

Model No. : TX-P46ST30E/J, PF46ST30 Parts List

Safety	Ref. No.	Part No.	Part Name & Description	Q'ty	Remarks
⚠	PCB	A-P46ST30E	CIRCUIT BOARD A	1	(RTL) PAVCCZ P46ST30E
⚠	PCB	A-P46ST30J	CIRCUIT BOARD A	1	(RTL) PAVCCZ P46ST30J
⚠	PCB	A-PF46ST30	CIRCUIT BOARD A	1	(RTL) PAVCCZ PF46ST30
⚠	PCB	TXNP21QMUE	CIRCUIT BOARD P2	1	(RTL) PAVCCZ
⚠	PCB	TXNP11QJUE	CIRCUIT BOARD P	1	(RTL)
⚠	PCB	TXN/K1RLUE	CIRCUIT BOARD K	1	(RTL) PAVCCZ
⚠	PCB	TXN/S1QNUE	CIRCUIT BOARD S	1	(RTL) PAVCCZ
⚠	PCB	TXN/V1QNUE	CIRCUIT BOARD V	1	(RTL) PAVCCZ
⚠	PCB	TNPA5316	CIRCUIT BOARD C1	1	(RTL)
⚠	PCB	TXNC211UGK	CIRCUIT BOARD C2	1	(RTL) PAVCCZ
⚠	PCB	TXNSC11UGKB	CIRCUIT BOARD SC	1	(RTL) PAVCCZ
⚠	PCB	TNPA5334	CIRCUIT BOARD SD	1	
⚠	PCB	TXNSS11UGK	CIRCUIT BOARD SS	1	(RTL) PAVCCZ
⚠	PCB	TXNSS211UGK	CIRCUIT BOARD SS2	1	(RTL) PAVCCZ
⚠	PCB	TXNSU11UGK	CIRCUIT BOARD SU	1	PAVCCZ
	A1	K1KY08AA0719	8P CONNECTOR	1	
	A6	K1KY15B00006	15P CONNECTOR	1	PAVCCZ
	A8	K1KY12AA0719	12P CONNECTOR	1	
	A11	K1KY04B00013	4P CONNECTOR	1	PAVCCZ
	A14	K1KY06AA0719	6P CONNECTOR	1	
	A20	K1MY35BA0345	35P CONNECTOR	1	
	A31	K1MY55BA0345	55P CONNECTOR	1	
	A32	K1MY55BA0345	55P CONNECTOR	1	
	A40	K1MY20BA0345	20P CONNECTOR	1	
⚠	C101	F0CAF334A105	C 0.33UF, 250V	1	PAVCCZ
⚠	C102	F1BAF221A088	C 220PF, 250V	1	PAVCCZ
⚠	C103	F1BAF221A088	C 220PF, 250V	1	PAVCCZ
⚠	C104	F0CAF334A105	C 0.33UF, 250V	1	PAVCCZ
	C106	F1H1H472A970	C 4700PF, , 50V	1	
	C111	F1H1H102A971	C 1000PF, 50V	1	
	C112	F1H1H103A970	C 0.01 uF 50 V	1	
⚠	C192	F1BAF471A088	C 470PF, 250V	1	PAVCCZ
⚠	C201	F0C2H1050001	C 1.5 UF 50 V	1	PAVCCZ
⚠	C202	F0C2H1050001	C 1.5 UF 50 V	1	PAVCCZ
	C205	F1H1C105A148	C 1UF, 16V	1	
	C206	F1H1H104A970	C 0.1UF, , 50V	1	
	C207	F1H1H681A971	C 680PF, 50V	1	
	C208	F1H1E1050008	C 1U 25V	1	PAVCCZ
	C209	F1H1H104A970	C 0.1UF, , 50V	1	
	C210	F1H1H102A971	C 1000PF, 50V	1	
	C211	F1H1E1050008	C 1U 25V	1	PAVCCZ
	C212	F1H1H102A971	C 1000PF, 50V	1	
	C213	F1H1H102A971	C 1000PF, 50V	1	
	C214	ECA1HHG010	E 1UF, 50V	1	
	C215	F1H1H104A970	C 0.1UF, , 50V	1	
	C220	F1A3A471A060	C 470PF 1KV	1	PAVCCZ
	C221	F1A3A471A060	C 470PF 1KV	1	PAVCCZ
	C222	F2A2W1010010	E 100UF 450V	1	PAVCCZ
	C223	F2A2W1010010	E 100UF 450V	1	PAVCCZ
	C224	F2A2W1010010	E 100UF 450V	1	PAVCCZ
	C225	F1A3A471A060	C 470PF 1KV	1	PAVCCZ
	C226	F1A3A471A060	C 470PF 1KV	1	PAVCCZ
	C301	F1H1E473A029	C 047PF 25V	1	PAVCCZ
	C302	ECA1HHG010	E 1UF, 50V	1	
	C303	F1H1H104A970	C 0.1UF, , 50V	1	
	C305	F2A1H2R2A122	E 2.2UF, 50V	1	
	C306	F1H1H332A970	C 3300PF, 50V	1	PAVCCZ
	C307	F1K1E225A085	C 2.2UF, 25V	1	
	C308	F1H1H681A971	C 680PF, 50V	1	
	C309	F1H1H101A971	C 100PF, 50V	1	

Model No. : TX-P46ST30E/J, PF46ST30 Parts List

Safety	Ref. No.	Part No.	Part Name & Description	Q'ty	Remarks
	C310	F1K2J681A017	C 680PF ,630V	1	PAVCCZ
	C311	F1K2J1500001	C 15PF, 630V	1	PAVCCZ
	C312	F1K2J1500001	C 15PF, 630V	1	PAVCCZ
	C313	F1H1H104A970	C 0.1UF, , 50V	1	
	C314	F1A3A471A060	C 470PF 1KV	1	PAVCCZ
	C315	F1H1C474A143	C 0.47UF, 16V	1	
	C316	ECWH8473HA	P 0.033UF 800V	1	
	C317	ECWH8473HA	P 0.033UF 800V	1	
	C321	F1K2J681A017	C 680PF ,630V	1	PAVCCZ
	C322	F1K2J1500001	C 15PF, 630V	1	PAVCCZ
	C323	F1K2J681A017	C 680PF ,630V	1	PAVCCZ
	C351	F2A2E2910001	E 290UF, 250V	1	PAVCCZ
	C352	F2A2E2910001	E 290UF, 250V	1	PAVCCZ
	C353	F2A2E2910001	E 290UF, 250V	1	PAVCCZ
	C354	F0C2E103A070	C 0.010UF, 250V	1	PAVCCZ
	C355	F1H1H104A970	C 0.1UF, , 50V	1	
	C358	F2A1H101A118	E 100UF, 50V	1	
	C359	F1H1H104A970	C 0.1UF, , 50V	1	
	C360	F1K1V1050001	C 1UF, 35V	1	PAVCCZ
	C361	F2A1H1000089	E 10UF, 50V	1	PAVCCZ
	C362	F2A1J1820001	C 1800UF ,63V	1	PAVCCZ
	C363	F1K1E225A085	C 2.2UF, 25V	1	
	C364	F1H1H104A970	C 0.1UF, , 50V	1	
	C365	F1H1H102A971	C 1000PF, 50V	1	
	C366	F2A1H4R7A794	E 4.7UF, 50V	1	PAVCCZ
	C367	F2A1J1820001	C 1800UF ,63V	1	PAVCCZ
	C368	F2A1J1820001	C 1800UF ,63V	1	PAVCCZ
	C370	F1K2A474A006	C 0.47UF, 100V	1	
	C372	F0C2E104A070	C 0.10UF, 250V	1	PAVCCZ
	C373	ECKD3A102KBP	C 1000PF, 1KV	1	
	C374	F1H1E1050008	C 1U 25V	1	PAVCCZ
	C376	F2A1J1820001	C 1800UF ,63V	1	PAVCCZ
	C378	ECKD3A102KBP	C 1000PF, 1KV	1	
	C379	ECKD3A102KBP	C 1000PF, 1KV	1	
	C401	F2A2W4700020	E 47UF 450V	1	PAVCCZ
	C403	F2A1H2200060	E 22UF, 50V	1	PAVCCZ
	C404	F1B3D331A011	C 330P 2000V	1	
	C405	F1H1H104A970	C 0.1UF, , 50V	1	
	C406	F1K1E225A085	C 2.2UF, 25V	1	
	C407	F1H1H222A970	C 2200PF, 50V	1	
	C408	F1H1H101A971	C 100PF, 50V	1	
	C410	F1B3A222A009	C 2200U 1000V	1	PAVCCZ
	C411	F1K1V1050001	C 1UF, 35V	1	PAVCCZ
	C452	F2A1E6810033	E 680UF 25V	1	PAVCCZ
	C453	F2A1E6810033	E 680UF 25V	1	PAVCCZ
	C454	F2A1E6810033	E 680UF 25V	1	PAVCCZ
	C455	F2A1E6810033	E 680UF 25V	1	PAVCCZ
	C456	F1H1H104A970	C 0.1UF, , 50V	1	
	C457	F1H1E473A029	C 047PF 25V	1	PAVCCZ
	C458	F1H1H104A970	C 0.1UF, , 50V	1	
	C459	F1H1C105A148	C 1UF, 16V	1	
	C460	F1H1C334A143	C 0.3UF. 16V	1	PAVCCZ
	C461	F1H1H104A970	C 0.1UF, , 50V	1	
	C462	F1H1C474A143	C 0.47UF, 16V	1	
	C463	F1H1H104A970	C 0.1UF, , 50V	1	
	C464	F1H1H102A971	C 1000PF, 50V	1	
	C465	F1H1H102A971	C 1000PF, 50V	1	
	C467	F1K1V1050001	C 1UF, 35V	1	PAVCCZ
	C468	F2A1V3310067	C 150UF 35V	1	PAVCCZ
	C469	F1H1C105A148	C 1UF, 16V	1	
	C470	F1H1H472A970	C 4700PF, , 50V	1	
	C471	F1H1H222A970	C 2200PF, 50V	1	

Model No. : TX-P46ST30E/J, PF46ST30 Parts List

Safety	Ref. No.	Part No.	Part Name & Description	Q'ty	Remarks
	C472	F1H1C105A148	C 1UF, 16V	1	
	C473	ECKD3A102KBP	C 1000PF, 1KV	1	
	C474	F2A1H101A118	E 100UF, 50V	1	
	C476	F1K1E684A130	C 0.68UF, 25V	1	PAVCCZ
	C478	F1H1H104A970	C 0.1UF, , 50V	1	
	C479	F1H1H104A970	C 0.1UF, , 50V	1	
	C480	F1K1V1050001	C 1UF, 35V	1	PAVCCZ
	C490	F1K2J102A014	C 1000PF, 630V	1	
	C501	F2A1H101A118	E 100UF, 50V	1	
	C502	F1H1H104A970	C 0.1UF, , 50V	1	
	C505	F2A1E1010130	E 100UF, 25V	1	PAVCCZ
	C551	F1K1E684A130	C 0.68UF, 25V	1	PAVCCZ
	C552	F1J1E224A227	C 0.22UF, 25V	1	
	C553	F1H1H102A971	C 1000PF, 50V	1	
	C554	F2A1H2200060	E 22UF, 50V	1	PAVCCZ
	C555	F1H1C105A148	C 1UF, 16V	1	
	C556	F1H1H104A970	C 0.1UF, , 50V	1	
	C557	F1H1C105A148	C 1UF, 16V	1	
	C558	F1H1C474A143	C 0.47UF, 16V	1	
	C601	F1H1H104A970	C 0.1UF, , 50V	1	
	C602	F1J1A4750009	C 4.7UF, 10V	1	PAVCCZ
	C651	F2A1H2200060	E 22UF, 50V	1	PAVCCZ
	C652	F1H1H104A970	C 0.1UF, , 50V	1	
	C654	F1K1E4750002	C 4.7UF, 25V	1	
	C655	F1H1H103A970	C 0.01 uF 50 V	1	
	C659	F1H1H102A971	C 1000PF, 50V	1	
	C701	F1H1H102A971	C 1000PF, 50V	1	
	C702	F1H1H102A971	C 1000PF, 50V	1	
	C0900	F1G1H101A565	C 100PF 50V	1	
	C0901	F1G1H101A565	C 100PF 50V	1	
	C2000	F1G1E1030005	C 0.01UF 25V	1	
	C2003	F1J1A106A087	C 10UF, 10V	1	
	C2004	F1J1E105A231	C 1 UF 25V	1	
	C2010	F1G1C104A077	C 0.1UF 16V	1	
	C2014	F1G1C104A077	C 0.1UF 16V	1	
	C2017	F1G1C104A077	C 0.1UF 16V	1	
	C2026	F1G1H1020008	C 1000PF 50V	1	
	C2752	F1G1E1030005	C 0.01UF 25V	1	
	C2810	ECJ1VB1H103K	C 0.01UF, 50V	1	
	C2811	F1J1A106A087	C 10UF, 10V	1	
	C2815	ECJ1VB1H103K	C 0.01UF, 50V	1	
	C2821	ECJ1XB1C104K	C 0.1UF, Z, 16V	1	
	C2850	F1G1A473A032	C0.047UF, 10V	1	
	C2851	F1G1A473A032	C0.047UF, 10V	1	
	C2852	F1G1A473A032	C0.047UF, 10V	1	
	C2853	F1G1A473A032	C0.047UF, 10V	1	
	C3001	F1G1A105A047	C 1UF 10V	1	
	C3002	F1G1A105A047	C 1UF 10V	1	
	C3003	F1G1C104A077	C 0.1UF 16V	1	
	C3004	F1G1C104A077	C 0.1UF 16V	1	
	C3005	F1G1A105A047	C 1UF 10V	1	
	C3006	F1G1A105A047	C 1UF 10V	1	
	C3011	F1J1A106A043	C 10UF, 10V	1	
	C3016	F1G1C104A077	C 0.1UF 16V	1	
	C3018	F1G1C104A077	C 0.1UF 16V	1	
	C3019	F1G1C104A077	C 0.1UF 16V	1	
	C3020	F1J1A106A043	C 10UF, 10V	1	
	C3084	F1J1A106A043	C 10UF, 10V	1	
	C3085	F1J1A106A043	C 10UF, 10V	1	
	C3086	F1J1A106A043	C 10UF, 10V	1	
	C3105	F1G1H5610004	C 560 pF 50 V	1	PAVCCZ
	C3106	F1G1H5610004	C 560 pF 50 V	1	PAVCCZ

Model No. : TX-P46ST30E/J, PF46ST30 Parts List

Safety	Ref. No.	Part No.	Part Name & Description	Q'ty	Remarks
	C3108	FIG1E333A091	C 0.033UF 25V	1	
	C3109	FIG1E333A091	C 0.033UF 25V	1	
	C3111	FIG1A105A047	C 1UF 10V	1	
	C3112	FIG1A105A047	C 1UF 10V	1	
	C3113	FIG1A106A043	C 10UF, 10V	1	
	C3120	F2H1A101A040	C 100UF, 10V	1	PAVCCZ
	C3121	F2H1A101A040	C 100UF, 10V	1	PAVCCZ
	C3124	FIG1A106A087	C 10UF, 10V	1	
	C3130	FIG1A106A087	C 10UF, 10V	1	
	C3131	FIG1A106A087	C 10UF, 10V	1	
	C3132	FIG1A106A087	C 10UF, 10V	1	
	C3135	FIG1H5610004	C 560 pF 50 V	1	PAVCCZ
	C3136	FIG1H5610004	C 560 pF 50 V	1	PAVCCZ
	C3139	FIG1H5610004	C 560 pF 50 V	1	PAVCCZ
	C3140	FIG1H5610004	C 560 pF 50 V	1	PAVCCZ
	C3145	FIG1A106A087	C 10UF, 10V	1	
	C3146	FIG1A106A087	C 10UF, 10V	1	
	C3147	FIG1A106A087	C 10UF, 10V	1	
	C3148	FIG1A106A087	C 10UF, 10V	1	
	C3151	FIG1A105A047	C 1UF 10V	1	
	C3152	FIG1A105A047	C 1UF 10V	1	
	C3153	FIG1H5610004	C 560 pF 50 V	1	PAVCCZ
	C3154	FIG1H5610004	C 560 pF 50 V	1	PAVCCZ
	C3155	FIG1H5610004	C 560 pF 50 V	1	PAVCCZ
	C3156	FIG1H5610004	C 560 pF 50 V	1	PAVCCZ
	C3157	FIG1A105A047	C 1UF 10V	1	
	C3158	FIG1A105A047	C 1UF 10V	1	
	C3159	FIG1A106A043	C 10UF, 10V	1	
	C3160	FIG1A106A043	C 10UF, 10V	1	
	C3161	FIG1A106A043	C 10UF, 10V	1	
	C3162	FIG1A106A043	C 10UF, 10V	1	
	C3163	FIG1A106A043	C 10UF, 10V	1	
	C3172	FIG1A105A047	C 1UF 10V	1	
	C3173	FIG1A105A047	C 1UF 10V	1	
	C3174	FIG1A105A047	C 1UF 10V	1	
	C3175	FIG1A105A047	C 1UF 10V	1	
	C3178	FIG1A106A043	C 10UF, 10V	1	
	C3179	FIG1A106A043	C 10UF, 10V	1	
	C4546	FIG1A105A047	C 1UF 10V	1	
	C4548	FIG1A105A047	C 1UF 10V	1	
	C4713	FIG1C104A077	C 0.1UF 16V	1	
	C4716	FIG1C104A077	C 0.1UF 16V	1	
	C4717	FIG1A106A087	C 10UF, 10V	1	
	C4718	FIG1A475A087	C 4.7UF, 10V	1	
	C4719	FIG1C104A077	C 0.1UF 16V	1	
	C4721	FIG1C104A077	C 0.1UF 16V	1	
	C4722	FIG1C104A077	C 0.1UF 16V	1	
	C4723	FIG1C104A077	C 0.1UF 16V	1	
	C4727	FIG1A106A087	C 10UF, 10V	1	
	C4800	FIG1A105A047	C 1UF 10V	1	
	C4801	FIG1A105A047	C 1UF 10V	1	
	C4802	FIG1H220A565	C 22PF, 50V	1	
	C4803	FIG1C104A077	C 0.1UF 16V	1	
	C4804	FIG1C104A077	C 0.1UF 16V	1	
	C4805	FIG1C104A077	C 0.1UF 16V	1	
	C4807	FIG1A106A043	C 10UF, 10V	1	
	C4808	FIG1C104A077	C 0.1UF 16V	1	
	C4811	FIG1A106A043	C 10UF, 10V	1	
	C4812	FIG1H1020008	C 1000PF 50V	1	
	C4816	FIG1H1020008	C 1000PF 50V	1	
	C4817	FIG1H330A565	C 33PF, 50V	1	
	C4818	FIG1H330A565	C 33PF, 50V	1	

Model No. : TX-P46ST30E/J, PF46ST30 Parts List

Safety	Ref. No.	Part No.	Part Name & Description	Q'ty	Remarks
	C4820	FIJ1E105A231	C 1 UF 25V	1	
	C4821	ECJ1VB1A105K	C 1UF, 10V	1	
	C4823	FIG1H1020008	C 1000PF 50V	1	
	C4825	FIG1H150A565	C 15PF, 50V	1	
	C4826	FIG1H150A565	C 15PF, 50V	1	
	C4830	FIG1H101A565	C 100PF 50V	1	
	C4831	FIG1H101A565	C 100PF 50V	1	
	C4899	FIJ1A106A043	C 10UF, 10V	1	
	C4908	FIG1H1020008	C 1000PF 50V	1	
	C4909	FIJ1E105A231	C 1 UF 25V	1	
	C4910	FIK1E106A136	C 10UF, 25V	1	
	C4911	FIH1H104A970	C 0.1UF, , 50V	1	
	C4912	FIJ1E105A231	C 1 UF 25V	1	
	C4913	FIH1H104A970	C 0.1UF, , 50V	1	
	C4914	FIJ1E105A231	C 1 UF 25V	1	
	C4915	FIH1H104A970	C 0.1UF, , 50V	1	
	C4916	FIK1E106A136	C 10UF, 25V	1	
	C4917	FIH1H104A970	C 0.1UF, , 50V	1	
	C4918	FIJ1E105A231	C 1 UF 25V	1	
	C4919	FIG1H1020008	C 1000PF 50V	1	
	C4921	FIJ1E4740001	C 0.47UF, 25V	1	PAVCCZ
	C4922	FIJ1E4740001	C 0.47UF, 25V	1	PAVCCZ
	C4924	FIJ1E4740001	C 0.47UF, 25V	1	PAVCCZ
	C4925	FIJ1E4740001	C 0.47UF, 25V	1	PAVCCZ
	C4934	FIG1H1020008	C 1000PF 50V	1	
	C4935	FIG1H1020008	C 1000PF 50V	1	
	C4936	FIG1H1020008	C 1000PF 50V	1	
	C4937	FIG1H1020008	C 1000PF 50V	1	
	C4938	FIK1E106A136	C 10UF, 25V	1	
	C4939	FIK1E106A136	C 10UF, 25V	1	
	C4970	FIJ1A106A087	C 10UF, 10V	1	
	C4971	FIJ1A106A087	C 10UF, 10V	1	
	C4972	F2H1A101A040	C 100UF, 10V	1	PAVCCZ
	C4973	F2H1A101A040	C 100UF, 10V	1	PAVCCZ
	C5000	FIG1E1030005	C 0.01UF 25V	1	
	C5002	FIJ1E105A231	C 1 UF 25V	1	
	C5003	FIH1C105A145	C 1 uF 16 V	1	
	C5012	EEEB1C101UF	C 100PF, J, 16V	1	
	C5013	ECJ1VB1A105K	C 1UF, 10V	1	
	C5014	ECJ1VB1A105K	C 1UF, 10V	1	
	C5015	ECJ1VB1A105K	C 1UF, 10V	1	
	C5016	ECJ1VB1A105K	C 1UF, 10V	1	
	C5017	ECJ1VB1A105K	C 1UF, 10V	1	
	C5018	FIG1C104A077	C 0.1UF 16V	1	
	C5020	FIG1E1030005	C 0.01UF 25V	1	
	C5023	FIK1E106A136	C 10UF, 25V	1	
	C5031	ECJ1VB1A105K	C 1UF, 10V	1	
	C5032	ECJ1VB1A105K	C 1UF, 10V	1	
	C5440	FIK1E106A136	C 10UF, 25V	1	
	C5442	FIG1C223A081	C 0.022UF, 16V	1	
	C5443	FIJ1A106A043	C 10UF, 10V	1	
	C5444	FIJ1A106A043	C 10UF, 10V	1	
	C5447	FIG1A333A032	C0.033UF, 10V	1	
	C5448	FIG1H5610004	C 560 pF 50 V	1	PAVCCZ
	C5668	FIG1C223A081	C 0.022UF, 16V	1	
	C5669	FIJ1A106A043	C 10UF, 10V	1	
	C5670	FIJ1A106A043	C 10UF, 10V	1	
	C5671	FIJ1A106A043	C 10UF, 10V	1	
	C5672	FIG1A333A032	C0.033UF, 10V	1	
	C5673	FIG1H5610004	C 560 pF 50 V	1	PAVCCZ
	C5676	FIK1E106A136	C 10UF, 25V	1	
	C5762	FIK1A106A021	C 0.010UF, K, 6.3V	1	

Model No. : TX-P46ST30E/J, PF46ST30 Parts List

Safety	Ref. No.	Part No.	Part Name & Description	Q'ty	Remarks
	C5900	FIJ1A106A043	C 10UF, 10V	1	
	C5901	FIJ1A106A043	C 10UF, 10V	1	
	C5902	FIJ1A106A043	C 10UF, 10V	1	
	C5905	FIG1C223A081	C 0.022UF, 16V	1	
	C5906	FIK1E106A136	C 10UF, 25V	1	
	C5908	FIG1A333A032	CO.033UF, 10V	1	
	C5909	FIG1H1020008	C 1000PF 50V	1	
	C5911	FIJ1A106A043	C 10UF, 10V	1	
	C5912	FIG1E472A086	C 4700pF 25V	1	
	C5913	FIG1A473A032	CO.047UF, 10V	1	
	C5915	FIG1A473A032	CO.047UF, 10V	1	
	C5917	FIG1A473A032	CO.047UF, 10V	1	
	C5919	FIG1A473A032	CO.047UF, 10V	1	
	C6750	FIJ1A475A087	C 4.7UF, 10V	1	
	C6751	FIJ1A106A087	C 10UF, 10V	1	
	C6787	FIJ1A106A087	C 10UF, 10V	1	
	C6788	FIJ1A106A087	C 10UF, 10V	1	
	C8001	FIG1C104A077	C 0.1UF 16V	1	
	C8002	FIJ1A106A087	C 10UF, 10V	1	
	C8003	FIG1C104A077	C 0.1UF 16V	1	
	C8004	FIG1C104A077	C 0.1UF 16V	1	
	C8005	FIG1C104A077	C 0.1UF 16V	1	
	C8006	FIG1C104A077	C 0.1UF 16V	1	
	C8007	FIG1C104A077	C 0.1UF 16V	1	
	C8008	FIG1C104A077	C 0.1UF 16V	1	
	C8009	FIJ1A106A087	C 10UF, 10V	1	
	C8011	FIG1C104A077	C 0.1UF 16V	1	
	C8013	FIG1C104A077	C 0.1UF 16V	1	
	C8014	FIG1C104A077	C 0.1UF 16V	1	
	C8015	FIG1C104A077	C 0.1UF 16V	1	
	C8016	FIG1C104A077	C 0.1UF 16V	1	
	C8017	FIJ1A106A087	C 10UF, 10V	1	
	C8018	FIG1C104A077	C 0.1UF 16V	1	
	C8019	FIG1C104A077	C 0.1UF 16V	1	
	C8020	FIG1C104A077	C 0.1UF 16V	1	
	C8021	FIG1C104A077	C 0.1UF 16V	1	
	C8022	FIJ1A106A087	C 10UF, 10V	1	
	C8023	FIJ1A106A087	C 10UF, 10V	1	
	C8024	FIJOG2260001	C 22 UF 4 V	1	
	C8026	FIG1C104A077	C 0.1UF 16V	1	
	C8027	FIG1C104A077	C 0.1UF 16V	1	
	C8028	FIG1C104A077	C 0.1UF 16V	1	
	C8030	FIG1C104A077	C 0.1UF 16V	1	
	C8032	FIG1C104A077	C 0.1UF 16V	1	
	C8036	FIG1C104A077	C 0.1UF 16V	1	
	C8039	FIG1C104A077	C 0.1UF 16V	1	
	C8041	FIG1H1020008	C 1000PF 50V	1	
	C8042	FIG1C104A077	C 0.1UF 16V	1	
	C8043	FIG1C104A077	C 0.1UF 16V	1	
	C8044	FIG1C104A077	C 0.1UF 16V	1	
	C8045	FIG1C104A077	C 0.1UF 16V	1	
	C8047	FIG1C104A077	C 0.1UF 16V	1	
	C8048	FIG1C104A077	C 0.1UF 16V	1	
	C8049	FIJ1A106A087	C 10UF, 10V	1	
	C8050	FIG1C104A077	C 0.1UF 16V	1	
	C8051	FIJ1A106A087	C 10UF, 10V	1	
	C8052	FIG1C104A077	C 0.1UF 16V	1	
	C8053	FIG1C104A077	C 0.1UF 16V	1	
	C8054	FIG1C104A077	C 0.1UF 16V	1	
	C8055	FIG1C104A077	C 0.1UF 16V	1	
	C8056	FIG1C104A077	C 0.1UF 16V	1	
	C8057	FIG1C104A077	C 0.1UF 16V	1	







Model No. : TX-P46ST30E/J, PF46ST30 Parts List

Safety	Ref. No.	Part No.	Part Name & Description	Q'ty	Remarks
	C8100	FIG1E682A123	C 6800 pF 25 V	1	
	C8102	FIJ1A475A087	C 4.7UF, 10V	1	
	C8104	FIH1C105A145	C 1 uF 16 V	1	
	C8106	FIG1C223A081	C 0.022UF, 16V	1	
	C8108	FIG1C104A077	C 0.1UF 16V	1	
	C8110	FIG1C104A077	C 0.1UF 16V	1	
	C8112	FIK1E106A136	C 10UF, 25V	1	
	C8114	FIK1E106A136	C 10UF, 25V	1	
	C8116	FIK1E106A136	C 10UF, 25V	1	
	C8118	FIK1E106A136	C 10UF, 25V	1	
	C8120	FIJ0G2260001	C 22 UF 4 V	1	
	C8122	FIJ0G2260001	C 22 UF 4 V	1	
	C8124	FIJ0G2260001	C 22 UF 4 V	1	
	C8126	FIJ0G2260001	C 22 UF 4 V	1	
	C8128	FIJ0G2260001	C 22 UF 4 V	1	
	C8200	FIG1C104A077	C 0.1UF 16V	1	
	C8201	FIG1C104A077	C 0.1UF 16V	1	
	C8202	FIG1C104A077	C 0.1UF 16V	1	
	C8203	FIG1C104A077	C 0.1UF 16V	1	
	C8204	FIG1C104A077	C 0.1UF 16V	1	
	C8205	FIJ1A106A087	C 10UF, 10V	1	
	C8206	FIG1C104A077	C 0.1UF 16V	1	
	C8208	FIG1C104A077	C 0.1UF 16V	1	
	C8210	FIG1C104A077	C 0.1UF 16V	1	
	C8213	FIG1C104A077	C 0.1UF 16V	1	
	C8214	FIJ1A106A087	C 10UF, 10V	1	
	C8216	FIG1C104A077	C 0.1UF 16V	1	
	C8218	FIG1C104A077	C 0.1UF 16V	1	
	C8219	FIG1C104A077	C 0.1UF 16V	1	
	C8222	FIG1C104A077	C 0.1UF 16V	1	
	C8223	FIG1C104A077	C 0.1UF 16V	1	
	C8224	FIG1C104A077	C 0.1UF 16V	1	
	C8225	FIG1C104A077	C 0.1UF 16V	1	
	C8226	FIG1C104A077	C 0.1UF 16V	1	
	C8227	FIG1C104A077	C 0.1UF 16V	1	
	C8300	FIG1H9R0A732	C 9 PF, 50V	1	
	C8301	FIG1H8R0A564	C 8 PF, 50V	1	
	C8302	FIG1C104A077	C 0.1UF 16V	1	
	C8303	FIG1C104A077	C 0.1UF 16V	1	
	C8304	FIG1C104A077	C 0.1UF 16V	1	
	C8305	FIG1A105A047	C 1UF 10V	1	
	C8306	FIG1A105A047	C 1UF 10V	1	
	C8307	FIG1A105A047	C 1UF 10V	1	
	C8308	FIG1A105A047	C 1UF 10V	1	
	C8309	FIG1A105A047	C 1UF 10V	1	
	C8310	FIG1A105A047	C 1UF 10V	1	
	C8311	FIG1A105A047	C 1UF 10V	1	
	C8401	FIG1C104A077	C 0.1UF 16V	1	
	C8402	FIK0J226A049	C 22UF, 6.3V	1	PAVCCZ
	C8403	FIK0J226A049	C 22UF, 6.3V	1	PAVCCZ
	C8406	FIG1C104A077	C 0.1UF 16V	1	
	C8407	FIG1C104A077	C 0.1UF 16V	1	
	C8411	FIG1C104A077	C 0.1UF 16V	1	
	C8603	FIJ1A106A087	C 10UF, 10V	1	
	C8604	FIG1C104A077	C 0.1UF 16V	1	
	C8605	FIG1C104A077	C 0.1UF 16V	1	
	C8607	FIG1H100A565	C 10PF 50V	1	
	C8608	FIG1H100A565	C 10PF 50V	1	
	C8609	FIG1C104A077	C 0.1UF 16V	1	
	C8611	FIG1C104A077	C 0.1UF 16V	1	
	C8615	FIJ1A106A087	C 10UF, 10V	1	
	C8616	FIJ1A106A087	C 10UF, 10V	1	





Model No. : TX-P46ST30E/J, PF46ST30 Parts List

Safety	Ref. No.	Part No.	Part Name & Description	Q'ty	Remarks
	C8617	FIG1C104A077	C 0.1UF 16V	1	
	C8619	FIG1C104A077	C 0.1UF 16V	1	
	C8620	FIG1C104A077	C 0.1UF 16V	1	
	C8627	FIG1C104A077	C 0.1UF 16V	1	
	C8628	FIJ0G2260001	C 22 UF 4 V	1	
	C8629	FIJ0G2260001	C 22 UF 4 V	1	
	C8630	F2H0J2210005	C 220UF, 6.3V	1	
	C8631	F2H0J2210005	C 220UF, 6.3V	1	
	C8632	FIJ1A106A087	C 10UF, 10V	1	
	C8633	FIG1C104A077	C 0.1UF 16V	1	
	C8636	FIJ1A106A043	C 10UF, 10V	1	
	C8637	FIJ1A106A087	C 10UF, 10V	1	
	C8638	FIG1C104A077	C 0.1UF 16V	1	
	C8639	FIJ1A106A087	C 10UF, 10V	1	
	C8640	FIG1C104A077	C 0.1UF 16V	1	
	C8641	FIJ1A106A043	C 10UF, 10V	1	
	C8642	FIJ1A106A087	C 10UF, 10V	1	
	C8643	FIG1C104A077	C 0.1UF 16V	1	
	C8644	FIG1C104A077	C 0.1UF 16V	1	
	C8660	FIG1H470A565	C 47PF, 50V	1	
	C8661	FIG1H470A565	C 47PF, 50V	1	
	C8738	FIJ1A475A087	C 4.7UF, 10V	1	
	C8739	FIH1C105A145	C 1 uF 16 V	1	
	C8740	FIG1E122A123	C 1200pF 25V	1	PAVCCZ
	C8742	FIG1C104A077	C 0.1UF 16V	1	
	C8744	FIK1E106A136	C 10UF, 25V	1	
	C8746	FIK1E106A136	C 10UF, 25V	1	
	C8748	FIJ0G2260001	C 22 UF 4 V	1	
	C8750	FIJ0G2260001	C 22 UF 4 V	1	
	C8753	FIJ0G2260001	C 22 UF 4 V	1	
	C8754	FIJ1A106A087	C 10UF, 10V	1	
	C8756	FIJ1A106A087	C 10UF, 10V	1	
	C8763	FIG1C104A077	C 0.1UF 16V	1	
	C8764	FIG1C223A081	C 0.022UF, 16V	1	
	C8765	FIJ1A106A043	C 10UF, 10V	1	
	C8766	FIJ1A106A043	C 10UF, 10V	1	
	C8768	FIG1A333A032	C0.033UF, 10V	1	
	C8769	FIG1H5610004	C 560 pF 50 V	1	PAVCCZ
	C8771	FIJ1A475A087	C 4.7UF, 10V	1	
	C8772	FIJ1A106A087	C 10UF, 10V	1	
	C8773	FIG1C104A077	C 0.1UF 16V	1	
	C8774	FIG1C104A077	C 0.1UF 16V	1	
	C8776	FIK1E106A136	C 10UF, 25V	1	
	C8777	FIG1C104A077	C 0.1UF 16V	1	
	C8780	ECJ1VB1A105K	C 1UF, 10V	1	
	C8781	ECJ1VB1A105K	C 1UF, 10V	1	
	C8786	FIG1C104A077	C 0.1UF 16V	1	
	C8787	FIG1C104A077	C 0.1UF 16V	1	
	C8789	FIK1E106A136	C 10UF, 25V	1	
	C8790	FIK1E106A136	C 10UF, 25V	1	
	C8791	FIG1C223A081	C 0.022UF, 16V	1	
	C8792	FIG1C1030008	C 0.01UF 16V	1	
	C8793	FIG1C1030008	C 0.01UF 16V	1	
	C8795	FIJ1A106A043	C 10UF, 10V	1	
	C8796	FIJ1A106A043	C 10UF, 10V	1	
	C8797	FIJ1A106A043	C 10UF, 10V	1	
	C8798	FIJ1A106A043	C 10UF, 10V	1	
	C8802	FIG1H1020008	C 1000PF 50V	1	
	C8803	FIG1E1030005	C 0.01UF 25V	1	
	C8810	FIJ1A106A043	C 10UF, 10V	1	
	C8813	FIJ1A106A043	C 10UF, 10V	1	
	C8900	FIG1C104A077	C 0.1UF 16V	1	





Model No. : TX-P46ST30E/J, PF46ST30 Parts List

Safety	Ref. No.	Part No.	Part Name & Description	Q'ty	Remarks
	C8901	FIG1C104A077	C 0.1UF 16V	1	
	C8902	FIG1C104A077	C 0.1UF 16V	1	
	C8903	FIG1C104A077	C 0.1UF 16V	1	
	C9099	FIG1C104A077	C 0.1UF 16V	1	
	C9100	FIJ1A106A087	C 10UF, 10V	1	
	C9101	FIG1E1030005	C 0.01UF 25V	1	
	C9102	FIK1E106A136	C 10UF, 25V	1	
	C9103	FIG1E1030005	C 0.01UF 25V	1	
	C9104	FIG1C104A077	C 0.1UF 16V	1	
	C9105	FIG1C104A077	C 0.1UF 16V	1	
	C9106	FIG1H5610004	C 560 pF 50 V	1	PAVCCZ
	C9108	FIG1C104A077	C 0.1UF 16V	1	
	C9300	FIG1C104A077	C 0.1UF 16V	1	
	C9301	FIG1H150A565	C 15PF, 50V	1	
	C9302	FIG1H180A565	C 18PF, 50V	1	
	C9308	FIG1C104A077	C 0.1UF 16V	1	
	C9311	FIG1C104A077	C 0.1UF 16V	1	
	C9312	FIJ1A106A087	C 10UF, 10V	1	
	C9313	FIG1C104A077	C 0.1UF 16V	1	
	C9328	FIG1C104A077	C 0.1UF 16V	1	
	C9330	FIG1A105A047	C 1UF 10V	1	
	C9331	FIG1A105A047	C 1UF 10V	1	
	C9332	FIG1A105A047	C 1UF 10V	1	
	C9337	FIJ1A106A087	C 10UF, 10V	1	
	C9362	FIG1C104A077	C 0.1UF 16V	1	
	C9366	FIG1A105A047	C 1UF 10V	1	
	C9371	FIJ1A106A087	C 10UF, 10V	1	
	C9375	FIG1C104A077	C 0.1UF 16V	1	
	C9380	FIG1C104A077	C 0.1UF 16V	1	
	C9389	FIG1A105A047	C 1UF 10V	1	
	C9392	FIJ1A106A087	C 10UF, 10V	1	
	C9400	FIG1C104A077	C 0.1UF 16V	1	
	C9401	FIG1C104A077	C 0.1UF 16V	1	
	C9402	FIG1C104A077	C 0.1UF 16V	1	
	C9404	FIG1C104A077	C 0.1UF 16V	1	
	C9407	FIG1C104A077	C 0.1UF 16V	1	
	C9409	FIJ1A106A087	C 10UF, 10V	1	
	C9411	FIJ1A106A087	C 10UF, 10V	1	
	C9413	FIJ1A106A087	C 10UF, 10V	1	
	C9415	FIJ1A106A087	C 10UF, 10V	1	
	C9589	FIJ1A106A087	C 10UF, 10V	1	
	C9590	FIG1E1030005	C 0.01UF 25V	1	
	CN0100	K1KA14A00248	14P CONNECTOR	1	
	CN8400	K1NA68B00059	68P CONNECTOR	1	PAVCCZ
	CN8600	K1NA09E00121	CONNECTOR	1	
	D101	B0FBCR000025	DIODE	1	PAVCCZ
	D102	B0EAKT000067	DIODE	1	PAVCCZ
	D103	B0EAKT000067	DIODE	1	PAVCCZ
	D104	B0AACK000004	DIODE	1	
	D105	B0AACK000004	DIODE	1	
	D106	B0FBCR000025	DIODE	1	PAVCCZ
	D107	B0ACJ000048	DIODE	1	
	D131	B0BA02800001	ZENER DIODE	1	
	D132	B0BA02800001	ZENER DIODE	1	
	D133	B0BA01400009	ZENER DIODE	1	
	D201	B0FABR000018	DIODE	1	PAVCCZ
	D201	D4EAC6210002	VARISTOR	1	
	D202	B0FABR000018	DIODE	1	PAVCCZ
	D202	D4EAC6210002	VARISTOR	1	
	D203	B0ECKM000053	DIODE	1	PAVCCZ

Model No. : TX-P46ST30E/J, PF46ST30 Parts List

Safety	Ref. No.	Part No.	Part Name & Description	Q'ty	Remarks
	D203	D4EAC6210002	VARISTOR	1	
	D204	B0ECKM000053	DIODE	1	PAVCCZ
	D204	D4EAC6210002	VARISTOR	1	
	D205	D4EAC6210002	VARISTOR	1	
	D206	B0ECKM000053	DIODE	1	PAVCCZ
	D207	B0ECKM000053	DIODE	1	PAVCCZ
	D209	TVSRM10B	DIODE	1	
	D210	B0ECKM000053	DIODE	1	PAVCCZ
	D211	B0ECKM000053	DIODE	1	PAVCCZ
	D301	B0HAGV000004	DIODE	1	
	D302	B0ECKM000053	DIODE	1	PAVCCZ
	D303	B0ECKM000053	DIODE	1	PAVCCZ
	D304	B0ECKM000053	DIODE	1	PAVCCZ
	D305	B0ECKM000053	DIODE	1	PAVCCZ
	D331	B0BC01400019	DIODE	1	PAVCCZ
	D332	B0BC01000014	ZENER DIODE	1	
	D333	B0BC01000014	ZENER DIODE	1	
	D351	B0AAQP000002	DIODE	1	PAVCCZ
	D352	B0AAQM000003	DIODE	1	PAVCCZ
	D353	B0ECKM000053	DIODE	1	PAVCCZ
	D354	B0JBSL000049	DIODE	1	PAVCCZ
	D382	B0BC5R600003	DIODE	1	
	D383	B0BB14500005	ZENER DIODE	1	PAVCCZ
	D384	B0BB14500005	ZENER DIODE	1	PAVCCZ
	D401	B0EAKT000048	DIODE	1	
	D402	TVSRM10B	DIODE	1	
	D403	TVSRM10B	DIODE	1	
	D404	B0ECKP000060	DIODE	1	PAVCCZ
	D405	B0BA3R100012	ZENER DIODE	1	PAVCCZ
	D406	B0HAGV000004	DIODE	1	
	D407	B0ECKP000060	DIODE	1	PAVCCZ
	D408	B0ECKM000053	DIODE	1	PAVCCZ
	D409	B0ECKM000053	DIODE	1	PAVCCZ
	D410	B0ECKM000053	DIODE	1	PAVCCZ
	D411	B0HAGV000004	DIODE	1	
	D412	DB2X41500L	DIODE	1	PAVCCZ
	D421	D4EAC6210002	VARISTOR	1	
	D422	D4EAC6210002	VARISTOR	1	
	D451	B0JBSL000049	DIODE	1	PAVCCZ
	D452	B0ACCCJ000048	DIODE	1	
	D453	B0ACCCJ000048	DIODE	1	
	D454	B0ACCCJ000048	DIODE	1	
	D455	B0ACCCJ000048	DIODE	1	
	D456	DB2X41500L	DIODE	1	PAVCCZ
	D458	B0ACCCJ000048	DIODE	1	
	D459	B0JBSL000049	DIODE	1	PAVCCZ
	D463	B0ACCCJ000048	DIODE	1	
	D464	B0ACCCJ000048	DIODE	1	
	D501	B0ECKP000060	DIODE	1	PAVCCZ
	D531	B0BA01400009	ZENER DIODE	1	
	D532	B0BC5R600003	DIODE	1	
	D553	B0ACCCJ000048	DIODE	1	
	D554	B0ACCCJ000048	DIODE	1	
	D555	B0ACCCJ000048	DIODE	1	
	D556	B0ACCCJ000048	DIODE	1	
	D581	B0BC5R600003	DIODE	1	
	D583	B0BA3R100012	ZENER DIODE	1	PAVCCZ
	D584	B0BA3R100012	ZENER DIODE	1	PAVCCZ
	D601	B0ACCCJ000048	DIODE	1	
	D603	B0ECKM000053	DIODE	1	PAVCCZ
	D631	B0BC6R700006	DIODE	1	PAVCCZ
	D655	B0ACCCJ000048	DIODE	1	

Model No. : TX-P46ST30E/J, PF46ST30 Parts List

Safety	Ref. No.	Part No.	Part Name & Description	Q'ty	Remarks
	D656	B0ACCJ000048	DIODE	1	
	D657	B0ACCJ000048	DIODE	1	
	D658	B0ACCJ000048	DIODE	1	
	D663	B0ACCJ000048	DIODE	1	
	D664	B0ACCJ000048	DIODE	1	
	D667	B0ACCJ000048	DIODE	1	
	D670	B0ACCJ000048	DIODE	1	
	D674	B0ACCJ000048	DIODE	1	
	D681	B0BC7R500001	DIODE	1	
	D682	B0BC6R100010	DIODE	1	PAVCCZ
	D683	B0BC01000014	ZENER DIODE	1	
	D2820	B3AGB0000065	LED	1	PAVCCZ
	D2850	B3EB00000056	LED	1	PAVCCZ
	D2851	B3EB00000056	LED	1	PAVCCZ
	D2852	B3EB00000056	LED	1	PAVCCZ
	D2853	B3EB00000056	LED	1	PAVCCZ
	D3015	K7AAAY000006	PHOTO LINK	1	
	D3130	B0ACCJ000048	DIODE	1	
	D4703	DZ2J056M0L	ZENER DIODE	1	
	D4704	B0JCCD000020	DIODE	1	PAVCCZ
	D4720	DZ2J056M0L	ZENER DIODE	1	
	D4721	B0JCCD000020	DIODE	1	PAVCCZ
	D4771	DZ2J056M0L	ZENER DIODE	1	
	D4772	B0JCCD000020	DIODE	1	PAVCCZ
	D4773	B0JCCE000008	DIODE	1	
	D4774	DZ2J056M0L	ZENER DIODE	1	
	D4775	B0JCCD000020	DIODE	1	PAVCCZ
	D4785	B0ECKM000048	DIODE	1	
	D5401	B0JCMD000066	ZENER DIODE	1	
	D5621	B0ACCJ000048	DIODE	1	
	D5622	B0ACCJ000048	DIODE	1	
	D5624	B0BC010A0007	ZENER DIODE	1	
	D5625	B0ACCJ000048	DIODE	1	
	D5626	DZ2J033M0L	ZENER DIODE	1	
	D5627	B0JCMD000066	ZENER DIODE	1	
	D5703	B0ACCJ000048	DIODE	1	
	D5704	B0ACCJ000048	DIODE	1	
	D5900	B0JCMD000066	ZENER DIODE	1	
	D8711	B0ADCJ000100	DIODE	1	
	D8712	DZ2J068M0L	ZENER DIODE	1	
	D8713	DZ2J068M0L	ZENER DIODE	1	
	D8717	B0ACCJ000048	DIODE	1	
	D8718	B0JCMD000066	ZENER DIODE	1	
	D8719	DZ2J068M0L	ZENER DIODE	1	
	D8720	B0ADCJ000100	DIODE	1	
	D8721	DZ2J068M0L	ZENER DIODE	1	
	D9806	B0ADCJ000100	DIODE	1	
	D9807	B0ADCJ000100	DIODE	1	
	F101	K5E103BZ0002	FUSE	1	
	F102	K5E103BZ0002	FUSE	1	
	F103	K5Y202Y00001	FUSE	1	PAVCCZ
	F301	K5Y502Y00001	FUSE	1	PAVCCZ
	IC201	C0DBEYY00025	IC	1	PAVCCZ
	IC301	C0DABYY00025	IC	1	PAVCCZ
	IC351	C0DBEYY00078	IC	1	
	IC352	C0DAAYY00063	IC	1	PAVCCZ
	IC401	C0DAAYY00065	IC	1	PAVCCZ
	IC451	C0DBEYY00078	IC	1	
	IC453	C0ABBA000059	IC	1	PAVCCZ
	IC455	C0DBAYY00922	IC	1	PAVCCZ





Model No. : TX-P46ST30E/J, PF46ST30 Parts List

Safety	Ref. No.	Part No.	Part Name & Description	Q'ty	Remarks
	IC601	C0DBEYY00078	IC	1	
	IC651	C0BBBA000024	IC	1	
	IC652	C0DBEYY00078	IC	1	
	IC2001	C1ZBZ0004368	IC	1	PAVCCZ
	IC3001	C1AB00003384	IC	1	PAVCCZ
	IC4700	C1AB00003469	IC	1	PAVCCZ
	IC4701	C0DBGYY00578	IC	1	
	IC4800	C0DBGYY02190	IC	1	PAVCCZ
	IC4900	C1AB00003457	IC	1	PAVCCZ
	IC5000	AN34044A-VF	IC	1	PAVCCZ
	IC5002	C0DBGHC00003	IC	1	
	IC5440	C0DBAYY00931	IC	1	PAVCCZ
	IC5607	C0DBAYY00931	IC	1	PAVCCZ
	IC5900	C0DBAYY00931	IC	1	PAVCCZ
	IC5901	C1ZBZ0004339	IC	1	PAVCCZ
	IC6750	C0CBCAG00031	IC	1	
	IC6776	C0DBAGF00030	IC	1	
	IC8000	MN2WS0200LE	IC	1	PAVCCZ
	IC8100	C0DBAYY00715	IC	1	
	IC8200	C3ABUY000009	IC	1	PAVCCZ
	IC8201	C3ABTY000025	IC	1	
	IC8403	C0JBAZ003032	IC	1	PAVCCZ
	IC8404	C0DBZYY00382	IC	1	PAVCCZ
	IC8601	C1CB00003491	IC	1	
	IC8602	C0DBZYY00368	IC	1	
	IC8603	C0DBZYY00450	IC	1	PAVCCZ
	IC8604	C0DBAGF00030	IC	1	
	IC8700	C0DBAYY00737	IC	1	
	IC8701	C0DBAYY00931	IC	1	PAVCCZ
	IC8702	C0DBAFG00029	IC	1	PAVCCZ
	IC8704	C0CBCAG00046	IC	1	
	IC8706	C0DBGYY00887	IC	1	
	IC8707	C0DBAYY00915	IC	1	PAVCCZ
	IC8714	C0DBGYY01682	IC	1	PAVCCZ
	IC8900	TVRS076AK	IC	1	PAVCCZ
	IC8901	TVR****	IC	1	PAVCCZ
	IC8902	TVR****	IC	1	PAVCCZ
	IC9300	C1AB00003461	IC	1	PAVCCZ
	IC9304	TVRS272AA	IC	1	PAVCCZ
	IC9400	C0JBAU000089	IC	1	PAVCCZ
	IC9401	C0JBAU000089	IC	1	PAVCCZ
	IC9402	C0JBAU000089	IC	1	PAVCCZ
	JA1	D0GFR00J0005	M 0 OHM, J, 1/3W	1	PAVCCZ
	JA2	D0GFR00J0005	M 0 OHM, J, 1/3W	1	PAVCCZ
	JA3	D0GFR00J0005	M 0 OHM, J, 1/3W	1	PAVCCZ
	JA4	D0GFR00J0005	M 0 OHM, J, 1/3W	1	PAVCCZ
	JA5	D0GFR00J0005	M 0 OHM, J, 1/3W	1	PAVCCZ
	JA6	D0GFR00J0005	M 0 OHM, J, 1/3W	1	PAVCCZ
	JA7	D0GFR00J0005	M 0 OHM, J, 1/3W	1	PAVCCZ
	JA8	D0GFR00J0005	M 0 OHM, J, 1/3W	1	PAVCCZ
	JA10	D0GFR00J0005	M 0 OHM, J, 1/3W	1	PAVCCZ
	JA11	D0GFR00J0005	M 0 OHM, J, 1/3W	1	PAVCCZ
	JA14	D0GFR00J0005	M 0 OHM, J, 1/3W	1	PAVCCZ
	JA15	D0GFR00J0005	M 0 OHM, J, 1/3W	1	PAVCCZ
	JA16	D0GFR00J0005	M 0 OHM, J, 1/3W	1	PAVCCZ
	JA18	D0GFR00J0005	M 0 OHM, J, 1/3W	1	PAVCCZ
	JA19	D0GFR00J0005	M 0 OHM, J, 1/3W	1	PAVCCZ
	JA22	D0GFR00J0005	M 0 OHM, J, 1/3W	1	PAVCCZ
	JA23	D0GFR00J0005	M 0 OHM, J, 1/3W	1	PAVCCZ
	JA24	D0GFR00J0005	M 0 OHM, J, 1/3W	1	PAVCCZ
	JA26	D0GFR00J0005	M 0 OHM, J, 1/3W	1	PAVCCZ







Model No. : TX-P46ST30E/J, PF46ST30 Parts List

Safety	Ref. No.	Part No.	Part Name & Description	Q'ty	Remarks
	JA27	D0GFR00J0005	M 0 OHM, J, 1/3W	1	PAVCCZ
	JA28	D0GFR00J0005	M 0 OHM, J, 1/3W	1	PAVCCZ
	JA29	D0GFR00J0005	M 0 OHM, J, 1/3W	1	PAVCCZ
	JA30	D0GFR00J0005	M 0 OHM, J, 1/3W	1	PAVCCZ
	JA32	D0GFR00J0005	M 0 OHM, J, 1/3W	1	PAVCCZ
	JA34	D0GFR00J0005	M 0 OHM, J, 1/3W	1	PAVCCZ
	JA36	D0GFR00J0005	M 0 OHM, J, 1/3W	1	PAVCCZ
	JA37	D0GFR00J0005	M 0 OHM, J, 1/3W	1	PAVCCZ
	JA38	D0GFR00J0005	M 0 OHM, J, 1/3W	1	PAVCCZ
	JA39	D0GFR00J0005	M 0 OHM, J, 1/3W	1	PAVCCZ
	JA40	D0GFR00J0005	M 0 OHM, J, 1/3W	1	PAVCCZ
	JA42	D0GFR00J0005	M 0 OHM, J, 1/3W	1	PAVCCZ
	JA43	D0GFR00J0005	M 0 OHM, J, 1/3W	1	PAVCCZ
	JA45	D0GFR00J0005	M 0 OHM, J, 1/3W	1	PAVCCZ
	JA46	D0GFR00J0005	M 0 OHM, J, 1/3W	1	PAVCCZ
	JA48	D0GFR00J0005	M 0 OHM, J, 1/3W	1	PAVCCZ
	JA49	D0GFR00J0005	M 0 OHM, J, 1/3W	1	PAVCCZ
	JK3002	K1FY121A0011	CONNECTOR	1	PAVCCZ
	JK3100	K1U710A00001	CONNECTOR	1	PAVCCZ
	JK3707	K1U411B00015	CONNECTOR UNIT	1	PAVCCZ
	JK4700	K1FY119D0015	CONNECTOR	1	PAVCCZ
	JK4701	K1FY119D0015	CONNECTOR	1	PAVCCZ
	JK4702	K1FY119D0015	CONNECTOR	1	PAVCCZ
	JK4703	K1FY119E0030	CONNECTOR	1	PAVCCZ
	JK8600	K2LC108A0012	JACK	1	PAVCCZ
	JK8601	K1FY104A0021	CONNECTOR	1	PAVCCZ
	JK8602	K1FY104B0065	CONNECTOR	1	PAVCCZ
	K1	K1KA08B00270	8P CONNECTOR	1	
	L192	EXCELSA35T	BEAD CHOKE	1	
	L202	EXCELD35V	BEAD CHOKE	1	
	L203	EXCELD35V	BEAD CHOKE	1	
	L354	G0C121Z00011	PEAKING COIL	1	PAVCCZ
	L401	G0A100ZA0023	CHOKE COIL	1	PAVCCZ
	L402	EXCELSA35T	BEAD CHOKE	1	
	L451	G0A100ZA0023	CHOKE COIL	1	PAVCCZ
	L2751	J0JHC0000045	CHIP INDUCTOR	1	
	L3100	J0JYC0000331	CHIP INDUCTOR	1	
	L3101	J0JYC0000331	CHIP INDUCTOR	1	
	L3104	J0JCC0000287	CHIP INDUCTOR	1	
	L3108	J0JCC0000287	CHIP INDUCTOR	1	
	L3111	J0JCC0000287	CHIP INDUCTOR	1	
	L3112	J0JCC0000287	CHIP INDUCTOR	1	
	L3113	J0JYC0000331	CHIP INDUCTOR	1	
	L3116	J0JYC0000331	CHIP INDUCTOR	1	
	L3117	J0JYC0000331	CHIP INDUCTOR	1	
	L3118	J0JYC0000331	CHIP INDUCTOR	1	
	L3119	J0JYC0000331	CHIP INDUCTOR	1	
	L3120	J0JYC0000331	CHIP INDUCTOR	1	
	L3300	J0ZZB0000150	FILTER	1	PAVCCZ
	L3301	J0ZZB0000150	FILTER	1	PAVCCZ
	L4702	J0JYC0000068	CHIP INDUCTOR	1	
	L4705	J0JYC0000068	CHIP INDUCTOR	1	
	L4708	J0JYC0000068	CHIP INDUCTOR	1	
	L4712	J0JHC0000045	CHIP INDUCTOR	1	
	L4717	J0JYC0000068	CHIP INDUCTOR	1	
	L4800	G1CR39J00009	INDUCTION COIL	1	
	L4801	G1CR39J00009	INDUCTION COIL	1	
	L4802	J0JGC0000020	CHIP INDUCTOR	1	
	L4803	J0JGC0000020	CHIP INDUCTOR	1	



Model No. : TX-P46ST30E/J, PF46ST30 Parts List

Safety	Ref. No.	Part No.	Part Name & Description	Q'ty	Remarks
	L4805	J0JGC0000020	CHIP INDUCTOR	1	
	L4807	J0JCC0000278	CHIP INDUCTOR	1	
	L4900	G1C150MA0426	INDUCTION COIL	1	PAVCCZ
	L4901	G1C150MA0426	INDUCTION COIL	1	PAVCCZ
	L4902	G1C150MA0426	INDUCTION COIL	1	PAVCCZ
	L4903	G1C150MA0426	INDUCTION COIL	1	PAVCCZ
	L5440	G1C6R8MA0445	INDUCTION COIL	1	PAVCCZ
	L5609	G1C6R8MA0445	INDUCTION COIL	1	PAVCCZ
	L5900	G1C6R8MA0445	INDUCTION COIL	1	PAVCCZ
	L8001	J0JCC0000287	CHIP INDUCTOR	1	
	L8002	J0JHC0000045	CHIP INDUCTOR	1	
	L8003	J0JHC0000045	CHIP INDUCTOR	1	
	L8005	J0JHC0000021	CHIP INDUCTOR	1	
	L8006	J0JCC0000287	CHIP INDUCTOR	1	
	L8007	J0JCC0000287	CHIP INDUCTOR	1	
	L8100	G1C4R7MA0416	INDUCTION COIL	1	
	L8102	G1C3R3MA0460	INDUCTION COIL	1	PAVCCZ
	L8600	J0JHC0000045	CHIP INDUCTOR	1	
	L8603	J0JHC0000045	CHIP INDUCTOR	1	
	L8604	J0JHC0000045	CHIP INDUCTOR	1	
	L8620	J0ZZB0000142	FILTER	1	
	L8621	J0ZZB0000142	FILTER	1	
	L8700	G1C2R2MA0449	INDUCTION COIL	1	PAVCCZ
	L8702	G1C6R8MA0445	INDUCTION COIL	1	PAVCCZ
	L8703	G1C6R8MA0445	INDUCTION COIL	1	PAVCCZ
	L8705	D0GBR00J0004	M 0 OHM J 1/10W	1	
	L8706	J0JGC0000020	CHIP INDUCTOR	1	
	L9303	J0JHC0000117	CHIP INDUCTOR	1	
	LF101	G0B382KA0010	CHOKE COIL	1	PAVCCZ
	LF102	G0B382KA0010	CHOKE COIL	1	PAVCCZ
	LF103	G0B382KA0010	CHOKE COIL	1	PAVCCZ
	LF104	G0B382KA0010	CHOKE COIL	1	PAVCCZ
	P2	K1KY02B00012	2P CONNECTOR	1	
	P6	K1KA15BA0311	15P CONNECTOR	1	PAVCCZ
	P9	K1KA02B00295	2P CONNECTOR	1	
	P11	K1KY03B00006	3P CONNECTOR	1	
	P25	K1KA10BA0237	10P CONNECTOR	1	PAVCCZ
	P34	K1KA03BA0237	3P CONNECTOR	1	
	P35	K1KA04BA0237	4P CONNECTOR	1	
	P51	K1KY02B00012	2P CONNECTOR	1	
	P52	K1KY02B00012	2P CONNECTOR	1	
	P55	K1KY03B00006	3P CONNECTOR	1	
	P56	K1KY03B00006	3P CONNECTOR	1	
	P57	K1KA05B00211	5P CONNECTOR	1	PAVCCZ
	P58	K1KA05B00211	5P CONNECTOR	1	PAVCCZ
	P1MM10	TMM27463	CLAMPER	1	PAVCCZ
	P1MM11	TMM27463	CLAMPER	1	PAVCCZ
	P1MM12	TMM27463	CLAMPER	1	PAVCCZ
	P1MM13	TMM27463	CLAMPER	1	PAVCCZ
	P1MM14	TMM27463	CLAMPER	1	PAVCCZ
	P1MM15	TMM27463	CLAMPER	1	PAVCCZ
	P1MM16	TMM27463	CLAMPER	1	PAVCCZ
	P1MM17	TMM27463	CLAMPER	1	PAVCCZ
	P1MM18	TMM27463	CLAMPER	1	PAVCCZ
	P2MM10	TMM27463	CLAMPER	1	PAVCCZ
	P2MM11	TMM27463	CLAMPER	1	PAVCCZ
	P2MM12	TMM27463	CLAMPER	1	PAVCCZ
	P2MM13	TMM27463	CLAMPER	1	PAVCCZ

Model No. : TX-P46ST30E/J, PF46ST30 Parts List

Safety	Ref. No.	Part No.	Part Name & Description	Q'ty	Remarks
	P2MM14	TMM27463	CLAMPER	1	PAVCCZ
	P2MM15	TMM27463	CLAMPER	1	PAVCCZ
	PA451	K5H502YA0063	FUSE	1	PAVCCZ
	PA501	K5H502YA0063	FUSE	1	PAVCCZ
	PA2005	K5H4022A0031	FUSE	1	
	PA5400	K5H5022A0031	FUSE	1	
	PA5900	K5H1022A0031	FUSE	1	
	PC101	B3PAA0000363	IC	1	
	PC302	B3PAA0000363	IC	1	
	PC402	B3PAA0000363	IC	1	
	PC501	B3PAA0000363	IC	1	
	PC602	B3PAA0000363	IC	1	
	PC603	B3PAA0000363	IC	1	
	Q101	B1CFNG000010	FET	1	
	Q102	DSA200100L	TRANSISTOR	1	
	Q201	B1CERR000060	FET	1	PAVCCZ
	Q202	B1CERR000060	FET	1	PAVCCZ
	Q203	B1ADMF000001	TRANSISTOR	1	PAVCCZ
	Q204	B1ADMF000001	TRANSISTOR	1	PAVCCZ
	Q301	B1CERR000056	FET	1	PAVCCZ
	Q302	B1CERR000056	FET	1	PAVCCZ
	Q354	DSC200100L	TRANSISTOR	1	
	Q374	B1DHBC000008	FET	1	
	Q375	B1CERM000033	FET	1	PAVCCZ
	Q376	B1ADMF000001	TRANSISTOR	1	PAVCCZ
	Q377	B1ABMD000022	TRANSISTOR	1	PAVCCZ
	Q451	B1CHRD000046	FET	1	PAVCCZ
	Q452	B1CBGD000001	FET	1	
	Q453	B1CBGD000001	FET	1	
	Q454	B1CHRD000046	FET	1	PAVCCZ
	Q455	B1CBGD000001	FET	1	
	Q456	B1CBGD000001	FET	1	
	Q457	B1DHBC000008	FET	1	
	Q458	B1CBGD000001	FET	1	
	Q459	B1CBGD000001	FET	1	
	Q460	B1CBGD000001	FET	1	
	Q462	B1CBGD000001	FET	1	
	Q463	B1CBGD000001	FET	1	
	Q501	B1AAPG000009	TRANSISTOR	1	PAVCCZ
	Q502	DSC200100L	TRANSISTOR	1	
	Q503	B1DHBC000008	FET	1	
	Q551	B1CBGD000001	FET	1	
	Q552	DSC200100L	TRANSISTOR	1	
	Q553	DSC200100L	TRANSISTOR	1	
	Q554	DSC200100L	TRANSISTOR	1	
	Q555	DSC200100L	TRANSISTOR	1	
	Q556	B1CBGD000001	FET	1	
	Q557	B1DHBC000008	FET	1	
	Q558	DSC200100L	TRANSISTOR	1	
	Q559	DSA200100L	TRANSISTOR	1	
	Q560	B1DHBC000008	FET	1	
	Q561	DSC200100L	TRANSISTOR	1	
	Q562	DSC200100L	TRANSISTOR	1	
	Q563	DSC200100L	TRANSISTOR	1	
	Q564	B1DHBC000008	FET	1	
	Q565	B1DHBC000008	FET	1	
	Q601	DSA200100L	TRANSISTOR	1	
	Q651	B1DHBC000008	FET	1	
	Q652	B1CBGD000001	FET	1	

Model No. : TX-P46ST30E/J, PF46ST30 Parts List

Safety	Ref. No.	Part No.	Part Name & Description	Q'ty	Remarks
	Q653	B1DHBC000008	FET	1	
	Q656	B1DHBC000008	FET	1	
	Q658	B1DHBC000008	FET	1	
	Q701	DSC200100L	TRANSISTOR	1	
	Q702	DSC200100L	TRANSISTOR	1	
	Q0900	B1ADCF000194	TRANSISTOR	1	PAVCCZ
	Q2810	B1ABCE000015	TRANSISTOR	1	
	Q2811	B1ABCE000015	TRANSISTOR	1	
	Q2812	B1ABCE000015	TRANSISTOR	1	
	Q3008	DSA2001S0L	TRANSISTOR	1	
	Q3102	B1AAF000004	TRANSISTOR	1	PAVCCZ
	Q3103	B1AAF000004	TRANSISTOR	1	PAVCCZ
	Q3104	B1AAF000004	TRANSISTOR	1	PAVCCZ
	Q3105	B1AAF000004	TRANSISTOR	1	PAVCCZ
	Q4513	DSA2001S0L	TRANSISTOR	1	
	Q4514	BIHFCEA00001	TRANSISTOR	1	PAVCCZ
	Q4700	B1ABCF000231	TRANSISTOR	1	
	Q4702	B1ABCF000231	TRANSISTOR	1	
	Q4709	B1ABCF000231	TRANSISTOR	1	
	Q4710	B1ABCF000231	TRANSISTOR	1	
	Q4970	B1ADCF000194	TRANSISTOR	1	PAVCCZ
	Q4971	B1AAF000002	TRANSISTOR	1	
	Q4972	B1AAF000002	TRANSISTOR	1	
	Q4974	DSC2001S0L	TRANSISTOR	1	
	Q8100	B1CFRD000077	FET	1	PAVCCZ
	Q8101	B1CFRD000077	FET	1	PAVCCZ
	Q8102	B1MBEDA00027	FET	1	
	Q8701	B1MBEDA00027	FET	1	
	Q8709	B1ADCF000194	TRANSISTOR	1	PAVCCZ
	Q8710	B1ADCF000194	TRANSISTOR	1	PAVCCZ
	Q8711	DSC2001S0L	TRANSISTOR	1	
	R003	D0GBR00J0004	M 0 OHM J 1/10W	1	
	R101	D0B1185JA033	M 1.8 MOHM J 1 W	1	PAVCCZ
	R102	D0B1825JA033	M 8.2 MOHM J 1 W	1	
	R103	D1F5150Y0001	F 150 OHM, 5W	1	PAVCCZ
	R104	D0D54R7J0002	M 4.7 OHM, J, 2W	1	PAVCCZ
	R105	D1BD2003A066	M 200KOHM.F.1/8W	1	PAVCCZ
	R106	D1BD2003A066	M 200KOHM.F.1/8W	1	PAVCCZ
	R107	D1BD2003A066	M 200KOHM.F.1/8W	1	PAVCCZ
	R108	D1BD2003A066	M 200KOHM.F.1/8W	1	PAVCCZ
	R109	D1BD2003A066	M 200KOHM.F.1/8W	1	PAVCCZ
	R110	D1BD1003A066	M 100KOHM, J.1/8 W	1	PAVCCZ
	R111	D1BD2003A066	M 200KOHM.F.1/8W	1	PAVCCZ
	R113	D0D5180J0002	M 18 OHM, J, 2W	1	PAVCCZ
	R114	D1BD1003A066	M 100KOHM, J.1/8 W	1	PAVCCZ
	R115	D1BD1003A066	M 100KOHM, J.1/8 W	1	PAVCCZ
	R116	D1BB2202A073	M 22KOHM, J.1/10W	1	PAVCCZ
	R117	D1BB2202A073	M 22KOHM, J.1/10W	1	PAVCCZ
	R118	D1BB2203A073	M 220KOHM, J.1/10W	1	PAVCCZ
	R121	D0GBR00J0004	M 0 OHM J 1/10W	1	
	R201	D1BD3303A066	M330KOHM.F.1/8W	1	PAVCCZ
	R202	D1BD3303A066	M330KOHM.F.1/8W	1	PAVCCZ
	R203	D1BD3303A066	M330KOHM.F.1/8W	1	PAVCCZ
	R204	D1BD3303A066	M330KOHM.F.1/8W	1	PAVCCZ
	R205	D1BD3303A066	M330KOHM.F.1/8W	1	PAVCCZ
	R206	D1BD3003A066	M 300KOHM.F.1/8W	1	PAVCCZ
	R207	D1BB2002A073	M 20KOHM, J.1/10W	1	PAVCCZ
	R209	D1BD7503A066	M 750KOHM, F.1/8W	1	PAVCCZ
	R210	D1BB1002A073	M 10KOHM, J.1/10W	1	PAVCCZ
	R211	D1BD2202A066	M 22KOHM, F.1/8W	1	PAVCCZ
	R212	D1BB1802A073	M 18KOHM, J.1/10W	1	PAVCCZ

Model No. : TX-P46ST30E/J, PF46ST30 Parts List

Safety	Ref. No.	Part No.	Part Name & Description	Q'ty	Remarks
	R213	D1BB1502A073	M 15KOHM, J.1/10W	1	PAVCCZ
	R214	D1BB1802A073	M 18KOHM, J.1/10W	1	PAVCCZ
	R215	D1BB1502A073	M 15KOHM, J.1/10W	1	PAVCCZ
	R217	D1BD51R0A066	M0.51KOHM,F.1/8W	1	PAVCCZ
	R219	DOGDR00J0004	M 0 OHM, 1/8W	1	
	R220	D1DE100JA019	M 100 OHM, 1/4W	1	PAVCCZ
	R221	D1BB2202A073	M 22KOHM, J.1/10W	1	PAVCCZ
	R224	DOXGR10J0007	M 0.10OHM, J, 5W	1	
	R225	DOXGR10J0007	M 0.10OHM, J, 5W	1	
	R227	D1BD51R0A066	M0.51KOHM,F.1/8W	1	PAVCCZ
	R229	DOGDR00J0004	M 0 OHM, 1/8W	1	
	R230	D1DE100JA019	M 100 OHM, 1/4W	1	PAVCCZ
	R231	D1BB2202A073	M 22KOHM, J.1/10W	1	PAVCCZ
	R234	DOXGR10J0007	M 0.10OHM, J, 5W	1	
	R235	DOXGR10J0007	M 0.10OHM, J, 5W	1	
	R236	D1BB2200A073	M 220 OHM, J.1/10W	1	PAVCCZ
	R237	D1BB2200A073	M 220 OHM, J.1/10W	1	PAVCCZ
	R238	D1BB5103A073	M510KOHM, J.1/10W	1	PAVCCZ
	R239	D1BB5103A073	M510KOHM, J.1/10W	1	PAVCCZ
	R247	DOGDR00J0004	M 0 OHM, 1/8W	1	
	R250	D1BB1800A073	M 180 OHM, J.1/10W	1	PAVCCZ
	R251	D1BB1200A073	M 120 OHM, J.1/10W	1	PAVCCZ
	R252	D1BB1800A073	M 180 OHM, J.1/10W	1	PAVCCZ
	R253	D1BB1200A073	M 120 OHM, J.1/10W	1	PAVCCZ
	R258	D1BD51R0A066	M0.51KOHM,F.1/8W	1	PAVCCZ
	R259	D1BD51R0A066	M0.51KOHM,F.1/8W	1	PAVCCZ
	R260	D1BD3303A066	M330KOHM.F.1/8W	1	PAVCCZ
	R261	D1BD3303A066	M330KOHM.F.1/8W	1	PAVCCZ
	R262	D1BD3303A066	M330KOHM.F.1/8W	1	PAVCCZ
	R263	D1BD1603A066	M 160KOHM.F.1/8W	1	PAVCCZ
	R301	D1BD3303A066	M330KOHM.F.1/8W	1	PAVCCZ
	R302	D1BD3303A066	M330KOHM.F.1/8W	1	PAVCCZ
	R303	D1BD3303A066	M330KOHM.F.1/8W	1	PAVCCZ
	R304	D1BD3303A066	M330KOHM.F.1/8W	1	PAVCCZ
	R305	D1BD3303A066	M330KOHM.F.1/8W	1	PAVCCZ
	R306	D1BD1002A066	M 10KOHM, J.1/8W	1	PAVCCZ
	R307	D1BD3301A066	M 3.3KOHM, F.1/8W	1	PAVCCZ
	R308	D1BD4702A066	M 47KOHM, F.1/8W	1	PAVCCZ
	R309	D1BD5600A066	M 560 OHM, F.1/8W	1	PAVCCZ
	R310	D1BD4700A066	M 470 OHM, F.1/8W	1	PAVCCZ
	R311	D1BD1200A066	M 120 OHM, J.1/8W	1	PAVCCZ
	R312	D1BD33R0A066	M 33 OHM, F.1/8W	1	PAVCCZ
	R313	D1BD10R0A066	M 10 OHM, F. 1/8W	1	PAVCCZ
	R314	D1DE2R2JA019	M 2.2 OHM, 1/4W	1	PAVCCZ
	R315	D1BB2202A073	M 22KOHM, J.1/10W	1	PAVCCZ
	R316	D1BD10R0A066	M 10 OHM, F. 1/8W	1	PAVCCZ
	R317	D1DE2R2JA019	M 2.2 OHM, 1/4W	1	PAVCCZ
	R318	D1BB2202A073	M 22KOHM, J.1/10W	1	PAVCCZ
	R319	D1BD10R0A066	M 10 OHM, F. 1/8W	1	PAVCCZ
	R320	D1BD3303A066	M330KOHM.F.1/8W	1	PAVCCZ
	R321	D1BD3303A066	M330KOHM.F.1/8W	1	PAVCCZ
	R322	D1BD3303A066	M330KOHM.F.1/8W	1	PAVCCZ
	R323	D1BD1603A066	M 160KOHM.F.1/8W	1	PAVCCZ
	R351	D1BB6202A073	M 62KOHM, J.1/10W	1	PAVCCZ
	R352	D1BB6202A073	M 62KOHM, J.1/10W	1	PAVCCZ
	R353	D1BB6202A073	M 62KOHM, J.1/10W	1	PAVCCZ
	R354	D1BB7502A073	M 75KOHM, J.1/10W	1	PAVCCZ
	R355	D1BB7502A073	M 75KOHM, J.1/10W	1	PAVCCZ
	R356	D1BB7502A073	M 75KOHM, J.1/10W	1	PAVCCZ
	R357	D1BB5101A073	M 5.1KOHM, J.1/10W	1	PAVCCZ
	R358	D1BB4702A073	M 47KOHM, J.1/10W	1	PAVCCZ
	R359	DOGBR00J0004	M 0 OHM J 1/10W	1	

Model No. : TX-P46ST30E/J, PF46ST30 Parts List

Safety	Ref. No.	Part No.	Part Name & Description	Q'ty	Remarks
	R360	D1BB2201A073	M 2.2KOHM, J.1/10W	1	PAVCCZ
	R361	D1BD1001A066	M 1KOHM, J.1/8W	1	PAVCCZ
	R369	D1BD4701A066	M 4.7KOHM, F.1/8W	1	PAVCCZ
	R370	D1BD4701A066	M 4.7KOHM, F.1/8W	1	PAVCCZ
	R371	D1BD4701A066	M 4.7KOHM, F.1/8W	1	PAVCCZ
	R372	D1BD4701A066	M 4.7KOHM, F.1/8W	1	PAVCCZ
	R373	D1BD1002A066	M 10KOHM, J.1/8W	1	PAVCCZ
	R374	D1BB1002A073	M 10KOHM, J.1/10W	1	PAVCCZ
	R375	D1BB4701A073	M 4.7KOHM, J.1/10W	1	PAVCCZ
	R376	D1BB4701A073	M 4.7KOHM, J.1/10W	1	PAVCCZ
	R377	D1BB2003A073	M 200KOHM, J.1/10W	1	PAVCCZ
	R378	D1DE330J0001	M 330 OHM, 1/4W	1	PAVCCZ
	R379	D1BB2702A073	M 27KOHM, J.1/10W	1	PAVCCZ
	R380	D1BB3303A073	M 330KOHM, J.1/10W	1	PAVCCZ
	R381	D1BB1803A073	M 18KOHM, J.1/10W	1	PAVCCZ
	R382	D1BB1003A073	M 100KOHM, J.1/10W	1	PAVCCZ
	R383	D1BD8202A066	M 750KOHM, F.1/8W	1	PAVCCZ
	R384	D1BD1003A066	M 100KOHM, J.1/8 W	1	PAVCCZ
	R385	D1BD1202A066	M 12KOHM, F.1/8W	1	PAVCCZ
	R386	D1BD6200A066	M 620 OHM, F.1/8W	1	PAVCCZ
	R387	D1BD1601A066	M 1.6KOHM, F.1/8W	1	PAVCCZ
	R388	ERG1SJ473P	M 47KOHM, J, 1W	1	
	R389	ERG2SJ104P	M 100KOHM, J, 2W	1	
	R390	D1BD1003A066	M 100KOHM, J.1/8 W	1	PAVCCZ
	R391	D1BD1001A066	M 1KOHM, J.1/8W	1	PAVCCZ
	R393	D1BD2001A066	M 2.0KOHM, F.1/8W	1	PAVCCZ
	R394	DOGDR00J0004	M 0 OHM, 1/8W	1	
	R399	DOGBR00J0004	M 0 OHM J 1/10W	1	
	R401	D1DE470JA022	M 470 OHM, 1/4W	1	PAVCCZ
	R403	DOXGR22J0005	M 0.220OHM, J, 5W	1	PAVCCZ
	R405	D1BD1003A066	M 100KOHM, J.1/8 W	1	PAVCCZ
	R406	D1BD2202A066	M 22KOHM, F.1/8W	1	PAVCCZ
	R407	D1BB2201A073	M 2.2KOHM, J.1/10W	1	PAVCCZ
	R408	ERG2DG224	M 220KOHM.G.2W	1	PAVCCZ
	R409	ERG2DG224	M 220KOHM.G.2W	1	PAVCCZ
	R410	ERG2DG224	M 220KOHM.G.2W	1	PAVCCZ
	R411	D1BD1004A066	M1000KOHM, F.1/8W	1	PAVCCZ
	R412	D1BD1002A066	M 10KOHM, J.1/8W	1	PAVCCZ
	R413	ERG2DG224	M 220KOHM.G.2W	1	PAVCCZ
	R441	D1BB6803A073	M680KOHM, J.1/10W	1	PAVCCZ
	R442	D1BB1003A073	M 100KOHM, J.1/10W	1	PAVCCZ
	R445	DOGBR00J0004	M 0 OHM J 1/10W	1	
	R447	D1BB2200A073	M 220 OHM, J.1/10W	1	PAVCCZ
	R448	D1BD3003A066	M 300KOHM.F.1/8W	1	PAVCCZ
	R449	D1BD2003A066	M 200KOHM.F.1/8W	1	PAVCCZ
	R451	D1BD3901A066	M 3.9KOHM, F.1/8W	1	PAVCCZ
	R452	D1BB2702A073	M 27KOHM, J.1/10W	1	PAVCCZ
	R453	D1BB2702A073	M 27KOHM, J.1/10W	1	PAVCCZ
	R454	D1BD6201A066	M 6.2KOHM, F.1/8W	1	PAVCCZ
	R455	D1BD3901A066	M 3.9KOHM, F.1/8W	1	PAVCCZ
	R456	D1BB1202A073	M 120 OHM, J.1/10W	1	PAVCCZ
	R457	D1BB3301A073	M 3.3KOHM, J.1/10W	1	PAVCCZ
	R458	D1BB1203A073	M 120KOHM, J.1/10W	1	PAVCCZ
	R459	D1BB2003A073	M 200KOHM, J.1/10W	1	PAVCCZ
	R460	D1BB2201A073	M 2.2KOHM, J.1/10W	1	PAVCCZ
	R461	D1BD2003A066	M 200KOHM.F.1/8W	1	PAVCCZ
	R462	D1BB1001A073	M 100 OHM, J.1/10W	1	PAVCCZ
	R463	D1BB1203A073	M 120KOHM, J.1/10W	1	PAVCCZ
	R464	D1BB2203A073	M 220KOHM, J.1/10W	1	PAVCCZ
	R465	D1BB1202A073	M 120 OHM, J.1/10W	1	PAVCCZ
	R466	D1BB1003A073	M 100KOHM, J.1/10W	1	PAVCCZ
	R467	D1BB1001A073	M 100 OHM, J.1/10W	1	PAVCCZ

Model No. : TX-P46ST30E/J, PF46ST30 Parts List

Safety	Ref. No.	Part No.	Part Name & Description	Q'ty	Remarks
	R468	D0XGR10J0007	M 0.100HM, J, 5W	1	
	R469	D0GBR00J0004	M 0 OHM J 1/10W	1	
	R471	D0GBR00J0004	M 0 OHM J 1/10W	1	
	R473	D1BB1002A073	M 10KOHM, J.1/10W	1	PAVCCZ
	R474	D1BB1002A073	M 10KOHM, J.1/10W	1	PAVCCZ
	R476	D1BB1003A073	M 100KOHM, J.1/10W	1	PAVCCZ
	R477	D1BB1003A073	M 100KOHM, J.1/10W	1	PAVCCZ
	R478	D1BB6802A073	M 68KOHM, J.1/10W	1	PAVCCZ
	R483	D1BB8202A073	M 82KOHM, J.1/10W	1	PAVCCZ
	R484	D0GBR00J0004	M 0 OHM J 1/10W	1	
	R485	D1BB2702A073	M 27KOHM, J.1/10W	1	PAVCCZ
	R486	ERX1SJ3R9	M 3.9 OHM, J, 1W	1	PAVCCZ
	R487	D1BB4702A073	M 47KOHM, J.1/10W	1	PAVCCZ
	R488	D1BD1003A066	M 100KOHM, J.1/8 W	1	PAVCCZ
	R489	D1BD1303A066	M 130KOHM.F.1/8W	1	PAVCCZ
	R490	D1BD2003A066	M 200KOHM.F.1/8W	1	PAVCCZ
	R491	D1BB1000A073	M 100 OHM, J.1/10W	1	PAVCCZ
	R492	D1BB1503A073	M 150KOHM, J.1/10W	1	PAVCCZ
	R493	D1BD3003A066	M 300KOHM.F.1/8W	1	PAVCCZ
	R496	D0GBR00J0004	M 0 OHM J 1/10W	1	
	R497	D1BB1002A073	M 10KOHM, J.1/10W	1	PAVCCZ
	R498	D1BB1002A073	M 10KOHM, J.1/10W	1	PAVCCZ
	R502	D1BD3900A066	M 390 OHM, F.1/8W	1	PAVCCZ
	R503	D1BD1004A066	M1000KOHM, F.1/8W	1	PAVCCZ
	R505	D1BB4701A073	M 4.7KOHM, J.1/10W	1	PAVCCZ
	R506	D1BB1002A073	M 10KOHM, J.1/10W	1	PAVCCZ
	R507	D1BB4701A073	M 4.7KOHM, J.1/10W	1	PAVCCZ
	R508	D1BB4701A073	M 4.7KOHM, J.1/10W	1	PAVCCZ
	R512	ERG2SJ222H	M 2.2KOHM, J, 2W	1	
	R513	D1BB1001A073	M 100 OHM, J.1/10W	1	PAVCCZ
	R514	D1BD1004A066	M1000KOHM, F.1/8W	1	PAVCCZ
	R515	D1BB1002A073	M 10KOHM, J.1/10W	1	PAVCCZ
	R516	D1BB1002A073	M 10KOHM, J.1/10W	1	PAVCCZ
	R517	D1BB1001A073	M 100 OHM, J.1/10W	1	PAVCCZ
	R518	D1BD3900A066	M 390 OHM, F.1/8W	1	PAVCCZ
	R519	D1BD3900A066	M 390 OHM, F.1/8W	1	PAVCCZ
	R550	D1DE2R2JA019	M 2.2 OHM, 1/4W	1	PAVCCZ
	R551	D1BB4703A073	M470KOHM, J.1/10W	1	PAVCCZ
	R552	D1BB4703A073	M470KOHM, J.1/10W	1	PAVCCZ
	R553	D1BB6801A073	M 6.8KOHM, J.1/10W	1	PAVCCZ
	R554	D1BB6803A073	M680KOHM, J.1/10W	1	PAVCCZ
	R555	D1BB1003A073	M 100KOHM, J.1/10W	1	PAVCCZ
	R556	D1BB1503A073	M 150KOHM, J.1/10W	1	PAVCCZ
	R557	D1BB3001A073	M 3.0KOHM, J.1/10W	1	PAVCCZ
	R558	D1BB4702A073	M 47KOHM, J.1/10W	1	PAVCCZ
	R559	D1BB1002A073	M 10KOHM, J.1/10W	1	PAVCCZ
	R560	D1BB1002A073	M 10KOHM, J.1/10W	1	PAVCCZ
	R561	D1BB4701A073	M 4.7KOHM, J.1/10W	1	PAVCCZ
	R562	D1BB1002A073	M 10KOHM, J.1/10W	1	PAVCCZ
	R563	D1BB1003A073	M 100KOHM, J.1/10W	1	PAVCCZ
	R564	D1BB3301A073	M 3.3KOHM, J.1/10W	1	PAVCCZ
	R565	D1BB3302A073	M 33KOHM, J.1/10W	1	PAVCCZ
	R566	D1BB1002A073	M 10KOHM, J.1/10W	1	PAVCCZ
	R567	D1BB3302A073	M 33KOHM, J.1/10W	1	PAVCCZ
	R568	D1BB2202A073	M 22KOHM, J.1/10W	1	PAVCCZ
	R569	D1BB1002A073	M 10KOHM, J.1/10W	1	PAVCCZ
	R570	D1BB1002A073	M 10KOHM, J.1/10W	1	PAVCCZ
	R571	D1BB4701A073	M 4.7KOHM, J.1/10W	1	PAVCCZ
	R572	D1BB4701A073	M 4.7KOHM, J.1/10W	1	PAVCCZ
	R573	D1BB1002A073	M 10KOHM, J.1/10W	1	PAVCCZ
	R574	D1BB1002A073	M 10KOHM, J.1/10W	1	PAVCCZ
	R576	D1BB1001A073	M 100 OHM, J.1/10W	1	PAVCCZ

Model No. : TX-P46ST30E/J, PF46ST30 Parts List

Safety	Ref. No.	Part No.	Part Name & Description	Q'ty	Remarks
	R577	D1BB1001A073	M 100 OHM, J.1/10W	1	PAVCCZ
	R578	D1BB5600A073	M 560 OHMJ.1/10W	1	PAVCCZ
	R579	D1BB1001A073	M 100 OHM, J.1/10W	1	PAVCCZ
	R580	D1BB1001A073	M 100 OHM, J.1/10W	1	PAVCCZ
	R581	DOGDR00J0004	M 0 OHM, 1/8W	1	
	R582	DOGDR00J0004	M 0 OHM, 1/8W	1	
	R583	D1BB6802A073	M 68KOHM, J.1/10W	1	PAVCCZ
	R584	D1BB6802A073	M 68KOHM, J.1/10W	1	PAVCCZ
	R585	D1BB4703A073	M470KOHM, J.1/10W	1	PAVCCZ
	R586	D1BB4703A073	M470KOHM, J.1/10W	1	PAVCCZ
	R587	D1BB1503A073	M 150KOHM, J.1/10W	1	PAVCCZ
	R588	D1BB1002A073	M 10KOHM, J.1/10W	1	PAVCCZ
	R589	D1BB4702A073	M 47KOHM, J.1/10W	1	PAVCCZ
	R590	D1BB4703A073	M470KOHM, J.1/10W	1	PAVCCZ
	R591	D1BB1002A073	M 10KOHM, J.1/10W	1	PAVCCZ
	R592	D1BB1002A073	M 10KOHM, J.1/10W	1	PAVCCZ
	R593	D1BB4701A073	M 4.7KOHM, J.1/10W	1	PAVCCZ
	R594	D1BB4701A073	M 4.7KOHM, J.1/10W	1	PAVCCZ
	R595	D1BB3001A073	M 3.0KOHM, J.1/10W	1	PAVCCZ
	R596	D1BB4701A073	M 4.7KOHM, J.1/10W	1	PAVCCZ
	R597	D1BB1002A073	M 10KOHM, J.1/10W	1	PAVCCZ
	R598	D1BB4701A073	M 4.7KOHM, J.1/10W	1	PAVCCZ
	R601	D1BD3903A066	M 390KOHM, F. 1/8W	1	PAVCCZ
	R602	D1BD3903A066	M 390KOHM, F. 1/8W	1	PAVCCZ
	R603	D1BD3903A066	M 390KOHM, F. 1/8W	1	PAVCCZ
	R604	D1BD3903A066	M 390KOHM, F. 1/8W	1	PAVCCZ
	R605	D1BD3903A066	M 390KOHM, F. 1/8W	1	PAVCCZ
	R606	D1BD3903A066	M 390KOHM, F. 1/8W	1	PAVCCZ
	R607	D1BD3903A066	M 390KOHM, F. 1/8W	1	PAVCCZ
	R608	D1BB2002A073	M 20KOHM, J.1/10W	1	PAVCCZ
	R609	D1BB1003A073	M 100KOHM, J.1/10W	1	PAVCCZ
	R610	D1BB5600A073	M 560 OHMJ.1/10W	1	PAVCCZ
	R611	D1BB1001A073	M 100 OHM, J.1/10W	1	PAVCCZ
	R612	D1BB5600A073	M 560 OHMJ.1/10W	1	PAVCCZ
	R613	D1BD5600A066	M 560 OHM, F.1/8W	1	PAVCCZ
	R614	D1BB1002A073	M 10KOHM, J.1/10W	1	PAVCCZ
	R615	D1BB1002A073	M 10KOHM, J.1/10W	1	PAVCCZ
	R616	D1BD3903A066	M 390KOHM, F. 1/8W	1	PAVCCZ
	R617	D1BD3303A066	M330KOHM, F.1/8W	1	PAVCCZ
	R618	D1BD1002A066	M 10KOHM, J.1/8W	1	PAVCCZ
	R619	DOGDR00J0004	M 0 OHM J 1/10W	1	
	R620	DOGDR00J0004	M 0 OHM J 1/10W	1	
	R621	D1BB1003A073	M 100KOHM, J.1/10W	1	PAVCCZ
	R635	D1BB4701A073	M 4.7KOHM, J.1/10W	1	PAVCCZ
	R636	D1BB4701A073	M 4.7KOHM, J.1/10W	1	PAVCCZ
	R637	D1BD22R0A066	M 0.22 OHM, F.1/8W	1	PAVCCZ
	R648	D1BB3303A073	M 330KOHM, J.1/10W	1	PAVCCZ
	R650	D1BB9102A073	M 91KOHM, J.1/10W	1	PAVCCZ
	R651	D1BB9102A073	M 91KOHM, J.1/10W	1	PAVCCZ
	R653	D1BB9102A073	M 91KOHM, J.1/10W	1	PAVCCZ
	R654	D1BB8202A073	M 82KOHM, J.1/10W	1	PAVCCZ
	R655	D1BB8202A073	M 82KOHM, J.1/10W	1	PAVCCZ
	R656	D1BB8202A073	M 82KOHM, J.1/10W	1	PAVCCZ
	R657	D1BB1502A073	M 15KOHM, J.1/10W	1	PAVCCZ
	R658	D1BB3902A073	M 39KOHM, J.1/10W	1	PAVCCZ
	R659	D1BB1002A073	M 10KOHM, J.1/10W	1	PAVCCZ
	R660	D1BB1002A073	M 10KOHM, J.1/10W	1	PAVCCZ
	R661	D1BB1002A073	M 10KOHM, J.1/10W	1	PAVCCZ
	R662	D1BB1502A073	M 15KOHM, J.1/10W	1	PAVCCZ
	R663	D1BB3001A073	M 3.0KOHM, J.1/10W	1	PAVCCZ
	R666	D1BB4701A073	M 4.7KOHM, J.1/10W	1	PAVCCZ
	R667	D1BB3601A073	M 3.6KOHM, J.1/10W	1	PAVCCZ

Model No. : TX-P46ST30E/J, PF46ST30 Parts List

Safety	Ref. No.	Part No.	Part Name & Description	Q'ty	Remarks
	R668	D1BB2201A073	M 2.2KOHM, J.1/10W	1	PAVCCZ
	R669	D1BB4701A073	M 4.7KOHM, J.1/10W	1	PAVCCZ
	R670	D1BB3601A073	M 3.6KOHM, J.1/10W	1	PAVCCZ
	R671	D1BB2201A073	M 2.2KOHM, J.1/10W	1	PAVCCZ
	R672	D1BB1003A073	M 100KOHM, J.1/10W	1	PAVCCZ
	R673	D1BB6801A073	M 6.8KOHM, J.1/10W	1	PAVCCZ
	R674	D1BB1202A073	M 120 OHM, J.1/10W	1	PAVCCZ
	R675	D1BB1802A073	M 18KOHM, J.1/10W	1	PAVCCZ
	R678	D1BB1003A073	M 100KOHM, J.1/10W	1	PAVCCZ
	R679	D1BB4701A073	M 4.7KOHM, J.1/10W	1	PAVCCZ
	R680	D1BB4701A073	M 4.7KOHM, J.1/10W	1	PAVCCZ
	R681	D1BB1003A073	M 100KOHM, J.1/10W	1	PAVCCZ
	R682	D1BB2203A073	M 220KOHM, J.1/10W	1	PAVCCZ
	R684	D1BB1001A073	M 100 OHM, J.1/10W	1	PAVCCZ
	R685	D1BB2203A073	M 220KOHM, J.1/10W	1	PAVCCZ
	R686	D1BB4701A073	M 4.7KOHM, J.1/10W	1	PAVCCZ
	R688	D1BB4701A073	M 4.7KOHM, J.1/10W	1	PAVCCZ
	R693	D1BD1000A066	M 100 OHM, J.1/8W	1	PAVCCZ
	R694	D1BB1001A073	M 100 OHM, J.1/10W	1	PAVCCZ
	R696	D1BB4701A073	M 4.7KOHM, J.1/10W	1	PAVCCZ
	R697	D1BB4701A073	M 4.7KOHM, J.1/10W	1	PAVCCZ
	R701	D0GBR00J0004	M 0 OHM J 1/10W	1	
	R703	D1BB1603A073	M 160KOHM, J.1/10W	1	PAVCCZ
	R704	D1BB4702A073	M 47KOHM, J.1/10W	1	PAVCCZ
	R705	D1BB1002A073	M 10KOHM, J.1/10W	1	PAVCCZ
	R706	D1BB1002A073	M 10KOHM, J.1/10W	1	PAVCCZ
	R707	D1BB1203A073	M 120KOHM, J.1/10W	1	PAVCCZ
	R708	D1BB1202A073	M 120 OHM, J.1/10W	1	PAVCCZ
	R709	D1BB1002A073	M 10KOHM, J.1/10W	1	PAVCCZ
	R710	D1BB1002A073	M 10KOHM, J.1/10W	1	PAVCCZ
	R0902	D0GA473JA015	M 47KOHM, J,1/16W	1	
	R0903	D0GA272JA023	M 2.7KOHM, J.1/16W	1	
	R0904	D0GA272JA023	M 2.7KOHM, J.1/16W	1	
	R0905	D0GA272JA023	M 2.7KOHM, J.1/16W	1	
	R0906	D0GA272JA023	M 2.7KOHM, J.1/16W	1	
	R0907	D0GA222JA023	M 2.2KOHM, J,1/16W	1	
	R0908	D0GA222JA023	M 2.2KOHM, J,1/16W	1	
	R0909	D0GA272JA023	M 2.7KOHM, J.1/16W	1	
	R0910	D0GA272JA023	M 2.7KOHM, J.1/16W	1	
	R0911	EXB28V332J	M 3.3 KOHM 1/32 W	1	
	R0912	D0GA101JA015	M 100 OHM, J,1/16W	1	
	R0913	D0GA101JA015	M 100 OHM, J,1/16W	1	
	R0951	D0GA473JA015	M 47KOHM, J,1/16W	1	
	R0952	D0GA102JA023	M1KOHM, J.1/16 W	1	
	R1201	D0GA103JA015	M 10KOHM, J,1/16W	1	
	R1202	D0GA103JA015	M 10KOHM, J,1/16W	1	
	R1305	D0GA103JA015	M 10KOHM, J,1/16W	1	
	R1350	D0GA103JA015	M 10KOHM, J,1/16W	1	
	R2012	D0GA103JA015	M 10KOHM, J,1/16W	1	
	R2705	D0GA101JA015	M 100 OHM, J,1/16W	1	
	R2752	D0GA184JA023	M 180KOHM J.1/16W	1	
	R2810	D0GB470JA065	M 47 OHM, J,1/10W	1	
	R2811	D0GB104JA065	M 100KOHM J 1/10W	1	
	R2812	D0GB224JA065	M 220KOHM, J,1/10W	1	PAVCCZ
	R2813	D0GB223JA065	M 22KOHM, J,1/10W	1	PAVCCZ
	R2814	D0GB103JA065	M 10K OHM J 1/10W	1	
	R2815	D0GB473JA065	M 47KOHM J. 1/10W	1	PAVCCZ
	R2816	D1BB1621A055	M1.62KOHM, J.1/10W	1	
	R2817	D0GB223JA065	M 22KOHM, J,1/10W	1	PAVCCZ
	R2818	D0GB473JA065	M 47KOHM J. 1/10W	1	PAVCCZ
	R2819	D1BB4301A055	M4.30KOHM, J.1/10W	1	
	R3001	D0GA102JA023	M1KOHM, J.1/16 W	1	

Model No. : TX-P46ST30E/J, PF46ST30 Parts List

Safety	Ref. No.	Part No.	Part Name & Description	Q'ty	Remarks
	R3002	D0GA122JA023	M 1.2KOHM, J,1/16W	1	
	R3003	D0GA103JA015	M 10KOHM, J,1/16W	1	
	R3004	D0GA103JA015	M 10KOHM, J,1/16W	1	
	R3030	D0GA101JA015	M 100 OHM, J,1/16W	1	
	R3104	D0GBR00J0004	M 0 OHM J 1/10W	1	
	R3106	D0GA333JA023	M 33KOHM, J,1/16W	1	
	R3107	D0GA333JA023	M 33KOHM, J,1/16W	1	
	R3109	D1BF75R0A011	M 75.0 OHM, 1/4W	1	PAVCCZ
	R3117	D0GA221JA023	M220 OHM, J.1/16 W	1	
	R3121	EXB28V221J	M220 OHM 1/32 W	1	
	R3129	D0GA104JA023	M100KOHM, J.1/16 W	1	
	R3137	D0GD750JA052	M 75 OHM, J,1/8W	1	PAVCCZ
	R3141	D1BF75R0A011	M 75.0 OHM, 1/4W	1	PAVCCZ
	R3142	D1BF75R0A011	M 75.0 OHM, 1/4W	1	PAVCCZ
	R3143	D1BF75R0A011	M 75.0 OHM, 1/4W	1	PAVCCZ
	R3147	D1BF75R0A011	M 75.0 OHM, 1/4W	1	PAVCCZ
	R3153	D0GA221JA023	M220 OHM, J.1/16 W	1	
	R3157	EXB28V221J	M220 OHM 1/32 W	1	
	R3163	D0GA104JA023	M100KOHM, J.1/16 W	1	
	R3164	D0GA104JA023	M100KOHM, J.1/16 W	1	
	R3167	D0GA333JA023	M 33KOHM, J,1/16W	1	
	R3168	D0GA333JA023	M 33KOHM, J,1/16W	1	
	R3171	D0GA222JA023	M 2.2KOHM, J,1/16W	1	
	R3172	D0GA222JA023	M 2.2KOHM, J,1/16W	1	
	R3173	EXB28V221J	M220 OHM 1/32 W	1	
	R3174	D0GA221JA023	M220 OHM, J.1/16 W	1	
	R3175	D0GA221JA023	M220 OHM, J.1/16 W	1	
	R3179	D0GA331JA023	M 330 OHM, J,1/16W	1	
	R3180	D0GA331JA023	M 330 OHM, J,1/16W	1	
	R3181	D1BD75R0A066	M 75.0 OHM, J.1/8 W	1	
	R3182	D1BD75R0A066	M 75.0 OHM, J.1/8 W	1	
	R3183	D1BD75R0A066	M 75.0 OHM, J.1/8 W	1	
	R3184	D0GA104JA023	M100KOHM, J.1/16 W	1	
	R3185	D0GA104JA023	M100KOHM, J.1/16 W	1	
	R3186	D0GA333JA023	M 33KOHM, J,1/16W	1	
	R3187	D0GA333JA023	M 33KOHM, J,1/16W	1	
	R3190	D0GA222JA023	M 2.2KOHM, J,1/16W	1	
	R3191	D0GA222JA023	M 2.2KOHM, J,1/16W	1	
	R3192	EXB28V820JX	M 82 OHM 1/32 W	1	
	R3194	D0GA331JA023	M 330 OHM, J,1/16W	1	
	R3195	D0GA331JA023	M 330 OHM, J,1/16W	1	
	R3198	D0GA680JA023	M 68 OHM, J,1/16W	1	
	R3202	D1BF75R0A011	M 75.0 OHM, 1/4W	1	PAVCCZ
	R3204	D1BA2152A014	M21.5KOHM, J.1/16 W	1	PAVCCZ
	R3206	D1BA1302A014	M 13KOHM, J.1/16 W	1	
	R3208	D0GA273JA023	M 27K OHM J, 1/16W	1	
	R3212	D0GA680JA023	M 68 OHM, J,1/16W	1	
	R3213	D0GA473JA015	M 47KOHM, J,1/16W	1	
	R3290	D0GA473JA015	M 47KOHM, J,1/16W	1	
	R3291	D0GA473JA015	M 47KOHM, J,1/16W	1	
	R4548	D0GA220JA023	M22 OHM, J.1/16 W	1	
	R4549	D0GA151JA023	M 150 OHM, J,1/16W	1	
	R4550	D0GA151JA023	M 150 OHM, J,1/16W	1	
	R4551	D0GA151JA023	M 150 OHM, J,1/16W	1	
	R4552	D0GA560JA023	M 56 OHM, J,1/16W	1	
	R4553	D0GA103JA015	M 10KOHM, J,1/16W	1	
	R4554	D0GA102JA023	M1KOHM, J.1/16 W	1	
	R4563	D0GA103JA015	M 10KOHM, J,1/16W	1	
	R4599	D0GA473JA015	M 47KOHM, J,1/16W	1	
	R4702	D0GA103JA015	M 10KOHM, J,1/16W	1	
	R4708	D0GA103JA015	M 10KOHM, J,1/16W	1	
	R4709	D0GA103JA015	M 10KOHM, J,1/16W	1	

Model No. : TX-P46ST30E/J, PF46ST30 Parts List

Safety	Ref. No.	Part No.	Part Name & Description	Q'ty	Remarks
	R4710	EXB28V473JX	M 47KOHM 1/32 W	1	
	R4711	DOGA102JA023	M1KOHM, J.1/16 W	1	
	R4715	DOGA103JA015	M 10KOHM, J,1/16W	1	
	R4721	DOGA103JA015	M 10KOHM, J,1/16W	1	
	R4722	DOGA103JA015	M 10KOHM, J,1/16W	1	
	R4723	EXB28V473JX	M 47KOHM 1/32 W	1	
	R4724	DOGA102JA023	M1KOHM, J.1/16 W	1	
	R4748	DOGA680JA023	M 68 OHM, J,1/16W	1	
	R4749	DOGA680JA023	M 68 OHM, J,1/16W	1	
	R4750	DOGA680JA023	M 68 OHM, J,1/16W	1	
	R4751	DOGA680JA023	M 68 OHM, J,1/16W	1	
	R4763	DOGA104JA023	M100KOHM, J.1/16 W	1	
	R4767	DOGA392JA023	M 3.9KOHM, J,1/16W	1	
	R4770	DOGA473JA015	M 47KOHM, J,1/16W	1	
	R4771	DOGA152JA023	M 1.5KOHM, J,0.063W	1	
	R4772	DOGA152JA023	M 1.5KOHM, J,0.063W	1	
	R4774	DOGA473JA015	M 47KOHM, J,1/16W	1	
	R4775	DOGA473JA015	M 47KOHM, J,1/16W	1	
	R4780	DOGA121JA023	M 120 OHM, J,1/16W	1	
	R4781	DOGA680JA023	M 68 OHM, J,1/16W	1	
	R4783	DOGA103JA015	M 10KOHM, J,1/16W	1	
	R4784	DOGA103JA015	M 10KOHM, J,1/16W	1	
	R4785	DOGA680JA023	M 68 OHM, J,1/16W	1	
	R4786	DOGA680JA023	M 68 OHM, J,1/16W	1	
	R4787	DOGA680JA023	M 68 OHM, J,1/16W	1	
	R4788	DOGA103JA015	M 10KOHM, J,1/16W	1	
	R4789	DOGA103JA015	M 10KOHM, J,1/16W	1	
	R4790	DOGA680JA023	M 68 OHM, J,1/16W	1	
	R4791	DOGA680JA023	M 68 OHM, J,1/16W	1	
	R4792	EXB28V473JX	M 47KOHM 1/32 W	1	
	R4793	DOGA102JA023	M1KOHM, J.1/16 W	1	
	R4794	DOGA103JA015	M 10KOHM, J,1/16W	1	
	R4795	DOGA103JA015	M 10KOHM, J,1/16W	1	
	R4796	EXB28V473JX	M 47KOHM 1/32 W	1	
	R4797	DOGA102JA023	M1KOHM, J.1/16 W	1	
	R4798	DOGA273JA023	M 27K OHM J ,1/16W	1	
	R4800	DOGA103JA015	M 10KOHM, J,1/16W	1	
	R4802	DOGAR00J0005	M 0 OHM, 1/16W	1	
	R4814	DOGA103JA015	M 10KOHM, J,1/16W	1	
	R4910	DOGA472JA023	M 4.7KOHM, J,1/16W	1	
	R4911	DOGA102JA023	M1KOHM, J.1/16 W	1	
	R4913	DOGA103JA015	M 10KOHM, J,1/16W	1	
	R4914	EXB28V220J	M 22 OHM 1/32 W	1	
	R4921	DOGA103JA015	M 10KOHM, J,1/16W	1	
	R4970	D1BB1403A055	M 140KOHM, J.1/10W	1	
	R4971	D1BB1403A055	M 140KOHM, J.1/10W	1	
	R4972	DOGA103JA015	M 10KOHM, J,1/16W	1	
	R4973	DOGA103JA015	M 10KOHM, J,1/16W	1	
	R4974	DOGA101JA015	M 100 OHM, J,1/16W	1	
	R4975	DOGA473JA015	M 47KOHM, J,1/16W	1	
	R4976	DOGA103JA015	M 10KOHM, J,1/16W	1	
	R4978	DOGA101JA015	M 100 OHM, J,1/16W	1	
	R4979	DOGA101JA015	M 100 OHM, J,1/16W	1	
	R4984	DOGA473JA015	M 47KOHM, J,1/16W	1	
	R4985	DOGA103JA015	M 10KOHM, J,1/16W	1	
	R4987	DOGA102JA023	M1KOHM, J.1/16 W	1	
	R5000	DOGA102JA023	M1KOHM, J.1/16 W	1	
	R5001	DOGA473JA015	M 47KOHM, J,1/16W	1	
	R5009	DOGA103JA015	M 10KOHM, J,1/16W	1	
	R5010	DOGA222JA023	M 2.2KOHM, J,1/16W	1	
	R5011	DOGA104JA023	M100KOHM, J.1/16 W	1	
	R5012	DOGA223JA023	M 22K OHM J 1/16W	1	

Model No. : TX-P46ST30E/J, PF46ST30 Parts List

Safety	Ref. No.	Part No.	Part Name & Description	Q'ty	Remarks
	R5013	D0GA103JA015	M 10KOHM, J, 1/16W	1	
	R5440	D0GA390JA023	M 39 OHM, J, 1/16W	1	
	R5441	D1BB1002A055	M 10KOHM, J, 1/10W	1	
	R5442	D1BB1002A055	M 10KOHM, J, 1/10W	1	
	R5443	D1BB5362A055	M53.6KOHM, J, 1/10W	1	PAVCCZ
	R5652	D1BB2101A087	M 2.1KOHM, J, 1/10W	1	
	R5653	D1BB2402A055	M 24KOHM, J, 1/10W	1	
	R5655	D1BA1001A014	M 1KOHM, J, 1/16 W	1	
	R5658	D0GAR00J0005	M 0 OHM, 1/16W	1	
	R5660	D0GA472JA023	M 4.7KOHM, J, 1/16W	1	
	R5661	D0GA472JA023	M 4.7KOHM, J, 1/16W	1	
	R5664	D0GA472JA023	M 4.7KOHM, J, 1/16W	1	
	R5665	D0GA471JA023	M 470OHM, J, 1/16W	1	
	R5686	D0GA390JA023	M 39 OHM, J, 1/16W	1	
	R5687	D1BB1002A055	M 10KOHM, J, 1/10W	1	
	R5705	D0GA472JA023	M 4.7KOHM, J, 1/16W	1	
	R5706	D0GA472JA023	M 4.7KOHM, J, 1/16W	1	
	R5900	D0GA390JA023	M 39 OHM, J, 1/16W	1	
	R5901	D1BB1002A055	M 10KOHM, J, 1/10W	1	
	R5902	D1BB5362A055	M53.6KOHM, J, 1/10W	1	PAVCCZ
	R5904	D1BB3002A055	M 30KOHM, J, 1/10W	1	
	R5906	D1BA4642A014	M46.4KOHM, J, 1/16 W	1	PAVCCZ
	R5907	D0GB363JA065	M 36K OHM J 1/10W	1	PAVCCZ
	R5910	D0GA472JA023	M 4.7KOHM, J, 1/16W	1	
	R5911	D0GA472JA023	M 4.7KOHM, J, 1/16W	1	
	R5912	D0GA472JA023	M 4.7KOHM, J, 1/16W	1	
	R5913	D0GA472JA023	M 4.7KOHM, J, 1/16W	1	
	R5916	D0GA683JA023	M 68KOHM, J, 1/16W	1	
	R5917	D0GA560JA023	M 56 OHM, J, 1/16W	1	
	R6953	D0GAR00J0005	M 0 OHM, 1/16W	1	
	R6956	D0GAR00J0005	M 0 OHM, 1/16W	1	
	R6957	D0GAR00J0005	M 0 OHM, 1/16W	1	
	R8008	D0GA331JA023	M 330 OHM, J, 1/16W	1	
	R8100	D1BB1271A087	M1.27KOHM, J, 1/16W	1	PAVCCZ
	R8102	D1BB2101A087	M 2.1KOHM, J, 1/10W	1	
	R8104	D1BB8200A087	M 820 OHM, J, 1/10W	1	
	R8106	D1BB2001A087	M 2KOHM, J, 1/10W	1	
	R8108	D0GB100JA065	M 10 OHM J 1/10W	1	
	R8110	D0GB100JA065	M 10 OHM J 1/10W	1	
	R8114	D0GA303JA023	M 30K OHM J 0.063W	1	PAVCCZ
	R8118	D0GA183JA023	M 18K OHM J, 1/16W	1	
	R8200	D1BA2400A014	M 240 OHM, J, 1/16 W	1	
	R8201	D1BA1001A014	M 1KOHM, J, 1/16 W	1	
	R8202	D1BA1001A014	M 1KOHM, J, 1/16 W	1	
	R8203	D1BA1001A014	M 1KOHM, J, 1/16 W	1	
	R8204	D1BA1001A014	M 1KOHM, J, 1/16 W	1	
	R8205	D1BA1001A014	M 1KOHM, J, 1/16 W	1	
	R8206	D1BA1001A014	M 1KOHM, J, 1/16 W	1	
	R8207	D1BA1001A014	M 1KOHM, J, 1/16 W	1	
	R8208	D1BA1001A014	M 1KOHM, J, 1/16 W	1	
	R8209	D0GA111JA023	M 110 OHM, J, 1/16W	1	
	R8210	D0GA111JA023	M 110 OHM, J, 1/16W	1	
	R8211	D1BA2400A014	M 240 OHM, J, 1/16 W	1	
	R8212	D1BA2400A014	M 240 OHM, J, 1/16 W	1	
	R8213	D0GA103JA015	M 10KOHM, J, 1/16W	1	
	R8214	D0GA103JA015	M 10KOHM, J, 1/16W	1	
	R8215	D1BA2400A014	M 240 OHM, J, 1/16 W	1	
	R8216	D1BA1001A014	M 1KOHM, J, 1/16 W	1	
	R8217	D1BA1001A014	M 1KOHM, J, 1/16 W	1	
	R8218	EXB28V220J	M 22 OHM 1/32 W	1	
	R8219	EXB28V220J	M 22 OHM 1/32 W	1	
	R8220	EXB28V220J	M 22 OHM 1/32 W	1	





Model No. : TX-P46ST30E/J, PF46ST30 Parts List

Safety	Ref. No.	Part No.	Part Name & Description	Q'ty	Remarks
	R8221	EXB28V220J	M 22 OHM 1/32 W	1	
	R8222	EXB28V220J	M 22 OHM 1/32 W	1	
	R8223	EXB28V220J	M 22 OHM 1/32 W	1	
	R8224	EXB28V220J	M 22 OHM 1/32 W	1	
	R8225	EXB28V220J	M 22 OHM 1/32 W	1	
	R8226	EXB28V220J	M 22 OHM 1/32 W	1	
	R8227	EXB28V220J	M 22 OHM 1/32 W	1	
	R8228	EXB28V220J	M 22 OHM 1/32 W	1	
	R8229	EXB28V220J	M 22 OHM 1/32 W	1	
	R8230	DOGA220JA023	M22 OHM, J,1/16 W	1	
	R8231	DOGA220JA023	M22 OHM, J,1/16 W	1	
	R8232	DOGA220JA023	M22 OHM, J,1/16 W	1	
	R8301	DOGA471JA023	M 470OHM, J,1/16W	1	
	R8302	DOGA360JA023	M 36 OHM, J,1/16W	1	PAVCCZ
	R8303	DOGA360JA023	M 36 OHM, J,1/16W	1	PAVCCZ
	R8304	D1BA6201A014	M 6.2KOHM, J,1/16 W	1	
	R8305	D1BA6201A014	M 6.2KOHM, J,1/16 W	1	
	R8307	D1BA6201A014	M 6.2KOHM, J,1/16 W	1	
	R8400	DOGA680JA023	M 68 OHM, J,1/16W	1	
	R8401	DOGA680JA023	M 68 OHM, J,1/16W	1	
	R8402	DOGA680JA023	M 68 OHM, J,1/16W	1	
	R8403	DOGA680JA023	M 68 OHM, J,1/16W	1	
	R8404	DOGA680JA023	M 68 OHM, J,1/16W	1	
	R8405	DOGA680JA023	M 68 OHM, J,1/16W	1	
	R8406	EXB2HV680J	M 68 OHM 1/16 W	1	
	R8407	EXB2HV680J	M 68 OHM 1/16 W	1	
	R8408	EXB2HV680J	M 68 OHM 1/16 W	1	
	R8409	EXB28V680JX	M 68 OHM 1/32 W	1	
	R8410	EXB2HV680J	M 68 OHM 1/16 W	1	
	R8411	EXB2HV680J	M 68 OHM 1/16 W	1	
	R8418	DOGA103JA015	M 10KOHM, J,1/16W	1	
	R8421	EXB2HV101J	M 100 OHM 1/16 W	1	
	R8424	DOGA223JA023	M 22K OHM J 1/16W	1	
	R8425	DOGA223JA023	M 22K OHM J 1/16W	1	
	R8426	DOGA473JA015	M 47KOHM, J,1/16W	1	
	R8427	DOGA473JA015	M 47KOHM, J,1/16W	1	
	R8429	DOGA103JA015	M 10KOHM, J,1/16W	1	
	R8433	DOGA103JA015	M 10KOHM, J,1/16W	1	
	R8434	DOGA103JA015	M 10KOHM, J,1/16W	1	
	R8435	DOGA223JA023	M 22K OHM J 1/16W	1	
	R8436	EXB2HV101J	M 100 OHM 1/16 W	1	
	R8437	EXB2HV473JV	M 47 KOHM 1/16 W	1	
	R8438	EXB2HV103JV	M 10 KOHM 1/16 W	1	
	R8440	DOGA103JA015	M 10KOHM, J,1/16W	1	
	R8441	DOGA103JA015	M 10KOHM, J,1/16W	1	
	R8442	DOGA103JA015	M 10KOHM, J,1/16W	1	
	R8601	DOGA101JA015	M 100 OHM, J,1/16W	1	
	R8602	DOGA101JA015	M 100 OHM, J,1/16W	1	
	R8603	DOGA101JA015	M 100 OHM, J,1/16W	1	
	R8606	DOGA472JA023	M 4.7KOHM, J,1/16W	1	
	R8607	DOGA472JA023	M 4.7KOHM, J,1/16W	1	
	R8608	DOGA102JA023	M1KOHM, J,1/16 W	1	
	R8609	D1BA6491A014	M6.49KOHM, J,1/16 W	1	
	R8610	DOGA221JA023	M220 OHM, J,1/16 W	1	
	R8615	DOGA105JA023	M 1M OHM, J,1/16W	1	
	R8616	DOGA472JA023	M 4.7KOHM, J,1/16W	1	
	R8617	DOGA103JA015	M 10KOHM, J,1/16W	1	
	R8618	DOGA103JA015	M 10KOHM, J,1/16W	1	
	R8620	DOGA103JA015	M 10KOHM, J,1/16W	1	
	R8621	DOGA103JA015	M 10KOHM, J,1/16W	1	
	R8624	DOGA560JA023	M 56 OHM, J,1/16W	1	
	R8625	DOGA560JA023	M 56 OHM, J,1/16W	1	

Model No. : TX-P46ST30E/J, PF46ST30 Parts List

Safety	Ref. No.	Part No.	Part Name & Description	Q'ty	Remarks
	R8626	DOGA560JA023	M 56 OHM, J,1/16W	1	
	R8627	DOGA560JA023	M 56 OHM, J,1/16W	1	
	R8628	DOGA560JA023	M 56 OHM, J,1/16W	1	
	R8629	DOGA560JA023	M 56 OHM, J,1/16W	1	
	R8630	D1HG1038A002	NETWORK RESISTER	1	
	R8632	EXB28V560JX	M 56 OHM 1/32 W	1	
	R8634	EXB28V560JX	M 56 OHM 1/32 W	1	
	R8635	EXB28V101JX	M 100 OHM 1/32 W	1	
	R8636	DOGA220JA023	M22 OHM, J.1/16 W	1	
	R8637	DOGA272JA023	M 2.7KOHM, J.1/16W	1	
	R8638	DOGA272JA023	M 2.7KOHM, J.1/16W	1	
	R8639	DOGA103JA015	M 10KOHM, J,1/16W	1	
	R8640	DOGA103JA015	M 10KOHM, J,1/16W	1	
	R8648	DOGA273JA023	M 27K OHM J ,1/16W	1	
	R8656	DOGA103JA015	M 10KOHM, J,1/16W	1	
	R8661	DOGA103JA015	M 10KOHM, J,1/16W	1	
	R8681	D1BA75R0A014	M 75 OHM, J.1/16 W	1	
	R8682	D1BA75R0A014	M 75 OHM, J.1/16 W	1	
	R8683	D1BA75R0A014	M 75 OHM, J.1/16 W	1	
	R8684	D1BA75R0A014	M 75 OHM, J.1/16 W	1	
	R8697	DOGA101JA015	M 100 OHM, J,1/16W	1	
	R8698	DOGA101JA015	M 100 OHM, J,1/16W	1	
	R8699	DOGA101JA015	M 100 OHM, J,1/16W	1	
	R8716	D1BB1911A087	M1.91KOHM, J.1/16W	1	PAVCCZ
	R8718	D1BB8200A087	M 820 OHM, J.1/10W	1	
	R8720	DOGB100JA065	M 10 OHM J 1/10W	1	
	R8722	DOGA273JA023	M 27K OHM J ,1/16W	1	
	R8742	D1BB5362A055	M53.6KOHM, J.1/10W	1	PAVCCZ
	R8743	D1BB1002A055	M 10KOHM, J.1/10W	1	
	R8744	DOGA390JA023	M 39 OHM, J,1/16W	1	
	R8745	D1BB1002A055	M 10KOHM, J.1/10W	1	
	R8746	DOGA222JA023	M 2.2KOHM, J,1/16W	1	
	R8747	DOGA683JA023	M 68KOHM, J,1/16W	1	
	R8748	DOGA473JA015	M 47KOHM, J,1/16W	1	
	R8749	DOGA222JA023	M 2.2KOHM, J,1/16W	1	
	R8750	DOGA392JA023	M 3.9KOHM, J,1/16W	1	
	R8751	DOGA222JA023	M 2.2KOHM, J,1/16W	1	
	R8752	DOGA332JA023	M 3.3KOHM, J,1/16W	1	
	R8753	DOGA102JA023	M1KOHM, J.1/16 W	1	
	R8754	DOGA103JA015	M 10KOHM, J,1/16W	1	
	R8755	DOGA221JA023	M220 OHM, J.1/16 W	1	
	R8756	DOGA104JA023	M100KOHM, J.1/16 W	1	
	R8757	DOGD102JA052	M 1.0KOHM, J,1/8W	1	PAVCCZ
	R8758	DOGA472JA023	M 4.7KOHM, J,1/16W	1	
	R8759	DOGA472JA023	M 4.7KOHM, J,1/16W	1	
	R8760	DOGA103JA015	M 10KOHM, J,1/16W	1	
	R8765	DOGA103JA015	M 10KOHM, J,1/16W	1	
	R8768	DOGA390JA023	M 39 OHM, J,1/16W	1	
	R8769	D1BB4301A055	M4.30KOHM, J.1/10W	1	
	R8770	D1BB3922A055	M39.2KOHM, 1/10W	1	PAVCCZ
	R8771	D1BB1002A055	M 10KOHM, J.1/10W	1	
	R8772	DOGA472JA023	M 4.7KOHM, J,1/16W	1	
	R8773	DOGA472JA023	M 4.7KOHM, J,1/16W	1	
	R8774	DOGA563JA023	M 56KOHM, J,0.063W	1	PAVCCZ
	R8775	DOGA473JA015	M 47KOHM, J,1/16W	1	
	R8806	D1BA7151A014	M7.15KOHM, J.1/16 W	1	
	R8807	DOGA102JA023	M1KOHM, J.1/16 W	1	
	R8811	DOGA103JA015	M 10KOHM, J,1/16W	1	
	R8816	DOGA103JA015	M 10KOHM, J,1/16W	1	
	R8818	DOGA103JA015	M 10KOHM, J,1/16W	1	
	R8819	DOGA103JA015	M 10KOHM, J,1/16W	1	
	R8820	DOGA103JA015	M 10KOHM, J,1/16W	1	

Model No. : TX-P46ST30E/J, PF46ST30 Parts List

Safety	Ref. No.	Part No.	Part Name & Description	Q'ty	Remarks
	R8821	D0GA473JA015	M 47KOHM, J,1/16W	1	
	R8824	D0GA103JA015	M 10KOHM, J,1/16W	1	
	R8831	D0GA103JA015	M 10KOHM, J,1/16W	1	
	R8835	D0GA103JA015	M 10KOHM, J,1/16W	1	
	R8848	D0GA102JA023	M1KOHM, J.1/16 W	1	
	R8849	D0GA103JA015	M 10KOHM, J,1/16W	1	
	R8852	D0GA243JA023	M 24K OHM J 0.063W	1	
	R8909	D0GA222JA023	M 2.2KOHM, J,1/16W	1	
	R8910	D0GA103JA015	M 10KOHM, J,1/16W	1	
	R8914	D0GA472JA023	M 4.7KOHM, J,1/16W	1	
	R8921	D0GA223JA023	M 22K OHM J 1/16W	1	
	R8964	D0GA472JA023	M 4.7KOHM, J,1/16W	1	
	R8972	EXB2HV680J	M 68 OHM 1/16 W	1	
	R9035	D0GA103JA015	M 10KOHM, J,1/16W	1	
	R9103	D0GA101JA015	M 100 OHM, J,1/16W	1	
	R9104	D0GA101JA015	M 100 OHM, J,1/16W	1	
	R9105	D0GA473JA015	M 47KOHM, J,1/16W	1	
	R9198	EXB28V101JX	M 100 OHM 1/32 W	1	
	R9203	D0GA272JA023	M 2.7KOHM, J.1/16W	1	
	R9205	D0GA333JA023	M 33KOHM, J,1/16W	1	
	R9206	D0GA563JA023	M 56KOHM, J,0.063W	1	PAVCCZ
	R9208	EXB2HV470JV	M 47 OHM 1/16 W	1	
	R9209	EXB2HV470JV	M 47 OHM 1/16 W	1	
	R9224	D0GA470JA023	M 47 OHM, J,1/16W	1	
	R9226	D0GA470JA023	M 47 OHM, J,1/16W	1	
	R9247	D0GA470JA023	M 47 OHM, J,1/16W	1	
	R9307	D0GA330JA023	M 33 OHM, J,1/16W	1	
	R9308	D0GA330JA023	M 33 OHM, J,1/16W	1	
	R9320	D0GA182JA023	M 1.8KOHM, J,0.063W	1	
	R9321	D0GA105JA023	M 1M OHM, J,1/16W	1	
	R9324	D0GB122JA065	M 1.2KOHM J 1/10W	1	PAVCCZ
	R9325	D0GB122JA065	M 1.2KOHM J 1/10W	1	PAVCCZ
	R9326	D0GB122JA065	M 1.2KOHM J 1/10W	1	PAVCCZ
	R9327	D0GB122JA065	M 1.2KOHM J 1/10W	1	PAVCCZ
	R9329	D0GA102JA023	M1KOHM, J.1/16 W	1	
	R9330	D0GA102JA023	M1KOHM, J.1/16 W	1	
	R9400	EXB2HV103JV	M 10 KOHM 1/16 W	1	
	R9401	EXB2HV103JV	M 10 KOHM 1/16 W	1	
	R9402	EXB28V103JX	M 10KOHM 1/32 W	1	
	R9533	EXB28V681J	M 680 OHM 1/32 W	1	PAVCCZ
	R9534	D0GA681JA023	M680 OHM, J,1/16W	1	
	R9535	EXB28V470JX	M 47 OHM 1/32 W	1	
	R9536	D0GA470JA023	M 47 OHM, J,1/16W	1	
	R9608	EXB2HV470JV	M 47 OHM 1/16 W	1	
	R9609	EXB28V470JX	M 47 OHM 1/32 W	1	
	R9610	EXB28V470JX	M 47 OHM 1/32 W	1	
	R9611	EXB28V470JX	M 47 OHM 1/32 W	1	
	R9907	D0GA101JA015	M 100 OHM, J,1/16W	1	
	RL100	K6B1AYY00081	RELAY	2	PAVCCZ
	RM2810	B3RAD0000168	REMOTE SENSOR	1	
	S10	K1KA03BA0061	3P CONNECTOR	1	
	S202	J0LY00000161	SERGE ABSORBER	1	PAVCCZ
	SN2810	B3JB00000078	IC	1	
	SW2890	K0F126A00003	SWITCH	1	PAVCCZ
	T201	G0C181K00005	PEAKING COIL	1	PAVCCZ
	T202	G0C181K00005	PEAKING COIL	1	PAVCCZ

Model No. : TX-P46ST30E/J, PF46ST30 Parts List

Safety	Ref. No.	Part No.	Part Name & Description	Q'ty	Remarks
⚠	T301	G4CYAYY00239	TRANS	1	PAVCCZ
⚠	T302	G4CYAYY00239	TRANS	1	PAVCCZ
	T303	G0C200K00001	PEAKING COIL	1	PAVCCZ
⚠	T401	G4DYA0000278	TRANS	1	PAVCCZ
	T8601	G5BYC0000015	TRANS	1	
⚠	TU4801	ENGS7302D5F	TUNER	1	PAVCCZ
	V14	K1KA06B00220	6P CONNECTOR	1	
	VR251	EVMAASA00BE4	CONTROL 22KOHMB	1	PAVCCZ
	VR600	EVMAASA00BE4	CONTROL 22KOHMB	1	PAVCCZ
	X8300	H0J245500110	CRYSTAL	1	PAVCCZ
	X8600	H0J250500109	CRYSTAL	1	
	X9300	H0J200500091	CRYSTAL	1	PAVCCZ
	ZA1	K4AD01A00002	TERMINAL	1	
	ZA100	K4AD01A00002	TERMINAL	1	
	ZA101	K4AD01A00002	TERMINAL	1	
	C10	K1MY20BA0345	20P CONNECTOR	1	
	C11	K1MY55BA0345	55P CONNECTOR	1	
	C14	K1KY03AA0719	3P CONNECTOR	1	
	C20	K1MY20BA0345	20P CONNECTOR	1	
	C21	K1MY55BA0345	55P CONNECTOR	1	
	C25	K1KY04B00013	4P CONNECTOR	1	PAVCCZ
	C16003	F1L2J562A022	C 5600PF, 630V	1	
	C16011	F2A2E191A264	E 190UF, 250V	1	PAVCCZ
	C16012	F2A2E191A264	E 190UF, 250V	1	PAVCCZ
	C16013	F2A2E191A264	E 190UF, 250V	1	PAVCCZ
	C16018	FOC2E115A280	C 1.1 UF 250 V	1	PAVCCZ
	C16041	ECJ1VB1H392K	C 3900UF, 50V	1	
	C16043	ECJ1VB1H392K	C 3900UF, 50V	1	
	C16044	F1E2J821A002	C 820PF, 630V	1	
	C16045	F1E2J821A002	C 820PF, 630V	1	
	C16051	ECJ1VB1H392K	C 3900UF, 50V	1	
	C16053	ECJ1VB1H392K	C 3900UF, 50V	1	
	C16061	F1E2J821A002	C 820PF, 630V	1	
	C16074	F1E2J821A002	C 820PF, 630V	1	
	C16101	F1L2J562A022	C 5600PF, 630V	1	
	C16104	F1H1E470A130	C 47PF, 25V	1	
	C16105	F1H1E470A130	C 47PF, 25V	1	
	C16131	F1K1E475A134	C 4.7UF 25V	1	
	C16132	F1H1C105A145	C 1 uF 16 V	1	
	C16133	F2A1E1010130	E 100UF, 25V	1	PAVCCZ
	C16135	F1K1E105A029	C 1UF, 25V	1	
	C16153	F1K1E475A134	C 4.7UF 25V	1	
	C16154	F1K1E475A134	C 4.7UF 25V	1	
	C16191	F1K1E475A134	C 4.7UF 25V	1	
	C16192	F1H1C105A145	C 1 uF 16 V	1	
	C16193	F2A1E4700094	E 47UF, 25V	1	
	C16195	F1K1E105A029	C 1UF, 25V	1	
	C16201	FOC2E405A279	C 4.0 UF 250 V	1	PAVCCZ
	C16202	FOC2E405A279	C 4.0 UF 250 V	1	PAVCCZ
	C16242	F1H1C105A145	C 1 uF 16 V	1	
	C16243	ECJ1VB1H103K	C 0.01UF, 50V	1	
	C16244	F1J1A106A087	C 10UF, 10V	1	
	C16271	F2A1E151B705	E 150UF, 25V	1	PAVCCZ
	C16280	F1K1E105A029	C 1UF, 25V	1	
	C16286	F1H1H104A970	C 0.1UF, , 50V	1	
	C16287	F1H1H104A970	C 0.1UF, , 50V	1	

Model No. : TX-P46ST30E/J, PF46ST30 Parts List

Safety	Ref. No.	Part No.	Part Name & Description	Q'ty	Remarks
	C16315	ECJ1VB1A105K	C 1UF, 10V	1	
	C16316	ECJ1XB1C104K	C 0.1UF, Z, 16V	1	
	C16317	ECJ1VB1A105K	C 1UF, 10V	1	
	C16318	FLJ1H104A717	C 0.1UF, 50V	1	
	C16319	FLJ1H104A717	C 0.1UF, 50V	1	
	C16328	F2A2T131A021	E 130UF, 220V	1	PAVCCZ
	C16330	FOC2E115A280	C 1.1 UF 250 V	1	PAVCCZ
	C16361	F1L2J1020001	C 1000PF, 630V	1	
	C16362	F1L2J562A022	C 5600PF, 630V	1	
	C16401	F1L2J562A022	C 5600PF, 630V	1	
	C16412	F2A2E191A264	E 190UF, 250V	1	PAVCCZ
	C16413	F2A2E191A264	E 190UF, 250V	1	PAVCCZ
	C16414	F2A2E191A264	E 190UF, 250V	1	PAVCCZ
	C16415	FOC2E115A280	C 1.1 UF 250 V	1	PAVCCZ
	C16421	F1L2J562A022	C 5600PF, 630V	1	
	C16441	ECJ1VB1H392K	C 3900UF, 50V	1	
	C16442	ECJ1VB1H392K	C 3900UF, 50V	1	
	C16451	ECJ1VB1H392K	C 3900UF, 50V	1	
	C16452	ECJ1VB1H392K	C 3900UF, 50V	1	
	C16460	F1E2J222A002	C 2200PF, 630V	1	
	C16472	ECJ1VB1A105K	C 1UF, 10V	1	
	C16490	F1H1C105A145	C 1 uF 16 V	1	
	C16502	F1K1E475A134	C 4.7UF 25V	1	
	C16503	F2A1E151B705	E 150UF, 25V	1	PAVCCZ
	C16505	F1K1E105A029	C 1UF, 25V	1	
	C16506	F1H1C105A145	C 1 uF 16 V	1	
	C16507	FOC2E115A280	C 1.1 UF 250 V	1	PAVCCZ
	C16531	F1K1E475A134	C 4.7UF 25V	1	
	C16534	F1H1C105A145	C 1 uF 16 V	1	
	C16551	F1K1E475A134	C 4.7UF 25V	1	
	C16561	FLJ1A106A087	C 10UF, 10V	1	
	C16562	F1H1C105A145	C 1 uF 16 V	1	
	C16564	F1H1C105A145	C 1 uF 16 V	1	
	C16565	ECJ1VB1H103K	C 0.01UF, 50V	1	
	C16566	ECJ1VB1H103K	C 0.01UF, 50V	1	
	C16567	F1H1C105A145	C 1 uF 16 V	1	
	C16584	ECJ1VB1H392K	C 3900UF, 50V	1	
	C16593	ECJ1XC1H102J	C 1000PF, J, 50V	1	
	C16602	F1H1H2200008	C 22PF, 50V	1	
	C16603	F1K2J102A014	C 1000PF, 630V	1	
	C16604	F1K2J102A014	C 1000PF, 630V	1	
	C16631	FOC2E405A279	C 4.0 UF 250 V	1	PAVCCZ
	C16632	FOC2E405A279	C 4.0 UF 250 V	1	PAVCCZ
	C16641	F1K2J222A014	C 2200PF ,630V	1	
	C16645	F1K2J102A014	C 1000PF, 630V	1	
	C16646	F1K2J102A014	C 1000PF, 630V	1	
	C16661	F1K2J102A038	C 1000PF, 630V	1	
	C16662	F1K2J102A038	C 1000PF, 630V	1	
	C16664	ECJ1XC1H820J	C 82PF, J, 50V	1	
	C16665	ECJ1XC1H820J	C 82PF, J, 50V	1	
	C16666	ECJ1XC1H820J	C 82PF, J, 50V	1	
	C16668	F1H1H821A831	C 820 PF, 50V	1	PAVCCZ
	C16685	F1H1H104A970	C 0.1UF, , 50V	1	
	C16692	F1H1H104A970	C 0.1UF, , 50V	1	
	C16723	F1K1E105A029	C 1UF, 25V	1	
	C16724	F1K1E475A134	C 4.7UF 25V	1	
	C16753	F1K1E475A134	C 4.7UF 25V	1	
	C16770	F1H1C105A145	C 1 uF 16 V	1	
	C16791	F2A1E151B705	E 150UF, 25V	1	PAVCCZ
	C16793	F2A1E151B705	E 150UF, 25V	1	PAVCCZ
	C16794	FLJ1A106A087	C 10UF, 10V	1	
	C16795	F2A1E151B705	E 150UF, 25V	1	PAVCCZ

Model No. : TX-P46ST30E/J, PF46ST30 Parts List

Safety	Ref. No.	Part No.	Part Name & Description	Q'ty	Remarks
	C16796	F1K1E475A134	C 4.7UF 25V	1	
	C16797	F1H1H104A970	C 0.1UF, , 50V	1	
	C16813	F2A2T131A021	E 130UF, 220V	1	PAVCCZ
	C16833	F1K2J222A014	C 2200PF ,630V	1	
	C16834	F1K2J222A014	C 2200PF ,630V	1	
	C16842	F2A2C131A210	E 130UF, 160V	1	PAVCCZ
	C16843	ECJ1VB1A105K	C 1UF, 10V	1	
	C16844	FLJ1H104A717	C 0.1UF, 50V	1	
	C16854	FLJ1H104A717	C 0.1UF, 50V	1	
	C16856	ECJ1VB1A105K	C 1UF, 10V	1	
	C16858	ECJ1XB1C104K	C 0.1UF, Z, 16V	1	
	C16859	FLJ1H104A717	C 0.1UF, 50V	1	
	C16860	ECJ1VB1A105K	C 1UF, 10V	1	
	C16861	ECJ1XB1C104K	C 0.1UF, Z, 16V	1	
	C16862	ECJ1VB1A105K	C 1UF, 10V	1	
	C16863	FLJ1H104A717	C 0.1UF, 50V	1	
	C16865	F1H1C105A145	C 1 uF 16 V	1	
	C16891	F1K1E105A029	C 1UF, 25V	1	
	C16902	F1E2J472A001	C 4700PF, 630V	1	
	C16903	F1E2J152A002	C 1500PF, 630V	1	
	C16907	F1E2J221A002	C 220PF, 630V	1	
	C16908	F1E2J821A002	C 820PF, 630V	1	
	C16909	F1E2J152A002	C 1500PF, 630V	1	
	C16910	F1E2J821A002	C 820PF, 630V	1	
	C16912	F1E2J821A002	C 820PF, 630V	1	
	C17101	ECJ1VB1A105K	C 1UF, 10V	1	
	C17102	ECJ1VB1A105K	C 1UF, 10V	1	
	C17103	ECJ1VB1A105K	C 1UF, 10V	1	
	C17108	F1K2A224A033	C 0.22UF, 100V	1	PAVCCZ
	C17109	F1K2A224A033	C 0.22UF, 100V	1	PAVCCZ
	C17112	F1K2A224A033	C 0.22UF, 100V	1	PAVCCZ
	C17131	ECJ1VB1A105K	C 1UF, 10V	1	
	C17132	ECJ1VB1A105K	C 1UF, 10V	1	
	C17133	F1K2A224A033	C 0.22UF, 100V	1	PAVCCZ
	C17136	F1K2A224A033	C 0.22UF, 100V	1	PAVCCZ
	C17137	ECJ1VB1A105K	C 1UF, 10V	1	
	C17138	ECJ1VB1A105K	C 1UF, 10V	1	
	C17139	F1K2A224A033	C 0.22UF, 100V	1	PAVCCZ
	C17142	F1K2A224A033	C 0.22UF, 100V	1	PAVCCZ
	C17143	ECJ1XB1C104K	C 0.1UF, Z, 16V	1	
	C17201	ECJ1VB1A105K	C 1UF, 10V	1	
	C17203	F1K2A224A033	C 0.22UF, 100V	1	PAVCCZ
	C17204	ECJ1VB1A105K	C 1UF, 10V	1	
	C17205	F1K2A224A033	C 0.22UF, 100V	1	PAVCCZ
	C17207	ECJ1VB1A105K	C 1UF, 10V	1	
	C17208	ECJ1VB1A105K	C 1UF, 10V	1	
	C17209	ECJ1VB1A105K	C 1UF, 10V	1	
	C17210	ECJ1VB1A105K	C 1UF, 10V	1	
	C17211	ECJ1VB1A105K	C 1UF, 10V	1	
	C17212	ECJ1VB1A105K	C 1UF, 10V	1	
	C17213	ECJ1XB1C104K	C 0.1UF, Z, 16V	1	
	C17226	F1K2A224A033	C 0.22UF, 100V	1	PAVCCZ
	C17228	F1L2E224A028	C 0.22UF, 250V	1	
	C17231	F1L2E224A028	C 0.22UF, 250V	1	
	C17233	F1K2A224A033	C 0.22UF, 100V	1	PAVCCZ
	C17235	F1K2A224A033	C 0.22UF, 100V	1	PAVCCZ
	C17236	F1K2A224A033	C 0.22UF, 100V	1	PAVCCZ
	CB1	K1MY55B00002	55P CONNECTOR	1	
	CB2	K1MY55B00002	55P CONNECTOR	1	
	CB3	K1MY55B00002	55P CONNECTOR	1	
	CB4	K1MY55B00002	55P CONNECTOR	1	

Model No. : TX-P46ST30E/J, PF46ST30 Parts List

Safety	Ref. No.	Part No.	Part Name & Description	Q'ty	Remarks
	CB5	K1MY55B00002	55P CONNECTOR	1	
	CB6	K1MY55B00002	55P CONNECTOR	1	
	CB7	K1MY55B00002	55P CONNECTOR	1	
	CB8	K1MY55B00002	55P CONNECTOR	1	
	CB9	K1MY55B00002	55P CONNECTOR	1	
	CB10	K1MY55B00002	55P CONNECTOR	1	
	CB11	K1MY55B00002	55P CONNECTOR	1	
	CB12	K1MY55B00002	55P CONNECTOR	1	
	CB13	K1MY55B00002	55P CONNECTOR	1	
	CB14	K1MY55B00002	55P CONNECTOR	1	
	CB15	K1MY55B00002	55P CONNECTOR	1	
	D16001	DA3CF30ACL	ZENER DIODE	1	PAVCCZ
	D16021	DA3CF30ACL	ZENER DIODE	1	PAVCCZ
	D16041	B0FCCN000003	DIODE	1	
	D16043	B0FCCN000003	DIODE	1	
	D16051	B0FCCN000003	DIODE	1	
	D16053	B0FCCN000003	DIODE	1	
	D16072	B0FCBN000001	DIODE	1	PAVCCZ
	D16131	B0ECKP000055	DIODE	1	
	D16133	B0ACCJ000048	DIODE	1	
	D16134	DZ2J051M0L	ZENER DIODE	1	
	D16191	B0ECKP000055	DIODE	1	
	D16192	B0ACCJ000048	DIODE	1	
	D16193	DZ2J051M0L	ZENER DIODE	1	
	D16243	B0ADCJ000100	DIODE	1	
	D16251	DZ2J330M0L	ZENER DIODE	1	
	D16252	DZ2J330M0L	ZENER DIODE	1	
	D16253	DZ2J051M0L	ZENER DIODE	1	
	D16254	B3ABB0000210	LED	1	
	D16255	B0ADCJ000100	DIODE	1	
	D16282	DZ2J068M0L	ZENER DIODE	1	
	D16285	B0ADEJ000035	ZENER DIODE	1	
	D16315	DZ2J150M0L	ZENER DIODE	1	
	D16316	B0ECKP000055	DIODE	1	
	D16317	B0ECKP000055	DIODE	1	
	D16362	DA3CF30ACL	ZENER DIODE	1	PAVCCZ
	D16401	B0FCCN000003	DIODE	1	
	D16407	B0JCME000093	DIODE	1	
	D16411	B0ADCJ000100	DIODE	1	
	D16413	B0ACCJ000048	DIODE	1	
	D16421	DA3CF30ACL	ZENER DIODE	1	PAVCCZ
	D16430	B0ECKP000055	DIODE	1	
	D16432	B0FCBN000001	DIODE	1	PAVCCZ
	D16461	B0FCCN000003	DIODE	1	
	D16462	B0FCCN000003	DIODE	1	
	D16473	B0ACCJ000048	DIODE	1	
	D16474	B0ACCJ000048	DIODE	1	
	D16475	DZ2J051M0L	ZENER DIODE	1	
	D16476	B0ACCJ000048	DIODE	1	
	D16481	B0FCCN000001	DIODE	1	
	D16482	B0FCCN000001	DIODE	1	
	D16491	B0ACCJ000048	DIODE	1	
	D16492	DZ2J047M0L	ZENER DIODE	1	
	D16493	B0ADCJ000100	DIODE	1	
	D16506	DZ2J051M0L	ZENER DIODE	1	
	D16534	DZ2J051M0L	ZENER DIODE	1	
	D16536	B0ECKP000055	DIODE	1	
	D16537	B0ADCJ000100	DIODE	1	
	D16538	B0ADCJ000100	DIODE	1	
	D16581	DZ2J330M0L	ZENER DIODE	1	
	D16582	DZ2J330M0L	ZENER DIODE	1	

Model No. : TX-P46ST30E/J, PF46ST30 Parts List

Safety	Ref. No.	Part No.	Part Name & Description	Q'ty	Remarks
	D16583	B3ABB0000210	LED	1	
	D16602	DZ2J043M0L	ZENER DIODE	1	
	D16603	B0ACCJ000048	DIODE	1	
	D16604	B0ADCJ000100	DIODE	1	
	D16605	B0ACCJ000048	DIODE	1	
	D16607	B0ACCJ000048	DIODE	1	
	D16608	B0ECKP000055	DIODE	1	
	D16609	B0ECKP000055	DIODE	1	
	D16618	B0ECKP000055	DIODE	1	
	D16641	B0FCCN000004	DIODE	1	PAVCCZ
	D16642	B0FCCN000004	DIODE	1	PAVCCZ
	D16643	B0FCCN000004	DIODE	1	PAVCCZ
	D16645	DZ2J150M0L	ZENER DIODE	1	
	D16646	DZ2J150M0L	ZENER DIODE	1	
	D16647	DZ2J150M0L	ZENER DIODE	1	
	D16648	DZ2J043M0L	ZENER DIODE	1	
	D16651	DZ2J051M0L	ZENER DIODE	1	
	D16652	B0ECKP000055	DIODE	1	
	D16662	DZ2J150M0L	ZENER DIODE	1	
	D16663	DZ2J150M0L	ZENER DIODE	1	
	D16664	DZ2J150M0L	ZENER DIODE	1	
	D16669	B0ACCJ000048	DIODE	1	
	D16673	B0ECHR000004	DIODE	1	PAVCCZ
	D16674	B0ECHR000004	DIODE	1	PAVCCZ
	D16685	B0ACCJ000048	DIODE	1	
	D16710	DZ2J15000L	ZENER DIODE	1	
	D16711	B0ECHR000004	DIODE	1	PAVCCZ
	D16712	B0ECHR000004	DIODE	1	PAVCCZ
	D16713	B0ECHS000002	DIODE	1	PAVCCZ
	D16714	B0ECHS000002	DIODE	1	PAVCCZ
	D16720	B0ECHR000004	DIODE	1	PAVCCZ
	D16728	B0ECKP000055	DIODE	1	
	D16791	DZ2J240M0L	ZENER DIODE	1	
	D16792	B0ACCJ000048	DIODE	1	
	D16795	B0ACCJ000048	DIODE	1	
	D16822	B0ACCJ000048	DIODE	1	
	D16823	B0ADCJ000100	DIODE	1	
	D16824	B0ACCJ000048	DIODE	1	
	D16825	DZ2J330M0L	ZENER DIODE	1	
	D16833	B0ECHR000004	DIODE	1	PAVCCZ
	D17101	B0ACCJ000048	DIODE	1	
	D17102	B0ACCJ000048	DIODE	1	
	D17103	B0JCCD000020	DIODE	1	PAVCCZ
	D17201	B0ACCJ000048	DIODE	1	
	D17202	B0ACCJ000048	DIODE	1	
	D17203	B0JCCD000020	DIODE	1	PAVCCZ
	IC16131	COZBZ0001822	IC	1	PAVCCZ
	IC16132	COZBZ0001822	IC	1	PAVCCZ
	IC16151	COZBZ0001822	IC	1	PAVCCZ
	IC16152	COZBZ0001822	IC	1	PAVCCZ
	IC16191	COZBZ0001822	IC	1	PAVCCZ
	IC16241	COJBAU000088	IC	1	
	IC16243	COJBAB000715	IC	1	
	IC16244	COJBAA000558	IC	1	PAVCCZ
	IC16304	MIP3910MSSCF	IC	1	
	IC16312	C0DBZMC00006	IC	1	
	IC16471	C0DBEYY00114	IC	1	
	IC16490	C0DBZMC00006	IC	1	
	IC16491	C0BBAA000008	LINEAR IC	1	
	IC16501	COZBZ0001822	IC	1	PAVCCZ
	IC16502	COZBZ0001822	IC	1	PAVCCZ

Model No. : TX-P46ST30E/J, PF46ST30 Parts List

Safety	Ref. No.	Part No.	Part Name & Description	Q'ty	Remarks
	IC16521	COZBZ0001822	IC	1	PAVCCZ
	IC16522	COZBZ0001822	IC	1	PAVCCZ
	IC16561	COJBAU000088	IC	1	
	IC16562	COJBAU000088	IC	1	
	IC16563	COJBAB000996	IC	1	PAVCCZ
	IC16564	COJBAB000321	IC	1	
	IC16565	COJBAB000321	IC	1	
	IC16684	COZBZ0001822	IC	1	PAVCCZ
	IC16691	COJBAC000509	IC	1	PAVCCZ
	IC16724	COCBAD00049	IC	1	
	IC16784	MIP3910MSSCF	IC	1	
	IC16785	COBZYY00352	IC	1	
	IC16786	MIP3910MSSCF	IC	1	
	IC16787	COBZYY00352	IC	1	
	IC16792	COBBA000008	LINEAR IC	1	
	IC16793	COBZMC00006	IC	1	
	IC16795	COCBALC00012	IC	1	
	IC16921	C1ZBZ0004292	IC	1	PAVCCZ
	IC17102	COJBAU000088	IC	1	
	IC17201	COJBAU000088	IC	1	
	L16001	GOCR18KA0214	PEAKING COIL	1	PAVCCZ
	L16002	GOCR18KA0214	PEAKING COIL	1	PAVCCZ
	L16303	GOC471MA0049	PEAKING COIL	1	
	L16411	GOCR18KA0214	PEAKING COIL	1	PAVCCZ
	L16412	GOCR18KA0214	PEAKING COIL	1	PAVCCZ
	PC16131	B3PBE0000058	IC	1	PAVCCZ
	PC16191	B3PBE0000060	IC	1	PAVCCZ
	PC16251	B3PBA0000498	IC	1	
	PC16301	B3PBA0000498	IC	1	
	PC16461	B3PBE0000058	IC	1	PAVCCZ
	PC16462	B3PBE0000060	IC	1	PAVCCZ
	PC16480	B3PBA0000498	IC	1	
	PC16581	B3PBA0000498	IC	1	
	PC16603	B3PBA0000498	IC	1	
	PC16685	B3PBA0000496	IC	1	
	PC16723	B3PBA0000498	IC	1	
	PC16896	B3PBA0000498	IC	1	
	PC16897	B3PBA0000498	IC	1	
	Q16001	B1JBDN000004	TRANSISTOR	1	PAVCCZ
	Q16002	B1JBDN000004	TRANSISTOR	1	PAVCCZ
	Q16003	B1JBDN000004	TRANSISTOR	1	PAVCCZ
	Q16021	B1JBEN000004	TRANSISTOR	1	PAVCCZ
	Q16022	B1JBEN000004	TRANSISTOR	1	PAVCCZ
	Q16023	B1JBEN000004	TRANSISTOR	1	PAVCCZ
	Q16041	DG3C3020CL	TRANSISTOR	1	PAVCCZ
	Q16043	DG3C3020CL	TRANSISTOR	1	PAVCCZ
	Q16051	DG3C3020CL	TRANSISTOR	1	PAVCCZ
	Q16053	DG3C3020CL	TRANSISTOR	1	PAVCCZ
	Q16055	B1HFPPA00001	TRANSISTOR	1	
	Q16056	B1HFPPA00001	TRANSISTOR	1	
	Q16101	B1CFRM000015	FET	1	
	Q16102	B1CFRM000023	FET	1	PAVCCZ
	Q16141	B1HFPPA00001	TRANSISTOR	1	
	Q16161	B1HFPPA00001	TRANSISTOR	1	
	Q16251	B1ABCF000231	TRANSISTOR	1	
	Q16280	B1ABCE000015	TRANSISTOR	1	
	Q16401	B1JBDN000004	TRANSISTOR	1	PAVCCZ
	Q16402	B1JBDN000004	TRANSISTOR	1	PAVCCZ
	Q16403	B1JBDN000004	TRANSISTOR	1	PAVCCZ

Model No. : TX-P46ST30E/J, PF46ST30 Parts List

Safety	Ref. No.	Part No.	Part Name & Description	Q'ty	Remarks
	Q16421	B1JBEN000004	TRANSISTOR	1	PAVCCZ
	Q16422	B1JBEN000004	TRANSISTOR	1	PAVCCZ
	Q16423	B1JBEN000004	TRANSISTOR	1	PAVCCZ
	Q16441	DG3C3020CL	TRANSISTOR	1	PAVCCZ
	Q16442	DG3C3020CL	TRANSISTOR	1	PAVCCZ
	Q16451	DG3C3020CL	TRANSISTOR	1	PAVCCZ
	Q16452	DG3C3020CL	TRANSISTOR	1	PAVCCZ
	Q16471	B1ABCE000015	TRANSISTOR	1	
	Q16501	B1HFPPA00001	TRANSISTOR	1	
	Q16521	B1HFPPA00001	TRANSISTOR	1	
	Q16531	B1HFPPA00001	TRANSISTOR	1	
	Q16538	B1CBGD000001	FET	1	
	Q16551	B1HFPPA00001	TRANSISTOR	1	
	Q16581	B1ABCF000231	TRANSISTOR	1	
	Q16600	B1CFRM000020	FET	1	PAVCCZ
	Q16601	B1CFRQ000022	FET	1	PAVCCZ
	Q16602	DSA2001S0L	TRANSISTOR	1	
	Q16606	DSC2001S0L	TRANSISTOR	1	
	Q16607	B1CBGD000001	FET	1	
	Q16621	B1JBDN000004	TRANSISTOR	1	PAVCCZ
	Q16622	B1JBDN000004	TRANSISTOR	1	PAVCCZ
	Q16623	B1JBDN000004	TRANSISTOR	1	PAVCCZ
	Q16646	DSA2001S0L	TRANSISTOR	1	
	Q16647	B1CBGD000001	FET	1	
	Q16660	B1CFRQ000021	FET	1	PAVCCZ
	Q16661	B1JBER000002	TRANSISTOR	1	PAVCCZ
	Q16762	B1HFPPA00001	TRANSISTOR	1	
	Q16815	B1ABCN000007	TRANSISTOR	1	
	Q16817	DSC2001Q0L	TRANSISTOR	1	
	Q16818	B1CBGD000001	FET	1	
	Q16819	B1CBGD000001	FET	1	
	Q16820	B1CBGD000001	FET	1	
	Q16891	DSA2001S0L	TRANSISTOR	1	
	Q16892	DSC2001Q0L	TRANSISTOR	1	
	Q16921	B1CBGD000001	FET	1	
	Q16922	B1CBGD000001	FET	1	
	Q16931	B1ABCN000007	TRANSISTOR	1	
	Q17101	B1ABCN000007	TRANSISTOR	1	
	Q17201	B1ABCN000007	TRANSISTOR	1	
	R16001	D0GF7R5JA047	M 7.5 OHM, J, 1/3W	1	
	R16002	D0GF7R5JA047	M 7.5 OHM, J, 1/3W	1	
	R16003	D0GF7R5JA047	M 7.5 OHM, J, 1/3W	1	
	R16021	D0GF7R5JA047	M 7.5 OHM, J, 1/3W	1	
	R16022	D0GF7R5JA047	M 7.5 OHM, J, 1/3W	1	
	R16023	D0GF7R5JA047	M 7.5 OHM, J, 1/3W	1	
	R16031	D0GF473JA048	M 47KOHM, J, 1/3W	1	PAVCCZ
	R16032	D0GF473JA048	M 47KOHM, J, 1/3W	1	PAVCCZ
	R16041	D0GF5R6JA047	M 5.6 OHM, J, 1/3W	1	
	R16043	D0GF5R6JA047	M 5.6 OHM, J, 1/3W	1	
	R16051	D0GF5R6JA047	M 5.6 OHM, J, 1/3W	1	
	R16053	D0GF5R6JA047	M 5.6 OHM, J, 1/3W	1	
	R16101	D0GD150JA059	M 15 OHM, J, 1/4W	1	
	R16102	D0GD150JA059	M 15 OHM, J, 1/4W	1	
	R16105	D0GF474JA048	M 470KOHM, J, 1/3W	1	PAVCCZ
	R16116	D0GB473JA065	M 47KOHM J. 1/10W	1	PAVCCZ
	R16130	D0GB103JA065	M 10K OHM J 1/10W	1	
	R16131	D0GB220JA065	M 22 OHM J 1/10W	1	PAVCCZ
	R16132	D0GB101JA065	M 100 OHM, J, 1/10W	1	
	R16133	D1BD2700A044	M 270 OHM, J, 1/8 W	1	
	R16134	D0GD750JA059	M 75 OHM, J, 1/4W	1	
	R16135	D0GB4R7JA065	M 4.7 OHM J 1/10W	1	PAVCCZ

Model No. : TX-P46ST30E/J, PF46ST30 Parts List

Safety	Ref. No.	Part No.	Part Name & Description	Q'ty	Remarks
	R16137	D0GZ1R0JA020	M 1 OHM, J,1/2W	1	
	R16138	D0GF561JA047	M 560 OHM,J, 1/3W	1	PAVCCZ
	R16141	D0GD100JA059	M 10 OHM,J,1/4W	1	
	R16143	D0GB473JA065	M 47KOHM J. 1/10W	1	PAVCCZ
	R16151	D0GB220JA065	M 22 OHM J 1/10W	1	PAVCCZ
	R16152	D0GB220JA065	M 22 OHM J 1/10W	1	PAVCCZ
	R16153	D0GB331JA065	M330 OHM J 1/10W	1	PAVCCZ
	R16154	D0GD750JA059	M 75 OHM,J,1/4W	1	
	R16155	D0GB473JA065	M 47 OHM J 1/10W	1	PAVCCZ
	R16161	D0GD100JA059	M 10 OHM,J,1/4W	1	
	R16163	D0GB473JA065	M 47KOHM J. 1/10W	1	PAVCCZ
	R16171	D0GD100JA059	M 10 OHM,J,1/4W	1	
	R16173	D0GB473JA065	M 47KOHM J. 1/10W	1	PAVCCZ
	R16181	D0GD100JA059	M 10 OHM,J,1/4W	1	
	R16183	D0GB473JA065	M 47KOHM J. 1/10W	1	PAVCCZ
	R16191	D1BD2700A044	M 270 OHM,J.1/8 W	1	
	R16192	D0GB103JA065	M 10K OHM J 1/10W	1	
	R16193	D0GD750JA052	M 75 OHM,J,1/8W	1	PAVCCZ
	R16195	D0GF1R0JA047	M 1 OHM,J,1/3W	1	
	R16196	D0GF102JA048	M 1.0 KOHM,J,1/3W	1	PAVCCZ
	R16197	D0GB220JA065	M 22 OHM J 1/10W	1	PAVCCZ
	R16230	D0GD470JA052	M 47 OHM,J,1/8W	1	PAVCCZ
	R16231	D0GB472JA065	M 4.7KOHM, J,1/10W	1	
	R16241	EXB38V470J	M 47 OHM 1/16 W	1	
	R16242	EXB38V472JV	M 4.7 KOHM 1/16 W	1	
	R16243	D0GB103JA065	M 10K OHM J 1/10W	1	
	R16244	D0GB273JA065	M 27K OHM J 1/10W	1	PAVCCZ
	R16245	D0GB472JA065	M 4.7KOHM, J,1/10W	1	
	R16246	D0GD222JA052	M 2.2KOHM,J,1/8W	1	PAVCCZ
	R16252	D0GF563JA048	M 56 KOHM,J,1/3W	1	PAVCCZ
	R16253	D1BD1003A044	M 100KOHM,J.1/8 W	1	
	R16254	D1BD4422A044	M44.2KOHM,F.1/8W	1	PAVCCZ
	R16255	D0GB103JA065	M 10K OHM J 1/10W	1	
	R16257	D0GB473JA065	M 47KOHM J. 1/10W	1	PAVCCZ
	R16281	D0GB103JA065	M 10K OHM J 1/10W	1	
	R16282	D0GD221JA052	M 220 OHM,J 1/4W	1	PAVCCZ
	R16283	D0GB473JA065	M 47KOHM J. 1/10W	1	PAVCCZ
	R16284	D0GB224JA065	M 220KOHM,J,1/10W	1	PAVCCZ
	R16285	EXB38V623J	M 62 KOHM 1/16 W	1	
	R16289	D0GF334JA047	M 330KOHMJ,1/3W	1	
	R16290	D0GF334JA047	M 330KOHMJ,1/3W	1	
	R16307	D1BD5232A077	M52.3KOHM,D.1/10W	1	PAVCCZ
	R16309	ERG2FJX563	M 56KOHM, J, 2W	1	PAVCCZ
	R16310	ERG2FJX563	M 56KOHM, J, 2W	1	PAVCCZ
	R16311	ERG2FJX563	M 56KOHM, J, 2W	1	PAVCCZ
	R16317	D1BD5232A077	M52.3KOHM,D.1/10W	1	PAVCCZ
	R16318	D1BD5762A077	M57.6KOHM,D.1/10W	1	PAVCCZ
	R16319	D1BD2491A077	M 2.49KOHM,D.1/10W	1	PAVCCZ
	R16320	ERJ14YJ683	M 68KOHM, J. 1/4W	1	
	R16330	D0GB102JA065	M 1KOHM,J,1/10W	1	
	R16332	D0GB474JA065	M 470KOHM,J,1/10W	1	
	R16334	D0GB472JA065	M 4.7KOHM, J,1/10W	1	
	R16335	D0GB102JA065	M 1KOHM,J,1/10W	1	
	R16401	D0GF7R5JA047	M 7.5 OHM,J, 1/3W	1	
	R16402	D0GF7R5JA047	M 7.5 OHM,J, 1/3W	1	
	R16403	D0GF7R5JA047	M 7.5 OHM,J, 1/3W	1	
	R16411	D1BD2700A044	M 270 OHM,J.1/8 W	1	
	R16412	D1BD2700A044	M 270 OHM,J.1/8 W	1	
	R16414	D0GB103JA065	M 10K OHM J 1/10W	1	
	R16416	D0GB103JA065	M 10K OHM J 1/10W	1	
	R16421	D0GF7R5JA047	M 7.5 OHM,J, 1/3W	1	
	R16422	D0GF7R5JA047	M 7.5 OHM,J, 1/3W	1	

Model No. : TX-P46ST30E/J, PF46ST30 Parts List

Safety	Ref. No.	Part No.	Part Name & Description	Q'ty	Remarks
	R16423	D0GF7R5JA047	M 7.5 OHM, J, 1/3W	1	
	R16441	D0GF5R6JA047	M 5.6 OHM, J, 1/3W	1	
	R16442	D0GF5R6JA047	M 5.6 OHM, J, 1/3W	1	
	R16451	D0GF5R6JA047	M 5.6 OHM, J, 1/3W	1	
	R16452	D0GF5R6JA047	M 5.6 OHM, J, 1/3W	1	
	R16466	D0GF473JA048	M 47KOHM, J, 1/3W	1	PAVCCZ
	R16467	D0GF473JA048	M 47KOHM, J, 1/3W	1	PAVCCZ
	R16471	D0GB392JA065	M 3.9KOHM, J, 1/10W	1	PAVCCZ
	R16472	D0GB222JA065	M 2.2KOHM, J, 1/10W	1	
	R16473	D0GD561JA052	M 560 OHM, J, 1/4W	1	PAVCCZ
	R16474	D0GB102JA065	M 1KOHM, J, 1/10W	1	
	R16475	D0GB472JA065	M 4.7KOHM, J, 1/10W	1	
	R16476	D0GB222JA065	M 2.2KOHM, J, 1/10W	1	
	R16478	D0GB562JA065	M 5.6KOHM, J, 1/10W	1	PAVCCZ
	R16479	D0GD103JA052	M 10KOHM, J, 1/8W	1	PAVCCZ
	R16490	D1BD1203A077	M 120KOHM, D.1/10W	1	PAVCCZ
	R16491	D1BD1203A077	M 120KOHM, D.1/10W	1	PAVCCZ
	R16492	D1BD1203A077	M 120KOHM, D.1/10W	1	PAVCCZ
	R16493	D1BD5111A077	M5.11KOHM, J.1/8 W	1	PAVCCZ
	R16494	D1BB2001A055	M 2KOHM, J.1/10W	1	
	R16497	D0GB473JA065	M 47KOHM J. 1/10W	1	PAVCCZ
	R16498	D0GB103JA065	M 10K OHM J 1/10W	1	
	R16501	D0GB220JA065	M 22 OHM J 1/10W	1	PAVCCZ
	R16503	D0GD100JA059	M 10 OHM, J, 1/4W	1	
	R16505	D0GF102JA048	M 1.0 KOHM, J, 1/3W	1	PAVCCZ
	R16506	D0GD100JA059	M 10 OHM, J, 1/4W	1	
	R16507	D0GB220JA065	M 22 OHM J 1/10W	1	PAVCCZ
	R16508	D0GB220JA065	M 22 OHM J 1/10W	1	PAVCCZ
	R16512	D0GB473JA065	M 47KOHM J. 1/10W	1	PAVCCZ
	R16517	D0GB473JA065	M 47KOHM J. 1/10W	1	PAVCCZ
	R16522	D0GB101JA065	M 100 OHM, J, 1/10W	1	
	R16525	D0GB4R7JA065	M 4.7 OHM J 1/10W	1	PAVCCZ
	R16526	D0GB4R7JA065	M 4.7 OHM J 1/10W	1	PAVCCZ
	R16531	D0GD100JA059	M 10 OHM, J, 1/4W	1	
	R16532	D0GB473JA065	M 47KOHM J. 1/10W	1	PAVCCZ
	R16534	D0GF561JA047	M 560 OHM, J, 1/3W	1	PAVCCZ
	R16536	D0GF1R0JA047	M 1 OHM, J, 1/3W	1	
	R16537	D0GF1R0JA047	M 1 OHM, J, 1/3W	1	
	R16551	D0GD100JA059	M 10 OHM, J, 1/4W	1	
	R16552	D0GB473JA065	M 47KOHM J. 1/10W	1	PAVCCZ
	R16561	EXB38V470J	M 47 OHM 1/16 W	1	
	R16562	EXB38V470J	M 47 OHM 1/16 W	1	
	R16563	EXB38V470J	M 47 OHM 1/16 W	1	
	R16564	EXB38V470J	M 47 OHM 1/16 W	1	
	R16565	EXB38V472JV	M 4.7 KOHM 1/16 W	1	
	R16566	EXB38V472JV	M 4.7 KOHM 1/16 W	1	
	R16567	EXB38V472JV	M 4.7 KOHM 1/16 W	1	
	R16568	EXB38V472JV	M 4.7 KOHM 1/16 W	1	
	R16570	EXB38V472JV	M 4.7 KOHM 1/16 W	1	
	R16573	D0GB103JA065	M 10K OHM J 1/10W	1	
	R16574	D0GB103JA065	M 10K OHM J 1/10W	1	
	R16575	D0GB751JA065	M750 OHM J 1/10W	1	PAVCCZ
	R16576	D0GB101JA065	M 100 OHM, J, 1/10W	1	
	R16579	EXB38V470J	M 47 OHM 1/16 W	1	
	R16581	D0GB103JA065	M 10K OHM J 1/10W	1	
	R16582	D0GF563JA048	M 56 KOHM, J, 1/3W	1	PAVCCZ
	R16583	D1BD1003A044	M 100KOHM, J.1/8 W	1	
	R16584	D1BD4422A044	M44.2KOHM, F.1/8W	1	PAVCCZ
	R16585	D0GB473JA065	M 47KOHM J. 1/10W	1	PAVCCZ
	R16587	D0GB222JA065	M 2.2KOHM, J, 1/10W	1	
	R16588	D0GB223JA065	M 22KOHM, J, 1/10W	1	PAVCCZ
	R16590	D0GB221JA065	M 220 OHM J 1/10W	1	

Model No. : TX-P46ST30E/J, PF46ST30 Parts List

Safety	Ref. No.	Part No.	Part Name & Description	Q'ty	Remarks
	R16591	EXB38V472JV	M 4.7 kOHM 1/16 W	1	
	R16594	D0GB472JA065	M 4.7KOHM, J,1/10W	1	
	R16601	D0GF1R0JA047	M 1 OHM,J,1/3W	1	
	R16604	D0GD331JA052	M 330 OHM,J,1/4W	1	PAVCCZ
	R16605	D0GD220JA059	M 22 OHM,J,1/4W	1	PAVCCZ
	R16606	D0GD223JA052	M 22KOHM, J,1/4W	1	PAVCCZ
	R16607	D1BB5111A055	M5.11KOHM,J.1/10W	1	
	R16608	ERG2FJX153	M 15KOHM, J, 2W	1	PAVCCZ
	R16609	D0GF102JA047	M 1.0 KOHM,J,1/3W	1	
	R16610	D0GB104JA065	M 100KOHM J 1/10W	1	
	R16612	D0GD220JA059	M 22 OHM,J,1/4W	1	PAVCCZ
	R16615	D1BB1871A055	M1.87KOHM, 1/10W	1	PAVCCZ
	R16617	D0GD222JA052	M 2.2KOHM, J,1/8W	1	PAVCCZ
	R16621	D0GD221JA052	M 220 OHM, J 1/4W	1	PAVCCZ
	R16622	D0GD221JA052	M 220 OHM, J 1/4W	1	PAVCCZ
	R16623	D0GD221JA052	M 220 OHM, J 1/4W	1	PAVCCZ
	R16631	D0GB103JA065	M 10K OHM J 1/10W	1	
	R16633	D0GD223JA052	M 22KOHM, J,1/4W	1	PAVCCZ
	R16634	D0GD222JA052	M 2.2KOHM, J,1/8W	1	PAVCCZ
	R16645	D0GB562JA065	M 5.6KOHM, J,1/10W	1	PAVCCZ
	R16646	D1BD8660A044	M 866 OHM, F.1/8W	1	PAVCCZ
	R16648	D0GF202JA047	M 2KOHM, J,1/3W	1	
	R16649	D0GD330JA059	M 33 OHM, F,1/4W	1	
	R16650	D0GB104JA065	M 100KOHM J 1/10W	1	
	R16651	D0GF202JA047	M 2KOHM, J,1/3W	1	
	R16653	D0GD222JA052	M 2.2KOHM, J,1/8W	1	PAVCCZ
	R16654	D0GD470JA052	M 47 OHM, J,1/8W	1	PAVCCZ
	R16658	D1BD6491A077	M6.49KOHM, D.1/10W	1	PAVCCZ
	R16661	D0GD100JA059	M 10 OHM, J,1/4W	1	
	R16662	D1BB1002A087	M 10KOHM, J.1/10W	1	
	R16663	D1BD9091A077	M 9.09KOHM, D.1/10W	1	PAVCCZ
	R16664	D0GF202JA047	M 2KOHM, J,1/3W	1	
	R16665	D0GD222JA052	M 2.2KOHM, J,1/8W	1	PAVCCZ
	R16666	D1BB1003A087	M100KOHM, D 1/10W	1	PAVCCZ
	R16667	D0GF202JA047	M 2KOHM, J,1/3W	1	
	R16668	D0GF202JA047	M 2KOHM, J,1/3W	1	
	R16674	D0GF202JA047	M 2KOHM, J,1/3W	1	
	R16675	D0GB103JA065	M 10K OHM J 1/10W	1	
	R16676	D1BD2700A044	M 270 OHM, J.1/8 W	1	
	R16677	D0GF202JA047	M 2KOHM, J,1/3W	1	
	R16678	D0GF202JA047	M 2KOHM, J,1/3W	1	
	R16681	D0GD100JA059	M 10 OHM, J,1/4W	1	
	R16682	D0GD100JA059	M 10 OHM, J,1/4W	1	
	R16683	D0GD100JA059	M 10 OHM, J,1/4W	1	
	R16684	D0GB220JA065	M 22 OHM J 1/10W	1	PAVCCZ
	R16685	D1BD1500A044	M 150 OHM, J.1/8 W	1	
	R16686	D0GB103JA065	M 10K OHM J 1/10W	1	
	R16696	D0D26R2JA034	M 2.6 OHM, J, 2W	1	
	R16697	D0D26R2JA034	M 2.6 OHM, J, 2W	1	
	R16698	D0D26R2JA034	M 2.6 OHM, J, 2W	1	
	R16699	D0D26R2JA034	M 2.6 OHM, J, 2W	1	
	R16719	D0GB220JA065	M 22 OHM J 1/10W	1	PAVCCZ
	R16721	EXB38V220JV	M 22 OHM 1/16 W	1	
	R16761	D0GD100JA059	M 10 OHM, J,1/4W	1	
	R16763	D0GB473JA065	M 47KOHM J. 1/10W	1	PAVCCZ
	R16772	D0GB472JA065	M 4.7KOHM, J,1/10W	1	
	R16773	D0GD102JA052	M 1.0KOHM, J,1/8W	1	PAVCCZ
	R16776	D0GD470JA052	M 47 OHM, J,1/8W	1	PAVCCZ
	R16786	D1BD5902A044	M 59KOHM, F.1/8W	1	PAVCCZ
	R16791	D0GB102JA065	M 1KOHM, J,1/10W	1	
	R16797	D0GD220JA052	M 22 OHM, J,1/4W	1	PAVCCZ
	R16798	D0GB222JA065	M 2.2KOHM, J,1/10W	1	

Model No. : TX-P46ST30E/J, PF46ST30 Parts List

Safety	Ref. No.	Part No.	Part Name & Description	Q'ty	Remarks
	R16799	D0GB102JA065	M 1KOHM, J, 1/10W	1	
	R16815	D0GB103JA065	M 10K OHM J 1/10W	1	
	R16818	D1BB3302A055	M 33KOHM, J, 1/10W	1	
	R16819	D1BD1503A044	M 150KOHM, F, 1/8W	1	PAVCCZ
	R16820	D1BD1503A044	M 150KOHM, F, 1/8W	1	PAVCCZ
	R16822	D1BD8202A044	M 82KOHM, J, 1/8 W	1	
	R16823	D1BD6192A044	M61.9KOHM, J, 1/8 W	1	
	R16824	D1BD3742A044	M37.4KOHM, F, 1/8W	1	
	R16825	D0GD154JA059	M 150KOHM, J, 1/4W	1	
	R16826	D0GB103JA065	M 10K OHM J 1/10W	1	
	R16829	D0GB102JA065	M 1KOHM, J, 1/10W	1	
	R16831	D1BD6812A077	M68.1KOHM, D, 1/10W	1	PAVCCZ
	R16832	D1BD7152A077	M71.5K0OHM, D, 1/10W	1	PAVCCZ
	R16833	ERG1FJX683	M 68KOHM, J, 1W	1	PAVCCZ
	R16834	ERG1FJX683	M 68KOHM, J, 1W	1	PAVCCZ
	R16838	ERG2FJX104	M 100KOHM, J, 1W	1	
	R16841	D0GB472JA065	M 4.7KOHM, J, 1/10W	1	
	R16842	D0GD102JA052	M 1.0KOHM, J, 1/8W	1	PAVCCZ
	R16844	ERA6YEB242	M 2.4KOHM, B 1/10W	1	
	R16845	D1BD6812A077	M68.1KOHM, D, 1/10W	1	PAVCCZ
	R16846	D1BD5762A077	M57.6KOHM, D, 1/10W	1	PAVCCZ
	R16847	D1BD6492A077	M64.9KOHM, D, 1/10W	1	PAVCCZ
	R16851	D0GB474JA065	M 470KOHM, J, 1/10W	1	
	R16852	D0GB474JA065	M 470KOHM, J, 1/10W	1	
	R16856	D0GB102JA065	M 1KOHM, J, 1/10W	1	
	R16873	ERA6YEB242	M 2.4KOHM, B 1/10W	1	
	R16891	D1BF6982A058	M 69.8KOHM, 1/4W	1	
	R16892	D1BF8252A058	M82.50KOHM, 1/4W	1	
	R16893	D1BF8252A058	M82.50KOHM, 1/4W	1	
	R16894	D1BB3091A087	M3.09KOHM, D 1/16W	1	PAVCCZ
	R16895	D1BB9091A087	M9.09 KOHM, J, 1/10W	1	PAVCCZ
	R16897	D1BB2262A055	M22.6KOHM F 1/10W	1	PAVCCZ
	R16898	D1BB1051A055	M1.05KOHM, J, 1/10W	1	
	R16899	D1BB1372A055	M13.7KOHM, 1/10W	1	PAVCCZ
	R16900	D1BB3831A055	M3.83KOHM, D 1/16W	1	PAVCCZ
	R16902	D0GB6R2JA065	M 6.2 OHM J 1/10W	1	PAVCCZ
	R16919	D1BB1582A055	M15.8KOHM, 1/10W	1	PAVCCZ
	R16920	D0GB101JA065	M 100 OHM, J, 1/10W	1	
	R16921	D1BB2152A055	M 21.5KOHM, 1/10W	1	PAVCCZ
	R16922	D1BB9531A055	M9.53KOHM, J, 1/10W	1	
	R16923	D1BB5111A055	M5.11KOHM, J, 1/10W	1	
	R16924	D1BB1152A055	M 11.5KOHM 1/10W	1	PAVCCZ
	R16931	D1BF2R70A021	M 2.7 OHM, 1/4W	1	
	R16932	D0GD223JA052	M 22KOHM, J, 1/4W	1	PAVCCZ
	R16937	D0GB184JA065	M 180KOHM J 1/10W	1	PAVCCZ
	R16939	D0GD102JA052	M 1.0KOHM, J, 1/8W	1	PAVCCZ
	R16940	D0GB473JA065	M 47KOHM J. 1/10W	1	PAVCCZ
	R16941	D0GB472JA065	M 4.7KOHM, J, 1/10W	1	
	R16942	D0GB473JA065	M 47KOHM J. 1/10W	1	PAVCCZ
	R16945	D0GB471JA065	M 470 OHM, J, 1/10W	1	PAVCCZ
	R17101	D0GB101JA065	M 100 OHM, J, 1/10W	1	
	R17102	D0GB101JA065	M 100 OHM, J, 1/10W	1	
	R17103	D0GB101JA065	M 100 OHM, J, 1/10W	1	
	R17104	D0GB101JA065	M 100 OHM, J, 1/10W	1	
	R17105	D0GB101JA065	M 100 OHM, J, 1/10W	1	
	R17106	D0GB101JA065	M 100 OHM, J, 1/10W	1	
	R17107	D0GB101JA065	M 100 OHM, J, 1/10W	1	
	R17108	D0GB101JA065	M 100 OHM, J, 1/10W	1	
	R17109	D0GZ1R0JA020	M 1 OHM, J, 1/2W	1	
	R17111	D0GZ1R0JA020	M 1 OHM, J, 1/2W	1	
	R17113	D0GZ1R0JA020	M 1 OHM, J, 1/2W	1	
	R17115	D0GBR00J0004	M 0 OHM J 1/10W	1	

Model No. : TX-P46ST30E/J, PF46ST30 Parts List





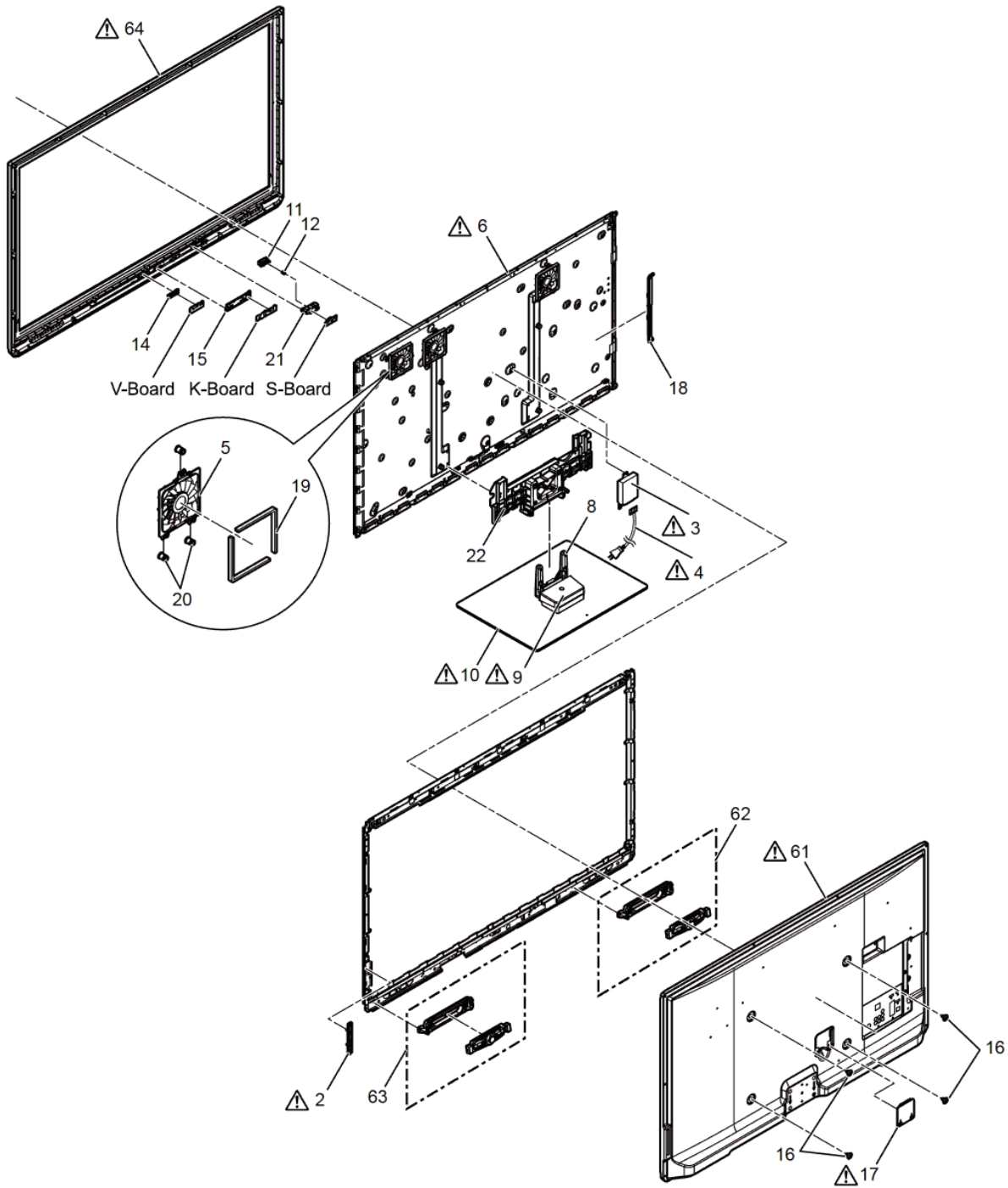

Safety	Ref. No.	Part No.	Part Name & Description	Q'ty	Remarks
	R17116	D0GBR00J0004	M 0 OHM J 1/10W	1	
	R17117	D0GF102JA047	M 1.0 KOHM,J,1/3W	1	
	R17118	D0GB101JA065	M 100 OHM,J,1/10W	1	
	R17119	D0GB101JA065	M 100 OHM,J,1/10W	1	
	R17120	D0GB101JA065	M 100 OHM,J,1/10W	1	
	R17121	D0GB101JA065	M 100 OHM,J,1/10W	1	
	R17122	D0GZ1R0JA020	M 1 OHM, J,1/2W	1	
	R17124	D0GZ1R0JA020	M 1 OHM, J,1/2W	1	
	R17126	D0GB101JA065	M 100 OHM,J,1/10W	1	
	R17127	D0GB101JA065	M 100 OHM,J,1/10W	1	
	R17128	D0GB101JA065	M 100 OHM,J,1/10W	1	
	R17129	D0GB101JA065	M 100 OHM,J,1/10W	1	
	R17130	D0GZ1R0JA020	M 1 OHM, J,1/2W	1	
	R17132	D0GZ1R0JA020	M 1 OHM, J,1/2W	1	
	R17134	D0GD224JA052	M 220KOHM,J,1/8W	1	PAVCCZ
	R17135	D0GB681JA065	M 680 OHM,J,1/10W	1	PAVCCZ
	R17138	EXB38V470J	M 47 OHM 1/16 W	1	
	R17139	EXB38V470J	M 47 OHM 1/16 W	1	
	R17140	EXB38V681J	M 680 OHM 1/16 W	1	
	R17141	D0GB681JA065	M 680 OHM,J,1/10W	1	PAVCCZ
	R17142	D0GF223JA047	M 22KOHM,J, 1/3W	1	PAVCCZ
	R17143	D0GB331JA065	M330 OHM J 1/10W	1	PAVCCZ
	R17144	D0GB102JA065	M 1KOHM,J,1/10W	1	
	R17145	D0GBR00J0004	M 0 OHM J 1/10W	1	
	R17146	D0GBR00J0004	M 0 OHM J 1/10W	1	
	R17196	D0GB102JA065	M 1KOHM,J,1/10W	1	
	R17201	D0GB101JA065	M 100 OHM,J,1/10W	1	
	R17202	D0GB101JA065	M 100 OHM,J,1/10W	1	
	R17203	D0GB101JA065	M 100 OHM,J,1/10W	1	
	R17204	D0GB101JA065	M 100 OHM,J,1/10W	1	
	R17205	D0GZ1R0JA020	M 1 OHM, J,1/2W	1	
	R17207	D0GZ1R0JA020	M 1 OHM, J,1/2W	1	
	R17209	D0GB101JA065	M 100 OHM,J,1/10W	1	
	R17210	D0GB101JA065	M 100 OHM,J,1/10W	1	
	R17211	D0GB101JA065	M 100 OHM,J,1/10W	1	
	R17212	D0GB101JA065	M 100 OHM,J,1/10W	1	
	R17213	D0GB101JA065	M 100 OHM,J,1/10W	1	
	R17214	D0GB101JA065	M 100 OHM,J,1/10W	1	
	R17215	D0GB101JA065	M 100 OHM,J,1/10W	1	
	R17216	D0GB101JA065	M 100 OHM,J,1/10W	1	
	R17217	D0GB101JA065	M 100 OHM,J,1/10W	1	
	R17218	D0GB101JA065	M 100 OHM,J,1/10W	1	
	R17219	D0GB101JA065	M 100 OHM,J,1/10W	1	
	R17220	D0GB101JA065	M 100 OHM,J,1/10W	1	
	R17221	D0GZ1R0JA020	M 1 OHM, J,1/2W	1	
	R17223	D0GZ1R0JA020	M 1 OHM, J,1/2W	1	
	R17225	D0GZ1R0JA020	M 1 OHM, J,1/2W	1	
	R17227	D0GZ1R0JA020	M 1 OHM, J,1/2W	1	
	R17229	D0GZ1R0JA020	M 1 OHM, J,1/2W	1	
	R17231	D0GZ1R0JA020	M 1 OHM, J,1/2W	1	
	R17233	D0GB681JA065	M 680 OHM,J,1/10W	1	PAVCCZ
	R17236	EXB38V470J	M 47 OHM 1/16 W	1	
	R17237	EXB38V470J	M 47 OHM 1/16 W	1	
	R17240	EXB38V681J	M 680 OHM 1/16 W	1	
	R17243	D0GD224JA052	M 220KOHM,J,1/8W	1	PAVCCZ
	R17244	D0GF102JA047	M 1.0 KOHM,J,1/3W	1	
	R17245	D0GB681JA065	M 680 OHM,J,1/10W	1	PAVCCZ
	R17246	D0GF223JA047	M 22KOHM,J, 1/3W	1	PAVCCZ
	R17247	D0GB331JA065	M330 OHM J 1/10W	1	PAVCCZ
	R17248	D0GB102JA065	M 1KOHM,J,1/10W	1	
	SC2	K1KY02B00012	2P CONNECTOR	1	

Model No. : TX-P46ST30E/J, PF46ST30 Parts List

Safety	Ref. No.	Part No.	Part Name & Description	Q'ty	Remarks
	SC20	K1MY35BA0345	35P CONNECTOR	1	
	SC41	K1KA09AA0707	9P CONNECTOR	1	
	SC42	K1KA09AA0707	9P CONNECTOR	1	
	SC46	K1KA09AA0707	9P CONNECTOR	1	
	SC50	K1KA02AA0193	2P CONNECTOR	1	
	SS11	K1KY03B00006	3P CONNECTOR	1	
	SS33	K1MY20BA0345	20P CONNECTOR	1	
	SS61	K1MY13BA0343	13P CONNECTOR	1	
	SS66	K1MY13BA0443	13P CONNECTOR	1	PAVCCZ
	T16471	G4DYA0000324	SWITCHING TRANS	1	PAVCCZ
	T16472	G4DYA0000325	SWITCHING TRANS	1	PAVCCZ
	ZA16001	K4AZ01D00004	TERMINAL	1	
	ZA16002	K4AZ01D00004	TERMINAL	1	
	ZA16011	K4AZ01D00004	TERMINAL	1	
	ZA16012	K4AZ01D00004	TERMINAL	1	
	ZA16101	K4AD01Z00003	TERMINAL	1	
	ZA16102	K4AD01Z00003	TERMINAL	1	
	ZA16106	K4AD01Z00003	TERMINAL	1	
	ZA16111	K4AA04D00002	TERMINAL	1	PAVCCZ
	ZA16112	K4AA04D00002	TERMINAL	1	PAVCCZ
	ZA16116	K4AA04D00002	TERMINAL	1	PAVCCZ
	ZA16402	K4AZ01D00004	TERMINAL	1	
	ZA16403	K4AZ01D00004	TERMINAL	1	
	ZA16411	K4AA04D00002	TERMINAL	1	PAVCCZ
	ZA16412	K4AA04D00002	TERMINAL	1	PAVCCZ
	ZA16421	K4AA04D00002	TERMINAL	1	PAVCCZ
	ZA16422	K4AA04D00002	TERMINAL	1	PAVCCZ
	ZA17101	K4CD01000013	AV TERMINAL	1	
	ZA17102	K4CD01000013	AV TERMINAL	1	
	ZA17103	K4CD01000013	AV TERMINAL	1	
	ZA17104	K4CD01000013	AV TERMINAL	1	
	ZA17201	K4CD01000013	AV TERMINAL	1	
	ZA17202	K4CD01000013	AV TERMINAL	1	
	ZA17203	K4CD01000013	AV TERMINAL	1	
	ZA17204	K4CD01000013	AV TERMINAL	1	

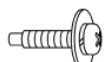
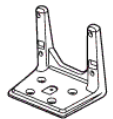
Model No. : TX-P46ST30E/J, PF46ST30 Exploded View 1

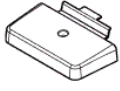

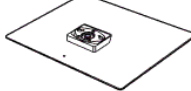
<p>Assembly screws</p> <p>72  M5 × 20 (silver) (4)</p> <p>71  M4 × 8 (black) (4)</p>	<p>13  M5 × 25 (black) (4)</p>	<p>8 Stand pole (1) </p>	<p> 9 Pole cover (1) </p>	<p> 10 Base (1) </p>
---	---	---	--	--



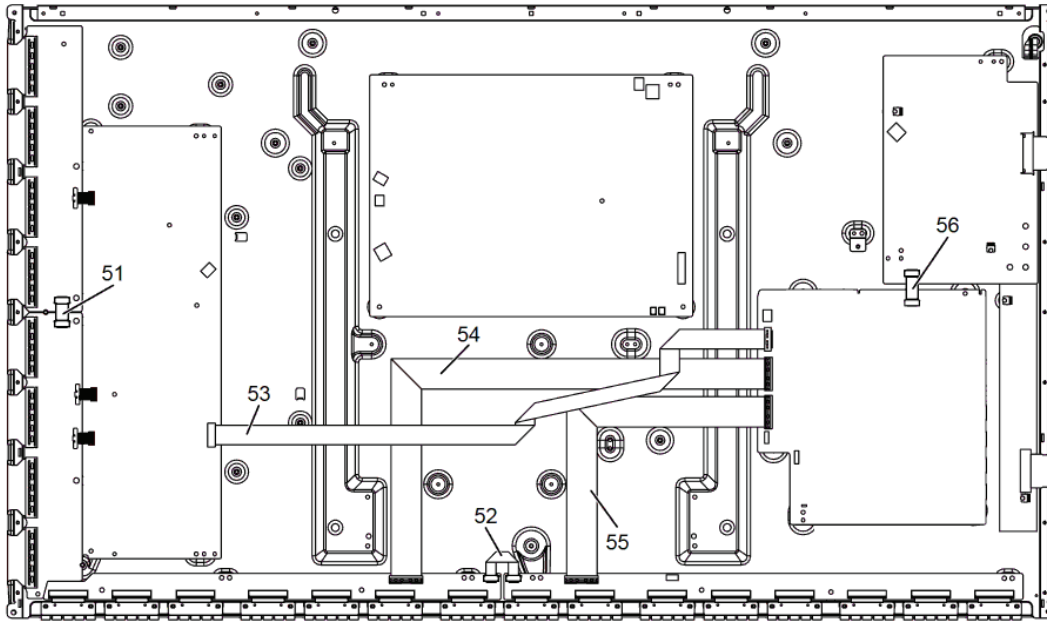

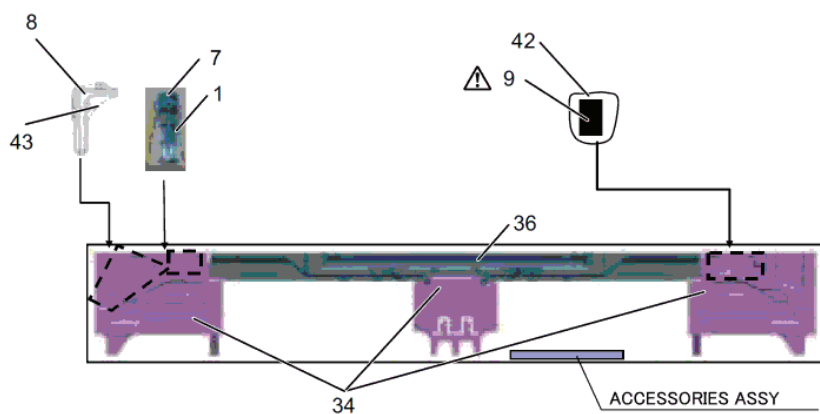
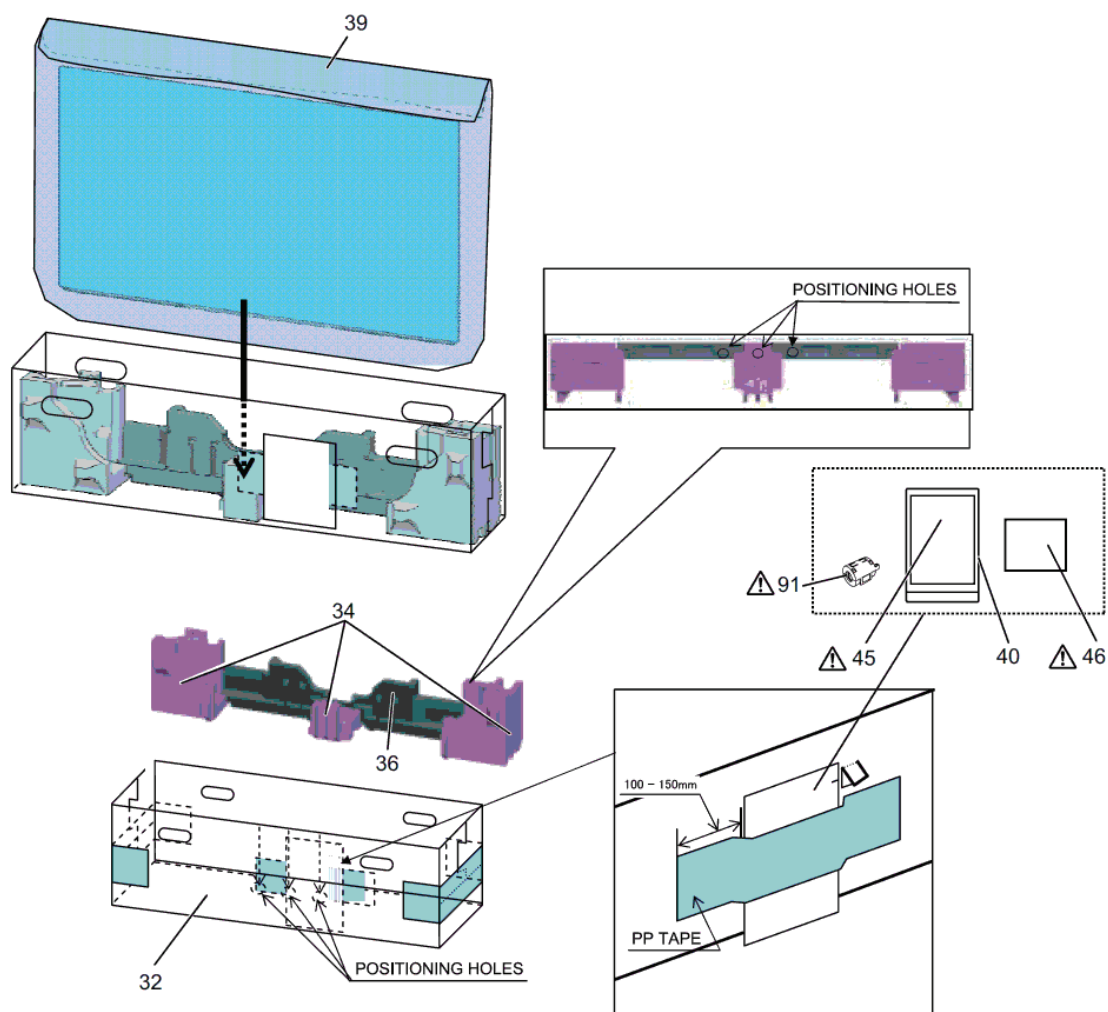

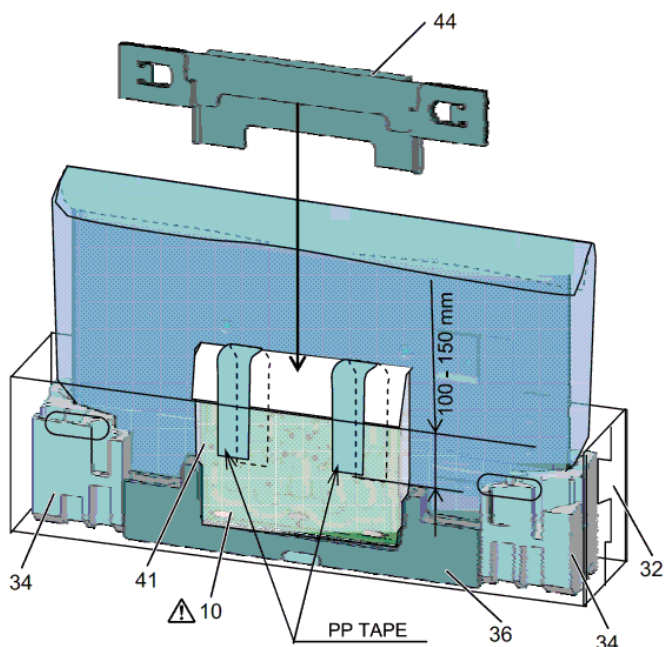
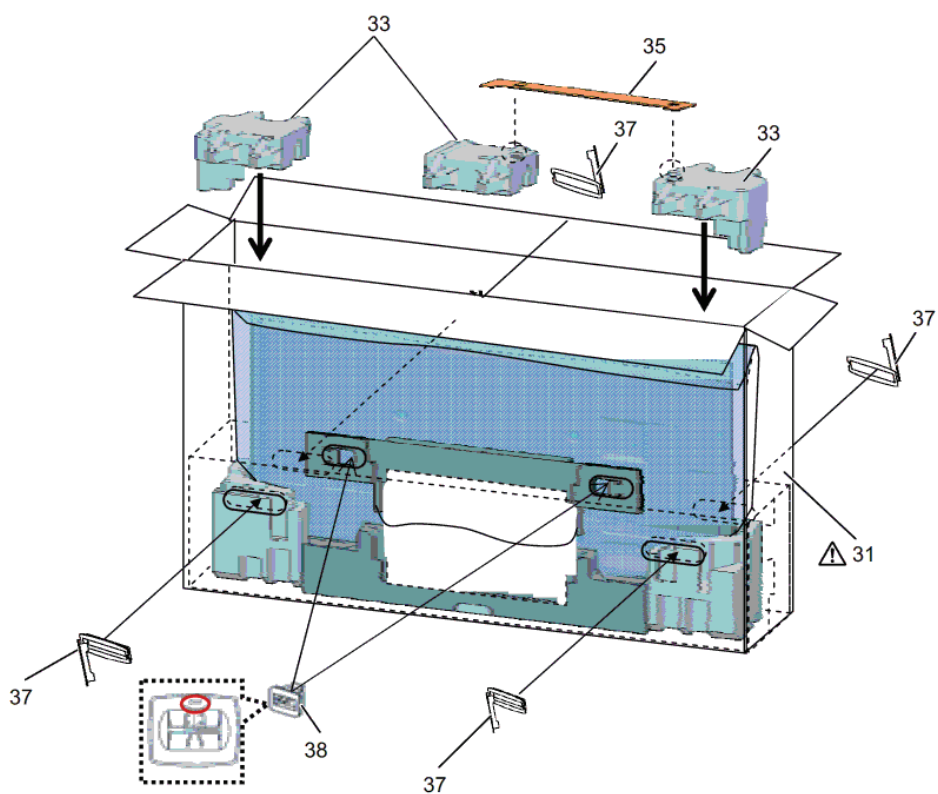









Model No. : TX-P46ST30E/J, PF46ST30 Exploded View 2







Model No. : TX-P46ST30E/J, PF46ST30 Parts List

Safety	Ref. No.	Part No.	Part Name & Description	Q'ty	Remarks
	1	BAT-C-0572	Battery Cover of RC	1	PAVCCZ
	91	JOKG00000146	FERRITE CORE PACK	1	
	2	KORB00500039	SIDE UNIT ASSY	1	PAVCCZ
	3	K2AZYH000023	AC-INLET WITH CABLE	1	PAVCCZ
	4	K2CN3YY00011	AC CORD	1	PAVCCZ P46ST30E, PF46ST30
	4	K2CS3YY00015	AC CORD	1	PAVCCZ P46ST30J
	5	L6FAYYYH0111	FAN	3	
	6	MD46F14A4J	PLASMA DISPLAY PANEL	1	
	7	N2QAYB000572	REMOTE CONTROL	1	PAVCCZ
	8	TBL5ZA3065	STAND POLE	1	
	9	TBL5ZB3054-1	POLE COVER	1	PAVCCZ
	10	TBL5ZX0069	PEDESTAL STAND	1	PAVCCZ
	11	TXA57003	POWER BUTTON	1	
	12	TESD101	SPRING	1	
		THEJ036J	SCREW(CONTACT_METAL_A-B:7)	7	
		THEJ036J	SCREW(SS:6 SC:7 SUS:3 PSM:1)	17	
		THEJ036J	SCREW(C:8)	8	
		THEJ039J	SCREW	9	
		THEJ0409	SCREW	13	chap.3.1. (3)
		THEL0239	SCREW(A-PRINT:4)	4	
		THEL0239	SCREW(DD:15)	15	
		THEL052Z	SCREW	17	chap.3.1. (1)
	13	THEL088N	SCREW M5x25	4	
		THTD030J	SCREW(BC:10)	10	PAVCCZ chap.3.1. (2)
	14	TKKC5412-1	3D EMITTER PANEL	1	
	15	TKKC5413	LED PANEL	1	PAVCCZ
	16	TKKL5493	M8 CAP	4	chap.3.1. (5)
	17	TKPOE48801-1	INLET COVER	1	PAVCCZ
	18	TKPOE49101	SIDE TERMINAL COVER	1	PAVCCZ
	19	TMKH292	FAN SPONGE	6	
		TMME292	CLAMPER(P2:2)	2	
		TMME292	CLAMPER	6	
		TMME332	STAND BRACKET:9 AC-INLET:1 INLET-METAL:1	11	
		TMME332	CLAMPER	5	
		TMME351	CLAMPER	4	
		TMME332	CLAMPER(CONTACT METAL BOT:1)	1	
		TMME397	SPACER	3	PAVCCZ
		TMME409	SPACER	4	PAVCCZ
	20	TMMJ117	RUBBER CUSHION	9	
	21	TMWC038	POWER BUTTON BRACKET	1	PAVCCZ
	22	TMZ0E9927-1	STAND BRACKET	1	PAVCCZ
	31	TPC0EA04501	CARTON BOX TOP	1	PAVCCZ
	32	TPC0EA04601	CARTON BOX BOTTOM	1	PAVCCZ
	33	TPD0E1154	TOP CUSHION	1	PAVCCZ
	34	TPD0E2160	BOTTOM CUSHION	1	PAVCCZ
	35	TPD0E9184	TOP PAD	1	PAVCCZ
	36	TPD0E9187	PEDESTAL CUSHION	1	PAVCCZ
	37	TPD169487	JOINT	4	
	38	TPDX0016-1	JOINT FOR PEDESTAL	2	
	39	TPE0E4010	PROTECT COVER	1	PAVCCZ
	40	TPE0E9008	BAG (INSTRUCTION BOOK)	1	PAVCCZ
	41	TPEB494	BAG (PEDESTAL STAND)	1	
	42	TPEB497	BAG (POLE COVER)	1	
	43	TPEB515	BAG (STAND POLE)	1	PAVCCZ
		TPG0E9700	PAPER CAP	0.25	PAVCCZ
	44	TPG0E9710	PEDESTAL PAD	1	PAVCCZ
	45	TQB0E2075A	INSTRUCTION BOOK(GERMAN)	1	PAVCCZ P46ST30E
	45	TQB0E2075B	INSTRUCTION BOOK(DUTCH)	1	PAVCCZ P46ST30E
	45	TQB0E2075C	INSTRUCTION BOOK(ITALIAN)	1	PAVCCZ P46ST30E
	45	TQB0E2075D	INSTRUCTION BOOK(FRENCH)	1	PAVCCZ P46ST30E
	45	TQB0E2075E	INSTRUCTION BOOK(SPANISH)	1	PAVCCZ P46ST30E
	45	TQB0E2075F	INSTRUCTION BOOK(SWEDISH)	1	PAVCCZ P46ST30E

Model No. : TX-P46ST30E/J, PF46ST30 Parts List

Safety	Ref. No.	Part No.	Part Name & Description	Q'ty	Remarks
⚠	45	TQB0E2075G	INSTRUCTION BOOK (NORWEGIAN)	1	PAVCCZ P46ST30E
⚠	45	TQB0E2075H	INSTRUCTION BOOK (FINNISH)	1	PAVCCZ P46ST30E
⚠	45	TQB0E2075I	INSTRUCTION BOOK (LITHUANIAN)	1	PAVCCZ P46ST30E
⚠	45	TQB0E2075J	INSTRUCTION BOOK (PORTUGUESE)	1	PAVCCZ P46ST30E
⚠	45	TQB0E2075K	INSTRUCTION BOOK (DANISH)	1	PAVCCZ P46ST30E
⚠	45	TQB0E2075M	INSTRUCTION BOOK (BULGARIAN)	1	PAVCCZ P46ST30E
⚠	45	TQB0E2075N	INSTRUCTION BOOK (ROMANIAN)	1	PAVCCZ P46ST30E
⚠	45	TQB0E2075O	INSTRUCTION BOOK (LATVIAN)	1	PAVCCZ P46ST30E
⚠	45	TQB0E2075P	INSTRUCTION BOOK (POLISH)	1	PAVCCZ P46ST30E
⚠	45	TQB0E2075Q	INSTRUCTION BOOK (HUNGARIAN)	1	PAVCCZ P46ST30E
⚠	45	TQB0E2075R	INSTRUCTION BOOK (CZECH)	1	PAVCCZ P46ST30E
⚠	45	TQB0E2075S	INSTRUCTION BOOK (GREEK)	1	PAVCCZ P46ST30E
⚠	45	TQB0E2075T	INSTRUCTION BOOK (TURKISH)	1	PAVCCZ P46ST30E
⚠	45	TQB0E2075U	INSTRUCTION BOOK (ENGLISH)	1	PAVCCZ P46ST30E
⚠	45	TQB0E2075V	INSTRUCTION BOOK (CROATIAN)	1	PAVCCZ P46ST30E
⚠	45	TQB0E2075W	INSTRUCTION BOOK (SLOVAKIAN)	1	PAVCCZ P46ST30E
⚠	45	TQB0E2075Z	INSTRUCTION BOOK (ESTONIAN)	1	PAVCCZ P46ST30E
⚠	45	TQB0E2079A	INSTRUCTION BOOK (GERMAN)	1	PAVCCZ P46ST30J
⚠	45	TQB0E2079C	INSTRUCTION BOOK (ITALIAN)	1	PAVCCZ P46ST30J
⚠	45	TQB0E2079D	INSTRUCTION BOOK (FRENCH)	1	PAVCCZ P46ST30J
⚠	45	TQB0E2077D	INSTRUCTION BOOK (FRENCH)	1	PAVCCZ PF46ST30
⚠	45	TQB0E2077U	INSTRUCTION BOOK (ENGLISH)	1	PAVCCZ PF46ST30
⚠	46	TQB0E2075X	INSTRUCTION BOOK (CD-ROM)	1	PAVCCZ P46ST30E
		TQZJ350	SCREW USE HANDBILE	1	
	51	TSXM217	CABLE (SU11-SD11)	1	
	52	TSXM237-1	CABLE (C10-C20)	1	
	53	TSXM307-1	CABLE (A20-SC20)	1	PAVCCZ
	54	TSXM308	CABLE (A31-C11)	1	PAVCCZ
	55	TSXM309	CABLE (A32-C21)	1	PAVCCZ
	56	TSXM326	CABLE (A40-SS33)	1	PAVCCZ
⚠	61	TTU0E0872	REAR COVER	1	PAVCCZ P46ST30E
⚠	61	TTU0E0877	REAR COVER	1	PAVCCZ P46ST30J
⚠	61	TTU0E0874	REAR COVER	1	PAVCCZ PF46ST30
	62	TXFEA01RAUE	SPEAKER L ASSY	1	PAVCCZ
	63	TXFEA02RAUE	SPEAKER R ASSY	1	PAVCCZ
⚠	64	TXFKY01QYUE	CABINET ASSY	1	PAVCCZ
		TXJA11QYUE	SPEAKER LEAD (A11-SPL/SPR)	1	PAVCCZ
	71	XSB4+8FNK	SCREW M4x8	1	
		XTB4+12GFJ	SCREW (CAB-CON_MET:TOP3 SIDE4 BOT5 PW:2)	14	
		XTV3+10JFJK	SCREW (REAR AV:2)	2	chap.3.1. (4)
		XTV3+8GFJ	SCREW (LED:2)	2	
		XYN3+J10FJK	SCREW	2	
		XYN4+E6FJ	SCREW (INLET:1)	1	
		XYN4+F8FJ	SCREW (SC-SUSD:4 SS-SS2:3)	7	
	72	XYN5+F20FN	SCREW M5x20 SILVER	4	
		XZB6X12B03	POLY BAG (SCREW)	1	