

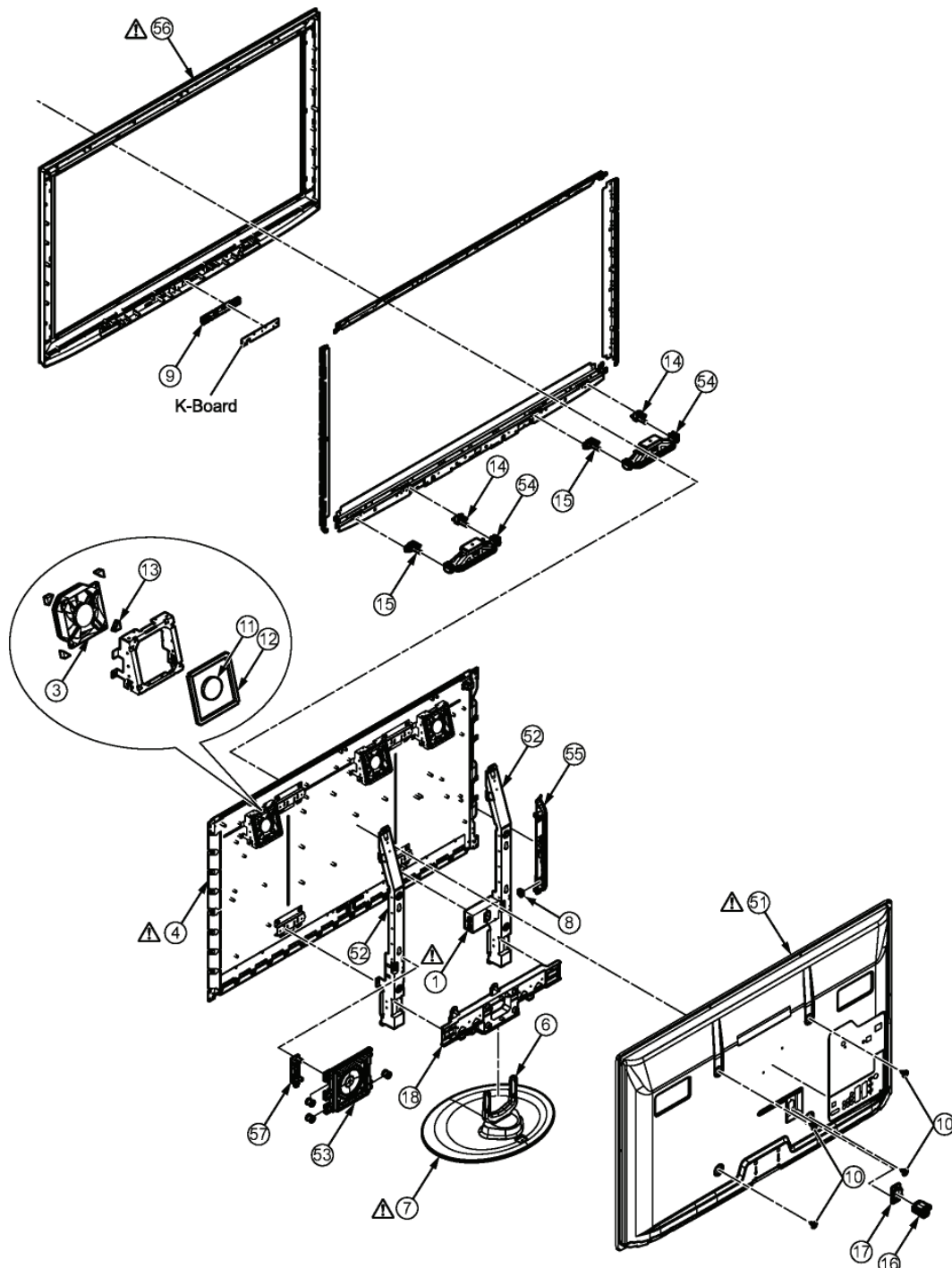



15 Exploded View and Replacement Parts List

15.1. Exploded View and Mechanical Replacement Parts List

15.1.1. Exploded View 1

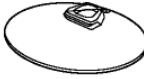

⑧2 Assembly screw (3) (silver)  M5 x 18	⑧1 Assembly screw (4) (black)  M5 x 30	⑥ Pole 	⑦ Base 
--	---	--	---

15.1.2. Exploded View 2

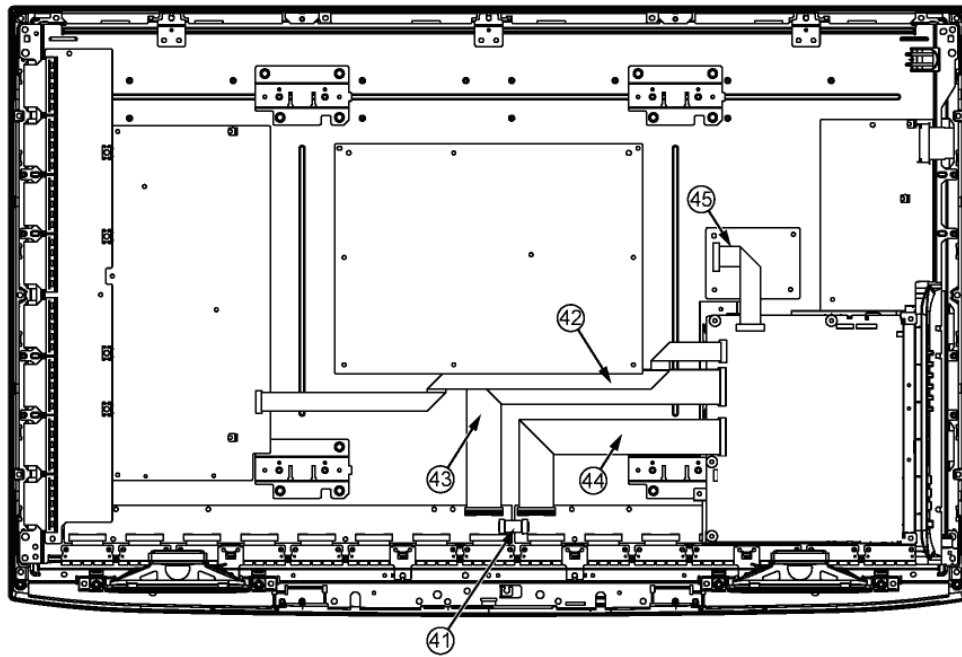



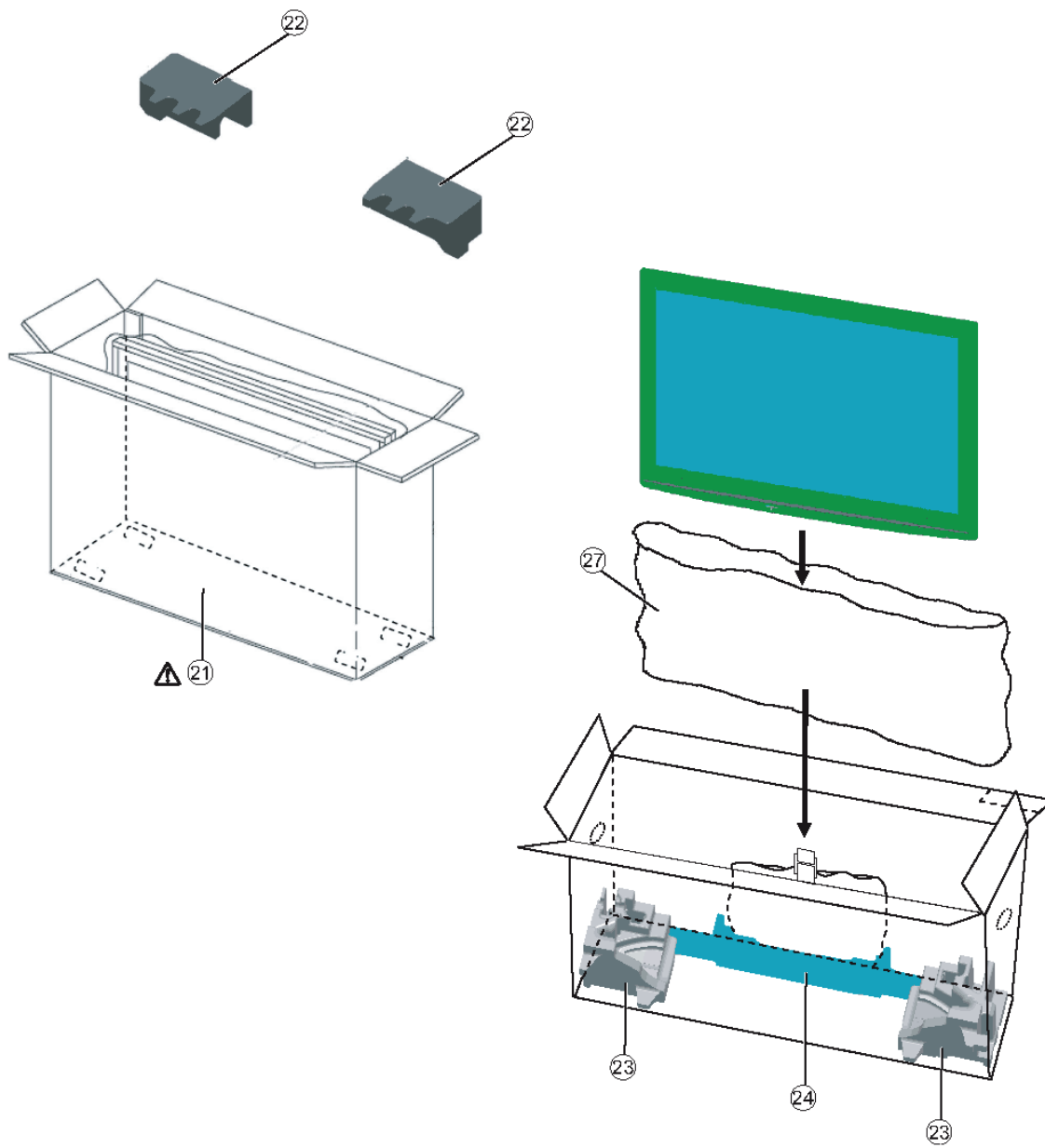



























15.1.4. Packing 2



15.1.5. Mechanical Replacement Parts List

Note: All parts except parts mentioned [PAVCCZ] in the Remarks column are supplied by AVC-CSPC.
Parts mentioned [PAVCCZ] are supplied by PAVCCZ.

Safety	Ref. No.	Part No.	Part Name & Description	Q'ty	Remarks
	61	J0KG00000146	FERRITE CORE PACK	1	
	1	K2AHYH000033	AC INLET WITH CABLE	1	PAVCCZ
	2	K2CN3YY00006	AC CORD	1	PAVCCZ
	3	L6FAYYYH0091	FAN (80MM-T15)	3	
	4	MD42F13C9Z	PLASMA DISPLAY PANEL	1	PAVCCZ
	5	N2QAYB000504	REMOTE CONTROL	1	PAVCCZ
	6	TBLA3828	STAND POLE	1	
	7	TBLX0151	PEDESTAL STAND (ROUND TITANIUM)	1	PAVCCZ
	8	TBX3EA00401	POWER BUTTON	1	
		THEC127N	SCREW (WOOFER)	2	
		THEJ0339	SCREW (TU:1 SIDE_COVER:4 2ND-TU:1 LAN:1)	7	
		THEL049	SCREW (WOOFER_SP)	2	
		THEL052Z	SCREW (BC TOP:4)	4	
	81	THEL080N	SCREW (M5x30)	4	
		THTA058N	SCREW	2	PAVCCZ
		THTD020J	SCREW (A-PRINT:4)	9	
		THTF011N	SCREW	79	
	9	TKKC5395	LED PANEL	1	
	10	TKKL5493	M8 CAP	4	
	11	TMKG896	SPONGE (FAN CENTER)	3	
	12	TMKG999	SPONGE	3	
		TMM23417	CLAMPER	3	
		TMME224	CLAMPER	3	
		TMME272	CLAMPER (AL:2)	2	
		TMME289	CLAMPER	1	
		TMME292	CLAMPER	1	
		TMME292	CLAMPER	2	
		TMME332	CLAMPER (HANGER:2 FAN:3)	5	
		TMME332	CLAMPER (SS:1)	1	
	13	TMMJ102	RUBBER (FAN CORNER)	12	
	14	TMW0E912	SP BRACKET L	2	PAVCCZ
	15	TMW0E913	SP BRACKET R	2	PAVCCZ
	16	TMXX064	AC CORD CLAMPER A	1	
	17	TMXX065	AC CORD CLAMPER B	1	
	18	TMZ0E9921	ONE LEG BRACKET	1	PAVCCZ
	21	TPC0E65405	CARTON BOX	1	PAVCCZ
	22	TPD0E1127	TOP CUSHION	1	PAVCCZ
	23	TPD0E2126	BOTTOM CUSHION	1	PAVCCZ
	24	TPD0E2127-1	PEDESTAL CUSHION	1	PAVCCZ
	25	TPD0E9176	JOINT PAD	1	PAVCCZ
	26	TPDX0016-1	JOINT FOR PEDESTAL	1	
	27	TPE0E4047	SET BAG	1	PAVCCZ
	28	TPE0E9002	ACCESSORIES BAG	1	PAVCCZ

Safety	Ref. No.	Part No.	Part Name & Description	Q'ty	Remarks
	29	TPE0E9003	BAG FOR AC CORD	1	PAVCCZ
	30	TPEB449	BAG (STAND ACCESSORY)	1	PAVCCZ
	31	TPEB455	BAG (PEDESTAL STAND)	1	
		TPG0E9311	PAPER CAP	0.25	PAVCCZ
	32	TQB0E0943A	INSTRUCTION BOOK (GERMAN)	1	PAVCCZ
	32	TQB0E0943B	INSTRUCTION BOOK (DUTCH)	1	PAVCCZ
	32	TQB0E0943C	INSTRUCTION BOOK (ITALIAN)	1	PAVCCZ
	32	TQB0E0943D	INSTRUCTION BOOK (FRENCH)	1	PAVCCZ
	32	TQB0E0943E	INSTRUCTION BOOK (SPANISH)	1	PAVCCZ
	32	TQB0E0943F	INSTRUCTION BOOK (SWEDISH)	1	PAVCCZ
	32	TQB0E0943G	INSTRUCTION BOOK (NORWEGIAN)	1	PAVCCZ
	32	TQB0E0943H	INSTRUCTION BOOK (FINNISH)	1	PAVCCZ
	32	TQB0E0943I	INSTRUCTION BOOK (LITHUANIAN)	1	PAVCCZ
	32	TQB0E0943J	INSTRUCTION BOOK (PORTUGUESE)	1	PAVCCZ
	32	TQB0E0943K	INSTRUCTION BOOK (DANISH)	1	PAVCCZ
	32	TQB0E0943M	INSTRUCTION BOOK (BULGARIAN)	1	PAVCCZ
	32	TQB0E0943N	INSTRUCTION BOOK (ROMANIAN)	1	PAVCCZ
	32	TQB0E0943O	INSTRUCTION BOOK (LATVIAN)	1	PAVCCZ
	32	TQB0E0943P	INSTRUCTION BOOK (POLISH)	1	PAVCCZ
	32	TQB0E0943Q	INSTRUCTION BOOK (HUNGARIAN)	1	PAVCCZ
	32	TQB0E0943R	INSTRUCTION BOOK (CZECH)	1	PAVCCZ
	32	TQB0E0943S	INSTRUCTION BOOK (GREEK)	1	PAVCCZ
	32	TQB0E0943T	INSTRUCTION BOOK (TURKISH)	1	PAVCCZ
	32	TQB0E0943U	INSTRUCTION BOOK (ENGLISH)	1	PAVCCZ
	32	TQB0E0943W	INSTRUCTION BOOK (SLOVAKIAN)	1	PAVCCZ
	32	TQB0E0943Z	INSTRUCTION BOOK (ESTONIAN)	1	PAVCCZ
	33	TQB0E0943X	INSTRUCTION BOOK (CD-ROM)	1	PAVCCZ
		TQZJ206	SCREW USE HANDBILL	1	
	41	TSXL519	CABLE (C10-C20)	1	
	42	TSXM017-1	CABLE (A20-SC20)	1	PAVCCZ
	43	TSXM018	CABLE (C11-A31)	1	PAVCCZ
	44	TSXM019	CABLE (C21-A32)	1	PAVCCZ
	45	TSXM026	CABLE (XS3-A88A)	1	PAVCCZ
	51	TTU0E0760	REAR COVER	1	PAVCCZ
	52	TUX0E173	42HANGER METAL	2	PAVCCZ
		TXFBL02LGUU	SCREW ASSY	1	PAVCCZ
	53	TXFEA01LBUE	SPEAKER WOOFER ASSY	1	PAVCCZ
	54	TXFEA01LJUE	SPEAKER ASSY	2	PAVCCZ
	55	TXFKP01LJUE	SIDE TERMINAL COVER ASSY	1	PAVCCZ
	56	TXFKY01LVUE	CABINET ASSY	1	PAVCCZ
	57	TXFMW01LVUE	WOOFER BRACKET ASSY	1	PAVCCZ
		TXJA11LJUE	SPEAKER LEAD (A11-SPL/SPR)	1	PAVCCZ
		TXJA12LVUE	SPEAKER LEAD (A12-WOOFER)	1	PAVCCZ

Safety	Ref. No.	Part No.	Part Name & Description	Q'ty	Remarks
		XSB3+6FJ	SCREW (HDMI:3)	5	
		XSB4+8FNK	SCREW M4x8 Black	2	
		XTB4+12GFJ	SCREW (GH:20 PW:2 LED:1)	27	
		XTB4+12GFJK	SCREW (BC:11)	10	
		XTS4+10GFN	COUNTERSUNK SCREW ST4x10 Silver	11	PAVCCZ
		XTV3+10JFJK	SCREW (REAR AV:2)	2	
		XTV3+6GFJ	SCREW	6	
		XTV3+8JFJ	SCREW	6	
		XTWT4+Z15DFJ	SCREW (SP BOX)	1	
		XYN3+F10FJK	SCREW (BC-AC_INLET:2)	2	
		XYN3+J10FJ	SCREW	29	
		XYN4+E6FJ	SCREW (INLET:1)	1	
		XYN4+F10FJ	SCREW (AL-GHT:4)	24	
	82	XYN5+F18FN	SCREW M5x18 Silver	3	
		XYN5+F18FN	SCREW (M5x18)	3	
		XZB7.5X9C05	BAG (SCREW)	1	PAVCCZ
		XZBT6506	POLY BAG (INSTRUCTION BOOK)	1	
	71	C5ZZZ0000049	Wi-LAN MODULE (DONGLE)	1	PAVCSK
	72	K2KYYYY00064	USB CABLE	1	PAVCSK

15.2.2. Electrical Replacement Parts List

Note: All parts except parts mentioned [PAVCCZ] in the Remarks column are supplied by AVC-CSPC.
Parts mentioned [PAVCCZ] are supplied by PAVCCZ.

Safety	Ref. No.	Part No.	Part Name & Description	Pcs	Remarks
△	PCB	LSEP1290VEHB	CIRCUIT BOARD P	1	(RTL) PA VCCZ
△	PCB	A-P42V20E	CIRCUIT BOARD A	1	(RTL) PA VCCZ
△	PCB	TXNXS1LQUE	CIRCUIT BOARD XS	1	(RTL) PA VCCZ
△	PCB	TXN/K1LVUE	CIRCUIT BOARD K	1	(RTL) PA VCCZ
△	PCB	TNPA5094	CIRCUIT BOARD C1	1	(RTL)
△	PCB	TNPA5095	CIRCUIT BOARD C2	1	(RTL)
△	PCB	TXNSC11NEK	CIRCUIT BOARD SC	1	(RTL) PA VCCZ
△	PCB	TNPA5086	CIRCUIT BOARD SM	1	
△	PCB	TXNSS11NEK	CIRCUIT BOARD SS	1	(RTL) PA VCCZ
△	PCB	TNPA4802	CIRCUIT BOARD SS2	1	(RTL)
	A1	K1KA11B00092	11P CONNECTOR	1	
	A6	K1KA11BA0107	11P CONNECTOR	1	
	A7	K1KY14AA0719	14P CONNECTOR	1	
	A8	K1KY12AA0719	12P CONNECTOR	1	
	A11	K1KA04AA0728	4P CONNECTOR	1	
	A12	K1KA02AA0728	2P CONNECTOR	1	
	A20	K1MY35BA0345	35P CONNECTOR	1	
	A31	K1MY68BA0345	68P CONNECTOR	1	
	A32	K1MY68BA0345	68P CONNECTOR	1	
	A88A	K1KY30AA0369	30P CONNECTOR	1	
	C1009	FIG1C104A116	C 0.1UF 16V	1	
	C1010	FLJ1E105A231	C 1 UF 25V	1	
	C1102	FLJ1A106A087	C 10UF, 10V	1	
	C1103	FIG1C104A116	C 0.1UF 16V	1	
	C1104	FIG1C104A116	C 0.1UF 16V	1	
	C1106	F1H1H270A971	C 27PF, 50V	1	
	C1107	FIG1H220A731	C 22PF, 50V	1	
	C1108	FIG1C104A116	C 0.1UF 16V	1	
	C1109	ECJ1VB1A105K	C 1UF, 10V	1	
	C1111	ECJ1VB1A105K	C 1UF, 10V	1	
	C1112	FIG1C104A116	C 0.1UF 16V	1	
	C1114	FIG1C104A116	C 0.1UF 16V	1	
	C1117	FIG1C104A116	C 0.1UF 16V	1	
	C1122	FIG1E103A123	C 0.01UF 25V	1	
	C1123	ECJ1VB1A105K	C 1UF, 10V	1	
	C2055	FLJ1A106A087	C 10UF, 10V	1	
	C2057	FLJ1A106A087	C 10UF, 10V	1	
	C2067	FIG1C103A116	C 0.01UF 16V	1	
	C2068	FIG1C103A116	C 0.01UF 16V	1	
	C2069	FIG1C103A116	C 0.01UF 16V	1	
	C2070	FIG1C103A116	C 0.01UF 16V	1	
	C2071	EEHBOJ101UR	E 100UF, 6.3V	1	
	C2072	EEHBOJ101UR	E 100UF, 6.3V	1	
	C2073	FIG1E333A091	C 0.033UF 25V	1	
	C2074	FIG1E333A091	C 0.033UF 25V	1	
	C2075	FIG1C104A116	C 0.1UF 16V	1	
	C2076	FIG1C104A116	C 0.1UF 16V	1	
	C2077	FIG1C104A116	C 0.1UF 16V	1	
	C2078	FIG1A105A047	C 1UF 10V	1	
	C2079	FIG1C103A116	C 0.01UF 16V	1	
	C2104	FIG1H100A731	C 10PF 50V	1	
	C2107	FIG1A105A047	C 1UF 10V	1	
	C2108	FIG1A105A047	C 1UF 10V	1	
	C2110	FIG1C104A116	C 0.1UF 16V	1	
	C2301	FIG1C104A116	C 0.1UF 16V	1	
	C2302	FIG1C104A116	C 0.1UF 16V	1	
	C2303	FK1E106A136	C 10UF, 25V	1	
	C2304	FLJ1E105A231	C 1 UF 25V	1	
	C2305	FIG1H102A730	C 1000PF 50V	1	
	C2306	FLJ1E105A231	C 1 UF 25V	1	
	C2307	FLJ1E105A231	C 1 UF 25V	1	
	C2308	FLJ1E105A231	C 1 UF 25V	1	
	C2311	FK1E106A136	C 10UF, 25V	1	
	C2313	FIG1H102A730	C 1000PF 50V	1	
	C2314	FLJ1E105A231	C 1 UF 25V	1	
	C2315	FK1E106A136	C 10UF, 25V	1	
	C2316	F1H1H104A970	C 0.1PF, , 50V	1	
	C2317	FLJ1E105A231	C 1 UF 25V	1	
	C2318	F1H1H104A970	C 0.1PF, , 50V	1	
	C2319	FK1E106A136	C 10UF, 25V	1	
	C2320	FLJ1E105A231	C 1 UF 25V	1	
	C2321	F1H1H104A970	C 0.1PF, , 50V	1	
	C2322	FK1E106A136	C 10UF, 25V	1	
	C2323	F1H1H104A970	C 0.1PF, , 50V	1	
	C2324	FLJ1E105A231	C 1 UF 25V	1	
	C2325	FIG1H102A730	C 1000PF 50V	1	
	C2334	FLJ1H474A757	C 0.47UF, 50V	1	
	C2335	F1H1E104A129	C 0.1PF, 25V	1	
	C2336	F1H1E104A129	C 0.1PF, 25V	1	
	C2337	FLJ1H474A757	C 0.47UF, 50V	1	
	C2338	F1H1E104A129	C 0.1PF, 25V	1	
	C2339	F1H1E104A129	C 0.1PF, 25V	1	
	C2340	F1H1H223A970	C 0.022PF, 50V	1	
	C2341	F1H1H223A970	C 0.022PF, 50V	1	
	C2342	F1H1H223A970	C 0.022PF, 50V	1	
	C2343	F1H1H223A970	C 0.022PF, 50V	1	
	C2344	F1H1H223A970	C 0.022PF, 50V	1	
	C2345	F1H1H223A970	C 0.022PF, 50V	1	
	C2346	F1H1H223A970	C 0.022PF, 50V	1	
	C2347	F1H1H223A970	C 0.022PF, 50V	1	
	C2349	FIG1H102A730	C 1000PF 50V	1	
	C2351	FIG1H102A730	C 1000PF 50V	1	
	C2353	FIG1H102A730	C 1000PF 50V	1	
	C2355	FIG1H102A730	C 1000PF 50V	1	
	C2411	FK1E106A136	C 10UF, 25V	1	
	C2413	FIG1H102A730	C 1000PF 50V	1	
	C2414	FLJ1E105A231	C 1 UF 25V	1	
	C2415	FK1E106A136	C 10UF, 25V	1	
	C2416	F1H1H104A970	C 0.1PF, , 50V	1	
	C2417	FLJ1E105A231	C 1 UF 25V	1	
	C2418	F1H1H104A970	C 0.1PF, , 50V	1	
	C2420	FLJ1E105A231	C 1 UF 25V	1	
	C2421	F1H1H104A970	C 0.1PF, , 50V	1	
	C2423	F1H1H104A970	C 0.1PF, , 50V	1	
	C2424	FLJ1E105A231	C 1 UF 25V	1	
	C2434	FLJ1H474A757	C 0.47UF, 50V	1	
	C2435	F1H1E104A129	C 0.1PF, 25V	1	
	C2436	F1H1E104A129	C 0.1PF, 25V	1	
	C2440	F1H1H223A970	C 0.022PF, 50V	1	
	C2441	F1H1H223A970	C 0.022PF, 50V	1	
	C2442	F1H1H223A970	C 0.022PF, 50V	1	
	C2443	F1H1H223A970	C 0.022PF, 50V	1	
	C2449	FIG1H102A730	C 1000PF 50V	1	
	C2451	FIG1H102A730	C 1000PF 50V	1	
	C2510	F1H1H103A970	C 0.01PF, 50V	1	
	C2511	FLJ1A106A087	C 10UF, 10V	1	
	C2515	F1H1H103A970	C 0.01PF, 50V	1	
	C2521	F1H1C104A143	C 0.1UF, 16V	1	
	C2752	FIG1E103A123	C 0.01UF 25V	1	

Safety	Ref. No.	Part No.	Part Name & Description	Pcs	Remarks
	C2753	F1G1A105A047	C 1UF 10V	1	
	C2756	F1K1E106A136	C 10UF, 25V	1	
	C2757	F1G1E103A123	C 0.01UF 25V	1	
	C2758	F2H1E470A007	E 47UF, 25V	1	
	C2759	F1J1E105A231	C 1 UF 25V	1	
	C2760	F2G1C100A022	E 10UF J 16V	1	
	C2780	ECJ1VB1A105K	C 1UF, 10V	1	
	C2781	F1G1C104A116	C 0.1UF 16V	1	
	C2782	F1G1C104A116	C 0.1UF 16V	1	
	C2783	F1G1C104A116	C 0.1UF 16V	1	
	C2784	F1G1C104A116	C 0.1UF 16V	1	
	C2801	F1K1C106A126	C 10UF, 16V	1	
	C2802	F1H1E104A129	C 0.1PF, 25V	1	
	C2803	F1G1E103A123	C 0.01UF 25V	1	
	C2805	F1H1H472A970	C 4700PF, , 50V	1	
	C2806	F1H1E104A129	C 0.1PF, 25V	1	
	C2807	F1K1E106A136	C 10UF, 25V	1	
	C2809	F1K1C106A126	C 10UF, 16V	1	
	C2821	F1J1E104A227	C 0.1UF, 25V	1	
	C2905	F2H1A101A009	E 100 UF, 10V	1	
	C2907	F1G1C104A116	C 0.1UF 16V	1	
	C2908	F1H1C104A143	C 0.1UF, 16V	1	
	C2909	F1H1C104A143	C 0.1UF, 16V	1	
	C2910	F1H1C104A143	C 0.1UF, 16V	1	
	C2911	F1G1C104A116	C 0.1UF 16V	1	
	C2917	F1H1H222A970	C 2200PF, 50V	1	
	C2950	ECJ1VB1A105K	C 1UF, 10V	1	
	C2951	F1H1A225A051	C 2.2UF, 10V	1	
	C2959	F1G1C104A116	C 0.1UF 16V	1	
	C2961	ECJ1VB1A105K	C 1UF, 10V	1	
	C3002	F1G1H561A730	C 56UF, 50V	1	
	C3003	F1G1H561A730	C 56UF, 50V	1	
	C3004	F1G1H561A730	C 56UF, 50V	1	
	C3005	F1G1H561A730	C 56UF, 50V	1	
	C3007	F1G1H561A730	C 56UF, 50V	1	
	C3008	F1G1H561A730	C 56UF, 50V	1	
	C3009	F1G1H561A730	C 56UF, 50V	1	
	C3010	F1G1H561A730	C 56UF, 50V	1	
	C3011	F1G1H561A730	C 56UF, 50V	1	
	C3012	F1G1H561A730	C 56UF, 50V	1	
	C3013	F1G1H561A730	C 56UF, 50V	1	
	C3014	F1G1H561A730	C 56UF, 50V	1	
	C3018	F1J1A106A087	C 10UF, 10V	1	
	C3019	F1J1A106A087	C 10UF, 10V	1	
	C3020	F1J1A106A087	C 10UF, 10V	1	
	C3021	F1J1A106A087	C 10UF, 10V	1	
	C3022	ECJ1VB1A105K	C 1UF, 10V	1	
	C3024	ECJ1VB1A105K	C 1UF, 10V	1	
	C3025	ECJ1VB1A105K	C 1UF, 10V	1	
	C3026	ECJ1VB1A105K	C 1UF, 10V	1	
	C3027	F1J1A106A087	C 10UF, 10V	1	
	C3028	F1J1A106A087	C 10UF, 10V	1	
	C3029	F1J1A106A087	C 10UF, 10V	1	
	C3030	F1J1A106A087	C 10UF, 10V	1	
	C3039	ECJ1VB1A105K	C 1UF, 10V	1	
	C3041	ECJ1VB1A105K	C 1UF, 10V	1	
	C3043	ECJ1VB1A105K	C 1UF, 10V	1	
	C3044	ECJ1VB1A105K	C 1UF, 10V	1	
	C3046	ECJ1VB1A105K	C 1UF, 10V	1	
	C3047	ECJ1VB1A105K	C 1UF, 10V	1	
	C3048	ECJ1VB1A105K	C 1UF, 10V	1	
	C3049	ECJ1VB1A105K	C 1UF, 10V	1	
	C3064	F1G1H102A730	C 1000PF 50V	1	
	C3065	F1G1H102A730	C 1000PF 50V	1	
	C3070	F1J1A106A087	C 10UF, 10V	1	
	C3071	F1J1A106A087	C 10UF, 10V	1	
	C3072	F1G1C104A116	C 0.1UF 16V	1	
	C3073	F1J1A106A087	C 10UF, 10V	1	
	C3078	F1J1A106A087	C 10UF, 10V	1	
	C3083	F1J1A106A087	C 10UF, 10V	1	
	C3084	F1J1A106A087	C 10UF, 10V	1	
	C3085	F1J1A106A087	C 10UF, 10V	1	
	C3086	F1J1A106A087	C 10UF, 10V	1	

Safety	Ref. No.	Part No.	Part Name & Description	Pcs	Remarks
	C3087	F1J1A106A087	C 10UF, 10V	1	
	C3088	F1J1A106A087	C 10UF, 10V	1	
	C3089	F1J1A106A087	C 10UF, 10V	1	
	C3090	F1J1A106A087	C 10UF, 10V	1	
	C3091	F1J1A106A087	C 10UF, 10V	1	
	C3092	F1J1A106A087	C 10UF, 10V	1	
	C3095	F2H1A101A009	E 100 UF, 10V	1	
	C3097	F2H1A101A009	E 100 UF, 10V	1	
	C3099	F1G1H561A730	C 56UF, 50V	1	
	C3102	F2H1A101A009	E 100 UF, 10V	1	
	C3103	F2H1A101A009	E 100 UF, 10V	1	
	C3107	F1J1A106A087	C 10UF, 10V	1	
	C3108	F1J1A106A087	C 10UF, 10V	1	
	C3109	F1J1A106A087	C 10UF, 10V	1	
	C3114	F1J1A106A087	C 10UF, 10V	1	
	C3115	F1J1A106A087	C 10UF, 10V	1	
	C3116	F1J1A106A087	C 10UF, 10V	1	
	C3117	F1J1A106A087	C 10UF, 10V	1	
	C3138	F2H1A101A009	E 100 UF, 10V	1	
	C3139	F1G1C104A116	C 0.1UF 16V	1	
	C3140	F1G1C104A116	C 0.1UF 16V	1	
	C3141	F1G1C104A116	C 0.1UF 16V	1	
	C3143	F1G1C104A116	C 0.1UF 16V	1	
	C3144	F1J1A106A087	C 10UF, 10V	1	
	C3145	F1G1C104A116	C 0.1UF 16V	1	
	C3146	F1J1A106A087	C 10UF, 10V	1	
	C3147	F1J1A106A087	C 10UF, 10V	1	
	C3257	F1G1H561A730	C 56UF, 50V	1	
	C3752	F1J1H102A836	C 1000UF, 50V	1	
	C4200	F1G1H102A730	C 1000PF 50V	1	
	C4201	F1H1C105A145	C 0.01UF, 16V	1	
	C4212	F1K1E106A136	C 10UF, 25V	1	
	C4213	F1K1E106A136	C 10UF, 25V	1	
	C4215	F1G1E332A123	C 3300UF 25V	1	
	C4216	F1J1A475A087	C 4.7UF, 10V	1	
	C4220	F1H1C104A143	C 0.1UF, 16V	1	
	C4233	F1K0J226A008	C 22UF, 6.3V	1	
	C4234	F1K0J226A008	C 22UF, 6.3V	1	
	C4235	F1G1H471A730	C 470PF, 50V	1	
	C4236	F1J1A475A087	C 4.7UF, 10V	1	
	C4237	ECJ1VB1A105K	C 1UF, 10V	1	
	C4238	F1J0G226A001	C 22 UF 4 V	1	
	C4240	F1J1A475A087	C 4.7UF, 10V	1	
	C4241	F1G1C104A116	C 0.1UF 16V	1	
	C4242	F1K0J226A008	C 22UF, 6.3V	1	
	C4243	F1K0J226A008	C 22UF, 6.3V	1	
	C4244	F1K0J226A008	C 22UF, 6.3V	1	
	C4245	F1G1C104A116	C 0.1UF 16V	1	
	C4246	F1J0G226A001	C 22 UF 4 V	1	
	C4247	F1J0G226A001	C 22 UF 4 V	1	
	C4248	F1G1H471A730	C 470PF, 50V	1	
	C4249	F1G1C104A116	C 0.1UF 16V	1	
	C4250	F1G1C104A116	C 0.1UF 16V	1	
	C4251	F1G1C104A116	C 0.1UF 16V	1	
	C4252	F1H1H120A971	C 12PF, 50V	1	
	C4253	F1G1C104A116	C 0.1UF 16V	1	
	C4254	F1G1C104A116	C 0.1UF 16V	1	
	C4255	F1H1H180A971	C 18PF, 50V	1	
	C4256	F1J1A106A087	C 10UF, 10V	1	
	C4257	F1G1C104A116	C 0.1UF 16V	1	
	C4258	F1G1C104A116	C 0.1UF 16V	1	
	C4259	F1G1C104A116	C 0.1UF 16V	1	
	C4260	F1G1C104A116	C 0.1UF 16V	1	
	C4261	F1J0G226A001	C 22 UF 4 V	1	
	C4262	F1J1A475A087	C 4.7UF, 10V	1	
	C4263	ECJ1VB0J105K	C 1UF, 6.3V	1	
	C4264	F1J1A106A087	C 10UF, 10V	1	
	C4266	F1J1A475A087	C 4.7UF, 10V	1	
	C4267	F1G1C104A116	C 0.1UF 16V	1	
	C4268	F1G1C104A116	C 0.1UF 16V	1	
	C4269	F1G1C104A116	C 0.1UF 16V	1	
	C4270	F1G1C104A116	C 0.1UF 16V	1	
	C4271	F1G1C104A116	C 0.1UF 16V	1	

Safety	Ref. No.	Part No.	Part Name & Description	Pcs	Remarks
	C4272	FIG1C104A116	C 0.1UF 16V	1	
	C4273	FIG1C104A116	C 0.1UF 16V	1	
	C4274	FIG1C104A116	C 0.1UF 16V	1	
	C4275	FIJ0G226A001	C 22 UF 4 V	1	
	C4276	FIG1C104A116	C 0.1UF 16V	1	
	C4277	FIG1C104A116	C 0.1UF 16V	1	
	C4278	FIG1C104A116	C 0.1UF 16V	1	
	C4279	FIG1C104A116	C 0.1UF 16V	1	
	C4280	FIG1C104A116	C 0.1UF 16V	1	
	C4281	FIG1C104A116	C 0.1UF 16V	1	
	C4282	FIG1C104A116	C 0.1UF 16V	1	
	C4283	FIG1C104A116	C 0.1UF 16V	1	
	C4284	FIG1C104A116	C 0.1UF 16V	1	
	C4285	FIJ0G226A001	C 22 UF 4 V	1	
	C4286	FIG1C104A116	C 0.1UF 16V	1	
	C4287	FIG1C104A116	C 0.1UF 16V	1	
	C4288	FIG1C104A116	C 0.1UF 16V	1	
	C4289	FIG1C104A116	C 0.1UF 16V	1	
	C4290	FIG1C104A116	C 0.1UF 16V	1	
	C4291	FIG1C104A116	C 0.1UF 16V	1	
	C4292	FIG1C104A116	C 0.1UF 16V	1	
	C4293	FIG1C104A116	C 0.1UF 16V	1	
	C4294	FIG1C104A116	C 0.1UF 16V	1	
	C4295	FIG1C104A116	C 0.1UF 16V	1	
	C4297	FIG1C104A116	C 0.1UF 16V	1	
	C4298	FIG1C104A116	C 0.1UF 16V	1	
	C4299	FIG1C104A116	C 0.1UF 16V	1	
	C4300	FIG1C104A116	C 0.1UF 16V	1	
	C4301	FIG1C104A116	C 0.1UF 16V	1	
	C4302	FIG1C104A116	C 0.1UF 16V	1	
	C4303	FIG1C104A116	C 0.1UF 16V	1	
	C4304	FIG1C104A116	C 0.1UF 16V	1	
	C4305	FIG1C104A116	C 0.1UF 16V	1	
	C4306	FIG1C104A116	C 0.1UF 16V	1	
	C4307	FIG1H101A731	C 100PF 50V	1	
	C4308	FIG1C104A116	C 0.1UF 16V	1	
	C4309	FIG1C104A116	C 0.1UF 16V	1	
	C4311	FIH1E104A129	C 0.1PF, 25V	1	
	C4312	FIG1E103A123	C 0.01UF 25V	1	
	C4313	FIH1H472A970	C 4700PF, , 50V	1	
	C4314	FIJ1E224A227	C 0.22UF, 25V	1	
	C4315	FIG1C104A116	C 0.1UF 16V	1	
	C4316	FK1E106A136	C 10UF, 25V	1	
	C4317	FIG1C104A116	C 0.1UF 16V	1	
	C4318	FK0J226A008	C 22UF, 6.3V	1	
	C4319	ECGR10G680ER	C 68UF, J, 4V	1	
	C4320	FIG1C104A116	C 0.1UF 16V	1	
	C4322	FIG1C104A116	C 0.1UF 16V	1	
	C4323	FIG1C104A116	C 0.1UF 16V	1	
	C4324	FIG1C104A116	C 0.1UF 16V	1	
	C4325	FIJ1A106A087	C 10UF, 10V	1	
	C4330	FIG1C104A116	C 0.1UF 16V	1	
	C4331	FIG1C104A116	C 0.1UF 16V	1	
	C4332	FIG1C104A116	C 0.1UF 16V	1	
	C4333	FIG1C104A116	C 0.1UF 16V	1	
	C4334	FIG1C104A116	C 0.1UF 16V	1	
	C4335	FIG1C104A116	C 0.1UF 16V	1	
	C4336	FIG1C104A116	C 0.1UF 16V	1	
	C4337	FIG1C104A116	C 0.1UF 16V	1	
	C4338	FIG1C104A116	C 0.1UF 16V	1	
	C4339	FIG1C104A116	C 0.1UF 16V	1	
	C4340	FIG1C104A116	C 0.1UF 16V	1	
	C4348	FIG1H101A731	C 100PF 50V	1	
	C4546	ECJ1VB0J105K	C 1UF, 6.3V	1	
	C4548	ECJ1VB0J105K	C 1UF, 6.3V	1	
	C4660	ECJ1VB0J105K	C 1UF, 6.3V	1	
	C4661	ECJ1VB0J105K	C 1UF, 6.3V	1	
	C4662	ECJ1VB0J105K	C 1UF, 6.3V	1	
	C4663	ECJ1VB0J105K	C 1UF, 6.3V	1	
	C4664	ECJ1VB0J105K	C 1UF, 6.3V	1	
	C4665	ECJ1VB0J105K	C 1UF, 6.3V	1	
	C4666	ECJ1VB0J105K	C 1UF, 6.3V	1	
	C4667	ECJ1VB0J105K	C 1UF, 6.3V	1	

Safety	Ref. No.	Part No.	Part Name & Description	Pcs	Remarks
	C4701	FIG1C104A116	C 0.1UF 16V	1	
	C4702	FIG1C104A116	C 0.1UF 16V	1	
	C4704	FIG1C104A116	C 0.1UF 16V	1	
	C4705	FIG1C104A116	C 0.1UF 16V	1	
	C4707	FIG1C104A116	C 0.1UF 16V	1	
	C4708	FIG1C104A116	C 0.1UF 16V	1	
	C4713	FIG1C104A116	C 0.1UF 16V	1	
	C4715	FIG1C104A116	C 0.1UF 16V	1	
	C4717	FIJ1A106A087	C 10UF, 10V	1	
	C4718	FIJ1A475A087	C 4.7UF, 10V	1	
	C4719	FIG1C104A116	C 0.1UF 16V	1	
	C4721	FIG1C104A116	C 0.1UF 16V	1	
	C4724	FIG1C104A116	C 0.1UF 16V	1	
	C4730	FIG1C104A116	C 0.1UF 16V	1	
	C4731	FIG1C104A116	C 0.1UF 16V	1	
	C5251	FIJ1E105A231	C 1 UF 25V	1	
	C5253	FIJ1E105A231	C 1 UF 25V	1	
	C5255	ECJ1VB1A105K	C 1UF, 10V	1	
	C5256	ECJ1VB1A105K	C 1UF, 10V	1	
	C5293	FIJ1E105A231	C 1 UF 25V	1	
	C5294	FIH1C105A145	C 0.01UF, 16V	1	
	C5301	FIG1H102A730	C 100PF 50V	1	
	C5310	FK1E106A136	C 10UF, 25V	1	
	C5311	FK1E106A136	C 10UF, 25V	1	
	C5312	FK1E106A136	C 10UF, 25V	1	
	C5313	FK1E106A136	C 10UF, 25V	1	
	C5314	FK0J226A008	C 22UF, 6.3V	1	
	C5315	FK0J226A008	C 22UF, 6.3V	1	
	C5317	FIH1E104A129	C 0.1PF, 25V	1	
	C5318	FIG1E682A123	C 6800UF 25V	1	
	C5319	FIG1E103A123	C 0.01UF 25V	1	
	C5431	FIG1C104A116	C 0.1UF 16V	1	
	C5432	FIG1C104A116	C 0.1UF 16V	1	
	C5435	FIG1C104A116	C 0.1UF 16V	1	
	C5436	FIG1C104A116	C 0.1UF 16V	1	
	C5437	FIG1C104A116	C 0.1UF 16V	1	
	C5438	FIG1C104A116	C 0.1UF 16V	1	
	C5470	FIG1C103A116	C 0.01UF 16V	1	
	C5471	FIG1A473A053	C0.047UF, 10V	1	
	C5473	FIG1E103A123	C 0.01UF 25V	1	
	C5474	FIG1C104A116	C 0.1UF 16V	1	
	C5475	FIG1A4740003	C 0.47UF, , 10V	1	
	C5482	F2G1A221A149	E 220UF, 10V	1	
	C5485	FIG1C104A116	C 0.1UF 16V	1	
	C5487	ECJ1VB0J105K	C 1UF, 6.3V	1	
	C5488	ECJ1VB0J105K	C 1UF, 6.3V	1	
	C5490	FIG1C104A116	C 0.1UF 16V	1	
	C5500	FIG1E682A123	C 6800UF 25V	1	
	C5501	FIG1A154A053	C 0.15UF, 10V	1	
	C5502	FIJ1A475A087	C 4.7UF, 10V	1	
	C5503	FIH1C105A145	C 0.01UF, 16V	1	
	C5504	FIG1E682A123	C 6800UF 25V	1	
	C5505	FIJ1A475A087	C 4.7UF, 10V	1	
	C5506	FIH1C105A145	C 0.01UF, 16V	1	
	C5507	FIG1A393A053	C0.015UF, 10V	1	
	C5508	FIH1C104A143	C 0.1UF, 16V	1	
	C5509	FIH1C104A143	C 0.1UF, 16V	1	
	C5510	FIH1C104A143	C 0.1UF, 16V	1	
	C5511	FIH1C104A143	C 0.1UF, 16V	1	
	C5516	FK1E106A136	C 10UF, 25V	1	
	C5517	FK1E106A136	C 10UF, 25V	1	
	C5519	FK1E106A136	C 10UF, 25V	1	
	C5520	FK1E106A136	C 10UF, 25V	1	
	C5521	FK1E106A136	C 10UF, 25V	1	
	C5522	FK1E106A136	C 10UF, 25V	1	
	C5523	FK1E106A136	C 10UF, 25V	1	
	C5526	FK1E106A136	C 10UF, 25V	1	
	C5528	FK0J226A008	C 22UF, 6.3V	1	
	C5529	FK0J226A008	C 22UF, 6.3V	1	
	C5530	FK0J226A008	C 22UF, 6.3V	1	
	C5531	FK0J226A008	C 22UF, 6.3V	1	
	C5532	FK0J226A008	C 22UF, 6.3V	1	
	C5533	FK0J226A008	C 22UF, 6.3V	1	

Safety	Ref. No.	Part No.	Part Name & Description	Pcs	Remarks
	C5534	F1K0J226A008	C 22UF, 6.3V	1	
	C5535	F1K0J226A008	C 22UF, 6.3V	1	
	C5536	F1K0J226A008	C 22UF, 6.3V	1	
	C5537	F1K0J226A008	C 22UF, 6.3V	1	
	C5538	F1K0J226A008	C 22UF, 6.3V	1	
	C5539	F1K0J226A008	C 22UF, 6.3V	1	
	C5603	F1G1H102A730	C 1000PF 50V	1	
	C5615	F1H1A225A051	C 2.2UF, 10V	1	
	C5616	F1G1E103A123	C 0.01UF 25V	1	
	C5635	F1H1C105A145	C 0.01UF, 16V	1	
	C5649	ECJ1VB1A105K	C 1UF, 10V	1	
	C5650	F1H1A225A051	C 2.2UF, 10V	1	
	C5651	F1J1A475A087	C 4.7UF, 10V	1	
	C5652	F1H0J475A041	C 4.7UF, 16V	1	
	C5719	F1J1A106A087	C 10UF, 10V	1	
	C5720	F1J1A106A087	C 10UF, 10V	1	
	C5724	F1H1E104A129	C 0.1PF, 25V	1	
	C5725	F1G1E682A123	C 6800UF 25V	1	
	C5726	F1G1E103A123	C 0.01UF 25V	1	
	C5728	F1J1A106A087	C 10UF, 10V	1	
	C5729	F1J1A106A087	C 10UF, 10V	1	
	C6700	F1H1E104A129	C 0.1PF, 25V	1	
	C6701	F1H1E104A129	C 0.1PF, 25V	1	
	C6702	F1H1E104A129	C 0.1PF, 25V	1	
	C6703	EEHBOG221P	C 220PF, J, 4V	1	
	C6704	F2G1E1010028	E 100PF, 25V	1	PAVCCZ
	C6705	F1H1E104A129	C 0.1PF, 25V	1	
	C6706	F2G1V4700028	E 47UF, 35V	1	PAVCCZ
	C6707	F1J1H474A757	C 0.47UF, 50V	1	
	C6708	F1H1H103A970	C 0.01PF, 50V	1	
	C6709	EEHBOG221P	C 220PF, J, 4V	1	
	C6710	F2G1V4700028	E 47UF, 35V	1	PAVCCZ
	C6711	F1H1E104A129	C 0.1PF, 25V	1	
	C6712	F1J1E224A227	C 0.22UF, 25V	1	
	C6713	F1J1E224A227	C 0.22UF, 25V	1	
	C6714	F1H1E104A129	C 0.1PF, 25V	1	
	C6715	F1J1H474A757	C 0.47UF, 50V	1	
	C6716	F1J1E224A227	C 0.22UF, 25V	1	
	C6717	F1K1E106A136	C 10UF, 25V	1	
	C6718	F1H1H103A970	C 0.01PF, 50V	1	
	C6719	F1H1E104A129	C 0.1PF, 25V	1	
	C6720	F1H1H181A971	C 180PF, 50V	1	
	C6721	F1H1A225A051	C 2.2UF, 10V	1	
	C6722	F1H1A225A051	C 2.2UF, 10V	1	
	C6723	F1K1E106A136	C 10UF, 25V	1	
	C6724	F1K0J226A008	C 22UF, 6.3V	1	
	C6725	F1K1E106A136	C 10UF, 25V	1	
	C6726	F1K0J226A008	C 22UF, 6.3V	1	
	C6727	F1H1H103A970	C 0.01PF, 50V	1	
	C6728	F1H1E104A129	C 0.1PF, 25V	1	
	C6730	F1H1E153A129	C 0.015PF, 25V	1	
	C6731	F1H1H392A970	C 3900PF, 50V	1	
	C6732	ECJ1VB0J105K	C 1UF, 6.3V	1	
	C6735	F1J1E105A231	C 1UF 25V	1	
	C6736	F1H1H102A971	C 1000PF, 50V	1	
	C6748	F1H1H822A970	C 8200PF, 50V	1	
	C6750	F1H1H102A971	C 1000PF, 50V	1	
	C6752	F2G1E1010028	E 100PF, 25V	1	PAVCCZ
	C6753	F2G1V4700028	E 47UF, 35V	1	PAVCCZ
	C6754	F2G1V4700028	E 47UF, 35V	1	PAVCCZ
	C8000	F1J1A106A087	C 10UF, 10V	1	
	C8001	F1J1A106A087	C 10UF, 10V	1	
	C8002	ECGRLOG680ER	C 68UF, J, 4V	1	
	C8003	F1J1A106A087	C 10UF, 10V	1	
	C8004	F1G1C104A116	C 0.1UF 16V	1	
	C8005	F1J1A106A087	C 10UF, 10V	1	
	C8006	F1J1A106A087	C 10UF, 10V	1	
	C8008	F1J1A106A087	C 10UF, 10V	1	
	C8009	F1J1A106A087	C 10UF, 10V	1	
	C8010	F1G1C104A116	C 0.1UF 16V	1	
	C8011	F1G1C104A116	C 0.1UF 16V	1	
	C8012	F1G1C104A116	C 0.1UF 16V	1	
	C8013	F1G1C104A116	C 0.1UF 16V	1	

Safety	Ref. No.	Part No.	Part Name & Description	Pcs	Remarks
	C8015	F1J1A106A087	C 10UF, 10V	1	
	C8016	F1G1C104A116	C 0.1UF 16V	1	
	C8017	F1J1A106A087	C 10UF, 10V	1	
	C8018	F1G1C104A116	C 0.1UF 16V	1	
	C8019	F1G1C104A116	C 0.1UF 16V	1	
	C8020	F1G1C104A116	C 0.1UF 16V	1	
	C8021	F1G1C104A116	C 0.1UF 16V	1	
	C8022	F1G1C104A116	C 0.1UF 16V	1	
	C8023	F1G1C104A116	C 0.1UF 16V	1	
	C8024	F1G1C104A116	C 0.1UF 16V	1	
	C8025	F1G1C104A116	C 0.1UF 16V	1	
	C8027	F1G1A105A047	C 1UF 10V	1	
	C8028	F1G1C104A116	C 0.1UF 16V	1	
	C8029	F1G1C104A116	C 0.1UF 16V	1	
	C8030	F1G1C104A116	C 0.1UF 16V	1	
	C8031	F1G1C104A116	C 0.1UF 16V	1	
	C8033	F1G1C104A116	C 0.1UF 16V	1	
	C8034	F1G1C104A116	C 0.1UF 16V	1	
	C8035	F1G1C104A116	C 0.1UF 16V	1	
	C8036	F1G1A105A047	C 1UF 10V	1	
	C8037	F1G1C104A116	C 0.1UF 16V	1	
	C8038	F1G1C104A116	C 0.1UF 16V	1	
	C8039	F1G1C104A116	C 0.1UF 16V	1	
	C8040	F1G1C104A116	C 0.1UF 16V	1	
	C8042	F1G1C104A116	C 0.1UF 16V	1	
	C8043	F1G1C104A116	C 0.1UF 16V	1	
	C8044	F1G1C104A116	C 0.1UF 16V	1	
	C8045	F1G1A105A047	C 1UF 10V	1	
	C8046	F1G1C104A116	C 0.1UF 16V	1	
	C8048	F1G1C104A116	C 0.1UF 16V	1	
	C8049	F1G1C104A116	C 0.1UF 16V	1	
	C8050	F1G1C104A116	C 0.1UF 16V	1	
	C8051	F1G1A105A047	C 1UF 10V	1	
	C8052	F1G1C104A116	C 0.1UF 16V	1	
	C8053	F1G1C104A116	C 0.1UF 16V	1	
	C8054	F1G1A105A047	C 1UF 10V	1	
	C8055	F1G1C104A116	C 0.1UF 16V	1	
	C8056	F1G1C104A116	C 0.1UF 16V	1	
	C8057	F1G1A105A047	C 1UF 10V	1	
	C8058	F1H0J475A041	C 4.7UF, 16V	1	
	C8059	F1H0J475A041	C 4.7UF, 16V	1	
	C8060	F1H0J475A041	C 4.7UF, 16V	1	
	C8061	F1J1A106A087	C 10UF, 10V	1	
	C8062	F1G1C104A116	C 0.1UF 16V	1	
	C8063	F1G1C104A116	C 0.1UF 16V	1	
	C8064	F1G1A105A047	C 1UF 10V	1	
	C8065	F1G1C104A116	C 0.1UF 16V	1	
	C8066	F1G1C104A116	C 0.1UF 16V	1	
	C8067	F1G1C104A116	C 0.1UF 16V	1	
	C8068	F1G1C104A116	C 0.1UF 16V	1	
	C8069	F1G1C104A116	C 0.1UF 16V	1	
	C8070	F1G1C104A116	C 0.1UF 16V	1	
	C8071	F1G1C104A116	C 0.1UF 16V	1	
	C8072	F1G1C104A116	C 0.1UF 16V	1	
	C8073	F1G1C104A116	C 0.1UF 16V	1	
	C8074	F1G1C104A116	C 0.1UF 16V	1	
	C8075	F1G1C104A116	C 0.1UF 16V	1	
	C8076	F1G1C104A116	C 0.1UF 16V	1	
	C8077	F1G1C104A116	C 0.1UF 16V	1	
	C8078	F1G1C104A116	C 0.1UF 16V	1	
	C8079	F1G1C104A116	C 0.1UF 16V	1	
	C8082	F1J1A106A087	C 10UF, 10V	1	
	C8083	F1H0J475A041	C 4.7UF, 16V	1	
	C8084	F1J1A106A087	C 10UF, 10V	1	
	C8085	F1J1A106A087	C 10UF, 10V	1	
	C8087	F1G1C104A116	C 0.1UF 16V	1	
	C8088	F1G1C104A116	C 0.1UF 16V	1	
	C8089	F1G1C104A116	C 0.1UF 16V	1	
	C8090	F1G1C104A116	C 0.1UF 16V	1	
	C8091	F1G1C104A116	C 0.1UF 16V	1	
	C8092	F1G1C104A116	C 0.1UF 16V	1	
	C8094	F1G1C104A116	C 0.1UF 16V	1	
	C8096	F1G1C104A116	C 0.1UF 16V	1	

Safety	Ref. No.	Part No.	Part Name & Description	Pcs	Remarks
	C8099	FIJ1A106A087	C 10UF, 10V	1	
	C8100	FIJ1A106A087	C 10UF, 10V	1	
	C8101	FIJ1A106A087	C 10UF, 10V	1	
	C8102	FIJ1A106A087	C 10UF, 10V	1	
	C8103	FIJ1A106A087	C 10UF, 10V	1	
	C8104	FIJ1A106A087	C 10UF, 10V	1	
	C8105	FIJ1A106A087	C 10UF, 10V	1	
	C8106	FIH0J475A041	C 4.7UF, 16V	1	
	C8107	FIH0J475A041	C 4.7UF, 16V	1	
	C8108	FIJ1A106A087	C 10UF, 10V	1	
	C8109	FIG1C104A116	C 0.1UF 16V	1	
	C8110	FIG1C104A116	C 0.1UF 16V	1	
	C8111	FIG1C104A116	C 0.1UF 16V	1	
	C8112	FIG1C104A116	C 0.1UF 16V	1	
	C8113	FIG1C104A116	C 0.1UF 16V	1	
	C8114	FIG1C104A116	C 0.1UF 16V	1	
	C8115	FIG1C104A116	C 0.1UF 16V	1	
	C8116	FIG1C104A116	C 0.1UF 16V	1	
	C8117	FIG1C104A116	C 0.1UF 16V	1	
	C8119	FIG1C104A116	C 0.1UF 16V	1	
	C8120	FIG1C104A116	C 0.1UF 16V	1	
	C8121	FIG1C104A116	C 0.1UF 16V	1	
	C8122	FIG1C104A116	C 0.1UF 16V	1	
	C8123	FIG1C104A116	C 0.1UF 16V	1	
	C8124	FIG1C104A116	C 0.1UF 16V	1	
	C8126	FIG1C104A116	C 0.1UF 16V	1	
	C8127	FIG1C104A116	C 0.1UF 16V	1	
	C8128	FIG1C104A116	C 0.1UF 16V	1	
	C8129	FIG1C104A116	C 0.1UF 16V	1	
	C8130	FIG1C104A116	C 0.1UF 16V	1	
	C8131	FIG1C104A116	C 0.1UF 16V	1	
	C8132	FIG1C104A116	C 0.1UF 16V	1	
	C8133	FIG1C104A116	C 0.1UF 16V	1	
	C8134	FIG1C104A116	C 0.1UF 16V	1	
	C8136	FIG1C104A116	C 0.1UF 16V	1	
	C8137	FIG1C104A116	C 0.1UF 16V	1	
	C8138	FIG1C104A116	C 0.1UF 16V	1	
	C8139	FIG1C104A116	C 0.1UF 16V	1	
	C8140	FIG1C104A116	C 0.1UF 16V	1	
	C8141	FIG1C104A116	C 0.1UF 16V	1	
	C8142	FIG1C104A116	C 0.1UF 16V	1	
	C8143	FIG1C104A116	C 0.1UF 16V	1	
	C8144	FIG1C104A116	C 0.1UF 16V	1	
	C8145	FIG1C104A116	C 0.1UF 16V	1	
	C8146	FIG1C104A116	C 0.1UF 16V	1	
	C8147	FIG1C104A116	C 0.1UF 16V	1	
	C8148	FIG1A105A047	C 1UF 10V	1	
	C8149	FIG1A105A047	C 1UF 10V	1	
	C8150	FIG1H8R0A732	C 8 PF, 50V	1	
	C8151	FIG1H8R0A732	C 8 PF, 50V	1	
	C8154	FIG1C103A116	C 0.01UF 16V	1	
	C8155	FIG1H150A731	C 15PF, 50V	1	
	C8156	FIG1HR50A577	C 0.5PF, 50V	1	
	C8157	FIG1C104A116	C 0.1UF 16V	1	
	C8158	FIG1C104A116	C 0.1UF 16V	1	
	C8159	FIJ1A106A087	C 10UF, 10V	1	
	C8160	ECJ1VF1A105Z	C 1UF, Z, 10V	1	
	C8240	FIG1C104A116	C 0.1UF 16V	1	
	C8241	FIG1C104A116	C 0.1UF 16V	1	
	C8242	FIG1C104A116	C 0.1UF 16V	1	
	C8243	FIG1H3R0A732	C 3 PF, 50V	1	
	C8246	FIG1A105A047	C 1UF 10V	1	
	C8247	FIG1C104A116	C 0.1UF 16V	1	
	C8248	FIG1C104A116	C 0.1UF 16V	1	
	C8249	FIG1C104A116	C 0.1UF 16V	1	
	C8250	FIG1C104A116	C 0.1UF 16V	1	
	C8251	ECGRLOG680ER	C 68UF, J, 4V	1	
	C8252	FIJ1A106A087	C 10UF, 10V	1	
	C8253	FIG1C104A116	C 0.1UF 16V	1	
	C8254	FIG1A105A047	C 1UF 10V	1	
	C8255	FIG1A105A047	C 1UF 10V	1	
	C8256	FIG1A105A047	C 1UF 10V	1	
	C8257	FIG1C104A116	C 0.1UF 16V	1	

Safety	Ref. No.	Part No.	Part Name & Description	Pcs	Remarks
	C8258	FIG1C104A116	C 0.1UF 16V	1	
	C8259	FIG1A105A047	C 1UF 10V	1	
	C8260	FIG1C104A116	C 0.1UF 16V	1	
	C8261	FIG1C104A116	C 0.1UF 16V	1	
	C8262	FIG1C104A116	C 0.1UF 16V	1	
	C8263	FIG1A105A047	C 1UF 10V	1	
	C8264	FIG1A105A047	C 1UF 10V	1	
	C8265	FIG1C104A116	C 0.1UF 16V	1	
	C8266	FIG1C104A116	C 0.1UF 16V	1	
	C8267	FIG1C104A116	C 0.1UF 16V	1	
	C8268	FIG1C104A116	C 0.1UF 16V	1	
	C8269	FIG1C104A116	C 0.1UF 16V	1	
	C8270	FIG1C104A116	C 0.1UF 16V	1	
	C8271	ECGRLOG680ER	C 68UF, J, 4V	1	
	C8272	FIJ1A106A087	C 10UF, 10V	1	
	C8273	FIG1A105A047	C 1UF 10V	1	
	C8274	FIG1C104A116	C 0.1UF 16V	1	
	C8275	FIG1A105A047	C 1UF 10V	1	
	C8276	FIG1C104A116	C 0.1UF 16V	1	
	C8277	FIG1C104A116	C 0.1UF 16V	1	
	C8278	FIG1A105A047	C 1UF 10V	1	
	C8279	FIG1C104A116	C 0.1UF 16V	1	
	C8280	FIG1C104A116	C 0.1UF 16V	1	
	C8281	FIG1A105A047	C 1UF 10V	1	
	C8282	FIG1C104A116	C 0.1UF 16V	1	
	C8283	FIG1A105A047	C 1UF 10V	1	
	C8284	FIG1A105A047	C 1UF 10V	1	
	C8285	FIG1A105A047	C 1UF 10V	1	
	C8286	FIG1A105A047	C 1UF 10V	1	
	C8289	FIG1C104A116	C 0.1UF 16V	1	
	C8290	FIG1C104A116	C 0.1UF 16V	1	
	C8291	FIG1C104A116	C 0.1UF 16V	1	
	C8292	FIG1C104A116	C 0.1UF 16V	1	
	C8293	FIG1C104A116	C 0.1UF 16V	1	
	C8300	FIG1C104A116	C 0.1UF 16V	1	
	C8301	FIG1C104A116	C 0.1UF 16V	1	
	C8303	FIG1C104A116	C 0.1UF 16V	1	
	C8304	FIG1H100A731	C 10PF 50V	1	
	C8305	FIG1H100A731	C 10PF 50V	1	
	C8306	FIG1C104A116	C 0.1UF 16V	1	
	C8308	FIG1C104A116	C 0.1UF 16V	1	
	C8309	FIG1C104A116	C 0.1UF 16V	1	
	C8310	FIG1C104A116	C 0.1UF 16V	1	
	C8311	FIJ1A106A087	C 10UF, 10V	1	
	C8314	FIG1C104A116	C 0.1UF 16V	1	
	C8315	FIG1C104A116	C 0.1UF 16V	1	
	C8316	FIG1C104A116	C 0.1UF 16V	1	
	C8317	FIG1C104A116	C 0.1UF 16V	1	
	C8318	FIG1C104A116	C 0.1UF 16V	1	
	C8319	FIG1C104A116	C 0.1UF 16V	1	
	C8320	ECJ1VB1A105K	C 1UF, 10V	1	
	C8321	FIH1A225A051	C 2.2UF, 10V	1	
	C8322	FIG1C104A116	C 0.1UF 16V	1	
	C8324	FIG1H560A731	C 56PF, 50V	1	
	C8325	FIG1H560A731	C 56PF, 50V	1	
	C8360	FIG1C104A116	C 0.1UF 16V	1	
	C8361	FIG1C104A116	C 0.1UF 16V	1	
	C8362	FIG1C104A116	C 0.1UF 16V	1	
	C8365	FIG1H151A731	C 150PF, 50V	1	
	C8366	FIG1H151A731	C 150PF, 50V	1	
	C8367	FIG1H151A731	C 150PF, 50V	1	
	C8368	FIG1H151A731	C 150PF, 50V	1	
	C8369	FIG1H151A731	C 150PF, 50V	1	
	C8370	FIG1H151A731	C 150PF, 50V	1	
	C8371	FIG1H151A731	C 150PF, 50V	1	
	C8372	FIG1H151A731	C 150PF, 50V	1	
	C8373	FIG1H151A731	C 150PF, 50V	1	
	C8374	FIG1H151A731	C 150PF, 50V	1	
	C8375	FIG1H151A731	C 150PF, 50V	1	
	C8400	FIG1C104A116	C 0.1UF 16V	1	
	C8401	FIG1C104A116	C 0.1UF 16V	1	
	C8402	FIG1C104A116	C 0.1UF 16V	1	
	C8403	FIG1C104A116	C 0.1UF 16V	1	

Safety	Ref. No.	Part No.	Part Name & Description	Pcs	Remarks
	C8404	F1G1C104A116	C 0.1UF 16V	1	
	C8405	F1G1C104A116	C 0.1UF 16V	1	
	C8406	F1G1C104A116	C 0.1UF 16V	1	
	C8407	F1G1C104A116	C 0.1UF 16V	1	
	C8408	F1G1C104A116	C 0.1UF 16V	1	
	C8409	F1G1C104A116	C 0.1UF 16V	1	
	C8410	F1G1C104A116	C 0.1UF 16V	1	
	C8412	F1G1C104A116	C 0.1UF 16V	1	
	C8413	F1G1E103A123	C 0.01UF 25V	1	
	C8414	F1G1E103A123	C 0.01UF 25V	1	
	C8415	F1G1C104A116	C 0.1UF 16V	1	
	C8416	F1K0J226A008	C 22UF, 6.3V	1	
	C8417	F1K0J226A008	C 22UF, 6.3V	1	
	C8418	F1K0J226A008	C 22UF, 6.3V	1	
	C8512	F1G1C104A116	C 0.1UF 16V	1	
	C8513	F1G1C104A116	C 0.1UF 16V	1	
	C8515	F1J1A106A087	C 10UF, 10V	1	
	C8516	F1G1C103A116	C 0.01UF 16V	1	
	C8600	F1G1H102A730	C 1000PF 50V	1	
	C8711	F1J1A106A087	C 10UF, 10V	1	
	C8712	F1G1C104A116	C 0.1UF 16V	1	
	C8713	F1G1C104A116	C 0.1UF 16V	1	
	C8714	F1G1H101A731	C 100PF 50V	1	
	C8717	F1J1A106A087	C 10UF, 10V	1	
	C8718	F1G1C104A116	C 0.1UF 16V	1	
	C8719	F1G1C104A116	C 0.1UF 16V	1	
	C8720	F1G1C104A116	C 0.1UF 16V	1	
	C8721	F1G1C104A116	C 0.1UF 16V	1	
	C8722	F1J1A106A087	C 10UF, 10V	1	
	C8726	F1J1A106A087	C 10UF, 10V	1	
	C8727	F1G1C104A116	C 0.1UF 16V	1	
	C8728	EEHBOJ221UP	E 220UF, 6.3V	1	
	C8731	F1G1C104A116	C 0.1UF 16V	1	
	C8739	F1J1A106A087	C 10UF, 10V	1	
	C8740	F1J1A106A087	C 10UF, 10V	1	
	C8741	F1G1A105A047	C 1UF 10V	1	
	C8742	F1G1A105A047	C 1UF 10V	1	
	C8744	EEHBOJ221UP	E 220UF, 6.3V	1	
	C8747	F1G1C104A116	C 0.1UF 16V	1	
	C8853	F1G1C104A116	C 0.1UF 16V	1	
	C8854	F1G1C104A116	C 0.1UF 16V	1	
	C8860	F2G1C470A022	E 47UF, 16V	1	
	C8861	F1G1C104A116	C 0.1UF 16V	1	
	C8862	F1G1C103A116	C 0.01UF 16V	1	
	C8863	F1J0G226A001	C 22 UF 4 V	1	
	C8922	F1G1C104A116	C 0.1UF 16V	1	
	C8923	F1G1C104A116	C 0.1UF 16V	1	
	C8950	F1G1C103A116	C 0.01UF 16V	1	
	C9040	F1G1C104A116	C 0.1UF 16V	1	
	C9052	F1G1C104A116	C 0.1UF 16V	1	
	C9066	F1K0J226A008	C 22UF, 6.3V	1	
	C9067	F1G1H102A730	C 1000PF 50V	1	
	C9069	F1G1H102A730	C 1000PF 50V	1	
	C9097	F1K1E106A136	C 10UF, 25V	1	
	C9098	F1K1E106A136	C 10UF, 25V	1	
	C9099	F1G1C104A116	C 0.1UF 16V	1	
	C9100	F1J1A106A087	C 10UF, 10V	1	
	C9101	F1G1E103A123	C 0.01UF 25V	1	
	C9102	F1K1E106A136	C 10UF, 25V	1	
	C9103	F1G1E103A123	C 0.01UF 25V	1	
	C9104	F1G1E103A123	C 0.01UF 25V	1	
	C9107	F1G1H272A730	C 2700PF, 50V	1	
	C9111	F1K0J226A008	C 22UF, 6.3V	1	
	C9112	F1K0J226A008	C 22UF, 6.3V	1	
	C9300	F1G1C104A116	C 0.1UF 16V	1	
	C9301	F1G1H180A731	C 18PF, 50V	1	
	C9302	F1G1H150A731	C 15PF, 50V	1	
	C9307	F1G1C104A116	C 0.1UF 16V	1	
	C9308	F1G1C104A116	C 0.1UF 16V	1	
	C9311	F1G1C104A116	C 0.1UF 16V	1	
	C9312	F1J1A106A087	C 10UF, 10V	1	
	C9313	F1G1C104A116	C 0.1UF 16V	1	
	C9314	F1J1A106A087	C 10UF, 10V	1	

Safety	Ref. No.	Part No.	Part Name & Description	Pcs	Remarks
	C9315	F1G1C104A116	C 0.1UF 16V	1	
	C9316	F1J1A106A087	C 10UF, 10V	1	
	C9319	F1G1C104A116	C 0.1UF 16V	1	
	C9322	F1G1C104A116	C 0.1UF 16V	1	
	C9323	F1G1C104A116	C 0.1UF 16V	1	
	C9325	F1G1C104A116	C 0.1UF 16V	1	
	C9327	F1G1C104A116	C 0.1UF 16V	1	
	C9335	F1J1A106A087	C 10UF, 10V	1	
	C9336	F1J1A106A087	C 10UF, 10V	1	
	C9337	F1J1A106A087	C 10UF, 10V	1	
	C9339	F1G1C104A116	C 0.1UF 16V	1	
	C9340	F1G1C104A116	C 0.1UF 16V	1	
	C9342	F1G1C104A116	C 0.1UF 16V	1	
	C9344	F1G1C104A116	C 0.1UF 16V	1	
	C9347	ECJ1VB0J105K	C 1UF, 6.3V	1	
	C9349	F1J1A106A087	C 10UF, 10V	1	
	C9350	F1G1C104A116	C 0.1UF 16V	1	
	C9351	F1G1C104A116	C 0.1UF 16V	1	
	C9352	ECJ1VB0J105K	C 1UF, 6.3V	1	
	C9356	F1G1C104A116	C 0.1UF 16V	1	
	C9361	F1G1C104A116	C 0.1UF 16V	1	
	C9363	F1G1C104A116	C 0.1UF 16V	1	
	C9371	F1J1A106A087	C 10UF, 10V	1	
	C9372	F1J1A106A087	C 10UF, 10V	1	
	C9373	F1J1A106A087	C 10UF, 10V	1	
	C9374	F1G1C104A116	C 0.1UF 16V	1	
	C9375	F1G1C104A116	C 0.1UF 16V	1	
	C9380	F1G1C104A116	C 0.1UF 16V	1	
	C9383	F1G1C104A116	C 0.1UF 16V	1	
	C9391	F1J1A106A087	C 10UF, 10V	1	
	C9392	F1J1A106A087	C 10UF, 10V	1	
	C9400	F1G1C104A116	C 0.1UF 16V	1	
	C9401	F1G1C104A116	C 0.1UF 16V	1	
	C9402	F1G1C104A116	C 0.1UF 16V	1	
	C9800	F1H1E104A129	C 0.1PF, 25V	1	
	C9801	F1G1E682A123	C 6800UF 25V	1	
	C9803	F1G1E472A123	C 4700UF 25V	1	
	C9804	F1K1E106A136	C 10UF, 25V	1	
	C9805	F1K1E106A136	C 10UF, 25V	1	
	C9806	F1G1H101A731	C 100PF 50V	1	
	C9807	F1G1H201A731	C 200 PF, 50V	1	
	C9809	F1G1H102A730	C 1000PF 50V	1	
	C9811	F1G1C104A116	C 0.1UF 16V	1	
	C9812	F1K1E106A136	C 10UF, 25V	1	
	C9813	F1K1E106A136	C 10UF, 25V	1	
	C9814	F1K0J226A008	C 22UF, 6.3V	1	
	C9815	F1K0J226A008	C 22UF, 6.3V	1	
	C9816	F1G1E103A123	C 0.01UF 25V	1	
	C9825	F1K0J226A008	C 22UF, 6.3V	1	
	C9900	F1G1E103A123	C 0.01UF 25V	1	
	CN0102	K1KA11A00178	11P CONNECTOR	1	
	D1002	EZJZ0V120JA	VARISTOR	1	
	D1003	EZJZ0V120JA	VARISTOR	1	
	D1004	EZAEG2A50AX	ESD SUPPRESSOR	1	
	D1005	EZAEG2A50AX	ESD SUPPRESSOR	1	
	D1006	EZAEG2A50AX	ESD SUPPRESSOR	1	
	D1007	EZAEG2A50AX	ESD SUPPRESSOR	1	
	D1008	EZAEG2A50AX	ESD SUPPRESSOR	1	
	D1009	EZAEG2A50AX	ESD SUPPRESSOR	1	
	D1010	EZAEG2A50AX	ESD SUPPRESSOR	1	
	D1107	B0JCCE000008	DIODE	1	
	D2014	B0ACCJ000048	DIODE	1	
	D2417	B0ACCJ000048	DIODE	1	
	D2520	B3AGB0000060	LED	1	
	D2521	B3AEA0000099	LED	1	
	D2780	B0BC01600013	ZENER DIODE	1	
	D2781	B0BC01600013	ZENER DIODE	1	
	D2782	B0BC01600013	ZENER DIODE	1	
	D2783	B0BC01600013	ZENER DIODE	1	
	D2801	B0JCME000092	DIODE	1	
	D2802	B0ADCJ000100	DIODE	1	

Safety	Ref. No.	Part No.	Part Name & Description	Pcs	Remarks
	D2803	B0ADCJ000100	DIODE	1	
	D2809	B0BC010A0007	ZENER DIODE	1	
	D2810	B0ACCJ000048	DIODE	1	
	D2811	DZ2J033M0L	ZENER DIODE	1	
	D3013	DZ2J140M0L	ZENER DIODE	1	PAVCCZ
	D3014	DZ2J140M0L	ZENER DIODE	1	PAVCCZ
	D3015	K7AAAY000006	PHOTO LINK	1	
	D3048	B0JCCE000008	DIODE	1	
	D3339	B0JCCE000008	DIODE	1	
	D4200	B0JCME000092	DIODE	1	
	D4702	B0ACCJ000048	DIODE	1	
	D4703	DZ2J056M0L	ZENER DIODE	1	
	D4704	B0JCCE000008	DIODE	1	
	D4719	B0ACCJ000048	DIODE	1	
	D4720	DZ2J056M0L	ZENER DIODE	1	
	D4721	B0JCCE000008	DIODE	1	
	D4735	B0ACCJ000048	DIODE	1	
	D4736	DZ2J056M0L	ZENER DIODE	1	
	D4737	B0JCCE000008	DIODE	1	
	D4770	B0ACCJ000048	DIODE	1	
	D4771	DZ2J056M0L	ZENER DIODE	1	
	D4772	B0JCCE000008	DIODE	1	
	D4785	B0ECKM000048	DIODE	1	
	D5250	B0ACCJ000048	DIODE	1	
	D5301	B0JCPG000030	DIODE	1	
	D5431	B0ADEJ000035	ZENER DIODE	1	
	D5432	B0ADEJ000035	ZENER DIODE	1	
	D5433	B0ADCJ000100	DIODE	1	
	D5434	B0ADCJ000100	DIODE	1	
	D5435	B0ADCJ000100	DIODE	1	
	D5436	B0ADCJ000100	DIODE	1	
	D5437	B0ADCJ000100	DIODE	1	
	D5439	DZ2J068M0L	ZENER DIODE	1	
	D5440	DZ2J120M0L	ZENER DIODE	1	
	D5441	DZ2J120M0L	ZENER DIODE	1	
	D5442	DZ2J068M0L	ZENER DIODE	1	
	D5443	DZ2J068M0L	ZENER DIODE	1	
	D5444	DZ2J068M0L	ZENER DIODE	1	
	D5445	DZ2J068M0L	ZENER DIODE	1	
	D5447	DZ2J068M0L	ZENER DIODE	1	
	D5448	DZ2J068M0L	ZENER DIODE	1	
	D5449	DZ2J068M0L	ZENER DIODE	1	
	D5450	B0ADCJ000100	DIODE	1	
	D5454	B0ADEJ000035	ZENER DIODE	1	
	D5470	B0ADEJ000035	ZENER DIODE	1	
	D5481	B0JCME000076	DIODE	1	
	D5482	B0ACCJ000048	DIODE	1	
	D5505	B0JCPD000026	DIODE	1	
	D5602	DZ2J056M0L	ZENER DIODE	1	
	D5603	B0JCPG000030	DIODE	1	
	D5605	B0ECKM000048	DIODE	1	
	D6700	B0JCPD000021	DIODE	1	
	D6701	B0JCMD000010	DIODE	1	
	D6702	B0JCMD000010	DIODE	1	
	D6703	B0ECKP000002	DIODE	1	
	D6705	B0JCPD000021	DIODE	1	
	D6706	B0BC4R700007	ZENER DIODE	1	
	D6707	B0BC4R700007	ZENER DIODE	1	
	D6708	B0ECKP000002	DIODE	1	
	D6709	B0ECKP000002	DIODE	1	
	D6710	B0BC4R700007	ZENER DIODE	1	
	D6711	B0BC6R600005	ZENER DIODE	1	
	D6712	B0BC6R600005	ZENER DIODE	1	
	D6713	B0JCND000009	DIODE	1	
	D6714	B0BC4R700007	ZENER DIODE	1	
	D9104	B0JCPG000030	DIODE	1	
	D9806	B0ADCJ000100	DIODE	1	
	D9807	B0ADCJ000100	DIODE	1	
	D9816	B0JCPG000030	DIODE	1	
	FL2759	FLJ1E104A148	C 0.1UF, 25V	1	
	FL8701	J0MAB0000140	LC FILTER	1	
	FL8702	J0MAB0000140	LC FILTER	1	

Safety	Ref. No.	Part No.	Part Name & Description	Pcs	Remarks
		IC1000	C1ZBZ0003775	IC	1
		IC1100	MN103SH9FPB1	IC	1
		IC1101	TVRR701AA	IC	1 PAVCCZ
		IC2301	C1AB00003230	IC	1
		IC2401	C1AB00003230	IC	1
		IC2780	COZBZ0001361	IC	1
		IC2801	C0DBAYY00462	IC	1
		IC2950	C0CBCAG00031	IC	1
		IC2952	C0DBGYY00281	IC	1
		IC3001	C1AB00003218	IC	1
		IC4200	C1AB00003310	IC	1
		IC4201	C0DBAYY00737	IC	1
		IC4204	C0DBGFF00004	IC	1
		IC4205	TVRR333	IC	1 PAVCCZ
		IC4206	C0DBGYY00892	IC	1
		IC4207	C0DBGFF00011	IC	1
		IC4211	C3ABSG000060	IC	1
		IC4212	C0DBAYY00462	IC	1
		IC4500	C1AB00003079	IC	1
		IC4701	C0DBGYY00578	IC	1
		IC5250	C0DBEYY00123	IC	1
		IC5251	C0CBCBC00227	IC	1
		IC5290	C0DBGYY00884	IC	1
		IC5302	C0DBAYY00755	IC	1
		IC5303	C0DBAYY00755	IC	1
		IC5470	C0EBM0000026	IC	1
		IC5481	C1ZBZ0004161	IC	1
		IC5500	C0DBAYY00715	IC	1
		IC5501	C0DBAYY00715	IC	1
		IC5603	C0DBFYY00049	IC	1
		IC5604	C0DBGYY00578	IC	1
		IC6700	C1AB00002948	IC	1 PAVCCZ
		IC6701	C0DBEYY00123	IC	1
		IC6702	C0DBAYY00462	IC	1
		IC8000	MN2WS0110C	IC	1
		IC8100	C1ZBZ0003967	IC	1
		IC8240	C3ABTY000025	IC	1
		IC8241	C3ABTY000025	IC	1
		IC8300	C1AB00003188	IC	1
		IC8302	C0DBFYY00041	IC	1
		IC8360	C0JBAR000566	IC	1 PAVCCZ
		IC8361	C0JBAR000566	IC	1 PAVCCZ
		IC8362	C0JBAR000566	IC	1 PAVCCZ
		IC8400	C1AB00003193	IC	1 PAVCCZ
		IC8401	C1AB00002913	IC	1 PAVCCZ
		IC8402	COZBZ0001584	IC	1 PAVCCZ
		IC8701	C0DBZYY00365	IC	1
		IC8703	C1CB00003239	IC	1
		IC8921	TVRR329	IC	1 PAVCCZ
		IC8950	TVRR369	IC	1 PAVCCZ
		IC9300	C1AB00003258	IC	1
		IC9304	TVRR382	IC	1 PAVCCZ
		IC9400	C0JBAZ002692	IC	1
		IC9401	C0JBAZ002692	IC	1
		IC9402	C0JBAZ002692	IC	1
		IC9800	C0DBAYY00605	IC	1
		IC9801	C0DBAYY00462	IC	1
		IC9803	C0DBAYY00462	IC	1
		JK2780	K4AK03A00001	JACK	1 PAVCCZ
		JK3001	K1FY315A0008	CONNECTOR	1
		JK3002	K1FY242A0001	CONNECTOR	1 PAVCCZ
		JK3100A	K2HA710A0001	JACK	1 PAVCCZ
		JK3707	K4AK13B00007	TERMINAL BOARD	1 PAVCCZ
		JK4700	K1FY119D0011	CONNECTOR	1
		JK4701	K1FY119D0011	CONNECTOR	1
		JK4702	K1FY119D0011	CONNECTOR	1
		JK4703	K1FY119E0016	CONNECTOR	1 PAVCCZ
		JK8301	K2LC1YYA0005	JACK	1
		JK8401A	K1NA68B00054	68P CONNECTOR	1 PAVCCZ
		JK8700	K1FY208B0008	CONNECTOR	1

Safety	Ref. No.	Part No.	Part Name & Description	Pcs	Remarks
	JK8850	K1NA12E00017	SD CARD CONNecTOR	1	
	JS6700	D0GAR00Z0001	M 0 OHM, 1/16W	1	
	K1	K1KA11B00092	11P CONNECTOR	1	
	L1100	J0JYC0000068	CHIP INDUCTOR	1	
	L2106	J0ZZB0000097	FILTER	1	
	L2107	J0ZZB0000097	FILTER	1	
	L2301	J0JHC0000045	CHIP INDUCTOR	1	
	L2302	G1C3R0ZA0156	INDUCTION COIL	1	
	L2303	G1C220MA0416	INDUCTION COIL	1	
	L2304	G1C220MA0416	INDUCTION COIL	1	
	L2305	G1C220MA0416	INDUCTION COIL	1	
	L2306	G1C220MA0416	INDUCTION COIL	1	
	L2401	J0JHC0000045	CHIP INDUCTOR	1	
	L2403	G1C220MA0416	INDUCTION COIL	1	
	L2404	G1C220MA0416	INDUCTION COIL	1	
	L2803	G1C330MA0416	INDUCTION COIL	1	
	L2900	J0JCC0000278	CHIP INDUCTOR	1	
	L2901	J0JCC0000278	CHIP INDUCTOR	1	
	L2904	J0JCC0000278	CHIP INDUCTOR	1	
	L2905	J0JHC0000046	CHIP INDUCTOR	1	
	L2950	J0JHC0000045	CHIP INDUCTOR	1	
	L3002	J0JYC0000331	CHIP INDUCTOR	1	
	L3003	J0JYC0000331	CHIP INDUCTOR	1	
	L3004	J0JYC0000331	CHIP INDUCTOR	1	
	L3005	J0JYC0000331	CHIP INDUCTOR	1	
	L3006	J0JYC0000331	CHIP INDUCTOR	1	
	L3007	J0JYC0000331	CHIP INDUCTOR	1	
	L3008	J0JYC0000331	CHIP INDUCTOR	1	
	L3009	J0JYC0000331	CHIP INDUCTOR	1	
	L3010	J0JYC0000331	CHIP INDUCTOR	1	
	L3011	J0JYC0000331	CHIP INDUCTOR	1	
	L3014	J0JYC0000331	CHIP INDUCTOR	1	
	L3015	J0JYC0000331	CHIP INDUCTOR	1	
	L3017	J0JCC0000287	CHIP INDUCTOR	1	
	L3018	J0JCC0000287	CHIP INDUCTOR	1	
	L3020	J0JYC0000331	CHIP INDUCTOR	1	
	L3028	J0JCC0000287	CHIP INDUCTOR	1	
	L3029	J0JYC0000331	CHIP INDUCTOR	1	
	L3030	J0JYC0000331	CHIP INDUCTOR	1	
	L4205	J0JHC0000045	CHIP INDUCTOR	1	
	L4206	G1C100MA0077	INDUCTION COIL	1	
	L4207	G1C3R3Z00005	INDUCTION COIL	1	
	L4208	J0JHC0000045	CHIP INDUCTOR	1	
	L4209	J0JHC0000045	CHIP INDUCTOR	1	
	L4210	J0JHC0000045	CHIP INDUCTOR	1	
	L4211	J0JHC0000045	CHIP INDUCTOR	1	
	L4212	J0JHC0000045	CHIP INDUCTOR	1	
	L4213	J0JHC0000045	CHIP INDUCTOR	1	
	L4214	G1C100MA0077	INDUCTION COIL	1	
	L4215	J0JYC0000068	CHIP INDUCTOR	1	
	L4217	J0JHC0000045	CHIP INDUCTOR	1	
	L4218	J0JHC0000045	CHIP INDUCTOR	1	
	L4219	G1C150MA0416	INDUCTION COIL	1	
	L4700	J0JYC0000068	CHIP INDUCTOR	1	
	L4701	J0JYC0000068	CHIP INDUCTOR	1	
	L4702	J0JYC0000068	CHIP INDUCTOR	1	
	L4703	J0JYC0000068	CHIP INDUCTOR	1	
	L4704	J0JYC0000068	CHIP INDUCTOR	1	
	L4705	J0JYC0000068	CHIP INDUCTOR	1	
	L4706	J0JYC0000068	CHIP INDUCTOR	1	
	L4707	J0JYC0000068	CHIP INDUCTOR	1	
	L4708	J0JYC0000068	CHIP INDUCTOR	1	
	L4712	J0JHC0000045	CHIP INDUCTOR	1	
	L4715	J0JYC0000068	CHIP INDUCTOR	1	
	L4716	J0JYC0000068	CHIP INDUCTOR	1	
	L4717	J0JYC0000068	CHIP INDUCTOR	1	
	L5251	J0JCC0000278	CHIP INDUCTOR	1	
	L5301	G1C6R8MA0416	INDUCTION COIL	1	
	L5480	J0JYC0000068	CHIP INDUCTOR	1	

Safety	Ref. No.	Part No.	Part Name & Description	Pcs	Remarks
	L5500	G1C2R2M00022	INDUCTION COIL	1	
	L5501	G1C3R3Z00005	INDUCTION COIL	1	
	L5502	G1C2R2Z00007	INDUCTION COIL	1	
	L5503	G1C3R3Z00004	INDUCTION COIL	1	
	L5504	G1C100MA0077	INDUCTION COIL	1	
	L5505	G1C100MA0077	INDUCTION COIL	1	
	L5611	G1C6R8MA0416	INDUCTION COIL	1	
	L6700	G1C220MA0363	INDUCTION COIL	1	
	L6701	J0JJC0000015	CHIP INDUCTOR	1	
	L6702	G1C100MA0291	INDUCTION COIL	1	
	L6703	G1C4R7Z00014	INDUCTION COIL	1	
	L6704	G1C221ZA0037	INDUCTION COIL	1	PAVCCZ
	L6705	J0JJC0000015	CHIP INDUCTOR	1	
	L6706	J0JGC0000020	FILTER	1	
	L6707	J0JGC0000020	FILTER	1	
	L6708	J0JHC0000116	CHIP INDUCTOR	1	
	L8000	J0JCC0000287	CHIP INDUCTOR	1	
	L8001	J0JCC0000287	CHIP INDUCTOR	1	
	L8002	J0JCC0000287	CHIP INDUCTOR	1	
	L8003	J0JHC0000045	CHIP INDUCTOR	1	
	L8004	J0JHC0000021	CHIP INDUCTOR	1	
	L8005	J0JHC0000021	CHIP INDUCTOR	1	
	L8006	J0JCC0000287	CHIP INDUCTOR	1	
	L8007	J0JHC0000045	CHIP INDUCTOR	1	
	L8008	J0JCC0000287	CHIP INDUCTOR	1	
	L8009	J0JHC0000045	CHIP INDUCTOR	1	
	L8010	J0JCC0000287	CHIP INDUCTOR	1	
	L8011	J0JHC0000116	CHIP INDUCTOR	1	
	L8012	J0JCC0000287	CHIP INDUCTOR	1	
	L8013	J0JCC0000287	CHIP INDUCTOR	1	
	L8014	J0JCC0000287	CHIP INDUCTOR	1	
	L8015	J0JHC0000116	CHIP INDUCTOR	1	
	L8016	J0JHC0000116	CHIP INDUCTOR	1	
	L8017	J0JHC0000045	CHIP INDUCTOR	1	
	L8018	J0JHC0000045	CHIP INDUCTOR	1	
	L8019	J0JHC0000045	CHIP INDUCTOR	1	
	L8020	J0JCC0000287	CHIP INDUCTOR	1	
	L8021	J0JCC0000287	CHIP INDUCTOR	1	
	L8022	J0JHC0000045	CHIP INDUCTOR	1	
	L8023	J0JHC0000045	CHIP INDUCTOR	1	
	L8024	J0JCC0000287	CHIP INDUCTOR	1	
	L8100	J0JHC0000045	CHIP INDUCTOR	1	
	L8300	J0JHC0000045	CHIP INDUCTOR	1	
	L8302	J0JHC0000045	CHIP INDUCTOR	1	
	L8303	J0JHC0000045	CHIP INDUCTOR	1	
	L8304	J0JHC0000045	CHIP INDUCTOR	1	
	L8340	J0JDC0000002	CHIP INDUCTOR	1	
	L8341	K5H1622A0031	FUSE	1	
	L8342	D0GBR00Z0002	M 0 OHM J 1/10W	1	
	L8400	J0JHC0000045	CHIP INDUCTOR	1	
	L8401	J0JHC0000045	CHIP INDUCTOR	1	
	L8511	J0ZZB0000083	FILTER	1	
	L8512	J0ZZB0000083	FILTER	1	
	L8513	J0ZZB0000083	FILTER	1	
	L8701	J0JHC0000045	CHIP INDUCTOR	1	
	L8702	J0JHC0000045	CHIP INDUCTOR	1	
	L8705	J0JHC0000045	CHIP INDUCTOR	1	
	L8706	J0JHC0000045	CHIP INDUCTOR	1	
	L8707	J0JHC0000045	CHIP INDUCTOR	1	
	L8708	J0JHC0000045	CHIP INDUCTOR	1	
	L8850	J0JHC0000045	CHIP INDUCTOR	1	
	L8920	J0JDC0000002	CHIP INDUCTOR	1	
	L9000	G1C100MA0416	INDUCTION COIL	1	
	L9300	J0JHC0000117	CHIP INDUCTOR	1	
	L9301	J0JHC0000117	CHIP INDUCTOR	1	
	L9302	J0JHC0000117	CHIP INDUCTOR	1	
	L9800	G1C6R8Z00010	INDUCTION COIL	1	
	L9801	G1C100MA0416	INDUCTION COIL	1	
	△	PA4206	K5H4022A0031	FUSE	1
	△	PA5610	K5H4022A0031	FUSE	1
	△	PA6700	K5H1022A0031	FUSE	1

Safety	Ref. No.	Part No.	Part Name & Description	Pcs	Remarks
	Q2101	DSA200100L	TRANSISTOR	1	
	Q2109	DSA200100L	TRANSISTOR	1	
	Q2252	DSA200100L	TRANSISTOR	1	
	Q2253	B1AAF000002	TRANSISTOR	1	
	Q2254	B1AAF000002	TRANSISTOR	1	
	Q2255	DSC2001S0L	TRANSISTOR	1	
	Q2301	DSA200100L	TRANSISTOR	1	
	Q2510	DSC200100L	TRANSISTOR	1	
	Q2511	DSC200100L	TRANSISTOR	1	
	Q2512	DSC200100L	TRANSISTOR	1	
	Q2850	DSA200100L	TRANSISTOR	1	
	Q2851	DSC200100L	TRANSISTOR	1	
	Q3000	B1ABCF000231	TRANSISTOR	1	
	Q3001	B1ABCF000231	TRANSISTOR	1	
	Q3002	B1ABCF000231	TRANSISTOR	1	
	Q3003	B1ABCF000231	TRANSISTOR	1	
	Q3004	B1ABCF000231	TRANSISTOR	1	
	Q3005	B1ABCF000231	TRANSISTOR	1	
	Q3008	DSA200100L	TRANSISTOR	1	
	Q4201	B1MBEDA00015	FET	1	
	Q4204	DSC200100L	TRANSISTOR	1	
	Q4205	DSC200100L	TRANSISTOR	1	
	Q4512	B1HFCFA00026	TRANSISTOR	1	
	Q4513	DSA200100L	TRANSISTOR	1	
	Q4700	B1ABCF000231	TRANSISTOR	1	
	Q4701	B1ABCF000231	TRANSISTOR	1	
	Q4702	B1ABCF000231	TRANSISTOR	1	
	Q4703	B1ABCF000231	TRANSISTOR	1	
	Q4704	B1ABCF000231	TRANSISTOR	1	
	Q4705	B1ABCF000231	TRANSISTOR	1	
	Q4709	B1ABCF000231	TRANSISTOR	1	
	Q4710	B1ABCF000231	TRANSISTOR	1	
	Q5431	DSA200100L	TRANSISTOR	1	
	Q5432	DSC2001S0L	TRANSISTOR	1	
	Q5433	DSC2001S0L	TRANSISTOR	1	
	Q5434	DSC2001S0L	TRANSISTOR	1	
	Q5435	DSA200100L	TRANSISTOR	1	
	Q5436	DSC200100L	TRANSISTOR	1	
	Q5475	DSC2001S0L	TRANSISTOR	1	
	Q5476	B1ABCF000231	TRANSISTOR	1	
	Q5478	DSC200100L	TRANSISTOR	1	
	Q5500	B1MBDDA00003	FET	1	
	Q5501	B1CFRD000048	FET	1	
	Q5502	B1MBDDA00003	FET	1	
	Q5503	B1MBEDA00015	FET	1	
	Q5504	B1CFRD000048	FET	1	
	Q5602	DSC2001S0L	TRANSISTOR	1	
	Q5603	DSC2001S0L	TRANSISTOR	1	
	Q8400	DSC200100L	TRANSISTOR	1	
	Q8401	DSC200100L	TRANSISTOR	1	
	Q9005	DSC200100L	TRANSISTOR	1	
	Q9006	DSC200100L	TRANSISTOR	1	
	Q9900	DSC200100L	TRANSISTOR	1	
	Q9901	DSC200100L	TRANSISTOR	1	
	R0180	D0GA101JA015	M 100 OHM, J,1/16W	1	
	R0907	EXB28V103JX	M 10KOHM 1/32 W	1	
	R0908	ERJ2GEJ103	M 10KOHM, J,1/16 W	1	
	R0913	ERJ2GEJ220	M 22 OHM, J,1/16 W	1	
	R0914	ERJ2GEJ220	M 22 OHM, J,1/16 W	1	
	R0915	D0GA472JA015	M 4.7KOHM, J,1/16W	1	
	R0916	D0GA472JA015	M 4.7KOHM, J,1/16W	1	
	R0917	ERJ2GEJ220	M 22 OHM, J,1/16 W	1	
	R0918	ERJ2GEJ220	M 22 OHM, J,1/16 W	1	
	R0931	ERJ2GEJ220	M 22 OHM, J,1/16 W	1	

Safety	Ref. No.	Part No.	Part Name & Description	Pcs	Remarks
	R0932	ERJ2GEJ220	M 22 OHM, J,1/16 W	1	
	R0933	D0GAR00Z0001	M 0 OHM, 1/16W	1	
	R0934	D0GAR00Z0001	M 0 OHM, 1/16W	1	
	R0935	ERJ2GEJ220	M 22 OHM, J,1/16 W	1	
	R0936	ERJ2GEJ220	M 22 OHM, J,1/16 W	1	
	R0939	D0GAR00Z0001	M 0 OHM, 1/16W	1	
	R0947	D0GA680JA015	M 68 OHM, J,1/16W	1	
	R0948	D0GA680JA015	M 68 OHM, J,1/16W	1	
	R0949	D0GA680JA015	M 68 OHM, J,1/16W	1	
	R0950	D0GA680JA015	M 68 OHM, J,1/16W	1	
	R0951	D0GA680JA015	M 68 OHM, J,1/16W	1	
	R0952	D0GA680JA015	M 68 OHM, J,1/16W	1	
	R0953	D0GA101JA015	M 100 OHM, J,1/16W	1	
	R0954	D0GA101JA015	M 100 OHM, J,1/16W	1	
	R0955	D0GA222JA015	M 2.2KOHM, J,1/16W	1	
	R0956	D0GA222JA015	M 2.2KOHM, J,1/16W	1	
	R0957	D0GA332JA015	M 3.3KOHM, J,1/16W	1	
	R0958	D0GA332JA015	M 3.3KOHM, J,1/16W	1	
	R0959	D0GA222JA015	M 2.2KOHM, J,1/16W	1	
	R0960	D0GA222JA015	M 2.2KOHM, J,1/16W	1	
	R0962	D0GAR00Z0001	M 0 OHM, 1/16W	1	
	R0963	D0GAR00Z0001	M 0 OHM, 1/16W	1	
	R0971	ERJ2GEJ103	M 10KOHM, J,1/16 W	1	
	R0972	D0GAR00Z0001	M 0 OHM, 1/16W	1	
	R0973	D0GAR00Z0001	M 0 OHM, 1/16W	1	
	R0987	ERJ2GEJ103	M 10KOHM, J,1/16 W	1	
	R0988	D0GA272JA015	M 2.7KOHM, J.1/16W	1	
	R0989	D0GA272JA015	M 2.7KOHM, J.1/16W	1	
	R0993	ERJ2GEJ103	M 10KOHM, J,1/16 W	1	
	R1004	D0GBR00Z0002	M 0 OHM J 1/10W	1	
	R1010	D0GB103JA057	M 10K OHM J 1/10W	1	
	R1153	D0GA471JA015	M 470OHM, J,1/16W	1	
	R1163	D0GA105JA015	M 1M OHM, J,1/16W	1	
	R1182	D0GA273JA015	M 27K OHM J ,1/16W	1	
	R1203	D0GA473JA015	M 47KOHM, J,1/16W	1	
	R1209	D0GA472JA015	M 4.7KOHM, J,1/16W	1	
	R1221	D1BB7151A055	M7.15KOHM,J.1/10W	1	
	R1224	ERJ2GEJ103	M 10KOHM, J,1/16 W	1	
	R1225	ERJ2GEJ103	M 10KOHM, J,1/16 W	1	
	R1236	D0GA473JA015	M 47KOHM, J,1/16W	1	
	R1237	ERJ2GEJ102X	M 1KOHM, J.1/16 W	1	
	R1243	D0GA473JA015	M 47KOHM, J,1/16W	1	
	R1255	ERJ2GEJ102X	M 1KOHM, J.1/16 W	1	
	R1401	ERJ2GEJ104	M100KOHM, J,1/16 W	1	

Safety	Ref. No.	Part No.	Part Name & Description	Pcs	Remarks
	R1406	DOGA683JA015	M 68KOHM, J,1/16W	1	
	R1407	DOGA473JA015	M 47KOHM, J,1/16W	1	
	R1409	ERJ2GEJ103	M 10KOHM, J,1/16W	1	
	R1410	ERJ2GEJ103	M 10KOHM, J,1/16W	1	
	R1411	ERJ2GEJ104	M100KOHM, J,1/16W	1	
	R2053	D1BB1403A055	M 140KOHM,J,1/10W	1	
	R2055	D1BB1403A055	M 140KOHM,J,1/10W	1	
	R2069	ERJ2GEJ103	M 10KOHM, J,1/16W	1	
	R2070	ERJ2GEJ103	M 10KOHM, J,1/16W	1	
	R2101	DOGA332JA015	M 3.3KOHM, J,1/16W	1	
	R2102	DOGA472JA015	M 4.7KOHM, J,1/16W	1	
	R2103	ERJ2GEJ220	M 22 OHM, J,1/16W	1	
	R2104	DOGA122JA015	M 1.2KOHM, J,1/16W	1	
	R2107	D0GAR00Z0001	M 0 OHM, 1/16W	1	
	R2110	ERJ2GEJ220	M 22 OHM, J,1/16W	1	
	R2121	DOGA681JA015	M680 OHM, J,1/16W	1	
	R2135	ERJ2GEJ102X	M 1KOHM, J.1/16W	1	
	R2139	ERJ2GEJ221	M 220 OHM, J,1/16W	1	
	R2254	DOGA101JA015	M 100 OHM, J,1/16W	1	
	R2255	DOGA473JA015	M 47KOHM, J,1/16W	1	
	R2256	ERJ2GEJ103	M 10KOHM, J,1/16W	1	
	R2257	DOGA105JA015	M 1M OHM, J,1/16W	1	
	R2258	DOGA101JA015	M 100 OHM, J,1/16W	1	
	R2259	DOGA101JA015	M 100 OHM, J,1/16W	1	
	R2260	ERJ2GEJ103	M 10KOHM, J,1/16W	1	
	R2263	ERJ2GEJ103	M 10KOHM, J,1/16W	1	
	R2264	DOGA101JA015	M 100 OHM, J,1/16W	1	
	R2301	ERJ2GEJ103	M 10KOHM, J,1/16W	1	
	R2302	EXB28V220J	M 22 OHM 1/32 W	1	
	R2306	DOGA473JA015	M 47KOHM, J,1/16W	1	
	R2307	DOGA472JA015	M 4.7KOHM, J,1/16W	1	
	R2308	ERJ2GEJ221	M 220 OHM, J,1/16W	1	
	R2309	DOGA222JA015	M 2.2KOHM, J,1/16W	1	
	R2310	DOGA222JA015	M 2.2KOHM, J,1/16W	1	
	R2318	ERJ8GEYJ3R3V	M 3.3 OHM, J,1/4W	1	
	R2319	ERJ8GEYJ3R3V	M 3.3 OHM, J,1/4W	1	
	R2320	ERJ8GEYJ3R3V	M 3.3 OHM, J,1/4W	1	
	R2321	ERJ8GEYJ3R3V	M 3.3 OHM, J,1/4W	1	
	R2402	EXB28V220J	M 22 OHM 1/32 W	1	
	R2418	ERJ8GEYJ3R3V	M 3.3 OHM, J,1/4W	1	
	R2419	ERJ8GEYJ3R3V	M 3.3 OHM, J,1/4W	1	
	R2510	ERJ3GEYJ470	M 47 OHM, J,1/10W	1	

Safety	Ref. No.	Part No.	Part Name & Description	Pcs	Remarks
	R2511	D0GB104JA041	M 100KOHM J 1/10W	1	
	R2512	D0GB224JA041	M 220KOHM, J,1/10W	1	
	R2513	ERJ3GEYJ223	M 22KOHM, J,1/10W	1	
	R2514	D0GB103JA057	M 10K OHM J 1/10W	1	
	R2515	D0GB473JA057	M 47KOHM, J,1/10W	1	
	R2516	D1BB6800A055	M 680 OHM, J,1/10W	1	
	R2517	ERJ3GEYJ223	M 22KOHM, J,1/10W	1	
	R2518	D0GB473JA057	M 47KOHM, J,1/10W	1	
	R2519	D1BB1821A055	M1.82KOHM, J,1/10W	1	
	R2527	D1BB1000A055	M 100 OHM, J,1/10W	1	
	R2550	ERJ6ENF1432	M14.3KOHM, F,1/8W	1	
	R2551	ERJ6ENF6651	M6.65KOHM, F,1/8W	1	
	R2552	ERJ6ENF7151	M7.15KOHM, F,1/8W	1	
	R2553	ERJ6ENF1741	M1.74KOHM, F,1/8W	1	
	R2752	DOGA184JA015	M 180KOHM J.1/16W	1	
	R2753	D0GB102JA041	M 1KOHM, J,1/10W	1	
	R2780	DOGA101JA015	M 100 OHM, J,1/16W	1	
	R2781	ERJ3GEYJ101	M 100 OHM, J,1/10W	1	
	R2782	ERJ3GEYJ101	M 100 OHM, J,1/10W	1	
	R2783	ERJ3GEYJ101	M 100 OHM, J,1/10W	1	
	R2784	ERJ3GEYJ101	M 100 OHM, J,1/10W	1	
	R2785	ERJ6GEYJ101V	M 100 OHM, J,1/8W	1	
	R2786	ERJ6GEYJ101V	M 100 OHM, J,1/8W	1	
	R2788	D0GAR00Z0001	M 0 OHM, 1/16W	1	
	R2789	D0GAR00Z0001	M 0 OHM, 1/16W	1	
	R2801	DOGA390JA015	M 39 OHM, J,1/16W	1	
	R2802	DOGA562JA015	M 5.2KOHM, J,1/16W	1	
	R2803	D1BB1001A055	M 1KOHM, J. 1/10W	1	
	R2805	D1BB7501A055	M 7.5KOHM, J,1/10W	1	
	R2806	D1BB2490A055	M 249 OHM, J,1/10W	1	
	R2807	DOGA473JA015	M 47KOHM, J,1/16W	1	
	R2814	DOGA472JA015	M 4.7KOHM, J,1/16W	1	
	R2815	DOGA471JA015	M 470OHM, J,1/16W	1	
	R2816	DOGA473JA015	M 47KOHM, J,1/16W	1	
	R2818	ERJ2GEJ102X	M 1KOHM, J.1/16W	1	
	R2819	DOGA473JA015	M 47KOHM, J,1/16W	1	
	R2824	DOGA101JA015	M 100 OHM, J,1/16W	1	
	R2826	DOGA101JA015	M 100 OHM, J,1/16W	1	
	R2828	DOGA101JA015	M 100 OHM, J,1/16W	1	
	R2830	DOGA473JA015	M 47KOHM, J,1/16W	1	
	R2831	DOGA473JA015	M 47KOHM, J,1/16W	1	
	R2834	DOGA101JA015	M 100 OHM, J,1/16W	1	
	R2835	DOGA101JA015	M 100 OHM, J,1/16W	1	
	R2850	ERJ3GEYJ101	M 100 OHM, J,1/10W	1	
	R2851	ERJ3GEYJ223	M 22KOHM, J,1/10W	1	
	R2853	D0GB102JA041	M 1KOHM, J,1/10W	1	
	R2854	D0GB104JA041	M 100KOHM J 1/10W	1	

Safety	Ref. No.	Part No.	Part Name & Description	Pcs	Remarks
	R2855	D0GB102JA041	M 1KOHM,J,1/10W	1	
	R2856	EXB28V472JX	RESISTOR ARRAY	1	
	R2907	DOGAR00Z0001	M 0 OHM, 1/16W	1	
	R2914	ERJ2GEJ103	M 10KOHM, J,1/16 W	1	
	R2918	DOGAR00Z0001	M 0 OHM, 1/16W	1	
	R2926	DOGA680JA015	M 68 OHM, J,1/16W	1	
	R2930	DOGA153JA015	M 15K OHM J 1/16W	1	
	R2959	DOGBR00Z0002	M 0 OHM J 1/10W	1	
	R2960	ERJ2GEJ103	M 10KOHM, J,1/16 W	1	
	R2961	DOGBR00Z0002	M 0 OHM J 1/10W	1	
	R3000	DOGA223JA015	M 22K OHM J 1/16W	1	
	R3001	DOGA223JA015	M 22K OHM J 1/16W	1	
	R3002	DOGA223JA015	M 22K OHM J 1/16W	1	
	R3003	DOGA223JA015	M 22K OHM J 1/16W	1	
	R3004	DOGA223JA015	M 22K OHM J 1/16W	1	
	R3005	DOGA223JA015	M 22K OHM J 1/16W	1	
	R3006	ERJ2GEJ104	M100KOHM, J,1/16 W	1	
	R3007	ERJ2GEJ104	M100KOHM, J,1/16 W	1	
	R3008	DOGA222JA015	M 2.2KOHM, J,1/16W	1	
	R3009	DOGA222JA015	M 2.2KOHM, J,1/16W	1	
	R3010	ERJ2GEJ104	M100KOHM, J,1/16 W	1	
	R3011	ERJ2GEJ104	M100KOHM, J,1/16 W	1	
	R3012	DOGA222JA015	M 2.2KOHM, J,1/16W	1	
	R3013	DOGA222JA015	M 2.2KOHM, J,1/16W	1	
	R3017	DOGAR00Z0001	M 0 OHM, 1/16W	1	
	R3019	DOGA222JA015	M 2.2KOHM, J,1/16W	1	
	R3021	DOGA222JA015	M 2.2KOHM, J,1/16W	1	
	R3024	ERJ2GEJ104	M100KOHM, J,1/16 W	1	
	R3025	ERJ2GEJ104	M100KOHM, J,1/16 W	1	
	R3028	DOGA331JA015	M 330 OHM, J,1/16W	1	
	R3029	DOGA331JA015	M 330 OHM, J,1/16W	1	
	R3030	DOGA101JA015	M 100 OHM, J,1/16W	1	
	R3041	DOGA331JA015	M 330 OHM, J,1/16W	1	
	R3042	DOGA331JA015	M 330 OHM, J,1/16W	1	
	R3072	ERJ6ENF1500	M 150 OHM.F.1/8W	1	
	R3073	ERJ6ENF1500	M 150 OHM.F.1/8W	1	
	R3074	ERJ6ENF1500	M 150 OHM.F.1/8W	1	
	R3075	ERJ6ENF1500	M 150 OHM.F.1/8W	1	
	R3076	ERJ6ENF1500	M 150 OHM.F.1/8W	1	
	R3077	ERJ6ENF1500	M 150 OHM.F.1/8W	1	
	R3079	ERJ6ENF1500	M 150 OHM.F.1/8W	1	
	R3081	ERJ6ENF1500	M 150 OHM.F.1/8W	1	
	R3082	ERJ6ENF1500	M 150 OHM.F.1/8W	1	
	R3083	ERJ6ENF1500	M 150 OHM.F.1/8W	1	
	R3084	ERJ6RED750	M 75 OHM,.D1/10W	1	
	R3085	ERJ6RED750	M 75 OHM,.D1/10W	1	
	R3086	ERJ6RED750	M 75 OHM,.D1/10W	1	
	R3087	ERJ6ENF1500	M 150 OHM.F.1/8W	1	
	R3089	DOGA680JA015	M 68 OHM, J,1/16W	1	
	R3091	D1BA2152A014	M21.5KOHM,J.1/16 W	1	PAVCCZ

Safety	Ref. No.	Part No.	Part Name & Description	Pcs	Remarks
	R3092	D1BA2152A014	M21.5KOHM,J.1/16 W	1	PAVCCZ
	R3094	D1BA1302A014	M 13KOHM,J.1/16 W	1	
	R3097	ERJ6ENF1500	M 150 OHM.F.1/8W	1	
	R3098	ERJ6ENF1500	M 150 OHM.F.1/8W	1	
	R3100	ERJ2GEJ104	M100KOHM, J,1/16 W	1	
	R3102	ERJ6ENF1500	M 150 OHM.F.1/8W	1	
	R3104	ERJ6ENF1500	M 150 OHM.F.1/8W	1	
	R3106	DOGA273JA015	M 27K OHM J ,1/16W	1	
	R3108	DOGA273JA015	M 27K OHM J ,1/16W	1	
	R3112	DOGAR00Z0001	M 0 OHM, 1/16W	1	
	R3113	DOGAR00Z0001	M 0 OHM, 1/16W	1	
	R3115	ERJ2GEJ221	M 220 OHM, J,1/16 W	1	
	R3116	ERJ2GEJ221	M 220 OHM, J,1/16 W	1	
	R3117	ERJ2GEJ221	M 220 OHM, J,1/16 W	1	
	R3118	ERJ2GEJ221	M 220 OHM, J,1/16 W	1	
	R3120	DOGA331JA015	M 330 OHM, J,1/16W	1	
	R3121	EXB28V221JX	M 220 OHM 1/32 W	1	
	R3123	EXB28V680JX	M 68 OHM 1/32 W	1	
	R3128	ERJ2GEJ221	M 220 OHM, J,1/16 W	1	
	R3143	DOGA680JA015	M 68 OHM, J,1/16W	1	
	R3146	DOGA331JA015	M 330 OHM, J,1/16W	1	
	R3150	DOGA680JA015	M 68 OHM, J,1/16W	1	
	R3153	DOGA680JA015	M 68 OHM, J,1/16W	1	
	R3154	EXB28V221JX	M 220 OHM 1/32 W	1	
	R3157	EXB28V221JX	M 220 OHM 1/32 W	1	
	R3167	ERJ6RED750	M 75 OHM,.D1/10W	1	
	R3169	ERJ2GEJ104	M100KOHM, J,1/16 W	1	
	R3172	ERJ6RED750	M 75 OHM,.D1/10W	1	
	R3173	EXB28V221JX	M 220 OHM 1/32 W	1	
	R3174	ERJ2GEJ104	M100KOHM, J,1/16 W	1	
	R3182	D1BA1302A014	M 13KOHM,J.1/16 W	1	
	R3187	ERJ6ENF1500	M 150 OHM.F.1/8W	1	
	R3188	ERJ6ENF1500	M 150 OHM.F.1/8W	1	
	R3189	DOGA680JA015	M 68 OHM, J,1/16W	1	
	R3192	EXB28V820JX	M 82 OHM 1/32 W	1	
	R3193	ERJ6ENF1500	M 150 OHM.F.1/8W	1	
	R3198	ERJ6ENF1500	M 150 OHM.F.1/8W	1	
	R3204	ERJ6ENF1500	M 150 OHM.F.1/8W	1	
	R3205	ERJ6ENF1500	M 150 OHM.F.1/8W	1	
	R3206	ERJ2GEJ220	M 22 OHM, J,1/16 W	1	
	R3207	ERJ2GEJ220	M 22 OHM, J,1/16 W	1	
	R3213	ERJ6ENF1500	M 150 OHM.F.1/8W	1	
	R3222	DOGAR00Z0001	M 0 OHM, 1/16W	1	
	R3224	DOGAR00Z0001	M 0 OHM, 1/16W	1	
	R3226	DOGA472JA015	M 4.7KOHM, J,1/16W	1	
	R3227	DOGA472JA015	M 4.7KOHM, J,1/16W	1	
	R3230	ERJ6RED750	M 75 OHM,.D1/10W	1	
	R3231	DOGAR00Z0001	M 0 OHM, 1/16W	1	
	R3232	ERJ6RED750	M 75 OHM,.D1/10W	1	
	R3233	DOGAR00Z0001	M 0 OHM, 1/16W	1	
	R3234	ERJ6RED750	M 75 OHM,.D1/10W	1	
	R3235	DOGAR00Z0001	M 0 OHM, 1/16W	1	
	R3236	DOGA680JA015	M 68 OHM, J,1/16W	1	

Safety	Ref. No.	Part No.	Part Name & Description	Pcs	Remarks
	R3237	DOGA680JA015	M 68 OHM, J,1/16W	1	
	R3240	ERJ2GEJ221	M 220 OHM, J,1/16 W	1	
	R3245	ERJ2GEJ221	M 220 OHM, J,1/16 W	1	
	R3287	DOGA473JA015	M 47KOHM, J,1/16W	1	
	R3288	DOGA473JA015	M 47KOHM, J,1/16W	1	
	R3290	DOGA473JA015	M 47KOHM, J,1/16W	1	
	R3291	DOGA473JA015	M 47KOHM, J,1/16W	1	
	R3292	DOGA105JA015	M 1M OHM, J,1/16W	1	
	R3293	EZAEG2A50AX	ESD SUPPRESSOR	1	
	R3716	DOGA223JA015	M 22K OHM J 1/16W	1	
	R3717	DOGA223JA015	M 22K OHM J 1/16W	1	
	R4200	DOGA2R2JA014	M 2.2OHM, J,1/16W	1	
	R4207	DOGA223JA015	M 22K OHM J 1/16W	1	
	R4208	DOGA683JA015	M 68KOHM, J,1/16W	1	
	R4222	ERJ2GEJ103	M 10KOHM, J,1/16W	1	
	R4223	D1BB4301A087	M4.3 KOHM,J.1/10W	1	
	R4224	D1BB1002A087	M 10KOHM,J.1/10W	1	
	R4225	D1BB1201A055	M 1.2KOHM,J.1/10W	1	
	R4227	D1BB2002A055	M 20KOHM,J.1/10W	1	
	R4228	D0GAR00Z0001	M 0 OHM, 1/16W	1	
	R4229	ERJ2GEJ102X	M 1KOHM, J.1/16W	1	
	R4230	D0GBR00Z0002	M 0 OHM J 1/10W	1	
	R4234	DOGA473JA015	M 47KOHM, J,1/16W	1	
	R4235	ERJ2GEJ103	M 10KOHM, J,1/16W	1	
	R4241	DOGA101JA015	M 100 OHM, J,1/16W	1	
	R4242	DOGA101JA015	M 100 OHM, J,1/16W	1	
	R4243	DOGA101JA015	M 100 OHM, J,1/16W	1	
	R4244	DOGA101JA015	M 100 OHM, J,1/16W	1	
	R4245	DOGA101JA015	M 100 OHM, J,1/16W	1	
	R4246	DOGA101JA015	M 100 OHM, J,1/16W	1	
	R4247	DOGA101JA015	M 100 OHM, J,1/16W	1	
	R4248	DOGA101JA015	M 100 OHM, J,1/16W	1	
	R4249	DOGA101JA015	M 100 OHM, J,1/16W	1	
	R4250	DOGA101JA015	M 100 OHM, J,1/16W	1	
	R4251	DOGA101JA015	M 100 OHM, J,1/16W	1	
	R4252	DOGA101JA015	M 100 OHM, J,1/16W	1	
	R4256	ERJ2GEJ220	M 22 OHM, J,1/16W	1	
	R4257	ERJ2GEJ220	M 22 OHM, J,1/16W	1	
	R4258	DOGA222JA015	M 2.2KOHM, J,1/16W	1	
	R4259	DOGA222JA015	M 2.2KOHM, J,1/16W	1	
	R4260	DOGA680JA015	M 68 OHM, J,1/16W	1	
	R4261	ERJ6GEYJ101V	M 100 OHM,J,1/8W	1	
	R4262	DOGA222JA015	M 2.2KOHM, J,1/16W	1	

Safety	Ref. No.	Part No.	Part Name & Description	Pcs	Remarks
	R4263	DOGA390JA015	M 39 OHM, J,1/16W	1	
	R4264	DOGA562JA015	M 5.2KOHM, J,1/16W	1	
	R4265	D1BB1001A055	M 1KOHM,J. 1/10W	1	
	R4266	D1BB3001A055	M 3.0KOHM,J.1/10W	1	
	R4267	D1BB1800A055	M180 OHM,J.1/10W	1	
	R4268	ERJ2GEJ102X	M 1KOHM, J.1/16W	1	
	R4269	DOGA473JA015	M 47KOHM, J,1/16W	1	
	R4313	D1BA1001A014	M 1KOHM,J. 1/16W	1	
	R4314	D1BA1001A014	M 1KOHM,J. 1/16W	1	
	R4315	ERJ2GEJ103	M 10KOHM, J,1/16W	1	
	R4316	ERJ2GEJ103	M 10KOHM, J,1/16W	1	
	R4317	ERJ2GEJ103	M 10KOHM, J,1/16W	1	
	R4318	DOGA331JA015	M 330 OHM, J,1/16W	1	
	R4320	DOGA330JA015	M 33 OHM, J,1/16W	1	
	R4321	DOGA330JA015	M 33 OHM, J,1/16W	1	
	R4322	DOGA330JA015	M 33 OHM, J,1/16W	1	
	R4323	DOGA330JA015	M 33 OHM, J,1/16W	1	
	R4324	DOGA330JA015	M 33 OHM, J,1/16W	1	
	R4325	DOGA330JA015	M 33 OHM, J,1/16W	1	
	R4326	DOGA330JA015	M 33 OHM, J,1/16W	1	
	R4327	DOGA330JA015	M 33 OHM, J,1/16W	1	
	R4328	DOGA330JA015	M 33 OHM, J,1/16W	1	
	R4329	DOGA330JA015	M 33 OHM, J,1/16W	1	
	R4330	DOGA330JA015	M 33 OHM, J,1/16W	1	
	R4331	DOGA330JA015	M 33 OHM, J,1/16W	1	
	R4332	DOGA330JA015	M 33 OHM, J,1/16W	1	
	R4333	DOGA330JA015	M 33 OHM, J,1/16W	1	
	R4334	DOGA330JA015	M 33 OHM, J,1/16W	1	
	R4335	DOGA330JA015	M 33 OHM, J,1/16W	1	
	R4336	DOGA330JA015	M 33 OHM, J,1/16W	1	
	R4337	DOGA330JA015	M 33 OHM, J,1/16W	1	
	R4338	DOGA330JA015	M 33 OHM, J,1/16W	1	
	R4339	DOGA330JA015	M 33 OHM, J,1/16W	1	
	R4340	DOGA330JA015	M 33 OHM, J,1/16W	1	
	R4341	DOGA330JA015	M 33 OHM, J,1/16W	1	
	R4342	DOGA680JA015	M 68 OHM, J,1/16W	1	
	R4344	D1BA1001A014	M 1KOHM,J. 1/16W	1	
	R4345	D1BA1001A014	M 1KOHM,J. 1/16W	1	
	R4346	DOGA330JA015	M 33 OHM, J,1/16W	1	
	R4347	DOGA330JA015	M 33 OHM, J,1/16W	1	
	R4548	ERJ2GEJ220	M 22 OHM, J,1/16W	1	

Safety	Ref. No.	Part No.	Part Name & Description	Pcs	Remarks
	R4549	D0GA151JA015	M 150 OHM, J,1/16W	1	
	R4550	D0GA151JA015	M 150 OHM, J,1/16W	1	
	R4551	D0GA151JA015	M 150 OHM, J,1/16W	1	
	R4552	D0GA560JA015	M 56 OHM, J,1/16W	1	
	R4553	ERJ2GEJ103	M 10KOHM, J,1/16W	1	
	R4554	ERJ2GEJ102X	M 1KOHM, J,1/16W	1	
	R4557	D0GAR00Z0001	M 0 OHM, 1/16W	1	
	R4563	ERJ2GEJ103	M 10KOHM, J,1/16W	1	
	R4597	D0GA152JA015	M 1.5KOHM, J,1/16W	1	
	R4598	D0GA152JA015	M 1.5KOHM, J,1/16W	1	
	R4599	D0GA473JA015	M 47KOHM, J,1/16W	1	
	R4651	ERJ2GEJ220	M 22 OHM, J,1/16W	1	
	R4655	ERJ2GEJ220	M 22 OHM, J,1/16W	1	
	R4659	ERJ2GEJ220	M 22 OHM, J,1/16W	1	
	R4663	ERJ2GEJ220	M 22 OHM, J,1/16W	1	
	R4666	D0GA330JA015	M 33 OHM, J,1/16W	1	
	R4668	D0GA330JA015	M 33 OHM, J,1/16W	1	
	R4670	D0GA330JA015	M 33 OHM, J,1/16W	1	
	R4672	D0GA330JA015	M 33 OHM, J,1/16W	1	
	R4676	ERJ2GEJ102X	M 1KOHM, J,1/16W	1	
	R4677	D0GA122JA015	M 1.2KOHM, J,1/16W	1	
	R4702	ERJ2GEJ103	M 10KOHM, J,1/16W	1	
	R4703	D0GA330JA015	M 33 OHM, J,1/16W	1	
	R4704	D0GA473JA015	M 47KOHM, J,1/16W	1	
	R4706	ERJ2GEJ103	M 10KOHM, J,1/16W	1	
	R4707	D0GA473JA015	M 47KOHM, J,1/16W	1	
	R4708	ERJ2GEJ103	M 10KOHM, J,1/16W	1	
	R4709	ERJ2GEJ103	M 10KOHM, J,1/16W	1	
	R4710	D0GA473JA015	M 47KOHM, J,1/16W	1	
	R4711	ERJ2GEJ102X	M 1KOHM, J,1/16W	1	
	R4712	D0GA473JA015	M 47KOHM, J,1/16W	1	
	R4715	ERJ2GEJ103	M 10KOHM, J,1/16W	1	
	R4716	D0GA330JA015	M 33 OHM, J,1/16W	1	
	R4717	D0GA473JA015	M 47KOHM, J,1/16W	1	
	R4719	ERJ2GEJ103	M 10KOHM, J,1/16W	1	
	R4720	D0GA473JA015	M 47KOHM, J,1/16W	1	
	R4721	ERJ2GEJ103	M 10KOHM, J,1/16W	1	
	R4722	ERJ2GEJ103	M 10KOHM, J,1/16W	1	
	R4723	D0GA473JA015	M 47KOHM, J,1/16W	1	
	R4724	ERJ2GEJ102X	M 1KOHM, J,1/16W	1	
	R4725	D0GA473JA015	M 47KOHM, J,1/16W	1	

Safety	Ref. No.	Part No.	Part Name & Description	Pcs	Remarks
	R4728	ERJ2GEJ103	M 10KOHM, J,1/16W	1	
	R4729	D0GA330JA015	M 33 OHM, J,1/16W	1	
	R4730	D0GA473JA015	M 47KOHM, J,1/16W	1	
	R4732	ERJ2GEJ103	M 10KOHM, J,1/16W	1	
	R4733	D0GA473JA015	M 47KOHM, J,1/16W	1	
	R4734	ERJ2GEJ103	M 10KOHM, J,1/16W	1	
	R4735	ERJ2GEJ103	M 10KOHM, J,1/16W	1	
	R4736	D0GA473JA015	M 47KOHM, J,1/16W	1	
	R4737	ERJ2GEJ102X	M 1KOHM, J,1/16W	1	
	R4738	D0GA473JA015	M 47KOHM, J,1/16W	1	
	R4739	ERJ2GEJ220	M 22 OHM, J,1/16W	1	
	R4740	D0GA680JA015	M 68 OHM, J,1/16W	1	
	R4741	D0GA680JA015	M 68 OHM, J,1/16W	1	
	R4742	D0GA680JA015	M 68 OHM, J,1/16W	1	
	R4743	D0GA680JA015	M 68 OHM, J,1/16W	1	
	R4744	D0GA680JA015	M 68 OHM, J,1/16W	1	
	R4745	D0GA680JA015	M 68 OHM, J,1/16W	1	
	R4748	D0GA680JA015	M 68 OHM, J,1/16W	1	
	R4749	D0GA680JA015	M 68 OHM, J,1/16W	1	
	R4750	D0GA680JA015	M 68 OHM, J,1/16W	1	
	R4751	D0GA680JA015	M 68 OHM, J,1/16W	1	
	R4762	D0GA680JA015	M 68 OHM, J,1/16W	1	
	R4763	ERJ2GEJ104	M100KOHM, J,1/16W	1	
	R4764	ERJ2GEJ104	M100KOHM, J,1/16W	1	
	R4765	D1BB4701A055	M 4.7KOHM, J,1/10W	1	
	R4767	ERJ2GEJ104	M100KOHM, J,1/16W	1	
	R4770	ERJ2GEJ104	M100KOHM, J,1/16W	1	
	R4771	ERJ2GEJ104	M100KOHM, J,1/16W	1	
	R4775	D1BA1001A014	M 1KOHM, J, 1/16W	1	
	R4776	D0GA680JA015	M 68 OHM, J,1/16W	1	
	R4777	D0GA680JA015	M 68 OHM, J,1/16W	1	
	R4778	D1BA1001A014	M 1KOHM, J, 1/16W	1	
	R4781	D0GA680JA015	M 68 OHM, J,1/16W	1	
	R4783	D0GA473JA015	M 47KOHM, J,1/16W	1	
	R4785	D0GA680JA015	M 68 OHM, J,1/16W	1	
	R4788	ERJ2GEJ103	M 10KOHM, J,1/16W	1	
	R4789	D0GA330JA015	M 33 OHM, J,1/16W	1	
	R4790	D0GA473JA015	M 47KOHM, J,1/16W	1	
	R4792	ERJ2GEJ103	M 10KOHM, J,1/16W	1	
	R4793	D0GA473JA015	M 47KOHM, J,1/16W	1	

Safety	Ref. No.	Part No.	Part Name & Description	Pcs	Remarks
	R4794	ERJ2GEJ103	M 10KOHM, J,1/16 W	1	
	R4795	ERJ2GEJ103	M 10KOHM, J,1/16 W	1	
	R4796	DOGA473JA015	M 47KOHM, J,1/16W	1	
	R4797	ERJ2GEJ102X	M 1KOHM, J,1/16 W	1	
	R4798	DOGA473JA015	M 47KOHM, J,1/16W	1	
	R4799	DOGA680JA015	M 68 OHM, J,1/16W	1	
	R4824	DOGA473JA015	M 47KOHM, J,1/16W	1	
	R5155	DOGA101JA015	M 100 OHM, J,1/16W	1	
	R5253	ERJ2GEJ103	M 10KOHM, J,1/16 W	1	
	R5254	D1BA5361A014	M5.36KOHM,J.1/16 W	1	
	R5255	D1BA1001A014	M 1KOHM,J. 1/16 W	1	
	R5301	DOGA2R2JA014	M 2.2OHM, J,1/16W	1	
	R5307	D1BB1202A087	M 12KOHM,J.1/10W	1	
	R5308	D1BB2201A087	M 2.2KOHM,J.1/10W	1	
	R5309	D1BB5601A055	M 5.6KOHM,J.1/10W	1	
	R5312	DOGA150JA015	M 15 OHM, J,1/16W	1	
	R5315	DOGB102JA041	M 1KOHM,J,1/10W	1	
	R5412	DOGA273JA015	M 27K OHM J ,1/16W	1	
	R5413	ERJ2GEJ104	M100KOHM, J,1/16 W	1	
	R5418	ERJ2GEJ104	M100KOHM, J,1/16 W	1	
	R5419	DOGA683JA015	M 68KOHM, J,1/16W	1	
	R5420	DOGA273JA015	M 27K OHM J ,1/16W	1	
	R5421	ERJ2GEJ104	M100KOHM, J,1/16 W	1	
	R5422	DOGA683JA015	M 68KOHM, J,1/16W	1	
	R5423	ERJ2GEJ104	M100KOHM, J,1/16 W	1	
	R5424	DOGA683JA015	M 68KOHM, J,1/16W	1	
	R5431	DOGA222JA015	M 2.2KOHM, J,1/16W	1	
	R5432	DOGA332JA015	M 3.3KOHM, J,1/16W	1	
	R5433	ERJ2GEJ102X	M 1KOHM, J,1/16 W	1	
	R5434	ERJ2GEJ103	M 10KOHM, J,1/16 W	1	
	R5435	ERJ6GEYJ221V	M 220 OHM,J,1/8W	1	
	R5437	DOGA222JA015	M 2.2KOHM, J,1/16W	1	
	R5438	DOGA472JA015	M 4.7KOHM, J,1/16W	1	
	R5439	ERJ6GEYJ471	M 470 OHM,J,1/8W	1	
	R5441	ERJ2GEJ221	M 220 OHM, J,1/16 W	1	
	R5443	ERJ2GEJ221	M 220 OHM, J,1/16 W	1	
	R5444	ERJ2GEJ104	M100KOHM, J,1/16 W	1	
	R5445	ERJ2GEJ104	M100KOHM, J,1/16 W	1	
	R5451	ERJ6GEYJ102V	M 1K OHM J 1/8W	1	
	R5452	ERJ6GEYJ104V	M 100KOHM,J,1/8W	1	
	R5453	ERJ6GEYJ472V	M 4.7KOHM.J.1/8W	1	
	R5454	ERJ6GEYJ472V	M 4.7KOHM.J.1/8W	1	
	R5455	ERJ6GEYJ472V	M 4.7KOHM.J.1/8W	1	
	R5456	ERJ6GEYJ472V	M 4.7KOHM.J.1/8W	1	
	R5457	DOGAR00Z0001	M 0 OHM, 1/16W	1	

Safety	Ref. No.	Part No.	Part Name & Description	Pcs	Remarks
	R5458	ERJ6GEYJ472V	M 4.7KOHM.J.1/8W	1	
	R5459	ERJ6GEYJ472V	M 4.7KOHM.J.1/8W	1	
	R5460	ERJ6GEYJ472V	M 4.7KOHM.J.1/8W	1	
	R5461	ERJ6GEYJ472V	M 4.7KOHM.J.1/8W	1	
	R5462	ERJ6GEYJ472V	M 4.7KOHM.J.1/8W	1	
	R5470	DOGA222JA015	M 2.2KOHM, J,1/16W	1	
	R5471	DOGA101JA015	M 100 OHM, J,1/16W	1	
	R5472	DOGA470JA015	M 47 OHM, J,1/16W	1	
	R5473	DOGA473JA015	M 47KOHM, J,1/16W	1	
	R5474	ERJ2GEJ103	M 10KOHM, J,1/16 W	1	
	R5475	DOGA123JA015	M 12K OHM J 1/16W	1	
	R5476	DOGA473JA015	M 47KOHM, J,1/16W	1	
	R5477	ERJ2GEJ103	M 10KOHM, J,1/16 W	1	
	R5478	DOGA473JA015	M 47KOHM, J,1/16W	1	
	R5479	DOGA822JA015	M8.2KOHM, J,1/16W	1	
	R5481	DOGA472JA015	M 4.7KOHM, J,1/16W	1	
	R5482	ERJ6GEYJ150V	M 15 OHM,J,1/8W	1	
	R5485	DOGA101JA015	M 100 OHM, J,1/16W	1	
	R5486	DOGA473JA015	M 47KOHM, J,1/16W	1	
	R5489	DOGAR00Z0001	M 0 OHM, 1/16W	1	
	R5493	ERJ2GEJ103	M 10KOHM, J,1/16 W	1	
	R5504	D1BB1241A087	M1.24KOHM,J.1/10W	1	
	R5505	D1BB1241A087	M1.24KOHM,J.1/10W	1	
	R5506	D1BB2101A087	M 2.1KOHM,J.1/10W	1	
	R5507	D1BB1101A055	M 1.1 KOHM,J.1/10W	1	
	R5508	D1BB8200A087	M 820 OHM,J.1/10W	1	
	R5509	D1BB8200A087	M 820 OHM,J.1/10W	1	
	R5510	D1BB2001A087	M 2KOHM,J.1/10W	1	
	R5511	D1BB3601A055	M 3.6KOHM,J.1/10W	1	
	R5512	DOGB100JA041	M 10 OHM J 1/10W	1	
	R5513	DOGB100JA041	M 10 OHM J 1/10W	1	
	R5514	DOGB100JA041	M 10 OHM J 1/10W	1	
	R5515	DOGB100JA041	M 10 OHM J 1/10W	1	
	R5516	DOGAR00Z0001	M 0 OHM, 1/16W	1	
	R5517	D1BB1002A055	M 10KOHM,J.1/10W	1	
	R5518	DOGAR00Z0001	M 0 OHM, 1/16W	1	
	R5519	DOGAR00Z0001	M 0 OHM, 1/16W	1	
	R5520	D1BB1502A055	M 15KOHM, J.1/10W	1	
	R5521	DOGAR00Z0001	M 0 OHM, 1/16W	1	
	R5522	D1BB2002A055	M 20KOHM,J.1/10W	1	
	R5523	D1BB2402A055	M 24KOHM,J.1/10W	1	
	R5528	ERJ2GEJ103	M 10KOHM, J,1/16 W	1	
	R5540	ERJ6GEYJ472V	M 4.7KOHM.J.1/8W	1	
	R5571	DOGA683JA015	M 68KOHM, J,1/16W	1	
	R5600	DOGA680JA015	M 68 OHM, J,1/16W	1	
	R5603	DOGA2R2JA014	M 2.2OHM, J,1/16W	1	
	R5607	DOGA223JA015	M 22K OHM J 1/16W	1	
	R5608	DOGA683JA015	M 68KOHM, J,1/16W	1	
	R5609	ERJ2GEJ103	M 10KOHM, J,1/16 W	1	

Safety	Ref. No.	Part No.	Part Name & Description	Pcs	Remarks
	R5610	D0GA473JA015	M 47KOHM, J,1/16W	1	
	R5611	D0GA222JA015	M 2.2KOHM, J,1/16W	1	
	R5612	ERJ2GEJ103	M 10KOHM, J,1/16W	1	
	R5613	D0GA473JA015	M 47KOHM, J,1/16W	1	
	R5640	ERJ2GEJ103	M 10KOHM, J,1/16W	1	
	R5641	ERJ2GEJ103	M 10KOHM, J,1/16W	1	
	R5642	ERJ2GEJ104	M100KOHM, J,1/16W	1	
	R5643	ERJ2GEJ103	M 10KOHM, J,1/16W	1	
	R5644	D0GA752JA015	M7.5KOHM, J,1/16W	1	
	R5681	D1BB1002A055	M 10KOHM,J.1/10W	1	
	R5682	D1BB1501A055	M1.50KOHM,J.1/10W	1	
	R5683	D1BB6201A055	M6.20KOHM,J.1/10W	1	
	R5724	D0GA150JA015	M 15 OHM, J,1/16W	1	
	R6700	D0GBR00Z0002	M 0 OHM J 1/10W	1	
	R6701	D0GB103JA057	M 10K OHM J 1/10W	1	
	R6702	D0GB103JA057	M 10K OHM J 1/10W	1	
	R6703	ERJ3GEYJ470	M 47 OHM,J,1/10W	1	
	R6704	ERJ3GEYJ470	M 47 OHM,J,1/10W	1	
	R6705	D0GB163JA041	M 16K OHM J 1/10W	1	PAVCCZ
	R6706	D0GBR00Z0002	M 0 OHM J 1/10W	1	
	R6707	ERJ8GEYJ101V	M 100 OHM, J,1/4W	1	
	R6709	ERJ12YJ150	M 15 OHM,J, 1/2W	1	
	R6710	ERJ3GEYJ470	M 47 OHM,J,1/10W	1	
	R6711	ERJ3GEYJ470	M 47 OHM,J,1/10W	1	
	R6712	ERJ8GEYJ3R3V	M 3.3 OHM, J,1/4W	1	
	R6713	D1BA4702A014	M 47KOHM,J.1/16W	1	PAVCCZ
	R6714	D1BA1502A014	M 15KOHM,J.1/16W	1	PAVCCZ
	R6722	ERJ3GEYJ470	M 47 OHM,J,1/10W	1	
	R6723	D0GB104JA041	M 100KOHM J 1/10W	1	
	R6724	ERJ3GEYJ101	M 100 OHM,J,1/10W	1	
	R6725	D1BB1002A055	M 10KOHM,J.1/10W	1	
	R6726	D1BB2201A055	M 2.2KOHM,J.1/10W	1	
	R6727	D1BB4700A055	M 470 OHM,J.1/10W	1	
	R6728	ERJ8GEYJ100	M 10 OHM, J,1/4W	1	
	R6729	ERJ8GEYJ100	M 10 OHM, J,1/4W	1	
	R6730	D0GB392JA041	M 3.9KOHM,J,1/10W	1	
	R6739	D0GBR00Z0002	M 0 OHM J 1/10W	1	
	R6740	D0GBR00Z0002	M 0 OHM J 1/10W	1	
	R6741	D0GBR00Z0002	M 0 OHM J 1/10W	1	
	R6742	D0GBR00Z0002	M 0 OHM J 1/10W	1	
	R6743	D0GBR00Z0002	M 0 OHM J 1/10W	1	
	R6744	D0GBR00Z0002	M 0 OHM J 1/10W	1	
	R6745	D0GBR00Z0002	M 0 OHM J 1/10W	1	
	R6746	D0GBR00Z0002	M 0 OHM J 1/10W	1	
	R6747	D0GBR00Z0002	M 0 OHM J 1/10W	1	
	R6748	D0GBR00Z0002	M 0 OHM J 1/10W	1	
	R6749	D0GBR00Z0002	M 0 OHM J 1/10W	1	
	R6750	D0GB222JA041	M 2.2KOHM,J,1/10W	1	
	R6751	D0GB222JA041	M 2.2KOHM,J,1/10W	1	
	R6753	D0GBR00Z0002	M 0 OHM J 1/10W	1	
	R6754	D0GB2R2JA057	M 2.2OHM J 1/10W	1	
	R6757	D0GBR00Z0002	M 0 OHM J 1/10W	1	

Safety	Ref. No.	Part No.	Part Name & Description	Pcs	Remarks
	R6758	D0GB103JA057	M 10K OHM J 1/10W	1	
	R6759	D0GB680JA041	M 68 OHM J 1/10W	1	
	R6760	D0GB680JA041	M 68 OHM J 1/10W	1	
	R6761	D0GB680JA041	M 68 OHM J 1/10W	1	
	R6762	D0GB680JA041	M 68 OHM J 1/10W	1	
	R6763	D0GB680JA041	M 68 OHM J 1/10W	1	
	R6764	D0GB680JA041	M 68 OHM J 1/10W	1	
	R6765	D0GB680JA041	M 68 OHM J 1/10W	1	
	R6766	D0GB680JA041	M 68 OHM J 1/10W	1	
	R6767	D0GB330JA041	M 33 OHM J 1/10W	1	
	R6768	D0GB330JA041	M 33 OHM J 1/10W	1	
	R6769	ERJ3GEYJ470	M 47 OHM,J,1/10W	1	
	R8000	D0GA331JA015	M 330 OHM, J,1/16W	1	
	R8031	D0GA222JA015	M 2.2KOHM, J,1/16W	1	
	R8100	ERJ2GEJ221	M 220 OHM, J,1/16 W	1	
	R8102	ERJ2GEJ103	M 10KOHM, J,1/16W	1	
	R8103	ERJ2GEJ103	M 10KOHM, J,1/16W	1	
	R8105	D0GAR00Z0001	M 0 OHM, 1/16W	1	
	R8109	ERJ2GEJ103	M 10KOHM, J,1/16W	1	
	R8110	ERJ2GEJ103	M 10KOHM, J,1/16W	1	
	R8111	D0GA560JA015	M 56 OHM, J,1/16W	1	
	R8112	D0GA560JA015	M 56 OHM, J,1/16W	1	
	R8114	D0GA560JA015	M 56 OHM, J,1/16W	1	
	R8115	D0GA560JA015	M 56 OHM, J,1/16W	1	
	R8116	D0GA560JA015	M 56 OHM, J,1/16W	1	
	R8117	ERJ2GEJ104	M100KOHM, J,1/16W	1	
	R8119	ERJ2GEJ103	M 10KOHM, J,1/16W	1	
	R8120	D0GAR00Z0001	M 0 OHM, 1/16W	1	
	R8240	D1BA2400A014	M 240 OHM,J.1/16W	1	
	R8246	D0GA330JA015	M 33 OHM, J,1/16W	1	
	R8247	D0GA330JA015	M 33 OHM, J,1/16W	1	
	R8253	D1BA1001A014	M 1KOHM,J. 1/16W	1	
	R8254	D1BA1001A014	M 1KOHM,J. 1/16W	1	
	R8255	D1BA1001A014	M 1KOHM,J. 1/16W	1	
	R8270	D1BA1001A014	M 1KOHM,J. 1/16W	1	
	R8271	D1BA1001A014	M 1KOHM,J. 1/16W	1	
	R8272	D1BA1001A014	M 1KOHM,J. 1/16W	1	
	R8277	D1BA1001A014	M 1KOHM,J. 1/16W	1	
	R8278	D1BA1001A014	M 1KOHM,J. 1/16W	1	
	R8279	D1BA1001A014	M 1KOHM,J. 1/16W	1	
	R8280	D1BA1001A014	M 1KOHM,J. 1/16W	1	
	R8281	D1BA1001A014	M 1KOHM,J. 1/16W	1	
	R8282	D1BA1001A014	M 1KOHM,J. 1/16W	1	
	R8283	D1BA1001A014	M 1KOHM,J. 1/16W	1	
	R8284	D1BA1001A014	M 1KOHM,J. 1/16W	1	
	R8285	ERJ2GEJ221	M 220 OHM, J,1/16 W	1	

Safety	Ref. No.	Part No.	Part Name & Description	Pcs	Remarks
	R8286	ERJ2GEJ221	M 220 OHM, J,1/16 W	1	
	R8287	D1BA2400A014	M 240 OHM, J,1/16 W	1	
	R8288	D1BA2400A014	M 240 OHM, J,1/16 W	1	
	R8289	ERJ2GEJ103	M 10KOHM, J,1/16 W	1	
	R8300	EXB2HV680J	M 68 OHM 1/16 W	1	
	R8301	ERJ2GEJ103	M 10KOHM, J,1/16 W	1	
	R8302	DOGA471JA015	M 470OHM, J,1/16W	1	
	R8303	DOGA680JA015	M 68 OHM, J,1/16W	1	
	R8304	DOGA680JA015	M 68 OHM, J,1/16W	1	
	R8305	DOGA680JA015	M 68 OHM, J,1/16W	1	
	R8306	DOGA680JA015	M 68 OHM, J,1/16W	1	
	R8309	DOGA222JA015	M 2.2KOHM, J,1/16W	1	
	R8310	DOGA680JA015	M 68 OHM, J,1/16W	1	
	R8315	DOGAR00Z0001	M 0 OHM, 1/16W	1	
	R8316	DOGAR00Z0001	M 0 OHM, 1/16W	1	
	R8322	DOGAR00Z0001	M 0 OHM, 1/16W	1	
	R8323	DOGAR00Z0001	M 0 OHM, 1/16W	1	
	R8324	DOGA561JA015	M 560OHM, J,1/16W	1	
	R8325	DOGA561JA015	M 560OHM, J,1/16W	1	
	R8326	DOGA472JA015	M 4.7KOHM, J,1/16W	1	
	R8327	DOGA472JA015	M 4.7KOHM, J,1/16W	1	
	R8340	EXB2HV680J	M 68 OHM 1/16 W	1	
	R8341	DOGA680JA015	M 68 OHM, J,1/16W	1	
	R8342	DOGA680JA015	M 68 OHM, J,1/16W	1	
	R8343	DOGA680JA015	M 68 OHM, J,1/16W	1	
	R8344	DOGA680JA015	M 68 OHM, J,1/16W	1	
	R8346	EXB28V680JX	M 68 OHM 1/32 W	1	
	R8347	EXB2HV103JV	M 10 kOHM 1/16 W	1	
	R8348	EXB28V103JX	M 10KOHM 1/32 W	1	
	R8349	ERJ2GEJ103	M 10KOHM, J,1/16 W	1	
	R8350	ERJ2GEJ103	M 10KOHM, J,1/16 W	1	
	R8351	ERJ2GEJ103	M 10KOHM, J,1/16 W	1	
	R8355	DOGA680JA015	M 68 OHM, J,1/16W	1	
	R8356	DOGA680JA015	M 68 OHM, J,1/16W	1	
	R8357	DOGA680JA015	M 68 OHM, J,1/16W	1	
	R8358	DOGA680JA015	M 68 OHM, J,1/16W	1	
	R8371	DOGAR00Z0001	M 0 OHM, 1/16W	1	
	R8372	DOGAR00Z0001	M 0 OHM, 1/16W	1	
	R8373	DOGAR00Z0001	M 0 OHM, 1/16W	1	
	R8374	DOGAR00Z0001	M 0 OHM, 1/16W	1	
	R8375	DOGAR00Z0001	M 0 OHM, 1/16W	1	
	R8376	DOGA680JA015	M 68 OHM, J,1/16W	1	
	R8377	DOGA680JA015	M 68 OHM, J,1/16W	1	
	R8378	DOGA680JA015	M 68 OHM, J,1/16W	1	
	R8379	DOGA680JA015	M 68 OHM, J,1/16W	1	
	R8380	DOGA680JA015	M 68 OHM, J,1/16W	1	

Safety	Ref. No.	Part No.	Part Name & Description	Pcs	Remarks
	R8381	D1BA75R0A014	M 75 OHM, J,1/16 W	1	
	R8382	D1BA75R0A014	M 75 OHM, J,1/16 W	1	
	R8383	D1BA75R0A014	M 75 OHM, J,1/16 W	1	
	R8384	D1BA75R0A014	M 75 OHM, J,1/16 W	1	
	R8385	DOGA680JA015	M 68 OHM, J,1/16W	1	
	R8386	DOGA680JA015	M 68 OHM, J,1/16W	1	
	R8387	DOGAR00Z0001	M 0 OHM, 1/16W	1	
	R8388	DOGAR00Z0001	M 0 OHM, 1/16W	1	
	R8389	DOGAR00Z0001	M 0 OHM, 1/16W	1	
	R8390	DOGAR00Z0001	M 0 OHM, 1/16W	1	
	R8391	DOGAR00Z0001	M 0 OHM, 1/16W	1	
	R8392	DOGAR00Z0001	M 0 OHM, 1/16W	1	
	R8393	ERJ2GEJ103	M 10KOHM, J,1/16 W	1	
	R8394	ERJ2GEJ103	M 10KOHM, J,1/16 W	1	
	R8395	ERJ2GEJ103	M 10KOHM, J,1/16 W	1	
	R8396	ERJ2GEJ103	M 10KOHM, J,1/16 W	1	
	R8397	EXB2HV103JV	M 10 kOHM 1/16 W	1	
	R8404	EXB2HV680J	M 68 OHM 1/16 W	1	
	R8406	DOGA680JA015	M 68 OHM, J,1/16W	1	
	R8407	DOGA680JA015	M 68 OHM, J,1/16W	1	
	R8408	DOGA680JA015	M 68 OHM, J,1/16W	1	
	R8409	DOGA680JA015	M 68 OHM, J,1/16W	1	
	R8410	DOGA680JA015	M 68 OHM, J,1/16W	1	
	R8411	DOGA680JA015	M 68 OHM, J,1/16W	1	
	R8412	DOGA680JA015	M 68 OHM, J,1/16W	1	
	R8413	DOGA680JA015	M 68 OHM, J,1/16W	1	
	R8414	EXB28V151J	M 150 OHM 1/32 W	1	
	R8415	EXB28V104JX	RESISTOR ARRAY	1	
	R8416	EXB28V151J	M 150 OHM 1/32 W	1	
	R8417	EXB28V104JX	RESISTOR ARRAY	1	
	R8419	EXB2HV101J	RESISTOR ARRAY	1	
	R8420	EXB2HV101J	RESISTOR ARRAY	1	
	R8422	EXB2HV680J	M 68 OHM 1/16 W	1	
	R8423	EXB2HV680J	M 68 OHM 1/16 W	1	
	R8424	EXB28V680JX	M 68 OHM 1/32 W	1	
	R8425	DOGA680JA015	M 68 OHM, J,1/16W	1	
	R8426	DOGA680JA015	M 68 OHM, J,1/16W	1	
	R8428	DOGA222JA015	M 2.2KOHM, J,1/16W	1	
	R8429	DOGA473JA015	M 47KOHM, J,1/16W	1	
	R8430	DOGA473JA015	M 47KOHM, J,1/16W	1	
	R8431	ERJ2GEJ103	M 10KOHM, J,1/16 W	1	
	R8432	ERJ2GEJ103	M 10KOHM, J,1/16 W	1	
	R8433	ERJ8RSJR10	M 1 OHM, 1/8W	1	
	R8434	DOGA473JA015	M 47KOHM, J,1/16W	1	
	R8436	DOGA223JA015	M 22K OHM J 1/16W	1	
	R8437	DOGA223JA015	M 22K OHM J 1/16W	1	
	R8438	ERJ2GEJ103	M 10KOHM, J,1/16 W	1	
	R8439	DOGA223JA015	M 22K OHM J 1/16W	1	

Safety	Ref. No.	Part No.	Part Name & Description	Pcs	Remarks
	R8440	ERJ2GEJ104	M100KOHM, J,1/16 W	1	
	R8441	DOGA681JA015	M680 OHM, J,1/16W	1	
	R8442	DOGA680JA015	M 68 OHM, J,1/16W	1	
	R8443	DOGA680JA015	M 68 OHM, J,1/16W	1	
	R8444	DOGA680JA015	M 68 OHM, J,1/16W	1	
	R8445	DOGA680JA015	M 68 OHM, J,1/16W	1	
	R8446	DOGA680JA015	M 68 OHM, J,1/16W	1	
	R8447	DOGA151JA015	M 150 OHM, J,1/16W	1	
	R8448	DOGA151JA015	M 150 OHM, J,1/16W	1	
	R8449	DOGA151JA015	M 150 OHM, J,1/16W	1	
	R8450	DOGA473JA015	M 47KOHM, J,1/16W	1	
	R8451	ERJ2GEJ103	M 10KOHM, J,1/16 W	1	
	R8452	DOGA680JA015	M 68 OHM, J,1/16W	1	
	R8453	DOGA680JA015	M 68 OHM, J,1/16W	1	
	R8454	ERJ2GEJ104	M100KOHM, J,1/16 W	1	
	R8455	ERJ2GEJ104	M100KOHM, J,1/16 W	1	
	R8456	ERJ2GEJ104	M100KOHM, J,1/16 W	1	
	R8457	ERJ2GEJ103	M 10KOHM, J,1/16 W	1	
	R8458	DOGA473JA015	M 47KOHM, J,1/16W	1	
	R8459	DOGA473JA015	M 47KOHM, J,1/16W	1	
	R8460	DOGA680JA015	M 68 OHM, J,1/16W	1	
	R8461	DOGA680JA015	M 68 OHM, J,1/16W	1	
	R8462	DOGA680JA015	M 68 OHM, J,1/16W	1	
	R8463	DOGA680JA015	M 68 OHM, J,1/16W	1	
	R8464	DOGA680JA015	M 68 OHM, J,1/16W	1	
	R8465	DOGA680JA015	M 68 OHM, J,1/16W	1	
	R8466	ERJ2GEJ103	M 10KOHM, J,1/16 W	1	
	R8467	ERJ2GEJ103	M 10KOHM, J,1/16 W	1	
	R8468	EXB2HV680J	M 68 OHM 1/16 W	1	
	R8469	DOGA680JA015	M 68 OHM, J,1/16W	1	
	R8470	ERJ2GEJ103	M 10KOHM, J,1/16 W	1	
	R8471	ERJ2GEJ103	M 10KOHM, J,1/16 W	1	
	R8472	ERJ2GEJ103	M 10KOHM, J,1/16 W	1	
	R8473	DOGA222JA015	M 2.2KOHM, J,1/16W	1	
	R8474	DOGA222JA015	M 2.2KOHM, J,1/16W	1	
	R8480	DOGA680JA015	M 68 OHM, J,1/16W	1	
	R8481	DOGA223JA015	M 22K OHM J 1/16W	1	
	R8483	DOGA680JA015	M 68 OHM, J,1/16W	1	
	R8484	DOGA680JA015	M 68 OHM, J,1/16W	1	
	R8485	ERJ2GEJ103	M 10KOHM, J,1/16 W	1	
	R8488	DOGA680JA015	M 68 OHM, J,1/16W	1	

Safety	Ref. No.	Part No.	Part Name & Description	Pcs	Remarks
	R8489	DOGA680JA015	M 68 OHM, J,1/16W	1	
	R8490	DOGA680JA015	M 68 OHM, J,1/16W	1	
	R8491	DOGA680JA015	M 68 OHM, J,1/16W	1	
	R8492	DOGA680JA015	M 68 OHM, J,1/16W	1	
	R8493	DOGA680JA015	M 68 OHM, J,1/16W	1	
	R8494	DOGA680JA015	M 68 OHM, J,1/16W	1	
	R8495	DOGA680JA015	M 68 OHM, J,1/16W	1	
	R8496	DOGA680JA015	M 68 OHM, J,1/16W	1	
	R8497	DOGA680JA015	M 68 OHM, J,1/16W	1	
	R8498	DOGA680JA015	M 68 OHM, J,1/16W	1	
	R8499	DOGA680JA015	M 68 OHM, J,1/16W	1	
	R8501	DOGA680JA015	M 68 OHM, J,1/16W	1	
	R8502	DOGA680JA015	M 68 OHM, J,1/16W	1	
	R8503	DOGA680JA015	M 68 OHM, J,1/16W	1	
	R8504	DOGA680JA015	M 68 OHM, J,1/16W	1	
	R8505	DOGA680JA015	M 68 OHM, J,1/16W	1	
	R8506	DOGA680JA015	M 68 OHM, J,1/16W	1	
	R8507	DOGA680JA015	M 68 OHM, J,1/16W	1	
	R8508	DOGA680JA015	M 68 OHM, J,1/16W	1	
	R8509	DOGA680JA015	M 68 OHM, J,1/16W	1	
	R8510	DOGA680JA015	M 68 OHM, J,1/16W	1	
	R8511	ERJ2GEJ103	M 10KOHM, J,1/16 W	1	
	R8515	ERJ2GEJ103	M 10KOHM, J,1/16 W	1	
	R8516	ERJ2GEJ103	M 10KOHM, J,1/16 W	1	
	R8524	D1BA49R9A014	M 49.9 OHM,J.1/16 W	1	
	R8525	D1BA49R9A014	M 49.9 OHM,J.1/16 W	1	
	R8526	D1BA49R9A014	M 49.9 OHM,J.1/16 W	1	
	R8527	D1BA49R9A014	M 49.9 OHM,J.1/16 W	1	
	R8566	DOGBR00Z0002	M 0 OHM J 1/10W	1	
	R8600	ERJ2GEJ103	M 10KOHM, J,1/16 W	1	
	R8606	ERJ2GEJ103	M 10KOHM, J,1/16 W	1	
	R8607	DOGA680JA015	M 68 OHM, J,1/16W	1	
	R8610	DOGA680JA015	M 68 OHM, J,1/16W	1	
	R8622	DOGA680JA015	M 68 OHM, J,1/16W	1	
	R8636	DOGA680JA015	M 68 OHM, J,1/16W	1	
	R8638	ERJ2GEJ103	M 10KOHM, J,1/16 W	1	
	R8641	DOGA680JA015	M 68 OHM, J,1/16W	1	
	R8642	DOGA680JA015	M 68 OHM, J,1/16W	1	
	R8644	DOGA680JA015	M 68 OHM, J,1/16W	1	
	R8645	DOGA680JA015	M 68 OHM, J,1/16W	1	
	R8649	ERJ2GEJ103	M 10KOHM, J,1/16 W	1	

Safety	Ref. No.	Part No.	Part Name & Description	Pcs	Remarks
	R8651	ERJ2GEJ103	M 10KOHM, J,1/16 W	1	
	R8652	ERJ2GEJ103	M 10KOHM, J,1/16 W	1	
	R8657	DOGA222JA015	M 2.2KOHM, J,1/16W	1	
	R8658	DOGA222JA015	M 2.2KOHM, J,1/16W	1	
	R8660	EXB2HV680J	M 68 OHM 1/16 W	1	
	R8661	ERJ2GEJ103	M 10KOHM, J,1/16 W	1	
	R8668	DOGA680JA015	M 68 OHM, J,1/16W	1	
	R8669	ERJ2GEJ103	M 10KOHM, J,1/16 W	1	
	R8672	ERJ2GEJ103	M 10KOHM, J,1/16 W	1	
	R8673	ERJ2GEJ103	M 10KOHM, J,1/16 W	1	
	R8680	ERJ2GEJ103	M 10KOHM, J,1/16 W	1	
	R8685	DOGA222JA015	M 2.2KOHM, J,1/16W	1	
	R8689	DOGA680JA015	M 68 OHM, J,1/16W	1	
	R8691	ERJ2GEJ103	M 10KOHM, J,1/16 W	1	
	R8692	DOGA680JA015	M 68 OHM, J,1/16W	1	
	R8703	DOGA560JA015	M 56 OHM, J,1/16W	1	
	R8704	DOGA560JA015	M 56 OHM, J,1/16W	1	
	R8705	DOGA560JA015	M 56 OHM, J,1/16W	1	
	R8706	DOGA560JA015	M 56 OHM, J,1/16W	1	
	R8707	DOGA560JA015	M 56 OHM, J,1/16W	1	
	R8708	DOGA560JA015	M 56 OHM, J,1/16W	1	
	R8709	DOGA560JA015	M 56 OHM, J,1/16W	1	
	R8710	DOGA560JA015	M 56 OHM, J,1/16W	1	
	R8711	DOGA472JA015	M 4.7KOHM, J,1/16W	1	
	R8712	DOGA472JA015	M 4.7KOHM, J,1/16W	1	
	R8721	DOGA560JA015	M 56 OHM, J,1/16W	1	
	R8722	DOGA560JA015	M 56 OHM, J,1/16W	1	
	R8723	DOGA560JA015	M 56 OHM, J,1/16W	1	
	R8724	DOGA560JA015	M 56 OHM, J,1/16W	1	
	R8725	DOGA560JA015	M 56 OHM, J,1/16W	1	
	R8726	ERJ2GEJ103	M 10KOHM, J,1/16 W	1	
	R8727	ERJ2GEJ103	M 10KOHM, J,1/16 W	1	
	R8728	DOGA560JA015	M 56 OHM, J,1/16W	1	
	R8729	DOGA560JA015	M 56 OHM, J,1/16W	1	
	R8730	DOGA560JA015	M 56 OHM, J,1/16W	1	
	R8731	DOGA560JA015	M 56 OHM, J,1/16W	1	
	R8732	DOGA560JA015	M 56 OHM, J,1/16W	1	
	R8733	DOGA560JA015	M 56 OHM, J,1/16W	1	
	R8734	DOGAR00Z0001	M 0 OHM, 1/16W	1	
	R8735	ERJ2GEJ103	M 10KOHM, J,1/16 W	1	
	R8737	D1BA6491A014	M6.49KOHM,J.1/16 W	1	

Safety	Ref. No.	Part No.	Part Name & Description	Pcs	Remarks
	R8739	ERJ2GEJ103	M 10KOHM, J,1/16 W	1	
	R8741	DOGA272JA015	M 2.7KOHM, J,1/16W	1	
	R8742	DOGA272JA015	M 2.7KOHM, J,1/16W	1	
	R8743	ERJ2GEJ103	M 10KOHM, J,1/16 W	1	
	R8744	D1BA6201A014	M 6.2KOHM,J.1/16 W	1	
	R8745	DOGA472JA015	M 4.7KOHM, J,1/16W	1	
	R8747	ERJ2GEJ103	M 10KOHM, J,1/16 W	1	
	R8748	ERJ2GEJ103	M 10KOHM, J,1/16 W	1	
	R8754	ERJ2GEJ103	M 10KOHM, J,1/16 W	1	
	R8757	D1BA1600A014	M 160 OHM,J.1/16 W	1	
	R8758	D1BA2402A014	M 24KOHM,J.1/16 W	1	
	R8759	D1BA1002A014	M 10KOHM,J. 1/16 W	1	
	R8760	D1BA2402A014	M 24KOHM,J.1/16 W	1	
	R8761	D1BA6201A014	M 6.2KOHM,J.1/16 W	1	
	R8762	DOGA472JA015	M 4.7KOHM, J,1/16W	1	
	R8764	ERJ2GEJ103	M 10KOHM, J,1/16 W	1	
	R8856	DOGA473JA015	M 47KOHM, J,1/16W	1	
	R8857	DOGA680JA015	M 68 OHM, J,1/16W	1	
	R8858	ERJ2GEJ103	M 10KOHM, J,1/16 W	1	
	R8859	DOGA680JA015	M 68 OHM, J,1/16W	1	
	R8860	DOGA680JA015	M 68 OHM, J,1/16W	1	
	R8861	DOGA680JA015	M 68 OHM, J,1/16W	1	
	R8862	DOGA680JA015	M 68 OHM, J,1/16W	1	
	R8863	DOGA680JA015	M 68 OHM, J,1/16W	1	
	R8864	ERJ2GEJ103	M 10KOHM, J,1/16 W	1	
	R8867	ERJ2GEJ103	M 10KOHM, J,1/16 W	1	
	R8868	DOGA330JA015	M 33 OHM, J,1/16W	1	
	R8869	ERJ2GEJ103	M 10KOHM, J,1/16 W	1	
	R8870	ERJ2GEJ103	M 10KOHM, J,1/16 W	1	
	R8872	DOGA330JA015	M 33 OHM, J,1/16W	1	
	R8873	DOGA680JA015	M 68 OHM, J,1/16W	1	
	R8874	DOGA680JA015	M 68 OHM, J,1/16W	1	
	R8875	DOGA680JA015	M 68 OHM, J,1/16W	1	
	R8876	DOGA680JA015	M 68 OHM, J,1/16W	1	
	R8877	DOGA330JA015	M 33 OHM, J,1/16W	1	
	R8878	ERJ2GEJ103	M 10KOHM, J,1/16 W	1	
	R8879	ERJ2GEJ103	M 10KOHM, J,1/16 W	1	
	R8880	ERJ2GEJ103	M 10KOHM, J,1/16 W	1	
	R8881	ERJ2GEJ103	M 10KOHM, J,1/16 W	1	
	R8882	ERJ2GEJ103	M 10KOHM, J,1/16 W	1	

Safety	Ref. No.	Part No.	Part Name & Description	Pcs	Remarks
	R8883	ERJ2GEJ103	M 10KOHM, J,1/16 W	1	
	R8885	ERJ2GEJ103	M 10KOHM, J,1/16 W	1	
	R8886	ERJ2GEJ103	M 10KOHM, J,1/16 W	1	
	R8887	ERJ2GEJ103	M 10KOHM, J,1/16 W	1	
	R8888	D0GBR00Z0002	M 0 OHM J 1/10W	1	
	R8918	EXB2HV680J	M 68 OHM 1/16 W	1	
	R8919	EXB2HV680J	M 68 OHM 1/16 W	1	
	R8922	EXB2HVR000	M 0 OHM 1/16 W	1	
	R8923	D0GA680JA015	M 68 OHM, J,1/16W	1	
	R8924	D0GA680JA015	M 68 OHM, J,1/16W	1	
	R8925	D0GA680JA015	M 68 OHM, J,1/16W	1	
	R8926	D0GA680JA015	M 68 OHM, J,1/16W	1	
	R8927	D0GA680JA015	M 68 OHM, J,1/16W	1	
	R8928	D0GA680JA015	M 68 OHM, J,1/16W	1	
	R8950	D0GA472JA015	M 4.7KOHM, J,1/16W	1	
	R9014	D1BB5601A055	M 5.6KOHM,J.1/10W	1	
	R9015	D0GA390JA015	M 39 OHM, J,1/16W	1	
	R9016	D0GA2R2JA014	M 2.2OHM, J,1/16W	1	
	R9017	D1BB4701A055	M 4.7KOHM,J.1/10W	1	
	R9019	D0GA2R2JA014	M 2.2OHM, J,1/16W	1	
	R9035	D0GA332JA015	M 3.3KOHM, J,1/16W	1	
	R9036	ERJ2GEJ103	M 10KOHM, J,1/16 W	1	
	R9037	D0GA473JA015	M 47KOHM, J,1/16W	1	
	R9038	ERJ2GEJ104	M100KOHM, J,1/16 W	1	
	R9039	D0GA473JA015	M 47KOHM, J,1/16W	1	
	R9040	D0GA472JA015	M 4.7KOHM, J,1/16W	1	
	R9104	D0GA390JA015	M 39 OHM, J,1/16W	1	
	R9107	D0GA332JA015	M 3.3KOHM, J,1/16W	1	
	R9110	D0GAR00Z0001	M 0 OHM, 1/16W	1	
	R9127	ERJ6GEYOR00V	M 0 OHM 1/8W	1	
	R9132	ERJ6GEYOR00V	M 0 OHM 1/8W	1	
	R9133	D1BB1202A055	M 12KOHM,J.1/10W	1	
	R9134	D1BB1002A055	M 10KOHM,J.1/10W	1	
	R9135	D1BB2702A055	M 27KOHM,J.1/10W	1	
	R9198	EXB28V101JX	M 100 OHM 1/32 W	1	
	R9203	D0GA272JA015	M 2.7KOHM, J.1/16W	1	
	R9205	D0GA333JA015	M 33KOHM,J,1/16W	1	
	R9206	D0GA563JA015	M 56KOHM, J,1/16W	1	
	R9208	EXB2HV470JV	M 47 OHM 1/16 W	1	
	R9209	EXB2HV470JV	M 47 OHM 1/16 W	1	
	R9224	D0GA470JA015	M 47 OHM, J,1/16W	1	
	R9226	D0GA470JA015	M 47 OHM, J,1/16W	1	
	R9247	D0GA470JA015	M 47 OHM, J,1/16W	1	
	R9300	EXB28VR000X	M 0 OHM 1/32 W	1	
	R9318	ERJ2GEJ102X	M 1KOHM, J.1/16 W	1	
	R9320	ERJ2GEJ102X	M 1KOHM, J.1/16 W	1	
	R9321	D0GA105JA015	M 1M OHM, J,1/16W	1	

Safety	Ref. No.	Part No.	Part Name & Description	Pcs	Remarks
	R9323	ERJ2GEJ102X	M 1KOHM, J.1/16 W	1	
	R9324	D0GB162JA041	M 1.6KOHM J 1/10W	1	
	R9325	D0GB162JA041	M 1.6KOHM J 1/10W	1	
	R9326	D0GB162JA041	M 1.6KOHM J 1/10W	1	
	R9327	D0GB162JA041	M 1.6KOHM J 1/10W	1	
	R9400	EXB2HV103JV	M 10 kOHM 1/16 W	1	
	R9401	EXB2HV103JV	M 10 kOHM 1/16 W	1	
	R9402	EXB28V103JX	M 10KOHM 1/32 W	1	
	R9608	EXB2HV470JV	M 47 OHM 1/16 W	1	
	R9609	EXB2HV470JV	M 47 OHM 1/16 W	1	
	R9610	EXB2HV470JV	M 47 OHM 1/16 W	1	
	R9872	D1BB3301A055	M 3.3KOHM,J.1/10W	1	
	R9873	D1BB1002A055	M 10KOHM,J.1/10W	1	
	R9874	D1BB2702A055	M 27KOHM,J.1/10W	1	
	R9875	D1BB2002A055	M 20KOHM,J.1/10W	1	
	R9877	D1BB4702A055	M 47KOHM,J.1/10W	1	
	R9878	D1BB1002A055	M 10KOHM,J.1/10W	1	
	R9879	D1BB1502A055	M 15KOHM, J.1/10W	1	
	R9903	D0GA472JA015	M 4.7KOHM, J,1/16W	1	
	R9904	ERJ2GEJ104	M100KOHM, J,1/16 W	1	
	R9905	ERJ2GEJ103	M 10KOHM, J,1/16 W	1	
	R9907	D0GA101JA015	M 100 OHM, J,1/16W	1	
	RM2510	B3RAD0000168	REMOTE SENSOR	1	
	SN2510	B3JB00000078	IC	1	
	SW2500	K0F122A00031	SWITCH	1	
	SW2550	K0H1BA000445	SWITCH	1	
	SW2551	K0H1BA000445	SWITCH	1	
	SW2552	K0H1BA000445	SWITCH	1	
	SW2553	K0H1BA000445	SWITCH	1	
	SW2554	K0H1BA000445	SWITCH	1	
	T8301	G5BYC0000015	TRANS	1	
△	TU2901A	ENG37F03KF	TUNER	1	
△	TU6700	J3BBCBC00006	TUNER	1	PAVCCZ
	X1100	H0J100500035	CRYSTAL	1	
	X4200	H0J270500113	CRYSTAL	1	
	X8002	H0J245500101	CRYSTAL	1	
	X8100	H0J270500120	CRYSTAL	1	
	X8300	H0J410500001	CRYSTAL	1	
	X9300	H0J200500076	CRYSTAL	1	
	XS3	K1KY30AA0369	30P CONNECTOR	1	
	C10	K1MN20BA0231	20P CONNECTOR	1	
	C11	K1MY68BA0345	68P CONNECTOR	1	
	C20	K1MY20BA0345	20P CONNECTOR	1	
	C21	K1MY68BA0345	68P CONNECTOR	1	
	C23	K1KY08AA0719	8P CONNECTOR	1	
	C25	K1KA04BA0107	4P CONNECTOR	1	
	C16001	F1L2J272A022	C 2700PF, 630V	1	
	C16002	F1L2J562A022	C 5600PF, 630V	1	
	C16012	F2A2T251A004	E 250UF, 220V	1	
	C16013	F2A2T251A004	E 250UF, 220V	1	
	C16014	F0C2E155A252	C 1.5UF, 250V	1	
	C16022	F1L2J562A022	C 5600PF, 630V	1	
	C16041	F1H1H392A970	C 3900PF, 50V	1	
	C16071	F1L2J1020001	C 1000PF, 630V	1	
	C16072	F1L2J1020001	C 1000PF, 630V	1	
	C16091	F1L2J1020001	C 1000PF, 630V	1	

Safety	Ref. No.	Part No.	Part Name & Description	Pcs	Remarks
	CB2	K1MY55B00002	55P CONNECTOR	1	
	CB3	K1MY55B00002	55P CONNECTOR	1	
	CB4	K1MY55B00002	55P CONNECTOR	1	
	CB5	K1MY55B00002	55P CONNECTOR	1	
	CB6	K1MY55B00002	55P CONNECTOR	1	
	CB7	K1MY55B00002	55P CONNECTOR	1	
	CB8	K1MY55B00002	55P CONNECTOR	1	
	CB9	K1MY55B00002	55P CONNECTOR	1	
	CB10	K1MY55B00002	55P CONNECTOR	1	
	CB11	K1MY55B00002	55P CONNECTOR	1	
	CB12	K1MY55B00002	55P CONNECTOR	1	
	CB13	K1MY55B00002	55P CONNECTOR	1	
	CB14	K1MY55B00002	55P CONNECTOR	1	
	CB15	K1MY55B00002	55P CONNECTOR	1	
	D16001	B0FBCN000005	DIODE	1	
	D16002	B0FBCN000005	DIODE	1	
	D16032	B0ACCCJ000048	DIODE	1	
	D16050	B0ECKP000055	DIODE	1	
	D16051	B0FBCN000007	DIODE	1	
	D16101	B0JCME000093	DIODE	1	
	D16131	B0ECKP000055	DIODE	1	
	D16151	B0ECKP000055	DIODE	1	
	D16152	B0ECKP000055	DIODE	1	
	D16153	B0ECKP000055	DIODE	1	
	D16191	B0ECKP000055	DIODE	1	
	D16192	B0ACCCJ000048	DIODE	1	
	D16196	DZ2J200M0L	ZENER DIODE	1	
	D16253	B3ABB0000210	LED	1	
	D16255	B0ACCCJ000048	DIODE	1	
	D16280	B0ACCCJ000048	DIODE	1	
	D16281	DZ2J051M0L	ZENER DIODE	1	
	D16282	DZ2J068M0L	ZENER DIODE	1	
	D16285	B0ADEJ000035	ZENER DIODE	1	
	D16286	B0ACCCJ000048	DIODE	1	
	D16315	DZ2J150M0L	ZENER DIODE	1	
	D16316	B0ECKP000055	DIODE	1	
	D16317	B0ECKP000055	DIODE	1	
	D16401	DA3DF50ACSLW	ZENER DIODE	1	
	D16402	DA3DF50ACSLW	ZENER DIODE	1	
	D16407	B0JCME000093	DIODE	1	
	D16411	B0ACCCJ000048	DIODE	1	
	D16421	B0FACP000006	DIODE	1	
	D16422	B0FACP000005	DIODE	1	
	D16451	B0ECKP000055	DIODE	1	
	D16462	B0FACP000003	DIODE	1	
	D16466	B0ACCCJ000048	DIODE	1	
	D16473	B0ACCCJ000048	DIODE	1	
	D16474	B0ACCCJ000048	DIODE	1	
	D16475	DZ2J051M0L	ZENER DIODE	1	
	D16476	B0ACCCJ000048	DIODE	1	
	D16477	DZ2J047L0L	ZENER DIODE	1	
	D16478	B0ACCCJ000048	DIODE	1	
	D16480	B0ACCCJ000048	DIODE	1	
	D16482	B0FACP000003	DIODE	1	
	D16490	B0ECKP000055	DIODE	1	
	D16491	B0ECKP000055	DIODE	1	
	D16492	DZ2J047M0L	ZENER DIODE	1	
	D16493	B0ADCJ000100	DIODE	1	
	D16494	B0ADCJ000100	DIODE	1	
	D16497	B0ECKP000055	DIODE	1	
	D16503	B0ECHR000001	DIODE	1	
	D16522	B0ECHR000001	DIODE	1	
	D16523	B0ECHR000001	DIODE	1	
	D16534	B0ECHR000001	DIODE	1	
	D16536	B0ECHR000001	DIODE	1	
	D16583	B3ABB0000210	LED	1	
	D16602	DZ2J150M0L	ZENER DIODE	1	
	D16604	B0ADCJ000100	DIODE	1	
	D16605	DZ2J051L0L	ZENER DIODE	1	
	D16607	B0ACCCJ000048	DIODE	1	
	D16610	B0ACCCJ000048	DIODE	1	
	D16618	B0ECKP000055	DIODE	1	

Safety	Ref. No.	Part No.	Part Name & Description	Pcs	Remarks
	D16641	B0FBCN000006	DIODE	1	
	D16642	B0FBCN000006	DIODE	1	
	D16645	DZ2J150M0L	ZENER DIODE	1	
	D16646	DZ2J150M0L	ZENER DIODE	1	
	D16647	DZ2J150M0L	ZENER DIODE	1	
	D16648	DZ2J051L0L	ZENER DIODE	1	
	D16649	B0ACCCJ000048	DIODE	1	
	D16650	B0ACCCJ000048	DIODE	1	
	D16651	DZ2J051M0L	ZENER DIODE	1	
	D16652	B0ECKP000055	DIODE	1	
	D16653	B0ACCCJ000048	DIODE	1	
	D16654	B0ACCCJ000048	DIODE	1	
	D16662	DZ2J150M0L	ZENER DIODE	1	
	D16663	DZ2J150M0L	ZENER DIODE	1	
	D16664	DZ2J150M0L	ZENER DIODE	1	
	D16669	B0ACCCJ000048	DIODE	1	
	D16671	B0ACCCJ000048	DIODE	1	
	D16673	B0ECHR000001	DIODE	1	
	D16674	B0ECHR000001	DIODE	1	
	D16677	B0ADEJ000035	ZENER DIODE	1	
	D16678	DZ2J15000L	ZENER DIODE	1	
	D16702	B0ACCCJ000048	DIODE	1	
	D16710	DZ2J15000L	ZENER DIODE	1	
	D16711	B0ECHR000001	DIODE	1	
	D16712	DZ2J15000L	ZENER DIODE	1	
	D16713	B0ECHR000001	DIODE	1	
	D16719	B0ECKP000055	DIODE	1	
	D16720	B0ECKP000055	DIODE	1	
	D16721	B0ECHR000001	DIODE	1	
	D16728	B0ECKP000055	DIODE	1	
	D16765	B0ECKP000055	DIODE	1	
	D16790	B0JCME000093	DIODE	1	
	D16791	DZ2J200M0L	ZENER DIODE	1	
	D16792	B0ACCCJ000048	DIODE	1	
	D16820	B0ACCCJ000048	DIODE	1	
	D16821	DZ2J330M0L	ZENER DIODE	1	
	D16822	B0ADCJ000100	DIODE	1	
	D16824	DZ2J330M0L	ZENER DIODE	1	
	D16825	DZ2J330M0L	ZENER DIODE	1	
	D16859	B0HCKS000002	DIODE	1	
	D16871	DZ2J240M0L	ZENER DIODE	1	
	D16872	DZ2J200M0L	ZENER DIODE	1	
	D16874	DZ2J051M0L	ZENER DIODE	1	
	D16875	B0ACCCJ000048	DIODE	1	
	D16893	DZ2J056H0L	ZENER DIODE	1	
	D16901	B0ADCJ000100	DIODE	1	
	D16902	B0ACCCJ000048	DIODE	1	
	D16920	B0ADCJ000100	DIODE	1	
	IC16131	C0ZBZ0001707	IC	1	
	IC16151	C0ZBZ0001708	IC	1	
	IC16251	C0BBBA000024	IC	1	
	IC16304	MIP390MSSCF	IC	1	
	IC16312	C0DBZMC00006	IC	1	
	IC16471	C0DBEYY00114	IC	1	
	IC16490	C0DBZMC00006	IC	1	
	IC16491	C0BBAA000008	LINEAR IC	1	
	IC16501	C0ZBZ0001708	IC	1	
	IC16521	C0ZBZ0001708	IC	1	
	IC16563	C0JBAB000916	IC	1	
	IC16581	C0BBBA000024	IC	1	
	IC16661	C0BBBA000024	IC	1	
	IC16691	C0JBAC000363	IC	1	
	IC16692	C0DBZYY00352	IC	1	
	IC16724	C0CBADE00049	IC	1	
	IC16771	C0CBADC00072	IC	1	
	IC16773	C0JBAB000715	IC	1	
	IC16784	MIP3910MSSCF	IC	1	
	IC16785	C0DBZYY00352	IC	1	
	IC16786	MIP3910MSSCF	IC	1	
	IC16787	C0DBZYY00352	IC	1	
	IC16792	C0BBAA000008	LINEAR IC	1	
	IC16793	C0DBZMC00006	IC	1	

Safety	Ref. No.	Part No.	Part Name & Description	Pcs	Remarks
	IC16920	COBBBA000024	IC	1	
	IC17202	C0JBAZ002692	IC	1	
	L16401	G0CR41K00001	PEAKING COIL	1	
	L16411	G0CR41K00001	PEAKING COIL	1	
	L16472	G0ZZ00002183	PEAKING COIL	1	
	L16698	G0C681MA00065	PEAKING COIL	1	
	L16851	G0ZZ00002183	PEAKING COIL	1	
	PC16191	B3PBA0000496	IC	1	
	PC16301	B3PBA0000498	IC	1	
	PC16461	B3PBE0000054	IC	1	
	PC16480	B3PBA0000498	IC	1	
	PC16603	B3PBA0000498	IC	1	
	PC16684	B3PBA0000496	IC	1	
	PC16685	B3PBA0000496	IC	1	
	PC16722	B3PBA0000498	IC	1	
	PC16723	B3PBA0000498	IC	1	
	PC16896	B3PBA0000498	IC	1	
	PC16897	B3PBA0000498	IC	1	
	Q16001	B1JADN000009	TRANSISTOR	1	
	Q16002	B1JADN000009	TRANSISTOR	1	
	Q16055	B1HFPPFA00001	TRANSISTOR	1	
	Q16056	B1HFPPFA00001	TRANSISTOR	1	
	Q16101	B1CFRM000008	FET	1	
	Q16102	B1CFRM000008	FET	1	
	Q16141	B1HFPPFA00001	TRANSISTOR	1	
	Q16161	B1HFPPFA00001	TRANSISTOR	1	
	Q16191	B1HFPPFA00001	TRANSISTOR	1	
	Q16251	B1ABCF000231	TRANSISTOR	1	
	Q16280	B1ABCF000231	TRANSISTOR	1	
	Q16402	DG3D5020CSLW	TRANSISTOR	1	
	Q16403	DG3D5020CSLW	TRANSISTOR	1	
	Q16421	DG3D4020CSR	TRANSISTOR	1	
	Q16422	DG3D4020CSR	TRANSISTOR	1	
	Q16441	B1JAEP000013	TRANSISTOR	1	
	Q16452	B1JAEP000012	TRANSISTOR	1	
	Q16471	B1ABCF000231	TRANSISTOR	1	
	Q16490	B1CBGD000001	FET	1	
	Q16501	B1HFPPFA00001	TRANSISTOR	1	
	Q16521	B1HFPPFA00001	TRANSISTOR	1	
	Q16531	B1HFPPFA00001	TRANSISTOR	1	
	Q16551	B1HFPPFA00001	TRANSISTOR	1	
	Q16601	B1CERR000042	FET	1	
	Q16602	DSC2001Q0L	TRANSISTOR	1	
	Q16603	DSA2001S0L	TRANSISTOR	1	
	Q16606	DSC2001Q0L	TRANSISTOR	1	
	Q16607	B1CBGD000001	FET	1	
	Q16608	B1CBGD000001	FET	1	
	Q16621	B1JADN000009	TRANSISTOR	1	
	Q16622	B1JADN000009	TRANSISTOR	1	
	Q16645	DSC2001Q0L	TRANSISTOR	1	
	Q16646	DSA2001S0L	TRANSISTOR	1	
	Q16647	B1CBGD000001	FET	1	
	Q16649	B1ABCN000007	TRANSISTOR	1	
	Q16660	B1CERR000042	FET	1	
	Q16661	B1JAER000010	TRANSISTOR	1	
	Q16662	DSC2001Q0L	TRANSISTOR	1	
	Q16663	DSA2001S0L	TRANSISTOR	1	
	Q16668	DSC2001Q0L	TRANSISTOR	1	
	Q16670	B1ADCN000007	TRANSISTOR	1	
	Q16671	B1ABCF000231	TRANSISTOR	1	
	Q16675	B1ABCF000231	TRANSISTOR	1	
	Q16677	DSC2001Q0L	TRANSISTOR	1	
	Q16678	B1ABCF000231	TRANSISTOR	1	
	Q16701	B1ADCN000007	TRANSISTOR	1	
	Q16702	B1ABCF000231	TRANSISTOR	1	
	Q16762	B1HFPPFA00001	TRANSISTOR	1	
	Q16801	DSA2001S0L	TRANSISTOR	1	
	Q16810	B1ABCF000231	TRANSISTOR	1	
	Q16815	B1ABCN000007	TRANSISTOR	1	

Safety	Ref. No.	Part No.	Part Name & Description	Pcs	Remarks
	Q16816	DSC2001Q0L	TRANSISTOR	1	
	Q16817	DSC2001Q0L	TRANSISTOR	1	
	Q16818	B1CBGD000001	FET	1	
	Q16876	B1ABCF000231	TRANSISTOR	1	
	Q16885	B1CFNG000001	FET	1	
	Q16920	B1ABCN000007	TRANSISTOR	1	
	Q16921	B1ABCN000007	TRANSISTOR	1	
	Q16930	DSC2001Q0L	TRANSISTOR	1	
	Q16931	B1ABCN000007	TRANSISTOR	1	
	Q16932	DSC2001Q0L	TRANSISTOR	1	
	R16001	D0GF7R5JA047	M 7.5 OHM, J, 1/3W	1	
	R16002	D0GF7R5JA047	M 7.5 OHM, J, 1/3W	1	
	R16021	D0GF7R5JA047	M 7.5 OHM, J, 1/3W	1	
	R16022	D0GF7R5JA047	M 7.5 OHM, J, 1/3W	1	
	R16031	ERJ6ENF8202	M 82KOHM, F, 1/8W	1	
	R16032	ERJ6ENF8202	M 82KOHM, F, 1/8W	1	
	R16033	ERJ6ENF5602	M 56KOHM, F, 1/8W	1	
	R16034	ERJ6ENF2702	M 27KOHM, F, 1/8W	1	
	R16041	D0GF5R6JA047	M 5.6 OHM, J, 1/3W	1	
	R16051	D0GF5R6JA047	M 5.6 OHM, J, 1/3W	1	
	R16101	D0GD221JA059	M 220 OHM, J, 1/4W	1	
	R16102	D0GD221JA059	M 220 OHM, J, 1/4W	1	
	R16103	D0GD100JA059	M 10 OHM, J, 1/4W	1	
	R16104	D0GD100JA059	M 10 OHM, J, 1/4W	1	
	R16105	ERJ8GEYJ474	M 470KOHM, J, 1/4W	1	
	R16109	D0GD100JA059	M 10 OHM, J, 1/4W	1	
	R16116	D0GB473JA057	M 47KOHM, J, 1/10W	1	
	R16131	ERJ8GEYJ101V	M 100 OHM, J, 1/4W	1	
	R16132	ERJ8GEYJ101V	M 100 OHM, J, 1/4W	1	
	R16134	D0GD750JA059	M 75 OHM, J, 1/4W	1	
	R16137	D0GF1R0JA047	M 1 OHM, J, 1/3W	1	
	R16141	D0GD100JA059	M 10 OHM, J, 1/4W	1	
	R16143	D0GB473JA057	M 47KOHM, J, 1/10W	1	
	R16151	ERJ8GEYJ101V	M 100 OHM, J, 1/4W	1	
	R16152	ERJ8GEYJ101V	M 100 OHM, J, 1/4W	1	
	R16154	D0GD750JA059	M 75 OHM, J, 1/4W	1	
	R16155	D0GF1R0JA047	M 1 OHM, J, 1/3W	1	
	R16159	D0GF1R0JA047	M 1 OHM, J, 1/3W	1	
	R16161	D0GD100JA059	M 10 OHM, J, 1/4W	1	
	R16163	D0GB473JA057	M 47KOHM, J, 1/10W	1	
	R16171	D0GD100JA059	M 10 OHM, J, 1/4W	1	
	R16173	D0GB473JA057	M 47KOHM, J, 1/10W	1	
	R16181	D0GD100JA059	M 10 OHM, J, 1/4W	1	
	R16183	D0GB473JA057	M 47KOHM, J, 1/10W	1	
	R16191	ERJ6GEYJ151V	M 150 OHM, J, 1/8W	1	
	R16192	D0GB103JA057	M 10K OHM J 1/10W	1	
	R16193	ERJ6GEYJ750	M 75 OHM, J, 1/8W	1	
	R16195	D0GF1R0JA047	M 1 OHM, J, 1/3W	1	
	R16230	ERJ6GEYJ470V	M 47 OHM, J, 1/8W	1	
	R16231	ERJ3GEYJ472	M 4.7KOHM, J, 1/10W	1	
	R16241	EXB38V470J	M 47 OHM 1/16 W	1	
	R16242	EXB38V472JV	M 4.7 kOHM 1/16 W	1	
	R16251	D1BB1401A055	M 1.4KOHM, J, 1/10W	1	
	R16252	ERJ6ENF3902	M 39KOHM, F, 1/8W	1	
	R16253	ERJ6ENF3902	M 39KOHM, F, 1/8W	1	
	R16254	ERJ6ENF6801	M 6.8KOHM, F, 1/8W	1	
	R16255	D1BB1201A055	M 1.2KOHM, J, 1/10W	1	
	R16256	D1BB1501A055	M 1.50KOHM, J, 1/10W	1	

Safety	Ref. No.	Part No.	Part Name & Description	Pcs	Remarks
	R16257	D0GB273JA041	M 27K OHM J 1/10W	1	
	R16258	D0GB103JA057	M 10K OHM J 1/10W	1	
	R16260	ERJ6GEYJ222V	M 2.2KOHM.J. 1/8W	1	
	R16280	D0GB222JA041	M 2.2KOHM,J,1/10W	1	
	R16281	D0GB103JA057	M 10K OHM J 1/10W	1	
	R16282	ERJ6GEYJ221V	M 220 OHM,J,1/8W	1	
	R16283	D0GB473JA057	M 47KOHM,J,1/10W	1	
	R16284	D0GB224JA041	M 220KOHM,J,1/10W	1	
	R16285	EXB38V623J	M 62 kOHM 1/16 W	1	
	R16288	D0GF334JA047	M 330KOHMJ,1/3W	1	
	R16289	D0GF334JA047	M 330KOHMJ,1/3W	1	
	R16290	D0GF334JA047	M 330KOHMJ,1/3W	1	
	R16307	ERJ6RBD6492	M64.9KOHM,D.1/10W	1	
	R16309	ERG1FJS333D	M 33KOHM, J, 1W	1	
	R16318	ERJ6RBD683	M 68KOHM,D.1/10W	1	
	R16319	ERJ6RBD2491	M2.49KOHM,D.1/10W	1	
	R16320	ERJ14YJ683	M 68KOHM, J. 1/4W	1	
	R16330	D0GB102JA041	M 1KOHM,J,1/10W	1	
	R16332	D0GB474JA041	M 470KOHM,J,1/10W	1	
	R16334	ERJ3GEYJ472	M 4.7KOHM,J,1/10W	1	
	R16335	D0GB102JA041	M 1KOHM,J,1/10W	1	
	R16402	D0GF7R5JA047	M 7.5 OHM,J, 1/3W	1	
	R16403	D0GF7R5JA047	M 7.5 OHM,J, 1/3W	1	
	R16410	D0GB391JA041	M 390 OHM,J,1/10W	1	
	R16411	ERJ6ENF2700	M 270 OHM,F.1/8W	1	
	R16416	D0GB103JA057	M 10K OHM J 1/10W	1	
	R16417	ERJ6GEYJ101V	M 100 OHM,J,1/8W	1	
	R16418	ERJ6GEYJ101V	M 100 OHM,J,1/8W	1	
	R16421	D0GF7R5JA047	M 7.5 OHM,J, 1/3W	1	
	R16422	D0GF7R5JA047	M 7.5 OHM,J, 1/3W	1	
	R16441	D0GF5R6JA047	M 5.6 OHM,J, 1/3W	1	
	R16452	D0GF5R6JA047	M 5.6 OHM,J, 1/3W	1	
	R16465	ERJ6ENF2702	M 27KOHM,F.1/8W	1	
	R16466	ERJ6ENF5602	M 56KOHM,F.1/8W	1	
	R16467	ERJ6ENF8202	M 82KOHM,F.1/8W	1	
	R16468	ERJ6ENF8202	M 82KOHM,F.1/8W	1	
	R16471	D0GB392JA041	M 3.9KOHM,J,1/10W	1	
	R16472	D0GB222JA041	M 2.2KOHM,J,1/10W	1	
	R16473	ERJ6GEYF561	M 560 OHM,J,1/8W	1	
	R16474	D0GB102JA041	M 1KOHM,J,1/10W	1	
	R16475	ERJ3GEYJ472	M 4.7KOHM,J,1/10W	1	
	R16476	ERJ3GEYJ472	M 4.7KOHM,J,1/10W	1	
	R16478	D0GB562JA041	M 5.6KOHM,J,1/10W	1	
	R16479	ERJ6GEYJ103V	M 10KOHM J 1/8W	1	
	R16490	ERJ6RED124	M 120KOHM,D.1/10W	1	
	R16491	ERJ6RED124	M 120KOHM,D.1/10W	1	
	R16492	ERJ6RED124	M 120KOHM,D.1/10W	1	
	R16493	ERJ6RBD6191	M6.19KOHM,D.1/10W	1	
	R16494	D1BB2001A055	M 2KOHM,J.1/10W	1	
	R16495	ERJ6ENF7500	M 750 OHM,F.1/8W	1	

Safety	Ref. No.	Part No.	Part Name & Description	Pcs	Remarks
	R16496	ERJ6GEYJ470V	M 47 OHM,J,1/8W	1	
	R16497	D0GB473JA057	M 47KOHM,J,1/10W	1	
	R16498	D0GB103JA057	M 10K OHM J 1/10W	1	
	R16503	D0GD100JA059	M 10 OHM,J,1/4W	1	
	R16504	D0GD750JA059	M 75 OHM,J,1/4W	1	
	R16506	D0GD100JA059	M 10 OHM,J,1/4W	1	
	R16509	D0GF1R0JA047	M 1 OHM,J,1/3W	1	
	R16512	D0GB473JA057	M 47KOHM,J,1/10W	1	
	R16517	D0GB473JA057	M 47KOHM,J,1/10W	1	
	R16521	ERJ6GEYJ101V	M 100 OHM,J,1/8W	1	
	R16522	ERJ6GEYJ101V	M 100 OHM,J,1/8W	1	
	R16523	D0GD750JA059	M 75 OHM,J,1/4W	1	
	R16531	D0GD100JA059	M 10 OHM,J,1/4W	1	
	R16533	D0GB473JA057	M 47KOHM,J,1/10W	1	
	R16534	D0GF5R6JA047	M 5.6 OHM,J, 1/3W	1	
	R16551	D0GD100JA059	M 10 OHM,J,1/4W	1	
	R16553	D0GB473JA057	M 47KOHM,J,1/10W	1	
	R16561	EXB38V470J	M 47 OHM 1/16 W	1	
	R16562	EXB38V470J	M 47 OHM 1/16 W	1	
	R16563	EXB38V470J	M 47 OHM 1/16 W	1	
	R16564	EXB38V470J	M 47 OHM 1/16 W	1	
	R16565	EXB38V472JV	M 4.7 kOHM 1/16 W	1	
	R16566	EXB38V472JV	M 4.7 kOHM 1/16 W	1	
	R16567	EXB38V472JV	M 4.7 kOHM 1/16 W	1	
	R16568	EXB38V472JV	M 4.7 kOHM 1/16 W	1	
	R16570	EXB38V472JV	M 4.7 kOHM 1/16 W	1	
	R16579	EXB38V470J	M 47 OHM 1/16 W	1	
	R16580	D0GB562JA041	M 5.6KOHM,J,1/10W	1	
	R16582	ERJ6ENF3902	M 39KOHM,F.1/8W	1	
	R16583	ERJ6ENF3902	M 39KOHM,F.1/8W	1	
	R16584	ERJ6ENF6801	M 6.8KOHM,F.1/8W	1	
	R16585	D1BB1001A055	M 1KOHM,J. 1/10W	1	
	R16586	D1BB2151A055	M2.15KOHM,J.1/10W	1	
	R16587	D0GB222JA041	M 2.2KOHM,J,1/10W	1	
	R16588	D0GB103JA057	M 10K OHM J 1/10W	1	
	R16590	ERJ3GEYJ221	M 220 OHM,J,1/10W	1	
	R16591	EXB38V472JV	M 4.7 kOHM 1/16 W	1	
	R16593	D1BB1401A055	M 1.4KOHM,J.1/10W	1	
	R16601	D0GF1R0JA047	M 1 OHM,J,1/3W	1	
	R16604	ERJ6GEYJ331V	M 330 OHM J 1/8W	1	
	R16605	ERJ6GEYJ182	M 1.8KOHM,J,1/8W	1	
	R16607	D1BB6981A055	M6.98KOHM,J.1/10W	1	
	R16609	D0GF202JA047	M 2KOHM,J,1/3W	1	
	R16610	D0GB104JA041	M 100KOHM J 1/10W	1	
	R16612	D0GD470JA059	M 47 OHM,J,1/4W	1	
	R16615	D1BB1101A055	M 1.1 KOHM,J.1/10W	1	
	R16617	ERJ6GEYJ222V	M 2.2KOHM.J. 1/8W	1	
	R16621	ERJ6GEYJ221V	M 220 OHM,J,1/8W	1	
	R16622	ERJ6GEYJ221V	M 220 OHM,J,1/8W	1	
	R16631	D0GB103JA057	M 10K OHM J 1/10W	1	
	R16633	ERJ6GEYJ223	M 22KOHM,J,1/8W	1	
	R16634	ERJ6GEYJ471	M 470 OHM,J,1/8W	1	
	R16645	D0GB562JA041	M 5.6KOHM,J,1/10W	1	
	R16646	D1BB1181A055	M 1.18KOHM,J.1/10W	1	
	R16648	D0GF202JA047	M 2KOHM,J,1/3W	1	
	R16649	D0GD330JA059	M 33 OHM,F,1/4W	1	

Safety	Ref. No.	Part No.	Part Name & Description	Pcs	Remarks
	R16650	D0GB104JA041	M 100KOHM J 1/10W	1	
	R16651	D0GF202JA047	M 2KOHM,J,1/3W	1	
	R16652	ERJ6GEYF822	M 8.2KOHM,J,1/8W	1	
	R16653	ERJ8GEYJ182	M 1.8KOHM, J,1/4W	1	
	R16654	ERJ6GEYJ470V	M 47 OHM,J,1/8W	1	
	R16655	D0GB103JA057	M 10K OHM J 1/10W	1	
	R16656	ERJ8GEYJ472V	M 4.7KOHM, J,1/4W	1	
	R16658	ERJ3RBD6341	M6.34KOHM,D 1/16W	1	
	R16659	ERJ6GEY0R00V	M 0 OHM 1/8W	1	
	R16660	ERJ6GEYJ222V	M 2.2KOHM.J. 1/8W	1	
	R16661	D0GB122JA041	M 1.2KOHM J 1/10W	1	
	R16662	D1BB1002A087	M 10KOHM,J.1/10W	1	
	R16663	ERJ6RBD7151	M 7.15KOHM,D.1/10W	1	
	R16664	D0GF202JA047	M 2KOHM, J,1/3W	1	
	R16665	D0GD330JA059	M 33 OHM,F,1/4W	1	
	R16666	D1BB2202A087	M 22KOHM,J.1/10W	1	
	R16667	D0GF202JA047	M 2KOHM, J,1/3W	1	
	R16668	D0GF202JA047	M 2KOHM, J,1/3W	1	
	R16673	ERJ6GEYJ472V	M 4.7KOHM.J.1/8W	1	
	R16674	D0GF202JA047	M 2KOHM, J,1/3W	1	
	R16675	ERJ3GEYJ472	M 4.7KOHM,J,1/10W	1	
	R16677	D0GF202JA047	M 2KOHM, J,1/3W	1	
	R16678	D0GF202JA047	M 2KOHM, J,1/3W	1	
	R16679	ERJ3RBD1072	M10.7KOHM,D 1/16W	1	
	R16680	ERJ6GEYJ472V	M 4.7KOHM.J.1/8W	1	
	R16681	D0GD100JA059	M 10 OHM,J,1/4W	1	
	R16682	D0GD100JA059	M 10 OHM,J,1/4W	1	
	R16684	ERJ6GEYJ221V	M 220 OHM,J,1/8W	1	
	R16685	ERJ6GEYJ221V	M 220 OHM,J,1/8W	1	
	R16686	D0GB103JA057	M 10K OHM J 1/10W	1	
	R16687	D1BB2702A055	M 27KOHM,J.1/10W	1	
	R16688	D1BB8871A055	M8.87KOHM,J.1/10W	1	
	R16690	ERJ3GEYJ472	M 4.7KOHM,J,1/10W	1	
	R16691	ERJ8GEYJ563	M 56KOHM, J,1/4W	1	
	R16692	ERJ6RBD152	M 1.5KOHM,D.1/10W	1	
	R16694	ERJ8GEYJ563	M 56KOHM, J,1/4W	1	
	R16695	ERJ6RBD152	M 1.5KOHM,D.1/10W	1	
	R16696	ERF5TK2R2	W 2.2 OHM, K, 5W	1	
	R16699	D0GB103JA057	M 10K OHM J 1/10W	1	
	R16707	ERJ6GEYJ392	M 3.9KOHM,J,1/8W	1	
	R16711	ERJ3GEYJ472	M 4.7KOHM,J,1/10W	1	
	R16712	ERJ6GEYJ102V	M 1K OHM J 1/8W	1	
	R16717	D0GB102JA041	M 1KOHM,J,1/10W	1	
	R16719	ERJ3GEYJ220	M 22 OHM,J,1/10W	1	
	R16721	EXB38V220JV	M 22 OHM 1/16 W	1	
	R16742	D0GB473JA057	M 47KOHM, J,1/10W	1	
	R16745	D0GB474JA041	M 470KOHM,J,1/10W	1	
	R16746	ERJ6GEYF473	M 47KOHM,J,1/8W	1	
	R16747	ERJ6GEYJ222V	M 2.2KOHM.J. 1/8W	1	
	R16750	D0GD123JA059	M 12KOHM,J,1/4W	1	
	R16751	D0GD154JA059	M 150KOHM,J,1/4W	1	
	R16752	ERJ3GEYJ472	M 4.7KOHM,J,1/10W	1	
	R16753	ERJ6GEYF473	M 47KOHM,J,1/8W	1	
	R16755	D0GD123JA059	M 12KOHM,J,1/4W	1	
	R16756	D0GD123JA059	M 12KOHM,J,1/4W	1	
	R16761	D0GD100JA059	M 10 OHM,J,1/4W	1	
	R16763	D0GB473JA057	M 47KOHM,J,1/10W	1	

Safety	Ref. No.	Part No.	Part Name & Description	Pcs	Remarks
	R16765	D0GD100JA059	M 10 OHM,J,1/4W	1	
	R16769	D0GD750JA059	M 75 OHM,J,1/4W	1	
	R16772	ERJ3GEYJ472	M 4.7KOHM,J,1/10W	1	
	R16773	ERJ6GEYJ102V	M 1K OHM J 1/8W	1	
	R16774	ERG1SJ273	M 27KOHM, J, 1W	1	
	R16776	ERJ6GEYJ470V	M 47 OHM,J,1/8W	1	
	R16783	D0GD154JA059	M 150KOHM,J,1/4W	1	
	R16785	ERJ6ENF1073	M 107KOHM,F. 1/8W	1	
	R16786	ERJ6ENF1073	M 107KOHM,F. 1/8W	1	
	R16787	ERJ6ENF3302	M 33KOHM,F.1/8W	1	
	R16789	D0GB103JA057	M 10K OHM J 1/10W	1	
	R16791	D0GB102JA041	M 1KOHM,J,1/10W	1	
	R16797	ERJ6GEYJ220	M 22 OHM,J,1/8W	1	
	R16798	D0GB222JA041	M 2.2KOHM,J,1/10W	1	
	R16799	D0GB102JA041	M 1KOHM,J,1/10W	1	
	R16801	ERJ6RBD223V	M 22KOHM,D.1/10W	1	
	R16802	ERJ6RBD3092	M30.9KOHM,D.1/10W	1	
	R16804	ERJ8GEYJ112	M 1.1KOHM, J,1/4W	1	
	R16818	D1BB3302A055	M 33KOHM,J.1/10W	1	
	R16819	ERJ6ENF1503	M 150KOHM.F.1/8W	1	
	R16820	ERJ6ENF1503	M 150KOHM.F.1/8W	1	
	R16822	ERJ6ENF8202	M 82KOHM,F.1/8W	1	
	R16823	ERJ6ENF8202	M 82KOHM,F.1/8W	1	
	R16824	ERJ6ENF3302	M 33KOHM,F.1/8W	1	
	R16825	D0GD154JA059	M 150KOHM,J,1/4W	1	
	R16826	ERJ6GEYJ103V	M 10KOHM J 1/8W	1	
	R16827	D0GB222JA041	M 2.2KOHM,J,1/10W	1	
	R16829	D0GB102JA041	M 1KOHM,J,1/10W	1	
	R16831	ERJ6RBD6812	M68.1KOHM,D.1/10W	1	
	R16832	ERJ6RBD7152	M71.50KOHM,D.1/10W	1	
	R16837	D0GB102JA041	M 1KOHM,J,1/10W	1	
	R16838	ERG1FJS104D	M 100KOHM, J, 1W	1	
	R16841	ERJ3GEYJ472	M 4.7KOHM,J,1/10W	1	
	R16843	ERJ6GEYJ102V	M 1K OHM J 1/8W	1	
	R16844	ERA6YEB242	M 2.4KOHM, B 1/10W	1	
	R16845	ERJ6RBD6652	M66.5KOHM,D.1/10W	1	
	R16846	ERJ6RBD6492	M64.9KOHM,D.1/10W	1	
	R16849	ERJ6RBD6492	M64.9KOHM,D.1/10W	1	
	R16851	D0GB474JA041	M 470KOHM,J,1/10W	1	
	R16852	D0GB474JA041	M 470KOHM,J,1/10W	1	
	R16860	ERG2FNJS8R2E	M 8.2 OHM, J, 2W	1	
	R16870	ERJ14YJ683	M 68KOHM, J. 1/4W	1	
	R16873	ERA6YEB242	M 2.4KOHM, B 1/10W	1	
	R16891	D1BF6982A058	M 69.8KOHM, 1/4W	1	
	R16892	D1BF8252A058	M82.50KOHM, 1/4W	1	
	R16893	D1BF8252A058	M82.50KOHM, 1/4W	1	
	R16897	D1BB1001A055	M 1KOHM,J. 1/10W	1	
	R16898	D1BB1051A055	M1.05KOHM,J.1/10W	1	
	R16899	D1BB2741A055	M2.74KOHM,J.1/10W	1	
	R16900	D0GB103JA057	M 10K OHM J 1/10W	1	
	R16901	ERJ3GEYJ472	M 4.7KOHM,J,1/10W	1	
	R16904	ERJ6GEYJ223	M 22KOHM,J,1/8W	1	
	R16919	D1BB7501A055	M 7.5KOHM,J.1/10W	1	

Safety	Ref. No.	Part No.	Part Name & Description	Pcs	Remarks
	R16920	D0GB103JA057	M 10K OHM J 1/10W	1	
	R16921	D1BB1241A055	M1.24KOHM,J.1/10W	1	
	R16922	D1BB3481A055	M3.48KOHM,J.1/10W	1	
	R16923	D0GB103JA057	M 10K OHM J 1/10W	1	
	R16926	ERJ6GEYJ222V	M 2.2KOHM.J. 1/8W	1	
	R16927	ERJ6GEYJ223	M 22KOHM,J,1/8W	1	
	R16928	ERJ6GEYJ472V	M 4.7KOHM.J.1/8W	1	
	R16929	D0GF1R0JA047	M 1 OHM,J,1/3W	1	
	R16930	D1BF2R70A021	M 2.7 OHM, 1/4W	1	
	R16931	D1BF2R70A021	M 2.7 OHM, 1/4W	1	
	R16932	ERJ6GEYJ223	M 22KOHM,J,1/8W	1	
	R16933	D1BB1002A055	M 10KOHM,J.1/10W	1	
	R16934	D1BB6801A055	M 6.8KOHM,J.1/10W	1	
	R16935	D0GB512JA041	M 5.1KOHM,J,1/10W	1	
	R16936	D0GB222JA041	M 2.2KOHM,J,1/10W	1	
	R16937	D0GB184JA041	M 180KOHM J 1/10W	1	
	R16938	D0GB184JA041	M 180KOHM J 1/10W	1	
	R17101	ERJ6GEY0R00V	M 0 OHM 1/8W	1	
	R17103	EXB38V681J	M 680 OHM 1/16 W	1	
	R17104	EXB38V470J	M 47 OHM 1/16 W	1	
	R17105	EXB38V470J	M 47 OHM 1/16 W	1	
	R17106	D0GZ1R0JA020	M 1 OHM, J,1/2W	1	
	R17108	D0GB101JA041	M 100 OHM,J,1/10W	1	
	R17109	D0GB101JA041	M 100 OHM,J,1/10W	1	
	R17110	D0GB201JA041	M 200 OHM,J,1/10W	1	
	R17111	D0GZ1R0JA020	M 1 OHM, J,1/2W	1	
	R17113	D0GB101JA041	M 100 OHM,J,1/10W	1	
	R17114	D0GB101JA041	M 100 OHM,J,1/10W	1	
	R17115	D0GB201JA041	M 200 OHM,J,1/10W	1	
	R17116	D0GZ1R0JA020	M 1 OHM, J,1/2W	1	
	R17118	D0GB101JA041	M 100 OHM,J,1/10W	1	
	R17119	D0GB101JA041	M 100 OHM,J,1/10W	1	
	R17120	D0GB201JA041	M 200 OHM,J,1/10W	1	
	R17121	D0GZ1R0JA020	M 1 OHM, J,1/2W	1	
	R17123	D0GB101JA041	M 100 OHM,J,1/10W	1	
	R17124	D0GB101JA041	M 100 OHM,J,1/10W	1	
	R17125	D0GB201JA041	M 200 OHM,J,1/10W	1	
	R17126	D0GZ1R0JA020	M 1 OHM, J,1/2W	1	
	R17128	D0GB101JA041	M 100 OHM,J,1/10W	1	
	R17129	D0GB101JA041	M 100 OHM,J,1/10W	1	
	R17130	D0GB201JA041	M 200 OHM,J,1/10W	1	
	R17131	D0GZ1R0JA020	M 1 OHM, J,1/2W	1	
	R17133	D0GB101JA041	M 100 OHM,J,1/10W	1	
	R17134	D0GB101JA041	M 100 OHM,J,1/10W	1	
	R17135	D0GB201JA041	M 200 OHM,J,1/10W	1	
	R17136	D0GZ1R0JA020	M 1 OHM, J,1/2W	1	
	R17138	D0GB101JA041	M 100 OHM,J,1/10W	1	
	R17139	D0GB101JA041	M 100 OHM,J,1/10W	1	

Safety	Ref. No.	Part No.	Part Name & Description	Pcs	Remarks
	R17140	D0GB101JA041	M 100 OHM,J,1/10W	1	
	R17141	D0GZ1R0JA020	M 1 OHM, J,1/2W	1	
	R17143	D0GB101JA041	M 100 OHM,J,1/10W	1	
	R17144	D0GB101JA041	M 100 OHM,J,1/10W	1	
	R17145	D0GB101JA041	M 100 OHM,J,1/10W	1	
	R17146	D0GB681JA041	M 680 OHM,J,1/10W	1	
	R17147	ERJ6GEYJ224	M 220KOHM,J,1/8W	1	
	R17148	D0GF151JA047	M 150 OHM,J, 1/3W	1	
	R17150	D0GB102JA041	M 1KOHM,J,1/10W	1	
	R17151	D0GBR00Z0002	M 0 OHM J 1/10W	1	
	R17152	D0GBR00Z0002	M 0 OHM J 1/10W	1	
	R17153	D0GBR00Z0002	M 0 OHM J 1/10W	1	
	R17201	ERJ6GEYJ224	M 220KOHM,J,1/8W	1	
	R17202	EXB38V470J	M 47 OHM 1/16 W	1	
	R17203	EXB38V470J	M 47 OHM 1/16 W	1	
	R17204	EXB38V681J	M 680 OHM 1/16 W	1	
	R17205	EXB38V470J	M 47 OHM 1/16 W	1	
	R17206	EXB38V470J	M 47 OHM 1/16 W	1	
	R17207	EXB38V681J	M 680 OHM 1/16 W	1	
	R17208	EXB38V681J	M 680 OHM 1/16 W	1	
	R17210	D0GZ1R0JA020	M 1 OHM, J,1/2W	1	
	R17212	D0GB101JA041	M 100 OHM,J,1/10W	1	
	R17213	D0GB101JA041	M 100 OHM,J,1/10W	1	
	R17214	D0GB201JA041	M 200 OHM,J,1/10W	1	
	R17215	D0GZ1R0JA020	M 1 OHM, J,1/2W	1	
	R17217	D0GB101JA041	M 100 OHM,J,1/10W	1	
	R17218	D0GB101JA041	M 100 OHM,J,1/10W	1	
	R17219	D0GB201JA041	M 200 OHM,J,1/10W	1	
	R17220	D0GZ1R0JA020	M 1 OHM, J,1/2W	1	
	R17222	D0GB101JA041	M 100 OHM,J,1/10W	1	
	R17223	D0GB101JA041	M 100 OHM,J,1/10W	1	
	R17224	D0GB201JA041	M 200 OHM,J,1/10W	1	
	R17225	D0GZ1R0JA020	M 1 OHM, J,1/2W	1	
	R17227	D0GB101JA041	M 100 OHM,J,1/10W	1	
	R17228	D0GB101JA041	M 100 OHM,J,1/10W	1	
	R17229	D0GB201JA041	M 200 OHM,J,1/10W	1	
	R17230	D0GZ1R0JA020	M 1 OHM, J,1/2W	1	
	R17232	D0GB101JA041	M 100 OHM,J,1/10W	1	
	R17233	D0GB101JA041	M 100 OHM,J,1/10W	1	
	R17234	D0GB201JA041	M 200 OHM,J,1/10W	1	
	R17235	D0GZ1R0JA020	M 1 OHM, J,1/2W	1	
	R17237	D0GB101JA041	M 100 OHM,J,1/10W	1	
	R17238	D0GB101JA041	M 100 OHM,J,1/10W	1	
	R17239	D0GB201JA041	M 200 OHM,J,1/10W	1	
	R17240	D0GZ1R0JA020	M 1 OHM, J,1/2W	1	
	R17242	D0GB101JA041	M 100 OHM,J,1/10W	1	
	R17243	D0GB101JA041	M 100 OHM,J,1/10W	1	
	R17244	D0GB101JA041	M 100 OHM,J,1/10W	1	
	R17245	D0GB681JA041	M 680 OHM,J,1/10W	1	
	R17247	D0GF151JA047	M 150 OHM,J, 1/3W	1	

Safety	Ref. No.	Part No.	Part Name & Description	Pcs	Remarks
	R17260	ERJ6GEY0R00V	M 0 OHM 1/8W	1	
	R17261	D0GBR00Z0002	M 0 OHM J 1/10W	1	
	R17262	D0GBR00Z0002	M 0 OHM J 1/10W	1	
	R17263	D0GBR00Z0002	M 0 OHM J 1/10W	1	
	SC2	K1KY02B00012	2P CONNECTOR	1	
	SC20	K1MY35BA0345	35P CONNECTOR	1	
	SC41	K1KA09AA0707	9P CONNECTOR	1	
	SC42	K1KA09AA0707	9P CONNECTOR	1	
	SC46	K1KA09AA0707	9P CONNECTOR	1	
	SC50	K1KA02AA0193	2P CONNECTOR	1	
	SS11	K1KY03B00006	3P CONNECTOR	1	
	SS21	K1KA07A00170	7P CONNECTOR	1	
	SS24	K1KB07AA0087	7P CONNECTOR	1	
	SS33	K1KY08AA0719	8P CONNECTOR	1	
	SS58	K1MN13B00091	13P CONNECTOR	1	
	SS61	K1MN13B00091	13P CONNECTOR	1	
	SS64	K1MN13B00091	13P CONNECTOR	1	
	T16471	G4DYA0000200	SWITCHING TRANS	1	
	ZA16001	K4CD01000011	AV TERMINAL	1	
	ZA16002	K4CD01000011	AV TERMINAL	1	
	ZA16003	K4CD01000011	AV TERMINAL	1	
	ZA16401	K4CD01000011	AV TERMINAL	1	
	ZA16402	K4CD01000011	AV TERMINAL	1	
	ZA16403	K4CD01000011	AV TERMINAL	1	
	ZA16404	K4CD01000011	AV TERMINAL	1	
	ZA16407	K4CD01000011	AV TERMINAL	1	
	ZA17101	K4CD01000013	AV TERMINAL	1	
	ZA17102	K4CD01000013	AV TERMINAL	1	
	ZA17103	K4CD01000013	AV TERMINAL	1	
	ZA17104	K4CD01000013	AV TERMINAL	1	
	ZA17201	K4CD01000013	AV TERMINAL	1	
	ZA17202	K4CD01000013	AV TERMINAL	1	
	ZA17203	K4CD01000013	AV TERMINAL	1	
	ZA17204	K4CD01000013	AV TERMINAL	1	
	C100	F1J1C474A059	C 0.47 uF 16 V	1	
△	C101	F0CAF334A021	C 0.33UF, 250V	1	
△	C102	F1BAF221A131	C 220PF, 250V	1	
△	C103	F1BAF221A131	C 220PF, 250V	1	
△	C104	F0CAF474A021	C 0.47UF, 250V	1	
△	C105	F0CAF224A021	C 0.22UF, 250V	1	
△	C109	ECWF2W225X03	P 2.2UF, 450V	1	
	C111	ECJ1VB1H102K	C 1000 pF 50 V	1	
	C113	F1J1E225A209	C 2.2 UF 25V	1	
	C114	F1H1C224A065	C 0.22UF, 16V	1	
	C115	ECJ1VB1H103K	C 0.01UF, 50V	1	
	C116	ECJ1VB1H472K	C 4700PF, 50V	1	
	C118	ECJ1VB1H102K	C 1000 pF 50 V	1	
	C120	F1E2J4730001	C 0.047PF, , 630V	1	
	C122	ECKD3A102KBP	C 1000PF, 1KV	1	
	C123	ECKD3A102KBP	C 1000PF, 1KV	1	
△	C125	F2B2W3910011	E 390UF, 450V	1	
	C127	F1H1C105A148	C 1UF, 16V	1	
	C200	ECJ1VB1H102K	C 1000 pF 50 V	1	
△	C201	F2B2W220A032	E 22UF, 450V	1	
	C204	ECJ1VB1E104K	C 0.1 UF, 25V	1	
	C205	F1H1H222A219	C 2200PF, 50V	1	
	C207	F2A1H1000083	E 10UF, 50V	1	
△	C209	F1BAF221A131	C 220PF, 250V	1	
	C210	F2A1H4700057	E 47UF, 50V	1	
	C211	F1J1E225A209	C 2.2 UF 25V	1	
	C212	ECJ1VB1H102K	C 1000 pF 50 V	1	
△	C300	F1BAF221A131	C 220PF, 250V	1	
	C301	ECKD3A101KBP	C 100PF, 1KV	1	
△	C302	F1BAF221A131	C 220PF, 250V	1	
△	C314	ECWH8333HA	P 0.033 uF	1	
	C400	ECJ1VB1H102K	C 1000 pF 50 V	1	

Safety	Ref. No.	Part No.	Part Name & Description	Pcs	Remarks
	C401	F1A3A221A039	C 220PF 1KV	1	
	C402	F1H1C105A148	C 1UF, 16V	1	
	C403	F1J1E105A231	C 1 UF 25V	1	
	C406	F2A1H1000083	E 10UF, 50V	1	
△	C407	ECWF6103HLB	P 0.01UF, 630V	1	
	C410	ECQE6104KF	P 0.1UF, 630V	1	
	C411	ECJ2VB1H103K	C 0.01UF, 50V	1	
	C412	ECJ1VB1H103K	C 0.01UF, 50V	1	
	C413	ECJ1VB1H102K	C 1000 pF 50 V	1	
	C414	ECJ1VB1H103K	C 0.01UF, 50V	1	
	C500	ECJ1VB1E104K	C 0.1 UF, 25V	1	
	C505	F2A1A681B345	E 680UF, 10V	1	
	C519	ECJ1VB1H102K	C 1000 pF 50 V	1	
	C601	ECJ1VB1H103K	C 0.01UF, 50V	1	
	C603	ECJ1VB1H103K	C 0.01UF, 50V	1	
	C607	ECJ1VB1H103K	C 0.01UF, 50V	1	
	C616	ECJ1VB1H103K	C 0.01UF, 50V	1	
	C617	ECJ1VB1H103K	C 0.01UF, 50V	1	
	C623	F1J0J4750018	C 4.7UF, 6.3 V	1	
	C625	ECJ1VB1H102K	C 1000 pF 50 V	1	
	C627	ECJ2VB1H103K	C 0.01UF, 50V	1	
	C628	ECJ1VB1H103K	C 0.01UF, 50V	1	
	C700	F1J1E105A231	C 1 UF 25V	1	
	C703	ECJ1VB1H332K	C 3300PF, 50V	1	
	C706	F1H1C105A148	C 1UF, 16V	1	
	C707	F1J1E105A231	C 1 UF 25V	1	
	C709	F1J1E104A137	C 0.1UF, 25V	1	
	C711	ECJ1VB1H102K	C 1000 pF 50 V	1	
	C712	F1J1H471A721	C 470 pF 50 V	1	
	C713	F1J1E105A231	C 1 UF 25V	1	
	C714	F1J1H333A571	C 0.033UF, 50V	1	
	C715	F1J1H332A623	C 3300pF, 50V	1	
	C716	F1J1E105A231	C 1 UF 25V	1	
	C717	ECJ1VB1H103K	C 0.01UF, 50V	1	
	C718	ECJ1VB1H102K	C 1000 pF 50 V	1	
△	C720	F2BZZ1420005	E 1400UF	1	
	C721	F2A2T4210002	E 420UF, 220V	1	
	C724	ECJ1VB1H103K	C 0.01UF, 50V	1	
	C725	ECJ1VB1H103K	C 0.01UF, 50V	1	
	C726	F1J1H333A571	C 0.033UF, 50V	1	
	C727	ECJ1VB1E104K	C 0.1 UF, 25V	1	
	C728	ECJ1VB1E104K	C 0.1 UF, 25V	1	
	C729	F2A2T181A007	E 180UF, 220V	1	
	C730	F2A2T181A007	E 180UF, 220V	1	
	C731	F2A2T181A007	E 180UF, 220V	1	
	C800	F2A1E1020108	E 1000UF, 25V	1	
	C802	ECJ1VB1E104K	C 0.1 UF, 25V	1	
	C804	ECJ1VB1H103K	C 0.01UF, 50V	1	
	C805	F1J1E105A231	C 1 UF 25V	1	
	C806	F2A1E1020108	E 1000UF, 25V	1	
	C807	F1J1E105A231	C 1 UF 25V	1	
	C808	ECJ1VB1E104K	C 0.1 UF, 25V	1	
	C810	F1J1E105A231	C 1 UF 25V	1	
△	C901	F2BZZ1820005	E 1800UF	1	
	C902	F2A1H4700057	E 47UF, 50V	1	
	C903	F1J1H104A459	C 0.1 uF 50 V	1	
	C905	ECJ2VB1H103K	C 0.01UF, 50V	1	
	C906	F1H1H222A219	C 2200PF, 50V	1	
	C907	F1H1C105A148	C 1UF, 16V	1	
	C908	ECJ1VB1H102K	C 1000 pF 50 V	1	
	C909	F1J1H273A571	C 0.027UF, 50V	1	
	D100	B0FBAT000006	DIODE	1	
	D102	B0ACDD000001	DIODE	1	
	D103	B0BC01400033	ZENER DIODE	1	
	D104	B0JCME000093	DIODE	1	
	D106	B0EAKT000048	DIODE	1	
	D108	B0HAPR000016	DIODE	1	
	D109	B0HAPR000016	DIODE	1	
	D114	B0ACDJ000010	DIODE	1	
△	D200	B0EBKT000007	DIODE	1	
	D201	MTZJ10B	ZENER DIODE	1	
	D202	MTZJ10B	ZENER DIODE	1	

Safety	Ref. No.	Part No.	Part Name & Description	Pcs	Remarks
	D205	MTZJ10B	ZENER DIODE	1	
	D206	B0ACDJ000010	DIODE	1	
	D207	B0BB17000009	ZENER DIODE	1	
	D208	B0ECKM000046	DIODE	1	
	D209	B0ECKM000046	DIODE	1	
	D210	B0BA03300004	ZENER DIODE	1	
	D300	B0EAAD000001	DIODE	1	
	D301	B0EAAD000001	DIODE	1	
	D400	MTZJ4. 7B	ZENER DIODE	1	
	D401	MTZJ10B	ZENER DIODE	1	
	D402	B0JCC000002	DIODE	1	
	D404	MTZJ12B	ZENER DIODE	1	
	D405	B0BA05100010	ZENER DIODE	1	
	D406	B0EAKS000003	DIODE	1	
	D408	B0ECKM000046	DIODE	1	
	D410	B0HAMP000067	DIODE	1	
	D411	B0BC8R100015	ZENER DIODE	1	
	D501	B0JAMG000031	DIODE	1	
	D600	B0ACDJ000010	DIODE	1	
	D604	B0EAAD000001	DIODE	1	
	D605	B0EAAD000001	DIODE	1	
	D611	B0ACDJ000010	DIODE	1	
	D701	B0ECKM000046	DIODE	1	
	D702	B0HBRR000001	DIODE	1	
	D703	B0FBAR000044	DIODE	1	
	D706	B0BC5R600065	ZENER DIODE	1	
	D708	B0ACDJ000010	DIODE	1	
	D800	B0FBM000023	DIODE	1	
	D801	B0ACDJ000010	DIODE	1	
	D900	B0BA03600020	ZENER DIODE	1	
	D901	B0JCM0000093	DIODE	1	
	D902	B0EAMR000015	DIODE	1	
	D903	B0BA02100001	ZENER DIODE	1	
	D904	B0BA02100001	ZENER DIODE	1	
	D905	B0BA03600020	ZENER DIODE	1	
	D907	B0EAMR000015	DIODE	1	
	D908	B0BA01500003	ZENER DIODE	1	
△	F100	K5E802BZ0002	FUSE	1	
△	F101	K5E802BZ0002	FUSE	1	
△	F200	K5G631B00008	FUSE	1	
	IC100	C0DBZYY00361	IC	1	
	IC200	C0DBZMC00006	IC	1	
△	IC201	MIP2K20MSSCF	IC	1	
△	IC202	B3PBA0000459	IC	1	
△	IC400	MIP418AMDS	IC	1	
△	IC401	B3PBA0000459	IC	1	
	IC500	C0DBZMC00006	IC	1	
△	IC600	B3PBA0000459	IC	1	
△	IC601	B3PBA0000459	IC	1	
	IC602	C0EBH0000210	IC	1	
	IC603	C2ABDB000135	IC	1	
	IC700	LSSK0087	IC	1	
	IC701	C0DBZMC00006	IC	1	
	IC800	C0DBZMC00006	IC	1	
	IC901	C0DBZMC00006	IC	1	
	IC902	C0DBZYY00360	IC	1	
△	IC903	B3PBA0000459	IC	1	
	IC904	C0DBZMC00006	IC	1	
△	L100	G0B113J00004	CHOKE COIL	1	
△	L101	G0B113J00004	CHOKE COIL	1	
	L700	J0JCC0000119	CHIP INDUCTOR	1	
	P2	K1KY02BA0001	2P CONNECTOR	1	
	P6	K1KA11AA0082	11P CONNECTOR	1	
	P7	K1KA14AA0082	14P CONNECTOR	1	
	P9	K1KA02B00295	2P CONNECTOR	1	
	P11	K1KA03B00246	3P CONNECTOR	1	
	P25	K1KA10AA0082	10P CONNECTOR	1	
	P34	K1KA03AA0193	3P CONNECTOR	1	

Safety	Ref. No.	Part No.	Part Name & Description	Pcs	Remarks
	P35	K1KA03A00647	3P CONNECTOR	1	
△	PR101	K5Y502B00008	FUSE	1	
△	PR900	K5Y402B00006	FUSE	1	
	Q101	DSC5001R0L	TRANSISTOR	1	
	Q103	B1BCCF000022	TRANSISTOR	1	
△	Q104	B1CERR000045	FET	1	
	Q300	B1CHPD000008	FET	1	
	Q301	B1CHPD000008	FET	1	
△	Q302	B1CERQ000059	FET	1	
△	Q303	B1CERQ000059	FET	1	
	Q400	DSC5001R0L	TRANSISTOR	1	
	Q401	B1CFGD000030	FET	1	
	Q402	B1CFGD000030	FET	1	
	Q505	B1CHPD000008	FET	1	
	Q600	DSC5001R0L	TRANSISTOR	1	
	Q602	DSC5001R0L	TRANSISTOR	1	
	Q701	B1HBCFA00033	TRANSISTOR	1	
	Q703	B1ADCF000111	TRANSISTOR	1	
	Q705	B1CBGD000001	FET	1	
	Q706	B1HDCFA00001	TRANSISTOR	1	
	Q707	DSC5001R0L	TRANSISTOR	1	
	Q708	B1ADCF000111	TRANSISTOR	1	
	Q709	B1CFGD000030	FET	1	
	Q710	B1CFGD000030	FET	1	
	Q711	DSC5001R0L	TRANSISTOR	1	
	Q712	DSC5001R0L	TRANSISTOR	1	
	Q714	B1ADCF000116	TRANSISTOR	1	
	Q715	B1ADCF000116	TRANSISTOR	1	
	Q800	B1CHRD000028	TRANSISTOR	1	
	Q801	DSC5001R0L	TRANSISTOR	1	
	Q805	B1ADCF000111	TRANSISTOR	1	
	Q806	DSC5001R0L	TRANSISTOR	1	
	Q807	B1HBCFA00033	TRANSISTOR	1	
△	Q901	B1CERQ000057	FET	1	
	R101	D0GB394JA057	M 390KOHM J 1/10W	1	
△	R102	ERF5TJ100	W 10 OHM, J, 5W	1	
	R103	ERJ6GEYJ333V	M 33KOHM, J, 1/8W	1	
	R104	ERJ6GEYJ104V	M 100KOHM, J, 1/8W	1	
	R105	D1AB6343A023	M 634 KOHM, 1/4 W	1	
	R106	ERJ3GEYJ434	M 430KOHM, J, 1/10W	1	
	R107	D1AB6343A023	M 634 KOHM, 1/4 W	1	
	R108	ERJ3GEYJ223	M 22KOHM, J, 1/10W	1	
	R109	ERJ6GEYJ103V	M 10KOHM J 1/8W	1	
	R112	ERJ6GEYJ103V	M 10KOHM J 1/8W	1	
	R113	ERJ3EKF1002	M 10KOHM, 1/10W	1	
	R114	D0BF6R8JA035	M 6.8 OHM, J, 1/2W	1	
	R115	D0BF6R8JA035	M 6.8 OHM, J, 1/2W	1	
	R116	ERJ8GEYJ153	M 15KOHM, J, 1/4W	1	
	R117	ERJ8GEYJ153	M 15KOHM, J, 1/4W	1	
	R118	ERJ6GEYJ183V	M 18KOHM, J, 1/8W	1	
	R119	D0GB103JA057	M 10K OHM J 1/10W	1	
	R121	ERJ3GEYJ333	M 33 KOHM, J, 1/10W	1	
	R122	ERX12SJR7	M 4.7 OHM, J, 1/2W	1	
	R123	D0GB103JA057	M 10K OHM J 1/10W	1	
	R125	DOXGR10J0003	M 0.10 OHM, J, 5W	1	
	R126	DOXGR10J0003	M 0.10 OHM, J, 5W	1	
	R127	ERJ6GEYJ331V	M 330 OHM J 1/8W	1	
	R128	ERJ6GEYJ103V	M 10KOHM J 1/8W	1	
	R129	D0GD4R7JA059	M 4.7 OHM, J, 1/4W	1	
	R130	ERJ3GEYOR00	M 0 OHM, 1/10W	1	
	R131	ERJ6GEYOR00V	M 0 OHM 1/8W	1	
	R132	ERJ6GEYOR00V	M 0 OHM 1/8W	1	
	R133	D1AB1004A023	M 1MOHM 1/4 W	1	

Safety	Ref. No.	Part No.	Part Name & Description	Pcs	Remarks
	R134	D1AB1004A023	M 1MOHM 1/4 W	1	
	R136	ERJ6GEYJ104V	M 100KOHM,J,1/8W	1	
	R137	ERJ8GEYJ474	M470KOHM, J,1/4W	1	
	R138	ERJ6GEYJ123V	M 12KOHM,J,1/8W	1	
	R139	ERJ6RBD123V	M 12KOHM,D.1/10W	1	
	R141	EVMAASA00B23	CONTROL 2KOHMB	1	
	R147	D1AB8453A023	M 845 KOHM, 1/4 W	1	
	R148	D1AB8453A023	M 845 KOHM, 1/4 W	1	
	R150	ERJ6ENF9101	M 9.1KOHM,F.1/8W	1	
	R200	D1AB3303A023	M330 KOHM, 1/4 W	1	
	R201	D1AB3303A023	M330 KOHM, 1/4 W	1	
	R203	D1AB3303A023	M330 KOHM, 1/4 W	1	
	R204	D1AB3303A023	M330 KOHM, 1/4 W	1	
	R206	ERJ6ENF3302	M 33KOHM,F.1/8W	1	
	R207	ERJ6ENF1272	M12.7KOHM,F.1/8W	1	
	R208	ERJ6GEYJ222V	M 2.2KOHM.J. 1/8W	1	
	R209	D0GB102JA057	M 1KOHM,J,1/10W	1	
	R211	ERJ6GEYJ224	M 220KOHM,J,1/8W	1	
	R214	ERJ6GEYJ153V	M 15KOHM,J,1/8W	1	
	R215	ERJ6GEY0R00V	M 0 OHM 1/8W	1	
	R216	D0GD4R7JA059	M 4.7 OHM,J,1/4W	1	
	R217	D0GD4R7JA059	M 4.7 OHM,J,1/4W	1	
⚠	R218	D0B1825JA033	M 8.2 MOHM J 1 W	1	
	R300	D0GZ181JA020	M 180 OHM,J,1/2W	1	
	R301	D0GZ181JA020	M 180 OHM,J,1/2W	1	
	R302	ERJ8GEYJ220V	M 22 OHM, J,1/4W	1	
	R303	ERJ8GEYJ220V	M 22 OHM, J,1/4W	1	
	R304	D0CF240JA010	M 24 OHM, J,1/2W	1	
	R305	D0CF240JA010	M 24 OHM, J,1/2W	1	
	R400	ERJ6GEYJ562V	M 5.6KOHM,J.1/8W	1	
	R401	ERJ6GEYJ203	M 20KOHM,J,1/8W	1	
	R403	ERJ6GEYJ302V	M 3KOHM,J,1/8W	1	
	R404	ERG2SJV563	M 56KOHM, J, 2W	1	
	R405	D0GD4R7JA059	M 4.7 OHM,J,1/4W	1	
	R406	D0GD123JA059	M 12 kohm F 1/4 W	1	
	R407	ERG2SJV563	M 56KOHM, J, 2W	1	
	R408	D0GD123JA059	M 12 kohm F 1/4 W	1	
	R409	ERJ3GEYJ273	M 27KOHM,J,1/10W	1	
	R410	ERJ3GEYJ273	M 27KOHM,J,1/10W	1	
	R411	ERJ6GEYJ104V	M 100KOHM,J,1/8W	1	
	R412	ERJ6GEYJ102V	M 1K OHM J 1/8W	1	
	R413	ERJ3GEYJ104	M 100KOHM,J,1/10W	1	
	R414	D0GB105JA057	M 1MOHM F 1/10W	1	
	R415	ERJ6GEYJ103V	M 10KOHM J 1/8W	1	
	R416	D1AB7503A023	M 750 KOHM, 1/4 W	1	
	R417	D1AB6343A023	M 634 KOHM, 1/4 W	1	
	R418	ERJ6ENF1003	M100KOHM,F. 1/8W	1	
	R500	ERJ6GEYJ221V	M 220 OHM,J,1/8W	1	
	R502	ERJ3GEYJ332	M 3.3KOHM,J,1/10W	1	
	R503	ERJ3GEYJ472	M 4.7KOHM,J,1/10W	1	
	R507	ERJ6RBD333	M 33KOHM,D.1/10W	1	
	R508	ERJ6RBD333	M 33KOHM,D.1/10W	1	
	R517	ERJ6GEYJ103V	M 10KOHM J 1/8W	1	
	R518	ERJ3GEYJ104	M 100KOHM,J,1/10W	1	
	R601	D0GB102JA057	M 1KOHM,J,1/10W	1	
	R602	ERJ3GEYJ224	M 220KOHM,J,1/10W	1	
	R604	ERJ3GEYJ104	M 100KOHM,J,1/10W	1	
	R605	ERJ3GEYJ224	M 220KOHM,J,1/10W	1	
	R608	ERJ6GEYJ102V	M 1K OHM J 1/8W	1	
	R609	ERJ3GEYJ104	M 100KOHM,J,1/10W	1	
	R610	ERJ6GEYJ101V	M 100 OHM,J,1/8W	1	

Safety	Ref. No.	Part No.	Part Name & Description	Pcs	Remarks
	R611	ERJ3GEYJ101	M 100 OHM,J,1/10W	1	
	R613	D0GB154JA057	M 150KOHM J 1/10W	1	
	R615	D0GB182JA057	M 1.8KOHM J 1/10W	1	
	R616	ERJ3GEYJ104	M 100KOHM,J,1/10W	1	
	R619	ERJ6GEYJ101V	M 100 OHM,J,1/8W	1	
	R620	D0GB102JA057	M 1KOHM,J,1/10W	1	
	R622	D0GB102JA057	M 1KOHM,J,1/10W	1	
	R623	ERJ3GEYJ104	M 100KOHM,J,1/10W	1	
	R624	ERJ6GEY0R00V	M 0 OHM 1/8W	1	
	R625	ERJ6ENF2701	M 2.7KOHM,F.1/8W	1	
	R626	ERJ3EKF3302	M 33KOHM, 1/10W	1	
	R627	D0GB103JA057	M 10K OHM J 1/10W	1	
	R628	ERJ3GEYJ222	M 2.2KOHM,J,1/10W	1	
	R630	ERJ6GEYJ101V	M 100 OHM,J,1/8W	1	
	R632	ERJ3GEYJ224	M 220KOHM,J,1/10W	1	
	R633	ERJ6GEY0R00V	M 0 OHM 1/8W	1	
	R635	ERJ3GEYJ472	M 4.7KOHM,J,1/10W	1	
	R637	ERJ6RBD152	M 1.5 kohm D 1/10 W	1	
	R639	ERJ3EKF10R0	M 10 OHM, 1/10W	1	
	R641	ERJ3GEYJ472	M 4.7KOHM,J,1/10W	1	
	R643	ERJ6GEYJ103V	M 10KOHM J 1/8W	1	
	R644	ERJ8GEYJ330	M 33 OHM, J,1/4W	1	
	R645	ERJ3GEYJ333	M 33 KOHM,J,1/10W	1	
	R646	D0GB102JA057	M 1KOHM,J,1/10W	1	
	R647	D0GB103JA057	M 10K OHM J 1/10W	1	
	R649	ERJ6GEYJ101V	M 100 OHM,J,1/8W	1	
	R652	ERJ6GEYJ392	M 3.9KOHM,J,1/8W	1	
	R653	ERJ6GEYJ392	M 3.9KOHM,J,1/8W	1	
	R661	ERJ6GEY0R00V	M 0 OHM 1/8W	1	
	R662	ERJ3GEYJ104	M 100KOHM,J,1/10W	1	
	R663	ERJ3GEYJ104	M 100KOHM,J,1/10W	1	
	R700	D0GD4R7JA059	M 4.7 OHM,J,1/4W	1	
	R702	ERJ3GEYJ101	M 100 OHM,J,1/10W	1	
	R703	ERJ6GEYJ105	M 1 kohm G 1/8 W	1	
	R704	ERJ6GEYJ100V	M 10 OHM,J,1/8W	1	
	R706	ERJ8ENF1500	M 150 OHM, 1/8W	1	
	R707	ERJ3EKF2702V	M27.0KOHM, 1/10W	1	
	R708	ERJ6GEYJ681	M 680 OHM,G,1/8W	1	
	R709	ERJ3EKF2202	M 22KOHM ,F 1/10W	1	
	R711	ERJ3EKF3302	M 33KOHM, 1/10W	1	
	R712	ERJ6GEY0R00V	M 0 OHM 1/8W	1	
	R714	ERJ6GEYJ102V	M 1K OHM J 1/8W	1	
	R726	ERJ6GEY0R00V	M 0 OHM 1/8W	1	
	R727	ERJ6ENF1201	M 1.2KOHM,F. 1/8W	1	
	R728	ERJ6GEYJ101V	M 100 OHM,J,1/8W	1	
	R729	ERJ6GEYJ100V	M 10 OHM,J,1/8W	1	
	R730	ERJ8GEYJ472V	M 4.7KOHM, J,1/4W	1	
	R731	ERJ6GEYJ4R7	M 4.7 OHM,J,1/8W	1	
	R732	ERJ6ENF1802	M 18KOHM,F.1/8W	1	
	R733	ERJ6GEYJ4R7	M 4.7 OHM,J,1/8W	1	
	R734	ERJ6GEYJ101V	M 100 OHM,J,1/8W	1	
	R736	ERJ6GEYJ101V	M 100 OHM,J,1/8W	1	
	R739	ERJ6ENF3901	M 3.9KOHM,F.1/8W	1	
	R740	ERJ3GEYJ331	M 330 OHM,J,1/10W	1	
	R741	ERJ6ENF6201	M 6.2KOHM,F.1/8W	1	
	R742	ERJ6ENF1003	M100KOHM,F. 1/8W	1	
	R743	ERJ6ENF1002	M 10KOHM,F. 1/8W	1	

Safety	Ref. No.	Part No.	Part Name & Description	Pcs	Remarks
	R744	ERJ6ENF1001	M 1KOHM, F. 1/8W	1	
	R745	ERJ6GEYJ333V	M 33KOHM, J, 1/8W	1	
	R746	ERJ6GEYJ103V	M 10KOHM J 1/8W	1	
	R749	ERJ6GEYOR00V	M 0 OHM 1/8W	1	
	R750	ERJ6ENF1002	M 10KOHM, F. 1/8W	1	
	R752	ERJ6GEYF473	M 47KOHM, J, 1/8W	1	
	R753	ERJ6ENF9102	M 91KOHM, F. 1/8W	1	
	R754	ERJ6ENF9102	M 91KOHM, F. 1/8W	1	
	R755	ERJ6ENF9102	M 91KOHM, F. 1/8W	1	
	R756	ERJ6ENF9102	M 91KOHM, F. 1/8W	1	
	R757	ERJ6ENF6802	M 68KOHM, F. 1/8W	1	
	R758	ERJ6ENF1503	M 150KOHM, F. 1/8W	1	
	R759	ERJ6ENF1503	M 150KOHM, F. 1/8W	1	
	R760	ERJ6ENF1503	M 150KOHM, F. 1/8W	1	
	R761	ERJ6ENF1503	M 150KOHM, F. 1/8W	1	
	R762	ERJ6ENF1603	M 160KOHM, F. 1/8W	1	
	R763	ERJ6ENF1502	M 150KOHM, F. 1/8W	1	
	R764	ERJ6ENF8201	M 8.2KOHM, F. 1/8W	1	
	R766	ERJ6GEYJ104V	M 100KOHM, J, 1/8W	1	
	R767	ERJ6GEYJ101V	M 100 OHM, J, 1/8W	1	
	R770	DOXGR01JA028	M 0.01 OHM, J, 5W	1	
	R773	ERJ6ENF1802	M 18KOHM, F. 1/8W	1	
	R774	ERJ6GEYJ103V	M 10KOHM J 1/8W	1	
	R775	ERJ6ENF1802	M 18KOHM, F. 1/8W	1	
	R776	ERJ6GEYJ103V	M 10KOHM J 1/8W	1	
	R777	ERJ6GEYJ104V	M 100KOHM, J, 1/8W	1	
	R778	ERJ6GEYF473	M 47KOHM, J, 1/8W	1	
	R779	ERJ6GEYF473	M 47KOHM, J, 1/8W	1	
	R780	ERJ6GEYOR00V	M 0 OHM 1/8W	1	
	R781	ERJ6GEYOR00V	M 0 OHM 1/8W	1	
	R783	ERJ6ENF2003	M 200KOHM, F. 1/8W	1	
	R784	ERJ6ENF3303	M 330KOHM, F. 1/8W	1	
	R785	ERJ6GEYJ102V	M 1K OHM J 1/8W	1	
	R786	ERJ6GEYJ104V	M 100KOHM, J, 1/8W	1	
	R787	ERJ3GEYJ331	M 330 OHM, J, 1/10W	1	
	R788	ERJ6GEYJ101V	M 100 OHM, J, 1/8W	1	
	R789	ERJ3GEYJ334	M 330KOHM, J, 1/10W	1	
	R790	ERJ3EKF3301	M 3.3KOHM, 1/10W	1	
	R792	ERJ3GEYOR00	M 0 OHM, 1/10W	1	
	R793	ERJ3GEYOR00	M 0 OHM, 1/10W	1	
	R798	ERJ3GEYOR00	M 0 OHM, 1/10W	1	
	R800	ERJ6GEYJ102V	M 1K OHM J 1/8W	1	
	R801	ERJ6GEYJ562V	M 5.6KOHM, J, 1/8W	1	
	R802	ERJ3GEYJ431V	M 430 OHM, J, 1/10W	1	
	R803	ERJ6RBD333	M 33KOHM, D, 1/10W	1	
	R804	ERJ6RBD622	M 6.2KOHM, D, 1/10W	1	
	R807	ERJ3GEYD274V	M 270KOHM, D, 1/10W	1	
	R808	DOGB102JA057	M 1KOHM, J, 1/10W	1	
	R809	DOGB184JA057	M 180KOHM J 1/10W	1	
	R810	DOGB473JA057	M 47KOHM, J, 1/10W	1	
	R811	ERJ3GEYJ104	M 100KOHM, J, 1/10W	1	
	R812	ERJ6GEYJ103V	M 10KOHM J 1/8W	1	
	R900	ERJ8GEYJ222V	M 2.2KOHM, J, 1/4W	1	
	R901	ERJ6GEYOR00V	M 0 OHM 1/8W	1	
	R902	DOGF101JA047	M 100 OHM, J, 1/3W	1	
	R903	DOXGR05JA028	M 0.05 OHM, J, 5W	1	
	R905	ERJ8GEYJ103	M 10KOHM, J, 1/4W	1	
	R906	ERJ8GEYJ222V	M 2.2KOHM, J, 1/4W	1	
	R907	ERJ6ENF3301	M 3.3KOHM, F. 1/8W	1	
	R908	ERJ6ENF3301	M 3.3KOHM, F. 1/8W	1	
	R909	DOGB473JA057	M 47KOHM, J, 1/10W	1	
	R910	ERJ3GEYJ333	M 33 KOHM, J, 1/10W	1	
	R911	ERJ3GEYD153V	M 15KOHM, D, 1/10W	1	
	R912	ERJ6GEYJ331V	M 330 OHM J 1/8W	1	

Safety	Ref. No.	Part No.	Part Name & Description	Pcs	Remarks
	R913	ERJ6RBD152	M 1.5 kOHM D 1/10 W	1	
	R914	ERJ6GEYJ102V	M 1K OHM J 1/8W	1	
	R915	ERJ6GEYOR00V	M 0 OHM 1/8W	1	
	R916	ERJ6ENF1103	M 110KOHM, F. 1/8W	1	
	R917	ERJ6ENF1003	M100KOHM, F. 1/8W	1	
	R918	ERJ6ENF8201	M 8.2KOHM, F. 1/8W	1	
	R919	ERJ6GEYOR00V	M 0 OHM 1/8W	1	
	R921	ERJ8GEYJ101V	M 100 OHM, J, 1/4W	1	
	R922	ERX12SJSR6	M 5.6 OHM, J, 1/2W	1	
	R923	EVMAASA00B23	CONTROL 2KOHMB	1	
	R924	ERJ8GEYJ103	M 10KOHM, J, 1/4W	1	
	R926	ERJ6ENF2003	M 200KOHM, F. 1/8W	1	
	R927	ERJ6ENF2003	M 200KOHM, F. 1/8W	1	
	R928	ERJ6ENF2202	M 2.2KOHM, F. 1/8W	1	
	R933	ERJ8GEYJ101V	M 100 OHM, J, 1/4W	1	
	R941	DOXGR10J0003	M 0.10 OHM, J, 5W	1	
	R942	ERJ6GEYJ222V	M 2.2KOHM, J, 1/8W	1	
	R943	ERJ6GEYJ223	M 22KOHM, J, 1/8W	1	
	R944	ERJ6ENF1001	M 1KOHM, F. 1/8W	1	
	R945	ERJ6ENF9102	M 91KOHM, F. 1/8W	1	
	R946	ERJ6GEYF473	M 47KOHM, J, 1/8W	1	
	R947	ERJ6GEYF473	M 47KOHM, J, 1/8W	1	
	R948	ERJ6GEYJ223	M 22KOHM, J, 1/8W	1	
	R949	ERJ6GEYOR00V	M 0 OHM 1/8W	1	
	R950	ERJ6ENF4702	M 47KOHM, F. 1/8W	1	
	△	RL101	K6B1AYY00057 RELAY	1	
	△	RL102	K6B1AYY00057 RELAY	1	
	△	S102	J0LV00000011 SERGE ABSORBER	1	
		T100	ETS42AY14GAD SWITCHING TRANSFORMER	1	
	△	T200	ETS15AC116AH SWITCHING TRANSFORMER	1	
	△	T300	G4DYA0000194 SWITCHING TRANSFORMER	1	
	△	T301	ETS42LZ1BGAD SWITCHING TRANSFORMER	1	
	△	T400	ETS29AZ31GAD SWITCHING TRANSFORMER	1	
		T900	ETS28AU3KGAD SWITCHING TRANSFORMER	1	
		TP700	GOZZ00002183 PEAKING COIL	1	
		TP900	GOZZ00002183 PEAKING COIL	1	
		VR251	EVMAASA00B33 CONTROL 3KOHMB	1	
		X600	H2B400400021 CRYSTAL	1	
		Z1	K4CZ01000027 AV TERMINAL	1	
		Z2	K4CZ01000027 AV TERMINAL	1	
		Z3	K4CZ01000027 AV TERMINAL	1	
	△	ZN100	D4EAD6210001 VARISTOR	1	
	△	ZN101	D4EAB681A011 VARISTOR	1	
	△	ZN102	D4EAD6210001 VARISTOR	1	
	△	ZN200	D4EA8511A001 VARISTOR	1	
	△	ZN201	D4EA8511A001 VARISTOR	1	