

# 13 Exploded View and Replacement Parts List

## 13.1. Exploded View and Mechanical Replacement Parts List

### 13.1.1. Exploded View

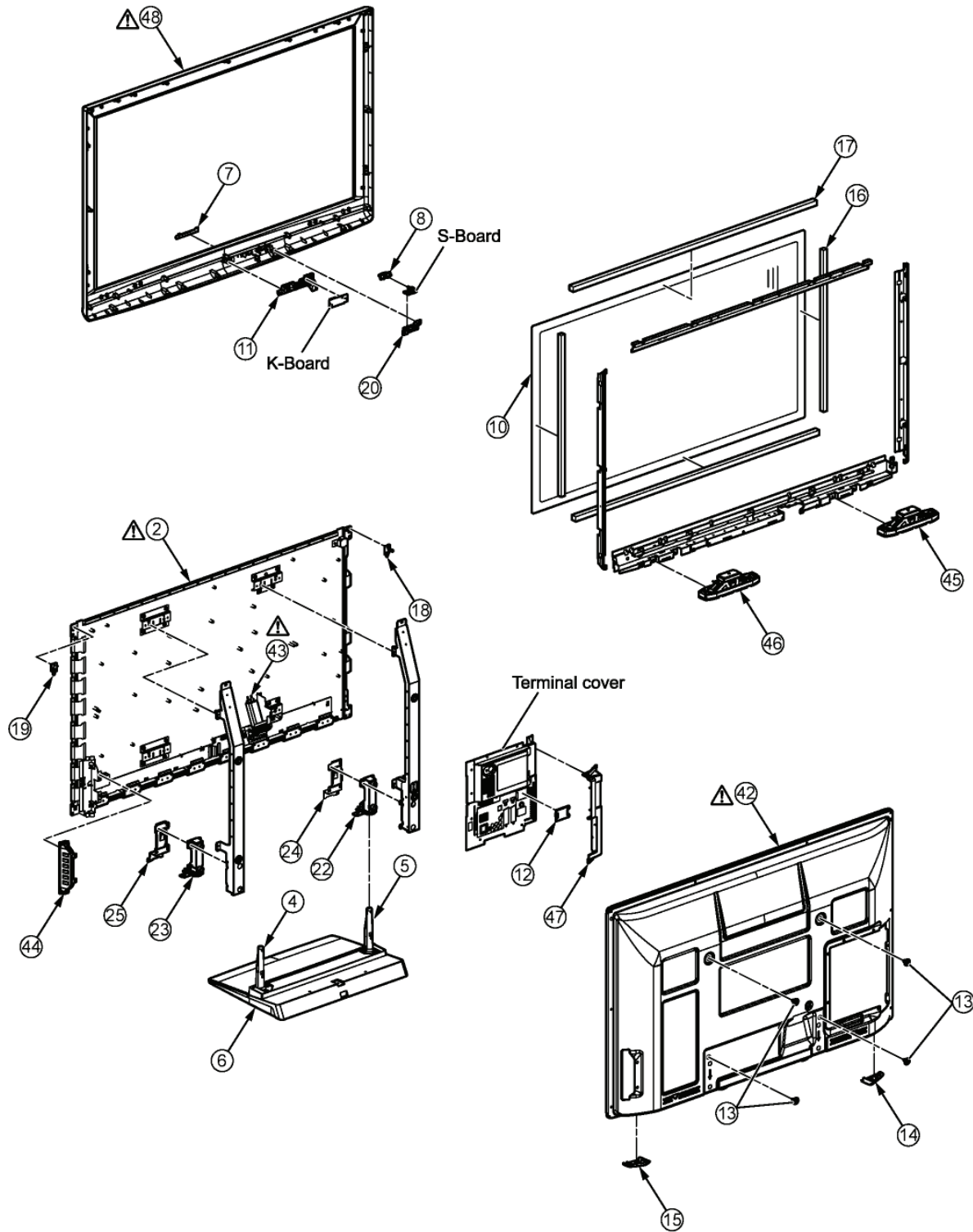

### 13.1.2. Packing 1

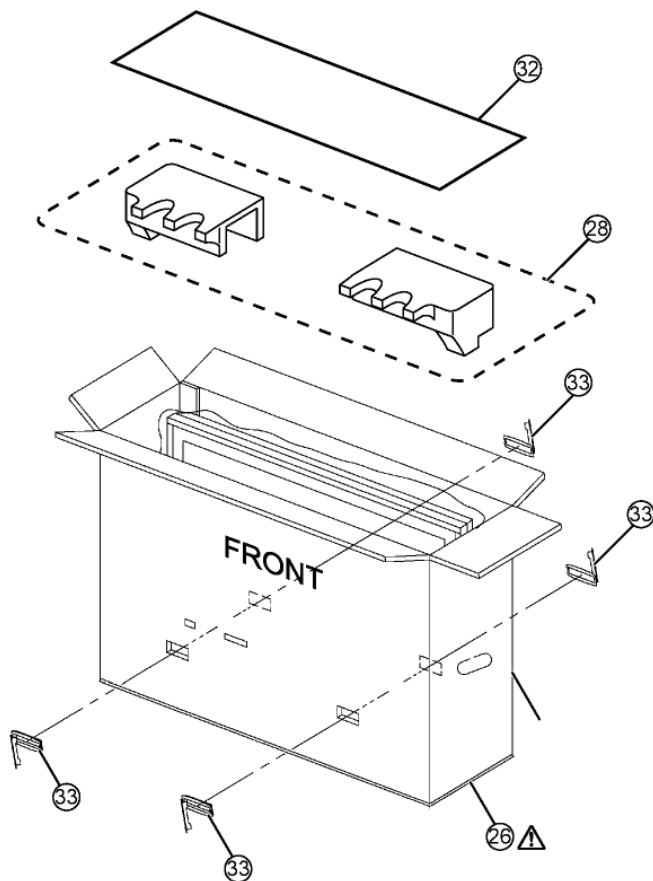



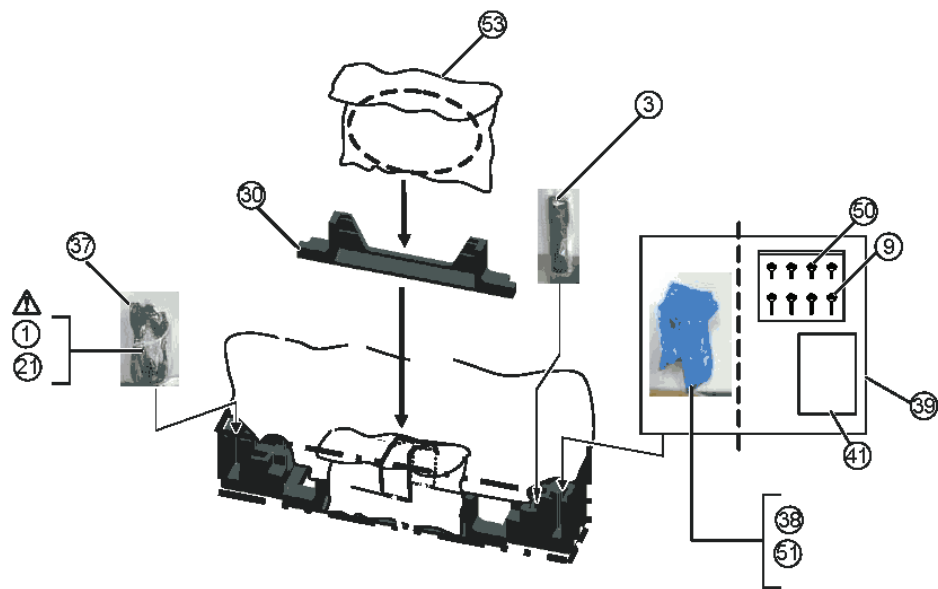
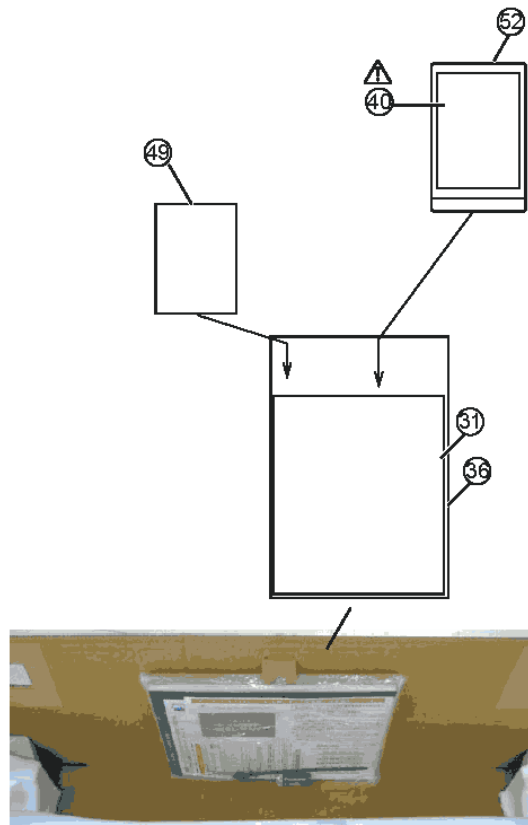
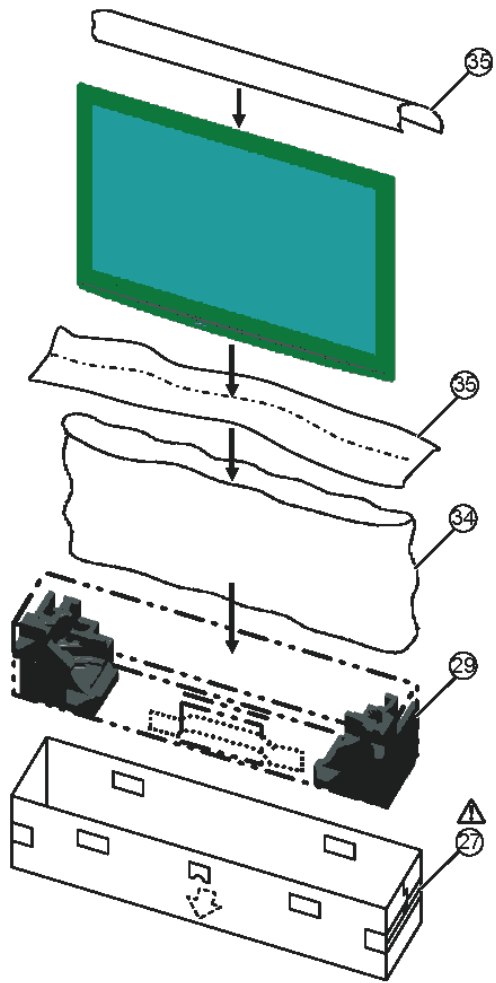

























### 13.1.3. Packing 2





#### 13.1.4. Mechanical Replacement Parts List

**Note:** All parts except parts mentioned [PAVCCZ] in the Remarks column are supplied by AVC-CSPC.  
Parts mentioned [PAVCCZ] are supplied by PAVCCZ.

Safety	Ref. No.	Part No.	Part Name & Description	Q'ty	Remarks
	1	K2CN3YY00004	AC CORD	1	PAVCCZ
	2	MD42H12A2J	PLASMA DISPLAY PANEL	1	PAVCCZ
	3	N2QAYB000328	REMOTE CONTROL	1	PAVCCZ
	4	TBLA3685	STAND POLE R	1	PAVCCZ
	5	TBLA3686	STAND POLE L	1	PAVCCZ
	6	TBLX0096	PEDESTAL STAND	1	PAVCCZ
	7	TBMA282	PANASONIC BADGE	1	
	8	TBX3EA00201	POWER BUTTON	1	PAVCCZ
		THEJ016J	SCREW (AC INRET:2)	2	
		THEL0429	SCREW	11	
		THEL052Z	SCREW (BC TOP:4)	2	
	9	THEL061N	SCREW (STAND-TV)	4	
		THEL069J	SCREW	55	
		THTD020J	SCREW (A-PRINT:4)	4	
		THTF013J	SCREW	2	
	10	TKGA5543	FRONT GLASS	1	
	11	TKK3EC5002	LED PANEL	1	PAVCCZ
	12	TKK3EL5001-1	ADJUSTMENT COVER	1	PAVCCZ
	13	TKKL5472	M8 CAP	4	
	14	TKR0E1901	REAR COVER HANDLE L	1	PAVCCZ
	15	TKR0E2001	REAR COVER HANDLE R	1	PAVCCZ
	16	TMK0EG010	SPONGE (LEFT/RIGHT)	2	PAVCCZ
	17	TMK0EG011	SPONGE (UPPER/BOTTOM)	2	PAVCCZ
		TMM23417	CLAMPER	2	
	18	TMD014-1	REAR COVER HOOK L	1	
	19	TMD015-1	REAR COVER HOOK R	1	
		TMME061	CLAMPER	1	
		TMME224	CLAMPER	4	
		TMME287	CLAMPER	2	
		TMME292	CLAMPER	2	
		TMME308	CLAMPER (GLASS HOLDER BOTTOM FRONT)	1	
		TMME331	CLAMPER	2	
		TMME332	CLAMPER	3	
		TMME332	CLAMPER (SS:1)	1	
		TMME332	CLAMPER (GLASS HOLDER REAR BOTTOM)	2	
		TMME341	CLAMPER	2	
		TMME345	SPACER	1	
	20	TMW3EC002	POWER BUTTON BRACKET	1	PAVCCZ
	21	TMXX055	AC CORD CLAMPER	2	
		TMXX062	AC CODE HOLDER	1	
	22	TMZ0E9911	STAND BRACKET L	1	PAVCCZ
	23	TMZ0E9912	STAND BRACKET R	1	PAVCCZ
	24	TMZX5167	STAND BRACKET METAL L	1	

Safety	Ref. No.	Part No.	Part Name & Description	Q'ty	Remarks
	25	TMZX5168	STAND BRACKET METAL R	1	
	26	TPC0E53401	CARTON BOX TOP	1	PAVCCZ
	27	TPC0E53500	CARTON BOX BOTTOM	1	PAVCCZ
	28	TPD0E1078	TOP CUSHION	1	PAVCCZ
	29	TPD0E2059	BOTTOM CUSHION	1	PAVCCZ
	30	TPD0E2078	PEDESTAL CUSHION	1	PAVCCZ
	31	TPD0E9137	ACCESSORIES PAD	1	PAVCCZ
	32	TPD0E9157	TOP PAD	1	PAVCCZ
	33	TPD169487	JOINT	4	
	34	TPE0E4010	PROTECT COVER	1	PAVCCZ
	35	TPE0E4041	PROTECT SHEET	2	PAVCCZ
	36	TPE0E9002	ACCESSORIES BAG	1	PAVCCZ
	37	TPE0E9003	BAG FOR AC CORD	1	PAVCCZ
	53	TPEB331-1	BAG (PEDESTAL STAND)	1	
	38	TPEB336	BAG (STAND POLE R)	1	
	39	TPEB338	BAG (STAND ACCESSORY)	1	PAVCCZ
		TPG0E9310	PAPER CAP	0.25	PAVCCZ
	40	TQB0E0825A	INSTRUCTION BOOK (GERMAN)	1	PAVCCZ
	40	TQB0E0825B	INSTRUCTION BOOK (DUTCH)	1	PAVCCZ
	40	TQB0E0825C	INSTRUCTION BOOK (ITALIAN)	1	PAVCCZ
	40	TQB0E0825D	INSTRUCTION BOOK (FRENCH)	1	PAVCCZ
	40	TQB0E0825E	INSTRUCTION BOOK (SPANISH)	1	PAVCCZ
	40	TQB0E0825F	INSTRUCTION BOOK (SWEDISH)	1	PAVCCZ
	40	TQB0E0825G	INSTRUCTION BOOK (NORWEGIAN)	1	PAVCCZ
	40	TQB0E0825H	INSTRUCTION BOOK (FINNISH)	1	PAVCCZ
	40	TQB0E0825I	INSTRUCTION BOOK (LITHUANIAN)	1	PAVCCZ
	40	TQB0E0825J	INSTRUCTION BOOK (PORTUGUESE)	1	PAVCCZ
	40	TQB0E0825K	INSTRUCTION BOOK (DANISH)	1	PAVCCZ
	40	TQB0E0825M	INSTRUCTION BOOK (BULGARIAN)	1	PAVCCZ
	40	TQB0E0825N	INSTRUCTION BOOK (ROMANIAN)	1	PAVCCZ
	40	TQB0E0825O	INSTRUCTION BOOK (LATVIAN)	1	PAVCCZ
	40	TQB0E0825P	INSTRUCTION BOOK (POLISH)	1	PAVCCZ
	40	TQB0E0825Q	INSTRUCTION BOOK (HUNGARIAN)	1	PAVCCZ
	40	TQB0E0825R	INSTRUCTION BOOK (CZECH)	1	PAVCCZ
	40	TQB0E0825S	INSTRUCTION BOOK (GREEK)	1	PAVCCZ
	40	TQB0E0825T	INSTRUCTION BOOK (TURKISH)	1	PAVCCZ
	40	TQB0E0825U	INSTRUCTION BOOK (ENGLISH)	1	PAVCCZ
	40	TQB0E0825W	INSTRUCTION BOOK (SLOVAKIAN)	1	PAVCCZ
	40	TQB0E0825X	INSTRUCTION BOOK (CD-ROM)	1	PAVCCZ
	40	TQB0E0825Z	INSTRUCTION BOOK (ESTONIAN)	1	PAVCCZ
	41	TQZJ060	SCREW USE HANDBILL	1	PAVCCZ
		TSXL519	CABLE (SU11-SD11)	1	
		TSXL733	CABLE (A20-SC20)	1	

Safety	Ref. No.	Part No.	Part Name & Description	Q'ty	Remarks
		TSXL737	CABLE (C10-C20)	1	
		TSXL757	CABLE (C21-A31)	1	
		TSXL760	CABLE (C22-A32)	1	
	42	TTU0E0568	REAR COVER	1	PAVCCZ
	43	TXAJS01EQUE	AC INLET ASSY	1	PAVCCZ
	44	TXFBX03EQUE	CONTROL BUTTON ASSY	1	PAVCCZ
	45	TXFEA01EQUE	SPEAKER L ASSY	1	PAVCCZ
	46	TXFEA02EQUE	SPEAKER R ASSY	1	PAVCCZ
	47	TXFKP01ETUE	SIDE TERMINAL COVER ASSY	1	PAVCCZ
	48	TXFKY01ETUE	CABINET ASSY	1	PAVCCZ
	49	TXFPE01RLTB	CLEANING CLOTH ASSY	1	PAVCCZ
		TXJA11EQUE-1	SPEAKER LEAD (A11-SPR)	1	
		TXJA12EQUE	SPEAKER LEAD (A12-SPL)	1	
		XSB3+6FJ	SCREW	2	
		XTB4+10JFJ	SCREW (STAND BRACKET)	8	
		XTB4+12GFJ	SCREW	21	
		XTB4+12GFJK	SCREW	11	
		XTV3+10JFJK	SCREW	4	
		XTW3+10TFJ	SCREW	1	
		XTWT4+Z15DFJ	SCREW (SP BOX)	2	
		XYN3+J12FJ	SCREW	26	
		XYN4+E8FJ	SCREW	1	
		XYN4+F10FJ	SCREW	18	
		XYN4+F10FJ	SCREW	12	
	50	XYN5+F18FN	SCREW (STAND POLE)	4	
	51	XZB9X18C05	BAG (STAND POLE L)	1	
	52	XZBT6506	POLY BAG (INSTRUCTION BOOK)	1	

## 13.2. Electrical Replacement Parts List

### 13.2.1. Replacement Parts List Notes

#### RTL (Retention Time Limited)

**Note:** The marking (RTL) indicates that the Retention Time is Limited for this item.

After the discontinuation of this assembly in production, the item will continue to be available for a specific period of time. The retention period of availability is dependant on the type of assembly, and in accordance with the laws governing part and product retention. After the end of this period, the assembly will no longer be available.

Abbreviation of part name and description

#### 1. Resistor

Example:

ERD25TJ104    C 100KOHM, J, 1/4W  
                   Type            Allowance

#### 2. Capacitor

Example:

ECKF1H103ZF    C 0.01UF, Z, 50V  
   Type            Allowance

Type	Allowance
C : Carbon	F : ±1%
F : Fuse	G : ±2%
M : Metal Oxide Metal Film	J : ±5%
S : Solid	K : ±10%
W : Wire Wound	M : ±20%

Type	Allowance
C : Ceramic	C : ±0.25pF
E : Electrolytic	D : ±0.5pF
P : Polyester	F : ±1pF
Polyprop	G : ±3pF
lene	J : ±5pF
T : Tantalum	K : ±10pF
	L : ±15pF
	M : ±20pF
	P : +100%, -0%
	Z : +80%, -20%



### 13.2.2. Electrical Replacement Parts List

**Note:** All parts except parts mentioned [PAVCCZ] in the Remarks column are supplied by AVC-CSPC.  
Parts mentioned [PAVCCZ] are supplied by PAVCCZ.

Safety	Ref. No.	Part No.	Part Name & Description	Pcs	Remarks
	A1	K1KA11A00178	11P CONNECTOR	1	
	A7	K1KY22A00003	22P CONNECTOR	1	
	A11	K1KA03AA0728	3P CONNECTOR	1	
	A12	K1KA02AA0728	2P CONNECTOR	1	
	A20	K1MN30BA0255	30P CONNECTOR	1	
	A25	K1KA13A00152	13P CONNECTOR	1	
	A31	K1MY68BA0345	68P CONNECTOR	1	
	A32	K1MY68BA0345	68P CONNECTOR	1	
	C1009	F1H1C104A143	C 0.1UF, K, 16V	1	
	C1010	F1J1E105A171	C 1 UF 25V	1	
	C1102	F1J1A106A043	C 0.010UF, K, 10V	1	
	C1103	F1G1C104A116	C 0.10UF, K, 16V	1	
	C1104	F1G1C104A116	C 0.10UF, K, 16V	1	
	C1106	F1H1H270A971	C 27UF, 50V	1	
	C1107	F1G1H220A731	C 22UF, 50V	1	
	C1108	F1G1C104A116	C 0.10UF, K, 16V	1	
	C1109	F1H1A1050032	C 10UF, 50V	1	
	C1111	F1H1A1050032	C 10UF, 50V	1	
	C1112	F1G1C104A116	C 0.10UF, K, 16V	1	
	C1114	F1G1C104A116	C 0.10UF, K, 16V	1	
	C1117	F1G1C104A116	C 0.10UF, K, 16V	1	
	C1122	F1G1E103A123	C 0.010UF, K, 25V	1	
	C1123	F1H1A1050032	C 10UF, 50V	1	
	C2023	F1G1C104A116	C 0.10UF, K, 16V	1	
	C2049	F1G1C104A116	C 0.10UF, K, 16V	1	
	C2050	F1G1C104A116	C 0.10UF, K, 16V	1	
	C2055	F1G1H150A731	C 15UF, 50V	1	
	C2056	F1G1H150A731	C 15UF, 50V	1	
	C2058	F1G1C104A116	C 0.10UF, K, 16V	1	
	C2059	F1J1A106A043	C 0.010UF, K, 10V	1	
	C2091	F1G1H100A731	C 10PF, K, 50V	1	
	C2092	F1G1H220A731	C 22UF, 50V	1	
	C2096	F1G1C104A116	C 0.10UF, K, 16V	1	
	C2098	EEHBOJ221UP	C 220PF, J, 6.3V	1	
	C2099	EEHBOJ221UP	C 220PF, J, 6.3V	1	
	C2102	F1G1C104A116	C 0.10UF, K, 16V	1	
	C2105	F1G1C104A116	C 0.10UF, K, 16V	1	
	C2106	F1G1C104A116	C 0.10UF, K, 16V	1	
	C2107	F1J1A106A043	C 0.010UF, K, 10V	1	
	C2108	F1J1A106A043	C 0.010UF, K, 10V	1	
	C2109	F1G1C104A116	C 0.10UF, K, 16V	1	
	C2110	F1G1C104A116	C 0.10UF, K, 16V	1	
	C2111	F1J1A475A039	C 4.7UF, K, 10V	1	
	C2112	F1J1A106A043	C 0.010UF, K, 10V	1	
	C2113	F1J1A106A043	C 0.010UF, K, 10V	1	
	C2114	F1G1C104A116	C 0.10UF, K, 16V	1	
	C2115	F1G1C104A116	C 0.10UF, K, 16V	1	
	C2117	F1G1C104A116	C 0.10UF, K, 16V	1	
	C2118	F1J1A475A039	C 4.7UF, K, 10V	1	
	C2120	F1G1H560A731	C 56UF, 50V	1	
	C2121	F1G1H560A731	C 56UF, 50V	1	
	C2122	F1G1C103A116	C 0.010UF, K, 16V	1	
	C2123	F1G1C103A116	C 0.010UF, K, 16V	1	
	C2124	F1G1C104A116	C 0.10UF, K, 16V	1	
	C2125	F1G1C103A116	C 0.010UF, K, 16V	1	
	C2127	F1G1C103A116	C 0.010UF, K, 16V	1	
	C2128	F1G1C103A116	C 0.010UF, K, 16V	1	
	C2129	F1G1C103A116	C 0.010UF, K, 16V	1	
	C2135	F1G1C103A116	C 0.010UF, K, 16V	1	
	C2136	F1G1C103A116	C 0.010UF, K, 16V	1	
	C2137	F1J1A106A043	C 0.010UF, K, 10V	1	
	C2192	F1J1A106A043	C 0.010UF, K, 10V	1	
	C2216	F1G1C104A116	C 0.10UF, K, 16V	1	
	C2244	F1G1C104A116	C 0.10UF, K, 16V	1	
	C2245	F1G1H102A730	C 1000UF, 50V	1	
	C2251	F1J1A106A043	C 0.010UF, K, 10V	1	
	C2261	F1J1A106A043	C 0.010UF, K, 10V	1	
	C2262	F1J1A106A043	C 0.010UF, K, 10V	1	
	C2263	F1J1A106A043	C 0.010UF, K, 10V	1	
	C2264	F1J1A106A043	C 0.010UF, K, 10V	1	
	C2301	F1G1C104A116	C 0.10UF, K, 16V	1	
	C2302	F1G1C104A116	C 0.10UF, K, 16V	1	
	C2303	F1J1E105A171	C 1 UF 25V	1	
	C2305	F1J1E105A171	C 1 UF 25V	1	
	C2309	F1J1E105A171	C 1 UF 25V	1	
	C2313	F1H1A1050032	C 10UF, 50V	1	
	C2317	F1H1H104A970	C 0.1UF, K, 50V	1	
	C2319	F1H1H104A970	C 0.1UF, K, 50V	1	
	C2321	F1H1H104A970	C 0.1UF, K, 50V	1	
	C2323	F1H1H104A970	C 0.1UF, K, 50V	1	
	C2325	F1J1H474A757	C 0.47UF, 50V	1	
	C2331	F1J1H474A757	C 0.47UF, 50V	1	
	C2333	F1H1E104A129	C 0.1UF, 25V	1	
	C2335	F1H1E104A129	C 0.1UF, 25V	1	
	C2337	F1H1H223A970	C 0.22UF, K, 50V	1	
	C2339	F1H1H223A970	C 0.22UF, K, 50V	1	
	C2341	F1H1E104A129	C 0.1UF, 25V	1	
	C2343	F1H1E104A129	C 0.1UF, 25V	1	
	C2345	F1H1H223A970	C 0.22UF, K, 50V	1	
	C2347	F1H1H223A970	C 0.22UF, K, 50V	1	
	C2353	F1G1H102A730	C 1000UF, 50V	1	
	C2359	F1G1H102A730	C 1000UF, 50V	1	
	C2361	F2G1E4710007	E 470UF, 25V	1	
	C2375	F1H1H223A970	C 0.22UF, K, 50V	1	
	C2377	F1H1H223A970	C 0.22UF, K, 50V	1	
	C2379	F1H1H223A970	C 0.22UF, K, 50V	1	
	C2381	F1H1H223A970	C 0.22UF, K, 50V	1	
	C2383	F1G1H102A730	C 1000UF, 50V	1	
	C2385	F1G1H102A730	C 1000UF, 50V	1	
	C2387	F1G1H102A730	C 1000UF, 50V	1	
	C2389	F1G1H102A730	C 1000UF, 50V	1	
	C2390	F1J1E105A171	C 1 UF 25V	1	
	C2407	F1K1E106A136	C 10UF, Z, 25V	1	
	C2408	F1J1E105A171	C 1 UF 25V	1	
	C2409	F1G1H102A730	C 1000UF, 50V	1	
	C2410	F1J1E105A171	C 1 UF 25V	1	
	C2411	F1J1E105A171	C 1 UF 25V	1	
	C2412	F1J1E105A171	C 1 UF 25V	1	

Safety	Ref. No.	Part No.	Part Name & Description	Pcs	Remarks
	C2512	FLJ1A106A043	C 0.010UF, K, 10V	1	
	C2515	FIH1H103A970	C 0.001UF, K, 50V	1	
	C2517	FIH1H103A970	C 0.001UF, K, 50V	1	
	C2521	FIH1H103A970	C 0.001UF, K, 50V	1	
	C2871	FIK1E106A136	C 10UF, Z, 25V	1	
	C2872	FIG1E103A123	C 0.010UF, K, 25V	1	
	C2873	FIH1E104A129	C 0.1UF, 25V	1	
	C2874	F2G1A101A019	E 100UF, 10V	1	
	C2875	FIH1H223A970	C 0.22UF, K, 50V	1	
	C2878	FIH1H472A970	C 4700PF, K, 50V	1	
	C2901	F2G1A101A019	E 100UF, 10V	1	
	C2906	FIH1C104A143	C 0.1UF, K, 16V	1	
	C2907	FIH1C104A143	C 0.1UF, K, 16V	1	
	C2912	F2G0J101A019	E 100UF 6.3V	1	
	C2914	FIH1H104A970	C 0.1UF, K, 50V	1	
	C2916	FIH1C104A143	C 0.1UF, K, 16V	1	
	C2920	FIH1H103A970	C 0.001UF, K, 50V	1	
	C2922	FIH1C104A143	C 0.1UF, K, 16V	1	
	C2923	FIH1H104A970	C 0.1UF, K, 50V	1	
	C2925	FIG1C104A116	C 0.10UF, K, 16V	1	
	C2927	FIG1H101A731	C 100PF, K, 50V	1	
	C2928	FIG1H101A731	C 100PF, K, 50V	1	
	C2940	FIH1H104A970	C 0.1UF, K, 50V	1	
	C2960	FIH0J1050012	C 1UF, K, 16V	1	
	C2961	FIG1H471A731	C 470UF, 50V	1	
	C2962	FIH0J1050012	C 1UF, K, 16V	1	
	C3002	FIG1H561A730	C 56UF, 50V	1	
	C3003	FIG1H561A730	C 56UF, 50V	1	
	C3004	FIG1H561A730	C 56UF, 50V	1	
	C3005	FIG1H561A730	C 56UF, 50V	1	
	C3007	FIG1H561A730	C 56UF, 50V	1	
	C3008	FIG1H561A730	C 56UF, 50V	1	
	C3009	FIG1H561A730	C 56UF, 50V	1	
	C3010	FIG1H561A730	C 56UF, 50V	1	
	C3011	FIG1H561A730	C 56UF, 50V	1	
	C3012	FIG1H561A730	C 56UF, 50V	1	
	C3013	FIG1H561A730	C 56UF, 50V	1	
	C3014	FIG1H561A730	C 56UF, 50V	1	
	C3018	FIJ1A106A043	C 0.010UF, K, 10V	1	
	C3019	FIJ1A106A043	C 0.010UF, K, 10V	1	
	C3020	FIJ1A106A043	C 0.010UF, K, 10V	1	
	C3021	FIJ1A106A043	C 0.010UF, K, 10V	1	
	C3022	FIH1A1050032	C 10UF, 50V	1	
	C3023	FIG1C104A116	C 0.10UF, K, 16V	1	
	C3024	FIH1A1050032	C 10UF, 50V	1	
	C3025	FIH1A1050032	C 10UF, 50V	1	
	C3026	FIH1A1050032	C 10UF, 50V	1	
	C3027	FIJ1A106A043	C 0.010UF, K, 10V	1	
	C3028	FIJ1A106A043	C 0.010UF, K, 10V	1	
	C3029	FIJ1A106A043	C 0.010UF, K, 10V	1	
	C3030	FIJ1A106A043	C 0.010UF, K, 10V	1	
	C3039	FIH1A1050032	C 10UF, 50V	1	
	C3041	FIH1A1050032	C 10UF, 50V	1	
	C3043	FIH1A1050032	C 10UF, 50V	1	
	C3044	FIH1A1050032	C 10UF, 50V	1	
	C3046	FIH1A1050032	C 10UF, 50V	1	
	C3047	FIH1A1050032	C 10UF, 50V	1	
	C3048	FIH1A1050032	C 10UF, 50V	1	
	C3049	FIH1A1050032	C 10UF, 50V	1	
	C3056	FIG1E333A091	C 0.033UF, K, 25V	1	

Safety	Ref. No.	Part No.	Part Name & Description	Pcs	Remarks
	C3057	FIG1E333A091	C 0.033UF, K, 25V	1	
	C3064	FIG1H102A730	C 1000UF, 50V	1	
	C3065	FIG1H102A730	C 1000UF, 50V	1	
	C3070	FIJ1A106A043	C 0.010UF, K, 10V	1	
	C3071	FIJ1A106A043	C 0.010UF, K, 10V	1	
	C3072	FIG1C104A116	C 0.10UF, K, 16V	1	
	C3073	FIJ1A106A043	C 0.010UF, K, 10V	1	
	C3074	FIJ1A106A043	C 0.010UF, K, 10V	1	
	C3075	FIH1A1050032	C 10UF, 50V	1	
	C3077	FIG1C104A116	C 0.10UF, K, 16V	1	
	C3078	FIJ1A106A043	C 0.010UF, K, 10V	1	
	C3083	FIJ1A106A043	C 0.010UF, K, 10V	1	
	C3084	FIJ1A106A043	C 0.010UF, K, 10V	1	
	C3085	FIJ1A106A043	C 0.010UF, K, 10V	1	
	C3086	FIJ1A106A043	C 0.010UF, K, 10V	1	
	C3087	FIJ1A106A043	C 0.010UF, K, 10V	1	
	C3088	FIJ1A106A043	C 0.010UF, K, 10V	1	
	C3089	FIJ1A106A043	C 0.010UF, K, 10V	1	
	C3090	FIJ1A106A043	C 0.010UF, K, 10V	1	
	C3091	FIJ1A106A043	C 0.010UF, K, 10V	1	
	C3092	FIJ1A106A043	C 0.010UF, K, 10V	1	
	C3095	F2G1A101A019	E 100UF, 10V	1	
	C3097	F2G1A101A019	E 100UF, 10V	1	
	C3099	FIG1H561A730	C 56UF, 50V	1	
	C3102	F2G1A101A019	E 100UF, 10V	1	
	C3103	F2G1A101A019	E 100UF, 10V	1	
	C3114	FIJ1A106A043	C 0.010UF, K, 10V	1	
	C3115	FIJ1A106A043	C 0.010UF, K, 10V	1	
	C3116	FIJ1A106A043	C 0.010UF, K, 10V	1	
	C3117	FIJ1A106A043	C 0.010UF, K, 10V	1	
	C3118	FIH1A1050032	C 10UF, 50V	1	
	C3119	FIH1A1050032	C 10UF, 50V	1	
	C3139	FIG1C104A116	C 0.10UF, K, 16V	1	
	C3140	FIG1C104A116	C 0.10UF, K, 16V	1	
	C3141	FIG1C104A116	C 0.10UF, K, 16V	1	
	C3143	FIG1C104A116	C 0.10UF, K, 16V	1	
	C3144	FIJ1A106A043	C 0.010UF, K, 10V	1	
	C3145	FIG1C104A116	C 0.10UF, K, 16V	1	
	C3146	FIJ1A106A043	C 0.010UF, K, 10V	1	
	C3147	FIJ1A106A043	C 0.010UF, K, 10V	1	
	C3257	FIG1H561A730	C 56UF, 50V	1	
	C3752	FIJ1H102A836	C 1000UF, 50V	1	
	C4500	FIG1C104A116	C 0.10UF, K, 16V	1	
	C4501	FIG1C104A116	C 0.10UF, K, 16V	1	
	C4502	FIG1C104A116	C 0.10UF, K, 16V	1	
	C4503	FIG1C104A116	C 0.10UF, K, 16V	1	
	C4533	FIG1H680A731	C 68UF, 50V	1	
	C4534	FIG1C104A116	C 0.10UF, K, 16V	1	
	C4535	FIG1C104A116	C 0.10UF, K, 16V	1	
	C4537	FIG1C104A116	C 0.10UF, K, 16V	1	
	C4547	FIG1C104A116	C 0.10UF, K, 16V	1	
	C4548	FIG1C104A116	C 0.10UF, K, 16V	1	
	C4549	FIG1C104A116	C 0.10UF, K, 16V	1	
	C4550	FIG1C104A116	C 0.10UF, K, 16V	1	

Safety	Ref. No.	Part No.	Part Name & Description	Pcs	Remarks
	C4551	F1G1C104A116	C 0.10UF, K, 16V	1	
	C4552	F1G1C104A116	C 0.10UF, K, 16V	1	
	C4553	F1G1H102A730	C 1000UF, 50V	1	
	C4554	F2G1C470A022	E 47UF, 16V	1	
	C4555	F1J1A106A043	C 0.010UF, K, 10V	1	
	C4567	F1G1C104A116	C 0.10UF, K, 16V	1	
	C4574	F1G1C104A116	C 0.10UF, K, 16V	1	
	C4575	F1G1C104A116	C 0.10UF, K, 16V	1	
	C4580	F1G1C104A116	C 0.10UF, K, 16V	1	
	C4585	F1G1C104A116	C 0.10UF, K, 16V	1	
	C4595	F1G1C104A116	C 0.10UF, K, 16V	1	
	C4598	F1J1A106A043	C 0.010UF, K, 10V	1	
	C4599	F1J1A106A043	C 0.010UF, K, 10V	1	
	C4600	F1G1C104A116	C 0.10UF, K, 16V	1	
	C4601	F1J1A106A043	C 0.010UF, K, 10V	1	
	C4602	F1G1C104A116	C 0.10UF, K, 16V	1	
	C4603	F1J1A475A039	C 4.7UF, K, 10V	1	
	C4605	F1J1A475A039	C 4.7UF, K, 10V	1	
	C4606	F1J1A475A039	C 4.7UF, K, 10V	1	
	C4607	F1J1A475A039	C 4.7UF, K, 10V	1	
	C4608	F1G1C104A116	C 0.10UF, K, 16V	1	
	C4613	F1H0J1050012	C 1UF, K, 16V	1	
	C4616	F1J1A475A039	C 4.7UF, K, 10V	1	
	C4617	F1J1A475A039	C 4.7UF, K, 10V	1	
	C4624	F1G1C104A116	C 0.10UF, K, 16V	1	
	C4625	F1G1C104A116	C 0.10UF, K, 16V	1	
	C4626	F1G1C104A116	C 0.10UF, K, 16V	1	
	C4628	F1G1C104A116	C 0.10UF, K, 16V	1	
	C4629	F1G1C104A116	C 0.10UF, K, 16V	1	
	C4630	F1G1C104A116	C 0.10UF, K, 16V	1	
	C4631	F1J1A106A043	C 0.010UF, K, 10V	1	
	C4632	F1G1C104A116	C 0.10UF, K, 16V	1	
	C4633	F1J1A106A043	C 0.010UF, K, 10V	1	
	C4634	F1G1C104A116	C 0.10UF, K, 16V	1	
	C4635	F1J1A106A043	C 0.010UF, K, 10V	1	
	C4636	F1G1C104A116	C 0.10UF, K, 16V	1	
	C4637	F1G1C104A116	C 0.10UF, K, 16V	1	
	C4638	F1G1C104A116	C 0.10UF, K, 16V	1	
	C4640	F1G1C104A116	C 0.10UF, K, 16V	1	
	C4642	F1G1C104A116	C 0.10UF, K, 16V	1	
	C4643	F1G1C104A116	C 0.10UF, K, 16V	1	
	C4644	F1G1C104A116	C 0.10UF, K, 16V	1	
	C4645	F1G1C104A116	C 0.10UF, K, 16V	1	
	C5470	F1G1C103A116	C 0.010UF, K, 16V	1	
	C5471	F1G1A473A053	C 0.47UF, 10V	1	
	C5473	F1G1E103A123	C 0.010UF, K, 25V	1	
	C5482	F2G1A221A149	E 220UF, 10V	1	
	C5483	F1J1A106A043	C 0.010UF, K, 10V	1	
	C5484	F2G0J470A019	E 47UF 6.3V	1	
	C5485	F1G1C104A116	C 0.10UF, K, 16V	1	
	C5486	F1G1E392A123	C 3900UF, Z, 25V	1	
	C5487	F1H0J1050012	C 1UF, K, 16V	1	
	C5488	F1H0J1050012	C 1UF, K, 16V	1	
	C5490	F1J1H474A757	C 0.47UF, 50V	1	
	C5491	F1J1H474A757	C 0.47UF, 50V	1	
	C5494	F1G1H820A731	C 82UF, 50V	1	
	C5495	F2G1V220A020	E 22UF, 35V	1	
	C5496	F1G1H102A730	C 1000UF, 50V	1	
	C5520	F2G1C100A022	C 10UF J 16V	1	
	C5600	F1G1C104A116	C 0.10UF, K, 16V	1	
	C5601	F1G1H272A571	C 2700UF, 50V	1	
	C5602	F2H0J1010009	C 100UF, 6.3V	1	
	C5603	F1H1C105A145	C 0.01UF, K, 16V	1	
	C5604	F1G1E103A123	C 0.010UF, K, 25V	1	

Safety	Ref. No.	Part No.	Part Name & Description	Pcs	Remarks
	C5605	F1J1A475A039	C 4.7UF, K, 10V	1	
	C5606	F1G1E6820007	C 6800UF, Z, 25V	1	
	C5607	F1G1H152A571	C 1500UF, 50V	1	
	C5608	F1G1C104A116	C 0.10UF, K, 16V	1	
	C5611	F1K1E106A136	C 10UF, Z, 25V	1	
	C5612	F1K1E106A136	C 10UF, Z, 25V	1	
	C5615	F1K1E106A136	C 10UF, Z, 25V	1	
	C5616	F1G1E103A123	C 0.010UF, K, 25V	1	
	C5620	F1H1E104A129	C 0.1UF, 25V	1	
	C5621	F1H1C105A145	C 0.01UF, K, 16V	1	
	C5622	F1J1A475A039	C 4.7UF, K, 10V	1	
	C5623	F1G1H272A571	C 2700UF, 50V	1	
	C5624	F1G1H3320004	C 3300UF, 50V	1	
	C5625	F1G1C273A081	C 0.027UF, K, 16V	1	
	C5626	F1G1C104A116	C 0.10UF, K, 16V	1	
	C5627	F1G1C104A116	C 0.10UF, K, 16V	1	
	C5628	ECGRLOE680ER	C 68UF, J, 2.5V	1	
	C5629	ECGRLOE680ER	C 68UF, J, 2.5V	1	
	C5636	F1G1C104A116	C 0.10UF, K, 16V	1	
	C5637	F1G1C104A116	C 0.10UF, K, 16V	1	
	C5638	F1G1C104A116	C 0.10UF, K, 16V	1	
	C5639	F1G1C104A116	C 0.10UF, K, 16V	1	
	C5640	F1G1C104A116	C 0.10UF, K, 16V	1	
	C5641	F1G1C104A116	C 0.10UF, K, 16V	1	
	C5642	F1K1E106A136	C 10UF, Z, 25V	1	
	C5643	F1H1E104A129	C 0.1UF, 25V	1	
	C5645	F1K1E106A136	C 10UF, Z, 25V	1	
	C5646	F1K1E106A136	C 10UF, Z, 25V	1	
	C5648	F2H0J1010009	C 100UF, 6.3V	1	
	C5649	F1G1C104A116	C 0.10UF, K, 16V	1	
	C5657	F1H1A225A051	C 22UF, 50V	1	
	C5658	F1G1E103A123	C 0.010UF, K, 25V	1	
	C5696	F2G1E470A021	C 47PF, J, 25V	1	
	C5697	F1J1E105A171	C 1 UF 25V	1	
	C5699	F1K1E106A136	C 10UF, Z, 25V	1	
	C5700	F1K1E106A136	C 10UF, Z, 25V	1	
	C5722	F1J1E105A171	C 1 UF 25V	1	
	C5723	F1H1C105A145	C 0.01UF, K, 16V	1	
	C5727	F1G1C104A116	C 0.10UF, K, 16V	1	
	C5728	F1G1C104A116	C 0.10UF, K, 16V	1	
	C8003	F1H0J1050012	C 1UF, K, 16V	1	
	C8005	F1H0J1050012	C 1UF, K, 16V	1	
	C8006	F1G1C104A116	C 0.10UF, K, 16V	1	
	C8007	F1G1C104A116	C 0.10UF, K, 16V	1	
	C8008	F1G1C104A116	C 0.10UF, K, 16V	1	
	C8009	F1J1A106A043	C 0.010UF, K, 10V	1	
	C8010	F1J1A106A043	C 0.010UF, K, 10V	1	
	C8011	F1G1C104A116	C 0.10UF, K, 16V	1	
	C8012	F1G1C104A116	C 0.10UF, K, 16V	1	
	C8013	F1G1C104A116	C 0.10UF, K, 16V	1	
	C8014	F1G1C104A116	C 0.10UF, K, 16V	1	
	C8015	F1H0J1050012	C 1UF, K, 16V	1	
	C8016	F1H0J1050012	C 1UF, K, 16V	1	
	C8017	F1J1A106A043	C 0.010UF, K, 10V	1	
	C8018	F1G1C104A116	C 0.10UF, K, 16V	1	
	C8019	F1G1C104A116	C 0.10UF, K, 16V	1	
	C8020	F1G1C104A116	C 0.10UF, K, 16V	1	
	C8021	F1G1C104A116	C 0.10UF, K, 16V	1	
	C8022	F1H0J1050012	C 1UF, K, 16V	1	
	C8023	F1J1A106A043	C 0.010UF, K, 10V	1	
	C8024	F1J1A106A043	C 0.010UF, K, 10V	1	
	C8025	F1G1C104A116	C 0.10UF, K, 16V	1	
	C8026	F1G1C104A116	C 0.10UF, K, 16V	1	
	C8027	F1G1C104A116	C 0.10UF, K, 16V	1	
	C8028	F1G1C104A116	C 0.10UF, K, 16V	1	
	C8029	F1G1C104A116	C 0.10UF, K, 16V	1	
	C8030	F1H0J1050012	C 1UF, K, 16V	1	

Safety	Ref. No.	Part No.	Part Name & Description	Pcs	Remarks
	C8031	FIH0J1050012	C 1UF, K, 16V	1	
	C8032	FIJ1A106A043	C 0.010UF, K, 10V	1	
	C8033	FIG1C104A116	C 0.10UF, K, 16V	1	
	C8034	FIG1C104A116	C 0.10UF, K, 16V	1	
	C8035	FIJ1A106A043	C 0.010UF, K, 10V	1	
	C8036	FIJ1A106A043	C 0.010UF, K, 10V	1	
	C8037	FIG1C104A116	C 0.10UF, K, 16V	1	
	C8038	FIG1C104A116	C 0.10UF, K, 16V	1	
	C8039	FIG1C104A116	C 0.10UF, K, 16V	1	
	C8040	FIG1C104A116	C 0.10UF, K, 16V	1	
	C8041	FIG1C104A116	C 0.10UF, K, 16V	1	
	C8042	ECGRLOG680ER	C 68UF, J, 4V	1	
	C8043	FIG1C104A116	C 0.10UF, K, 16V	1	
	C8044	FIG1C104A116	C 0.10UF, K, 16V	1	
	C8045	FIG1C104A116	C 0.10UF, K, 16V	1	
	C8046	FIG1C104A116	C 0.10UF, K, 16V	1	
	C8047	FIG1C104A116	C 0.10UF, K, 16V	1	
	C8048	FIG1C104A116	C 0.10UF, K, 16V	1	
	C8049	FIG1C104A116	C 0.10UF, K, 16V	1	
	C8050	FIG1C104A116	C 0.10UF, K, 16V	1	
	C8051	FIG1C104A116	C 0.10UF, K, 16V	1	
	C8052	FIH0J1050012	C 1UF, K, 16V	1	
	C8053	FIG1C103A116	C 0.010UF, K, 16V	1	
	C8054	FIG1H150A731	C 15UF, 50V	1	
	C8055	FIG1HR50A577	C 0.50UF, 50V	1	
	C8056	FIG1C104A116	C 0.10UF, K, 16V	1	
	C8057	FIG1C104A116	C 0.10UF, K, 16V	1	
	C8058	FIJ1A106A043	C 0.010UF, K, 10V	1	
	C8063	FIH0J1050012	C 1UF, K, 16V	1	
	C8064	FIH0J1050012	C 1UF, K, 16V	1	
	C8065	FIG1C104A116	C 0.10UF, K, 16V	1	
	C8067	FIG1C104A116	C 0.10UF, K, 16V	1	
	C8069	FIG1H102A730	C 1000UF, 50V	1	
	C8070	FIG1C104A116	C 0.10UF, K, 16V	1	
	C8071	FIG1C104A116	C 0.10UF, K, 16V	1	
	C8072	FIG1C104A116	C 0.10UF, K, 16V	1	
	C8073	FIG1C104A116	C 0.10UF, K, 16V	1	
	C8074	FIG1C104A116	C 0.10UF, K, 16V	1	
	C8075	FIJ1A106A043	C 0.010UF, K, 10V	1	
	C8076	FIG1C104A116	C 0.10UF, K, 16V	1	
	C8077	FIG1C104A116	C 0.10UF, K, 16V	1	
	C8078	FIG1C104A116	C 0.10UF, K, 16V	1	
	C8079	FIG1C104A116	C 0.10UF, K, 16V	1	
	C8080	FIG1C104A116	C 0.10UF, K, 16V	1	
	C8081	FIG1C104A116	C 0.10UF, K, 16V	1	
	C8082	FIG1H102A730	C 1000UF, 50V	1	
	C8083	FIG1C104A116	C 0.10UF, K, 16V	1	
	C8084	FIG1H102A730	C 1000UF, 50V	1	
	C8085	FIG1C104A116	C 0.10UF, K, 16V	1	
	C8086	FIG1C104A116	C 0.10UF, K, 16V	1	
	C8087	FIG1C104A116	C 0.10UF, K, 16V	1	
	C8088	FIG1C104A116	C 0.10UF, K, 16V	1	
	C8089	FIG1C104A116	C 0.10UF, K, 16V	1	
	C8090	FIG1C104A116	C 0.10UF, K, 16V	1	
	C8092	FIG1C104A116	C 0.10UF, K, 16V	1	
	C8093	FIG1C104A116	C 0.10UF, K, 16V	1	
	C8094	FIG1C104A116	C 0.10UF, K, 16V	1	
	C8095	FIG1C104A116	C 0.10UF, K, 16V	1	
	C8096	FIG1C104A116	C 0.10UF, K, 16V	1	
	C8097	FIG1C104A116	C 0.10UF, K, 16V	1	
	C8098	FIG1C104A116	C 0.10UF, K, 16V	1	
	C8099	FIG1C104A116	C 0.10UF, K, 16V	1	
	C8100	FIG1C104A116	C 0.10UF, K, 16V	1	
	C8101	FIG1C104A116	C 0.10UF, K, 16V	1	
	C8102	FIG1C104A116	C 0.10UF, K, 16V	1	
	C8201	FIG1C104A116	C 0.10UF, K, 16V	1	
	C8202	FIG1C104A116	C 0.10UF, K, 16V	1	
	C8306	FIG1A4740003	C0.047UF, K, 10V	1	

Safety	Ref. No.	Part No.	Part Name & Description	Pcs	Remarks
	C8307	FIG1C104A116	C 0.10UF, K, 16V	1	
	C8309	FIG1C104A116	C 0.10UF, K, 16V	1	
	C8311	FIG1H120A731	C 12UF, 50V	1	
	C8312	FIG1H120A731	C 12UF, 50V	1	
	C8313	FIG1C104A116	C 0.10UF, K, 16V	1	
	C8314	FIG1C104A116	C 0.10UF, K, 16V	1	
	C8316	FIG1C271A117	C 270UF, K, 16V	1	
	C8317	FIG1C271A117	C 270UF, K, 16V	1	
	C8319	FIG1C104A116	C 0.10UF, K, 16V	1	
	C8320	FIG1C104A116	C 0.10UF, K, 16V	1	
	C8321	FIG1C104A116	C 0.10UF, K, 16V	1	
	C8327	FIH1A225A051	C 22UF, 50V	1	
	C8328	FIH1A1050032	C 10UF, 50V	1	
	C8329	FIG1C104A116	C 0.10UF, K, 16V	1	
	C8330	FIG1C104A116	C 0.10UF, K, 16V	1	
	C8331	FIG1C104A116	C 0.10UF, K, 16V	1	
	C8332	FIG1C104A116	C 0.10UF, K, 16V	1	
	C8333	FIG1C104A116	C 0.10UF, K, 16V	1	
	C8334	FIG1C104A116	C 0.10UF, K, 16V	1	
	C8335	FIG1C104A116	C 0.10UF, K, 16V	1	
	C8336	FIG1C104A116	C 0.10UF, K, 16V	1	
	C8340	FIG1C104A116	C 0.10UF, K, 16V	1	
	C8343	FIG1C104A116	C 0.10UF, K, 16V	1	
	C8344	FIG1C104A116	C 0.10UF, K, 16V	1	
	C8345	FIG1C104A116	C 0.10UF, K, 16V	1	
	C8346	FIG1C104A116	C 0.10UF, K, 16V	1	
	C8405	FIG1C104A116	C 0.10UF, K, 16V	1	
	C8408	FIG1C104A116	C 0.10UF, K, 16V	1	
	C8409	FIG1C104A116	C 0.10UF, K, 16V	1	
	C8410	FIG1C104A116	C 0.10UF, K, 16V	1	
	C8411	F2G1A101A019	E 100UF, 10V	1	
	C8412	FIG1C104A116	C 0.10UF, K, 16V	1	
	C8413	FIG1C104A116	C 0.10UF, K, 16V	1	
	C8414	FIG1C104A116	C 0.10UF, K, 16V	1	
	C8415	FIG1C104A116	C 0.10UF, K, 16V	1	
	C8416	FIG1E103A123	C 0.010UF, K, 25V	1	
	C8417	FIG1E103A123	C 0.010UF, K, 25V	1	
	C8418	FIG1C104A116	C 0.10UF, K, 16V	1	
	C8508	FIG1C103A116	C 0.010UF, K, 16V	1	
	C8510	FIJ1A106A043	C 0.010UF, K, 10V	1	
	C8532	F2G1C470A022	E 47UF, 16V	1	
	C8533	FIG1C104A116	C 0.10UF, K, 16V	1	
	C8535	FIG1C103A116	C 0.010UF, K, 16V	1	
	C8544	FIJ0G2260001	C 0.001UF, 6.3V	1	
	C8580	FIG1C104A116	C 0.10UF, K, 16V	1	
	C8581	FIG1C104A116	C 0.10UF, K, 16V	1	
	C9033	FIG1C104A116	C 0.10UF, K, 16V	1	
	C9034	FIG1C104A116	C 0.10UF, K, 16V	1	
	C9035	FIJ1A106A043	C 0.010UF, K, 10V	1	
	C9036	FIJ1A106A043	C 0.010UF, K, 10V	1	
	C9037	FIG1E103A123	C 0.010UF, K, 25V	1	
	C9040	FIG1C104A116	C 0.10UF, K, 16V	1	
	C9044	FIJ1A475A039	C 4.7UF, K, 10V	1	
	C9045	FIG1C104A116	C 0.10UF, K, 16V	1	
	C9046	FIG1C104A116	C 0.10UF, K, 16V	1	
	C9047	FIG1C104A116	C 0.10UF, K, 16V	1	
	C9048	FIG1C104A116	C 0.10UF, K, 16V	1	
	C9049	FIG1C104A116	C 0.10UF, K, 16V	1	
	C9052	FIG1C104A116	C 0.10UF, K, 16V	1	
	C9053	FIG1C104A116	C 0.10UF, K, 16V	1	
	C9055	FIG1C104A116	C 0.10UF, K, 16V	1	
	C9057	FIG1C104A116	C 0.10UF, K, 16V	1	
	C9061	FIG1C104A116	C 0.10UF, K, 16V	1	
	C9062	FIJ1A475A039	C 4.7UF, K, 10V	1	
	C9063	FIG1C104A116	C 0.10UF, K, 16V	1	
	C9064	FIG1C104A116	C 0.10UF, K, 16V	1	
	C9065	FIG1C104A116	C 0.10UF, K, 16V	1	

Safety	Ref. No.	Part No.	Part Name & Description	Pcs	Remarks
	C9066	F1H1E104A129	C 0.1UF, 25V	1	
	C9067	F1K0J226A008	C 22UF, K, 6.3V	1	
	C9068	F1K0J226A008	C 22UF, K, 6.3V	1	
	C9069	F1G1H222A730	C 2200UF, 50V	1	
	C9071	F1H1E104A129	C 0.1UF, 25V	1	
	C9072	F1K0J226A008	C 22UF, K, 6.3V	1	
	C9073	F1K0J226A008	C 22UF, K, 6.3V	1	
	C9074	F1G1H222A730	C 2200UF, 50V	1	
	C9076	F1G1C223A116	C 0.022UF, K, 16V	1	
	C9077	F1K1E106A136	C 10UF, Z, 25V	1	
	C9078	F1K1E106A136	C 10UF, Z, 25V	1	
	C9079	F1G1H220A731	C 22UF, 50V	1	
	C9080	F1G1H201A731	C 200 UF, K, 50V	1	
	C9468	F1G1E103A123	C 0.010UF, K, 25V	1	
	C9469	F1G1C104A116	C 0.10UF, K, 16V	1	
	C9535	F1G1C104A116	C 0.10UF, K, 16V	1	
	C9536	F1G1C104A116	C 0.10UF, K, 16V	1	
	C9537	F1G1C104A116	C 0.10UF, K, 16V	1	
	C9538	F1G1C104A116	C 0.10UF, K, 16V	1	
	C9539	F1G1C104A116	C 0.10UF, K, 16V	1	
	C9540	F1G1C104A116	C 0.10UF, K, 16V	1	
	C9541	F1G1C104A116	C 0.10UF, K, 16V	1	
	C9542	F1G1C104A116	C 0.10UF, K, 16V	1	
	C9543	F1G1C104A116	C 0.10UF, K, 16V	1	
	C9544	F1G1C104A116	C 0.10UF, K, 16V	1	
	C9545	F1G1C104A116	C 0.10UF, K, 16V	1	
	C9546	F1G1C104A116	C 0.10UF, K, 16V	1	
	C9547	F1G1C104A116	C 0.10UF, K, 16V	1	
	C9548	F1G1C104A116	C 0.10UF, K, 16V	1	
	C9549	F1G1C104A116	C 0.10UF, K, 16V	1	
	C9550	F1G1C104A116	C 0.10UF, K, 16V	1	
	C9823	F1K1E106A136	C 10UF, Z, 25V	1	
	C9825	F1G1H101A731	C 100PF, K, 50V	1	
	C9832	F1J1A106A043	C 0.010UF, K, 10V	1	
	C9837	F1J1A106A043	C 0.010UF, K, 10V	1	
	C9840	F1G1E103A123	C 0.010UF, K, 25V	1	
	C9844	F1G1E103A123	C 0.010UF, K, 25V	1	
	C9845	F1G1C104A116	C 0.10UF, K, 16V	1	
	C9846	F1G1C104A116	C 0.10UF, K, 16V	1	
	C9858	F1K1E106A136	C 10UF, Z, 25V	1	
	C9859	F1G1E103A123	C 0.010UF, K, 25V	1	
	C9863	F1G1E472A123	C 4200UF, Z, 25V	1	
	C9869	F1K1E106A136	C 10UF, Z, 25V	1	
	C9872	F1K1E106A136	C 10UF, Z, 25V	1	
	C9874	F1G1H101A731	C 100PF, K, 50V	1	
	C9882	F1G1H201A731	C 200 UF, K, 50V	1	
	C9889	F1J1A106A043	C 0.010UF, K, 10V	1	
	C9892	F1J1A106A043	C 0.010UF, K, 10V	1	
	C9897	F1J1A106A043	C 0.010UF, K, 10V	1	
	C9899	F1J1A106A043	C 0.010UF, K, 10V	1	
	C9900	F1G1C104A116	C 0.10UF, K, 16V	1	
	C9901	F1G1C104A116	C 0.10UF, K, 16V	1	
	C9902	F1G1C104A116	C 0.10UF, K, 16V	1	
	C9903	F1G1C104A116	C 0.10UF, K, 16V	1	
	C9904	F1G1C104A116	C 0.10UF, K, 16V	1	
	C9905	F1G1C104A116	C 0.10UF, K, 16V	1	
	C9906	F1G1C104A116	C 0.10UF, K, 16V	1	
	C9907	F1G1C104A116	C 0.10UF, K, 16V	1	
	C9908	F1G1C104A116	C 0.10UF, K, 16V	1	
	C9909	F1G1C104A116	C 0.10UF, K, 16V	1	
	C9910	F1G1C104A116	C 0.10UF, K, 16V	1	
	C9911	F1G1C104A116	C 0.10UF, K, 16V	1	
	C9912	F1G1C104A116	C 0.10UF, K, 16V	1	
	C9913	F1G1C104A116	C 0.10UF, K, 16V	1	

Safety	Ref. No.	Part No.	Part Name & Description	Pcs	Remarks
	C9914	F1G1C104A116	C 0.10UF, K, 16V	1	
	C9915	F1G1C104A116	C 0.10UF, K, 16V	1	
	C9916	F1G1C104A116	C 0.10UF, K, 16V	1	
	C9917	F1G1C104A116	C 0.10UF, K, 16V	1	
	C9918	F1G1C104A116	C 0.10UF, K, 16V	1	
	C9919	F1G1C104A116	C 0.10UF, K, 16V	1	
	C9920	F1G1C104A116	C 0.10UF, K, 16V	1	
	C9921	F1G1C104A116	C 0.10UF, K, 16V	1	
	C9922	F1G1C104A116	C 0.10UF, K, 16V	1	
	C9923	F1G1C104A116	C 0.10UF, K, 16V	1	
	C9924	F1G1C104A116	C 0.10UF, K, 16V	1	
	C9925	F1G1C104A116	C 0.10UF, K, 16V	1	
	C9926	F1J1A106A043	C 0.010UF, K, 10V	1	
	C9927	F1G1C104A116	C 0.10UF, K, 16V	1	
	C9928	F1G1C104A116	C 0.10UF, K, 16V	1	
	C9929	F1G1C104A116	C 0.10UF, K, 16V	1	
	C9930	F1G1C104A116	C 0.10UF, K, 16V	1	
	C9931	F1G1C104A116	C 0.10UF, K, 16V	1	
	C9932	F1G1C104A116	C 0.10UF, K, 16V	1	
	C9933	F1G1C104A116	C 0.10UF, K, 16V	1	
	C9934	F1G1C104A116	C 0.10UF, K, 16V	1	
	C9935	F1G1C104A116	C 0.10UF, K, 16V	1	
	C9936	F1G1C104A116	C 0.10UF, K, 16V	1	
	C9937	F1G1C104A116	C 0.10UF, K, 16V	1	
	C9938	F1G1C104A116	C 0.10UF, K, 16V	1	
	C9939	F1G1C104A116	C 0.10UF, K, 16V	1	
	C9940	F1G1C104A116	C 0.10UF, K, 16V	1	
	C9941	F1G1C104A116	C 0.10UF, K, 16V	1	
	C9942	F1G1C104A116	C 0.10UF, K, 16V	1	
	C9943	F1G1C104A116	C 0.10UF, K, 16V	1	
	C9944	F1G1C104A116	C 0.10UF, K, 16V	1	
	C9945	F1G1C104A116	C 0.10UF, K, 16V	1	
	C9946	F1G1C104A116	C 0.10UF, K, 16V	1	
	C9947	F1G1C104A116	C 0.10UF, K, 16V	1	
	C9948	F1G1C104A116	C 0.10UF, K, 16V	1	
	C9949	F1G1C104A116	C 0.10UF, K, 16V	1	
	C9950	F1G1C104A116	C 0.10UF, K, 16V	1	
	C9951	F1G1C104A116	C 0.10UF, K, 16V	1	
	C9952	F1G1C104A116	C 0.10UF, K, 16V	1	
	C9953	F1G1C104A116	C 0.10UF, K, 16V	1	
	C9954	F1G1C104A116	C 0.10UF, K, 16V	1	
	C9955	F1G1C104A116	C 0.10UF, K, 16V	1	
	C9956	F1G1C104A116	C 0.10UF, K, 16V	1	
	C9957	F1G1C104A116	C 0.10UF, K, 16V	1	
	C9958	F1G1C104A116	C 0.10UF, K, 16V	1	
	C9959	F1G1C104A116	C 0.10UF, K, 16V	1	
	C9961	F1J1A106A043	C 0.010UF, K, 10V	1	
	C9962	F1J1A106A043	C 0.010UF, K, 10V	1	
	C9965	F1G1C104A116	C 0.10UF, K, 16V	1	
	C9966	F1J1A106A043	C 0.010UF, K, 10V	1	
	C9967	F1G1C104A116	C 0.10UF, K, 16V	1	
	C9968	F1G1C104A116	C 0.10UF, K, 16V	1	
	C9970	F1G1C104A116	C 0.10UF, K, 16V	1	
	C9971	F1G1H180A731	C 18UF, 50V	1	
	C9972	F1G1H180A731	C 18UF, 50V	1	
	C9973	F1G1C104A116	C 0.10UF, K, 16V	1	
	C9974	F1G1C104A116	C 0.10UF, K, 16V	1	
	C9975	F1G1C104A116	C 0.10UF, K, 16V	1	
	C9976	F1G1C104A116	C 0.10UF, K, 16V	1	
	C9977	F1G1C104A116	C 0.10UF, K, 16V	1	
	C9978	F1G1C104A116	C 0.10UF, K, 16V	1	
	C9979	F1G1C104A116	C 0.10UF, K, 16V	1	
	C9980	F1G1C104A116	C 0.10UF, K, 16V	1	
	CN0100	K1KA11AA0715	11P CONNECTOR	1	
	CN0101	K1KA20AA0009	20P CONNECTOR	1	
	CN0102	K1KA04AA0104	4P CONNECTOR	1	
	D1107	MA3X704A0L	ZENER DIODE	1	
	D2014	MA2J11100L	DIODE	1	





Safety	Ref. No.	Part No.	Part Name & Description	Pcs	Remarks
	L3011	J0JCC0000287	CHIP INDUCTOR	1	
	L3014	J0JCC0000287	CHIP INDUCTOR	1	
	L3015	J0JCC0000287	CHIP INDUCTOR	1	
	L3017	J0JCC0000287	CHIP INDUCTOR	1	
	L3018	J0JCC0000287	CHIP INDUCTOR	1	
	L3026	J0JCC0000287	CHIP INDUCTOR	1	
	L3027	J0JCC0000287	CHIP INDUCTOR	1	
	L3028	J0JCC0000287	CHIP INDUCTOR	1	
	L3029	J0JCC0000287	CHIP INDUCTOR	1	
	L3030	J0JCC0000287	CHIP INDUCTOR	1	
	L3034	J0JCC0000364	CHIP INDUCTOR	1	
	L3035	J0JCC0000364	CHIP INDUCTOR	1	
	L4502	J0JYC0000068	CHIP INDUCTOR	1	
	L4503	J0JYC0000068	CHIP INDUCTOR	1	
	L4504	J0JYC0000068	CHIP INDUCTOR	1	
	L4505	J0JYC0000068	CHIP INDUCTOR	1	
	L4506	J0JYC0000068	CHIP INDUCTOR	1	
	L4507	J0JYC0000068	CHIP INDUCTOR	1	
	L4511	J0JYC0000068	CHIP INDUCTOR	1	
	L4512	J0JCC0000059	CHIP INDUCTOR	1	
	L4513	J0JCC0000059	CHIP INDUCTOR	1	
	L4514	J0JYC0000068	CHIP INDUCTOR	1	
	L4515	J0JYC0000068	CHIP INDUCTOR	1	
	L4516	J0JYC0000068	CHIP INDUCTOR	1	
	L4517	J0JYC0000068	CHIP INDUCTOR	1	
	L4518	J0JYC0000068	CHIP INDUCTOR	1	
	L4519	J0JYC0000068	CHIP INDUCTOR	1	
	L5480	J0JYC0000068	CHIP INDUCTOR	1	
	L5481	G1C100MA0072	INDUCTION COIL	1	
	L5544	G1C470MA0291	INDUCTION COIL	1	
	L5600	G1C2R2Z00007	INDUCTION COIL	1	
	L5601	G1C3R3Z00004	INDUCTION COIL	1	
	L5602	G1C4R7Z00014	INDUCTION COIL	1	
	L5603	G1C6R8Z00008	INDUCTION COIL	1	
	L5604	G1C100MA0203	INDUCTION COIL	1	
	L5605	J0JHC0000075	CHIP INDUCTOR	1	
	L5606	G1C100MA0203	INDUCTION COIL	1	
	L8001	J0JHC0000045	CHIP INDUCTOR	1	
	L8002	J0JHC0000045	CHIP INDUCTOR	1	
	L8003	J0JHC0000045	CHIP INDUCTOR	1	
	L8004	J0JHC0000045	CHIP INDUCTOR	1	
	L8005	J0JHC0000045	CHIP INDUCTOR	1	
	L8007	J0JHC0000045	CHIP INDUCTOR	1	
	L8008	J0JHC0000045	CHIP INDUCTOR	1	
	L8009	J0JHC0000045	CHIP INDUCTOR	1	
	L8010	J0JHC0000045	CHIP INDUCTOR	1	
	L8011	J0JHC0000045	CHIP INDUCTOR	1	
	L8012	J0JHC0000045	CHIP INDUCTOR	1	
	L8013	J0JHC0000045	CHIP INDUCTOR	1	
	L8301	J0JHC0000045	CHIP INDUCTOR	1	
	L8303	G1CR15JA0020	INDUCTION COIL	1	
	L8304	J0JHC0000045	CHIP INDUCTOR	1	
	L8501	J0JHC0000045	CHIP INDUCTOR	1	
	L8580	J0JHC0000075	CHIP INDUCTOR	1	
	L9001	G1C3R3Z00004	INDUCTION COIL	1	
	L9802	G1C6R8Z00008	INDUCTION COIL	1	
	L9900	J0JHC0000117	CHIP INDUCTOR	1	
	L9901	J0JHC0000117	CHIP INDUCTOR	1	
	L9903	J0JHC0000117	CHIP INDUCTOR	1	
	PA5600	K5H5022A0031	FUSE	1	
△	PCB	TXNGK1EQUE	CIRCUIT BOARD GK	1	(RTL) PAVCCZ
△	PCB	A-P42C10Y	CIRCUIT BOARD A	1	(RTL) PAVCCZ
△	PCB	TXN/S1ETUE	CIRCUIT BOARD S	1	(RTL) PAVCCZ
△	PCB	TXN/K1ETUE	CIRCUIT BOARD K	1	(RTL) PAVCCZ
	Q2001	B1ABCF000231	TRANSISTOR	1	
	Q2022	B1ADCE000022	TRANSISTOR	1	
	Q2063	2SD0601ASL	TRANSISTOR	1	

Safety	Ref. No.	Part No.	Part Name & Description	Pcs	Remarks
	Q2064	2SD0601ASL	TRANSISTOR	1	
	Q2065	2SB0709ASL	TRANSISTOR	1	
	Q2510	2SD0601ARL	TRANSISTOR	1	
	Q2511	2SD0601ARL	TRANSISTOR	1	
	Q2513	2SD0601ARL	TRANSISTOR	1	
	Q2519	2SD0601ARL	TRANSISTOR	1	
	Q3000	B1ABCF000231	TRANSISTOR	1	
	Q3001	B1ABCF000231	TRANSISTOR	1	
	Q3002	B1ABCF000231	TRANSISTOR	1	
	Q3003	B1ABCF000231	TRANSISTOR	1	
	Q3004	B1ABCF000231	TRANSISTOR	1	
	Q3005	B1ABCF000231	TRANSISTOR	1	
	Q4500	B1ABCF000231	TRANSISTOR	1	
	Q4501	B1ABCF000231	TRANSISTOR	1	
	Q4514	2SB0709ASL	TRANSISTOR	1	
	Q4515	2SB0709ASL	TRANSISTOR	1	
	Q4516	2SB0709ASL	TRANSISTOR	1	
	Q4517	2SB0709ASL	TRANSISTOR	1	
	Q4519	2SB0709ASL	TRANSISTOR	1	
	Q4533	B1ABCF000231	TRANSISTOR	1	
	Q4534	B1ABCF000231	TRANSISTOR	1	
	Q5480	B1ADCE000022	TRANSISTOR	1	
	Q5600	B1MBDDA00003	FET	1	
	Q5601	B1MBDDA00003	FET	1	
	Q5602	B1MBDDA00003	FET	1	
	Q5603	B1MBDDA00003	FET	1	
	Q5606	2SD0601ARL	TRANSISTOR	1	
	Q5607	2SD0601ARL	TRANSISTOR	1	
	Q5608	2SB0709ARL	TRANSISTOR	1	
	Q8200	2SD0601ARL	TRANSISTOR	1	
	Q8401	2SD0601ARL	TRANSISTOR	1	
	Q8402	2SD0601ARL	TRANSISTOR	1	
	Q9000	B1ABCF000231	TRANSISTOR	1	
	Q9001	B1ABCF000231	TRANSISTOR	1	
	Q9002	B1ABCF000231	TRANSISTOR	1	
	Q9003	B1ABCF000231	TRANSISTOR	1	
	Q9004	B1ABCF000231	TRANSISTOR	1	
	Q9301	2SD0601ARL	TRANSISTOR	1	
	Q9302	2SD0601ARL	TRANSISTOR	1	
	Q9807	2SD0601ARL	TRANSISTOR	1	
	R0180	ERJ2GEJ101	M 100 OHM, J, 0.063W	1	
	R0605	ERJ2GEJ473	M 47KOHM, J, 0.063W	1	
	R0900	ERJ2GEJ680	M 68 OHM, J, 0.063W	1	
	R0901	EXB28V680JX	RESISTOR ARRAY	1	
	R0902	ERJ2GEJ102X	M 1K OHM J 1/4W	1	
	R0905	ERJ2GEJ103	M 10KOHM, J, 0.063W	1	
	R0906	ERJ2GEJ103	M 10KOHM, J, 0.063W	1	
	R0907	ERJ2GEJ103	M 10KOHM, J, 0.063W	1	
	R0909	ERJ2GEJ220	M 22 OHM, J, 0.063W	1	
	R0910	ERJ2GEJ220	M 22 OHM, J, 0.063W	1	
	R0911	ERJ2GEJ220	M 22 OHM, J, 0.063W	1	
	R0912	ERJ2GEJ220	M 22 OHM, J, 0.063W	1	
	R0913	ERJ2GEJ220	M 22 OHM, J, 0.063W	1	
	R0914	ERJ2GEJ220	M 22 OHM, J, 0.063W	1	
	R0915	ERJ2GEJ472	M 4.7KOHM, J, 0.063W	1	
	R0916	ERJ2GEJ472	M 4.7KOHM, J, 0.063W	1	
	R0917	ERJ2GEJ220	M 22 OHM, J, 0.063W	1	
	R0918	ERJ2GEJ220	M 22 OHM, J, 0.063W	1	

Safety	Ref. No.	Part No.	Part Name & Description	Pcs	Remarks
	R0919	ERJ2GEJ220	M 22 OHM, J, 0.063W	1	
	R0920	ERJ2GEJ220	M 22 OHM, J, 0.063W	1	
	R0927	ERJ2GEJ220	M 22 OHM, J, 0.063W	1	
	R0928	ERJ2GEJ220	M 22 OHM, J, 0.063W	1	
	R0929	ERJ2GEJ220	M 22 OHM, J, 0.063W	1	
	R0930	ERJ2GEJ220	M 22 OHM, J, 0.063W	1	
	R0933	DOYAR0000007	M 0 OHM 1/4W	1	
	R0934	DOYAR0000007	M 0 OHM 1/4W	1	
	R0937	ERJ2GEJ472	M 4.7KOHM, J, 0.063W	1	
	R0938	ERJ2GEJ472	M 4.7KOHM, J, 0.063W	1	
	R0939	ERJ2GEJ220	M 22 OHM, J, 0.063W	1	
	R0940	ERJ2GEJ220	M 22 OHM, J, 0.063W	1	
	R0941	DOYAR0000007	M 0 OHM 1/4W	1	
	R0942	DOYAR0000007	M 0 OHM 1/4W	1	
	R0945	ERJ2GEJ220	M 22 OHM, J, 0.063W	1	
	R0946	ERJ2GEJ220	M 22 OHM, J, 0.063W	1	
	R0947	ERJ2GEJ680	M 68 OHM, J, 0.063W	1	
	R0948	ERJ2GEJ680	M 68 OHM, J, 0.063W	1	
	R0949	ERJ2GEJ680	M 68 OHM, J, 0.063W	1	
	R0950	ERJ2GEJ680	M 68 OHM, J, 0.063W	1	
	R0951	ERJ2GEJ680	M 68 OHM, J, 0.063W	1	
	R0952	ERJ2GEJ680	M 68 OHM, J, 0.063W	1	
	R0953	ERJ2GEJ680	M 68 OHM, J, 0.063W	1	
	R0954	ERJ2GEJ680	M 68 OHM, J, 0.063W	1	
	R0955	ERJ2GEJ472	M 4.7KOHM, J, 0.063W	1	
	R0956	ERJ2GEJ472	M 4.7KOHM, J, 0.063W	1	
	R0957	ERJ2GEJ472	M 4.7KOHM, J, 0.063W	1	
	R0958	ERJ2GEJ472	M 4.7KOHM, J, 0.063W	1	
	R0959	ERJ2GEJ472	M 4.7KOHM, J, 0.063W	1	
	R0960	ERJ2GEJ472	M 4.7KOHM, J, 0.063W	1	
	R0961	ERJ2GEJ472	M 4.7KOHM, J, 0.063W	1	
	R0962	ERJ2GEJ472	M 4.7KOHM, J, 0.063W	1	
	R1010	DOGB103JA041	M 10K OHM J 1/16W	1	
	R1146	DOYAR0000007	M 0 OHM 1/4W	1	
	R1153	ERJ2GEJ681	M 680 OHM, J, 0.063W	1	
	R1163	ERJ2GEJ105	M 1MOHM, J, 0.063W	1	
	R1179	DOYAR0000007	M 0 OHM 1/4W	1	
	R1181	DOYAR0000007	M 0 OHM 1/4W	1	
	R1182	ERJ2GED273X	M 27KOHM, J, 0.063W	1	
	R1203	ERJ2GEJ473	M 47KOHM, J, 0.063W	1	
	R1209	ERJ2GEJ472	M 4.7KOHM, J, 0.063W	1	
	R1221	D1BB7151A055	M7.15KOHM, 1/10W	1	
	R1224	ERJ2GEJ103	M 10KOHM, J, 0.063W	1	
	R1225	ERJ2GEJ103	M 10KOHM, J, 0.063W	1	

Safety	Ref. No.	Part No.	Part Name & Description	Pcs	Remarks
	R1236	ERJ2GEJ473	M 47KOHM, J, 0.063W	1	
	R1237	ERJ2GEJ102X	M 1K OHM J 1/4W	1	
	R1243	ERJ2GEJ473	M 47KOHM, J, 0.063W	1	
	R1255	ERJ2GEJ102X	M 1K OHM J 1/4W	1	
	R1400	ERJ2GEJ103	M 10KOHM, J, 0.063W	1	
	R1401	ERJ2GEJ104	M 100KOHM, J, 0.063W	1	
	R1402	ERJ2GEJ683	M 68KOHM, J, 0.063W	1	
	R1403	ERJ2GEJ333	M 33KOHM, J, 0.063W	1	
	R1404	ERJ2GEJ683	M 68KOHM, J, 0.063W	1	
	R1405	ERJ2GEJ333	M 33KOHM, J, 0.063W	1	
	R1406	ERJ2GEJ683	M 68KOHM, J, 0.063W	1	
	R1407	ERJ2GEJ473	M 47KOHM, J, 0.063W	1	
	R1410	ERJ2GEJ103	M 10KOHM, J, 0.063W	1	
	R1411	ERJ2GEJ104	M 100KOHM, J, 0.063W	1	
	R1413	ERJ2GEJ473	M 47KOHM, J, 0.063W	1	
	R2002	ERJ2GEJ471	M 470 OHM, J, 0.063W	1	
	R2003	ERJ2GEJ105	M 1MOHM, J, 0.063W	1	
	R2006	ERJ2GEJ471	M 470 OHM, J, 0.063W	1	
	R2007	ERJ2GEJ221	M 220 OHM, J, 0.063W	1	
	R2008	ERJ2GEJ471	M 470 OHM, J, 0.063W	1	
	R2015	ERJ2GEJ103	M 10KOHM, J, 0.063W	1	
	R2016	ERJ2GEJ103	M 10KOHM, J, 0.063W	1	
	R2017	ERJ2GEJ103	M 10KOHM, J, 0.063W	1	
	R2018	ERJ2GEJ103	M 10KOHM, J, 0.063W	1	
	R2019	D1BB2002A055	M 20KOHM, 1/10W	1	
	R2020	D1BB2001A055	M 2KOHM, 1/10W	1	
	R2023	ERJ2GEJ103	M 10KOHM, J, 0.063W	1	
	R2032	ERJ2GEJ561	M 60 OHM, J, 0.063W	1	
	R2047	D1BB2802A055	M 28KOHM, 1/10W	1	
	R2048	D1BB2802A055	M 28KOHM, 1/10W	1	
	R2050	D1BB2802A055	M 28KOHM, 1/10W	1	
	R2051	D1BB2802A055	M 28KOHM, 1/10W	1	
	R2063	JOJCC0000287	CHIP INDUCTOR	1	
	R2064	JOJCC0000287	CHIP INDUCTOR	1	
	R2092	ERJ2GEJ103	M 10KOHM, J, 0.063W	1	
	R2093	ERJ2GEJ103	M 10KOHM, J, 0.063W	1	
	R2110	ERJ2GEJ101	M 100 OHM, J, 0.063W	1	
	R2111	ERJ2GEJ101	M 100 OHM, J, 0.063W	1	
	R2114	ERJ2GEJ222	M 2.2KOHM, J, 0.063W	1	
	R2115	ERJ2GEJ222	M 2.2KOHM, J, 0.063W	1	
	R2118	ERJ2GEJ471	M 470 OHM, J, 0.063W	1	
	R2119	ERJ2GEJ105	M 1MOHM, J, 0.063W	1	
	R2120	ERJ2GEJ473	M 47KOHM, J, 0.063W	1	
	R2121	ERJ8GEYJ3R3V	M 3.3 OHM, J, 1/8W	1	
	R2122	ERJ2GEJ101	M 100 OHM, J, 0.063W	1	



Safety	Ref. No.	Part No.	Part Name & Description	Pcs	Remarks
	R2123	ERJ8GEYJ3R3V	M 3.3 OHM, J,1/8W	1	
	R2124	ERJ2GEJ103	M 10KOHM, J,0.063W	1	
	R2125	ERJ8GEYJ3R3V	M 3.3 OHM, J,1/8W	1	
	R2127	ERJ8GEYJ3R3V	M 3.3 OHM, J,1/8W	1	
	R2129	ERJ2GEJ100	M 10 OHM, J,0.063W	1	
	R2132	ERJ2GEJ471	M 470 OHM, J,0.063W	1	
	R2137	ERJ2GEJ100	M 10 OHM, J,0.063W	1	
	R2141	ERJ2GEJ102X	M 1K OHM J 1/4W	1	
	R2142	ERJ2GEJ222	M 2.2KOHM, J,0.063W	1	
	R2172	ERJ2GEJ680	M 68 OHM, J,0.063W	1	
	R2190	ERJ2GEJ472	M 4.7KOHM, J,0.063W	1	
	R2316	EXB28V220J	RESISTOR ARRAY	1	
	R2325	D0YAR0000007	M 0 OHM 1/4W	1	
	R2516	ERJ3GEYJ223	M 22KOHM,J,1/16W	1	
	R2517	ERJ3GEYJ470	M 47 OHM,J,1/16W	1	
	R2520	ERJ3GEYJ224	M 22KOHM,J,1/16W	1	
	R2524	ERJ3GEYJ223	M 22KOHM,J,1/16W	1	
	R2525	D1BB7500A055	M 750 OHM, 1/10W	1	
	R2530	D0GB473JA057	M 47KOHM,J,1/16W	1	
	R2531	D1BB2700A055	M 270 OHM, 1/10W	1	
	R2542	D0GB473JA057	M 47KOHM,J,1/16W	1	
	R2556	D0GB103JA041	M 10K OHM J 1/16W	1	
	R2557	ERJ3GEYJ223	M 22KOHM,J,1/16W	1	
	R2561	ERJ3GEYJ223	M 22KOHM,J,1/16W	1	
	R2562	D0GB473JA057	M 47KOHM,J,1/16W	1	
	R2565	D1BB1001A055	M 1KOHM, 1/16W	1	
	R2581	D0GDR00Z0002	M 0 OHM, 1/10W	1	
	R2756	ERJ2GEJ101	M 100 OHM, J,0.063W	1	
	R2757	ERJ2GEJ101	M 100 OHM, J,0.063W	1	
	R2870	ERJ2GEJ390	M 39 OHM, J,0.063W	1	
	R2871	ERJ2GEJ103	M 10KOHM, J,0.063W	1	
	R2872	ERJ2GEJ683	M 68KOHM, J,0.063W	1	
	R2873	D0YAR0000007	M 0 OHM 1/4W	1	
	R2874	ERJ2GEJ103	M 10KOHM, J,0.063W	1	
	R2875	ERJ2GEJ203X	M 20KOHM,J,0.063W	1	
	R2905	D0YAR0000007	M 0 OHM 1/4W	1	
	R2909	D0YAR0000007	M 0 OHM 1/4W	1	
	R2915	ERJ2GEJ221	M 220 OHM, J,0.063W	1	
	R2916	ERJ3GEY0R00	M 0 OHM, 1/16W	1	
	R2930	ERJ2GEJ153	M 15KOHM, J,0.063W	1	
	R2941	D0YAR0000007	M 0 OHM 1/4W	1	
	R2942	D0YAR0000007	M 0 OHM 1/4W	1	
	R2960	ERJ2GEJ103	M 10KOHM, J,0.063W	1	
	R3000	ERJ2GEJ223	M 22KOHM, J,0.063W	1	
	R3001	ERJ2GEJ223	M 22KOHM, J,0.063W	1	
	R3002	ERJ2GEJ223	M 22KOHM, J,0.063W	1	
	R3003	ERJ2GEJ223	M 22KOHM, J,0.063W	1	
	R3004	ERJ2GEJ223	M 22KOHM, J,0.063W	1	
	R3005	ERJ2GEJ223	M 22KOHM, J,0.063W	1	
	R3006	ERJ2GEJ104	M 100KOHM, J,0.063W	1	

Safety	Ref. No.	Part No.	Part Name & Description	Pcs	Remarks
	R3007	ERJ2GEJ104	M 100KOHM, J,0.063W	1	
	R3008	ERJ2GEJ222	M 2.2KOHM, J,0.063W	1	
	R3009	ERJ2GEJ222	M 2.2KOHM, J,0.063W	1	
	R3010	ERJ2GEJ104	M 100KOHM, J,0.063W	1	
	R3011	ERJ2GEJ104	M 100KOHM, J,0.063W	1	
	R3012	ERJ2GEJ222	M 2.2KOHM, J,0.063W	1	
	R3013	ERJ2GEJ222	M 2.2KOHM, J,0.063W	1	
	R3014	ERJ2GEJ103	M 10KOHM, J,0.063W	1	
	R3019	ERJ2GEJ222	M 2.2KOHM, J,0.063W	1	
	R3021	ERJ2GEJ222	M 2.2KOHM, J,0.063W	1	
	R3024	ERJ2GEJ104	M 100KOHM, J,0.063W	1	
	R3025	ERJ2GEJ104	M 100KOHM, J,0.063W	1	
	R3028	ERJ2GEJ331	M 330 OHM, J,0.063W	1	
	R3029	ERJ2GEJ331	M 330 OHM, J,0.063W	1	
	R3030	J0JCC0000287	CHIP INDUCTOR	1	
	R3033	ERJ2GEJ221	M 220 OHM, J,0.063W	1	
	R3034	ERJ2GEJ221	M 220 OHM, J,0.063W	1	
	R3037	ERJ2GEJ221	M 220 OHM, J,0.063W	1	
	R3038	ERJ2GEJ221	M 220 OHM, J,0.063W	1	
	R3041	ERJ2GEJ331	M 330 OHM, J,0.063W	1	
	R3042	ERJ2GEJ331	M 330 OHM, J,0.063W	1	
	R3043	ERJ2GEJ221	M 220 OHM, J,0.063W	1	
	R3045	ERJ2GEJ221	M 220 OHM, J,0.063W	1	
	R3047	ERJ2GEJ221	M 220 OHM, J,0.063W	1	
	R3048	ERJ2GEJ221	M 220 OHM, J,0.063W	1	
	R3049	ERJ2GEJ221	M 220 OHM, J,0.063W	1	
	R3050	ERJ2GEJ221	M 220 OHM, J,0.063W	1	
	R3051	ERJ2GEJ221	M 220 OHM, J,0.063W	1	
	R3052	ERJ2GEJ221	M 220 OHM, J,0.063W	1	
	R3072	D1BD1500A044	M 150 OHM, 1/10W	1	
	R3073	D1BD1500A044	M 150 OHM, 1/10W	1	
	R3074	D1BD1500A044	M 150 OHM, 1/10W	1	
	R3075	D1BD1500A044	M 150 OHM, 1/10W	1	
	R3076	D1BD1500A044	M 150 OHM, 1/10W	1	
	R3077	D1BD1500A044	M 150 OHM, 1/10W	1	
	R3079	D1BD1500A044	M 150 OHM, 1/10W	1	
	R3081	D1BD1500A044	M 150 OHM, 1/10W	1	
	R3082	D1BD1500A044	M 150 OHM, 1/10W	1	
	R3083	D1BD1500A044	M 150 OHM, 1/10W	1	
	R3084	ERJ6RED750	M 75 OHM, 1/10W	1	
	R3085	ERJ6RED750	M 75 OHM, 1/10W	1	
	R3086	ERJ6RED750	M 75 OHM, 1/10W	1	
	R3087	D1BD1500A044	M 150 OHM, 1/10W	1	
	R3089	ERJ2GEJ680	M 68 OHM, J,0.063W	1	
	R3091	ERJ2RKF2152	M 21.5K OHM, J, 2W	1	PAVCCZ
	R3092	ERJ2RKF2152	M 21.5K OHM, J, 2W	1	PAVCCZ
	R3094	ERJ2RKF1302	M 13K OHM, J, 2W	1	
	R3097	D1BD1500A044	M 150 OHM, 1/10W	1	

Safety	Ref. No.	Part No.	Part Name & Description	Pcs	Remarks
	R3098	D1BD1500A044	M 150 OHM, 1/10W	1	
	R3100	ERJ2GEJ104	M 100KOHM, J,0.063W	1	
	R3102	D1BD1500A044	M 150 OHM, 1/10W	1	
	R3104	D1BD1500A044	M 150 OHM, 1/10W	1	
	R3106	ERJ2GED273X	M 27KOHM, J,0.063W	1	
	R3108	ERJ2GED273X	M 27KOHM, J,0.063W	1	
	R3112	DOYAR0000007	M 0 OHM 1/4W	1	
	R3113	DOYAR0000007	M 0 OHM 1/4W	1	
	R3115	ERJ2GEJ221	M 220 OHM, J,0.063W	1	
	R3116	ERJ2GEJ221	M 220 OHM, J,0.063W	1	
	R3117	ERJ2GEJ221	M 220 OHM, J,0.063W	1	
	R3118	ERJ2GEJ221	M 220 OHM, J,0.063W	1	
	R3119	ERJ2GEJ221	M 220 OHM, J,0.063W	1	
	R3120	ERJ2GEJ331	M 330 OHM, J,0.063W	1	
	R3121	ERJ6RED750	M 75 OHM, 1/10W	1	
	R3123	ERJ2GEJ221	M 220 OHM, J,0.063W	1	
	R3128	ERJ2GEJ221	M 220 OHM, J,0.063W	1	
	R3132	ERJ2GEJ820	M 82 OHM, J,0.063W	1	
	R3133	ERJ2GEJ820	M 82 OHM, J,0.063W	1	
	R3134	ERJ2GEJ820	M 82 OHM, J,0.063W	1	
	R3135	ERJ2GEJ221	M 220 OHM, J,0.063W	1	
	R3136	ERJ2GEJ221	M 220 OHM, J,0.063W	1	
	R3137	ERJ2GEJ221	M 220 OHM, J,0.063W	1	
	R3138	ERJ2GEJ221	M 220 OHM, J,0.063W	1	
	R3139	ERJ2GEJ221	M 220 OHM, J,0.063W	1	
	R3140	ERJ2GEJ221	M 220 OHM, J,0.063W	1	
	R3143	ERJ2GEJ680	M 68 OHM, J,0.063W	1	
	R3146	ERJ2GEJ331	M 330 OHM, J,0.063W	1	
	R3150	ERJ2GEJ680	M 68 OHM, J,0.063W	1	
	R3153	ERJ2GEJ680	M 68 OHM, J,0.063W	1	
	R3167	ERJ6RED750	M 75 OHM, 1/10W	1	
	R3169	ERJ2GEJ104	M 100KOHM, J,0.063W	1	
	R3172	ERJ6RED750	M 75 OHM, 1/10W	1	
	R3174	ERJ2GEJ104	M 100KOHM, J,0.063W	1	
	R3182	ERJ2RKF1302	M 13K OHM, J, 2W	1	
	R3186	D1BD1500A044	M 150 OHM, 1/10W	1	
	R3187	D1BD1500A044	M 150 OHM, 1/10W	1	
	R3188	D1BD1500A044	M 150 OHM, 1/10W	1	
	R3193	D1BD1500A044	M 150 OHM, 1/10W	1	
	R3198	D1BD1500A044	M 150 OHM, 1/10W	1	
	R3204	D1BD1500A044	M 150 OHM, 1/10W	1	
	R3205	D1BD1500A044	M 150 OHM, 1/10W	1	
	R3206	ERJ2GEJ220	M 22 OHM, J,0.063W	1	
	R3207	ERJ2GEJ220	M 22 OHM, J,0.063W	1	
	R3212	D1BD1500A044	M 150 OHM, 1/10W	1	
	R3213	D1BD1500A044	M 150 OHM, 1/10W	1	
	R3236	ERJ2GEJ680	M 68 OHM, J,0.063W	1	
	R3237	ERJ2GEJ680	M 68 OHM, J,0.063W	1	

Safety	Ref. No.	Part No.	Part Name & Description	Pcs	Remarks
	R3240	ERJ2GEJ221	M 220 OHM, J,0.063W	1	
	R3245	ERJ2GEJ221	M 220 OHM, J,0.063W	1	
	R3256	DOGDR00Z0002	M 0 OHM, 1/10W	1	
	R3308	ERJ2GEJ223	M 22KOHM, J,0.063W	1	
	R3309	ERJ2GEJ223	M 22KOHM, J,0.063W	1	
	R3770	D1BD1432A044	M14.3KOHM, 1/10W	1	
	R3771	D1BD6651A044	M6.65KOHM, 1/10W	1	
	R3772	D1BD1741A044	M1.74KOHM, 1/10W	1	
	R3775	ERJ6ENF7151	M7.15KOHM, 1/10W	1	
	R4277	ERJ2GEJ103	M 10KOHM, J,0.063W	1	
	R4284	ERJ2GEJ103	M 10KOHM, J,0.063W	1	
	R4285	ERJ2GEJ103	M 10KOHM, J,0.063W	1	
	R4286	ERJ2GEJ103	M 10KOHM, J,0.063W	1	
	R4294	ERJ2GEJ103	M 10KOHM, J,0.063W	1	
	R4300	ERJ2GEJ103	M 10KOHM, J,0.063W	1	
	R4305	ERJ2GEJ473	M 47KOHM, J,0.063W	1	
	R4306	ERJ2GEJ473	M 47KOHM, J,0.063W	1	
	R4500	ERJ2GEJ103	M 10KOHM, J,0.063W	1	
	R4501	ERJ2GEJ103	M 10KOHM, J,0.063W	1	
	R4502	ERJ2RKD330	M 33 OHM, J, 2W	1	
	R4503	ERJ2RKD330	M 33 OHM, J, 2W	1	
	R4504	ERJ2GEJ102X	M 1K OHM J 1/4W	1	
	R4505	ERJ2GEJ102X	M 1K OHM J 1/4W	1	
	R4506	ERJ2GEJ473	M 47KOHM, J,0.063W	1	
	R4507	ERJ2GEJ473	M 47KOHM, J,0.063W	1	
	R4524	ERJ2GEJ103	M 10KOHM, J,0.063W	1	
	R4525	ERJ2GEJ103	M 10KOHM, J,0.063W	1	
	R4528	ERJ2GEJ103	M 10KOHM, J,0.063W	1	
	R4529	ERJ2GEJ103	M 10KOHM, J,0.063W	1	
	R4530	ERJ2GEJ103	M 10KOHM, J,0.063W	1	
	R4531	ERJ2GEJ103	M 10KOHM, J,0.063W	1	
	R4532	ERJ2GEJ473	M 47KOHM, J,0.063W	1	
	R4533	ERJ2GEJ473	M 47KOHM, J,0.063W	1	
	R4534	ERJ2GEJ473	M 47KOHM, J,0.063W	1	
	R4538	ERJ2GEJ473	M 47KOHM, J,0.063W	1	
	R4539	DOYAR0000007	M 0 OHM 1/4W	1	
	R4540	ERJ2GEJ473	M 47KOHM, J,0.063W	1	
	R4541	DOYAR0000007	M 0 OHM 1/4W	1	
	R4542	DOYAR0000007	M 0 OHM 1/4W	1	
	R4543	DOYAR0000007	M 0 OHM 1/4W	1	
	R4552	ERJ2GEJ220	M 22 OHM, J,0.063W	1	
	R4587	D1BB60400001	M 604 OHM, 1/10W	1	
	R4588	D1BB8060A055	M 806 OHM, 1/10W	1	
	R4589	D1BB8060A055	M 806 OHM, 1/10W	1	
	R4592	D1BB8060A055	M 806 OHM, 1/10W	1	
	R4593	D1BB2201A055	M 2.2KOHM, 1/10W	1	
	R4596	ERJ6GEYJ102V	M 1K OHM J 1/10W	1	
	R4597	ERJ6GEYJ102V	M 1K OHM J 1/10W	1	
	R4598	ERJ6GEYJ102V	M 1K OHM J 1/10W	1	
	R4601	ERJ6GEYJ102V	M 1K OHM J 1/10W	1	

Safety	Ref. No.	Part No.	Part Name & Description	Pcs	Remarks
	R4605	D1BB2201A055	M 2.2KOHM, 1/10W	1	
	R4607	D0YAR0000007	M 0 OHM 1/4W	1	
	R4608	ERJ6GEYJ102V	M 1K OHM J 1/10W	1	
	R4609	ERJ2GEJ122	M 1.2KOHM, J,0.063W	1	
	R4613	D0YAR0000007	M 0 OHM 1/4W	1	
	R4614	D0YAR0000007	M 0 OHM 1/4W	1	
	R4615	D0YAR0000007	M 0 OHM 1/4W	1	
	R4616	D0YAR0000007	M 0 OHM 1/4W	1	
	R4620	ERJ2GEJ473	M 47KOHM, J,0.063W	1	
	R4622	ERJ2GEJ102X	M 1K OHM J 1/4W	1	
	R4623	D0YAR0000007	M 0 OHM 1/4W	1	
	R4624	ERJ2GEJ103	M 10KOHM, J,0.063W	1	
	R4626	D1BB2200A055	M 220 OHM, 1/10W	1	
	R4627	D1BB2200A055	M 220 OHM, 1/10W	1	
	R4631	D1BB4990A055	M 499 OHM, 1/10W	1	
	R4634	D1BB2200A055	M 220 OHM, 1/10W	1	
	R4635	EXB28V680JX	RESISTOR ARRAY	1	
	R4636	ERJ2GEJ680	M 68 OHM, J,0.063W	1	
	R4637	ERJ2GEJ473	M 47KOHM, J,0.063W	1	
	R4638	ERJ2GEJ680	M 68 OHM, J,0.063W	1	
	R4639	EXB28V680JX	RESISTOR ARRAY	1	
	R4640	EXB28V680JX	RESISTOR ARRAY	1	
	R4641	ERJ2GEJ473	M 47KOHM, J,0.063W	1	
	R4642	ERJ2GEJ473	M 47KOHM, J,0.063W	1	
	R4645	ERJ2GEJ680	M 68 OHM, J,0.063W	1	
	R4646	ERJ2GEJ680	M 68 OHM, J,0.063W	1	
	R4648	EXB28V330J	RESISTOR ARRAY	1	
	R4649	EXB28V680JX	RESISTOR ARRAY	1	
	R4650	ERJ2GEJ680	M 68 OHM, J,0.063W	1	
	R4651	ERJ2GEJ680	M 68 OHM, J,0.063W	1	
	R4652	ERJ2GEJ473	M 47KOHM, J,0.063W	1	
	R4656	ERJ2GEJ222	M 2.2KOHM, J,0.063W	1	
	R4664	D1BB60400001	M 604 OHM, 1/10W	1	
	R4665	ERJ2GEJ473	M 47KOHM, J,0.063W	1	
	R4666	ERJ2GEJ473	M 47KOHM, J,0.063W	1	
	R4672	ERJ2GEJ473	M 47KOHM, J,0.063W	1	
	R4674	ERJ2GEJ103	M 10KOHM, J,0.063W	1	
	R4677	ERJ2GEJ103	M 10KOHM, J,0.063W	1	
	R4678	EXB28V680JX	RESISTOR ARRAY	1	
	R4679	EXB28V680JX	RESISTOR ARRAY	1	
	R4698	ERJ2GEJ104	M 100KOHM, J,0.063W	1	
	R4699	ERJ2GEJ104	M 100KOHM, J,0.063W	1	
	R4700	ERJ2GEJ473	M 47KOHM, J,0.063W	1	
	R4707	ERJ2GEJ473	M 47KOHM, J,0.063W	1	
	R4736	ERJ2GEJ473	M 47KOHM, J,0.063W	1	
	R4738	ERJ2GEJ473	M 47KOHM, J,0.063W	1	
	R4799	EXB28V680JX	RESISTOR ARRAY	1	
	R5470	ERJ2GEJ222	M 2.2KOHM, J,0.063W	1	
	R5471	ERJ2GEJ101	M 100 OHM, J,0.063W	1	
	R5472	ERJ2GEJ470	M 47 OHM, J,0.063W	1	

Safety	Ref. No.	Part No.	Part Name & Description	Pcs	Remarks
	R5473	ERJ2GEJ473	M 47KOHM, J,0.063W	1	
	R5474	ERJ2GEJ103	M 10KOHM, J,0.063W	1	
	R5475	ERJ2GEJ123	M 12KOHM, J,0.063W	1	
	R5482	ERJ6GEYJ150V	M 15 OHM, J,1/10W	1	
	R5484	D1BB3902A055	M 39KOHM, 1/10W	1	
	R5485	ERJ2GEJ101	M 100 OHM, J,0.063W	1	
	R5486	ERJ2GEJ103	M 10KOHM, J,0.063W	1	
	R5488	D0YAR0000007	M 0 OHM 1/4W	1	
	R5489	ERJ2RKD330	M 33 OHM, J, 2W	1	
	R5490	ERJ2GEJ473	M 47KOHM, J,0.063W	1	
	R5491	ERJ2GEJ473	M 47KOHM, J,0.063W	1	
	R5492	ERJ2GEJ105	M 1MOHM, J,0.063W	1	
	R5493	ERJ2GEJ203X	M 20KOHM, J,0.063W	1	
	R5494	ERJ2GEJ103	M 10KOHM, J,0.063W	1	
	R5496	ERJ2GEJ680	M 68 OHM, J,0.063W	1	
	R5541	D1BB1003A055	M 100KOHM, 1/10W	1	
	R5542	D1BB3401A055	M 3.4KOHM, 1/10W	1	
	R5543	ERJ6GEYJ153V	M 15KOHM, J,1/10W	1	
	R5581	ERJ2GEJ473	M 47KOHM, J,0.063W	1	
	R5582	ERJ2GEJ473	M 47KOHM, J,0.063W	1	
	R5600	D1BB3901A055	M 3.9KOHM, 1/10W	1	
	R5604	D1BB2402A055	M 24KOHM, 1/10W	1	
	R5605	D1BB3901A055	M 3.9KOHM, 1/10W	1	
	R5610	D1BB2201A055	M 2.2KOHM, 1/10W	1	
	R5611	D1BB1202A055	M 12KOHM, 1/10W	1	
	R5612	D1BB2002A055	M 20KOHM, 1/10W	1	
	R5613	ERJ2GEJ5R6X	M 5.6 OHM, J,0.063W	1	
	R5622	ERJ2GEJ5R6X	M 5.6 OHM, J,0.063W	1	
	R5629	D1BB2101A055	M 2.1KOHM, 1/10W	1	
	R5630	D1BB3301A055	M 3.3KOHM, 1/16W	1	
	R5631	D1BB3901A055	M 3.9KOHM, 1/10W	1	
	R5632	D1BB4021A055	M 4.2KOHM, 1/16W	1	
	R5633	D1BB1202A055	M 12KOHM, 1/10W	1	
	R5634	D1BB1602A055	M 16KOHM, 1/10W	1	
	R5635	ERJ2GEJ223	M 22KOHM, J,0.063W	1	
	R5636	ERJ2GEJ683	M 68KOHM, J,0.063W	1	
	R5646	ERJ2GEJ103	M 10KOHM, J,0.063W	1	
	R5647	ERJ2GEJ473	M 47KOHM, J,0.063W	1	
	R5657	ERJ2GEJ222	M 2.2KOHM, J,0.063W	1	
	R5658	ERJ2GEJ473	M 47KOHM, J,0.063W	1	
	R5659	ERJ2GEJ103	M 10KOHM, J,0.063W	1	
	R5668	ERJ2GEJ222	M 2.2KOHM, J,0.063W	1	
	R5669	ERJ2GEJ332	M 3.3KOHM, J,0.063W	1	
	R5670	ERJ2GEJ102X	M 1K OHM J 1/4W	1	
	R5671	ERJ2GEJ103	M 10KOHM, J,0.063W	1	
	R5672	ERJ6GEYJ221V	M 220 OHM, J,1/10W	1	
	R5674	ERJ6GEYJ471	M 470 OHM, J,1/10W	1	
	R5676	ERJ2GEJ221	M 220 OHM, J,0.063W	1	
	R5678	ERJ2GEJ471	M 470 OHM, J,0.063W	1	
	R8004	D1BB2402A055	M 24KOHM, 1/10W	1	

Safety	Ref. No.	Part No.	Part Name & Description	Pcs	Remarks
	R8005	D1BB1002A055	M 10KOHM, 1/10W	1	
	R8006	D1BB2402A055	M 24KOHM, 1/10W	1	
	R8007	DOGBR00Z0002	M 0 OHM J 1/16W	1	
	R8026	DOYAR0000007	M 0 OHM 1/4W	1	
	R8027	DOYAR0000007	M 0 OHM 1/4W	1	
	R8030	ERJ2GEJ101	M 100 OHM, J, 0.063W	1	
	R8031	ERJ2RKF1001	M 1KOHM, 0.063W	1	
	R8032	ERJ2RKF1001	M 1KOHM, 0.063W	1	
	R8056	ERJ2GEJ470	M 47 OHM, J, 0.063W	1	
	R8057	ERJ2GEJ470	M 47 OHM, J, 0.063W	1	
	R8058	ERJ2GEJ470	M 47 OHM, J, 0.063W	1	
	R8059	ERJ2GEJ470	M 47 OHM, J, 0.063W	1	
	R8060	ERJ2GEJ470	M 47 OHM, J, 0.063W	1	
	R8061	ERJ2GEJ470	M 47 OHM, J, 0.063W	1	
	R8062	ERJ2GEJ470	M 47 OHM, J, 0.063W	1	
	R8063	ERJ2GEJ470	M 47 OHM, J, 0.063W	1	
	R8064	ERJ2GEJ470	M 47 OHM, J, 0.063W	1	
	R8065	ERJ2GEJ470	M 47 OHM, J, 0.063W	1	
	R8066	ERJ2GEJ470	M 47 OHM, J, 0.063W	1	
	R8067	ERJ2GEJ470	M 47 OHM, J, 0.063W	1	
	R8068	ERJ2GEJ470	M 47 OHM, J, 0.063W	1	
	R8069	ERJ2GEJ470	M 47 OHM, J, 0.063W	1	
	R8070	ERJ2GEJ470	M 47 OHM, J, 0.063W	1	
	R8071	ERJ2GEJ470	M 47 OHM, J, 0.063W	1	
	R8072	ERJ2GEJ470	M 47 OHM, J, 0.063W	1	
	R8073	ERJ2GEJ470	M 47 OHM, J, 0.063W	1	
	R8074	ERJ2GEJ221	M 220 OHM, J, 0.063W	1	
	R8075	ERJ2GEJ470	M 47 OHM, J, 0.063W	1	
	R8076	ERJ2GEJ470	M 47 OHM, J, 0.063W	1	
	R8077	ERJ2GEJ470	M 47 OHM, J, 0.063W	1	
	R8078	ERJ2GEJ470	M 47 OHM, J, 0.063W	1	
	R8081	ERJ2GEJ103	M 10KOHM, J, 0.063W	1	
	R8082	ERJ2RKF75R0	M 75 OHM, , 0.063W	1	
	R8083	ERJ2GEJ301	M 300 OHM, J, 0.063W	1	
	R8086	ERJ2GEJ104	M 100KOHM, J, 0.063W	1	
	R8088	ERJ2GEJ103	M 10KOHM, J, 0.063W	1	
	R8090	ERJ2GEJ103	M 10KOHM, J, 0.063W	1	
	R8091	ERJ2GEJ470	M 47 OHM, J, 0.063W	1	
	R8093	ERJ2GEJ470	M 47 OHM, J, 0.063W	1	
	R8095	ERJ2GEJ103	M 10KOHM, J, 0.063W	1	
	R8096	ERJ2GEJ820	M 82 OHM, J, 0.063W	1	
	R8097	ERJ2GEJ221	M 220 OHM, J, 0.063W	1	
	R8100	ERJ2GEJ470	M 47 OHM, J, 0.063W	1	

Safety	Ref. No.	Part No.	Part Name & Description	Pcs	Remarks
	R8101	ERJ2GEJ103	M 10KOHM, J, 0.063W	1	
	R8109	ERJ2GEJ222	M 2.2KOHM, J, 0.063W	1	
	R8244	ERJ2GEJ103	M 10KOHM, J, 0.063W	1	
	R8245	ERJ2GEJ103	M 10KOHM, J, 0.063W	1	
	R8260	ERJ2GEJ102X	M 1K OHM J 1/4W	1	
	R8272	ERJ2GEJ103	M 10KOHM, J, 0.063W	1	
	R8301	EXB2HV680J	RESISTOR ARRAY	1	
	R8305	ERJ2GEJ102X	M 1K OHM J 1/4W	1	
	R8308	ERJ2GEJ680	M 68 OHM, J, 0.063W	1	
	R8312	ERJ2GEJ102X	M 1K OHM J 1/4W	1	
	R8313	ERJ2GEJ225	M 1MOHM, J, 0.063W	1	
	R8321	ERJ2GEJ103	M 10KOHM, J, 0.063W	1	
	R8322	ERJ2GEJ222	M 2.2KOHM, J, 0.063W	1	
	R8323	ERJ2GEJ222	M 2.2KOHM, J, 0.063W	1	
	R8324	ERJ2GEJ222	M 2.2KOHM, J, 0.063W	1	
	R8325	ERJ2GEJ680	M 68 OHM, J, 0.063W	1	
	R8326	ERJ2GEJ680	M 68 OHM, J, 0.063W	1	
	R8327	ERJ2GEJ680	M 68 OHM, J, 0.063W	1	
	R8328	ERJ2GEJ103	M 10KOHM, J, 0.063W	1	
	R8332	EXB2HV101J	RESISTOR ARRAY	1	
	R8333	EXB2HV101J	RESISTOR ARRAY	1	
	R8335	EXB2HV680J	RESISTOR ARRAY	1	
	R8336	EXB2HV680J	RESISTOR ARRAY	1	
	R8337	EXB28V680JX	RESISTOR ARRAY	1	
	R8338	ERJ2GEJ680	M 68 OHM, J, 0.063W	1	
	R8339	ERJ2GEJ680	M 68 OHM, J, 0.063W	1	
	R8340	DOYAR0000007	M 0 OHM 1/4W	1	
	R8345	ERJ2GEJ103	M 10KOHM, J, 0.063W	1	
	R8347	DOYAR0000007	M 0 OHM 1/4W	1	
	R8353	ERJ2GEJ680	M 68 OHM, J, 0.063W	1	
	R8354	ERJ2GEJ680	M 68 OHM, J, 0.063W	1	
	R8356	DOYAR0000007	M 0 OHM 1/4W	1	
	R8395	ERJ2GEJ103	M 10KOHM, J, 0.063W	1	
	R8404	ERJ2GEJ103	M 10KOHM, J, 0.063W	1	
	R8405	ERJ2GEJ103	M 10KOHM, J, 0.063W	1	
	R8406	DOGFR10JA020	M 1 OHM, J, 0.33W	1	PAVCCZ
	R8407	ERJ2GEJ473	M 47KOHM, J, 0.063W	1	
	R8410	ERJ2GEJ223	M 22KOHM, J, 0.063W	1	
	R8411	ERJ2GEJ223	M 22KOHM, J, 0.063W	1	
	R8412	ERJ2GEJ103	M 10KOHM, J, 0.063W	1	
	R8413	ERJ2GEJ103	M 10KOHM, J, 0.063W	1	
	R8415	ERJ2GEJ222	M 2.2KOHM, J, 0.063W	1	
	R8416	ERJ2GEJ223	M 22KOHM, J, 0.063W	1	
	R8417	ERJ2GEJ104	M 100KOHM, J, 0.063W	1	
	R8418	ERJ2GEJ681	M 680 OHM, J, 0.063W	1	
	R8421	ERJ2GEJ680	M 68 OHM, J, 0.063W	1	

Safety	Ref. No.	Part No.	Part Name & Description	Pcs	Remarks
	R8422	ERJ2GEJ680	M 68 OHM, J,0.063W	1	
	R8423	ERJ2GEJ680	M 68 OHM, J,0.063W	1	
	R8424	ERJ2GEJ680	M 68 OHM, J,0.063W	1	
	R8425	ERJ2GEJ680	M 68 OHM, J,0.063W	1	
	R8426	EXB2HV680J	RESISTOR ARRAY	1	
	R8428	EXB2HV680J	RESISTOR ARRAY	1	
	R8430	ERJ2GEJ101	M 100 OHM, J,0.063W	1	
	R8431	ERJ2GEJ151	M 150 OHM, J,0.063W	1	
	R8432	ERJ2GEJ151	M 150 OHM, J,0.063W	1	
	R8433	ERJ2GEJ223	M 22KOHM, J,0.063W	1	
	R8434	ERJ2GEJ473	M 47KOHM, J,0.063W	1	
	R8435	ERJ2GEJ103	M 10KOHM, J,0.063W	1	
	R8436	ERJ2GEJ103	M 10KOHM, J,0.063W	1	
	R8437	EXB2HV104JV	RESISTOR ARRAY	1	
	R8438	ERJ2GEJ104	M 100KOHM, J,0.063W	1	
	R8439	ERJ2GEJ680	M 68 OHM, J,0.063W	1	
	R8440	ERJ2GEJ104	M 100KOHM, J,0.063W	1	
	R8441	EXB2HV680J	RESISTOR ARRAY	1	
	R8442	ERJ2GEJ680	M 68 OHM, J,0.063W	1	
	R8445	ERJ2GEJ104	M 100KOHM, J,0.063W	1	
	R8446	ERJ2GEJ680	M 68 OHM, J,0.063W	1	
	R8449	ERJ2GEJ680	M 68 OHM, J,0.063W	1	
	R8450	ERJ2GEJ103	M 10KOHM, J,0.063W	1	
	R8453	EXB2HV680J	RESISTOR ARRAY	1	
	R8454	EXB28V151J	RESISTOR ARRAY	1	
	R8455	EXB2HV680J	RESISTOR ARRAY	1	
	R8456	ERJ2GEJ680	M 68 OHM, J,0.063W	1	
	R8457	ERJ2GEJ680	M 68 OHM, J,0.063W	1	
	R8458	ERJ2GEJ680	M 68 OHM, J,0.063W	1	
	R8459	ERJ2GEJ680	M 68 OHM, J,0.063W	1	
	R8460	ERJ2GEJ680	M 68 OHM, J,0.063W	1	
	R8461	ERJ2GEJ680	M 68 OHM, J,0.063W	1	
	R8463	EXB28V151J	RESISTOR ARRAY	1	
	R8464	ERJ2GEJ680	M 68 OHM, J,0.063W	1	
	R8465	ERJ2GEJ103	M 10KOHM, J,0.063W	1	
	R8466	ERJ2GEJ103	M 10KOHM, J,0.063W	1	
	R8467	EXB28V151J	RESISTOR ARRAY	1	
	R8468	ERJ2GEJ680	M 68 OHM, J,0.063W	1	
	R8469	ERJ2GEJ680	M 68 OHM, J,0.063W	1	
	R8470	EXB28V151J	RESISTOR ARRAY	1	
	R8471	ERJ2GEJ103	M 10KOHM, J,0.063W	1	
	R8476	ERJ2GEJ103	M 10KOHM, J,0.063W	1	
	R8477	ERJ2GEJ103	M 10KOHM, J,0.063W	1	
	R8479	ERJ2GEJ103	M 10KOHM, J,0.063W	1	
	R8487	EXB28V680JX	RESISTOR ARRAY	1	

Safety	Ref. No.	Part No.	Part Name & Description	Pcs	Remarks
	R8488	EXB28V680JX	RESISTOR ARRAY	1	
	R8489	ERJ2GEJ680	M 68 OHM, J,0.063W	1	
	R8491	ERJ2GEJ223	M 22KOHM, J,0.063W	1	
	R8494	ERJ2GEJ222	M 2.2KOHM, J,0.063W	1	
	R8496	ERJ2GEJ222	M 2.2KOHM, J,0.063W	1	
	R8501	ERJ2GEJ101	M 100 OHM, J,0.063W	1	
	R8502	ERJ2GEJ331	M 330 OHM, J,0.063W	1	
	R8503	ERJ2GEJ331	M 330 OHM, J,0.063W	1	
	R8504	ERJ2GEJ331	M 330 OHM, J,0.063W	1	
	R8506	ERJ2GEJ331	M 330 OHM, J,0.063W	1	
	R8508	ERJ2GEJ680	M 68 OHM, J,0.063W	1	
	R8509	D1BB1600A055	M 160 OHM, 1/10W	1	
	R8510	D1BB1600A055	M 160 OHM, 1/10W	1	
	R8511	ERJ2GEJ472	M 4.7KOHM, J,0.063W	1	
	R8512	ERJ2GEJ222	M 2.2KOHM, J,0.063W	1	
	R8514	ERJ2GEJ680	M 68 OHM, J,0.063W	1	
	R8515	ERJ2GEJ222	M 2.2KOHM, J,0.063W	1	
	R8516	ERJ2GEJ222	M 2.2KOHM, J,0.063W	1	
	R8517	ERJ2GEJ103	M 10KOHM, J,0.063W	1	
	R8520	ERJ2GEJ103	M 10KOHM, J,0.063W	1	
	R8558	ERJ2GEJ680	M 68 OHM, J,0.063W	1	
	R8575	ERJ2GEJ680	M 68 OHM, J,0.063W	1	
	R8576	ERJ2GEJ680	M 68 OHM, J,0.063W	1	
	R8577	ERJ2GEJ680	M 68 OHM, J,0.063W	1	
	R8578	ERJ2GEJ680	M 68 OHM, J,0.063W	1	
	R8579	ERJ2GEJ680	M 68 OHM, J,0.063W	1	
	R8580	ERJ2GEJ680	M 68 OHM, J,0.063W	1	
	R8581	ERJ2GEJ103	M 10KOHM, J,0.063W	1	
	R8582	ERJ2GEJ680	M 68 OHM, J,0.063W	1	
	R8585	ERJ2GEJ680	M 68 OHM, J,0.063W	1	
	R8608	ERJ2GEJ680	M 68 OHM, J,0.063W	1	
	R8609	ERJ2GEJ103	M 10KOHM, J,0.063W	1	
	R8610	ERJ2GEJ680	M 68 OHM, J,0.063W	1	
	R8611	ERJ2GEJ680	M 68 OHM, J,0.063W	1	
	R8612	ERJ2GEJ680	M 68 OHM, J,0.063W	1	
	R8613	ERJ2GEJ680	M 68 OHM, J,0.063W	1	
	R8614	ERJ2GEJ680	M 68 OHM, J,0.063W	1	
	R8615	ERJ2GEJ680	M 68 OHM, J,0.063W	1	
	R8616	ERJ2GEJ680	M 68 OHM, J,0.063W	1	
	R8617	ERJ2GEJ680	M 68 OHM, J,0.063W	1	
	R8618	ERJ2GEJ103	M 10KOHM, J,0.063W	1	



Safety	Ref. No.	Part No.	Part Name & Description	Pcs	Remarks
	R8619	ERJ2GEJ103	M 10KOHM, J, 0.063W	1	
	R8620	ERJ2GEJ103	M 10KOHM, J, 0.063W	1	
	R8626	ERJ2GEJ103	M 10KOHM, J, 0.063W	1	
	R8627	ERJ2GEJ103	M 10KOHM, J, 0.063W	1	
	R8628	ERJ2GEJ103	M 10KOHM, J, 0.063W	1	
	R8629	ERJ2GEJ103	M 10KOHM, J, 0.063W	1	
	R8630	ERJ2GEJ103	M 10KOHM, J, 0.063W	1	
	R8637	ERJ2GEJ680	M 68 OHM, J, 0.063W	1	
	R8638	ERJ2GEJ680	M 68 OHM, J, 0.063W	1	
	R8639	ERJ2GEJ680	M 68 OHM, J, 0.063W	1	
	R8640	ERJ2GEJ103	M 10KOHM, J, 0.063W	1	
	R8641	ERJ2GEJ103	M 10KOHM, J, 0.063W	1	
	R8642	ERJ2GEJ103	M 10KOHM, J, 0.063W	1	
	R8644	DOYAR0000007	M 0 OHM 1/4W	1	
	R8645	ERJ2GEJ680	M 68 OHM, J, 0.063W	1	
	R8646	ERJ2GEJ680	M 68 OHM, J, 0.063W	1	
	R8647	ERJ2GEJ680	M 68 OHM, J, 0.063W	1	
	R8651	ERJ2GEJ680	M 68 OHM, J, 0.063W	1	
	R8653	ERJ2GEJ680	M 68 OHM, J, 0.063W	1	
	R8654	ERJ2GEJ103	M 10KOHM, J, 0.063W	1	
	R8660	DOYAR0000007	M 0 OHM 1/4W	1	
	R8661	ERJ2GEJ103	M 10KOHM, J, 0.063W	1	
	R8663	ERJ2GEJ103	M 10KOHM, J, 0.063W	1	
	R8665	ERJ2GEJ222	M 2.2KOHM, J, 0.063W	1	
	R8667	ERJ2GEJ680	M 68 OHM, J, 0.063W	1	
	R8670	ERJ2GEJ222	M 2.2KOHM, J, 0.063W	1	
	R8671	ERJ2GEJ222	M 2.2KOHM, J, 0.063W	1	
	R8672	EXB2HV680J	RESISTOR ARRAY	1	
	R8673	EXB2HV680J	RESISTOR ARRAY	1	
	R8674	EXB2HV103JV	RESISTOR ARRAY	1	
	R8675	ERJ2GEJ222	M 2.2KOHM, J, 0.063W	1	
	R8677	ERJ2GEJ103	M 10KOHM, J, 0.063W	1	
	R8678	ERJ2GEJ222	M 2.2KOHM, J, 0.063W	1	
	R8679	ERJ2GEJ222	M 2.2KOHM, J, 0.063W	1	
	R8680	ERJ2GEJ222	M 2.2KOHM, J, 0.063W	1	
	R8681	ERJ2GEJ222	M 2.2KOHM, J, 0.063W	1	
	R8683	ERJ2GEJ680	M 68 OHM, J, 0.063W	1	
	R8688	EXB2HV680J	RESISTOR ARRAY	1	
	R8689	EXB2HV680J	RESISTOR ARRAY	1	
	R8690	EXB2HV680J	RESISTOR ARRAY	1	
	R8691	ERJ2GEJ103	M 10KOHM, J, 0.063W	1	
	R8692	ERJ2GEJ680	M 68 OHM, J, 0.063W	1	
	R8697	ERJ2GEJ222	M 2.2KOHM, J, 0.063W	1	
	R8703	ERJ2GEJ680	M 68 OHM, J, 0.063W	1	

Safety	Ref. No.	Part No.	Part Name & Description	Pcs	Remarks
	R8715	ERJ2GEJ103	M 10KOHM, J, 0.063W	1	
	R8716	ERJ2GEJ103	M 10KOHM, J, 0.063W	1	
	R8718	ERJ2GEJ103	M 10KOHM, J, 0.063W	1	
	R8719	EXB28V103JX	RESISTOR ARRAY	1	
	R8722	EXB28V103JX	RESISTOR ARRAY	1	
	R8723	ERJ2GEJ103	M 10KOHM, J, 0.063W	1	
	R8746	ERJ2GEJ103	M 10KOHM, J, 0.063W	1	
	R8747	ERJ2GEJ103	M 10KOHM, J, 0.063W	1	
	R8750	ERJ2GEJ103	M 10KOHM, J, 0.063W	1	
	R8751	ERJ2GEJ103	M 10KOHM, J, 0.063W	1	
	R8765	ERJ2GEJ103	M 10KOHM, J, 0.063W	1	
	R8767	ERJ2GEJ103	M 10KOHM, J, 0.063W	1	
	R8768	ERJ2GEJ103	M 10KOHM, J, 0.063W	1	
	R8802	ERJ2GEJ680	M 68 OHM, J, 0.063W	1	
	R8803	ERJ2GEJ680	M 68 OHM, J, 0.063W	1	
	R8804	ERJ2GEJ680	M 68 OHM, J, 0.063W	1	
	R8805	ERJ2GEJ680	M 68 OHM, J, 0.063W	1	
	R8806	ERJ2GEJ680	M 68 OHM, J, 0.063W	1	
	R8807	ERJ2GEJ680	M 68 OHM, J, 0.063W	1	
	R8808	ERJ2GEJ680	M 68 OHM, J, 0.063W	1	
	R8855	ERJ2GEJ103	M 10KOHM, J, 0.063W	1	
	R8856	ERJ2GEJ680	M 68 OHM, J, 0.063W	1	
	R8857	ERJ2GEJ680	M 68 OHM, J, 0.063W	1	
	R8858	ERJ2GEJ680	M 68 OHM, J, 0.063W	1	
	R8859	ERJ2GEJ680	M 68 OHM, J, 0.063W	1	
	R8860	ERJ2GEJ680	M 68 OHM, J, 0.063W	1	
	R8862	ERJ2GEJ680	M 68 OHM, J, 0.063W	1	
	R8864	ERJ2GEJ680	M 68 OHM, J, 0.063W	1	
	R8898	ERJ2GEJ103	M 10KOHM, J, 0.063W	1	
	R8899	ERJ2GEJ680	M 68 OHM, J, 0.063W	1	
	R8954	ERJ2GEJ680	M 68 OHM, J, 0.063W	1	
	R8959	ERJ2GEJ680	M 68 OHM, J, 0.063W	1	
	R8960	ERJ2GEJ680	M 68 OHM, J, 0.063W	1	
	R8963	ERJ2GEJ103	M 10KOHM, J, 0.063W	1	
	R9062	ERJ2GEJ101	M 100 OHM, J, 0.063W	1	
	R9063	ERJ2GEJ101	M 100 OHM, J, 0.063W	1	
	R9064	ERJ2GEJ101	M 100 OHM, J, 0.063W	1	
	R9065	ERJ2GEJ101	M 100 OHM, J, 0.063W	1	
	R9066	ERJ2GEJ101	M 100 OHM, J, 0.063W	1	
	R9067	ERJ2GEJ101	M 100 OHM, J, 0.063W	1	
	R9068	ERJ2GEJ103	M 10KOHM, J, 0.063W	1	

Safety	Ref. No.	Part No.	Part Name & Description	Pcs	Remarks
	R9070	ERJ2GEJ103	M 10KOHM, J, 0.063W	1	
	R9071	ERJ2GEJ223	M 22KOHM, J, 0.063W	1	
	R9072	ERJ2GEJ102X	M 1K OHM J 1/4W	1	
	R9073	ERJ2GEJ472	M 4.7KOHM, J, 0.063W	1	
	R9077	D1BB1302A055	M 13KOHM, 1/10W	1	
	R9078	D1BB4302A055	M 43KOHM, 1/10W	1	
	R9079	D1BB2702A055	M 27KOHM, 1/10W	1	
	R9080	D1BB1502A055	M 15KOHM, 1/10W	1	
	R9081	D1BB4702A055	M 47KOHM, 1/10W	1	
	R9098	ERJ2GEJ472	M 4.7KOHM, J, 0.063W	1	
	R9099	ERJ2GEJ101	M 100 OHM, J, 0.063W	1	
	R9100	ERJ2GEJ473	M 47KOHM, J, 0.063W	1	
	R9101	ERJ2GEJ333	M 33KOHM, J, 0.063W	1	
	R9102	ERJ2GEJ101	M 100 OHM, J, 0.063W	1	
	R9104	ERJ2GEJ472	M 4.7KOHM, J, 0.063W	1	
	R9105	ERJ2GEJ103	M 10KOHM, J, 0.063W	1	
	R9106	ERJ2GEJ104	M 100KOHM, J, 0.063W	1	
	R9107	ERJ2GEJ332	M 3.3KOHM, J, 0.063W	1	
	R9108	ERJ2GEJ103	M 10KOHM, J, 0.063W	1	
	R9109	ERJ2GEJ103	M 10KOHM, J, 0.063W	1	
	R9110	ERJ2GEJ101	M 100 OHM, J, 0.063W	1	
	R9112	ERJ2GEJ103	M 10KOHM, J, 0.063W	1	
	R9113	ERJ2GEJ104	M 100KOHM, J, 0.063W	1	
	R9114	ERJ2GEJ472	M 4.7KOHM, J, 0.063W	1	
	R9115	ERJ2GEJ101	M 100 OHM, J, 0.063W	1	
	R9116	ERJ2GEJ101	M 100 OHM, J, 0.063W	1	
	R9117	ERJ2GEJ103	M 10KOHM, J, 0.063W	1	
	R9118	ERJ2GEJ103	M 10KOHM, J, 0.063W	1	
	R9119	EXB38V470J	RESISTOR ARRAY	1	
	R9120	ERJ2GEJ101	M 100 OHM, J, 0.063W	1	
	R9121	ERJ2GEJ104	M 100KOHM, J, 0.063W	1	
	R9122	ERJ2GEJ472	M 4.7KOHM, J, 0.063W	1	
	R9123	ERJ2GEJ472	M 4.7KOHM, J, 0.063W	1	
	R9124	ERJ2GEJ470	M 47 OHM, J, 0.063W	1	
	R9129	ERJ2GEJ683	M 68KOHM, J, 0.063W	1	
	R9130	ERJ2GEJ470	M 47 OHM, J, 0.063W	1	
	R9142	ERJ2GEJ101	M 100 OHM, J, 0.063W	1	
	R9145	ERJ2GEJ101	M 100 OHM, J, 0.063W	1	
	R9149	ERJ2GEJ472	M 4.7KOHM, J, 0.063W	1	
	R9154	ERJ2RHD272	M 2.7KOHM, J, 2W	1	
	R9155	ERJ2RHD272	M 2.7KOHM, J, 2W	1	
	R9164	ERJ2GEJ103	M 10KOHM, J, 0.063W	1	
	R9166	ERJ2GEJ103	M 10KOHM, J, 0.063W	1	
	R9187	ERJ2RHD272	M 2.7KOHM, J, 2W	1	
	R9188	ERJ2RHD272	M 2.7KOHM, J, 2W	1	

Safety	Ref. No.	Part No.	Part Name & Description	Pcs	Remarks
	R9189	ERJ2GEJ103	M 10KOHM, J, 0.063W	1	
	R9202	ERJ2GEJ101	M 100 OHM, J, 0.063W	1	
	R9203	ERJ2GEJ223	M 22KOHM, J, 0.063W	1	
	R9205	ERJ2GEJ333	M 33KOHM, J, 0.063W	1	
	R9206	ERJ2GED563X	M 56KOHM, J, 0.063W	1	
	R9207	ERJ2GEJ243	M 24KOHM, J, 0.063W	1	
	R9210	ERJ2GEJ473	M 47KOHM, J, 0.063W	1	
	R9211	ERJ2RHD272	M 2.7KOHM, J, 2W	1	
	R9214	ERJ2RHD272	M 2.7KOHM, J, 2W	1	
	R9215	ERJ2GEJ104	M 100KOHM, J, 0.063W	1	
	R9223	ERJ2RHD272	M 2.7KOHM, J, 2W	1	
	R9225	ERJ2RHD272	M 2.7KOHM, J, 2W	1	
	R9317	ERJ2GEJ102X	M 1K OHM J 1/4W	1	
	R9347	EXB2HV220JV	RESISTOR ARRAY	1	
	R9348	EXB2HV220JV	RESISTOR ARRAY	1	
	R9350	ERJ2GEJ470	M 47 OHM, J, 0.063W	1	
	R9351	ERJ2GEJ470	M 47 OHM, J, 0.063W	1	
	R9352	EXB2HV220JV	RESISTOR ARRAY	1	
	R9353	EXB2HV220JV	RESISTOR ARRAY	1	
	R9354	EXB2HV220JV	RESISTOR ARRAY	1	
	R9355	EXB2HV220JV	RESISTOR ARRAY	1	
	R9356	EXB2HV220JV	RESISTOR ARRAY	1	
	R9357	EXB2HV220JV	RESISTOR ARRAY	1	
	R9358	EXB2HV330JV	RESISTOR ARRAY	1	
	R9359	EXB2HV330JV	RESISTOR ARRAY	1	
	R9360	ERJ2GEJ332	M 3.3KOHM, J, 0.063W	1	
	R9361	ERJ2GEJ470	M 47 OHM, J, 0.063W	1	
	R9362	ERJ2GEJ470	M 47 OHM, J, 0.063W	1	
	R9363	ERJ2GEJ103	M 10KOHM, J, 0.063W	1	
	R9369	ERJ2GEJ472	M 4.7KOHM, J, 0.063W	1	
	R9370	ERJ2GEJ103	M 10KOHM, J, 0.063W	1	
	R9371	ERJ2GEJ104	M 100KOHM, J, 0.063W	1	
	R9385	ERJ2GEJ472	M 4.7KOHM, J, 0.063W	1	
	R9391	ERJ2GEJ104	M 100KOHM, J, 0.063W	1	
	R9396	ERJ2GEJ470	M 47 OHM, J, 0.063W	1	
	R9397	ERJ2GEJ470	M 47 OHM, J, 0.063W	1	
	R9398	ERJ2GEJ470	M 47 OHM, J, 0.063W	1	
	R9399	ERJ2GEJ470	M 47 OHM, J, 0.063W	1	
	R9401	ERJ2GEJ102X	M 1K OHM J 1/4W	1	
	R9402	ERJ2GEJ470	M 47 OHM, J, 0.063W	1	
	R9403	EXB2HV103JV	RESISTOR ARRAY	1	
	R9404	EXB2HV103JV	RESISTOR ARRAY	1	
	R9405	EXB2HV103JV	RESISTOR ARRAY	1	
	R9406	EXB2HV103JV	RESISTOR ARRAY	1	
	R9407	D0GDR00Z0002	M 0 OHM, 1/10W	1	
	R9408	D0GDR00Z0002	M 0 OHM, 1/10W	1	
	R9578	ERJ2GEJ472	M 4.7KOHM, J, 0.063W	1	
	R9586	ERJ2GEJ470	M 47 OHM, J, 0.063W	1	
	R9587	ERJ2GEJ470	M 47 OHM, J, 0.063W	1	
	R9592	D0GA103JA015	M 10KOHM, J, 1/16W	1	

Safety	Ref. No.	Part No.	Part Name & Description	Pcs	Remarks
	R9594	ERJ2GEJ103	M 10KOHM, J, 0.063W	1	
	R9598	ERJ2GEJ470	M 47 OHM, J, 0.063W	1	
	R9604	ERJ2GEJ103	M 10KOHM, J, 0.063W	1	
	R9608	EXB2HV470JV	RESISTOR ARRAY	1	
	R9609	EXB28V470JX	RESISTOR ARRAY	1	
	R9610	EXB2HV470JV	RESISTOR ARRAY	1	
	R9611	ERJ2GEJ680	M 68 OHM, J, 0.063W	1	
	R9616	ERJ2GEJ470	M 47 OHM, J, 0.063W	1	
	R9618	ERJ2GEJ331	M 330 OHM, J, 0.063W	1	
	R9839	EXB38V101JV	RESISTOR ARRAY	1	
	R9848	EXB2HV470JV	RESISTOR ARRAY	1	
	R9849	EXB2HV470JV	RESISTOR ARRAY	1	
	R9868	ERJ2GEJ104	M 100KOHM, J, 0.063W	1	
	R9871	ERJ2GEJ103	M 10KOHM, J, 0.063W	1	
	R9872	D1BB1002A055	M 10KOHM, 1/10W	1	
	R9873	ERJ14YJ120	M 12 OHM, J, 1/4W	1	
	R9893	D1BB2702A055	M 27KOHM, 1/10W	1	
	R9894	D1BB2002A055	M 20KOHM, 1/10W	1	
	R9895	D1BB11030002	M 110KOHM, 1/10W	1	
	R9896	D1BB4702A055	M 47KOHM, 1/10W	1	
	R9897	ERJ2GEJ103	M 10KOHM, J, 0.063W	1	
	R9898	ERJ2GEJ103	M 10KOHM, J, 0.063W	1	
	R9899	ERJ2GEJ103	M 10KOHM, J, 0.063W	1	
	R9900	ERJ14YJ120	M 12 OHM, J, 1/4W	1	
	R9902	D0GBR0020002	M 0 OHM J 1/16W	1	
	R9903	EXB2HV470JV	RESISTOR ARRAY	1	
	R9905	ERJ2RKD330	M 33 OHM, J, 2W	1	
	R9906	EXB38V470J	RESISTOR ARRAY	1	
	R9907	ERJ2GEJ151	M 150 OHM, J, 0.063W	1	
	R9936	D1BB1001A055	M 1KOHM, 1/16W	1	
	R9937	D1BB1001A055	M 1KOHM, 1/16W	1	
	R9938	D1BB1001A055	M 1KOHM, 1/16W	1	
	R9939	D1BB1001A055	M 1KOHM, 1/16W	1	
	R9940	ERJ2RKD330	M 33 OHM, J, 2W	1	
	R9943	EXB2HV470JV	RESISTOR ARRAY	1	
	R9944	EXB38V470J	RESISTOR ARRAY	1	
	R9945	EXB38V470J	RESISTOR ARRAY	1	
	R9946	EXB38V470J	RESISTOR ARRAY	1	
	R9947	EXB38V470J	RESISTOR ARRAY	1	
	R9948	EXB38V470J	RESISTOR ARRAY	1	
	R9949	EXB38V470J	RESISTOR ARRAY	1	
	R9950	EXB38V470J	RESISTOR ARRAY	1	
	R9951	EXB38V470J	RESISTOR ARRAY	1	
	R9952	ERJ2GEJ470	M 47 OHM, J, 0.063W	1	
	R9953	ERJ2GEJ470	M 47 OHM, J, 0.063W	1	
	R9954	ERJ2GEJ470	M 47 OHM, J, 0.063W	1	
	R9955	ERJ2GEJ470	M 47 OHM, J, 0.063W	1	
	R9966	ERJ2GEJ471	M 470 OHM, J, 0.063W	1	
	R9967	ERJ2GEJ470	M 47 OHM, J, 0.063W	1	
	R9968	ERJ2GEJ470	M 47 OHM, J, 0.063W	1	
	R9969	ERJ2GEJ470	M 47 OHM, J, 0.063W	1	
	R9970	ERJ2GEJ470	M 47 OHM, J, 0.063W	1	
	R9972	ERJ2GEJ103	M 10KOHM, J, 0.063W	1	
	R9975	ERJ2GEJ470	M 47 OHM, J, 0.063W	1	

Safety	Ref. No.	Part No.	Part Name & Description	Pcs	Remarks
	R9977	ERJ2GEJ470	M 47 OHM, J, 0.063W	1	
	R9983	ERJ2GEJ470	M 47 OHM, J, 0.063W	1	
	R9987	ERJ2GEJ470	M 47 OHM, J, 0.063W	1	
	R9988	ERJ2GEJ470	M 47 OHM, J, 0.063W	1	
	R9989	ERJ2GEJ470	M 47 OHM, J, 0.063W	1	
	R9990	ERJ2GEJ101	M 100 OHM, J, 0.063W	1	
	RM2501	B3RAD0000160	REMOTE SENSOR	1	
	S1B	K1KA03BA0237	3P CONNECTOR	1	
	△	SW2500	KOF162B00002	SWITCH	1
		SW3759	EVQ11G05R	SWITCH	1
		SW3760	EVQ11G05R	SWITCH	1
		SW3761	EVQ11G05R	SWITCH	1
		SW3762	EVQ11G05R	SWITCH	1
		SW3763	EVQ11G05R	SWITCH	1
	△	TU2901	ENG37E18KF	TUNER	1
	X1100	HOJ100500035	CRYSTAL	1	
	X2010	HOJ245500089	CRYSTAL	1	
	X8001	HOJ270500120	CRYSTAL	1	
	X8301	HOJ300500027	CRYSTAL	1	
	X9900	HOJ200500076	CRYSTAL	1	
	C10	K1MY55BA0345	55P CONNECTOR	1	
	C14	K1KA02A00787	2P CONNECTOR	1	
	C20	K1MY55BA0345	55P CONNECTOR	1	
	C21	K1MY68BA0345	68P CONNECTOR	1	
	C22	K1MY68BA0345	68P CONNECTOR	1	
	C23	K1KA06B00220	6P CONNECTOR	1	
	C25	K1KA04BA0107	4P CONNECTOR	1	
	C16002	F1L2J562A022	C 5600UF, K, 6.3V	1	
	C16012	F2A2T301A004	E 300UF, 220V	1	
	C16013	FOC2E225A230	E 0.022UF, 250V	1	
	C16022	F1L2J562A022	C 5600UF, K, 6.3V	1	
	C16103	F1H1E470A130	C 47UF, K, 25V	1	
	C16104	F1H1E470A130	C 47UF, K, 25V	1	
	C16131	F1L1E4750004	C 4.7UF, 25V	1	
	C16133	F1L1E4750004	C 4.7UF, 25V	1	
	C16135	F1K1E105A029	C 1UF, Z, 25V	1	
	C16191	F1L1E4750004	C 4.7UF, 25V	1	
	C16192	F1H1E104A129	C 0.1UF, 25V	1	
	C16193	EEUF1E470	E 47UF, 25V	1	
	C16195	F1L1E4750004	C 4.7UF, 25V	1	
	C16198	F1K2J102A014	C 1000UF, K, 6.3V	1	
	C16241	F2A1A101A106	E 100UF, 10V	1	
	C16242	F1H1C105A008	C 1UF, K, 16V	1	
	C16243	F1H1H103A970	C 0.001UF, K, 50V	1	
	C16272	F2A1E471A102	E 470UF, 25V	1	
	C16280	F1K1E105A029	C 1UF, Z, 25V	1	
	C16286	F1H1H104A970	C 0.1UF, K, 50V	1	
	C16287	F1H1H104A970	C 0.1UF, K, 50V	1	
	C16310	F2A2T301A004	E 300UF, 220V	1	
	C16315	F1H1A1050032	C 10UF, 50V	1	
	C16316	F1H1C104A143	C 0.1UF, K, 16V	1	
	C16317	F1H1A1050032	C 10UF, 50V	1	
	C16318	F1J1H104A835	C 0.10UF, 50V	1	
	C16319	F1J1H104A835	C 0.10UF, 50V	1	
	C16328	F2A2D201A226	E 220UF, 200V	1	
	C16401	F1L2J562A022	C 5600UF, K, 6.3V	1	
	C16412	FOC2E225A230	E 0.022UF, 250V	1	
	C16413	F2A2T301A004	E 300UF, 220V	1	
	C16414	F2A2T301A004	E 300UF, 220V	1	
	C16421	F1L2J562A022	C 5600UF, K, 6.3V	1	
	C16460	F1E2J152A002	C 1500PF, 600V	1	



Safety	Ref. No.	Part No.	Part Name & Description	Pcs	Remarks
	C16461	F1E2J182A002	C 1800PF, 600V	1	
	C16462	F1E2J332A002	C 3300PF, 600V	1	
	C16464	F1L2J1020001	C 1000UF, K, 6.3V	1	
	C16471	F1L2J1020001	C 1000UF, K, 6.3V	1	
	C16472	F1K1E105A029	C 1UF, Z, 25V	1	
	C16490	F1H1C105A008	C 1UF, K, 16V	1	
	C16491	F1L2J1020001	C 1000UF, K, 6.3V	1	
	C16501	F1K1E105A029	C 1UF, Z, 25V	1	
	C16502	F1L1E4750004	C 4.7UF, 25V	1	
	C16503	F2A1E471A102	E 470UF, 25V	1	
	C16504	F1L1E4750004	C 4.7UF, 25V	1	
	C16505	F1K1E105A029	C 1UF, Z, 25V	1	
	C16521	F1K1E105A029	C 1UF, Z, 25V	1	
	C16522	F1L1E4750004	C 4.7UF, 25V	1	
	C16523	F2A1E471A102	E 470UF, 25V	1	
	C16524	F1L1E4750004	C 4.7UF, 25V	1	
	C16525	F1L1E4750004	C 4.7UF, 25V	1	
	C16527	F1L1E4750004	C 4.7UF, 25V	1	
	C16533	F1H1H104A970	C 0.1UF, K, 50V	1	
	C16535	F1H1H104A970	C 0.1UF, K, 50V	1	
	C16536	F1H1H104A970	C 0.1UF, K, 50V	1	
	C16562	F1H1C105A008	C 1UF, K, 16V	1	
	C16563	F2A1A101A106	E 100UF, 10V	1	
	C16564	F1H1C105A008	C 1UF, K, 16V	1	
	C16565	F1H1H103A970	C 0.001UF, K, 50V	1	
	C16566	F1H1H103A970	C 0.001UF, K, 50V	1	
	C16581	F1K1E105A029	C 1UF, Z, 25V	1	
	C16582	F1L1E4750004	C 4.7UF, 25V	1	
	C16593	F1H1H102A971	C 1000PF, K, 50V	1	
	C16602	F1H1H220A971	C 22PF, K, 50V	1	
	C16603	F1K2J102A014	C 1000UF, K, 6.3V	1	
	C16604	F1K2J102A014	C 1000UF, K, 6.3V	1	
	C16608	F1H1H221A971	C 220UF, K, 50V	1	
	C16641	F1E2J332A002	C 3300PF, 600V	1	
	C16642	F1E2J332A002	C 3300PF, 600V	1	
	C16661	F1K2J102A014	C 1000UF, K, 6.3V	1	
	C16662	F1K2J102A014	C 1000UF, K, 6.3V	1	
	C16664	F1H1H680A971	C 68PF, K, 50V	1	
	C16665	F1H1H680A971	C 68PF, K, 50V	1	
	C16666	F1H1H680A971	C 68PF, K, 50V	1	
	C16667	F1H1H391A971	C 391UF, 50V	1	
	C16684	F1H1H104A970	C 0.1UF, K, 50V	1	
	C16685	F1H1H104A970	C 0.1UF, K, 50V	1	
	C16691	F2A2C101A169	E 1000UF, 160V	1	
	C16707	F1H1H220A971	C 22PF, K, 50V	1	
	C16708	F1H1H104A970	C 0.1UF, K, 50V	1	
	C16721	F2A1H101A128	E 100UF, 50V	1	
	C16723	F1L1E4750004	C 4.7UF, 25V	1	
	C16724	F1L1E4750004	C 4.7UF, 25V	1	
	C16725	F1L1E4750004	C 4.7UF, 25V	1	
	C16727	F1L2J1220001	C 1200UF, K, 6.3V	1	
	C16753	F1L1E4750004	C 4.7UF, 25V	1	
	C16754	F1L1E4750004	C 4.7UF, 25V	1	
	C16755	F1L1E4750004	C 4.7UF, 25V	1	
	C16756	F1L1E4750004	C 4.7UF, 25V	1	
	C16771	F1H1C105A008	C 1UF, K, 16V	1	
	C16772	F1L1E4750004	C 4.7UF, 25V	1	
	C16773	F1L1E4750004	C 4.7UF, 25V	1	
	C16791	EEUFC1E221	E 220UF, 25V	1	
	C16795	F2A1E471A102	E 470UF, 25V	1	
	C16796	F2A1E471A102	E 470UF, 25V	1	
	C16812	F1L1E4750004	C 4.7UF, 25V	1	
	C16813	F2A2T221A009	E 220UF, 220V	1	
	C16821	F1J1H104A835	C 0.10UF, 50V	1	
	C16822	F2A2G470A187	E 470UF, 400V	1	
	C16823	F1L2J562A022	C 5600UF, K, 6.3V	1	
	C16842	F2A2C101A169	E 1000UF, 160V	1	
	C16843	F1J1H104A835	C 0.10UF, 50V	1	
	C16844	F1J1H104A835	C 0.10UF, 50V	1	
	C16856	F1H1A1050032	C 10UF, 50V	1	
	C16857	F1H1H472A970	C 4700PF, K, 50V	1	
	C16858	F1H1C104A143	C 0.1UF, K, 16V	1	

Safety	Ref. No.	Part No.	Part Name & Description	Pcs	Remarks
	C16860	F1H1A1050032	C 10UF, 50V	1	
	C16861	F1H1C104A143	C 0.1UF, K, 16V	1	
	C16862	F1H1A1050032	C 10UF, 50V	1	
	C16863	F1J1H104A835	C 0.10UF, 50V	1	
	C16864	F1J1H104A835	C 0.10UF, 50V	1	
	C16866	F1H1A1050032	C 10UF, 50V	1	
	C16867	F1H1A1050032	C 10UF, 50V	1	
	C16868	F1H1A1050032	C 10UF, 50V	1	
	C16869	F1J1H104A835	C 0.10UF, 50V	1	
	C16891	F1K1E105A029	C 1UF, Z, 25V	1	
	C17121	F1H1A1050032	C 10UF, 50V	1	
	C17123	F1L2E154A028	E 1500UF, 25V	1	
	C17124	F1L2E154A028	E 1500UF, 25V	1	
	C17130	F1H1C104A143	C 0.1UF, K, 16V	1	
	C17131	F1H1A1050032	C 10UF, 50V	1	
	C17133	F1L2E154A028	E 1500UF, 25V	1	
	C17134	F1L2E154A028	E 1500UF, 25V	1	
	C17141	F1H1A1050032	C 10UF, 50V	1	
	C17143	F1L2E154A028	E 1500UF, 25V	1	
	C17144	F1L2E154A028	E 1500UF, 25V	1	
	C17148	F1H1C104A143	C 0.1UF, K, 16V	1	
	C17151	F1H1A1050032	C 10UF, 50V	1	
	C17153	F1L2E154A028	E 1500UF, 25V	1	
	C17154	F1L2E154A028	E 1500UF, 25V	1	
	C17161	F1H1C104A143	C 0.1UF, K, 16V	1	
	C17162	F1H1C104A143	C 0.1UF, K, 16V	1	
	C17211	F1H1A1050032	C 10UF, 50V	1	
	C17212	F1L2E154A028	E 1500UF, 25V	1	
	C17213	F1L2E154A028	E 1500UF, 25V	1	
	C17214	F1H1A1050032	C 10UF, 50V	1	
	C17215	F1L2E154A028	E 1500UF, 25V	1	
	C17221	F1H1A1050032	C 10UF, 50V	1	
	C17223	F1L2E154A028	E 1500UF, 25V	1	
	C17224	F1L2E154A028	E 1500UF, 25V	1	
	C17229	F1H1C104A143	C 0.1UF, K, 16V	1	
	C17230	F1K2A105A006	C 1UF, 100V	1	
	C17231	F1H1A1050032	C 10UF, 50V	1	
	C17233	F1L2E154A028	E 1500UF, 25V	1	
	C17234	F1L2E154A028	E 1500UF, 25V	1	
	C17241	F1L2E154A028	E 1500UF, 25V	1	
	C17244	F1H1C104A143	C 0.1UF, K, 16V	1	
	C17270	F1H1C104A143	C 0.1UF, K, 16V	1	
	C17271	F1H1C104A143	C 0.1UF, K, 16V	1	
	C17272	F1H1C104A143	C 0.1UF, K, 16V	1	
	C17273	F1H1C104A143	C 0.1UF, K, 16V	1	
	C17277	F1H1C104A143	C 0.1UF, K, 16V	1	
	C17278	F1H1C104A143	C 0.1UF, K, 16V	1	
	CB1	K1MY55B00001	55P CONNECTOR	1	
	CB2	K1MY55B00001	55P CONNECTOR	1	
	CB3	K1MY55B00001	55P CONNECTOR	1	
	CB4	K1MY55B00001	55P CONNECTOR	1	
	CB5	K1MY55B00001	55P CONNECTOR	1	
	CB6	K1MY55B00001	55P CONNECTOR	1	
	CB7	K1MY55B00001	55P CONNECTOR	1	
	CB8	K1MY55B00001	55P CONNECTOR	1	
	D16001	B0FBCN000005	DIODE	1	
	D16021	B0FBCN000008	DIODE	1	
	D16101	MA22D3900L	DIODE	1	
	D16131	B0ECKP000047	DIODE	1	
	D16191	B0ECKP000047	DIODE	1	
	D16192	MA2J11100L	DIODE	1	
	D16193	B0ECKP000047	DIODE	1	
	D16194	B0ECKP000047	DIODE	1	
	D16195	B0ECKP000047	DIODE	1	
	D16280	MA2J11100L	DIODE	1	
	D16281	MAZ80510LL	ZENER DIODE	1	
	D16282	MAZ80680ML	ZENER DIODE	1	
	D16285	MA3X152D0L	DIODE	1	
	D16315	MAZ81500ML	ZENER DIODE	1	
	D16316	B0ECKP000047	DIODE	1	
	D16317	B0ECKP000047	DIODE	1	

Safety	Ref. No.	Part No.	Part Name & Description	Pcs	Remarks
	D16401	B0FACQ000001	DIODE	1	
	D16407	MA22D3900L	DIODE	1	
	D16411	MA2J11100L	DIODE	1	
	D16421	MA3DF40000LW	ZENER DIODE	1	
	D16441	BOECHR000001	DIODE	1	
	D16451	BOECKP000047	DIODE	1	
	D16461	MA3DF46000LW	ZENER DIODE	1	
	D16473	MA3X152D0L	DIODE	1	
	D16474	MA2J11100L	DIODE	1	
	D16475	MAZ80510LL	ZENER DIODE	1	
	D16476	MA2J11100L	DIODE	1	
	D16478	BOHCKS000002	DIODE	1	
	D16480	MA2J11100L	DIODE	1	
	D16481	B0FACQ000002	DIODE	1	
	D16490	BOECKP000047	DIODE	1	
	D16491	MA2J11100L	DIODE	1	
	D16492	MAZ80470ML	ZENER DIODE	1	
	D16493	MA3X152E0L	ZENER DIODE	1	
	D16503	BOHCKS000002	DIODE	1	
	D16522	BOECKP000047	DIODE	1	
	D16524	BOECKP000047	DIODE	1	
	D16534	BOECKP000047	DIODE	1	
	D16536	BOHCKS000002	DIODE	1	
	D16583	B3ABB0000210	LED	1	
	D16602	MAZ81500ML	ZENER DIODE	1	
	D16604	MA3X152E0L	ZENER DIODE	1	
	D16605	MAZ80510LL	ZENER DIODE	1	
	D16606	BOECKM000038	DIODE	1	
	D16607	MA2J11100L	DIODE	1	
	D16608	MA8120M	ZENER DIODE	1	
	D16610	MA2J11100L	DIODE	1	
	D16615	MA2J11100L	DIODE	1	
	D16616	MA3X152E0L	ZENER DIODE	1	
	D16618	BOECKP000047	DIODE	1	
	D16619	BOECKP000047	DIODE	1	
	D16620	BOECKP000047	DIODE	1	
	D16621	MA3DF25000RP	ZENER DIODE	1	
	D16622	MA3DF25000RP	ZENER DIODE	1	
	D16624	BOECKP000047	DIODE	1	
	D16625	MAZ82000ML	ZENER DIODE	1	
	D16641	B0FBNC000006	DIODE	1	
	D16642	B0FBNC000006	DIODE	1	
	D16662	MAZ83300ML	ZENER DIODE	1	
	D16663	MAZ83300ML	ZENER DIODE	1	
	D16664	MAZ83300ML	ZENER DIODE	1	
	D16670	BOECHR000001	DIODE	1	
	D16671	MA2J11100L	DIODE	1	
	D16672	BOECHR000001	DIODE	1	
	D16678	MAZ81500ML	ZENER DIODE	1	
	D16679	BOECKP000047	DIODE	1	
	D16702	MA2J11100L	DIODE	1	
	D16710	MAZ815000L	ZENER DIODE	1	
	D16711	BOECHR000001	DIODE	1	
	D16712	MAZ815000L	ZENER DIODE	1	
	D16713	BOECHR000001	DIODE	1	
	D16714	MAZ815000L	ZENER DIODE	1	
	D16715	BOECHR000001	DIODE	1	
	D16717	MAZ83300ML	ZENER DIODE	1	
	D16719	BOECKP000047	DIODE	1	
	D16720	BOECKP000047	DIODE	1	
	D16721	BOHCKS000002	DIODE	1	
	D16722	MA3DF30000LW	ZENER DIODE	1	
	D16724	B0FBNC000008	DIODE	1	
	D16725	MA2J11100L	DIODE	1	
	D16765	BOHCKS000002	DIODE	1	
	D16791	MAZ82000ML	ZENER DIODE	1	
	D16816	MA8120M	ZENER DIODE	1	
	D16817	MA8120M	ZENER DIODE	1	
	D16820	MA3X152E0L	ZENER DIODE	1	
	D16821	MAZ83600ML	ZENER DIODE	1	
	D16824	MAZ83300ML	ZENER DIODE	1	
	D16825	MAZ83300ML	ZENER DIODE	1	
	D16859	BOHCKS000002	DIODE	1	

Safety	Ref. No.	Part No.	Part Name & Description	Pcs	Remarks
	D16860	BOHCKS000002	DIODE	1	
	D16865	BOECKP000047	DIODE	1	
	D16871	MAZ82000ML	ZENER DIODE	1	
	D16874	MAZ80510LL	ZENER DIODE	1	
	D16875	MA2J11100L	DIODE	1	
	D16901	MA3X152E0L	ZENER DIODE	1	
	D16920	MA3X152E0L	ZENER DIODE	1	
	IC16131	COZBZ0000895	IC	1	
	IC16241	COJBAZ002811	IC	1	
	IC16304	MIP3900MSSCF	IC	1	
	IC16312	C0DBZMC00006	IC	1	
	IC16464	COJBAB000715	IC	1	
	IC16465	COJBAB000715	IC	1	
	IC16471	C0DBEKA00003	IC	1	
	IC16490	C0DBZMC00006	IC	1	
	IC16491	NJM2406F	LINEAR IC *	1	
	IC16501	COZBZ0001324	IC	1	
	IC16521	COZBZ0001324	IC	1	
	IC16561	COJBAZ001120	IC	1	
	IC16562	COJBAZ001120	IC	1	
	IC16563	COJBAC000363	IC	1	
	IC16581	COBBBA000024	IC	1	
	IC16661	COBBBA000024	IC	1	
	IC16692	C0DBZMC00006	IC	1	
	IC16724	C0CBADC00072	IC	1	
	IC16725	C0CBADC00072	IC	1	
	IC16771	C0CBADC00072	IC	1	
	IC16773	COJBAB000715	IC	1	
	IC16784	MIP9L02MBS	IC	1	
	IC16786	MIP3900MSSCF	IC	1	
	IC16787	C0DBZMC00006	IC	1	
	IC16788	MIP3900MSSCF	IC	1	
	IC16789	C0DBZMC00006	IC	1	
	IC16791	EHMDD9920	LINEAR IC	1	
	IC17101	COJBAZ002914	IC	1	
	IC17102	COJBAZ002914	IC	1	
	IC17103	COJBAZ002914	IC	1	
	IC17104	COJBAZ002914	IC	1	
	IC17201	COJBAZ002914	IC	1	
	IC17202	COJBAZ002914	IC	1	
	IC17205	COJBAZ002914	IC	1	
	IC17206	COJBAZ002914	IC	1	
	IC17207	COJBAZ002914	IC	1	
	IC17208	COJBAZ002914	IC	1	
	IC17211	COJBAZ002914	IC	1	
	IC17212	COJBAZ002914	IC	1	
	L16011	G0C2R5KA0147	PEAKING COIL	1	
	L16012	G0C2R5KA0147	PEAKING COIL	1	
	L16013	G0C2R5KA0147	PEAKING COIL	1	
	L16014	G0C2R5KA0147	PEAKING COIL	1	
	L16103	G0ZZ00002183	PEAKING COIL	1	
	L16222	G0ZZ00002183	PEAKING COIL	1	
	L16271	G0ZZ00002183	PEAKING COIL	1	
	L16303	G0C471KA0167	PEAKING COIL	1	
	L16401	G0C2R5KA0147	PEAKING COIL	1	
	L16402	G0C2R5KA0147	PEAKING COIL	1	
	L16403	G0C2R5KA0147	PEAKING COIL	1	
	L16404	G0C2R5KA0147	PEAKING COIL	1	
	L16411	G0C2R5KA0147	PEAKING COIL	1	
	L16412	G0C2R5KA0147	PEAKING COIL	1	
	L16413	G0C2R5KA0147	PEAKING COIL	1	
	L16414	G0C2R5KA0147	PEAKING COIL	1	
	L16472	G0ZZ00002183	PEAKING COIL	1	
	L16697	G0C102KA0187	PEAKING COIL	1	
	L16698	G0C681MA0065	PEAKING COIL	1	
	L16699	G0C471KA0167	PEAKING COIL	1	
	L16851	G0ZZ00002183	PEAKING COIL	1	
	PC16191	B3PBA0000496	IC	1	
	PC16192	B3PBA0000223	IC	1	
	PC16461	B3PBA0000457	IC	1	

Safety	Ref. No.	Part No.	Part Name & Description	Pcs	Remarks
	PC16480	B3PBA0000223	IC	1	
	PC16601	B3PBA0000223	IC	1	
	PC16603	B3PBA0000223	IC	1	
	PC16684	B3PBA0000496	IC	1	
	PC16685	B3PBA0000496	IC	1	
	PC16722	B3PBA0000223	IC	1	
	PC16723	B3PBA0000223	IC	1	
	PC16896	B3PBA0000223	IC	1	
△	PCB	LSEP1279BEHB	CIRCUIT BOARD P	1	(RTL)
△	PCB	TNPA4892	CIRCUIT BOARD C1	1	(RTL)
△	PCB	TNPA4893	CIRCUIT BOARD C2	1	(RTL)
△	PCB	TXNSC11UBG	CIRCUIT BOARD SC	1	(RTL) PAVCCZ
△	PCB	TXNSD11UBG	CIRCUIT BOARD SD	1	PAVCCZ
△	PCB	TXNSS11UBU	CIRCUIT BOARD SS	1	(RTL) PAVCCZ
△	PCB	TNPA4807	CIRCUIT BOARD SS2	1	(RTL)
△	PCB	TXNSU11UBG	CIRCUIT BOARD SU	1	PAVCCZ
	Q16001	B1JAEN000005	TRANSISTOR	1	
	Q16002	B1JAEN000005	TRANSISTOR	1	
	Q16021	B1JAEN000004	TRANSISTOR	1	
	Q16022	B1JAEN000004	TRANSISTOR	1	
	Q16101	2SK417300L	FET	1	
	Q16102	2SK399500L	FET	1	
	Q16141	B1HFPPA00001	TRANSISTOR	1	
	Q16161	B1HFPPA00001	TRANSISTOR	1	
	Q16191	B1HFPPA00001	TRANSISTOR	1	
	Q16280	2SD0601ARL	TRANSISTOR	1	
	Q16401	2PG0090000RP	TRANSISTOR	1	
	Q16402	2PG0090000RP	TRANSISTOR	1	
	Q16421	B1JAEP000004	TRANSISTOR	1	
	Q16422	B1JAEP000004	TRANSISTOR	1	
	Q16441	B1JAEP000006	TRANSISTOR	1	
	Q16451	B1JADP000003	TRANSISTOR	1	
	Q16471	B1ABCF000231	TRANSISTOR	1	
	Q16490	B1CBGD000001	FET	1	
	Q16501	B1HFPPA00001	TRANSISTOR	1	
	Q16521	B1HFPPA00001	TRANSISTOR	1	
	Q16531	B1HFPPA00001	TRANSISTOR	1	
	Q16551	B1HFPPA00001	TRANSISTOR	1	
	Q16581	B1ABCF000231	TRANSISTOR	1	
	Q16601	B1CERR000025	FET	1	
	Q16602	2SD0601AQL	TRANSISTOR	1	
	Q16603	2SB0709ASL	TRANSISTOR	1	
	Q16604	B1CHPM000001	FET	1	
	Q16606	2SD0601AQL	TRANSISTOR	1	
	Q16607	B1CBGD000001	FET	1	
	Q16621	B1JADN000004	TRANSISTOR	1	
	Q16622	B1JADN000004	TRANSISTOR	1	
	Q16624	2SB0709ASL	TRANSISTOR	1	
	Q16661	B1JAER000003	TRANSISTOR	1	
	Q16662	2SD0601AQL	TRANSISTOR	1	
	Q16663	2SB0709ASL	TRANSISTOR	1	
	Q16667	2SB0709ARL	TRANSISTOR	1	
	Q16670	B1ADCN000007	TRANSISTOR	1	
	Q16671	B1ABCF000231	TRANSISTOR	1	
	Q16672	B1CBGD000001	FET	1	
	Q16673	B1CBGD000001	FET	1	
	Q16674	B1CBGD000001	FET	1	
	Q16675	B1ADCN000007	TRANSISTOR	1	
	Q16676	B1ABCF000231	TRANSISTOR	1	
	Q16701	B1ADCN000007	TRANSISTOR	1	
	Q16702	B1ABCF000231	TRANSISTOR	1	
	Q16762	B1HFPPA00001	TRANSISTOR	1	
	Q16815	B1ABCN000007	TRANSISTOR	1	
	Q16816	2SD0601AQL	TRANSISTOR	1	
	Q16817	B1CBGD000001	FET	1	
	Q16818	B1CBGD000001	FET	1	
	Q16874	B1CBGD000001	FET	1	
	Q16875	B1ABCF000231	TRANSISTOR	1	

Safety	Ref. No.	Part No.	Part Name & Description	Pcs	Remarks
	Q16876	B1ABCF000231	TRANSISTOR	1	
	Q16882	B1ABCF000231	TRANSISTOR	1	
	Q16884	2SD0601ARL	TRANSISTOR	1	
	Q16920	B1ABCN000007	TRANSISTOR	1	
	R16001	D0GF7R5JA047	M 7.5 OHM, J, 0.33W	1	
	R16002	D0GF7R5JA047	M 7.5 OHM, J, 0.33W	1	
	R16021	D0GF7R5JA047	M 7.5 OHM, J, 0.33W	1	
	R16022	D0GF7R5JA047	M 7.5 OHM, J, 0.33W	1	
	R16101	D0GD221JA059	M 220 OHM, J, 1/10W	1	
	R16102	D0GD221JA059	M 220 OHM, J, 1/10W	1	
	R16103	D0GD100JA059	M 10 OHM, J, 0.25W	1	
	R16104	D0GD100JA059	M 10 OHM, J, 0.25W	1	
	R16105	ERJ8GEYJ474	M 470KOHM, J, 1/8W	1	
	R16109	D0GD100JA059	M 10 OHM, J, 0.25W	1	
	R16110	ERJ6GEYF473	M 47KOHM, J, 1/10W	1	
	R16116	ERJ6GEYF473	M 47KOHM, J, 1/10W	1	
	R16131	D0GD101JA036	M 100 OHM, J, 0.25W	1	
	R16132	D0GD101JA036	M 100 OHM, J, 0.25W	1	
	R16134	D0GD750JA059	M 75 OHM, J, 0.25W	1	
	R16137	D0GF1R0JA047	M 1.0 OHM, J, 0.33W	1	
	R16141	D0GD100JA059	M 10 OHM, J, 0.25W	1	
	R16142	ERJ6GEYF473	M 47KOHM, J, 1/10W	1	
	R16143	ERJ6GEYF473	M 47KOHM, J, 1/10W	1	
	R16161	D0GD100JA059	M 10 OHM, J, 0.25W	1	
	R16162	ERJ6GEYF473	M 47KOHM, J, 1/10W	1	
	R16163	ERJ6GEYF473	M 47KOHM, J, 1/10W	1	
	R16191	ERJ6GEYJ151V	M 150 OHM, J, 1/10W	1	
	R16192	ERJ6GEYJ103V	M 10K OHM J 1/10W	1	
	R16193	ERJ6GEYJ750	M 75 OHM, J, 1/10W	1	
	R16194	D0GF7R5JA047	M 7.5 OHM, J, 0.33W	1	
	R16195	D0GF1R0JA047	M 1.0 OHM, J, 0.33W	1	
	R16196	D0GF7R5JA047	M 7.5 OHM, J, 0.33W	1	
	R16241	EXB38V470J	RESISTOR ARRAY	1	
	R16242	EXB38V472JV	RESISTOR ARRAY	1	
	R16280	ERJ6GEYJ222V	M 2.2K OHM J 1/10W	1	
	R16281	D0GD103JA036	M 10KOHM, J, 0.25W	1	
	R16282	ERJ6GEYJ221V	M 220 OHM, J, 1/10W	1	
	R16283	ERJ6GEYF473	M 47KOHM, J, 1/10W	1	
	R16284	ERJ6GEYJ224	M 220KOHM, J, 1/10W	1	
	R16285	EXB38V623J	RESISTOR ARRAY	1	
	R16289	D0GF334JA047	M 330KOHM, F, 0.33W	1	
	R16290	D0GF334JA047	M 330KOHM, F, 0.33W	1	
	R16302	ERJ8GEYJ333	M 33KOHM, J, 1/8W	1	
	R16307	ERJ6RBD513	M 5.1KOHM, J, 1/10W	1	
	R16309	ERJ8GEYJ333	M 33KOHM, J, 1/8W	1	
	R16310	ERJ8GEYJ333	M 33KOHM, J, 1/8W	1	
	R16311	ERJ8GEYJ333	M 33KOHM, J, 1/8W	1	
	R16317	ERJ6RBD243	M 2.4KOHM, J, 1/10W	1	
	R16318	ERJ6RBD433	M 4.3KOHM, J, 1/10W	1	
	R16319	ERJ6RBD242	M 2.4KOHM, J, 1/10W	1	
	R16320	ERJ14YJ683	M 68KOHM, 1/2W	1	
	R16330	ERJ6GEYJ102V	M 1K OHM J 1/10W	1	

Safety	Ref. No.	Part No.	Part Name & Description	Pcs	Remarks
	R16332	ERJ6GEYJ474	M 47KOHM,J,1/10W	1	
	R16334	ERJ6GEYJ472V	M 4.7K OHM J 1/10W	1	
	R16335	ERJ6GEYJ102V	M 1K OHM J 1/10W	1	
	R16401	ERJT08J7R5V	M 7.5OHM,J,0.33W	1	
	R16402	ERJT08J7R5V	M 7.5OHM,J,0.33W	1	
	R16410	ERJ6GEYG391	M 390 OHM,F,1/10W	1	
	R16411	D1BD2700A044	M 270 OHM, 1/10W	1	
	R16414	ERJ6GEYJ331V	M 330 OHM J 1/10W	1	
	R16415	ERJ6GEYJ331V	M 330 OHM J 1/10W	1	
	R16416	DOGD103JA036	M 10KOHM,J,0.25W	1	
	R16421	ERJT08J7R5V	M 7.5OHM,J,0.33W	1	
	R16422	ERJT08J7R5V	M 7.5OHM,J,0.33W	1	
	R16441	ERJT08J5R6V	M 5.6 OHM,F,0.33W	1	
	R16451	ERJT08J5R6V	M 5.6 OHM,F,0.33W	1	
	R16471	ERJ6GEYG392	M 3.9KOHM,J,1/10W	1	
	R16472	ERJ6GEYJ222V	M 2.2K OHM J 1/10W	1	
	R16473	ERJ6GEYF561	M 560 OHM,F,1/10W	1	
	R16474	ERJ6GEYJ102V	M 1K OHM J 1/10W	1	
	R16475	ERJ6GEYJ472V	M 4.7K OHM J 1/10W	1	
	R16476	ERJ6GEYJ472V	M 4.7K OHM J 1/10W	1	
	R16478	ERJ6GEYJ562V	M 5.6KOHM,J,1/10W	1	
	R16479	DOGD103JA036	M 10KOHM,J,0.25W	1	
	R16480	ERJ6GEYJ472V	M 4.7K OHM J 1/10W	1	
	R16490	ERJ6RBD104	M 100KOHM, 1/10W	1	
	R16491	ERJ6RED114	M 110KOHM, 1/10W	1	
	R16492	ERJ6RED124	M 120KOHM, 1/10W	1	
	R16493	ERJ6RBD4221	M 4.22KOHM, 1/10W	1	
	R16494	D1BD2001A044	M 2KOHM, 1/10W	1	
	R16495	D1BD3900A044	M 390 OHM, 1/10W	1	
	R16496	ERJ6GEYJ470V	M 47 OHM,J,1/10W	1	
	R16497	ERJ6GEYF473	M 47KOHM,J,1/10W	1	
	R16498	ERJ6GEYJ103V	M 10K OHM J 1/10W	1	
	R16501	DOGD101JA036	M 100 OHM,J,0.25W	1	
	R16502	DOGD101JA036	M 100 OHM,J,0.25W	1	
	R16503	ERJT06J100V	M 10 OHM,F,0.25W	1	
	R16504	ERJT06J750V	M 75 OHM,F,0.25W	1	
	R16506	ERJT06J100V	M 10 OHM,F,0.25W	1	
	R16510	ERJT14J1R0U	M 1.0 OHM, J,1/4W	1	
	R16511	ERJ6GEYF473	M 47KOHM,J,1/10W	1	
	R16512	ERJ6GEYF473	M 47KOHM,J,1/10W	1	
	R16516	ERJ6GEYF473	M 47KOHM,J,1/10W	1	
	R16517	ERJ6GEYF473	M 47KOHM,J,1/10W	1	
	R16521	DOGD101JA036	M 100 OHM,J,0.25W	1	
	R16522	DOGD101JA036	M 100 OHM,J,0.25W	1	
	R16523	ERJT06J750V	M 75 OHM,F,0.25W	1	
	R16524	ERJT06J750V	M 75 OHM,F,0.25W	1	
	R16531	ERJT06J100V	M 10 OHM,F,0.25W	1	
	R16532	ERJ6GEYF473	M 47KOHM,J,1/10W	1	
	R16533	ERJ6GEYF473	M 47KOHM,J,1/10W	1	
	R16534	ERJT08J1R0V	M 1.8OHM,J,0.33W	1	
	R16536	ERJT08J1R0V	M 1.8OHM,J,0.33W	1	
	R16551	ERJT06J100V	M 10 OHM,F,0.25W	1	

Safety	Ref. No.	Part No.	Part Name & Description	Pcs	Remarks
	R16552	ERJ6GEYF473	M 47KOHM,J,1/10W	1	
	R16553	ERJ6GEYF473	M 47KOHM,J,1/10W	1	
	R16561	EXB38V470J	RESISTOR ARRAY	1	
	R16562	EXB38V470J	RESISTOR ARRAY	1	
	R16563	EXB38V470J	RESISTOR ARRAY	1	
	R16564	EXB38V470J	RESISTOR ARRAY	1	
	R16565	EXB38V472JV	RESISTOR ARRAY	1	
	R16566	EXB38V472JV	RESISTOR ARRAY	1	
	R16567	EXB38V472JV	RESISTOR ARRAY	1	
	R16568	EXB38V472JV	RESISTOR ARRAY	1	
	R16570	ERJ6GEYJ472V	M 4.7K OHM J 1/10W	1	
	R16579	ERJ6GEYJ470V	M 47 OHM,J,1/10W	1	
	R16580	ERJ6GEYJ222V	M 2.2K OHM J 1/10W	1	
	R16582	ERJT08J393	M 39 KOHM,J,0.33W	1	
	R16583	ERJT08J393	M 39 KOHM,J,0.33W	1	
	R16584	D1BD6811A044	M6.81KOHM, 1/10W	1	
	R16585	D1BD1001A044	M 1KOHM, 1/10W	1	
	R16586	D1BD1691A044	M1.69KOHM, 1/10W	1	
	R16587	ERJ6GEYJ222V	M 2.2K OHM J 1/10W	1	
	R16588	DOGD103JA036	M 10KOHM,J,0.25W	1	
	R16589	DOGD103JA036	M 10KOHM,J,0.25W	1	
	R16590	ERJ6GEYJ221V	M 220 OHM,J,1/10W	1	
	R16591	EXB38V472JV	RESISTOR ARRAY	1	
	R16592	ERJ6GEYJ472V	M 4.7K OHM J 1/10W	1	
	R16593	D1BD1331A044	M 1.33K OHM 1/10W	1	
	R16602	ERJ6GEYJ102V	M 1K OHM J 1/10W	1	
	R16604	ERJ6GEYJ331V	M 330 OHM J 1/10W	1	
	R16605	ERJ6GEYG182	M 1.8KOHM,J,1/10W	1	
	R16606	DOGD103JA036	M 10KOHM,J,0.25W	1	
	R16607	D1BD6651A044	M6.65KOHM, 1/10W	1	
	R16608	ERJT08J102V	M 1KOHM,J, 0.33W	1	
	R16609	ERJT08J102V	M 1KOHM,J, 0.33W	1	
	R16610	ERJ6GEYJ104V	M 100KOHM,J,1/10W	1	
	R16611	ERJ8GEYJ683	M 68KOHM, J,1/8W	1	
	R16612	ERJT06J470V	M 47 OHM,F,0.25W	1	
	R16613	ERJ8GEYJ473	M 47KOHM, J,1/8W	1	
	R16614	ERJ8GEYJ683	M 68KOHM, J,1/8W	1	
	R16615	D1BD1131A044	M1.13KOHM, 1/10W	1	
	R16617	ERJ6GEYJ222V	M 2.2K OHM J 1/10W	1	
	R16619	ERJT08J1R0V	M 1.8OHM,J,0.33W	1	
	R16621	ERJT06J221V	M 220 OHM,F,0.25W	1	
	R16622	ERJT06J221V	M 220 OHM,F,0.25W	1	
	R16627	ERJ6GEYJ220	M 22 OHM,J,1/10W	1	
	R16628	ERJ6GEYF473	M 47KOHM,J,1/10W	1	
	R16631	DOGD103JA036	M 10KOHM,J,0.25W	1	
	R16633	ERJ6GEYJ223	M 22KOHM,J,1/10W	1	
	R16634	ERJ6GEYJ471	M 470 OHM,J,1/10W	1	
	R16658	D1BD8661A044	M86.6KOHM, 1/10W	1	
	R16661	ERJ6GEYJ122V	M 1.2KOHM,J,1/10W	1	
	R16663	D1BD5231A044	M5.23KOHM, 1/10W	1	
	R16664	ERJT08J102V	M 1KOHM,J, 0.33W	1	
	R16665	ERJT06J330V	M 33 OHM,F,0.25W	1	
	R16666	DOGD103JA036	M 10KOHM,J,0.25W	1	
	R16673	ERJ6GEYJ472V	M 4.7K OHM J 1/10W	1	
	R16674	ERJT08J102V	M 1KOHM,J, 0.33W	1	
	R16675	ERJ6GEYJ472V	M 4.7K OHM J 1/10W	1	
	R16679	D1BD1002A044	M10.0KOHM, 1/10W	1	
	R16680	D1BD7501A044	M 7.5KOHM, 1/10W	1	



Safety	Ref. No.	Part No.	Part Name & Description	Pcs	Remarks
	R16681	ERJT06J100V	M 10 OHM,F,0.25W	1	
	R16682	ERJT06J100V	M 10 OHM,F,0.25W	1	
	R16684	ERJ6GEYJ221V	M 220 OHM,J,1/10W	1	
	R16685	ERJ6GEYJ221V	M 220 OHM,J,1/10W	1	
	R16686	D0GD103JA036	M 10KOHM,J,0.25W	1	
	R16691	ERJ8GEYJ563	M 56KOHM, J,1/8W	1	
	R16692	ERJ6RBD152	M 1.5KOHM,J,1/10W	1	
	R16694	ERJ8GEYJ563	M 56KOHM, J,1/8W	1	
	R16695	ERJ6RBD152	M 1.5KOHM,J,1/10W	1	
	R16696	ERF5TK2R2	W 2.2 OHM, K, 5W	1	
	R16699	D0GD103JA036	M 10KOHM,J,0.25W	1	
	R16707	ERJ6GEYJ392	M 3.9KOHM,J,1/10W	1	
	R16711	ERJ6GEYJ472V	M 4.7K OHM J 1/10W	1	
	R16712	ERJ6GEYJ102V	M 1K OHM J 1/10W	1	
	R16713	ERG1FJS104D	M 100KOHM, J, 1W	1	
	R16714	ERJ6GEYF473	M 47KOHM,J,1/10W	1	
	R16715	ERJ6GEYJ103V	M 10K OHM J 1/10W	1	
	R16717	ERJ6GEYJ102V	M 1K OHM J 1/10W	1	
	R16720	ERJ3GEYJ220	M 22 OHM,J,1/16W	1	
	R16721	ERJ3GEYJ220	M 22 OHM,J,1/16W	1	
	R16722	ERJ3GEYJ220	M 22 OHM,J,1/16W	1	
	R16723	ERJ3GEYJ220	M 22 OHM,J,1/16W	1	
	R16731	ERG2FJS104D	M 100KOHM, J, 2W	1	
	R16733	ERJ6GEYJ474	M 470KOHM,J,1/10W	1	
	R16734	D1BD4991A044	M4.99KOHM, 1/10W	1	
	R16735	D1BD1873A044	M 187KOHM, 1/10W	1	
	R16736	D1BD1873A044	M 187KOHM, 1/10W	1	
	R16737	D1BD2053A044	M 205KOHM, 1/10W	1	
	R16744	D1BD1273A044	M 127KOHM, 1/10W	1	
	R16749	D0GD103JA036	M 10KOHM,J,0.25W	1	
	R16750	ERJT06J123	M 12KOHM,F,0.25W	1	
	R16751	ERJT06J154V	M 150KOHM,F,0.25W	1	
	R16752	ERJ6GEYJ472V	M 4.7K OHM J 1/10W	1	
	R16753	ERJ6GEYJ224	M 220KOHM,J,1/10W	1	
	R16755	ERJT06J123	M 12KOHM,F,0.25W	1	
	R16756	ERJT06J123	M 12KOHM,F,0.25W	1	
	R16761	ERJT06J100V	M 10 OHM,F,0.25W	1	
	R16762	ERJ6GEYF473	M 47KOHM,J,1/10W	1	
	R16763	ERJ6GEYF473	M 47KOHM,J,1/10W	1	
	R16765	ERJT08J1R0V	M 1.8OHM,J,0.33W	1	
	R16766	D0GDR00Z0002	M 0 OHM, 1/10W	1	
	R16769	ERJT06J750V	M 75 OHM,F,0.25W	1	
	R16772	ERJ6GEYJ472V	M 4.7K OHM J 1/10W	1	
	R16773	ERJ6GEYJ102V	M 1K OHM J 1/10W	1	
	R16774	ERG1SJ273	M 27KOHM, J, 1W	1	
	R16775	ERJ6GEYJ472V	M 4.7K OHM J 1/10W	1	
	R16776	ERJ6GEYJ470V	M 47 OHM,J,1/10W	1	
	R16777	ERJ6GEYJ103V	M 10K OHM J 1/10W	1	
	R16783	ERJT06J154V	M 150KOHM,F,0.25W	1	
	R16785	D1BD1003A044	M 100KOHM, 1/10W	1	
	R16786	D1BD1003A044	M 100KOHM, 1/10W	1	
	R16787	D1BD3302A044	M 33KOHM, 1/10W	1	
	R16789	D0GD103JA036	M 10KOHM,J,0.25W	1	
	R16791	ERJ6GEYJ102V	M 1K OHM J 1/10W	1	
	R16794	D1BD2003A044	M 200KOHM, 1/10W	1	
	R16795	D1BD2003A044	M 200KOHM, 1/10W	1	
	R16796	D1BD5602A044	M 56KOHM, 1/10W	1	
	R16806	ERJ6GEYJ102V	M 1K OHM J 1/10W	1	
	R16811	ERJ6RBD152	M 1.5KOHM,J,1/10W	1	

Safety	Ref. No.	Part No.	Part Name & Description	Pcs	Remarks
	R16822	ERJ6ENF8202	M 82KOHM, 1/10W	1	
	R16823	ERJ6ENF8202	M 82KOHM, 1/10W	1	
	R16824	D1BD3302A044	M 33KOHM, 1/10W	1	
	R16825	ERJT06J154V	M 150KOHM,F,0.25W	1	
	R16826	D0GD103JA036	M 10KOHM,J,0.25W	1	
	R16829	ERJ6GEYJ102V	M 1K OHM J 1/10W	1	
	R16831	D1BD7152A044	M71.5KOHM, 1/10W	1	
	R16832	D1BD7152A044	M71.5KOHM, 1/10W	1	
	R16833	D0GD103JA036	M 10KOHM,J,0.25W	1	
	R16838	ERJ14YJ563U	M 56KOHM, 1/2W	1	
	R16841	ERJ14YJ563U	M 56KOHM, 1/2W	1	
	R16844	D1BD1241A044	M1.24KOHM, 1/10W	1	
	R16845	D1BD7152A044	M71.5KOHM, 1/10W	1	
	R16846	ERJ6ENF8202	M 82KOHM, 1/10W	1	
	R16847	ERJ6GEYJ472V	M 4.7K OHM J 1/10W	1	
	R16848	ERJ6GEYJ472V	M 4.7K OHM J 1/10W	1	
	R16851	ERJ6GEYJ474	M 470KOHM,J,1/10W	1	
	R16860	D0D28R2JA021	M 8.2 OHM,J,2W	1	
	R16869	ERJ8GEYJ473	M 47KOHM, J,1/8W	1	
	R16870	ERJ14YJ683	M 68KOHM, 1/2W	1	
	R16873	D1BD2491A044	M2.49KOHM, 1/10W	1	
	R16877	ERJ6GEYJ681	M 680 OHM,J,1/10W	1	
	R16886	ERJ6GEYJ224	M 220KOHM,J,1/10W	1	
	R16887	ERJ6GEYJ224	M 220KOHM,J,1/10W	1	
	R16888	ERJ6GEYJ224	M 220KOHM,J,1/10W	1	
	R16891	D1BD4702A044	M 47KOHM, 1/10W	1	
	R16892	D1BD4702A044	M 47KOHM, 1/10W	1	
	R16893	D1BD4702A044	M 47KOHM, 1/10W	1	
	R16894	D1BD4702A044	M 47KOHM, 1/10W	1	
	R16895	D1BD4702A044	M 47KOHM, 1/10W	1	
	R16896	D1BD3302A044	M 33KOHM, 1/10W	1	
	R16897	D1BD2741A044	M2.74KOHM, 1/10W	1	
	R16899	D1BD1471A044	M1.47KOHM, 1/10W	1	
	R16904	ERJ6GEYJ223	M 22KOHM,J,1/10W	1	
	R16920	D0GD103JA036	M 10KOHM,J,0.25W	1	
	R16921	D1BD1741A044	M1.74KOHM, 1/10W	1	
	R16922	D1BD3001A044	M 3KOHM, 1/10W	1	
	R16923	D0GD103JA036	M 10KOHM,J,0.25W	1	
	R16926	ERJ6GEYJ222V	M 2.2K OHM J 1/10W	1	
	R16927	ERJ6GEYJ223	M 22KOHM,J,1/10W	1	
	R17101	EXB38V470J	RESISTOR ARRAY	1	
	R17102	ERJ3GEYJ470	M 47 OHM,J,1/16W	1	
	R17103	EXB38V471J	RESISTOR ARRAY	1	
	R17104	ERJ3GEYJ471	M 470 OHM,J,1/16W	1	
	R17105	ERJ3GEYJ470	M 47 OHM,J,1/16W	1	
	R17106	ERJ3GEYJ471	M 470 OHM,J,1/16W	1	
	R17107	EXB38V470J	RESISTOR ARRAY	1	
	R17108	ERJ3GEYJ470	M 47 OHM,J,1/16W	1	
	R17109	EXB38V471J	RESISTOR ARRAY	1	
	R17110	ERJ3GEYJ471	M 470 OHM,J,1/16W	1	
	R17111	ERJ3GEYJ470	M 47 OHM,J,1/16W	1	
	R17112	ERJ3GEYJ471	M 470 OHM,J,1/16W	1	
	R17115	ERJ3GEY0R00	M 0 OHM, 1/16W	1	
	R17119	EXB38V470J	RESISTOR ARRAY	1	
	R17125	ERJ3GEY0R00	M 0 OHM, 1/16W	1	
	R17126	D0GZ6R8JA020	M 6.8 OHM,J,0.5W	1	
	R17127	D0GZ6R8JA020	M 6.8 OHM,J,0.5W	1	
	R17135	ERJ3GEY0R00	M 0 OHM, 1/16W	1	
	R17136	D0GZ6R8JA020	M 6.8 OHM,J,0.5W	1	

Safety	Ref. No.	Part No.	Part Name & Description	Pcs	Remarks
	R17137	D0GZ6R8JA020	M 6.8 OHM,J, 0.5W	1	
	R17145	ERJ3GEY0R00	M 0 OHM, 1/16W	1	
	R17146	D0GZ6R8JA020	M 6.8 OHM,J, 0.5W	1	
	R17147	D0GZ6R8JA020	M 6.8 OHM,J, 0.5W	1	
	R17155	EXB38V102J	RESISTOR ARRAY	1	
	R17156	D0GZ6R8JA020	M 6.8 OHM,J, 0.5W	1	
	R17157	D0GZ6R8JA020	M 6.8 OHM,J, 0.5W	1	
	R17159	EXB38V470J	RESISTOR ARRAY	1	
	R17161	D0GDR00Z0002	M 0 OHM, 1/10W	1	
	R17177	EXB38V102J	RESISTOR ARRAY	1	
	R17180	ERJ3GEYJ470	M 47 OHM,J,1/16W	1	
	R17184	EXB38V470J	RESISTOR ARRAY	1	
	R17185	D0GB102JA041	M 1KOHM,J,1/16W	1	
	R17191	D0GF472JA047	M 4.7KOHM,J, 0.33W	1	
	R17192	ERJ6GEYJ224	M 220KOHM,J,1/ 10W	1	
	R17194	ERJ3GEY0R00	M 0 OHM, 1/16W	1	
	R17195	ERJ3GEY0R00	M 0 OHM, 1/16W	1	
	R17196	ERJ6GEYJ102V	M 1K OHM J 1/10W	1	
	R17201	EXB38V470J	RESISTOR ARRAY	1	
	R17202	ERJ3GEYJ470	M 47 OHM,J,1/16W	1	
	R17203	EXB38V471J	RESISTOR ARRAY	1	
	R17204	ERJ3GEYJ471	M 470 OHM,J,1/ 16W	1	
	R17205	ERJ3GEYJ470	M 47 OHM,J,1/16W	1	
	R17206	ERJ3GEYJ471	M 470 OHM,J,1/ 16W	1	
	R17207	EXB38V470J	RESISTOR ARRAY	1	
	R17208	ERJ3GEYJ470	M 47 OHM,J,1/16W	1	
	R17209	EXB38V471J	RESISTOR ARRAY	1	
	R17210	ERJ3GEYJ471	M 470 OHM,J,1/ 16W	1	
	R17215	ERJ3GEYJ470	M 47 OHM,J,1/16W	1	
	R17216	D0GZ6R8JA020	M 6.8 OHM,J, 0.5W	1	
	R17217	D0GZ6R8JA020	M 6.8 OHM,J, 0.5W	1	
	R17219	ERJ6GEYJ224	M 220KOHM,J,1/ 10W	1	
	R17220	ERJ3GEYJ471	M 470 OHM,J,1/ 16W	1	
	R17223	D0GZ6R8JA020	M 6.8 OHM,J, 0.5W	1	
	R17224	D0GZ6R8JA020	M 6.8 OHM,J, 0.5W	1	
	R17225	EXB38V470J	RESISTOR ARRAY	1	
	R17226	D0GZ6R8JA020	M 6.8 OHM,J, 0.5W	1	
	R17227	D0GZ6R8JA020	M 6.8 OHM,J, 0.5W	1	
	R17228	ERJ3GEYJ470	M 47 OHM,J,1/16W	1	
	R17229	EXB38V471J	RESISTOR ARRAY	1	
	R17230	ERJ3GEYJ471	M 470 OHM,J,1/ 16W	1	
	R17235	ERJ3GEYJ470	M 47 OHM,J,1/16W	1	
	R17236	D0GZ6R8JA020	M 6.8 OHM,J, 0.5W	1	
	R17237	D0GZ6R8JA020	M 6.8 OHM,J, 0.5W	1	
	R17239	ERJ3GEYJ471	M 470 OHM,J,1/ 16W	1	
	R17240	EXB38V470J	RESISTOR ARRAY	1	
	R17241	ERJ3GEYJ470	M 47 OHM,J,1/16W	1	
	R17242	EXB38V471J	RESISTOR ARRAY	1	
	R17245	EXB38V102J	RESISTOR ARRAY	1	
	R17246	ERJ3GEYJ471	M 470 OHM,J,1/ 16W	1	
	R17248	ERJ3GEYJ470	M 47 OHM,J,1/16W	1	
	R17249	EXB38V470J	RESISTOR ARRAY	1	
	R17250	EXB38V470J	RESISTOR ARRAY	1	
	R17251	ERJ3GEYJ471	M 470 OHM,J,1/ 16W	1	

Safety	Ref. No.	Part No.	Part Name & Description	Pcs	Remarks
	R17252	ERJ3GEY0R00	M 0 OHM, 1/16W	1	
	R17253	D0GDR00Z0002	M 0 OHM, 1/10W	1	
	R17257	ERJ3GEYJ470	M 47 OHM,J,1/16W	1	
	R17258	EXB38V102J	RESISTOR ARRAY	1	
	R17261	D0GDR00Z0002	M 0 OHM, 1/10W	1	
	R17262	ERJ3GEY0R00	M 0 OHM, 1/16W	1	
	R17269	D0GF472JA047	M 4.7KOHM,J, 0.33W	1	
	R17272	ERJ3GEY0R00	M 0 OHM, 1/16W	1	
	R17280	D0GB102JA041	M 1KOHM,J,1/16W	1	
	R17282	ERJ3GEY0R00	M 0 OHM, 1/16W	1	
	R17285	EXB38V470J	RESISTOR ARRAY	1	
	R17288	EXB38V222J	RESISTOR ARRAY	1	
	R17290	EXB38V470J	RESISTOR ARRAY	1	
	R17293	EXB38V470J	RESISTOR ARRAY	1	
	R17294	EXB38V471J	RESISTOR ARRAY	1	
	R17295	ERJ3GEYJ470	M 47 OHM,J,1/16W	1	
	R17296	ERJ3GEYJ471	M 470 OHM,J,1/ 16W	1	
	R17297	EXB38V470J	RESISTOR ARRAY	1	
	R17298	EXB38V471J	RESISTOR ARRAY	1	
	R17299	ERJ3GEYJ470	M 47 OHM,J,1/16W	1	
	R17300	ERJ3GEYJ471	M 470 OHM,J,1/ 16W	1	
	R17301	ERJ3GEYJ471	M 470 OHM,J,1/ 16W	1	
	R17302	ERJ3GEYJ471	M 470 OHM,J,1/ 16W	1	
	R17303	ERJ3GEYJ470	M 47 OHM,J,1/16W	1	
	R17304	ERJ3GEYJ470	M 47 OHM,J,1/16W	1	
	SC2	K1KA02A00676	2P CONNECTOR	1	
	SC3	K1KA03A00596	3P CONNECTOR	1	
	SC20	K1MN30BA0255	30P CONNECTOR	1	
	SC41	K1KA09A00239	9P CONNECTOR	1	
	SC42	K1KA09A00239	9P CONNECTOR	1	
	SC46	K1KA09A00239	9P CONNECTOR	1	
	SC50	K1KA02AA0193	2P CONNECTOR	1	
	SS3	K1KY03BA0236	3P CONNECTOR	1	
	SS11	K1KA03A00608	3P CONNECTOR	1	
	SS22	K1KY15AA0606	15P CONNECTOR	1	
	SS23	K1KA06B00220	6P CONNECTOR	1	
	SS24	K1KB15AA0032	15P CONNECTOR	1	
	SS58	K1MN13B00091	13P CONNECTOR	1	
	SS53A	K1MN13B00091	13P CONNECTOR	1	
	VR16600	EVMEASA00B54	CONTROL 50KOHMB 0.3W	1	
	VR16601	EVMEASA00B53	CONTROL 50KOHMB 0.3W	1	
	ZA001	K4AZ01D00004	TERMINAL	1	
	ZA002	K4CD01000011	AV TERMINAL	1	
	ZA16401	K4CD01000011	AV TERMINAL	1	
	ZA16402	K4CD01000011	AV TERMINAL	1	
	ZA16403	K4CD01000011	AV TERMINAL	1	
	ZA17101	K4CD01000013	AV TERMINAL	1	
	ZA17102	K4CD01000013	AV TERMINAL	1	
	ZA17103	K4CD01000013	AV TERMINAL	1	
	ZA17104	K4CD01000013	AV TERMINAL	1	
	ZA17201	K4CD01000013	AV TERMINAL	1	
	ZA17202	K4CD01000013	AV TERMINAL	1	
	ZA17203	K4CD01000013	AV TERMINAL	1	
	ZA17204	K4CD01000013	AV TERMINAL	1	
	△ C101	F0CAF334A021	C 0.33UF, 250V	1	
	△ C102	F1BAF221A107	C 220UF, 250V	1	
	△ C103	F1BAF221A107	C 220UF, 250V	1	
	△ C104	F0CAF334A021	C 0.33UF, 250V	1	
	C105	F1J1H334A679	C 0.33UF. 50V	1	
	△ C106	F1BAF221A107	C 220UF, 250V	1	
	△ C107	F1BAF221A107	C 220UF, 250V	1	
	△ C109	ECQE2W225L0	C 22UF, 450V	1	

Safety	Ref. No.	Part No.	Part Name & Description	Pcs	Remarks
△	C110	ECQE2W225L0	C 22UF, 450V	1	
	C111	ECJ1VB1H103K	C 0.001UF, K, 50V	1	
	C112	ECJ1VB1H102K	C 1000PF, K, 50V	1	
	C113	F1J1E225A209	C 2.2 UF 25V	1	
	C114	F1H1C224A065	C 0.22UF, K, 50V	1	
	C115	ECJ1VB1H103K	C 0.001UF, K, 50V	1	
	C116	ECJ1VB1H472K	C 4700PF, K, 50V	1	
	C117	ECJ1VB1E104K	C 0.10UF, K, 25V	1	
	C118	F1H1H221A832	C 220UF, K, 50V	1	
	C119	ECJ2XB1H104K	C 0.1UF, K, 50V	1	
	C120	F1E2J4730001	C 0.047PF, , 600V	1	
	C121	F1H1C105A071	C 1UF, K, 16V	1	
	C122	ECKD3A102KBP	C 1000PF, K, 1KV	1	
	C123	ECKD3A102KBP	C 1000PF, K, 1KV	1	
	C124	F1H1C105A071	C 1UF, K, 16V	1	
△	C125	F2B2W3310012	C 330UF, 450V	1	
	C126	ECJ1VB1H102K	C 1000PF, K, 50V	1	
	C127	F1H1C105A071	C 1UF, K, 16V	1	
	C130	F1H1H221A832	C 220UF, K, 50V	1	
	C132	ECJ1VB1E104K	C 0.10UF, K, 25V	1	
	C200	ECJ1VB1H102K	C 1000PF, K, 50V	1	
△	C201	F2A2W220A165	E 22UF 160V	1	
	C202	F1E2J4730001	C 0.047PF, , 600V	1	
	C204	F1H1C105A148	C 1UF, K, 16V	1	
	C205	F2A1H4700057	E 47UF, 50V	1	
	C206	ECJ1VB1E104K	C 0.10UF, K, 25V	1	
	C207	F2A1H1000083	E 10UF, 50V	1	
	C208	F1J1E105A231	C 1 UF 25V	1	
	C209	ECJ1VB1E104K	C 0.10UF, K, 25V	1	
	C210	F2A1H4700057	E 47UF, 50V	1	
	C213	F1J1E105A231	C 1 UF 25V	1	
	C300	ECJ1VB1H103K	C 0.001UF, K, 50V	1	
	C301	ECJ2XB1H104K	C 0.1UF, K, 50V	1	
	C303	ECJ2FB1E474K	C 47UF, K, 25V	1	
	C304	ECCD3D470JGE	C 47PF, K, 2KV	1	
	C305	ECJ2XB1H104K	C 0.1UF, K, 50V	1	
	C306	ECJ2FB1E474K	C 47UF, K, 25V	1	
	C307	ECJ2VB1H103K	C 0.01UF, K, 50V	1	
	C308	ECJ2FB1E224K	C 22UF, K, 25V	1	
	C309	ECKD3D122KBP	C 1200PF, K, 2KV	1	
	C310	ECJ2VB1H222K	C 2200P 50V	1	
	C311	ECJ2VC1H470J	C 47PF. K. 50V	1	
	C312	ECJ1VB1E104K	C 0.10UF, K, 25V	1	
△	C313	F0C2J104A104	E 0.10UF, 630V	1	
	C314	F0C2J104A104	E 0.10UF, 630V	1	
△	C315	F0C2J333A104	E 0.033UF, 630V	1	
	C316	F1A3D1000002	C 10PF. 2KV	1	
	C317	F1A3D221A010	C 220PF. 2KV	1	
△	C319	F1BAF3310003	C 330UF, 250V	1	
	C321	ECJ1VB1H103K	C 0.001UF, K, 50V	1	
	C322	ECJ2VB1H103K	C 0.01UF, K, 50V	1	
△	C323	ECQE2W225L0	C 22UF, 450V	1	
	C500	ECJ2FB1C334K	C 33UF, K, 25V	1	
	C502	ECJ1XC1H681J	C 680PF, J, 50V	1	
	C503	ECJ1XC1H681J	C 680PF, J, 50V	1	
	C504	ECJ1XC1H102J	C 1000PF, J, 50V	1	
	C505	F2A1A1820009	C 1800UF. 10V	1	
	C506	ECJ1XC1H681J	C 680PF, J, 50V	1	
	C507	F2A1V1820026	E 1800UF 35V	1	
	C510	ECJ1XC1H102J	C 1000PF, J, 50V	1	
	C511	F1J1E105A231	C 1 UF 25V	1	
	C513	F2A1E1010106	E 100UF, 25V	1	
	C515	ECJ2XB1H104K	C 0.1UF, K, 50V	1	
	C518	ECJ1VB1H103K	C 0.001UF, K, 50V	1	
	C519	ECJ1VB1H102K	C 1000PF, K, 50V	1	
	C520	ECJ1VB1H102K	C 1000PF, K, 50V	1	
	C521	ECJ1VB1H102K	C 1000PF, K, 50V	1	

Safety	Ref. No.	Part No.	Part Name & Description	Pcs	Remarks
	C522	F1J1E105A231	C 1 UF 25V	1	
	C600	ECJ1VB1H103K	C 0.001UF, K, 50V	1	
	C601	ECJ1VB1H103K	C 0.001UF, K, 50V	1	
	C603	ECJ1VB1H103K	C 0.001UF, K, 50V	1	
	C606	ECJ2VB1H223K	C 0.022UF, K, 50V	1	
	C607	ECJ1VB1H103K	C 0.001UF, K, 50V	1	
	C608	ECJ2VB1H223K	C 0.022UF, K, 50V	1	
	C610	ECJ2VB1H103K	C 0.01UF, K, 50V	1	
	C611	ECJ2VB1H103K	C 0.01UF, K, 50V	1	
	C613	ECJ2VB1H103K	C 0.01UF, K, 50V	1	
	C623	F1J0J4750018	C 4.7UF, K, 16V	1	
	C625	ECJ2VB1H102K	C 1000PF, J, 50V	1	
	C627	ECJ2VB1H103K	C 0.01UF, K, 50V	1	
	C628	ECJ2VB1H103K	C 0.01UF, K, 50V	1	
	C630	ECJ1VB1H102K	C 1000PF, K, 50V	1	
	C700	F2A1H1000083	E 10UF, 50V	1	
	C701	ECJ1VB1E104K	C 0.10UF, K, 25V	1	
	C702	ECJ2VB1E104K	C 0.1UF, K, 25V	1	
	C704	F1B3D1020012	C 1000PF. 2KV	1	
	C706	ECJ2XB1H104K	C 0.1UF, K, 50V	1	
△	C709	F2AZZ471A019	E 470UF, 80V	1	
△	C712	F2B2E2210011	C 220UF, Z, 250V	1	
	C713	ECJ2VB1C224K	C 0.22UF, K, 16V	1	
	C714	ECJ2VC1H471J	C 470PF, K, 50V	1	
	C715	ECJ2VC1H471J	C 470PF, K, 50V	1	
	C716	ECJ2VB1C224K	C 0.22UF, K, 16V	1	
	C717	F2A1E3320041	E 3300PF, 25V	1	
	C718	ECJ2XB1H104K	C 0.1UF, K, 50V	1	
	C720	F0C2E204A256	E 0.20UF, 250V	1	
	C721	F0C2E473A256	E 0.047UF, 250V	1	
	C722	F0C2E473A256	E 0.047UF, 250V	1	
	C723	F1J1E105A231	C 1 UF 25V	1	
	C724	F1J1E105A231	C 1 UF 25V	1	
	C726	F2A1E4710105	E 470UF, 25V	1	
	C727	ECJ1VB1E104K	C 0.10UF, K, 25V	1	
	C728	ECJ1VB1H102K	C 1000PF, K, 50V	1	
	C729	ECJ1VB1E104K	C 0.10UF, K, 25V	1	
	C731	ECJ1VB1E104K	C 0.10UF, K, 25V	1	
	C732	F0C2E204A256	E 0.20UF, 250V	1	
	C735	ECJ1VB1H102K	C 1000PF, K, 50V	1	
△	D100	B0FBAT000006	DIODE	1	
	D101	B0ACD0000010	DIODE	1	
	D102	B0JCDD000002	DIODE	1	
	D103	B0BC01400033	ZENER DIODE	1	
	D104	B0JAME000099	DIODE	1	
	D105	B0ACD0000010	DIODE	1	
	D106	B0EAKT000048	DIODE	1	
	D108	B0HAPR000016	DIODE	1	
	D109	B0HAPR000016	DIODE	1	
	D110	B0BC8R100015	ZENER DIODE	1	
	D111	B0ACD0000010	DIODE	1	
	D114	B0ACD0000010	DIODE	1	
△	D200	B0EBKT000007	DIODE	1	
	D202	B0EAKT000048	DIODE	1	
	D203	B0EAKT000048	DIODE	1	
	D204	B0HAMP000067	DIODE	1	
	D205	MTZJ10B	ZENER DIODE	1	
	D206	B0ACD0000010	DIODE	1	
	D207	B0BB17000003	ZENER DIODE	1	
	D208	B0HAMM000122	DIODE	1	
	D209	B0HALP000007	DIODE	1	
	D210	B0EAAD000001	DIODE	1	
	D211	B0BC02000014	ZENER DIODE	1	
	D212	B0EAKT000048	DIODE	1	
	D213	B0JCME000029	DIODE	1	
	D300	B0BC8R100015	ZENER DIODE	1	
	D301	B0HAGR000010	DIODE	1	

Safety	Ref. No.	Part No.	Part Name & Description	Pcs	Remarks
	D302	BOEAD000001	DIODE	1	
	D303	BOEAD000001	DIODE	1	
	D304	BOHAGR000010	DIODE	1	
	D305	BOHAJP000004	DIODE	1	
	D307	B0JCM0000029	DIODE	1	
	D308	B0ACDJ000010	DIODE	1	
	D310	BOEAKT000048	DIODE	1	
	D311	B0JCM000029	DIODE	1	
	D500	B0BC01300033	ZENER DIODE	1	
	D501	B0JANG000018	DIODE	1	
	D502	BOHBSM000043	DIODE	1	
	D506	B0JANG000018	DIODE	1	
	D510	B0JANG000018	DIODE	1	
	D511	B0ACDJ000010	DIODE	1	
	D600	B0ACDJ000010	DIODE	1	
	D603	B0BC5R100039	ZENER DIODE	1	
	D604	BOEAD000001	DIODE	1	
	D605	BOEAD000001	DIODE	1	
	D700	BOHBSN000013	DIODE	1	
	D703	BOEAKT000031	DIODE	1	
	D704	BOEAKT000031	DIODE	1	
	D705	B0JBSL000013	DIODE	1	
	D706	BOFAAT000002	DIODE	1	
	D708	B0BC01300033	ZENER DIODE	1	
	D710	B0JCPE000038	DIODE	1	
	D711	DAN202U	DIODE	1	
	D712	B0BC8R100015	ZENER DIODE	1	
	D713	B0ACDJ000010	DIODE	1	
	D715	B0BC01200047	ZENER DIODE	1	
	D716	B0ADJC000025	DIODE	1	
	D718	B0JCPE000038	DIODE	1	
	D719	B0ACDJ000010	DIODE	1	
	D720	B0ACDJ000010	DIODE	1	
	D721	B0ACDJ000010	DIODE	1	
	D722	B0ACDJ000010	DIODE	1	
△	F100	K5E802BZ0002	FUSE	1	
△	F101	K5E802BZ0002	FUSE	1	
△	F200	K5G631B00008	FUSE	1	
△	F201	K5G631B00008	FUSE	1	
	IC100	C0DBZZZ00084	IC	1	
	IC101	C0DAGKC00001	IC	1	
	IC102	C0DAGKC00002	IC	1	
	IC200	C0DBZMC00006	IC	1	
△	IC201	MIP3E40MY	IC	1	
△	IC202	B3PBA0000508	IC	1	
	IC300	C0ABBA000168	IC	1	
	IC301	C0DABYY00019	IC	1	
△	IC302	B3PBA0000508	IC	1	
△	IC303	B3PBA0000508	IC	1	
△	IC304	B3PBA0000508	IC	1	
	IC500	C0DBZMC00006	IC	1	
	IC502	C0CAAJG00015	IC	1	
△	IC600	CNC1S171R	IC	1	
△	IC601	CNC1S171R	IC	1	
	IC602	C0EBH0000210	IC	1	
	IC603	C2ABDB000122	IC	1	
	IC700	C0DBZMC00006	IC	1	
	IC701	C0DBZMC00006	IC	1	
	IC702	C0DAAZH00027	IC	1	
	J501	ERJ6GEY0R00V	M 0 OHM J 1/10W	1	
△	L100	G0B163J00001	CHOKE COIL	1	
△	L101	G0B163J00001	CHOKE COIL	1	
	L102	EXCELDR35V	CORE	1	
	L103	EXCELDR35V	CORE	1	
	L104	EXCELDR35V	CORE	1	
	L700	G0C680KA0207	CHOKE COIL	1	
	P2	K1KA02A00676	2P CONNECTOR	1	

Safety	Ref. No.	Part No.	Part Name & Description	Pcs	Remarks
	P6	K1KA12AA0191	12P CONNECTOR	1	
	P7	K1KA11AA0191	11P CONNECTOR	1	
	P9	K1KA02B00295	2P CONNECTOR	1	
	P11	K1KA03A00608	3P CONNECTOR	1	
	P25	K1KA13AA0082	13P CONNECTOR	1	
	P34	K1KA03AA0193	3P CONNECTOR	1	
	P35	K1KA03A00647	3P CONNECTOR	1	
△	PR101	K5Y502BA0001	FUSE	1	
△	PR600	ERBSE0R50U	FUSE	1	
△	PR700	K5G502B00015	FUSE	1	
△	PR702	ERBSE0R50U	FUSE	1	
	Q100	B1CHMG000004	FET	1	
	Q101	B1CFHG000013	FET	1	
	Q103	B1BCCF000022	TRANSISTOR	1	
△	Q104	B1CERR000027	FET	1	
	Q106	B1HFCFA00021	TRANSISTOR	1	
	Q201	B1HFCFA00021	TRANSISTOR	1	
	Q300	B1CBGD000001	FET	1	
	Q301	B1CHND000004	FET	1	
	Q302	B1HFFFA00001	TRANSISTOR	1	
	Q303	B1HFFFA00001	TRANSISTOR	1	
△	Q304	B1CERR000028	FET	1	
△	Q305	B1CERR000028	FET	1	
	Q500	B1CHND000004	FET	1	
	Q503	B1CHND000004	FET	1	
	Q504	B1CFQC000002	FET	1	
	Q505	B1CHND000004	FET	1	
	Q506	2SD1819ARL	TRANSISTOR	1	
	Q600	2SD1819ARL	TRANSISTOR	1	
	Q602	2SD1819ARL	TRANSISTOR	1	
	Q610	B1CBGD000001	FET	1	
	Q700	2SB1218ARL	TRANSISTOR	1	
	Q701	B1ADCF000111	TRANSISTOR	1	
	Q702	2SD1819ARL	TRANSISTOR	1	
	Q703	B1HBCFA000033	TRANSISTOR	1	
	Q704	B1HFCFA00021	TRANSISTOR	1	
	Q705	B1HBCFA000033	TRANSISTOR	1	
△	R101	DOB1825JA033	M1.22MOHM,J,0.05W	1	
△	R102	ERF5TJ100	W 10 OHM, J, 5W	1	
	R103	ERJ6GEYJ333V	M 33KOHM, J, 1/10W	1	
	R104	ERJ6GEYJ624	M 620KOHM, J, 1/10W	1	
	R105	D1AB4303A023	CHIP RESISTOR	1	
	R106	ERJ3GEYJ434	M 430KOHM, J, 1/16W	1	
	R107	D1AB4303A023	CHIP RESISTOR	1	
	R108	ERJ3GEYJ223	M 22KOHM, J, 1/16W	1	
	R109	ERJ6GEYJ821	M 820 OHM, J, 1/10W	1	
	R110	D1AB4303A023	CHIP RESISTOR	1	
	R112	ERJ6GEYJ472V	M 4.7K OHM J 1/10W	1	
	R113	ERJ3EKF1002	M 10KOHM, 1/16W	1	
	R114	DOB6R8JA035	M 6.8OHM, J, 0.05W	1	
	R115	DOB6R8JA035	M 6.8OHM, J, 0.05W	1	
	R116	ERJ8GEYJ153	M 15KOHM, J, 1/8W	1	
	R117	ERJ8GEYJ153	M 15KOHM, J, 1/8W	1	
	R118	DOGB183JA057	M 18K OHM J 1/16W	1	
	R119	DOGB103JA057	M 10K OHM J 1/16W	1	
	R120	ERG12SJ181	M 180 OHM, J, 1/2W	1	
	R121	ERJ3GEYJ333	M 33KOHM, J, 1/16W	1	
	R122	ERX12SJ4R7	M 4.7 OHM, J, 1/2W	1	
	R123	DOGB103JA057	M 10K OHM J 1/16W	1	
	R125	DOXZR12JA011	M 0.12OHM, J, 5W	1	



Safety	Ref. No.	Part No.	Part Name & Description	Pcs	Remarks
	R126	DOXR12JA011	M 0.12OHM,J, 5W	1	
	R127	ERJ6GEYJ331V	M 330 OHM J 1/10W	1	
	R128	ERJ6GEYJ103V	M 10K OHM J 1/10W	1	
	R129	D0GD4R7JA059	M 4.7 OHM,J,0.25W	1	
	R130	ERJ6GEYJ104V	M 100KOHM,J,1/10W	1	
	R131	ERJ6GEYJ331V	M 330 OHM J 1/10W	1	
	R132	D0GD2R2JA059	M 2.2 OHM,J,0.25W	1	
	R133	D1AB6803A023	CHIP RESISTOR	1	
	R134	D1AB6803A023	CHIP RESISTOR	1	
	R135	D1AB6803A023	CHIP RESISTOR	1	
	R136	ERJ6GEYJ104V	M 100KOHM,J,1/10W	1	
	R137	ERJ8GEYJ474	M 470KOHM, J,1/8W	1	
	R138	ERJ6GEYJ123V	M 12KOHM,J,1/10W	1	
	R139	ERJ6ENF1272	M12.7KOHM, 1/10W	1	
	R140	ERJ6GEYG821	M 820 OHM,J,1/10W	1	
	R141	EVMAASA00B23	CONTROL 2KOHMB	1	
	R142	D0GB103JA057	M 10K OHM J 1/16W	1	
	R143	ERJ3GEYJ333	M 33KOHM,J,1/16W	1	
	R144	D0GB103JA057	M 10K OHM J 1/16W	1	
	R145	ERJ3GEYJ333	M 33KOHM,J,1/16W	1	
	R146	ERJ3GEYJ472	M 4.7KOHM,J,1/16W	1	
	R147	D1AB5603A023	CHIP RESISTOR	1	
	R148	D1AB5603A023	CHIP RESISTOR	1	
	R149	D1AB5103A023	CHIP RESISTOR	1	
	R150	ERJ6ENF3302	M 33KOHM, 1/10W	1	
	R151	ERJ6ENF2002	M 20KOHM, 1/10W	1	
	R200	D1AB2203A023	CHIP RESISTOR	1	
	R201	D1AB2203A023	CHIP RESISTOR	1	
	R202	D1AB2203A023	CHIP RESISTOR	1	
	R203	D1AB2203A023	CHIP RESISTOR	1	
	R204	D1AB2203A023	CHIP RESISTOR	1	
	R205	D1AB2203A023	CHIP RESISTOR	1	
	R206	ERJ6ENF3302	M 33KOHM, 1/10W	1	
	R207	ERJ6ENF4702	M 47KOHM, 1/10W	1	
	R208	ERJ6GEYJ222V	M 2.2K OHM J 1/10W	1	
	R209	D0GB102JA057	M 1KOHM,J,1/16W	1	
△	R210	ERF5TJ100	W 10 OHM, J, 5W	1	
	R211	ERJ6GEYJ6R8V	M 6.8 OHM,J,1/10W	1	
	R212	ERJ6GEYJ472V	M 4.7K OHM J 1/10W	1	
	R213	ERJ6GEYJ153V	M 15KOHM,J,1/10W	1	
	R214	ERJ6GEYJ221V	M 220 OHM,J,1/10W	1	
	R216	D0GD4R7JA059	M 4.7 OHM,J,0.25W	1	
	R217	D0GD4R7JA059	M 4.7 OHM,J,0.25W	1	
	R218	ERJ3GEY0R00	M 0 OHM, 1/16W	1	
	R219	ERJ6GEYF473	M 47KOHM,J,1/10W	1	
	R301	ERJ6GEYJ472V	M 4.7K OHM J 1/10W	1	
	R303	ERJ6GEYJ332V	M 3.3K OHM J 1/10W	1	
	R304	ERJ6GEYJ104V	M 100KOHM,J,1/10W	1	
	R305	D0GD180JA036	M 18 OHM,J,0.25W	1	
	R308	D0GB105JA057	M 1M OHM F 1/16W	1	
	R309	ERJ6GEYJ222V	M 2.2K OHM J 1/10W	1	
	R310	ERJ6GEYJ103V	M 10K OHM J 1/10W	1	
	R311	ERJ6GEYJ153V	M 15KOHM,J,1/10W	1	
	R312	ERJ6GEYJ333V	M 33KOHM,J,1/10W	1	

Safety	Ref. No.	Part No.	Part Name & Description	Pcs	Remarks
	R313	ERJ6GEYF473	M 47KOHM,J,1/10W	1	
	R314	ERJ6GEYJ100V	M 10 OHM,J,1/10W	1	
	R315	ERJ6GEYJ222V	M 2.2K OHM J 1/10W	1	
	R316	ERJ6GEYJ223	M 22KOHM,J,1/10W	1	
	R317	ERJ6GEYG682	M 6.8KOHM,J,1/10W	1	
	R318	ERJ6GEYJ472V	M 4.7K OHM J 1/10W	1	
	R319	ERJ6GEYJ223	M 22KOHM,J,1/10W	1	
	R320	ERJ6GEYJ1R0	M 1 OHM,J,1/10W	1	
	R321	ERJ6GEYJ223	M 22KOHM,J,1/10W	1	
	R322	ERJ12YJ100	M 10 OHM,J, 1/2W	1	
	R323	ERJ12YJ101	M 100 OHM,J, 1/2W	1	
	R324	ERJ12YJ100	M 10 OHM,J, 1/2W	1	
	R325	ERJ12YJ101	M 100 OHM,J, 1/2W	1	
	R326	ERJ6GEYJ223	M 22KOHM,J,1/10W	1	
	R327	ERJ6GEYJ102V	M 1K OHM J 1/10W	1	
	R328	ERJ6GEYJ104V	M 100KOHM,J,1/10W	1	
	R330	ERJ6GEYJ100V	M 10 OHM,J,1/10W	1	
	R333	ERJ6GEYJ221V	M 220 OHM,J,1/10W	1	
	R334	ERJ6GEYJ104V	M 100KOHM,J,1/10W	1	
	R335	ERJ6GEYJ100V	M 10 OHM,J,1/10W	1	
	R337	ERJ6GEYJ221V	M 220 OHM,J,1/10W	1	
	R338	ERJ6GEYJ104V	M 100KOHM,J,1/10W	1	
	R341	D0XB105JA007	RESISTOR ARRAY	1	
	R342	ERJ6GEYJ102V	M 1K OHM J 1/10W	1	
	R343	ERJ6ENF1200	M 120 OHM, 1/10W	1	
	R344	ERJ6ENF22R0	M 22 OHM, 1/10W	1	
	R346	ERJ6GEYJ221V	M 220 OHM,J,1/10W	1	
	R500	ERJ6GEYJ221V	M 220 OHM,J,1/10W	1	
	R502	D0GB102JA057	M 1KOHM,J,1/16W	1	
	R503	ERJ3GEYJ104	M 100KOHM,J,1/16W	1	
	R504	D0GF1R5JA047	M 1.5 OHM,J, 0.33W	1	
	R505	ERJ8GEYJ100	M 10 OHM, J,1/8W	1	
	R506	ERJ3GEYJ104	M 100KOHM,J,1/16W	1	
	R507	ERJ6RBD333	M 33KOHM,J,1/10W	1	
	R508	ERJ3RBD333	M 33KOHM, 1/16W	1	
	R511	D0GB102JA057	M 1KOHM,J,1/16W	1	
	R512	ERJ3GEY0R00	M 0 OHM, 1/16W	1	
	R515	ERJ3EKF2702V	M27.0KOHM, 1/16W	1	
	R516	ERJ3EKF2401	M 2.4KOHM, 1/16W	1	
	R517	D0GB103JA057	M 10K OHM J 1/16W	1	
	R518	ERJ3GEYJ104	M 100KOHM,J,1/16W	1	
	R521	ERJ3GEYJ104	M 100KOHM,J,1/16W	1	
	R524	ERJ6GEYJ683V	M 68K OHM J 1/10W	1	
	R525	ERJ6GEYJ104V	M 100KOHM,J,1/10W	1	
	R526	ERJ6GEYJ393V	M 39KOHM,J,1/10W	1	
	R527	ERJ6GEYJ101V	M 100 OHM,J,1/10W	1	
	R528	D0GB103JA057	M 10K OHM J 1/16W	1	
	R529	ERJ3GEYJ104	M 100KOHM,J,1/16W	1	
	R530	ERJ6GEYJ104V	M 100KOHM,J,1/10W	1	
	R531	ERJ6GEYJ102V	M 1K OHM J 1/10W	1	
	R600	ERJ3GEY0R00	M 0 OHM, 1/16W	1	
	R601	ERJ6GEYJ102V	M 1K OHM J 1/10W	1	
	R602	ERJ3GEYJ224	M 220KOHM,J,1/16W	1	

Safety	Ref. No.	Part No.	Part Name & Description	Pcs	Remarks
	R603	ERJ3GEYJ101	M 100 OHM,J,1/16W	1	
	R604	ERJ6GEYJ104V	M 100KOHM,J,1/10W	1	
	R605	ERJ3GEYJ224	M 220KOHM,J,1/16W	1	
	R606	ERJ3GEYJ101	M 100 OHM,J,1/16W	1	
	R608	ERJ6GEYJ102V	M 1K OHM J 1/10W	1	
	R609	ERJ6GEYJ104V	M 100KOHM,J,1/10W	1	
	R610	ERJ6GEYJ101V	M 100 OHM,J,1/10W	1	
	R611	ERJ6GEYJ101V	M 100 OHM,J,1/10W	1	
	R612	ERJ3GEY0R00	M 0 OHM, 1/16W	1	
	R613	DOGB154JA057	M 150KOHM J 1/16W	1	
	R615	DOGB182JA057	M 1.8KOHM J 1/16W	1	
	R619	ERJ6GEYJ101V	M 100 OHM,J,1/10W	1	
	R620	ERJ6GEYJ102V	M 1K OHM J 1/10W	1	
	R621	ERJ3GEYJ104	M 100KOHM,J,1/16W	1	
	R622	ERJ6GEYJ102V	M 1K OHM J 1/10W	1	
	R623	ERJ6GEYJ104V	M 100KOHM,J,1/10W	1	
	R633	ERJ3GEYJ222	M 2.2KOHM,J,1/16W	1	
	R634	DOGB102JA057	M 1KOHM,J,1/16W	1	
	R635	ERJ6GEYJ102V	M 1K OHM J 1/10W	1	
	R636	ERJ6GEYJ102V	M 1K OHM J 1/10W	1	
	R637	DOGB152JA057	M 1.5KOHM J 1/16W	1	
	R638	ERJ3GEYJ101	M 100 OHM,J,1/16W	1	
	R639	DOGB152JA057	M 1.5KOHM J 1/16W	1	
	R640	DOGB102JA057	M 1KOHM,J,1/16W	1	
	R641	ERJ6RBD152	M 1.5KOHM,J,1/10W	1	
	R642	DOGB102JA057	M 1KOHM,J,1/16W	1	
	R643	ERJ6GEYJ332V	M 3.3K OHM J 1/10W	1	
	R644	ERJ8GEYJ330	M 33 OHM, J,1/8W	1	
	R645	ERJ3GEYJ104	M 100KOHM,J,1/16W	1	
	R646	ERJ6GEYF473	M 47KOHM,J,1/10W	1	
	R647	ERJ6GEYJ102V	M 1K OHM J 1/10W	1	
	R648	ERJ6GEYJ393V	M 39KOHM,J,1/10W	1	
	R652	ERJ6GEYJ392	M 3.9KOHM,J,1/10W	1	
	R653	ERJ6GEYJ392	M 3.9KOHM,J,1/10W	1	
	R701	ERJ3GEYJ104	M 100KOHM,J,1/16W	1	
	R702	ERJ3GEYJ683	M 68KOHM,J,1/16W	1	
	R703	ERJ6GEYJ222V	M 2.2K OHM J 1/10W	1	
	R704	ERJ6GEYJ102V	M 1K OHM J 1/10W	1	
	R705	ERJ6GEYJ222V	M 2.2K OHM J 1/10W	1	
	R706	ERJ3GEYJ104	M 100KOHM,J,1/16W	1	
	R707	ERG1SJW123	M 12KOHM, J, 1W	1	
	R708	ERJ3GEY0R00	M 0 OHM, 1/16W	1	
	R709	ERJ8GEYJ154	M 150KOHM, J,1/8W	1	
	R710	ERJ8GEYJ154	M 150KOHM, J,1/8W	1	
	R711	ERJ8GEYJ154	M 150KOHM, J,1/8W	1	
	R712	ERJ14YJ2R7U	M 2.7OHM, 1/4W	1	
	R713	ERJ14YJ2R7U	M 2.7OHM, 1/4W	1	
	R714	ERJ14YJ2R7U	M 2.7OHM, 1/4W	1	
	R715	ERJ14YJ2R7U	M 2.7OHM, 1/4W	1	
	R716	ERJ6GEYJ102V	M 1K OHM J 1/10W	1	

Safety	Ref. No.	Part No.	Part Name & Description	Pcs	Remarks
	R717	ERJ6GEYJ102V	M 1K OHM J 1/10W	1	
	R718	ERJ6GEYJ681	M 680 OHM,J,1/10W	1	
	R720	ERJ6GEYJ103V	M 10K OHM J 1/10W	1	
	R721	ERJ6GEYJ101V	M 100 OHM,J,1/10W	1	
	R722	ERJ6GEYJ102V	M 1K OHM J 1/10W	1	
	R723	ERJ6GEYJ122V	M 1.2KOHM,J,1/10W	1	
	R724	ERJ6GEYJ102V	M 1K OHM J 1/10W	1	
	R725	ERJ8ENF1603	M 16KOHM, 1/8W	1	
	R726	ERJ8ENF1503	M 15KOHM, 1/8W	1	
	R727	ERJ8ENF1303	M 13KOHM, 1/8W	1	
	R728	ERJ8ENF1303	M 13KOHM, 1/8W	1	
	R730	ERJ6ENF6801	M 6.8KOHM, 1/10W	1	
	R731	ERJ6GEYJ222V	M 2.2K OHM J 1/10W	1	
	R732	ERJ8ENF5102	M 51K OHM, 1/8W	1	
	R733	ERJ8ENF4702	M 47K OHM, 1/8W	1	
	R735	EVMAASA00B23	CONTROL 2KOHMB	1	
	R736	ERJ6ENF3301	M 3.3KOHM, 1/10W	1	
	R737	EVMAASA00B23	CONTROL 2KOHMB	1	
	R738	ERJ6ENF1303	M 13KOHM, 1/10W	1	
	R739	ERJ6ENF1303	M 13KOHM, 1/10W	1	
	R740	ERJ6ENF3302	M 33KOHM, 1/10W	1	
	R741	ERJ6ENF1803	M 18KOHM, 1/10W	1	
	R742	ERJ6ENF1803	M 18KOHM, 1/10W	1	
	R743	ERJ6ENF1803	M 18KOHM, 1/10W	1	
	R744	ERJ6ENF1803	M 18KOHM, 1/10W	1	
	R745	ERJ6ENF3302	M 33KOHM, 1/10W	1	
	R748	ERJ8ENF3900	M 390 OHM, 1/8W	1	
	R749	ERJ3GEYJ472	M 4.7KOHM,J,1/16W	1	
	R750	ERJ3GEYJ333	M 33KOHM,J,1/16W	1	
	R751	ERJ6ENF1302	M 13KOHM, 1/10W	1	
	R752	ERJ6ENF1101	M 1.1KOHM, 1/10W	1	
	R753	ERJ6GEYJ101V	M 100 OHM,J,1/10W	1	
	R754	ERJ3EKF2002	M 20KOHM, 1/16W	1	
	R755	ERJ3EKF3302	M 33KOHM, 1/16W	1	
	R757	DOMA30MJ0001	M 30 OHM,J, 2W	1	
	R764	DOGB103JA057	M 10K OHM J 1/16W	1	
	R765	DOGB103JA057	M 10K OHM J 1/16W	1	
	R766	ERJ6GEYJ101V	M 100 OHM,J,1/10W	1	
	R768	ERJ8ENF3900	M 390 OHM, 1/8W	1	
	R769	ERJ6GEYJ102V	M 1K OHM J 1/10W	1	
	R770	DOGB103JA057	M 10K OHM J 1/16W	1	
	R777	DOMA30MJ0001	M 30 OHM,J, 2W	1	
	R784	ERJ6GEYJ102V	M 1K OHM J 1/10W	1	
	R785	ERJ3GEYJ222	M 2.2KOHM,J,1/16W	1	
	R788	ERJ6GEY0R00V	M 0 OHM J 1/10W	1	
	R792	ERJ3EKF2002	M 20KOHM, 1/16W	1	
	R793	ERJ3EKF3302	M 33KOHM, 1/16W	1	
	R795	ERJ3GEY0R00	M 0 OHM, 1/16W	1	
	R797	ERJ6GEYF561	M 560 OHM,F,1/10W	1	
	△	RL101	K6B1AYY00047	REALY	1
	△	RL102	K6B1AYY00047	REALY	1
	△	S100	J0LT00000009	SWITCH	1
	△	S101	J0LT00000009	SWITCH	1
	T100	G4DYA0000152	TRANSFORMER	1	
	△	T200	ETS29AZ2U6AH	TRANSFORMER	1
	△	T300	G4D3A0000211	TRANSFORMER	1
	△	T301	G4D3A0000213	TRANSFORMER	1
	X801	H2B400400021	CRYSTAL	1	

Safety	Ref. No.	Part No.	Part Name & Description	Pcs	Remarks
	Z1	K4ZZ01000206	TERMINAL	1	
	Z2	K4ZZ01000206	TERMINAL	1	
	Z3	K4ZZ01000206	TERMINAL	1	
△	ZN100	ERZVRED621	VARISTOR	1	
△	ZN101	ERZVGAD681T2	VARISTOR	1	
△	ZN102	ERZVRED621	VARISTOR	1	
△	ZN200	ERZVA7D511	VARISTOR	1	
△	ZN201	ERZVA7D511	VARISTOR	1	