

13 Exploded View and Replacement Parts List

13.1. Exploded View and Mechanical Replacement Parts List

13.1.1. Exploded View

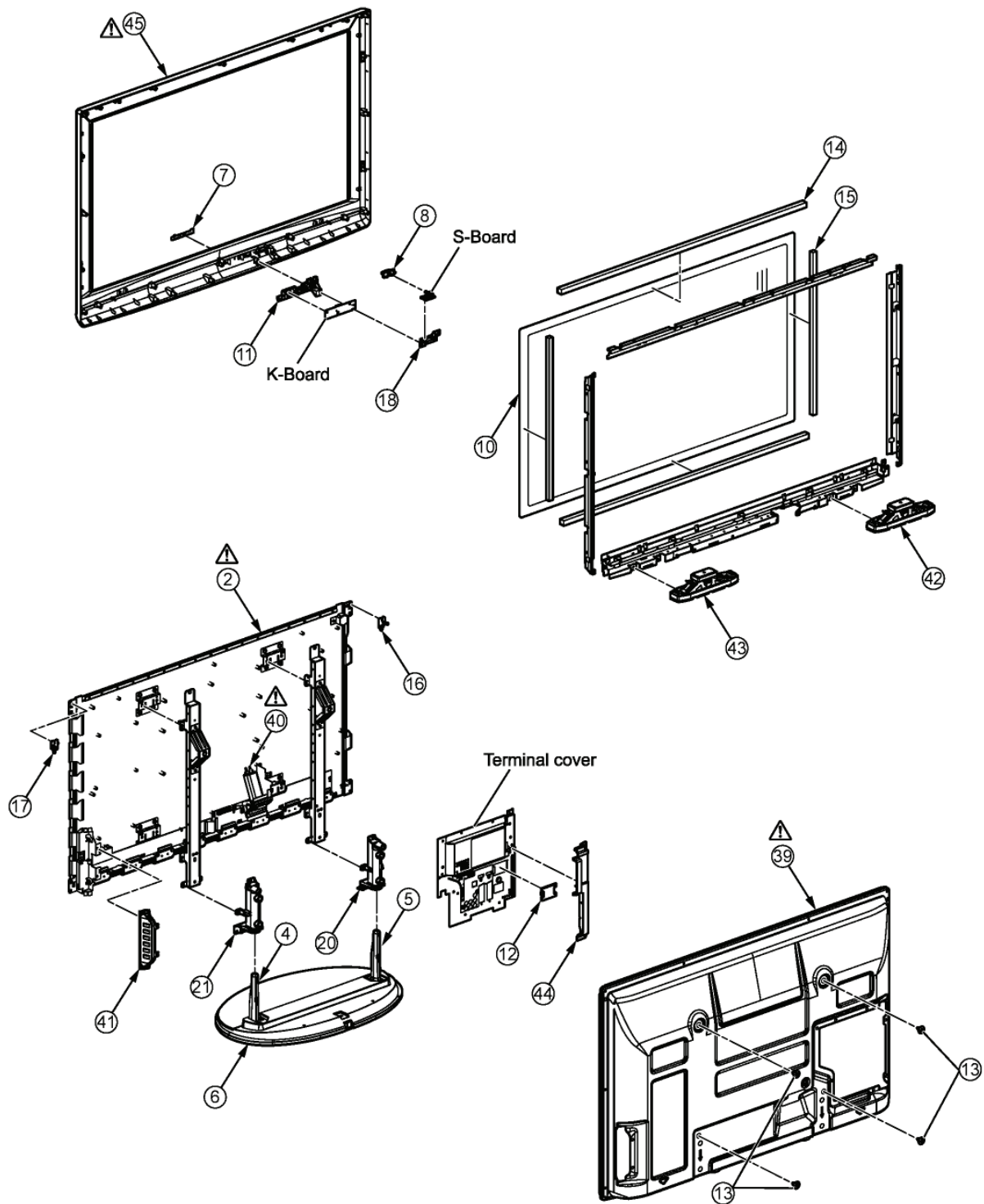

13.1.2. Packing 1

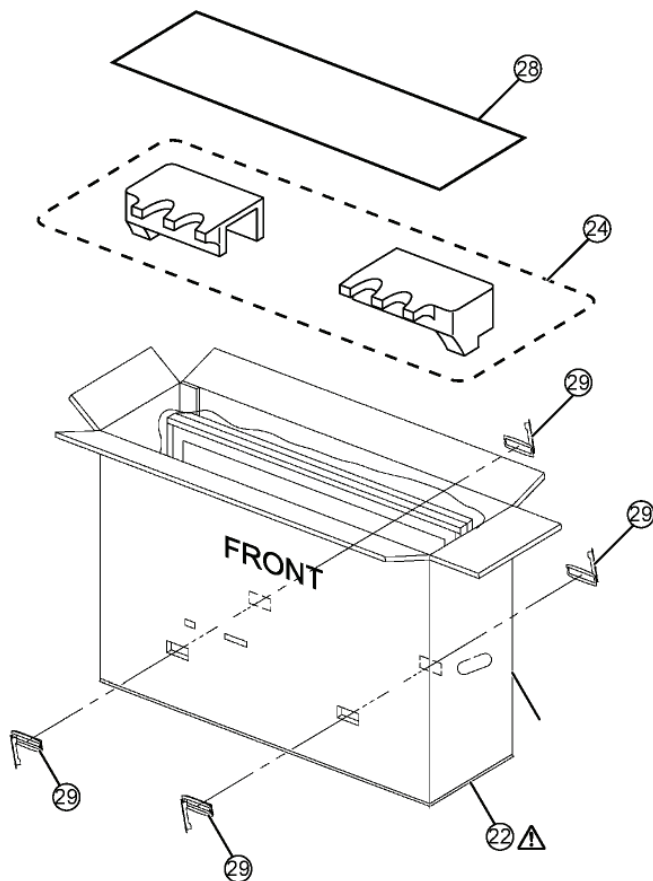



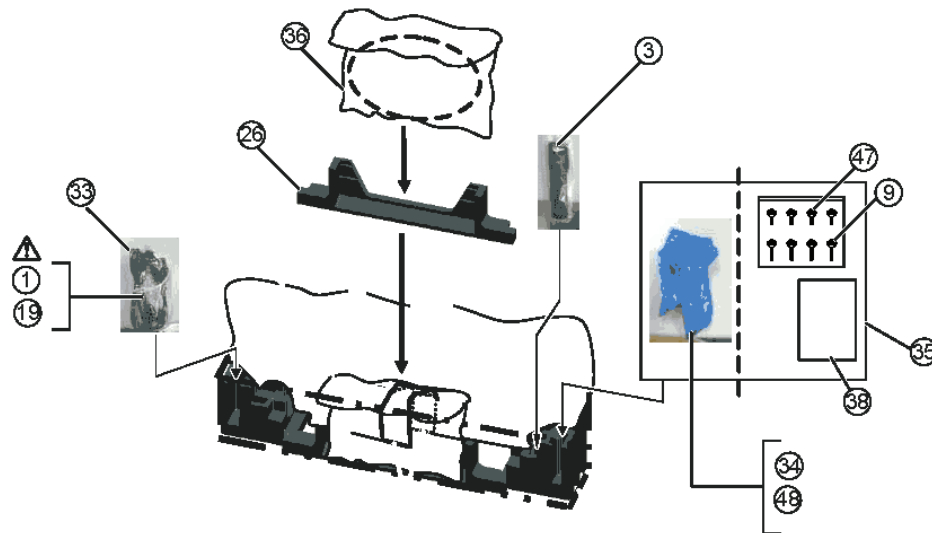
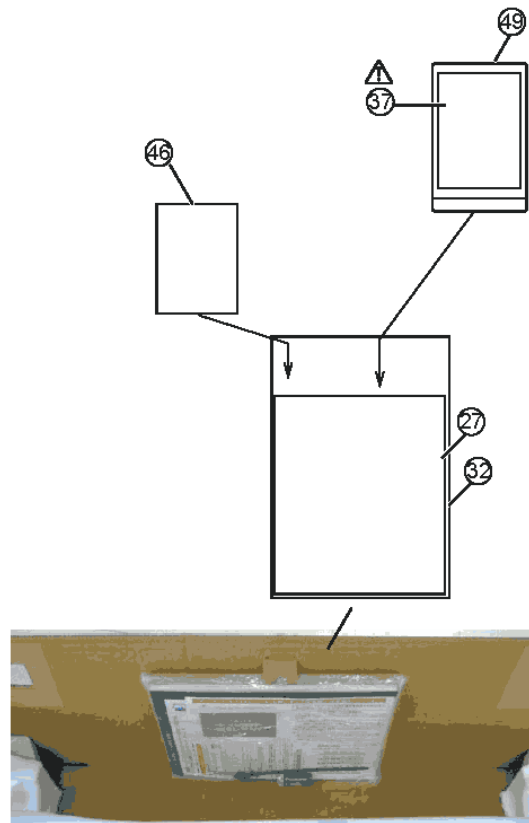
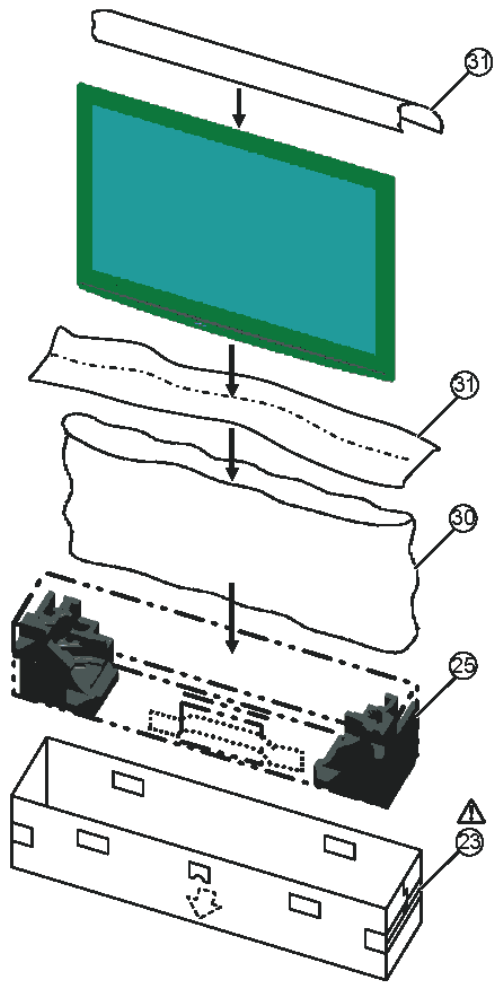

























13.1.3. Packing 2







13.1.4. Mechanical Replacement Parts List

Note: All parts except parts mentioned [PAVCCZ] in the Remarks column are supplied by AVC-CSPC.
Parts mentioned [PAVCCZ] are supplied by PAVCCZ.

Safety	Ref. No.	Part No.	Part Name & Description	Q'ty	Remarks
	1	K2CN3YY00004	AC CORD	1	E PAVCCZ
	1	K2CT3YY00016	AC CORD	1	B PAVCCZ
	2	MD37H12A2J	PLASMA DISPLAY PANEL	1	PAVCCZ
	3	N2QAYB000328	REMOTE CONTROL	1	PAVCCZ
	4	TBLA3685	STAND POLE R	1	PAVCCZ
	5	TBLA3686	STAND POLE L	1	PAVCCZ
	6	TBLX0096	PEDESTAL STAND	1	PAVCCZ
	7	TBMA282	PANASONIC BADGE	1	
	8	TBX3EA00201	POWER BUTTON	1	PAVCCZ
		THEJ016J	SCREW (AC INRET:2)	2	
		THEL052Z	SCREW (BC TOP:4)	2	
	9	THEL061N	SCREW (STAND-TV)	4	
		THEL069J	SCREW (TU:2 INLET:3 CONT:1)	54	
		THEL070J	SCREW (BC-TU:6 SIDE-T:2 AC:1 CONT:2)	11	
		THTD020J	SCREW (A-PRINT:4)	3	
		THTF013J	SCREW	2	
	10	TKGA5540	FRONT GLASS	1	PAVCCZ
	11	TKK3EC5002	LED PANEL	1	PAVCCZ
	12	TKK3EL5001-1	ADJUSTMENT COVER	1	PAVCCZ
	13	TKKL5472	M8 CAP	4	
	14	TMK0EG012	SPONGE (UPPER/BOTTOM)	2	PAVCCZ
	15	TMK0EG013	SPONGE (LEFT/RIGHT)	2	PAVCCZ
		TMM23417	CLAMPER	3	
	16	TMMD014-1	REAR COVER HOOK L	1	
	17	TMMD015-1	REAR COVER HOOK R	1	
		TMME061	CLAMPER	1	
		TMME224	CLAMPER	4	
		TMME261	CLAMPER	2	
		TMME287	CLAMPER	2	
		TMME292	CLAMPER	1	
		TMME331	CLAMPER	2	
		TMME332	CLAMPER (HANGER METAL)	1	
		TMME332	CLAMPER (SS:1)	1	
		TMME332	CLAMPER (GLASS HOLDER REAR BOTTOM)	2	
		TMME341	CLAMPER	4	
		TMME345	SPACER	1	
	18	TMW3EC002	POWER BUTTON BRACKET	1	PAVCCZ
	19	TMXX055	AC CORD CLAMPER	2	
		TMXX062	AC CODE HOLDER	1	
	20	TMZX5160	STAND BRACKET (L)	1	
	21	TMZX5161	STAND BRACKET (R)	1	
	22	TPC0E53201	CARTON BOX TOP	1	PAVCCZ
	23	TPC0E53300	CARTON BOX BOTTOM	1	PAVCCZ

Safety	Ref. No.	Part No.	Part Name & Description	Q'ty	Remarks
	24	TPD0E1077	TOP CUSHION	1	PAVCCZ
	25	TPD0E2056	BOTTOM CUSHION	1	PAVCCZ
	26	TPD0E2080	PEDESTAL CUSHION	1	PAVCCZ
	27	TPD0E9137	ACCESSORIES PAD	1	PAVCCZ
	28	TPD0E9156	TOP PAD	1	PAVCCZ
	29	TPD169487	JOINT	4	
	30	TPE0E4010	PROTECT COVER	1	PAVCCZ
	31	TPE0E4041	PROTECT SHEET	2	PAVCCZ
	32	TPE0E9002	ACCESSORIES BAG	1	PAVCCZ
	33	TPE0E9003	BAG FOR AC CORD	1	PAVCCZ
	36	TPEB331-1	BAG (PEDESTAL STAND)	1	
	34	TPEB336	BAG (STAND POLE R)	1	
	35	TPEB338	BAG (STAND ACCESSORY)	1	PAVCCZ
		TPG0E9330	PAPER CAP	0.25	PAVCCZ
	37	TQB0E0823	INSTRUCTION BOOK (ENGLISH)	1	E PAVCCZ
	37	TQB0E0824A	INSTRUCTION BOOK (GERMAN)	1	B PAVCCZ
	37	TQB0E0824B	INSTRUCTION BOOK (DUTCH)	1	E PAVCCZ
	37	TQB0E0824C	INSTRUCTION BOOK (ITALIAN)	1	E PAVCCZ
	37	TQB0E0824D	INSTRUCTION BOOK (FRENCH)	1	E PAVCCZ
	37	TQB0E0824E	INSTRUCTION BOOK (SPANISH)	1	E PAVCCZ
	37	TQB0E0824F	INSTRUCTION BOOK (SWEDISH)	1	E PAVCCZ
	37	TQB0E0824G	INSTRUCTION BOOK (NORWEGIAN)	1	E PAVCCZ
	37	TQB0E0824H	INSTRUCTION BOOK (FINNISH)	1	E PAVCCZ
	37	TQB0E0824I	INSTRUCTION BOOK (LITHUANIAN)	1	E PAVCCZ
	37	TQB0E0824J	INSTRUCTION BOOK (PORTUGUESE)	1	E PAVCCZ
	37	TQB0E0824K	INSTRUCTION BOOK (DANISH)	1	E PAVCCZ
	37	TQB0E0824M	INSTRUCTION BOOK (BULGARIAN)	1	E PAVCCZ
	37	TQB0E0824N	INSTRUCTION BOOK (ROMANIAN)	1	E PAVCCZ
	37	TQB0E0824O	INSTRUCTION BOOK (LATVIAN)	1	E PAVCCZ
	37	TQB0E0824P	INSTRUCTION BOOK (POLISH)	1	E PAVCCZ
	37	TQB0E0824Q	INSTRUCTION BOOK (HUNGARIAN)	1	E PAVCCZ
	37	TQB0E0824R	INSTRUCTION BOOK (CZECH)	1	E PAVCCZ
	37	TQB0E0824S	INSTRUCTION BOOK (GREEK)	1	E PAVCCZ
	37	TQB0E0824T	INSTRUCTION BOOK (TURKISH)	1	E PAVCCZ
	37	TQB0E0824U	INSTRUCTION BOOK (ENGLISH)	1	E PAVCCZ
	37	TQB0E0824W	INSTRUCTION BOOK (SLOVAKIAN)	1	E PAVCCZ
	37	TQB0E0824X	INSTRUCTION BOOK (CD-ROM)	1	E PAVCCZ
	37	TQB0E0824Z	INSTRUCTION BOOK (ESTONIAN)	1	E PAVCCZ
	38	TQZJ060	SCREW USE HANDBILL	1	PAVCCZ
		TSXL732	CABLE (A20-SC20)	1	PAVCCZ
		TSXL737	CABLE (C10-C20)	1	
		TSXL756	CABLE (C10-C20)	1	PAVCCZ
		TSXL759	CABLE (C22-A32)	1	PAVCCZ

Safety	Ref. No.	Part No.	Part Name & Description	Q'ty	Remarks
	39	TTU0E0574	REAR COVER	1	B PAVCCZ
	39	TTU0E0468	REAR COVER	1	E PAVCCZ
	40	TXAJS01ERUE	AC INLET ASSY	1	PAVCCZ
	41	TXFBX03ERUE	CONTROL BUTTON ASSY	1	PAVCCZ
	42	TXFEA01ERUE	SPEAKER L ASSY	1	PAVCCZ
	43	TXFEA02EQEUE	SPEAKER R ASSY	1	PAVCCZ
	44	TXFKP01EUUE	SIDE TERMINAL COVER ASSY	1	PAVCCZ
	45	TXFKY01EUUE	CABINET ASSY	1	PAVCCZ
	46	TXFPE01RLTB	CLEANING CLOTH ASSY	1	PAVCCZ
		TXJA11ERUE	SPEAKER LEAD (A11-SPR)	1	PAVCCZ
		TXJA12ERUE	SPEAKER LEAD (A12-SPL)	1	PAVCCZ
		XSB3+6FJ	SCREW	2	
		XTB4+10JFJ	SCREW (STAND BRACKET)	6	
		XTB4+12GFJ	SCREW	19	
		XTB4+12GFJK	SCREW	11	
		XTB4+12GFN	SCREW	4	
		XTS4+12GFN	SCREW	2	
		XTV3+10JFJK	SCREW	4	
		XTW3+10TFJ	SCREW	1	
		XTWT4+Z15DFJ	SCREW (SP BOX)	4	
		XYN3+F8FJ	SCREW	1	
		XYN3+J12FJ	SCREW	26	
		XYN4+E8FJ	SCREW	1	
		XYN4+F10FJ	SCREW	20	
	47	XYN5+F18FN	SCREW (STAND POLE)	4	
	48	XZB9X18C05	BAG (STAND POLE L)	1	
	49	XZBT6506	POLY BAG (INSTRUCTION BOOK)	1	

Safety	Ref. No.	Part No.	Part Name & Description	Pcs	Remarks
	C2407	FK1E106A136	C 10UF, Z, 25V	1	
	C2408	FIJ1E105A171	C 1 UF 25V	1	
	C2409	FIG1H102A730	C 1000UF, 50V	1	
	C2410	FIJ1E105A171	C 1 UF 25V	1	
	C2411	FIJ1E105A171	C 1 UF 25V	1	
	C2412	FIJ1E105A171	C 1 UF 25V	1	
	C2512	FIJ1A106A043	C 0.010UF, K, 10V	1	
	C2515	FIH1H103A970	C 0.001UF, K, 50V	1	
	C2517	FIH1H103A970	C 0.001UF, K, 50V	1	
	C2521	FIH1H103A970	C 0.001UF, K, 50V	1	
	C2871	FK1E106A136	C 10UF, Z, 25V	1	
	C2872	FIG1E103A123	C 0.010UF, K, 25V	1	
	C2873	FIH1E104A129	C 0.1UF, 25V	1	
	C2874	F2G1A101A019	E 100UF, 10V	1	
	C2875	FIH1H223A970	C 0.22UF, K, 50V	1	
	C2878	FIH1H472A970	C 4700PF, K, 50V	1	
	C2901	F2G1A101A019	E 100UF, 10V	1	
	C2906	FIH1C104A143	C 0.1UF, K, 16V	1	
	C2907	FIH1C104A143	C 0.1UF, K, 16V	1	
	C2912	F2G0J101A019	E 100UF 6.3V	1	
	C2914	FIH1H104A970	C 0.1UF, K, 50V	1	
	C2916	FIH1C104A143	C 0.1UF, K, 16V	1	
	C2920	FIH1H103A970	C 0.001UF, K, 50V	1	
	C2922	FIH1C104A143	C 0.1UF, K, 16V	1	
	C2923	FIH1H104A970	C 0.1UF, K, 50V	1	
	C2925	FIG1C104A116	C 0.10UF, K, 16V	1	
	C2927	FIG1H101A731	C 100PF, K, 50V	1	
	C2928	FIG1H101A731	C 100PF, K, 50V	1	
	C2940	FIH1H104A970	C 0.1UF, K, 50V	1	
	C2960	FIH0J1050012	C 1UF, K, 16V	1	
	C2961	FIG1H471A731	C 470UF, 50V	1	
	C2962	FIH0J1050012	C 1UF, K, 16V	1	
	C3002	FIG1H561A730	C 56UF, 50V	1	
	C3003	FIG1H561A730	C 56UF, 50V	1	
	C3004	FIG1H561A730	C 56UF, 50V	1	
	C3005	FIG1H561A730	C 56UF, 50V	1	
	C3007	FIG1H561A730	C 56UF, 50V	1	
	C3008	FIG1H561A730	C 56UF, 50V	1	
	C3009	FIG1H561A730	C 56UF, 50V	1	
	C3010	FIG1H561A730	C 56UF, 50V	1	
	C3011	FIG1H561A730	C 56UF, 50V	1	
	C3012	FIG1H561A730	C 56UF, 50V	1	
	C3013	FIG1H561A730	C 56UF, 50V	1	
	C3014	FIG1H561A730	C 56UF, 50V	1	
	C3018	FIJ1A106A043	C 0.010UF, K, 10V	1	
	C3019	FIJ1A106A043	C 0.010UF, K, 10V	1	
	C3020	FIJ1A106A043	C 0.010UF, K, 10V	1	
	C3021	FIJ1A106A043	C 0.010UF, K, 10V	1	
	C3022	FIH1A1050032	C 10UF, 50V	1	
	C3024	FIH1A1050032	C 10UF, 50V	1	
	C3025	FIH1A1050032	C 10UF, 50V	1	
	C3026	FIH1A1050032	C 10UF, 50V	1	
	C3027	FIJ1A106A043	C 0.010UF, K, 10V	1	
	C3028	FIJ1A106A043	C 0.010UF, K, 10V	1	
	C3029	FIJ1A106A043	C 0.010UF, K, 10V	1	
	C3030	FIJ1A106A043	C 0.010UF, K, 10V	1	
	C3039	FIH1A1050032	C 10UF, 50V	1	
	C3041	FIH1A1050032	C 10UF, 50V	1	
	C3043	FIH1A1050032	C 10UF, 50V	1	
	C3044	FIH1A1050032	C 10UF, 50V	1	
	C3046	FIH1A1050032	C 10UF, 50V	1	
	C3047	FIH1A1050032	C 10UF, 50V	1	

Safety	Ref. No.	Part No.	Part Name & Description	Pcs	Remarks
	C3048	FIH1A1050032	C 10UF, 50V	1	
	C3049	FIH1A1050032	C 10UF, 50V	1	
	C3056	FIG1E333A091	C 0.033UF, K, 25V	1	
	C3057	FIG1E333A091	C 0.033UF, K, 25V	1	
	C3064	FIG1H102A730	C 1000UF, 50V	1	
	C3065	FIG1H102A730	C 1000UF, 50V	1	
	C3070	FIJ1A106A043	C 0.010UF, K, 10V	1	
	C3071	FIJ1A106A043	C 0.010UF, K, 10V	1	
	C3072	FIG1C104A116	C 0.10UF, K, 16V	1	
	C3073	FIJ1A106A043	C 0.010UF, K, 10V	1	
	C3074	FIJ1A106A043	C 0.010UF, K, 10V	1	
	C3075	FIH1A1050032	C 10UF, 50V	1	
	C3077	FIG1C104A116	C 0.10UF, K, 16V	1	
	C3078	FIJ1A106A043	C 0.010UF, K, 10V	1	
	C3083	FIJ1A106A043	C 0.010UF, K, 10V	1	
	C3084	FIJ1A106A043	C 0.010UF, K, 10V	1	
	C3085	FIJ1A106A043	C 0.010UF, K, 10V	1	
	C3086	FIJ1A106A043	C 0.010UF, K, 10V	1	
	C3087	FIJ1A106A043	C 0.010UF, K, 10V	1	
	C3088	FIJ1A106A043	C 0.010UF, K, 10V	1	
	C3089	FIJ1A106A043	C 0.010UF, K, 10V	1	
	C3090	FIJ1A106A043	C 0.010UF, K, 10V	1	
	C3091	FIJ1A106A043	C 0.010UF, K, 10V	1	
	C3092	FIJ1A106A043	C 0.010UF, K, 10V	1	
	C3095	F2G1A101A019	E 100UF, 10V	1	
	C3097	F2G1A101A019	E 100UF, 10V	1	
	C3099	FIG1H561A730	C 56UF, 50V	1	
	C3102	F2G1A101A019	E 100UF, 10V	1	
	C3103	F2G1A101A019	E 100UF, 10V	1	
	C3114	FIJ1A106A043	C 0.010UF, K, 10V	1	
	C3115	FIJ1A106A043	C 0.010UF, K, 10V	1	
	C3116	FIJ1A106A043	C 0.010UF, K, 10V	1	
	C3117	FIJ1A106A043	C 0.010UF, K, 10V	1	
	C3118	FIH1A1050032	C 10UF, 50V	1	
	C3119	FIH1A1050032	C 10UF, 50V	1	
	C3139	FIG1C104A116	C 0.10UF, K, 16V	1	
	C3140	FIG1C104A116	C 0.10UF, K, 16V	1	
	C3141	FIG1C104A116	C 0.10UF, K, 16V	1	
	C3143	FIG1C104A116	C 0.10UF, K, 16V	1	
	C3144	FIJ1A106A043	C 0.010UF, K, 10V	1	
	C3145	FIG1C104A116	C 0.10UF, K, 16V	1	
	C3146	FIJ1A106A043	C 0.010UF, K, 10V	1	
	C3147	FIJ1A106A043	C 0.010UF, K, 10V	1	
	C3257	FIG1H561A730	C 56UF, 50V	1	
	C3752	FIJ1H102A836	C 1000UF, 50V	1	
	C4500	FIG1C104A116	C 0.10UF, K, 16V	1	
	C4501	FIG1C104A116	C 0.10UF, K, 16V	1	
	C4502	FIG1C104A116	C 0.10UF, K, 16V	1	
	C4503	FIG1C104A116	C 0.10UF, K, 16V	1	
	C4533	FIG1H680A731	C 68UF, 50V	1	
	C4534	FIG1C104A116	C 0.10UF, K, 16V	1	
	C4535	FIG1C104A116	C 0.10UF, K, 16V	1	
	C4537	FIG1C104A116	C 0.10UF, K, 16V	1	
	C4547	FIG1C104A116	C 0.10UF, K, 16V	1	

Safety	Ref. No.	Part No.	Part Name & Description	Pcs	Remarks
	C4548	F1G1C104A116	C 0.10UF, K, 16V	1	
	C4549	F1G1C104A116	C 0.10UF, K, 16V	1	
	C4550	F1G1C104A116	C 0.10UF, K, 16V	1	
	C4551	F1G1C104A116	C 0.10UF, K, 16V	1	
	C4552	F1G1C104A116	C 0.10UF, K, 16V	1	
	C4553	F1G1H102A730	C 1000UF, 50V	1	
	C4554	F2G1C470A022	E 47UF, 16V	1	
	C4555	F1J1A106A043	C 0.010UF, K, 10V	1	
	C4567	F1G1C104A116	C 0.10UF, K, 16V	1	
	C4574	F1G1C104A116	C 0.10UF, K, 16V	1	
	C4575	F1G1C104A116	C 0.10UF, K, 16V	1	
	C4580	F1G1C104A116	C 0.10UF, K, 16V	1	
	C4585	F1G1C104A116	C 0.10UF, K, 16V	1	
	C4595	F1G1C104A116	C 0.10UF, K, 16V	1	
	C4598	F1J1A106A043	C 0.010UF, K, 10V	1	
	C4599	F1J1A106A043	C 0.010UF, K, 10V	1	
	C4600	F1G1C104A116	C 0.10UF, K, 16V	1	
	C4601	F1J1A106A043	C 0.010UF, K, 10V	1	
	C4602	F1G1C104A116	C 0.10UF, K, 16V	1	
	C4603	F1J1A475A039	C 4.7UF, K, 10V	1	
	C4605	F1J1A475A039	C 4.7UF, K, 10V	1	
	C4606	F1J1A475A039	C 4.7UF, K, 10V	1	
	C4607	F1J1A475A039	C 4.7UF, K, 10V	1	
	C4608	F1G1C104A116	C 0.10UF, K, 16V	1	
	C4613	F1H0J1050012	C 1UF, K, 16V	1	
	C4616	F1J1A475A039	C 4.7UF, K, 10V	1	
	C4617	F1J1A475A039	C 4.7UF, K, 10V	1	
	C4624	F1G1C104A116	C 0.10UF, K, 16V	1	
	C4625	F1G1C104A116	C 0.10UF, K, 16V	1	
	C4626	F1G1C104A116	C 0.10UF, K, 16V	1	
	C4628	F1G1C104A116	C 0.10UF, K, 16V	1	
	C4629	F1G1C104A116	C 0.10UF, K, 16V	1	
	C4630	F1G1C104A116	C 0.10UF, K, 16V	1	
	C4631	F1J1A106A043	C 0.010UF, K, 10V	1	
	C4632	F1G1C104A116	C 0.10UF, K, 16V	1	
	C4633	F1J1A106A043	C 0.010UF, K, 10V	1	
	C4634	F1G1C104A116	C 0.10UF, K, 16V	1	
	C4635	F1J1A106A043	C 0.010UF, K, 10V	1	
	C4636	F1G1C104A116	C 0.10UF, K, 16V	1	
	C4637	F1G1C104A116	C 0.10UF, K, 16V	1	
	C4638	F1G1C104A116	C 0.10UF, K, 16V	1	
	C4640	F1G1C104A116	C 0.10UF, K, 16V	1	
	C4642	F1G1C104A116	C 0.10UF, K, 16V	1	
	C4643	F1G1C104A116	C 0.10UF, K, 16V	1	
	C4644	F1G1C104A116	C 0.10UF, K, 16V	1	
	C4645	F1G1C104A116	C 0.10UF, K, 16V	1	
	C5470	F1G1C103A116	C 0.010UF, K, 16V	1	
	C5471	F1G1A473A053	C 0.47UF, 10V	1	
	C5473	F1G1E103A123	C 0.010UF, K, 25V	1	
	C5482	F2G1A221A149	E 220UF, 10V	1	
	C5483	F1J1A106A043	C 0.010UF, K, 10V	1	
	C5484	F2G0J470A019	E 47UF 6.3V	1	
	C5485	F1G1C104A116	C 0.10UF, K, 16V	1	
	C5486	F1G1E392A123	C 3900UF, Z, 25V	1	
	C5487	F1H0J1050012	C 1UF, K, 16V	1	
	C5488	F1H0J1050012	C 1UF, K, 16V	1	
	C5490	F1J1H474A757	C 0.47UF, 50V	1	
	C5491	F1J1H474A757	C 0.47UF, 50V	1	
	C5494	F1G1H820A731	C 82UF, 50V	1	
	C5495	F2G1V220A020	E 22UF, 35V	1	
	C5496	F1G1H102A730	C 1000UF, 50V	1	
	C5520	F2G1C100A022	C 10UF J 16V	1	
	C5600	F1G1C104A116	C 0.10UF, K, 16V	1	
	C5601	F1G1H272A571	C 2700UF, 50V	1	
	C5602	F2H0J1010009	C 100UF, 6.3V	1	

Safety	Ref. No.	Part No.	Part Name & Description	Pcs	Remarks
	C5603	F1H1C105A145	C 0.01UF, K, 16V	1	
	C5604	F1G1E103A123	C 0.010UF, K, 25V	1	
	C5605	F1J1A475A039	C 4.7UF, K, 10V	1	
	C5606	F1G1E6820007	C 6800UF, Z, 25V	1	
	C5607	F1G1H152A571	C 1500UF, 50V	1	
	C5608	F1G1C104A116	C 0.10UF, K, 16V	1	
	C5611	F1K1E106A136	C 10UF, Z, 25V	1	
	C5612	F1K1E106A136	C 10UF, Z, 25V	1	
	C5615	F1K1E106A136	C 10UF, Z, 25V	1	
	C5616	F1G1E103A123	C 0.010UF, K, 25V	1	
	C5620	F1H1E104A129	C 0.1UF, 25V	1	
	C5621	F1H1C105A145	C 0.01UF, K, 16V	1	
	C5622	F1J1A475A039	C 4.7UF, K, 10V	1	
	C5623	F1G1H272A571	C 2700UF, 50V	1	
	C5624	F1G1H3320004	C 3300UF, 50V	1	
	C5625	F1G1C273A081	C 0.027UF, K, 16V	1	
	C5626	F1G1C104A116	C 0.10UF, K, 16V	1	
	C5627	F1G1C104A116	C 0.10UF, K, 16V	1	
	C5628	ECGRLOE680ER	C 68UF, J, 2.5V	1	
	C5629	ECGRLOE680ER	C 68UF, J, 2.5V	1	
	C5636	F1G1C104A116	C 0.10UF, K, 16V	1	
	C5637	F1G1C104A116	C 0.10UF, K, 16V	1	
	C5638	F1G1C104A116	C 0.10UF, K, 16V	1	
	C5639	F1G1C104A116	C 0.10UF, K, 16V	1	
	C5640	F1G1C104A116	C 0.10UF, K, 16V	1	
	C5641	F1G1C104A116	C 0.10UF, K, 16V	1	
	C5642	F1K1E106A136	C 10UF, Z, 25V	1	
	C5643	F1H1E104A129	C 0.1UF, 25V	1	
	C5645	F1K1E106A136	C 10UF, Z, 25V	1	
	C5646	F1K1E106A136	C 10UF, Z, 25V	1	
	C5648	F2H0J1010009	C 100UF, 6.3V	1	
	C5649	F1G1C104A116	C 0.10UF, K, 16V	1	
	C5657	F1H1A225A051	C 22UF, 50V	1	
	C5658	F1G1E103A123	C 0.010UF, K, 25V	1	
	C5696	F2G1E470A021	C 47PF, J, 25V	1	
	C5697	F1J1E105A171	C 1 UF 25V	1	
	C5699	F1K1E106A136	C 10UF, Z, 25V	1	
	C5700	F1K1E106A136	C 10UF, Z, 25V	1	
	C5722	F1J1E105A171	C 1 UF 25V	1	
	C5723	F1H1C105A145	C 0.01UF, K, 16V	1	
	C5727	F1G1C104A116	C 0.10UF, K, 16V	1	
	C5728	F1G1C104A116	C 0.10UF, K, 16V	1	
	C8001	F1G1C104A116	C 0.10UF, K, 16V	1	
	C8002	F1H0J1050012	C 1UF, K, 16V	1	
	C8003	F1H0J1050012	C 1UF, K, 16V	1	
	C8004	F1H0J1050012	C 1UF, K, 16V	1	
	C8005	F1H0J1050012	C 1UF, K, 16V	1	
	C8006	F1G1C104A116	C 0.10UF, K, 16V	1	
	C8007	F1G1C104A116	C 0.10UF, K, 16V	1	
	C8008	F1G1C104A116	C 0.10UF, K, 16V	1	
	C8009	F1J1A106A043	C 0.010UF, K, 10V	1	
	C8010	F1J1A106A043	C 0.010UF, K, 10V	1	
	C8011	F1G1C104A116	C 0.10UF, K, 16V	1	
	C8012	F1G1C104A116	C 0.10UF, K, 16V	1	
	C8013	F1G1C104A116	C 0.10UF, K, 16V	1	
	C8014	F1G1C104A116	C 0.10UF, K, 16V	1	
	C8015	F1H0J1050012	C 1UF, K, 16V	1	
	C8016	F1H0J1050012	C 1UF, K, 16V	1	
	C8017	F1J1A106A043	C 0.010UF, K, 10V	1	
	C8018	F1G1C104A116	C 0.10UF, K, 16V	1	
	C8019	F1G1C104A116	C 0.10UF, K, 16V	1	
	C8020	F1G1C104A116	C 0.10UF, K, 16V	1	
	C8021	F1G1C104A116	C 0.10UF, K, 16V	1	
	C8022	F1H0J1050012	C 1UF, K, 16V	1	
	C8023	F1J1A106A043	C 0.010UF, K, 10V	1	
	C8024	F1J1A106A043	C 0.010UF, K, 10V	1	

Safety	Ref. No.	Part No.	Part Name & Description	Pcs	Remarks
	C8025	FIG1C104A116	C 0.10UF, K, 16V	1	
	C8026	FIG1C104A116	C 0.10UF, K, 16V	1	
	C8027	FIG1C104A116	C 0.10UF, K, 16V	1	
	C8028	FIG1C104A116	C 0.10UF, K, 16V	1	
	C8029	FIG1C104A116	C 0.10UF, K, 16V	1	
	C8030	FIH0J1050012	C 1UF, K, 16V	1	
	C8031	FIH0J1050012	C 1UF, K, 16V	1	
	C8032	FIJ1A106A043	C 0.010UF, K, 10V	1	
	C8033	FIG1C104A116	C 0.10UF, K, 16V	1	
	C8034	FIG1C104A116	C 0.10UF, K, 16V	1	
	C8035	FIJ1A106A043	C 0.010UF, K, 10V	1	
	C8036	FIJ1A106A043	C 0.010UF, K, 10V	1	
	C8037	FIG1C104A116	C 0.10UF, K, 16V	1	
	C8038	FIG1C104A116	C 0.10UF, K, 16V	1	
	C8039	FIG1C104A116	C 0.10UF, K, 16V	1	
	C8040	FIG1C104A116	C 0.10UF, K, 16V	1	
	C8041	FIG1C104A116	C 0.10UF, K, 16V	1	
	C8042	ECGRLOG680ER	C 68UF, J, 4V	1	
	C8043	FIG1C104A116	C 0.10UF, K, 16V	1	
	C8044	FIG1C104A116	C 0.10UF, K, 16V	1	
	C8045	FIG1C104A116	C 0.10UF, K, 16V	1	
	C8046	FIG1C104A116	C 0.10UF, K, 16V	1	
	C8047	FIG1C104A116	C 0.10UF, K, 16V	1	
	C8048	FIG1C104A116	C 0.10UF, K, 16V	1	
	C8049	FIG1C104A116	C 0.10UF, K, 16V	1	
	C8050	FIG1C104A116	C 0.10UF, K, 16V	1	
	C8051	FIG1C104A116	C 0.10UF, K, 16V	1	
	C8052	FIH0J1050012	C 1UF, K, 16V	1	
	C8053	FIG1E103A123	C 0.010UF, K, 25V	1	
	C8054	FIG1H150A731	C 15UF, 50V	1	
	C8055	FIG1HR50A577	C 0.50UF, 50V	1	
	C8056	FIG1C104A116	C 0.10UF, K, 16V	1	
	C8057	FIG1C104A116	C 0.10UF, K, 16V	1	
	C8058	FIJ1A106A043	C 0.010UF, K, 10V	1	
	C8067	FIG1E103A123	C 0.010UF, K, 25V	1	
	C8068	FIG1C104A116	C 0.10UF, K, 16V	1	
	C8069	FIG1H820A731	C 82UF, 50V	1	
	C8070	FIG1C104A116	C 0.10UF, K, 16V	1	
	C8071	FIG1C104A116	C 0.10UF, K, 16V	1	
	C8072	FIG1C104A116	C 0.10UF, K, 16V	1	
	C8073	FIG1C104A116	C 0.10UF, K, 16V	1	
	C8074	FIG1C104A116	C 0.10UF, K, 16V	1	
	C8075	FIJ0G2260001	C 0.001UF, 6.3V	1	
	C8076	FIG1C104A116	C 0.10UF, K, 16V	1	
	C8077	FIG1C104A116	C 0.10UF, K, 16V	1	
	C8078	FIG1C104A116	C 0.10UF, K, 16V	1	
	C8079	FIG1C104A116	C 0.10UF, K, 16V	1	
	C8080	FIG1C104A116	C 0.10UF, K, 16V	1	
	C8306	FIG1A4740003	C0.047UF, K, 10V	1	
	C8307	FIG1C104A116	C 0.10UF, K, 16V	1	
	C8309	FIG1C104A116	C 0.10UF, K, 16V	1	
	C8311	FIG1H120A731	C 12UF, 50V	1	
	C8312	FIG1H120A731	C 12UF, 50V	1	
	C8313	FIG1C104A116	C 0.10UF, K, 16V	1	
	C8314	FIG1C104A116	C 0.10UF, K, 16V	1	
	C8316	FIG1C271A117	C 270UF, K, 16V	1	
	C8317	FIG1C271A117	C 270UF, K, 16V	1	
	C8319	FIG1C104A116	C 0.10UF, K, 16V	1	
	C8320	FIG1C104A116	C 0.10UF, K, 16V	1	
	C8321	FIG1C104A116	C 0.10UF, K, 16V	1	
	C8327	FIH1A225A051	C 22UF, 50V	1	
	C8328	FIH1A1050032	C 10UF, 50V	1	
	C8329	FIG1C104A116	C 0.10UF, K, 16V	1	
	C8330	FIG1C104A116	C 0.10UF, K, 16V	1	
	C8331	FIG1C104A116	C 0.10UF, K, 16V	1	
	C8332	FIG1C104A116	C 0.10UF, K, 16V	1	
	C8333	FIG1C104A116	C 0.10UF, K, 16V	1	
	C8334	FIG1C104A116	C 0.10UF, K, 16V	1	

Safety	Ref. No.	Part No.	Part Name & Description	Pcs	Remarks
	C8335	FIG1C104A116	C 0.10UF, K, 16V	1	
	C8336	FIG1C104A116	C 0.10UF, K, 16V	1	
	C8340	FIG1C104A116	C 0.10UF, K, 16V	1	
	C8343	FIG1C104A116	C 0.10UF, K, 16V	1	
	C8344	FIG1C104A116	C 0.10UF, K, 16V	1	
	C8345	FIG1C104A116	C 0.10UF, K, 16V	1	
	C8346	FIG1C104A116	C 0.10UF, K, 16V	1	
	C8405	FIG1C104A116	C 0.10UF, K, 16V	1	
	C8408	FIG1C104A116	C 0.10UF, K, 16V	1	
	C8409	FIG1C104A116	C 0.10UF, K, 16V	1	
	C8410	FIG1C104A116	C 0.10UF, K, 16V	1	
	C8411	F2G1A101A019	E 100UF, 10V	1	
	C8412	FIG1C104A116	C 0.10UF, K, 16V	1	
	C8413	FIG1C104A116	C 0.10UF, K, 16V	1	
	C8414	FIG1C104A116	C 0.10UF, K, 16V	1	
	C8415	FIG1C104A116	C 0.10UF, K, 16V	1	
	C8416	FIG1E103A123	C 0.010UF, K, 25V	1	
	C8417	FIG1E103A123	C 0.010UF, K, 25V	1	
	C8418	FIG1C104A116	C 0.10UF, K, 16V	1	
	C8532	F2G1C470A022	E 47UF, 16V	1	
	C8533	FIG1C104A116	C 0.10UF, K, 16V	1	
	C8535	FIG1C103A116	C 0.010UF, K, 16V	1	
	C8544	FIJ0G2260001	C 0.001UF, 6.3V	1	
	C8555	FIG1C104A116	C 0.10UF, K, 16V	1	
	C8601	FIG1C104A116	C 0.10UF, K, 16V	1	
	C9033	FIG1C104A116	C 0.10UF, K, 16V	1	
	C9034	FIG1C104A116	C 0.10UF, K, 16V	1	
	C9035	FIJ1A106A043	C 0.010UF, K, 10V	1	
	C9036	FIJ1A106A043	C 0.010UF, K, 10V	1	
	C9037	FIG1E103A123	C 0.010UF, K, 25V	1	
	C9040	FIG1C104A116	C 0.10UF, K, 16V	1	
	C9044	FIJ1A475A039	C 4.7UF, K, 10V	1	
	C9045	FIG1C104A116	C 0.10UF, K, 16V	1	
	C9046	FIG1C104A116	C 0.10UF, K, 16V	1	
	C9047	FIG1C104A116	C 0.10UF, K, 16V	1	
	C9048	FIG1C104A116	C 0.10UF, K, 16V	1	
	C9049	FIG1C104A116	C 0.10UF, K, 16V	1	
	C9052	FIG1C104A116	C 0.10UF, K, 16V	1	
	C9053	FIG1C104A116	C 0.10UF, K, 16V	1	
	C9055	FIG1C104A116	C 0.10UF, K, 16V	1	
	C9057	FIG1C104A116	C 0.10UF, K, 16V	1	
	C9061	FIG1C104A116	C 0.10UF, K, 16V	1	
	C9062	FIJ1A475A039	C 4.7UF, K, 10V	1	
	C9063	FIG1C104A116	C 0.10UF, K, 16V	1	
	C9064	FIG1C104A116	C 0.10UF, K, 16V	1	
	C9065	FIG1C104A116	C 0.10UF, K, 16V	1	
	C9066	FIH1E104A129	C 0.1UF, 25V	1	
	C9067	FIK0J226A008	C 22UF, K,6.3V	1	
	C9068	FIK0J226A008	C 22UF, K,6.3V	1	
	C9069	FIG1H222A730	C 2200UF, 50V	1	
	C9071	FIH1E104A129	C 0.1UF, 25V	1	
	C9072	FIK0J226A008	C 22UF, K,6.3V	1	
	C9073	FIK0J226A008	C 22UF, K,6.3V	1	
	C9074	FIG1H222A730	C 2200UF, 50V	1	
	C9076	FIG1C223A116	C 0.022UF, K, 16V	1	
	C9077	FIK1E106A136	C 10UF, Z, 25V	1	
	C9078	FIK1E106A136	C 10UF, Z, 25V	1	
	C9079	FIG1H220A731	C 22UF, 50V	1	
	C9080	FIG1H201A731	C 200 UF, K, 50V	1	
	C9468	FIG1E103A123	C 0.010UF, K, 25V	1	
	C9469	FIG1C104A116	C 0.10UF, K, 16V	1	
	C9535	FIG1C104A116	C 0.10UF, K, 16V	1	
	C9536	FIG1C104A116	C 0.10UF, K, 16V	1	
	C9537	FIG1C104A116	C 0.10UF, K, 16V	1	
	C9538	FIG1C104A116	C 0.10UF, K, 16V	1	
	C9539	FIG1C104A116	C 0.10UF, K, 16V	1	
	C9540	FIG1C104A116	C 0.10UF, K, 16V	1	

Safety	Ref. No.	Part No.	Part Name & Description	Pcs	Remarks
	C9541	F1G1C104A116	C 0.10UF, K, 16V	1	
	C9542	F1G1C104A116	C 0.10UF, K, 16V	1	
	C9543	F1G1C104A116	C 0.10UF, K, 16V	1	
	C9544	F1G1C104A116	C 0.10UF, K, 16V	1	
	C9545	F1G1C104A116	C 0.10UF, K, 16V	1	
	C9546	F1G1C104A116	C 0.10UF, K, 16V	1	
	C9547	F1G1C104A116	C 0.10UF, K, 16V	1	
	C9548	F1G1C104A116	C 0.10UF, K, 16V	1	
	C9549	F1G1C104A116	C 0.10UF, K, 16V	1	
	C9550	F1G1C104A116	C 0.10UF, K, 16V	1	
	C9823	F1K1E106A136	C 10UF, Z, 25V	1	
	C9825	F1G1H101A731	C 100PF, K, 50V	1	
	C9832	F1J1A106A043	C 0.010UF, K, 10V	1	
	C9837	F1J1A106A043	C 0.010UF, K, 10V	1	
	C9840	F1G1E103A123	C 0.010UF, K, 25V	1	
	C9844	F1G1E103A123	C 0.010UF, K, 25V	1	
	C9845	F1G1C104A116	C 0.10UF, K, 16V	1	
	C9846	F1G1C104A116	C 0.10UF, K, 16V	1	
	C9858	F1K1E106A136	C 10UF, Z, 25V	1	
	C9859	F1G1E103A123	C 0.010UF, K, 25V	1	
	C9863	F1G1E472A123	C 4200UF, Z, 25V	1	
	C9869	F1K1E106A136	C 10UF, Z, 25V	1	
	C9872	F1K1E106A136	C 10UF, Z, 25V	1	
	C9874	F1G1H101A731	C 100PF, K, 50V	1	
	C9882	F1G1H201A731	C 200 UF, K, 50V	1	
	C9889	F1J1A106A043	C 0.010UF, K, 10V	1	
	C9892	F1J1A106A043	C 0.010UF, K, 10V	1	
	C9897	F1J1A106A043	C 0.010UF, K, 10V	1	
	C9899	F1J1A106A043	C 0.010UF, K, 10V	1	
	C9900	F1G1C104A116	C 0.10UF, K, 16V	1	
	C9901	F1G1C104A116	C 0.10UF, K, 16V	1	
	C9902	F1G1C104A116	C 0.10UF, K, 16V	1	
	C9903	F1G1C104A116	C 0.10UF, K, 16V	1	
	C9904	F1G1C104A116	C 0.10UF, K, 16V	1	
	C9905	F1G1C104A116	C 0.10UF, K, 16V	1	
	C9906	F1G1C104A116	C 0.10UF, K, 16V	1	
	C9907	F1G1C104A116	C 0.10UF, K, 16V	1	
	C9908	F1G1C104A116	C 0.10UF, K, 16V	1	
	C9909	F1G1C104A116	C 0.10UF, K, 16V	1	
	C9910	F1G1C104A116	C 0.10UF, K, 16V	1	
	C9911	F1G1C104A116	C 0.10UF, K, 16V	1	
	C9912	F1G1C104A116	C 0.10UF, K, 16V	1	
	C9913	F1G1C104A116	C 0.10UF, K, 16V	1	
	C9914	F1G1C104A116	C 0.10UF, K, 16V	1	
	C9915	F1G1C104A116	C 0.10UF, K, 16V	1	
	C9916	F1G1C104A116	C 0.10UF, K, 16V	1	
	C9917	F1G1C104A116	C 0.10UF, K, 16V	1	
	C9918	F1G1C104A116	C 0.10UF, K, 16V	1	
	C9919	F1G1C104A116	C 0.10UF, K, 16V	1	
	C9920	F1G1C104A116	C 0.10UF, K, 16V	1	
	C9921	F1G1C104A116	C 0.10UF, K, 16V	1	
	C9922	F1G1C104A116	C 0.10UF, K, 16V	1	
	C9923	F1G1C104A116	C 0.10UF, K, 16V	1	
	C9924	F1G1C104A116	C 0.10UF, K, 16V	1	
	C9925	F1G1C104A116	C 0.10UF, K, 16V	1	
	C9926	F1J1A106A043	C 0.010UF, K, 10V	1	
	C9927	F1G1C104A116	C 0.10UF, K, 16V	1	
	C9928	F1G1C104A116	C 0.10UF, K, 16V	1	
	C9929	F1G1C104A116	C 0.10UF, K, 16V	1	
	C9930	F1G1C104A116	C 0.10UF, K, 16V	1	
	C9931	F1G1C104A116	C 0.10UF, K, 16V	1	
	C9932	F1G1C104A116	C 0.10UF, K, 16V	1	
	C9933	F1G1C104A116	C 0.10UF, K, 16V	1	
	C9934	F1G1C104A116	C 0.10UF, K, 16V	1	
	C9935	F1G1C104A116	C 0.10UF, K, 16V	1	

Safety	Ref. No.	Part No.	Part Name & Description	Pcs	Remarks
	C9936	F1G1C104A116	C 0.10UF, K, 16V	1	
	C9937	F1G1C104A116	C 0.10UF, K, 16V	1	
	C9938	F1G1C104A116	C 0.10UF, K, 16V	1	
	C9939	F1G1C104A116	C 0.10UF, K, 16V	1	
	C9940	F1G1C104A116	C 0.10UF, K, 16V	1	
	C9941	F1G1C104A116	C 0.10UF, K, 16V	1	
	C9942	F1G1C104A116	C 0.10UF, K, 16V	1	
	C9943	F1G1C104A116	C 0.10UF, K, 16V	1	
	C9944	F1G1C104A116	C 0.10UF, K, 16V	1	
	C9945	F1G1C104A116	C 0.10UF, K, 16V	1	
	C9946	F1G1C104A116	C 0.10UF, K, 16V	1	
	C9947	F1G1C104A116	C 0.10UF, K, 16V	1	
	C9948	F1G1C104A116	C 0.10UF, K, 16V	1	
	C9949	F1G1C104A116	C 0.10UF, K, 16V	1	
	C9950	F1G1C104A116	C 0.10UF, K, 16V	1	
	C9951	F1G1C104A116	C 0.10UF, K, 16V	1	
	C9952	F1G1C104A116	C 0.10UF, K, 16V	1	
	C9953	F1G1C104A116	C 0.10UF, K, 16V	1	
	C9954	F1G1C104A116	C 0.10UF, K, 16V	1	
	C9955	F1G1C104A116	C 0.10UF, K, 16V	1	
	C9956	F1G1C104A116	C 0.10UF, K, 16V	1	
	C9957	F1G1C104A116	C 0.10UF, K, 16V	1	
	C9958	F1G1C104A116	C 0.10UF, K, 16V	1	
	C9959	F1G1C104A116	C 0.10UF, K, 16V	1	
	C9961	F1J1A106A043	C 0.010UF, K, 10V	1	
	C9962	F1J1A106A043	C 0.010UF, K, 10V	1	
	C9965	F1G1C104A116	C 0.10UF, K, 16V	1	
	C9966	F1J1A106A043	C 0.010UF, K, 10V	1	
	C9967	F1G1C104A116	C 0.10UF, K, 16V	1	
	C9968	F1G1C104A116	C 0.10UF, K, 16V	1	
	C9970	F1G1C104A116	C 0.10UF, K, 16V	1	
	C9971	F1G1H180A731	C 18UF, 50V	1	
	C9972	F1G1H180A731	C 18UF, 50V	1	
	C9973	F1G1C104A116	C 0.10UF, K, 16V	1	
	C9974	F1G1C104A116	C 0.10UF, K, 16V	1	
	C9975	F1G1C104A116	C 0.10UF, K, 16V	1	
	C9976	F1G1C104A116	C 0.10UF, K, 16V	1	
	C9977	F1G1C104A116	C 0.10UF, K, 16V	1	
	C9978	F1G1C104A116	C 0.10UF, K, 16V	1	
	C9979	F1G1C104A116	C 0.10UF, K, 16V	1	
	C9980	F1G1C104A116	C 0.10UF, K, 16V	1	
	C16002	F1L2J562A022	C 5600UF, K, 6.3V	1	
	C16012	F2A2T301A004	E 300UF, 220V	1	
	C16013	F0C2E155A252	E 0.015UF, 250V	1	
	C16022	F1L2J562A022	C 5600UF, K, 6.3V	1	
	C16103	F1H1E470A130	C 47UF, K, 25V	1	
	C16104	F1H1E470A130	C 47UF, K, 25V	1	
	C16131	F1L1E4750004	C 4.7UF, 25V	1	
	C16133	F1L1E4750004	C 4.7UF, 25V	1	
	C16135	F1K1E105A029	C 1UF, Z, 25V	1	
	C16191	F1L1E4750004	C 4.7UF, 25V	1	
	C16192	F1H1E104A129	C 0.1UF, 25V	1	
	C16193	EEUFC1E470	E 47UF, 25V	1	
	C16195	F1L1E4750004	C 4.7UF, 25V	1	
	C16198	F1K2J102A014	C 1000UF, K, 6.3V	1	
	C16241	F2A1A101A106	E 100UF, 10V	1	
	C16242	F1H1C105A008	C 1UF, K, 16V	1	
	C16243	F1H1H103A970	C 0.001UF, K, 50V	1	
	C16272	F2A1E471A102	E 470UF, 25V	1	
	C16280	F1K1E105A029	C 1UF, Z, 25V	1	
	C16286	F1H1H104A970	C 0.1UF, K, 50V	1	
	C16287	F1H1H104A970	C 0.1UF, K, 50V	1	
	C16310	F2A2T301A004	E 300UF, 220V	1	
	C16315	F1H1A1050032	C 10UF, 50V	1	
	C16316	F1H1C104A143	C 0.1UF, K, 16V	1	
	C16317	F1H1A1050032	C 10UF, 50V	1	
	C16318	F1J1H104A835	C 0.10UF, 50V	1	
	C16319	F1J1H104A835	C 0.10UF, 50V	1	
	C16328	F2A2D201A226	E 220UF, 200V	1	
	C16401	F1L2J562A022	C 5600UF, K, 6.3V	1	

Safety	Ref. No.	Part No.	Part Name & Description	Pcs	Remarks
	C16412	F0C2E155A252	E 0.015UF, 250V	1	
	C16413	F2A2T301A004	E 300UF, 220V	1	
	C16414	F2A2T301A004	E 300UF, 220V	1	
	C16421	F1L2J562A022	C 5600UF, K, 6.3V	1	
	C16460	F1E2J471A002	C 47PF, 600V	1	
	C16461	F1E2J471A002	C 47PF, 600V	1	
	C16462	F1E2J222A002	C 2200PF, 600V	1	
	C16471	F1L2J1020001	C 1000UF, K, 6.3V	1	
	C16472	FK1E105A029	C 1UF, Z, 25V	1	
	C16490	F1H1C105A008	C 1UF, K, 16V	1	
	C16491	F1L2J1020001	C 1000UF, K, 6.3V	1	
	C16501	FK1E105A029	C 1UF, Z, 25V	1	
	C16502	F1L1E4750004	C 4.7UF, 25V	1	
	C16503	F2A1E471A102	E 470UF, 25V	1	
	C16504	F1L1E4750004	C 4.7UF, 25V	1	
	C16505	FK1E105A029	C 1UF, Z, 25V	1	
	C16521	FK1E105A029	C 1UF, Z, 25V	1	
	C16522	F1L1E4750004	C 4.7UF, 25V	1	
	C16523	F2A1E471A102	E 470UF, 25V	1	
	C16524	F1L1E4750004	C 4.7UF, 25V	1	
	C16525	F1L1E4750004	C 4.7UF, 25V	1	
	C16527	F1L1E4750004	C 4.7UF, 25V	1	
	C16533	F1H1H104A970	C 0.1UF, K, 50V	1	
	C16535	F1H1H104A970	C 0.1UF, K, 50V	1	
	C16536	F1H1H104A970	C 0.1UF, K, 50V	1	
	C16562	F1H1C105A008	C 1UF, K, 16V	1	
	C16563	F2A1A101A106	E 100UF, 10V	1	
	C16564	F1H1C105A008	C 1UF, K, 16V	1	
	C16565	F1H1H103A970	C 0.001UF, K, 50V	1	
	C16566	F1H1H103A970	C 0.001UF, K, 50V	1	
	C16581	FK1E105A029	C 1UF, Z, 25V	1	
	C16582	F1L1E4750004	C 4.7UF, 25V	1	
	C16593	F1H1H102A971	C 1000PF, K, 50V	1	
	C16602	F1H1H220A971	C 22PF, K, 50V	1	
	C16603	FK2J102A014	C 1000UF, K, 6.3V	1	
	C16604	FK2J102A014	C 1000UF, K, 6.3V	1	
	C16608	F1H1H221A971	C 220UF, K, 50V	1	
	C16641	F1E2J332A002	C 3300PF, 600V	1	
	C16642	F1E2J332A002	C 3300PF, 600V	1	
	C16661	FK2J102A014	C 1000UF, K, 6.3V	1	
	C16662	FK2J102A014	C 1000UF, K, 6.3V	1	
	C16664	F1H1H680A971	C 68PF, K, 50V	1	
	C16665	F1H1H680A971	C 68PF, K, 50V	1	
	C16666	F1H1H680A971	C 68PF, K, 50V	1	
	C16675	F1H1H391A971	C 391UF, 50V	1	
	C16684	F1H1H104A970	C 0.1UF, K, 50V	1	
	C16685	F1H1H104A970	C 0.1UF, K, 50V	1	
	C16691	F2A2C101A169	E 1000UF, 160V	1	
	C16707	F1H1H220A971	C 22PF, K, 50V	1	
	C16708	F1H1H104A970	C 0.1UF, K, 50V	1	
	C16721	F2A1H101A128	E 100UF, 50V	1	
	C16723	F1L1E4750004	C 4.7UF, 25V	1	
	C16724	F1L1E4750004	C 4.7UF, 25V	1	
	C16725	F1L1E4750004	C 4.7UF, 25V	1	
	C16753	F1L1E4750004	C 4.7UF, 25V	1	
	C16754	F1L1E4750004	C 4.7UF, 25V	1	
	C16755	F1L1E4750004	C 4.7UF, 25V	1	
	C16756	F1L1E4750004	C 4.7UF, 25V	1	
	C16771	F1H1C105A008	C 1UF, K, 16V	1	
	C16772	F1L1E4750004	C 4.7UF, 25V	1	
	C16773	F1L1E4750004	C 4.7UF, 25V	1	
	C16791	EEUFC1E221	E 220UF, 25V	1	
	C16795	F2A1E471A102	E 470UF, 25V	1	
	C16796	F2A1E471A102	E 470UF, 25V	1	
	C16812	F1L1E4750004	C 4.7UF, 25V	1	
	C16813	F2A2T221A009	E 220UF, 220V	1	
	C16821	FLJ1H104A835	C 0.10UF, 50V	1	
	C16822	F2A2G470A187	E 470UF, 400V	1	
	C16823	F1L2J562A022	C 5600UF, K, 6.3V	1	
	C16842	F2A2C101A169	E 1000UF, 160V	1	
	C16843	FLJ1H104A835	C 0.10UF, 50V	1	
	C16844	FLJ1H104A835	C 0.10UF, 50V	1	

Safety	Ref. No.	Part No.	Part Name & Description	Pcs	Remarks
	C16856	F1H1A1050032	C 10UF, 50V	1	
	C16857	F1H1H472A970	C 4700PF, K, 50V	1	
	C16858	F1H1C104A143	C 0.1UF, K, 16V	1	
	C16860	F1H1A1050032	C 10UF, 50V	1	
	C16861	F1H1C104A143	C 0.1UF, K, 16V	1	
	C16862	F1H1A1050032	C 10UF, 50V	1	
	C16863	FLJ1H104A835	C 0.10UF, 50V	1	
	C16864	FLJ1H104A835	C 0.10UF, 50V	1	
	C16866	F1H1A1050032	C 10UF, 50V	1	
	C16867	F1H1A1050032	C 10UF, 50V	1	
	C16868	F1H1A1050032	C 10UF, 50V	1	
	C16869	FLJ1H104A835	C 0.10UF, 50V	1	
	C16891	FK1E105A029	C 1UF, Z, 25V	1	
	C17121	F1H1A1050032	C 10UF, 50V	1	
	C17123	F1L2E154A028	E 1500UF, 25V	1	
	C17124	F1L2E154A028	E 1500UF, 25V	1	
	C17130	F1H1C104A143	C 0.1UF, K, 16V	1	
	C17131	F1H1A1050032	C 10UF, 50V	1	
	C17133	F1L2E154A028	E 1500UF, 25V	1	
	C17134	F1L2E154A028	E 1500UF, 25V	1	
	C17141	F1H1A1050032	C 10UF, 50V	1	
	C17143	F1L2E154A028	E 1500UF, 25V	1	
	C17144	F1L2E154A028	E 1500UF, 25V	1	
	C17148	F1H1C104A143	C 0.1UF, K, 16V	1	
	C17151	F1H1A1050032	C 10UF, 50V	1	
	C17153	F1L2E154A028	E 1500UF, 25V	1	
	C17154	F1L2E154A028	E 1500UF, 25V	1	
	C17161	F1H1C104A143	C 0.1UF, K, 16V	1	
	C17162	F1H1C104A143	C 0.1UF, K, 16V	1	
	C17211	F1H1A1050032	C 10UF, 50V	1	
	C17212	F1L2E154A028	E 1500UF, 25V	1	
	C17213	F1L2E154A028	E 1500UF, 25V	1	
	C17214	F1H1A1050032	C 10UF, 50V	1	
	C17215	F1L2E154A028	E 1500UF, 25V	1	
	C17221	F1H1A1050032	C 10UF, 50V	1	
	C17223	F1L2E154A028	E 1500UF, 25V	1	
	C17224	F1L2E154A028	E 1500UF, 25V	1	
	C17229	F1H1C104A143	C 0.1UF, K, 16V	1	
	C17230	FK2A105A012	C 1UF, 100V	1	
	C17231	F1H1A1050032	C 10UF, 50V	1	
	C17233	F1L2E154A028	E 1500UF, 25V	1	
	C17234	F1L2E154A028	E 1500UF, 25V	1	
	C17241	F1L2E154A028	E 1500UF, 25V	1	
	C17244	F1H1C104A143	C 0.1UF, K, 16V	1	
	C17270	F1H1C104A143	C 0.1UF, K, 16V	1	
	C17271	F1H1C104A143	C 0.1UF, K, 16V	1	
	C17272	F1H1C104A143	C 0.1UF, K, 16V	1	
	C17273	F1H1C104A143	C 0.1UF, K, 16V	1	
	C17277	F1H1C104A143	C 0.1UF, K, 16V	1	
	C17278	F1H1C104A143	C 0.1UF, K, 16V	1	
	CB1	K1MY55B00001	55P CONNECTOR	1	
	CB2	K1MY55B00001	55P CONNECTOR	1	
	CB3	K1MY55B00001	55P CONNECTOR	1	
	CB4	K1MY55B00001	55P CONNECTOR	1	
	CB5	K1MY55B00001	55P CONNECTOR	1	
	CB6	K1MY55B00001	55P CONNECTOR	1	
	CB7	K1MY55B00001	55P CONNECTOR	1	
	CB8	K1MY55B00001	55P CONNECTOR	1	
	CN0100	K1KA11AA0715	11P CONNECTOR	1	
	CN0101	K1KA20AA0009	20P CONNECTOR	1	
	CN0102	K1KA04AA0104	4P CONNECTOR	1	
	D1107	MA3X704A0L	ZENER DIODE	1	
	D2014	MA2J11100L	DIODE	1	
	D2017	MA2J11100L	DIODE	1	
	D2512	MAZ80560ML	ZENER DIODE	1	
	D2520	B3AGB0000057	LED	1	
	D2524	MAZ80560ML	ZENER DIODE	1	
	D2525	B3ACB0000225	LED	1	PAVCCZ
	D2526	MAZ80560ML	ZENER DIODE	1	
	D2530	MAZ80560ML	ZENER DIODE	1	

Safety	Ref. No.	Part No.	Part Name & Description	Pcs	Remarks
	D2870	B0JCMCE000037	DIODE	1	
	D2871	MA8120M	ZENER DIODE	1	
	D3013	MAZ81400ML	ZENER DIODE	1	
	D3014	MAZ81400ML	ZENER DIODE	1	
	D3048	MA3X7040AL	ZENER DIODE	1	
	D3054	EZJP0V080GA	VARISTOR	1	
	D3201	EZJP0V080GA	VARISTOR	1	
	D3339	MA3X7040AL	ZENER DIODE	1	
	D4512	EZAEG2A50AX	DIODE	1	
	D4513	B0BC5R6A0275	DIODE	1	
	D4517	EZAEG2A50AX	DIODE	1	
	D4518	EZAEG2A50AX	DIODE	1	
	D4520	EZAEG2A50AX	DIODE	1	
	D4525	MA2J11100L	DIODE	1	
	D4526	MA2J11100L	DIODE	1	
	D4541	MA2J11100L	DIODE	1	
	D4542	MA2J11100L	DIODE	1	
	D4575	MA2J11100L	DIODE	1	
	D4576	B0HCMM000014	DIODE	1	
	D4577	B0HCMM000014	DIODE	1	
	D4583	B0HCMM000014	DIODE	1	
	D4587	EZAEG2A50AX	DIODE	1	
	D4588	EZAEG2A50AX	DIODE	1	
	D4589	EZAEG2A50AX	DIODE	1	
	D4590	EZAEG2A50AX	DIODE	1	
	D4591	EZAEG2A50AX	DIODE	1	
	D4592	EZAEG2A50AX	DIODE	1	
	D4593	EZAEG2A50AX	DIODE	1	
	D4594	EZAEG2A50AX	DIODE	1	
	D4595	EZAEG2A50AX	DIODE	1	
	D4596	EZAEG2A50AX	DIODE	1	
	D4597	EZAEG2A50AX	DIODE	1	
	D4598	EZAEG2A50AX	DIODE	1	
	D4599	EZAEG2A50AX	DIODE	1	
	D4600	EZAEG2A50AX	DIODE	1	
	D4601	EZAEG2A50AX	DIODE	1	
	D4602	EZAEG2A50AX	DIODE	1	
	D4611	B0BC5R6A0275	DIODE	1	
	D5481	B0HCMM000014	DIODE	1	
	D5482	B0HCMM000014	DIODE	1	
	D5483	MA3X78900L	ZENER DIODE	1	
	D5485	B0BC03900015	ZENER DIODE	1	
	D5600	B0BC4R700007	ZENER DIODE	1	
	D5603	B0BC6R600005	ZENER DIODE	1	
	D5607	B0BC4R700007	ZENER DIODE	1	
	D5608	B0BC4R700007	ZENER DIODE	1	
	D5612	MAZ80560LL	ZENER DIODE	1	
	D5620	B0BC01100001	ZENER DIODE	1	
	D5621	MA3X152D0L	DIODE	1	
	D5622	MA3X152D0L	DIODE	1	
	D9000	B0JCCE000008	DIODE	1	
	D9110	B0JCGD000002	DIODE	1	
	D16001	B0FBCN000005	DIODE	1	
	D16021	B0FBCN000008	DIODE	1	
	D16101	MA22D3900L	DIODE	1	
	D16131	B0ECKP000047	DIODE	1	
	D16191	B0ECKP000047	DIODE	1	
	D16192	MA2J11100L	DIODE	1	
	D16193	B0ECKP000047	DIODE	1	
	D16194	B0ECKP000047	DIODE	1	
	D16195	B0ECKP000047	DIODE	1	
	D16280	MA2J11100L	DIODE	1	
	D16281	MAZ80510LL	ZENER DIODE	1	
	D16282	MAZ80680ML	ZENER DIODE	1	
	D16285	MA3X152D0L	DIODE	1	
	D16315	MAZ81500ML	ZENER DIODE	1	
	D16316	B0ECKP000047	DIODE	1	
	D16317	B0ECKP000047	DIODE	1	
	D16401	B0FACQ000001	DIODE	1	
	D16407	MA22D3900L	DIODE	1	
	D16411	MA2J11100L	DIODE	1	
	D16421	MA3DF40000LW	ZENER DIODE	1	
	D16441	B0ECHR000001	DIODE	1	

Safety	Ref. No.	Part No.	Part Name & Description	Pcs	Remarks
	D16451	B0ECKP000047	DIODE	1	
	D16461	MA3DF46000LW	ZENER DIODE	1	
	D16473	MA3X152D0L	DIODE	1	
	D16474	MA2J11100L	DIODE	1	
	D16475	MAZ80510LL	ZENER DIODE	1	
	D16476	MA2J11100L	DIODE	1	
	D16478	B0HCKS000002	DIODE	1	
	D16480	MA2J11100L	DIODE	1	
	D16481	B0FACQ000002	DIODE	1	
	D16490	B0ECKP000047	DIODE	1	
	D16491	MA2J11100L	DIODE	1	
	D16492	MAZ80470ML	ZENER DIODE	1	
	D16493	MA3X152E0L	ZENER DIODE	1	
	D16503	B0HCKS000002	DIODE	1	
	D16522	B0ECKP000047	DIODE	1	
	D16524	B0ECKP000047	DIODE	1	
	D16534	B0ECKP000047	DIODE	1	
	D16536	B0HCKS000002	DIODE	1	
	D16583	B3ABB0000210	LED	1	
	D16602	MAZ81500ML	ZENER DIODE	1	
	D16604	MA3X152E0L	ZENER DIODE	1	
	D16605	MAZ80510LL	ZENER DIODE	1	
	D16606	B0ECKM000038	DIODE	1	
	D16607	MA2J11100L	DIODE	1	
	D16608	MA8120M	ZENER DIODE	1	
	D16610	MA2J11100L	DIODE	1	
	D16615	MA2J11100L	DIODE	1	
	D16616	MA3X152E0L	ZENER DIODE	1	
	D16618	B0ECKP000047	DIODE	1	
	D16619	B0ECKP000047	DIODE	1	
	D16620	B0ECKP000047	DIODE	1	
	D16621	MA3DF25000RP	ZENER DIODE	1	
	D16622	MA3DF25000RP	ZENER DIODE	1	
	D16624	B0ECKP000047	DIODE	1	
	D16625	MAZ82000ML	ZENER DIODE	1	
	D16641	B0FBCN000006	DIODE	1	
	D16642	B0FBCN000006	DIODE	1	
	D16662	MAZ83300ML	ZENER DIODE	1	
	D16663	MAZ83300ML	ZENER DIODE	1	
	D16664	MAZ83300ML	ZENER DIODE	1	
	D16670	B0ECHR000001	DIODE	1	
	D16671	MA2J11100L	DIODE	1	
	D16672	B0ECHR000001	DIODE	1	
	D16678	MAZ81500ML	ZENER DIODE	1	
	D16679	B0ECKP000047	DIODE	1	
	D16702	MA2J11100L	DIODE	1	
	D16710	MAZ815000L	ZENER DIODE	1	
	D16711	B0ECHR000001	DIODE	1	
	D16712	MAZ815000L	ZENER DIODE	1	
	D16713	B0ECHR000001	DIODE	1	
	D16714	MAZ815000L	ZENER DIODE	1	
	D16715	B0ECHR000001	DIODE	1	
	D16717	MAZ83300ML	ZENER DIODE	1	
	D16719	B0ECKP000047	DIODE	1	
	D16720	B0ECKP000047	DIODE	1	
	D16721	B0HCKS000002	DIODE	1	
	D16722	MA3DF30000LW	ZENER DIODE	1	
	D16724	B0FBCN000008	DIODE	1	
	D16725	MA2J11100L	DIODE	1	
	D16765	B0HCKS000002	DIODE	1	
	D16791	MAZ82000ML	ZENER DIODE	1	
	D16816	MA8120M	ZENER DIODE	1	
	D16817	MA8120M	ZENER DIODE	1	
	D16820	MA3X152E0L	ZENER DIODE	1	
	D16821	MAZ83600ML	ZENER DIODE	1	
	D16824	MAZ83300ML	ZENER DIODE	1	
	D16825	MAZ83300ML	ZENER DIODE	1	
	D16859	B0HCKS000002	DIODE	1	
	D16860	B0HCKS000002	DIODE	1	
	D16865	B0ECKP000047	DIODE	1	
	D16871	MAZ82000ML	ZENER DIODE	1	
	D16874	MAZ80510LL	ZENER DIODE	1	
	D16875	MA2J11100L	DIODE	1	

Safety	Ref. No.	Part No.	Part Name & Description	Pcs	Remarks
	D16901	MA3X152E0L	ZENER DIODE	1	
	D16920	MA3X152E0L	ZENER DIODE	1	
	FL9803	FL1J1E104A148	C 0.10UF, Z, 25V	1	
	FL9805	FL1J1E104A148	C 0.10UF, Z, 25V	1	
	FL9806	FL1J1E104A148	C 0.10UF, Z, 25V	1	
	GK1	K1KA02BA0061	2P CONNECTOR	1	
	IC1000	C1ZBZ0003775	IC	1	
	IC1100	MNZSFH9GP83	IC	1	
	IC1101	TVRQ387	IC	1	PAVCCZ
	IC2008	C0DBGYY00578	IC	1	
	IC2301	C1AB00002875	IC	1	
	IC2801	C0DBAYY00462	IC	1	
	IC2960	C0DBGHF00001	IC	1	
	IC3001	C1AB00002855	IC	1	
	IC4510	C1AB00003045	IC	1	
	IC4511	C0DBGYY00578	IC	1	
	IC4512	C0CBCAG00039	IC	1	
	IC4513	C0DBGYY00618	IC	1	
	IC5401	C0CBZZE00001	IC	1	
	IC5470	C0EBM0000026	IC	1	
	IC5480	C1ZBZ0003972	IC	1	
	IC5600	C0DBAYY00480	IC	1	
	IC5601	C0DBAYY00480	IC	1	
	IC8001	MN2WS0047	IC	1	
	IC8002	C3ABRY000038	IC	1	
	IC8003	C3ABRY000038	IC	1	
	IC8004	C0ZBZ0001567	IC	1	
	IC8301	C1AB00003049	IC	1	
	IC8302	C0DBFYY00028	IC	1	
	IC8401	C1AB00002913	IC	1	PAVCCZ
	IC8403	C0ZBZ0001584	IC	1	PAVCCZ
	IC8404	C0JBAZ001120	IC	1	
	IC8405	C0JBAZ001120	IC	1	
	IC8408	C0JBAU000025	IC	1	PAVCCZ
	IC8409	C0JBAZ002811	IC	1	
	IC8410	C0JBAU000025	IC	1	PAVCCZ
	IC8411	C0JBAU000025	IC	1	PAVCCZ
	IC8554	TVRQ369AC	IC	1	PAVCCZ
	IC8601	TVRQ408AB	IC	1	PAVCCZ
	IC9001	TVRQ453	IC	1	PAVCCZ
	IC9003	MNZSFH8KPH2	IC	1	
	IC9004	C1ZBZ0003983	IC	1	
	IC9303	TVRQ380	IC	1	PAVCCZ
	IC9500	C1ZBZ0003760	IC	1	
	IC9805	C0DBAYY00477	IC	1	
	IC9806	C0DBAYY00477	IC	1	
	IC9807	C0DBEHG00006	IC	1	
	IC9808	C0CBCAC00365	IC	1	
	IC9900	MN84526	IC	1	
	IC9901	C3ABQY000032	IC	1	
	IC16131	C0ZBZ0000895	IC	1	
	IC16241	C0JBAZ002811	IC	1	
	IC16304	MIP3900MSSCF	IC	1	
	IC16312	C0DBZMC00006	IC	1	
	IC16464	C0JBAB000715	IC	1	
	IC16465	C0JBAB000715	IC	1	
	IC16471	C0DBEKA00003	IC	1	
	IC16490	C0DBZMC00006	IC	1	
	IC16491	NJM2406F	LINEAR IC *	1	
	IC16501	C0ZBZ0001324	IC	1	
	IC16521	C0ZBZ0001324	IC	1	
	IC16561	C0JBAZ001120	IC	1	
	IC16562	C0JBAZ001120	IC	1	
	IC16563	C0JBAC000363	IC	1	
	IC16581	C0BBBA000024	IC	1	
	IC16661	C0BBBA000024	IC	1	
	IC16692	C0DBZMC00006	IC	1	
	IC16724	C0CBADC00072	IC	1	
	IC16725	C0CBADC00072	IC	1	
	IC16771	C0CBADC00072	IC	1	

Safety	Ref. No.	Part No.	Part Name & Description	Pcs	Remarks
	IC16773	C0JBAB000715	IC	1	
	IC16784	MIP9L02MBS	IC	1	
	IC16786	MIP3900MSSCF	IC	1	
	IC16787	C0DBZMC00006	IC	1	
	IC16788	MIP3900MSSCF	IC	1	
	IC16789	C0DBZMC00006	IC	1	
	IC16791	EHMDD9920	LINEAR IC	1	
	IC17101	C0JBAZ002914	IC	1	
	IC17102	C0JBAZ002914	IC	1	
	IC17103	C0JBAZ002914	IC	1	
	IC17104	C0JBAZ002914	IC	1	
	IC17201	C0JBAZ002914	IC	1	
	IC17202	C0JBAZ002914	IC	1	
	IC17205	C0JBAZ002914	IC	1	
	IC17206	C0JBAZ002914	IC	1	
	IC17207	C0JBAZ002914	IC	1	
	IC17208	C0JBAZ002914	IC	1	
	IC17211	C0JBAZ002914	IC	1	
	IC17212	C0JBAZ002914	IC	1	
	JK3002A	K1FY121A0008	CONNECTOR	1	PAVCCZ
	JK3003A	K1FY121A0008	CONNECTOR	1	PAVCCZ
	JK3100A	K2HA7YYA0004	TERMINAL	1	PAVCCZ
	JK3107A	K4AK17B00004	TERMINAL	1	PAVCCZ
	JK4500	K1FY119D0006	CONNECTOR	1	
	JK4501	K1FY119D0006	CONNECTOR	1	
	JK8302	K1NA09E00080	9P CONNECTOR	1	
	JK8401	K1NA68B00051	68P CONNECTOR	1	PAVCCZ
	K1	K1KA07B00135	7P CONNECTOR	1	PAVCCZ
	L1100	J0JYC0000068	CHIP INDUCTOR	1	
	L2001	G1C150KA0038	INDUCTION COIL	1	PAVCCZ
	L2010	G1C220MA0291	INDUCTION COIL	1	
	L2012	G1C220MA0291	INDUCTION COIL	1	
	L2014	G1C220MA0291	INDUCTION COIL	1	
	L2016	G1C220MA0291	INDUCTION COIL	1	
	L2018	J0JHC0000042	CHIP INDUCTOR	1	
	L2023	G1C3R0ZA0156	INDUCTION COIL	1	
	L2032	J0JYC0000068	CHIP INDUCTOR	1	
	L2870	G1C101M00029	INDUCTION COIL	1	
	L2901	J0JCC0000278	CHIP INDUCTOR	1	
	L2902	J0JCC0000269	CHIP INDUCTOR	1	
	L2904	J0JCC0000269	CHIP INDUCTOR	1	
	L3002	J0JCC0000287	CHIP INDUCTOR	1	
	L3003	J0JCC0000287	CHIP INDUCTOR	1	
	L3004	J0JCC0000287	CHIP INDUCTOR	1	
	L3005	J0JCC0000287	CHIP INDUCTOR	1	
	L3006	J0JCC0000287	CHIP INDUCTOR	1	
	L3007	J0JCC0000287	CHIP INDUCTOR	1	
	L3008	J0JCC0000287	CHIP INDUCTOR	1	
	L3009	J0JCC0000287	CHIP INDUCTOR	1	
	L3010	J0JCC0000287	CHIP INDUCTOR	1	
	L3011	J0JCC0000287	CHIP INDUCTOR	1	
	L3014	J0JCC0000287	CHIP INDUCTOR	1	
	L3015	J0JCC0000287	CHIP INDUCTOR	1	
	L3017	J0JCC0000287	CHIP INDUCTOR	1	
	L3018	J0JCC0000287	CHIP INDUCTOR	1	
	L3026	J0JCC0000287	CHIP INDUCTOR	1	
	L3027	J0JCC0000287	CHIP INDUCTOR	1	
	L3028	J0JCC0000287	CHIP INDUCTOR	1	
	L3029	J0JCC0000287	CHIP INDUCTOR	1	
	L3030	J0JCC0000287	CHIP INDUCTOR	1	
	L3034	J0JCC0000364	CHIP INDUCTOR	1	
	L3035	J0JCC0000364	CHIP INDUCTOR	1	
	L4502	J0JYC0000068	CHIP INDUCTOR	1	
	L4503	J0JYC0000068	CHIP INDUCTOR	1	
	L4504	J0JYC0000068	CHIP INDUCTOR	1	
	L4505	J0JYC0000068	CHIP INDUCTOR	1	
	L4506	J0JYC0000068	CHIP INDUCTOR	1	
	L4507	J0JYC0000068	CHIP INDUCTOR	1	
	L4511	J0JYC0000068	CHIP INDUCTOR	1	
	L4512	J0JCC0000059	CHIP INDUCTOR	1	

Safety	Ref. No.	Part No.	Part Name & Description	Pcs	Remarks
	L4513	J0JCC000059	CHIP INDUCTOR	1	
	L4514	J0JYC000068	CHIP INDUCTOR	1	
	L4515	J0JYC000068	CHIP INDUCTOR	1	
	L4516	J0JYC000068	CHIP INDUCTOR	1	
	L4517	J0JYC000068	CHIP INDUCTOR	1	
	L4518	J0JYC000068	CHIP INDUCTOR	1	
	L4519	J0JYC000068	CHIP INDUCTOR	1	
	L5480	J0JYC000068	CHIP INDUCTOR	1	
	L5481	G1C100MA072	INDUCTION COIL	1	
	L5544	G1C470MA0291	INDUCTION COIL	1	
	L5600	G1C2R2Z00007	INDUCTION COIL	1	
	L5601	G1C3R3Z00004	INDUCTION COIL	1	
	L5602	G1C4R7Z00014	INDUCTION COIL	1	
	L5603	G1C6R8Z00008	INDUCTION COIL	1	
	L5604	G1C100MA0203	INDUCTION COIL	1	
	L5605	J0JHC0000075	CHIP INDUCTOR	1	
	L5606	G1C100MA0203	INDUCTION COIL	1	
	L5614	G1C100MA0203	INDUCTION COIL	1	
	L8001	J0JHC0000045	CHIP INDUCTOR	1	
	L8002	J0JHC0000045	CHIP INDUCTOR	1	
	L8003	J0JHC0000045	CHIP INDUCTOR	1	
	L8004	J0JHC0000045	CHIP INDUCTOR	1	
	L8005	J0JHC0000045	CHIP INDUCTOR	1	
	L8007	J0JHC0000045	CHIP INDUCTOR	1	
	L8008	J0JHC0000045	CHIP INDUCTOR	1	
	L8009	J0JHC0000045	CHIP INDUCTOR	1	
	L8010	J0JHC0000045	CHIP INDUCTOR	1	
	L8301	J0JHC0000045	CHIP INDUCTOR	1	
	L8303	G1CR15JA0020	INDUCTION COIL	1	
	L8304	J0JHC0000045	CHIP INDUCTOR	1	
	L8501	J0JHC0000045	CHIP INDUCTOR	1	
	L8551	J0JHC0000075	CHIP INDUCTOR	1	
	L9001	G1C3R3Z00004	INDUCTION COIL	1	
	L9802	G1C6R8Z00008	INDUCTION COIL	1	
	L9900	J0JHC0000117	CHIP INDUCTOR	1	
	L9901	J0JHC0000117	CHIP INDUCTOR	1	
	L9903	J0JHC0000117	CHIP INDUCTOR	1	
	L16011	G0C3R3KA0147	PEAKING COIL	1	
	L16012	G0C3R3KA0147	PEAKING COIL	1	
	L16013	G0C3R3KA0147	PEAKING COIL	1	
	L16014	G0C3R3KA0147	PEAKING COIL	1	
	L16103	G0ZZ00002183	PEAKING COIL	1	
	L16222	G0ZZ00002183	PEAKING COIL	1	
	L16271	G0ZZ00002183	PEAKING COIL	1	
	L16303	G0C471KA0167	PEAKING COIL	1	
	L16401	G0C3R3KA0147	PEAKING COIL	1	
	L16402	G0C3R3KA0147	PEAKING COIL	1	
	L16403	G0C3R3KA0147	PEAKING COIL	1	
	L16404	G0C3R3KA0147	PEAKING COIL	1	
	L16411	G0C3R3KA0147	PEAKING COIL	1	
	L16412	G0C3R3KA0147	PEAKING COIL	1	
	L16413	G0C3R3KA0147	PEAKING COIL	1	
	L16414	G0C3R3KA0147	PEAKING COIL	1	
	L16472	G0ZZ00002183	PEAKING COIL	1	
	L16697	G0C102KA0187	PEAKING COIL	1	
	L16698	G0C681MA0065	PEAKING COIL	1	
	L16699	G0C471KA0167	PEAKING COIL	1	
	L16851	G0ZZ00002183	PEAKING COIL	1	
	PA5600	K5H5022A0031	FUSE	1	
	PC16191	B3PBA0000496	IC	1	
	PC16192	B3PBA0000223	IC	1	
	PC16461	B3PBA0000457	IC	1	
	PC16480	B3PBA0000223	IC	1	
	PC16601	B3PBA0000223	IC	1	
	PC16603	B3PBA0000223	IC	1	
	PC16684	B3PBA0000496	IC	1	
	PC16685	B3PBA0000496	IC	1	
	PC16722	B3PBA0000223	IC	1	
	PC16723	B3PBA0000223	IC	1	
	PC16896	B3PBA0000223	IC	1	

Safety	Ref. No.	Part No.	Part Name & Description	Pcs	Remarks
△	PCB	TXNGK1EQUE	CIRCUIT BOARD GK	1	(RTL) PAVCCZ
△	PCB	A-P37C10B	CIRCUIT BOARD A	1	(RTL) B PAVCCZ
△	PCB	A-P37C10E	CIRCUIT BOARD A	1	(RTL) E PAVCCZ
△	PCB	LSEP1279BEHB	CIRCUIT BOARD P	1	(RTL)
△	PCB	TNPA4890	CIRCUIT BOARD C1	1	(RTL)
△	PCB	TNPA4891	CIRCUIT BOARD C2	1	(RTL)
△	PCB	TXNSC1ERUE	CIRCUIT BOARD SC	1	(RTL) PAVCCZ
△	PCB	TNPA4775	CIRCUIT BOARD SM	1	
△	PCB	TXNSS1ERUE	CIRCUIT BOARD SS	1	(RTL) PAVCCZ
△	PCB	TNPA4806	CIRCUIT BOARD SS2	1	(RTL)
△	PCB	TXN/S1ETUE	CIRCUIT BOARD S	1	(RTL) PAVCCZ
△	PCB	TXN/K1ETUE	CIRCUIT BOARD K	1	(RTL) PAVCCZ
	Q2001	B1ABCF000231	TRANSISTOR	1	
	Q2022	B1ADCE000022	TRANSISTOR	1	
	Q2063	2SD0601ASL	TRANSISTOR	1	
	Q2064	2SD0601ASL	TRANSISTOR	1	
	Q2065	2SB0709ASL	TRANSISTOR	1	
	Q2510	2SD0601ARL	TRANSISTOR	1	
	Q2511	2SD0601ARL	TRANSISTOR	1	
	Q2513	2SD0601ARL	TRANSISTOR	1	
	Q2519	2SD0601ARL	TRANSISTOR	1	
	Q3000	B1ABCF000231	TRANSISTOR	1	
	Q3001	B1ABCF000231	TRANSISTOR	1	
	Q3002	B1ABCF000231	TRANSISTOR	1	
	Q3003	B1ABCF000231	TRANSISTOR	1	
	Q3004	B1ABCF000231	TRANSISTOR	1	
	Q3005	B1ABCF000231	TRANSISTOR	1	
	Q4500	B1ABCF000231	TRANSISTOR	1	
	Q4501	B1ABCF000231	TRANSISTOR	1	
	Q4514	2SB0709ASL	TRANSISTOR	1	
	Q4515	2SB0709ASL	TRANSISTOR	1	
	Q4516	2SB0709ASL	TRANSISTOR	1	
	Q4517	2SB0709ASL	TRANSISTOR	1	
	Q4519	2SB0709ASL	TRANSISTOR	1	
	Q4533	B1ABCF000231	TRANSISTOR	1	
	Q4534	B1ABCF000231	TRANSISTOR	1	
	Q5480	B1ADCE000022	TRANSISTOR	1	
	Q5600	B1MBDDA00003	FET	1	
	Q5601	B1MBDDA00003	FET	1	
	Q5602	B1MBDDA00003	FET	1	
	Q5603	B1MBDDA00003	FET	1	
	Q5606	2SD0601ARL	TRANSISTOR	1	
	Q5607	2SD0601ARL	TRANSISTOR	1	
	Q5608	2SB0709ARL	TRANSISTOR	1	
	Q8200	2SD0601ARL	TRANSISTOR	1	
	Q8401	2SD0601ARL	TRANSISTOR	1	
	Q8402	2SD0601ARL	TRANSISTOR	1	
	Q9000	B1ABCF000231	TRANSISTOR	1	
	Q9001	B1ABCF000231	TRANSISTOR	1	
	Q9002	B1ABCF000231	TRANSISTOR	1	
	Q9003	B1ABCF000231	TRANSISTOR	1	
	Q9004	B1ABCF000231	TRANSISTOR	1	
	Q9301	2SD0601ARL	TRANSISTOR	1	
	Q9302	2SD0601ARL	TRANSISTOR	1	
	Q9807	2SD0601ARL	TRANSISTOR	1	
	Q16001	B1JAEN000005	TRANSISTOR	1	
	Q16002	B1JAEN000005	TRANSISTOR	1	
	Q16021	B1JAEN000004	TRANSISTOR	1	
	Q16022	B1JAEN000004	TRANSISTOR	1	
	Q16101	2SK417300L	FET	1	
	Q16102	2SK399500L	FET	1	
	Q16141	B1HFPPA00001	TRANSISTOR	1	
	Q16161	B1HFPPA00001	TRANSISTOR	1	
	Q16191	B1HFPPA00001	TRANSISTOR	1	
	Q16280	2SD0601ARL	TRANSISTOR	1	

Safety	Ref. No.	Part No.	Part Name & Description	Pcs	Remarks
	Q16401	2PG0090000RP	TRANSISTOR	1	
	Q16402	2PG0090000RP	TRANSISTOR	1	
	Q16421	BIJADP000004	TRANSISTOR	1	
	Q16422	BIJADP000004	TRANSISTOR	1	
	Q16441	BIJAEP000006	TRANSISTOR	1	
	Q16451	BIJADP000003	TRANSISTOR	1	
	Q16471	B1ABCF000231	TRANSISTOR	1	
	Q16490	B1CBGD000001	FET	1	
	Q16501	B1HFFPA00001	TRANSISTOR	1	
	Q16521	B1HFFPA00001	TRANSISTOR	1	
	Q16531	B1HFFPA00001	TRANSISTOR	1	
	Q16551	B1HFFPA00001	TRANSISTOR	1	
	Q16581	B1ABCF000231	TRANSISTOR	1	
	Q16601	B1CERR000025	FET	1	
	Q16602	2SD0601AQL	TRANSISTOR	1	
	Q16603	2SB0709ASL	TRANSISTOR	1	
	Q16604	B1CHPM000001	FET	1	
	Q16606	2SD0601AQL	TRANSISTOR	1	
	Q16607	B1CBGD000001	FET	1	
	Q16621	BIJADN000004	TRANSISTOR	1	
	Q16622	BIJADN000004	TRANSISTOR	1	
	Q16624	2SB0709ASL	TRANSISTOR	1	
	Q16661	BIJAER000003	TRANSISTOR	1	
	Q16662	2SD0601AQL	TRANSISTOR	1	
	Q16663	2SB0709ASL	TRANSISTOR	1	
	Q16667	2SB0709ARL	TRANSISTOR	1	
	Q16670	B1ADCN000007	TRANSISTOR	1	
	Q16671	B1ABCF000231	TRANSISTOR	1	
	Q16672	B1CBGD000001	FET	1	
	Q16673	B1CBGD000001	FET	1	
	Q16674	B1CBGD000001	FET	1	
	Q16675	B1ADCN000007	TRANSISTOR	1	
	Q16676	B1ABCF000231	TRANSISTOR	1	
	Q16701	B1ADCN000007	TRANSISTOR	1	
	Q16702	B1ABCF000231	TRANSISTOR	1	
	Q16762	B1HFFPA00001	TRANSISTOR	1	
	Q16815	B1ABCN000007	TRANSISTOR	1	
	Q16816	2SD0601AQL	TRANSISTOR	1	
	Q16817	B1CBGD000001	FET	1	
	Q16818	B1CBGD000001	FET	1	
	Q16874	B1CBGD000001	FET	1	
	Q16875	B1ABCF000231	TRANSISTOR	1	
	Q16876	B1ABCF000231	TRANSISTOR	1	
	Q16882	B1ABCF000231	TRANSISTOR	1	
	Q16884	2SD0601ARL	TRANSISTOR	1	
	Q16920	B1ABCN000007	TRANSISTOR	1	
	R0180	ERJ2GEJ101	M 100 OHM, J, 0.063W	1	
	R0605	ERJ2GEJ473	M 47KOHM, J, 0.063W	1	
	R0900	ERJ2GEJ680	M 68 OHM, J, 0.063W	1	
	R0901	EXB28V680JX	RESISTOR ARRAY	1	
	R0902	ERJ2GEJ102X	M 1K OHM J 1/4W	1	
	R0905	ERJ2GEJ103	M 10KOHM, J, 0.063W	1	
	R0906	ERJ2GEJ103	M 10KOHM, J, 0.063W	1	
	R0907	ERJ2GEJ103	M 10KOHM, J, 0.063W	1	
	R0909	ERJ2GEJ220	M 22 OHM, J, 0.063W	1	
	R0910	ERJ2GEJ220	M 22 OHM, J, 0.063W	1	
	R0911	ERJ2GEJ220	M 22 OHM, J, 0.063W	1	
	R0912	ERJ2GEJ220	M 22 OHM, J, 0.063W	1	
	R0913	ERJ2GEJ220	M 22 OHM, J, 0.063W	1	
	R0914	ERJ2GEJ220	M 22 OHM, J, 0.063W	1	
	R0915	ERJ2GEJ472	M 4.7KOHM, J, 0.063W	1	

Safety	Ref. No.	Part No.	Part Name & Description	Pcs	Remarks
	R0916	ERJ2GEJ472	M 4.7KOHM, J, 0.063W	1	
	R0917	ERJ2GEJ220	M 22 OHM, J, 0.063W	1	
	R0918	ERJ2GEJ220	M 22 OHM, J, 0.063W	1	
	R0919	ERJ2GEJ220	M 22 OHM, J, 0.063W	1	
	R0920	ERJ2GEJ220	M 22 OHM, J, 0.063W	1	
	R0927	ERJ2GEJ220	M 22 OHM, J, 0.063W	1	
	R0928	ERJ2GEJ220	M 22 OHM, J, 0.063W	1	
	R0929	ERJ2GEJ220	M 22 OHM, J, 0.063W	1	
	R0930	ERJ2GEJ220	M 22 OHM, J, 0.063W	1	
	R0933	DOYAR0000007	M 0 OHM 1/4W	1	
	R0934	DOYAR0000007	M 0 OHM 1/4W	1	
	R0937	ERJ2GEJ472	M 4.7KOHM, J, 0.063W	1	
	R0938	ERJ2GEJ472	M 4.7KOHM, J, 0.063W	1	
	R0939	ERJ2GEJ220	M 22 OHM, J, 0.063W	1	
	R0940	ERJ2GEJ220	M 22 OHM, J, 0.063W	1	
	R0941	DOYAR0000007	M 0 OHM 1/4W	1	
	R0942	DOYAR0000007	M 0 OHM 1/4W	1	
	R0945	ERJ2GEJ220	M 22 OHM, J, 0.063W	1	
	R0946	ERJ2GEJ220	M 22 OHM, J, 0.063W	1	
	R0947	ERJ2GEJ680	M 68 OHM, J, 0.063W	1	
	R0948	ERJ2GEJ680	M 68 OHM, J, 0.063W	1	
	R0949	ERJ2GEJ680	M 68 OHM, J, 0.063W	1	
	R0950	ERJ2GEJ680	M 68 OHM, J, 0.063W	1	
	R0951	ERJ2GEJ680	M 68 OHM, J, 0.063W	1	
	R0952	ERJ2GEJ680	M 68 OHM, J, 0.063W	1	
	R0953	ERJ2GEJ680	M 68 OHM, J, 0.063W	1	
	R0954	ERJ2GEJ680	M 68 OHM, J, 0.063W	1	
	R0955	ERJ2GEJ472	M 4.7KOHM, J, 0.063W	1	
	R0956	ERJ2GEJ472	M 4.7KOHM, J, 0.063W	1	
	R0957	ERJ2GEJ472	M 4.7KOHM, J, 0.063W	1	
	R0958	ERJ2GEJ472	M 4.7KOHM, J, 0.063W	1	
	R0959	ERJ2GEJ472	M 4.7KOHM, J, 0.063W	1	
	R0960	ERJ2GEJ472	M 4.7KOHM, J, 0.063W	1	
	R0961	ERJ2GEJ472	M 4.7KOHM, J, 0.063W	1	
	R0962	ERJ2GEJ472	M 4.7KOHM, J, 0.063W	1	
	R1010	DOGB103JA041	M 10K OHM J 1/16W	1	
	R1146	DOYAR0000007	M 0 OHM 1/4W	1	
	R1153	ERJ2GEJ681	M 680 OHM, J, 0.063W	1	
	R1163	ERJ2GEJ105	M 1MOHM, J, 0.063W	1	
	R1171	ERJ2GEJ683	M 68KOHM, J, 0.063W	1	
	R1172	ERJ2GEJ333	M 33KOHM, J, 0.063W	1	
	R1179	DOYAR0000007	M 0 OHM 1/4W	1	
	R1181	DOYAR0000007	M 0 OHM 1/4W	1	

Safety	Ref. No.	Part No.	Part Name & Description	Pcs	Remarks
	R1182	ERJ2GED273X	M 27KOHM, J, 0.063W	1	
	R1203	ERJ2GEJ473	M 47KOHM, J, 0.063W	1	
	R1209	ERJ2GEJ472	M 4.7KOHM, J, 0.063W	1	
	R1221	D1BB7151A055	M7.15KOHM, 1/10W	1	
	R1224	ERJ2GEJ103	M 10KOHM, J, 0.063W	1	
	R1225	ERJ2GEJ103	M 10KOHM, J, 0.063W	1	
	R1236	ERJ2GEJ473	M 47KOHM, J, 0.063W	1	
	R1237	ERJ2GEJ102X	M 1K OHM J 1/4W	1	
	R1243	ERJ2GEJ473	M 47KOHM, J, 0.063W	1	
	R1255	ERJ2GEJ102X	M 1K OHM J 1/4W	1	
	R1262	ERJ2GEJ473	M 47KOHM, J, 0.063W	1	
	R1400	ERJ2GEJ103	M 10KOHM, J, 0.063W	1	
	R1401	ERJ2GEJ104	M 100KOHM, J, 0.063W	1	
	R1402	ERJ2GEJ683	M 68KOHM, J, 0.063W	1	
	R1403	ERJ2GEJ333	M 33KOHM, J, 0.063W	1	
	R1406	ERJ2GEJ683	M 68KOHM, J, 0.063W	1	
	R1407	ERJ2GEJ473	M 47KOHM, J, 0.063W	1	
	R1410	ERJ2GEJ103	M 10KOHM, J, 0.063W	1	
	R1411	ERJ2GEJ104	M 100KOHM, J, 0.063W	1	
	R2002	ERJ2GEJ471	M 470 OHM, J, 0.063W	1	
	R2003	ERJ2GEJ105	M 1MOHM, J, 0.063W	1	
	R2006	ERJ2GEJ471	M 470 OHM, J, 0.063W	1	
	R2007	ERJ2GEJ221	M 220 OHM, J, 0.063W	1	
	R2008	ERJ2GEJ471	M 470 OHM, J, 0.063W	1	
	R2015	ERJ2GEJ103	M 10KOHM, J, 0.063W	1	
	R2016	ERJ2GEJ103	M 10KOHM, J, 0.063W	1	
	R2017	ERJ2GEJ103	M 10KOHM, J, 0.063W	1	
	R2018	ERJ2GEJ103	M 10KOHM, J, 0.063W	1	
	R2019	D1BB2002A055	M 20KOHM, 1/10W	1	
	R2020	D1BB2001A055	M 2KOHM, 1/10W	1	
	R2023	ERJ2GEJ103	M 10KOHM, J, 0.063W	1	
	R2032	ERJ2GEJ561	M 60 OHM, J, 0.063W	1	
	R2047	D1BB2802A055	M 28KOHM, 1/10W	1	
	R2048	D1BB2802A055	M 28KOHM, 1/10W	1	
	R2050	D1BB2802A055	M 28KOHM, 1/10W	1	
	R2051	D1BB2802A055	M 28KOHM, 1/10W	1	
	R2063	J0JCC0000287	CHIP INDUCTOR	1	
	R2064	J0JCC0000287	CHIP INDUCTOR	1	
	R2092	ERJ2GEJ103	M 10KOHM, J, 0.063W	1	
	R2093	ERJ2GEJ103	M 10KOHM, J, 0.063W	1	
	R2110	ERJ2GEJ101	M 100 OHM, J, 0.063W	1	
	R2111	ERJ2GEJ101	M 100 OHM, J, 0.063W	1	
	R2114	ERJ2GEJ222	M 2.2KOHM, J, 0.063W	1	
	R2115	ERJ2GEJ222	M 2.2KOHM, J, 0.063W	1	
	R2118	ERJ2GEJ471	M 470 OHM, J, 0.063W	1	

Safety	Ref. No.	Part No.	Part Name & Description	Pcs	Remarks
	R2119	ERJ2GEJ105	M 1MOHM, J, 0.063W	1	
	R2120	ERJ2GEJ473	M 47KOHM, J, 0.063W	1	
	R2121	ERJ8GEYJ3R3V	M 3.3 OHM, J, 1/8W	1	
	R2122	ERJ2GEJ101	M 100 OHM, J, 0.063W	1	
	R2123	ERJ8GEYJ3R3V	M 3.3 OHM, J, 1/8W	1	
	R2124	ERJ2GEJ103	M 10KOHM, J, 0.063W	1	
	R2125	ERJ8GEYJ3R3V	M 3.3 OHM, J, 1/8W	1	
	R2127	ERJ8GEYJ3R3V	M 3.3 OHM, J, 1/8W	1	
	R2129	ERJ2GEJ100	M 10 OHM, J, 0.063W	1	
	R2132	ERJ2GEJ471	M 470 OHM, J, 0.063W	1	
	R2137	ERJ2GEJ100	M 10 OHM, J, 0.063W	1	
	R2141	ERJ2GEJ102X	M 1K OHM J 1/4W	1	
	R2142	ERJ2GEJ222	M 2.2KOHM, J, 0.063W	1	
	R2172	ERJ2GEJ680	M 68 OHM, J, 0.063W	1	
	R2190	ERJ2GEJ472	M 4.7KOHM, J, 0.063W	1	
	R2316	EXB28V220J	RESISTOR ARRAY	1	
	R2325	D0YAR0000007	M 0 OHM 1/4W	1	
	R2516	ERJ3GEYJ223	M 22KOHM, J, 1/16W	1	
	R2517	ERJ3GEYJ470	M 47 OHM, J, 1/16W	1	
	R2520	ERJ3GEYJ224	M 220KOHM, J, 1/16W	1	
	R2524	ERJ3GEYJ223	M 22KOHM, J, 1/16W	1	
	R2525	D1BB7500A055	M 750 OHM, 1/10W	1	
	R2530	D0GB473JA057	M 47KOHM, J, 1/16W	1	
	R2531	D1BB2700A055	M 270 OHM, 1/10W	1	
	R2542	D0GB473JA057	M 47KOHM, J, 1/16W	1	
	R2556	D0GB103JA041	M 10K OHM J 1/16W	1	
	R2557	ERJ3GEYJ223	M 22KOHM, J, 1/16W	1	
	R2561	ERJ3GEYJ223	M 22KOHM, J, 1/16W	1	
	R2562	D0GB473JA057	M 47KOHM, J, 1/16W	1	
	R2565	D1BB1001A055	M 1KOHM, 1/16W	1	
	R2581	D0GDR00Z0002	M 0 OHM, 1/10W	1	
	R2756	ERJ2GEJ101	M 100 OHM, J, 0.063W	1	
	R2757	ERJ2GEJ101	M 100 OHM, J, 0.063W	1	
	R2870	ERJ2GEJ390	M 39 OHM, J, 0.063W	1	
	R2871	ERJ2GEJ103	M 10KOHM, J, 0.063W	1	
	R2872	ERJ2GEJ683	M 68KOHM, J, 0.063W	1	
	R2873	D0YAR0000007	M 0 OHM 1/4W	1	
	R2874	ERJ2GEJ103	M 10KOHM, J, 0.063W	1	
	R2875	ERJ2GEJ203X	M 20KOHM, J, 0.063W	1	
	R2905	D0YAR0000007	M 0 OHM 1/4W	1	
	R2909	D0YAR0000007	M 0 OHM 1/4W	1	
	R2915	ERJ2GEJ221	M 220 OHM, J, 0.063W	1	
	R2916	ERJ3GEY0R00	M 0 OHM, 1/16W	1	
	R2930	ERJ2GEJ153	M 15KOHM, J, 0.063W	1	
	R2941	D0YAR0000007	M 0 OHM 1/4W	1	
	R2942	D0YAR0000007	M 0 OHM 1/4W	1	
	R2960	ERJ2GEJ103	M 10KOHM, J, 0.063W	1	
	R3000	ERJ2GEJ223	M 22KOHM, J, 0.063W	1	
	R3001	ERJ2GEJ223	M 22KOHM, J, 0.063W	1	
	R3002	ERJ2GEJ223	M 22KOHM, J, 0.063W	1	

Safety	Ref. No.	Part No.	Part Name & Description	Pcs	Remarks
	R3003	ERJ2GEJ223	M 22KOHM, J, 0.063W	1	
	R3004	ERJ2GEJ223	M 22KOHM, J, 0.063W	1	
	R3005	ERJ2GEJ223	M 22KOHM, J, 0.063W	1	
	R3006	ERJ2GEJ104	M 100KOHM, J, 0.063W	1	
	R3007	ERJ2GEJ104	M 100KOHM, J, 0.063W	1	
	R3008	ERJ2GEJ222	M 2.2KOHM, J, 0.063W	1	
	R3009	ERJ2GEJ222	M 2.2KOHM, J, 0.063W	1	
	R3010	ERJ2GEJ104	M 100KOHM, J, 0.063W	1	
	R3011	ERJ2GEJ104	M 100KOHM, J, 0.063W	1	
	R3012	ERJ2GEJ222	M 2.2KOHM, J, 0.063W	1	
	R3013	ERJ2GEJ222	M 2.2KOHM, J, 0.063W	1	
	R3014	ERJ2GEJ103	M 10KOHM, J, 0.063W	1	
	R3019	ERJ2GEJ222	M 2.2KOHM, J, 0.063W	1	
	R3021	ERJ2GEJ222	M 2.2KOHM, J, 0.063W	1	
	R3024	ERJ2GEJ104	M 100KOHM, J, 0.063W	1	
	R3025	ERJ2GEJ104	M 100KOHM, J, 0.063W	1	
	R3028	ERJ2GEJ331	M 330 OHM, J, 0.063W	1	
	R3029	ERJ2GEJ331	M 330 OHM, J, 0.063W	1	
	R3030	J0JCC0000287	CHIP INDUCTOR	1	
	R3033	ERJ2GEJ221	M 220 OHM, J, 0.063W	1	
	R3034	ERJ2GEJ221	M 220 OHM, J, 0.063W	1	
	R3037	ERJ2GEJ221	M 220 OHM, J, 0.063W	1	
	R3038	ERJ2GEJ221	M 220 OHM, J, 0.063W	1	
	R3041	ERJ2GEJ331	M 330 OHM, J, 0.063W	1	
	R3042	ERJ2GEJ331	M 330 OHM, J, 0.063W	1	
	R3043	ERJ2GEJ221	M 220 OHM, J, 0.063W	1	
	R3045	ERJ2GEJ221	M 220 OHM, J, 0.063W	1	
	R3047	ERJ2GEJ221	M 220 OHM, J, 0.063W	1	
	R3048	ERJ2GEJ221	M 220 OHM, J, 0.063W	1	
	R3049	ERJ2GEJ221	M 220 OHM, J, 0.063W	1	
	R3050	ERJ2GEJ221	M 220 OHM, J, 0.063W	1	
	R3051	ERJ2GEJ221	M 220 OHM, J, 0.063W	1	
	R3052	ERJ2GEJ221	M 220 OHM, J, 0.063W	1	
	R3072	D1BD1500A044	M 150 OHM, 1/10W	1	
	R3073	D1BD1500A044	M 150 OHM, 1/10W	1	
	R3074	D1BD1500A044	M 150 OHM, 1/10W	1	
	R3075	D1BD1500A044	M 150 OHM, 1/10W	1	
	R3076	D1BD1500A044	M 150 OHM, 1/10W	1	
	R3077	D1BD1500A044	M 150 OHM, 1/10W	1	
	R3079	D1BD1500A044	M 150 OHM, 1/10W	1	
	R3081	D1BD1500A044	M 150 OHM, 1/10W	1	
	R3082	D1BD1500A044	M 150 OHM, 1/10W	1	
	R3083	D1BD1500A044	M 150 OHM, 1/10W	1	
	R3084	ERJ6RED750	M 75 OHM, 1/10W	1	
	R3085	ERJ6RED750	M 75 OHM, 1/10W	1	
	R3086	ERJ6RED750	M 75 OHM, 1/10W	1	
	R3087	D1BD1500A044	M 150 OHM, 1/10W	1	

Safety	Ref. No.	Part No.	Part Name & Description	Pcs	Remarks
	R3089	ERJ2GEJ680	M 68 OHM, J, 0.063W	1	
	R3091	ERJ2RKF2152	M 21.5K OHM, J, 2W	1	PAVCCZ
	R3092	ERJ2RKF2152	M 21.5K OHM, J, 2W	1	PAVCCZ
	R3094	ERJ2RKF1302	M 13K OHM, J, 2W	1	
	R3097	D1BD1500A044	M 150 OHM, 1/10W	1	
	R3098	D1BD1500A044	M 150 OHM, 1/10W	1	
	R3100	ERJ2GEJ104	M 100KOHM, J, 0.063W	1	
	R3102	D1BD1500A044	M 150 OHM, 1/10W	1	
	R3104	D1BD1500A044	M 150 OHM, 1/10W	1	
	R3106	ERJ2GED273X	M 27KOHM, J, 0.063W	1	
	R3108	ERJ2GED273X	M 27KOHM, J, 0.063W	1	
	R3112	DOYAR0000007	M 0 OHM 1/4W	1	
	R3113	DOYAR0000007	M 0 OHM 1/4W	1	
	R3115	ERJ2GEJ221	M 220 OHM, J, 0.063W	1	
	R3116	ERJ2GEJ221	M 220 OHM, J, 0.063W	1	
	R3117	ERJ2GEJ221	M 220 OHM, J, 0.063W	1	
	R3118	ERJ2GEJ221	M 220 OHM, J, 0.063W	1	
	R3119	ERJ2GEJ221	M 220 OHM, J, 0.063W	1	
	R3120	ERJ2GEJ331	M 330 OHM, J, 0.063W	1	
	R3121	ERJ6RED750	M 75 OHM, 1/10W	1	
	R3123	ERJ2GEJ221	M 220 OHM, J, 0.063W	1	
	R3128	ERJ2GEJ221	M 220 OHM, J, 0.063W	1	
	R3132	ERJ2GEJ820	M 82 OHM, J, 0.063W	1	
	R3133	ERJ2GEJ820	M 82 OHM, J, 0.063W	1	
	R3134	ERJ2GEJ820	M 82 OHM, J, 0.063W	1	
	R3135	ERJ2GEJ221	M 220 OHM, J, 0.063W	1	
	R3136	ERJ2GEJ221	M 220 OHM, J, 0.063W	1	
	R3137	ERJ2GEJ221	M 220 OHM, J, 0.063W	1	
	R3138	ERJ2GEJ221	M 220 OHM, J, 0.063W	1	
	R3139	ERJ2GEJ221	M 220 OHM, J, 0.063W	1	
	R3140	ERJ2GEJ221	M 220 OHM, J, 0.063W	1	
	R3143	ERJ2GEJ680	M 68 OHM, J, 0.063W	1	
	R3146	ERJ2GEJ331	M 330 OHM, J, 0.063W	1	
	R3150	ERJ2GEJ680	M 68 OHM, J, 0.063W	1	
	R3153	ERJ2GEJ680	M 68 OHM, J, 0.063W	1	
	R3167	ERJ6RED750	M 75 OHM, 1/10W	1	
	R3169	ERJ2GEJ104	M 100KOHM, J, 0.063W	1	
	R3172	ERJ6RED750	M 75 OHM, 1/10W	1	
	R3174	ERJ2GEJ104	M 100KOHM, J, 0.063W	1	
	R3182	ERJ2RKF1302	M 13K OHM, J, 2W	1	
	R3186	D1BD1500A044	M 150 OHM, 1/10W	1	
	R3187	D1BD1500A044	M 150 OHM, 1/10W	1	
	R3188	D1BD1500A044	M 150 OHM, 1/10W	1	
	R3193	D1BD1500A044	M 150 OHM, 1/10W	1	
	R3198	D1BD1500A044	M 150 OHM, 1/10W	1	
	R3204	D1BD1500A044	M 150 OHM, 1/10W	1	
	R3205	D1BD1500A044	M 150 OHM, 1/10W	1	
	R3206	ERJ2GEJ220	M 22 OHM, J, 0.063W	1	

Safety	Ref. No.	Part No.	Part Name & Description	Pcs	Remarks
	R3207	ERJ2GEJ220	M 22 OHM, J, 0.063W	1	
	R3212	D1BD1500A044	M 150 OHM, 1/10W	1	
	R3213	D1BD1500A044	M 150 OHM, 1/10W	1	
	R3236	ERJ2GEJ680	M 68 OHM, J, 0.063W	1	
	R3237	ERJ2GEJ680	M 68 OHM, J, 0.063W	1	
	R3240	ERJ2GEJ221	M 220 OHM, J, 0.063W	1	
	R3245	ERJ2GEJ221	M 220 OHM, J, 0.063W	1	
	R3256	D0GDR00Z0002	M 0 OHM, 1/10W	1	
	R3308	ERJ2GEJ223	M 22KOHM, J, 0.063W	1	
	R3309	ERJ2GEJ223	M 22KOHM, J, 0.063W	1	
	R3770	D1BD1432A044	M14.3KOHM, 1/10W	1	
	R3771	D1BD6651A044	M6.65KOHM, 1/10W	1	
	R3772	D1BD1741A044	M1.74KOHM, 1/10W	1	
	R3775	ERJ6ENF7151	M7.15KOHM, 1/10W	1	
	R4305	ERJ2GEJ473	M 47KOHM, J, 0.063W	1	
	R4306	ERJ2GEJ473	M 47KOHM, J, 0.063W	1	
	R4330	ERJ2GEJ103	M 10KOHM, J, 0.063W	1	
	R4363	ERJ2GEJ103	M 10KOHM, J, 0.063W	1	
	R4364	ERJ2GEJ103	M 10KOHM, J, 0.063W	1	
	R4365	ERJ2GEJ103	M 10KOHM, J, 0.063W	1	
	R4500	ERJ2GEJ103	M 10KOHM, J, 0.063W	1	
	R4501	ERJ2GEJ103	M 10KOHM, J, 0.063W	1	
	R4502	ERJ2RKD330	M 33 OHM, J, 2W	1	
	R4503	ERJ2RKD330	M 33 OHM, J, 2W	1	
	R4504	ERJ2GEJ102X	M 1K OHM J 1/4W	1	
	R4505	ERJ2GEJ102X	M 1K OHM J 1/4W	1	
	R4506	ERJ2GEJ473	M 47KOHM, J, 0.063W	1	
	R4507	ERJ2GEJ473	M 47KOHM, J, 0.063W	1	
	R4524	ERJ2GEJ103	M 10KOHM, J, 0.063W	1	
	R4525	ERJ2GEJ103	M 10KOHM, J, 0.063W	1	
	R4528	ERJ2GEJ103	M 10KOHM, J, 0.063W	1	
	R4529	ERJ2GEJ103	M 10KOHM, J, 0.063W	1	
	R4530	ERJ2GEJ103	M 10KOHM, J, 0.063W	1	
	R4531	ERJ2GEJ103	M 10KOHM, J, 0.063W	1	
	R4532	ERJ2GEJ473	M 47KOHM, J, 0.063W	1	
	R4533	ERJ2GEJ473	M 47KOHM, J, 0.063W	1	
	R4534	ERJ2GEJ473	M 47KOHM, J, 0.063W	1	
	R4538	ERJ2GEJ473	M 47KOHM, J, 0.063W	1	
	R4539	D0YAR0000007	M 0 OHM 1/4W	1	
	R4540	ERJ2GEJ473	M 47KOHM, J, 0.063W	1	
	R4541	D0YAR0000007	M 0 OHM 1/4W	1	
	R4542	D0YAR0000007	M 0 OHM 1/4W	1	
	R4543	D0YAR0000007	M 0 OHM 1/4W	1	
	R4552	ERJ2GEJ220	M 22 OHM, J, 0.063W	1	
	R4587	D1BB60400001	M 604 OHM, 1/10W	1	
	R4588	D1BB8060A055	M 806 OHM, 1/10W	1	
	R4589	D1BB8060A055	M 806 OHM, 1/10W	1	
	R4592	D1BB8060A055	M 806 OHM, 1/10W	1	
	R4593	D1BB2201A055	M 2.2KOHM, 1/10W	1	
	R4596	ERJ6GEYJ102V	M 1K OHM J 1/10W	1	

Safety	Ref. No.	Part No.	Part Name & Description	Pcs	Remarks
	R4597	ERJ6GEYJ102V	M 1K OHM J 1/10W	1	
	R4598	ERJ6GEYJ102V	M 1K OHM J 1/10W	1	
	R4601	ERJ6GEYJ102V	M 1K OHM J 1/10W	1	
	R4605	D1BB2201A055	M 2.2KOHM, 1/10W	1	
	R4607	D0YAR0000007	M 0 OHM 1/4W	1	
	R4608	ERJ6GEYJ102V	M 1K OHM J 1/10W	1	
	R4609	ERJ2GEJ122	M 1.2KOHM, J, 0.063W	1	
	R4613	D0YAR0000007	M 0 OHM 1/4W	1	
	R4614	D0YAR0000007	M 0 OHM 1/4W	1	
	R4615	D0YAR0000007	M 0 OHM 1/4W	1	
	R4616	D0YAR0000007	M 0 OHM 1/4W	1	
	R4620	ERJ2GEJ473	M 47KOHM, J, 0.063W	1	
	R4622	ERJ2GEJ102X	M 1K OHM J 1/4W	1	
	R4623	D0YAR0000007	M 0 OHM 1/4W	1	
	R4624	ERJ2GEJ103	M 10KOHM, J, 0.063W	1	
	R4626	D1BB2200A055	M 220 OHM, 1/10W	1	
	R4627	D1BB2200A055	M 220 OHM, 1/10W	1	
	R4631	D1BB4990A055	M 499 OHM, 1/10W	1	
	R4634	D1BB2200A055	M 220 OHM, 1/10W	1	
	R4635	EXB28V680JX	RESISTOR ARRAY	1	
	R4636	ERJ2GEJ680	M 68 OHM, J, 0.063W	1	
	R4637	ERJ2GEJ473	M 47KOHM, J, 0.063W	1	
	R4638	ERJ2GEJ680	M 68 OHM, J, 0.063W	1	
	R4639	EXB28V680JX	RESISTOR ARRAY	1	
	R4640	EXB28V680JX	RESISTOR ARRAY	1	
	R4641	ERJ2GEJ473	M 47KOHM, J, 0.063W	1	
	R4642	ERJ2GEJ473	M 47KOHM, J, 0.063W	1	
	R4645	ERJ2GEJ680	M 68 OHM, J, 0.063W	1	
	R4646	ERJ2GEJ680	M 68 OHM, J, 0.063W	1	
	R4648	EXB28V330J	RESISTOR ARRAY	1	
	R4649	EXB28V680JX	RESISTOR ARRAY	1	
	R4650	ERJ2GEJ680	M 68 OHM, J, 0.063W	1	
	R4651	ERJ2GEJ680	M 68 OHM, J, 0.063W	1	
	R4652	ERJ2GEJ473	M 47KOHM, J, 0.063W	1	
	R4656	ERJ2GEJ222	M 2.2KOHM, J, 0.063W	1	
	R4664	D1BB60400001	M 604 OHM, 1/10W	1	
	R4665	ERJ2GEJ473	M 47KOHM, J, 0.063W	1	
	R4666	ERJ2GEJ473	M 47KOHM, J, 0.063W	1	
	R4672	ERJ2GEJ473	M 47KOHM, J, 0.063W	1	
	R4674	ERJ2GEJ103	M 10KOHM, J, 0.063W	1	
	R4677	ERJ2GEJ103	M 10KOHM, J, 0.063W	1	
	R4678	EXB28V680JX	RESISTOR ARRAY	1	
	R4679	EXB28V680JX	RESISTOR ARRAY	1	
	R4698	ERJ2GEJ104	M 100KOHM, J, 0.063W	1	
	R4699	ERJ2GEJ104	M 100KOHM, J, 0.063W	1	
	R4700	ERJ2GEJ473	M 47KOHM, J, 0.063W	1	
	R4707	ERJ2GEJ473	M 47KOHM, J, 0.063W	1	
	R4736	ERJ2GEJ473	M 47KOHM, J, 0.063W	1	
	R4738	ERJ2GEJ473	M 47KOHM, J, 0.063W	1	
	R4799	EXB28V680JX	RESISTOR ARRAY	1	
	R5470	ERJ2GEJ222	M 2.2KOHM, J, 0.063W	1	

Safety	Ref. No.	Part No.	Part Name & Description	Pcs	Remarks
	R5471	ERJ2GEJ101	M 100 OHM, J, 0.063W	1	
	R5472	ERJ2GEJ470	M 47 OHM, J, 0.063W	1	
	R5473	ERJ2GEJ473	M 47KOHM, J, 0.063W	1	
	R5474	ERJ2GEJ103	M 10KOHM, J, 0.063W	1	
	R5475	ERJ2GEJ123	M 12KOHM, J, 0.063W	1	
	R5482	ERJ6GEYJ150V	M 15 OHM, J, 1/10W	1	
	R5484	D1BB3902A055	M 39KOHM, 1/10W	1	
	R5488	DOYAR0000007	M 0 OHM 1/4W	1	
	R5489	ERJ2RKD330	M 33 OHM, J, 2W	1	
	R5490	ERJ2GEJ473	M 47KOHM, J, 0.063W	1	
	R5491	ERJ2GEJ473	M 47KOHM, J, 0.063W	1	
	R5492	ERJ2GEJ105	M 1MOHM, J, 0.063W	1	
	R5493	ERJ2GEJ203X	M 20KOHM, J, 0.063W	1	
	R5494	ERJ2GEJ103	M 10KOHM, J, 0.063W	1	
	R5496	ERJ2GEJ680	M 68 OHM, J, 0.063W	1	
	R5541	D1BB1003A055	M 100KOHM, 1/10W	1	
	R5542	D1BB3401A055	M 3.4KOHM, 1/10W	1	
	R5543	ERJ6GEYJ153V	M 15KOHM, J, 1/10W	1	
	R5581	ERJ2GEJ473	M 47KOHM, J, 0.063W	1	
	R5582	ERJ2GEJ473	M 47KOHM, J, 0.063W	1	
	R5600	D1BB3901A055	M 3.9KOHM, 1/10W	1	
	R5604	D1BB2402A055	M 24KOHM, 1/10W	1	
	R5605	D1BB3901A055	M 3.9KOHM, 1/10W	1	
	R5610	D1BB2201A055	M 2.2KOHM, 1/10W	1	
	R5611	D1BB1202A055	M 12KOHM, 1/10W	1	
	R5612	D1BB2002A055	M 20KOHM, 1/10W	1	
	R5613	ERJ2GEJ5R6X	M 5.6 OHM, J, 0.063W	1	
	R5622	ERJ2GEJ5R6X	M 5.6 OHM, J, 0.063W	1	
	R5629	D1BB2101A055	M 2.1KOHM, 1/10W	1	
	R5630	D1BB3301A055	M 3.3KOHM, 1/16W	1	
	R5631	D1BB3901A055	M 3.9KOHM, 1/10W	1	
	R5632	D1BB4021A055	M 4.2KOHM, 1/16W	1	
	R5633	D1BB1202A055	M 12KOHM, 1/10W	1	
	R5634	D1BB1602A055	M 16KOHM, 1/10W	1	
	R5635	ERJ2GEJ223	M 22KOHM, J, 0.063W	1	
	R5636	ERJ2GEJ683	M 68KOHM, J, 0.063W	1	
	R5646	ERJ2GEJ103	M 10KOHM, J, 0.063W	1	
	R5647	ERJ2GEJ473	M 47KOHM, J, 0.063W	1	
	R5657	ERJ2GEJ222	M 2.2KOHM, J, 0.063W	1	
	R5658	ERJ2GEJ473	M 47KOHM, J, 0.063W	1	
	R5659	ERJ2GEJ103	M 10KOHM, J, 0.063W	1	
	R5668	ERJ2GEJ222	M 2.2KOHM, J, 0.063W	1	
	R5669	ERJ2GEJ332	M 3.3KOHM, J, 0.063W	1	
	R5670	ERJ2GEJ102X	M 1K OHM J 1/4W	1	
	R5671	ERJ2GEJ103	M 10KOHM, J, 0.063W	1	
	R5672	ERJ6GEYJ221V	M 220 OHM, J, 1/10W	1	
	R5674	ERJ6GEYJ471	M 470 OHM, J, 1/10W	1	
	R5676	ERJ2GEJ221	M 220 OHM, J, 0.063W	1	
	R5678	ERJ2GEJ471	M 470 OHM, J, 0.063W	1	

Safety	Ref. No.	Part No.	Part Name & Description	Pcs	Remarks
	R8001	ERJ2GEJ221	M 220 OHM, J, 0.063W	1	
	R8002	ERJ2GEJ560X	M 56 OHM, J, 0.063W	1	
	R8004	D1BB2402A055	M 24KOHM, 1/10W	1	
	R8005	D1BB1002A055	M 10KOHM, 1/10W	1	
	R8006	D1BB6801A055	M 6.8KOHM, 1/10W	1	
	R8023	DOYAR0000007	M 0 OHM 1/4W	1	
	R8024	DOYAR0000007	M 0 OHM 1/4W	1	
	R8025	DOYAR0000007	M 0 OHM 1/4W	1	
	R8026	DOYAR0000007	M 0 OHM 1/4W	1	
	R8027	DOYAR0000007	M 0 OHM 1/4W	1	
	R8028	DOYAR0000007	M 0 OHM 1/4W	1	
	R8029	DOYAR0000007	M 0 OHM 1/4W	1	
	R8030	ERJ2GEJ101	M 100 OHM, J, 0.063W	1	
	R8031	D1BB2700A055	M 270 OHM, 1/10W	1	
	R8032	D1BB2700A055	M 270 OHM, 1/10W	1	
	R8035	DOYAR0000007	M 0 OHM 1/4W	1	
	R8036	D0GBR00Z0002	M 0 OHM J 1/16W	1	
	R8039	DOYAR0000007	M 0 OHM 1/4W	1	
	R8056	ERJ2GEJ470	M 47 OHM, J, 0.063W	1	
	R8057	ERJ2GEJ470	M 47 OHM, J, 0.063W	1	
	R8058	ERJ2GEJ470	M 47 OHM, J, 0.063W	1	
	R8059	ERJ2GEJ470	M 47 OHM, J, 0.063W	1	
	R8060	ERJ2GEJ470	M 47 OHM, J, 0.063W	1	
	R8061	ERJ2GEJ470	M 47 OHM, J, 0.063W	1	
	R8062	ERJ2GEJ470	M 47 OHM, J, 0.063W	1	
	R8063	ERJ2GEJ470	M 47 OHM, J, 0.063W	1	
	R8064	ERJ2GEJ470	M 47 OHM, J, 0.063W	1	
	R8065	ERJ2GEJ470	M 47 OHM, J, 0.063W	1	
	R8066	ERJ2GEJ470	M 47 OHM, J, 0.063W	1	
	R8067	ERJ2GEJ470	M 47 OHM, J, 0.063W	1	
	R8068	ERJ2GEJ470	M 47 OHM, J, 0.063W	1	
	R8069	ERJ2GEJ470	M 47 OHM, J, 0.063W	1	
	R8070	ERJ2GEJ470	M 47 OHM, J, 0.063W	1	
	R8071	ERJ2GEJ470	M 47 OHM, J, 0.063W	1	
	R8072	ERJ2GEJ470	M 47 OHM, J, 0.063W	1	
	R8073	ERJ2GEJ470	M 47 OHM, J, 0.063W	1	
	R8074	ERJ2GEJ221	M 220 OHM, J, 0.063W	1	
	R8075	ERJ2GEJ470	M 47 OHM, J, 0.063W	1	
	R8076	ERJ2GEJ470	M 47 OHM, J, 0.063W	1	
	R8077	ERJ2GEJ470	M 47 OHM, J, 0.063W	1	
	R8078	ERJ2GEJ470	M 47 OHM, J, 0.063W	1	
	R8079	DOYAR0000007	M 0 OHM 1/4W	1	
	R8080	DOYAR0000007	M 0 OHM 1/4W	1	
	R8081	ERJ2GEJ103	M 10KOHM, J, 0.063W	1	
	R8082	ERJ2RKF75R0	M 75 OHM, , 0.063W	1	
	R8083	ERJ2GEJ301	M 300 OHM, J, 0.063W	1	
	R8084	DOYAR0000007	M 0 OHM 1/4W	1	
	R8086	ERJ2GEJ104	M 100KOHM, J, 0.063W	1	

Safety	Ref. No.	Part No.	Part Name & Description	Pcs	Remarks
	R8087	ERJ2GEJ103	M 10KOHM, J, 0.063W	1	
	R8090	ERJ2GEJ103	M 10KOHM, J, 0.063W	1	
	R8091	ERJ2GEJ101	M 100 OHM, J, 0.063W	1	
	R8093	ERJ2GEJ470	M 47 OHM, J, 0.063W	1	
	R8095	ERJ2GEJ103	M 10KOHM, J, 0.063W	1	
	R8097	ERJ2GEJ221	M 220 OHM, J, 0.063W	1	
	R8098	ERJ2GEJ103	M 10KOHM, J, 0.063W	1	
	R8099	ERJ2GEJ103	M 10KOHM, J, 0.063W	1	
	R8100	ERJ2GEJ470	M 47 OHM, J, 0.063W	1	
	R8101	ERJ2GEJ103	M 10KOHM, J, 0.063W	1	
	R8106	ERJ2GEJ202	M 2KOHM, J, 0.063W	1	
	R8107	ERJ2GEJ101	M 100 OHM, J, 0.063W	1	
	R8108	ERJ2GEJ223	M 22KOHM, J, 0.063W	1	
	R8244	ERJ2GEJ103	M 10KOHM, J, 0.063W	1	
	R8245	ERJ2GEJ103	M 10KOHM, J, 0.063W	1	
	R8301	EXB2HV220JV	RESISTOR ARRAY	1	
	R8305	ERJ2GEJ102X	M 1K OHM J 1/4W	1	
	R8308	ERJ2GEJ680	M 68 OHM, J, 0.063W	1	
	R8312	ERJ2GEJ102X	M 1K OHM J 1/4W	1	
	R8313	ERJ2GEJ225	M 1MOHM, J, 0.063W	1	
	R8321	ERJ2GEJ103	M 10KOHM, J, 0.063W	1	
	R8322	ERJ2GEJ222	M 2.2KOHM, J, 0.063W	1	
	R8323	ERJ2GEJ222	M 2.2KOHM, J, 0.063W	1	
	R8324	ERJ2GEJ222	M 2.2KOHM, J, 0.063W	1	
	R8325	ERJ2RKD330	M 33 OHM, J, 2W	1	
	R8326	ERJ2GEJ680	M 68 OHM, J, 0.063W	1	
	R8327	ERJ2GEJ680	M 68 OHM, J, 0.063W	1	
	R8328	ERJ2GEJ103	M 10KOHM, J, 0.063W	1	
	R8332	EXB2HV101J	RESISTOR ARRAY	1	
	R8333	EXB2HV101J	RESISTOR ARRAY	1	
	R8335	EXB2HV680J	RESISTOR ARRAY	1	
	R8336	EXB2HV680J	RESISTOR ARRAY	1	
	R8337	EXB28V680JX	RESISTOR ARRAY	1	
	R8338	ERJ2GEJ680	M 68 OHM, J, 0.063W	1	
	R8339	ERJ2GEJ680	M 68 OHM, J, 0.063W	1	
	R8340	D0YAR0000007	M 0 OHM 1/4W	1	
	R8345	ERJ2GEJ103	M 10KOHM, J, 0.063W	1	
	R8347	D0YAR0000007	M 0 OHM 1/4W	1	
	R8353	ERJ2GEJ151	M 150 OHM, J, 0.063W	1	
	R8354	ERJ2GEJ151	M 150 OHM, J, 0.063W	1	
	R8356	D0YAR0000007	M 0 OHM 1/4W	1	
	R8395	ERJ2GEJ103	M 10KOHM, J, 0.063W	1	
	R8404	ERJ2GEJ103	M 10KOHM, J, 0.063W	1	
	R8405	ERJ2GEJ103	M 10KOHM, J, 0.063W	1	
	R8406	D0GFR10JA020	M 1 OHM, J, 0.33W	1	PAVCCZ
	R8407	ERJ2GEJ473	M 47KOHM, J, 0.063W	1	

Safety	Ref. No.	Part No.	Part Name & Description	Pcs	Remarks
	R8410	ERJ2GEJ223	M 22KOHM, J, 0.063W	1	
	R8411	ERJ2GEJ223	M 22KOHM, J, 0.063W	1	
	R8412	ERJ2GEJ103	M 10KOHM, J, 0.063W	1	
	R8416	ERJ2GEJ223	M 22KOHM, J, 0.063W	1	
	R8417	ERJ2GEJ104	M 100KOHM, J, 0.063W	1	
	R8418	ERJ2GEJ681	M 680 OHM, J, 0.063W	1	
	R8421	ERJ2GEJ680	M 68 OHM, J, 0.063W	1	
	R8422	ERJ2GEJ680	M 68 OHM, J, 0.063W	1	
	R8423	ERJ2GEJ680	M 68 OHM, J, 0.063W	1	
	R8424	ERJ2GEJ680	M 68 OHM, J, 0.063W	1	
	R8425	ERJ2GEJ680	M 68 OHM, J, 0.063W	1	
	R8426	EXB2HV680J	RESISTOR ARRAY	1	
	R8428	EXB2HV680J	RESISTOR ARRAY	1	
	R8430	ERJ2GEJ101	M 100 OHM, J, 0.063W	1	
	R8431	ERJ2GEJ151	M 150 OHM, J, 0.063W	1	
	R8432	ERJ2GEJ151	M 150 OHM, J, 0.063W	1	
	R8433	ERJ2GEJ223	M 22KOHM, J, 0.063W	1	
	R8434	ERJ2GEJ473	M 47KOHM, J, 0.063W	1	
	R8435	ERJ2GEJ103	M 10KOHM, J, 0.063W	1	
	R8436	ERJ2GEJ103	M 10KOHM, J, 0.063W	1	
	R8437	EXB2HV104JV	RESISTOR ARRAY	1	
	R8438	ERJ2GEJ104	M 100KOHM, J, 0.063W	1	
	R8439	ERJ2GEJ680	M 68 OHM, J, 0.063W	1	
	R8440	ERJ2GEJ104	M 100KOHM, J, 0.063W	1	
	R8441	EXB2HV680J	RESISTOR ARRAY	1	
	R8442	ERJ2GEJ680	M 68 OHM, J, 0.063W	1	
	R8445	ERJ2GEJ104	M 100KOHM, J, 0.063W	1	
	R8446	ERJ2GEJ680	M 68 OHM, J, 0.063W	1	
	R8449	ERJ2GEJ680	M 68 OHM, J, 0.063W	1	
	R8450	ERJ2GEJ103	M 10KOHM, J, 0.063W	1	
	R8453	EXB2HV680J	RESISTOR ARRAY	1	
	R8454	EXB28V151J	RESISTOR ARRAY	1	
	R8455	EXB2HV680J	RESISTOR ARRAY	1	
	R8456	ERJ2GEJ680	M 68 OHM, J, 0.063W	1	
	R8457	ERJ2GEJ680	M 68 OHM, J, 0.063W	1	
	R8458	ERJ2GEJ680	M 68 OHM, J, 0.063W	1	
	R8459	ERJ2GEJ680	M 68 OHM, J, 0.063W	1	
	R8460	ERJ2GEJ680	M 68 OHM, J, 0.063W	1	
	R8461	ERJ2GEJ680	M 68 OHM, J, 0.063W	1	
	R8463	EXB28V151J	RESISTOR ARRAY	1	
	R8465	ERJ2GEJ103	M 10KOHM, J, 0.063W	1	
	R8466	ERJ2GEJ103	M 10KOHM, J, 0.063W	1	
	R8471	ERJ2GEJ103	M 10KOHM, J, 0.063W	1	
	R8472	EXB2HV103JV	RESISTOR ARRAY	1	
	R8474	EXB28V103JX	RESISTOR ARRAY	1	

Safety	Ref. No.	Part No.	Part Name & Description	Pcs	Remarks
	R8476	ERJ2GEJ103	M 10KOHM, J, 0.063W	1	
	R8477	ERJ2GEJ103	M 10KOHM, J, 0.063W	1	
	R8479	ERJ2GEJ103	M 10KOHM, J, 0.063W	1	
	R8487	EXB28V680JX	RESISTOR ARRAY	1	
	R8488	EXB28V680JX	RESISTOR ARRAY	1	
	R8501	ERJ2GEJ101	M 100 OHM, J, 0.063W	1	
	R8502	ERJ2GEJ331	M 330 OHM, J, 0.063W	1	
	R8503	ERJ2GEJ331	M 330 OHM, J, 0.063W	1	
	R8504	ERJ2GEJ331	M 330 OHM, J, 0.063W	1	
	R8506	ERJ2GEJ331	M 330 OHM, J, 0.063W	1	
	R8508	D1BB91R0A055	M 91 OHM, 1/10W	1	
	R8509	D1BB91R0A055	M 91 OHM, 1/10W	1	
	R8510	D1BB91R0A055	M 91 OHM, 1/10W	1	
	R8512	ERJ2GEJ103	M 10KOHM, J, 0.063W	1	
	R8556	ERJ2GEJ103	M 10KOHM, J, 0.063W	1	
	R8564	ERJ2GEJ103	M 10KOHM, J, 0.063W	1	
	R8566	DOYAR0000007	M 0 OHM 1/4W	1	
	R8567	ERJ2GEJ103	M 10KOHM, J, 0.063W	1	
	R8603	ERJ2GEJ472	M 4.7KOHM, J, 0.063W	1	
	R8605	ERJ2GEJ680	M 68 OHM, J, 0.063W	1	
	R8610	ERJ2GEJ680	M 68 OHM, J, 0.063W	1	
	R8611	ERJ2GEJ680	M 68 OHM, J, 0.063W	1	
	R8612	ERJ2GEJ680	M 68 OHM, J, 0.063W	1	
	R8613	ERJ2GEJ680	M 68 OHM, J, 0.063W	1	
	R8614	ERJ2GEJ680	M 68 OHM, J, 0.063W	1	
	R8615	ERJ2GEJ680	M 68 OHM, J, 0.063W	1	
	R8616	ERJ2GEJ680	M 68 OHM, J, 0.063W	1	
	R8617	ERJ2GEJ680	M 68 OHM, J, 0.063W	1	
	R8657	ERJ2GEJ103	M 10KOHM, J, 0.063W	1	
	R8658	ERJ2GEJ220	M 22 OHM, J, 0.063W	1	
	R8660	DOYAR0000007	M 0 OHM 1/4W	1	
	R8670	ERJ2GEJ222	M 2.2KOHM, J, 0.063W	1	
	R8671	ERJ2GEJ222	M 2.2KOHM, J, 0.063W	1	
	R8674	EXB2HV103JV	RESISTOR ARRAY	1	
	R8675	ERJ2GEJ222	M 2.2KOHM, J, 0.063W	1	
	R8678	ERJ2GEJ222	M 2.2KOHM, J, 0.063W	1	
	R8679	ERJ2GEJ222	M 2.2KOHM, J, 0.063W	1	
	R8680	ERJ2GEJ222	M 2.2KOHM, J, 0.063W	1	
	R8681	ERJ2GEJ222	M 2.2KOHM, J, 0.063W	1	
	R8703	ERJ2GEJ680	M 68 OHM, J, 0.063W	1	
	R8710	ERJ2GEJ680	M 68 OHM, J, 0.063W	1	
	R8711	ERJ2GEJ103	M 10KOHM, J, 0.063W	1	
	R8712	ERJ2GEJ103	M 10KOHM, J, 0.063W	1	
	R8751	ERJ2GEJ103	M 10KOHM, J, 0.063W	1	

Safety	Ref. No.	Part No.	Part Name & Description	Pcs	Remarks
	R8802	ERJ2GEJ680	M 68 OHM, J, 0.063W	1	
	R8803	ERJ2GEJ680	M 68 OHM, J, 0.063W	1	
	R8804	ERJ2GEJ680	M 68 OHM, J, 0.063W	1	
	R8805	ERJ2GEJ680	M 68 OHM, J, 0.063W	1	
	R8806	ERJ2GEJ680	M 68 OHM, J, 0.063W	1	
	R8807	ERJ2GEJ680	M 68 OHM, J, 0.063W	1	
	R8808	ERJ2GEJ680	M 68 OHM, J, 0.063W	1	
	R8855	ERJ2GEJ680	M 68 OHM, J, 0.063W	1	
	R8856	ERJ2GEJ680	M 68 OHM, J, 0.063W	1	
	R8857	ERJ2GEJ680	M 68 OHM, J, 0.063W	1	
	R8858	ERJ2GEJ680	M 68 OHM, J, 0.063W	1	
	R8859	ERJ2GEJ680	M 68 OHM, J, 0.063W	1	
	R8860	ERJ2GEJ680	M 68 OHM, J, 0.063W	1	
	R8861	ERJ2GEJ103	M 10KOHM, J, 0.063W	1	
	R8862	ERJ2GEJ680	M 68 OHM, J, 0.063W	1	
	R8863	ERJ2GEJ680	M 68 OHM, J, 0.063W	1	
	R8864	ERJ2GEJ680	M 68 OHM, J, 0.063W	1	
	R8865	EXB2HV680J	RESISTOR ARRAY	1	
	R8866	EXB2HV680J	RESISTOR ARRAY	1	
	R8867	EXB2HV680J	RESISTOR ARRAY	1	
	R8868	ERJ2GEJ680	M 68 OHM, J, 0.063W	1	
	R8871	ERJ2GEJ103	M 10KOHM, J, 0.063W	1	
	R8873	ERJ2GEJ103	M 10KOHM, J, 0.063W	1	
	R8875	ERJ2GEJ103	M 10KOHM, J, 0.063W	1	
	R8877	ERJ2GEJ680	M 68 OHM, J, 0.063W	1	
	R8878	ERJ2GEJ680	M 68 OHM, J, 0.063W	1	
	R8879	ERJ2GEJ680	M 68 OHM, J, 0.063W	1	
	R8880	ERJ2GEJ680	M 68 OHM, J, 0.063W	1	
	R8882	ERJ2GEJ680	M 68 OHM, J, 0.063W	1	
	R8883	ERJ2GEJ680	M 68 OHM, J, 0.063W	1	
	R8884	ERJ2GEJ680	M 68 OHM, J, 0.063W	1	
	R8885	ERJ2GEJ680	M 68 OHM, J, 0.063W	1	
	R8886	ERJ2GEJ680	M 68 OHM, J, 0.063W	1	
	R8887	ERJ2GEJ680	M 68 OHM, J, 0.063W	1	
	R8888	ERJ2GEJ680	M 68 OHM, J, 0.063W	1	
	R8889	ERJ2GEJ680	M 68 OHM, J, 0.063W	1	
	R8890	ERJ2GEJ680	M 68 OHM, J, 0.063W	1	
	R8891	ERJ2GEJ680	M 68 OHM, J, 0.063W	1	
	R8892	ERJ2GEJ680	M 68 OHM, J, 0.063W	1	
	R8894	ERJ2GEJ680	M 68 OHM, J, 0.063W	1	
	R8896	DOYAR0000007	M 0 OHM 1/4W	1	
	R8898	ERJ2GEJ103	M 10KOHM, J, 0.063W	1	

Safety	Ref. No.	Part No.	Part Name & Description	Pcs	Remarks
	R8900	ERJ2GEJ680	M 68 OHM, J, 0.063W	1	
	R8901	ERJ2GEJ680	M 68 OHM, J, 0.063W	1	
	R8904	ERJ2GEJ103	M 10KOHM, J, 0.063W	1	
	R8905	ERJ2GEJ103	M 10KOHM, J, 0.063W	1	
	R8906	ERJ2GEJ103	M 10KOHM, J, 0.063W	1	
	R8907	ERJ2GEJ103	M 10KOHM, J, 0.063W	1	
	R8908	ERJ2GEJ103	M 10KOHM, J, 0.063W	1	
	R8909	ERJ2GEJ103	M 10KOHM, J, 0.063W	1	
	R8910	ERJ2GEJ103	M 10KOHM, J, 0.063W	1	
	R8927	D0YAR0000007	M 0 OHM 1/4W	1	
	R8935	ERJ2GEJ103	M 10KOHM, J, 0.063W	1	
	R8947	ERJ2GEJ680	M 68 OHM, J, 0.063W	1	
	R8952	EXB2HV680J	RESISTOR ARRAY	1	
	R8953	EXB2HV680J	RESISTOR ARRAY	1	
	R8954	ERJ2GEJ680	M 68 OHM, J, 0.063W	1	
	R8957	ERJ2GEJ103	M 10KOHM, J, 0.063W	1	
	R8958	ERJ2GEJ103	M 10KOHM, J, 0.063W	1	
	R8959	ERJ2GEJ680	M 68 OHM, J, 0.063W	1	
	R8960	ERJ2GEJ680	M 68 OHM, J, 0.063W	1	
	R8963	ERJ2GEJ103	M 10KOHM, J, 0.063W	1	
	R9062	ERJ2GEJ101	M 100 OHM, J, 0.063W	1	
	R9063	ERJ2GEJ101	M 100 OHM, J, 0.063W	1	
	R9064	ERJ2GEJ101	M 100 OHM, J, 0.063W	1	
	R9065	ERJ2GEJ101	M 100 OHM, J, 0.063W	1	
	R9066	ERJ2GEJ101	M 100 OHM, J, 0.063W	1	
	R9067	ERJ2GEJ101	M 100 OHM, J, 0.063W	1	
	R9068	ERJ2GEJ103	M 10KOHM, J, 0.063W	1	
	R9070	ERJ2GEJ103	M 10KOHM, J, 0.063W	1	
	R9071	ERJ2GEJ223	M 22KOHM, J, 0.063W	1	
	R9072	ERJ2GEJ102X	M 1K OHM J 1/4W	1	
	R9073	ERJ2GEJ472	M 4.7KOHM, J, 0.063W	1	
	R9077	D1BB1302A055	M 13KOHM, 1/10W	1	
	R9078	D1BB4302A055	M 43KOHM, 1/10W	1	
	R9079	D1BB2702A055	M 27KOHM, 1/10W	1	
	R9080	D1BB1502A055	M 15KOHM, 1/10W	1	
	R9081	D1BB4702A055	M 47KOHM, 1/10W	1	
	R9098	ERJ2GEJ472	M 4.7KOHM, J, 0.063W	1	
	R9099	ERJ2GEJ101	M 100 OHM, J, 0.063W	1	
	R9100	ERJ2GEJ473	M 47KOHM, J, 0.063W	1	
	R9101	ERJ2GEJ333	M 33KOHM, J, 0.063W	1	
	R9102	ERJ2GEJ101	M 100 OHM, J, 0.063W	1	
	R9104	ERJ2GEJ472	M 4.7KOHM, J, 0.063W	1	
	R9105	ERJ2GEJ103	M 10KOHM, J, 0.063W	1	
	R9106	ERJ2GEJ104	M 100KOHM, J, 0.063W	1	

Safety	Ref. No.	Part No.	Part Name & Description	Pcs	Remarks
	R9107	ERJ2GEJ332	M 3.3KOHM, J, 0.063W	1	
	R9108	ERJ2GEJ103	M 10KOHM, J, 0.063W	1	
	R9109	ERJ2GEJ103	M 10KOHM, J, 0.063W	1	
	R9110	ERJ2GEJ101	M 100 OHM, J, 0.063W	1	
	R9112	ERJ2GEJ103	M 10KOHM, J, 0.063W	1	
	R9113	ERJ2GEJ104	M 100KOHM, J, 0.063W	1	
	R9114	ERJ2GEJ472	M 4.7KOHM, J, 0.063W	1	
	R9115	ERJ2GEJ101	M 100 OHM, J, 0.063W	1	
	R9116	ERJ2GEJ101	M 100 OHM, J, 0.063W	1	
	R9117	ERJ2GEJ103	M 10KOHM, J, 0.063W	1	
	R9118	ERJ2GEJ103	M 10KOHM, J, 0.063W	1	
	R9119	EXB38V470J	RESISTOR ARRAY	1	
	R9120	ERJ2GEJ101	M 100 OHM, J, 0.063W	1	
	R9121	ERJ2GEJ104	M 100KOHM, J, 0.063W	1	
	R9122	ERJ2GEJ472	M 4.7KOHM, J, 0.063W	1	
	R9123	ERJ2GEJ472	M 4.7KOHM, J, 0.063W	1	
	R9124	ERJ2GEJ470	M 47 OHM, J, 0.063W	1	
	R9129	ERJ2GEJ683	M 68KOHM, J, 0.063W	1	
	R9130	ERJ2GEJ470	M 47 OHM, J, 0.063W	1	
	R9142	ERJ2GEJ101	M 100 OHM, J, 0.063W	1	
	R9145	ERJ2GEJ101	M 100 OHM, J, 0.063W	1	
	R9149	ERJ2GEJ472	M 4.7KOHM, J, 0.063W	1	
	R9154	ERJ2RHD272	M 2.7KOHM, J, 2W	1	
	R9155	ERJ2RHD272	M 2.7KOHM, J, 2W	1	
	R9164	ERJ2GEJ103	M 10KOHM, J, 0.063W	1	
	R9166	ERJ2GEJ103	M 10KOHM, J, 0.063W	1	
	R9187	ERJ2RHD272	M 2.7KOHM, J, 2W	1	
	R9188	ERJ2RHD272	M 2.7KOHM, J, 2W	1	
	R9189	ERJ2GEJ103	M 10KOHM, J, 0.063W	1	
	R9202	ERJ2GEJ101	M 100 OHM, J, 0.063W	1	
	R9203	ERJ2GEJ223	M 22KOHM, J, 0.063W	1	
	R9205	ERJ2GEJ333	M 33KOHM, J, 0.063W	1	
	R9206	ERJ2GED563X	M 56KOHM, J, 0.063W	1	
	R9207	ERJ2GEJ243	M 24KOHM, J, 0.063W	1	
	R9210	ERJ2GEJ473	M 47KOHM, J, 0.063W	1	
	R9211	ERJ2RHD272	M 2.7KOHM, J, 2W	1	
	R9214	ERJ2RHD272	M 2.7KOHM, J, 2W	1	
	R9215	ERJ2GEJ104	M 100KOHM, J, 0.063W	1	
	R9223	ERJ2RHD272	M 2.7KOHM, J, 2W	1	
	R9225	ERJ2RHD272	M 2.7KOHM, J, 2W	1	
	R9317	ERJ2GEJ102X	M 1K OHM J 1/4W	1	
	R9347	EXB2HV220JV	RESISTOR ARRAY	1	
	R9348	EXB2HV220JV	RESISTOR ARRAY	1	
	R9350	ERJ2GEJ470	M 47 OHM, J, 0.063W	1	
	R9351	ERJ2GEJ470	M 47 OHM, J, 0.063W	1	
	R9352	EXB2HV220JV	RESISTOR ARRAY	1	

Safety	Ref. No.	Part No.	Part Name & Description	Pcs	Remarks
	R9353	EXB2HV220JV	RESISTOR ARRAY	1	
	R9354	EXB2HV220JV	RESISTOR ARRAY	1	
	R9355	EXB2HV220JV	RESISTOR ARRAY	1	
	R9356	EXB2HV220JV	RESISTOR ARRAY	1	
	R9357	EXB2HV220JV	RESISTOR ARRAY	1	
	R9358	EXB2HV330JV	RESISTOR ARRAY	1	
	R9359	EXB2HV330JV	RESISTOR ARRAY	1	
	R9360	ERJ2GEJ332	M 3.3KOHM, J,0.063W	1	
	R9361	ERJ2GEJ470	M 47 OHM, J,0.063W	1	
	R9362	ERJ2GEJ470	M 47 OHM, J,0.063W	1	
	R9363	ERJ2GEJ103	M 10KOHM, J,0.063W	1	
	R9369	ERJ2GEJ472	M 4.7KOHM, J,0.063W	1	
	R9370	ERJ2GEJ103	M 10KOHM, J,0.063W	1	
	R9371	ERJ2GEJ104	M 100KOHM, J,0.063W	1	
	R9385	ERJ2GEJ472	M 4.7KOHM, J,0.063W	1	
	R9391	ERJ2GEJ104	M 100KOHM, J,0.063W	1	
	R9396	ERJ2GEJ470	M 47 OHM, J,0.063W	1	
	R9397	ERJ2GEJ470	M 47 OHM, J,0.063W	1	
	R9398	ERJ2GEJ470	M 47 OHM, J,0.063W	1	
	R9399	ERJ2GEJ470	M 47 OHM, J,0.063W	1	
	R9401	ERJ2GEJ102X	M 1K OHM J 1/4W	1	
	R9402	ERJ2GEJ470	M 47 OHM, J,0.063W	1	
	R9403	EXB2HV103JV	RESISTOR ARRAY	1	
	R9404	EXB2HV103JV	RESISTOR ARRAY	1	
	R9405	EXB2HV103JV	RESISTOR ARRAY	1	
	R9406	EXB2HV103JV	RESISTOR ARRAY	1	
	R9407	D0GDR00Z0002	M 0 OHM, 1/10W	1	
	R9408	D0GDR00Z0002	M 0 OHM, 1/10W	1	
	R9578	ERJ2GEJ472	M 4.7KOHM, J,0.063W	1	
	R9586	ERJ2GEJ470	M 47 OHM, J,0.063W	1	
	R9587	ERJ2GEJ470	M 47 OHM, J,0.063W	1	
	R9592	D0GA103JA015	M 10KOHM, J, 1/16W	1	
	R9594	ERJ2GEJ103	M 10KOHM, J,0.063W	1	
	R9598	ERJ2GEJ470	M 47 OHM, J,0.063W	1	
	R9604	ERJ2GEJ103	M 10KOHM, J,0.063W	1	
	R9608	EXB2HV470JV	RESISTOR ARRAY	1	
	R9609	EXB28V470JX	RESISTOR ARRAY	1	
	R9610	EXB2HV470JV	RESISTOR ARRAY	1	
	R9611	ERJ2GEJ680	M 68 OHM, J,0.063W	1	
	R9616	ERJ2GEJ470	M 47 OHM, J,0.063W	1	
	R9618	ERJ2GEJ331	M 330 OHM, J,0.063W	1	
	R9839	EXB38V101JV	RESISTOR ARRAY	1	
	R9848	EXB2HV470JV	RESISTOR ARRAY	1	
	R9849	EXB2HV470JV	RESISTOR ARRAY	1	
	R9868	ERJ2GEJ104	M 100KOHM, J,0.063W	1	
	R9871	ERJ2GEJ103	M 10KOHM, J,0.063W	1	
	R9872	D1BB1002A055	M 10KOHM, 1/10W	1	
	R9873	ERJ14YJ120	M 12 OHM, J, 1/4W	1	
	R9893	D1BB2702A055	M 27KOHM, 1/10W	1	
	R9894	D1BB2002A055	M 20KOHM, 1/10W	1	
	R9895	D1BB11030002	M 110KOHM, 1/10W	1	
	R9896	D1BB4702A055	M 47KOHM, 1/10W	1	

Safety	Ref. No.	Part No.	Part Name & Description	Pcs	Remarks
	R9897	ERJ2GEJ103	M 10KOHM, J,0.063W	1	
	R9898	ERJ2GEJ103	M 10KOHM, J,0.063W	1	
	R9899	ERJ2GEJ103	M 10KOHM, J,0.063W	1	
	R9900	ERJ14YJ120	M 12 OHM, J, 1/4W	1	
	R9902	D0GBR00Z0002	M 0 OHM J 1/16W	1	
	R9903	EXB2HV470JV	RESISTOR ARRAY	1	
	R9905	ERJ2RKD330	M 33 OHM, J, 2W	1	
	R9906	EXB38V470J	RESISTOR ARRAY	1	
	R9907	ERJ2GEJ151	M 150 OHM, J,0.063W	1	
	R9936	D1BB1001A055	M 1KOHM, 1/16W	1	
	R9937	D1BB1001A055	M 1KOHM, 1/16W	1	
	R9938	D1BB1001A055	M 1KOHM, 1/16W	1	
	R9939	D1BB1001A055	M 1KOHM, 1/16W	1	
	R9940	ERJ2RKD330	M 33 OHM, J, 2W	1	
	R9943	EXB2HV470JV	RESISTOR ARRAY	1	
	R9944	EXB38V470J	RESISTOR ARRAY	1	
	R9945	EXB38V470J	RESISTOR ARRAY	1	
	R9946	EXB38V470J	RESISTOR ARRAY	1	
	R9947	EXB38V470J	RESISTOR ARRAY	1	
	R9948	EXB38V470J	RESISTOR ARRAY	1	
	R9949	EXB38V470J	RESISTOR ARRAY	1	
	R9950	EXB38V470J	RESISTOR ARRAY	1	
	R9951	EXB38V470J	RESISTOR ARRAY	1	
	R9952	ERJ2GEJ470	M 47 OHM, J,0.063W	1	
	R9953	ERJ2GEJ470	M 47 OHM, J,0.063W	1	
	R9954	ERJ2GEJ470	M 47 OHM, J,0.063W	1	
	R9955	ERJ2GEJ470	M 47 OHM, J,0.063W	1	
	R9966	ERJ2GEJ471	M 470 OHM, J,0.063W	1	
	R9967	ERJ2GEJ470	M 47 OHM, J,0.063W	1	
	R9968	ERJ2GEJ470	M 47 OHM, J,0.063W	1	
	R9969	ERJ2GEJ470	M 47 OHM, J,0.063W	1	
	R9970	ERJ2GEJ470	M 47 OHM, J,0.063W	1	
	R9972	ERJ2GEJ103	M 10KOHM, J,0.063W	1	
	R9975	ERJ2GEJ470	M 47 OHM, J,0.063W	1	
	R9977	ERJ2GEJ470	M 47 OHM, J,0.063W	1	
	R9983	ERJ2GEJ470	M 47 OHM, J,0.063W	1	
	R9987	ERJ2GEJ470	M 47 OHM, J,0.063W	1	
	R9988	ERJ2GEJ470	M 47 OHM, J,0.063W	1	
	R9989	ERJ2GEJ470	M 47 OHM, J,0.063W	1	
	R9990	ERJ2GEJ101	M 100 OHM, J,0.063W	1	
	R16001	D0GF7R5JA047	M 7.5 OHM, J, 0.33W	1	
	R16002	D0GF7R5JA047	M 7.5 OHM, J, 0.33W	1	
	R16021	D0GF7R5JA047	M 7.5 OHM, J, 0.33W	1	
	R16022	D0GF7R5JA047	M 7.5 OHM, J, 0.33W	1	
	R16101	D0GD221JA059	M 220 OHM, J, 1/ 10W	1	
	R16102	D0GD221JA059	M 220 OHM, J, 1/ 10W	1	
	R16103	D0GD100JA059	M 10 OHM, J, 0.25W	1	
	R16104	D0GD100JA059	M 10 OHM, J, 0.25W	1	
	R16105	ERJ8GEYJ474	M 470KOHM, J, 1/ 8W	1	
	R16109	D0GD100JA059	M 10 OHM, J, 0.25W	1	

Safety	Ref. No.	Part No.	Part Name & Description	Pcs	Remarks
	R16110	ERJ6GEYF473	M 47KOHM,J,1/10W	1	
	R16116	ERJ6GEYF473	M 47KOHM,J,1/10W	1	
	R16131	D0GD101JA036	M 100 OHM,J,0.25W	1	
	R16132	D0GD101JA036	M 100 OHM,J,0.25W	1	
	R16134	D0GD750JA059	M 75 OHM,J,0.25W	1	
	R16137	D0GF1R0JA047	M 1.0 OHM,J,0.33W	1	
	R16141	D0GD100JA059	M 10 OHM,J,0.25W	1	
	R16142	ERJ6GEYF473	M 47KOHM,J,1/10W	1	
	R16143	ERJ6GEYF473	M 47KOHM,J,1/10W	1	
	R16161	D0GD100JA059	M 10 OHM,J,0.25W	1	
	R16162	ERJ6GEYF473	M 47KOHM,J,1/10W	1	
	R16163	ERJ6GEYF473	M 47KOHM,J,1/10W	1	
	R16191	ERJ6GEYJ151V	M 150 OHM,J,1/10W	1	
	R16192	ERJ6GEYJ103V	M 10K OHM J 1/10W	1	
	R16193	ERJ6GEYJ750	M 75 OHM,J,1/10W	1	
	R16194	D0GF7R5JA047	M 7.5 OHM,J,0.33W	1	
	R16195	D0GF1R0JA047	M 1.0 OHM,J,0.33W	1	
	R16196	D0GF7R5JA047	M 7.5 OHM,J,0.33W	1	
	R16241	EXB38V470J	RESISTOR ARRAY	1	
	R16242	EXB38V472JV	RESISTOR ARRAY	1	
	R16280	ERJ6GEYJ222V	M 2.2K OHM J 1/10W	1	
	R16281	D0GD103JA036	M 10KOHM,J,0.25W	1	
	R16282	ERJ6GEYJ221V	M 220 OHM,J,1/10W	1	
	R16283	ERJ6GEYF473	M 47KOHM,J,1/10W	1	
	R16284	ERJ6GEYJ224	M 220KOHM,J,1/10W	1	
	R16285	EXB38V623J	RESISTOR ARRAY	1	
	R16289	D0GF334JA047	M 330KOHM,F,0.33W	1	
	R16290	D0GF334JA047	M 330KOHM,F,0.33W	1	
	R16302	ERJ8GEYJ333	M 33KOHM, J,1/8W	1	
	R16307	ERJ6RBD513	M 5.1KOHM,J,1/10W	1	
	R16309	ERJ8GEYJ333	M 33KOHM, J,1/8W	1	
	R16310	ERJ8GEYJ333	M 33KOHM, J,1/8W	1	
	R16311	ERJ8GEYJ333	M 33KOHM, J,1/8W	1	
	R16317	ERJ6RBD243	M 2.4KOHM,J,1/10W	1	
	R16318	ERJ6RBD433	M 4.3KOHM,J,1/10W	1	
	R16319	ERJ6RBD242	M 2.4KOHM,J,1/10W	1	
	R16320	ERJ14YJ683	M 68KOHM, 1/2W	1	
	R16330	ERJ6GEYJ102V	M 1K OHM J 1/10W	1	
	R16332	ERJ6GEYJ474	M 470KOHM,J,1/10W	1	
	R16334	ERJ6GEYJ472V	M 4.7K OHM J 1/10W	1	
	R16335	ERJ6GEYJ102V	M 1K OHM J 1/10W	1	
	R16401	ERJT08J7R5V	M 7.5OHM,J,0.33W	1	
	R16402	ERJT08J7R5V	M 7.5OHM,J,0.33W	1	
	R16410	ERJ6GEYJ391	M 390 OHM,F,1/10W	1	
	R16411	D1BD2700A044	M 270 OHM, 1/10W	1	
	R16414	ERJ6GEYJ331V	M 330 OHM J 1/10W	1	
	R16415	ERJ6GEYJ331V	M 330 OHM J 1/10W	1	
	R16416	D0GD103JA036	M 10KOHM,J,0.25W	1	
	R16421	ERJT08J7R5V	M 7.5OHM,J,0.33W	1	
	R16422	ERJT08J7R5V	M 7.5OHM,J,0.33W	1	
	R16441	ERJT08J5R6V	M 5.6 OHM,F,0.33W	1	

Safety	Ref. No.	Part No.	Part Name & Description	Pcs	Remarks
	R16451	ERJT08J5R6V	M 5.6 OHM,F,0.33W	1	
	R16471	ERJ6GEYJ392	M 3.9KOHM,J,1/10W	1	
	R16472	ERJ6GEYJ222V	M 2.2K OHM J 1/10W	1	
	R16473	ERJ6GEYF561	M 560 OHM,F,1/10W	1	
	R16474	ERJ6GEYJ102V	M 1K OHM J 1/10W	1	
	R16475	ERJ6GEYJ472V	M 4.7K OHM J 1/10W	1	
	R16476	ERJ6GEYJ472V	M 4.7K OHM J 1/10W	1	
	R16478	ERJ6GEYJ562V	M 5.6KOHM,J,1/10W	1	
	R16479	D0GD103JA036	M 10KOHM,J,0.25W	1	
	R16480	ERJ6GEYJ472V	M 4.7K OHM J 1/10W	1	
	R16490	ERJ6RBD104	M 100KOHM, 1/10W	1	
	R16491	ERJ6RED114	M 110KOHM, 1/10W	1	
	R16492	ERJ6RED124	M 120KOHM, 1/10W	1	
	R16493	ERJ6RBD4221	M 4.22KOHM, 1/10W	1	
	R16494	D1BD2001A044	M 2KOHM, 1/10W	1	
	R16495	D1BD3900A044	M 390 OHM, 1/10W	1	
	R16496	ERJ6GEYJ470V	M 47 OHM,J,1/10W	1	
	R16497	ERJ6GEYF473	M 47KOHM,J,1/10W	1	
	R16498	ERJ6GEYJ103V	M 10K OHM J 1/10W	1	
	R16501	D0GD101JA036	M 100 OHM,J,0.25W	1	
	R16502	D0GD101JA036	M 100 OHM,J,0.25W	1	
	R16503	ERJT06J100V	M 10 OHM,F,0.25W	1	
	R16504	ERJT06J750V	M 75 OHM,F,0.25W	1	
	R16506	ERJT06J100V	M 10 OHM,F,0.25W	1	
	R16510	ERJT14J1ROU	M 1.0 OHM, J,1/4W	1	
	R16511	ERJ6GEYF473	M 47KOHM,J,1/10W	1	
	R16512	ERJ6GEYF473	M 47KOHM,J,1/10W	1	
	R16516	ERJ6GEYF473	M 47KOHM,J,1/10W	1	
	R16517	ERJ6GEYF473	M 47KOHM,J,1/10W	1	
	R16521	D0GD101JA036	M 100 OHM,J,0.25W	1	
	R16522	D0GD101JA036	M 100 OHM,J,0.25W	1	
	R16523	ERJT06J750V	M 75 OHM,F,0.25W	1	
	R16524	ERJT06J750V	M 75 OHM,F,0.25W	1	
	R16531	ERJT06J100V	M 10 OHM,F,0.25W	1	
	R16532	ERJ6GEYF473	M 47KOHM,J,1/10W	1	
	R16533	ERJ6GEYF473	M 47KOHM,J,1/10W	1	
	R16534	ERJT08J1ROV	M 1.8OHM,J,0.33W	1	
	R16536	ERJT08J1ROV	M 1.8OHM,J,0.33W	1	
	R16551	ERJT06J100V	M 10 OHM,F,0.25W	1	
	R16552	ERJ6GEYF473	M 47KOHM,J,1/10W	1	
	R16553	ERJ6GEYF473	M 47KOHM,J,1/10W	1	
	R16561	EXB38V470J	RESISTOR ARRAY	1	
	R16562	EXB38V470J	RESISTOR ARRAY	1	
	R16563	EXB38V470J	RESISTOR ARRAY	1	
	R16564	EXB38V470J	RESISTOR ARRAY	1	
	R16565	EXB38V472JV	RESISTOR ARRAY	1	
	R16566	EXB38V472JV	RESISTOR ARRAY	1	
	R16567	EXB38V472JV	RESISTOR ARRAY	1	
	R16568	EXB38V472JV	RESISTOR ARRAY	1	
	R16570	ERJ6GEYJ472V	M 4.7K OHM J 1/10W	1	
	R16579	ERJ6GEYJ470V	M 47 OHM,J,1/10W	1	
	R16580	ERJ6GEYJ222V	M 2.2K OHM J 1/10W	1	
	R16582	ERJT08J393V	M 39 KOHM,J,0.33W	1	PAVCCZ
	R16583	ERJT08J393V	M 39 KOHM,J,0.33W	1	PAVCCZ
	R16584	D1BD6811A044	M6.81KOHM, 1/10W	1	
	R16585	D1BD1001A044	M 1KOHM, 1/10W	1	
	R16586	D1BD1691A044	M1.69KOHM, 1/10W	1	

Safety	Ref. No.	Part No.	Part Name & Description	Pcs	Remarks
	R16587	ERJ6GEYJ222V	M 2.2K OHM J 1/10W	1	
	R16588	DOGD103JA036	M 10KOHM,J,0.25W	1	
	R16589	DOGD103JA036	M 10KOHM,J,0.25W	1	
	R16590	ERJ6GEYJ221V	M 220 OHM,J,1/10W	1	
	R16591	EXB38V472JV	RESISTOR ARRAY	1	
	R16592	ERJ6GEYJ472V	M 4.7K OHM J 1/10W	1	
	R16593	D1BD1331A044	M 1.33K OHM 1/10W	1	
	R16602	ERJ6GEYJ102V	M 1K OHM J 1/10W	1	
	R16604	ERJ6GEYJ331V	M 330 OHM J 1/10W	1	
	R16605	ERJ6GEYJ182	M 1.8KOHM,J,1/10W	1	
	R16606	DOGD103JA036	M 10KOHM,J,0.25W	1	
	R16607	D1BD6651A044	M6.65KOHM, 1/10W	1	
	R16608	ERJT08J102V	M 1KOHM,J, 0.33W	1	
	R16609	ERJT08J102V	M 1KOHM,J, 0.33W	1	
	R16610	ERJ6GEYJ104V	M 100KOHM,J,1/10W	1	
	R16611	ERJ8GEYJ683	M 68KOHM, J,1/8W	1	
	R16612	ERJT06J470V	M 47 OHM,F,0.25W	1	
	R16613	ERJ8GEYJ473	M 47KOHM, J,1/8W	1	
	R16614	ERJ8GEYJ683	M 68KOHM, J,1/8W	1	
	R16615	D1BD1131A044	M1.13KOHM, 1/10W	1	
	R16617	ERJ6GEYJ222V	M 2.2K OHM J 1/10W	1	
	R16619	ERJT08J1R0V	M 1.8OHM,J, 0.33W	1	
	R16621	ERJT06J221V	M 220 OHM,F,0.25W	1	
	R16622	ERJT06J221V	M 220 OHM,F,0.25W	1	
	R16627	ERJ6GEYJ220	M 22 OHM,J,1/10W	1	
	R16628	ERJ6GEYF473	M 47KOHM,J,1/10W	1	
	R16631	DOGD103JA036	M 10KOHM,J,0.25W	1	
	R16633	ERJ6GEYJ223	M 22KOHM,J,1/10W	1	
	R16634	ERJ6GEYJ471	M 470 OHM,J,1/10W	1	
	R16658	D1BD8661A044	M86.6KOHM, 1/10W	1	
	R16661	ERJ6GEYJ122V	M 1.2KOHM,J,1/10W	1	
	R16663	D1BD5231A044	M5.23KOHM, 1/10W	1	
	R16664	ERJT08J102V	M 1KOHM,J, 0.33W	1	
	R16665	ERJT06J330V	M 33 OHM,F,0.25W	1	
	R16666	DOGD103JA036	M 10KOHM,J,0.25W	1	
	R16673	ERJ6GEYJ472V	M 4.7K OHM J 1/10W	1	
	R16674	ERJT08J102V	M 1KOHM,J, 0.33W	1	
	R16675	ERJ6GEYJ472V	M 4.7K OHM J 1/10W	1	
	R16679	D1BD1002A044	M10.0KOHM, 1/10W	1	
	R16680	D1BD7501A044	M 7.5KOHM, 1/10W	1	
	R16681	ERJT06J100V	M 10 OHM,F,0.25W	1	
	R16682	ERJT06J100V	M 10 OHM,F,0.25W	1	
	R16684	ERJ6GEYJ221V	M 220 OHM,J,1/10W	1	
	R16685	ERJ6GEYJ221V	M 220 OHM,J,1/10W	1	
	R16686	DOGD103JA036	M 10KOHM,J,0.25W	1	
	R16691	ERJ8GEYJ563	M 56KOHM, J,1/8W	1	
	R16692	ERJ6RBD152	M 1.5KOHM,J,1/10W	1	
	R16694	ERJ8GEYJ563	M 56KOHM, J,1/8W	1	
	R16695	ERJ6RBD152	M 1.5KOHM,J,1/10W	1	
	R16696	ERF5TK2R2	W 2.2 OHM, K, 5W	1	
	R16699	DOGD103JA036	M 10KOHM,J,0.25W	1	
	R16707	ERJ6GEYJ392	M 3.9KOHM,J,1/10W	1	
	R16711	ERJ6GEYJ472V	M 4.7K OHM J 1/10W	1	
	R16712	ERJ6GEYJ102V	M 1K OHM J 1/10W	1	
	R16713	ERG1FJS104D	M 100KOHM, J, 1W	1	
	R16714	ERJ6GEYF473	M 47KOHM,J,1/10W	1	

Safety	Ref. No.	Part No.	Part Name & Description	Pcs	Remarks
	R16715	ERJ6GEYJ103V	M 10K OHM J 1/10W	1	
	R16717	ERJ6GEYJ102V	M 1K OHM J 1/10W	1	
	R16720	ERJ3GEYJ220	M 22 OHM,J,1/16W	1	
	R16721	ERJ3GEYJ220	M 22 OHM,J,1/16W	1	
	R16722	ERJ3GEYJ220	M 22 OHM,J,1/16W	1	
	R16723	ERJ3GEYJ220	M 22 OHM,J,1/16W	1	
	R16731	ERG2FJS104D	M 100KOHM, J, 2W	1	
	R16733	ERJ6GEYJ474	M 470KOHM,J,1/10W	1	
	R16734	D1BD4991A044	M4.99KOHM, 1/10W	1	
	R16735	D1BD1873A044	M 187KOHM, 1/10W	1	
	R16736	D1BD1873A044	M 187KOHM, 1/10W	1	
	R16737	D1BD2053A044	M 205KOHM, 1/10W	1	
	R16744	D1BD1273A044	M 127KOHM, 1/10W	1	
	R16749	DOGD103JA036	M 10KOHM,J,0.25W	1	
	R16750	ERJT06J123	M 12KOHM,F,0.25W	1	
	R16751	ERJT06J154V	M 150KOHM,F,0.25W	1	
	R16752	ERJ6GEYJ472V	M 4.7K OHM J 1/10W	1	
	R16753	ERJ6GEYJ224	M 220KOHM,J,1/10W	1	
	R16755	ERJT06J123	M 12KOHM,F,0.25W	1	
	R16756	ERJT06J123	M 12KOHM,F,0.25W	1	
	R16761	ERJT06J100V	M 10 OHM,F,0.25W	1	
	R16762	ERJ6GEYF473	M 47KOHM,J,1/10W	1	
	R16763	ERJ6GEYF473	M 47KOHM,J,1/10W	1	
	R16765	ERJT08J1R0V	M 1.8OHM,J, 0.33W	1	
	R16766	DOGDR00Z0002	M 0 OHM, 1/10W	1	
	R16769	ERJT06J750V	M 75 OHM,F,0.25W	1	
	R16772	ERJ6GEYJ472V	M 4.7K OHM J 1/10W	1	
	R16773	ERJ6GEYJ102V	M 1K OHM J 1/10W	1	
	R16774	ERG1SJ273	M 27KOHM, J, 1W	1	
	R16775	ERJ6GEYJ472V	M 4.7K OHM J 1/10W	1	
	R16776	ERJ6GEYJ470V	M 47 OHM,J,1/10W	1	
	R16777	ERJ6GEYJ103V	M 10K OHM J 1/10W	1	
	R16783	ERJT06J154V	M 150KOHM,F,0.25W	1	
	R16785	D1BD1003A044	M 100KOHM, 1/10W	1	
	R16786	D1BD1003A044	M 100KOHM, 1/10W	1	
	R16787	D1BD3302A044	M 33KOHM, 1/10W	1	
	R16789	DOGD103JA036	M 10KOHM,J,0.25W	1	
	R16791	ERJ6GEYJ102V	M 1K OHM J 1/10W	1	
	R16794	D1BD2003A044	M 200KOHM, 1/10W	1	
	R16795	D1BD2003A044	M 200KOHM, 1/10W	1	
	R16796	D1BD5602A044	M 56KOHM, 1/10W	1	
	R16806	ERJ6GEYJ102V	M 1K OHM J 1/10W	1	
	R16811	ERJ6RBD152	M 1.5KOHM,J,1/10W	1	
	R16822	ERJ6ENF8202	M 82KOHM, 1/10W	1	
	R16823	ERJ6ENF8202	M 82KOHM, 1/10W	1	
	R16824	D1BD3302A044	M 33KOHM, 1/10W	1	
	R16825	ERJT06J154V	M 150KOHM,F,0.25W	1	
	R16826	DOGD103JA036	M 10KOHM,J,0.25W	1	
	R16829	ERJ6GEYJ102V	M 1K OHM J 1/10W	1	
	R16831	D1BD7152A044	M71.5KOHM, 1/10W	1	
	R16832	D1BD7152A044	M71.5KOHM, 1/10W	1	
	R16833	DOGD103JA036	M 10KOHM,J,0.25W	1	
	R16838	ERJ14YJ563U	M 56KOHM, 1/2W	1	
	R16841	ERJ14YJ563U	M 56KOHM, 1/2W	1	
	R16844	D1BD1241A044	M1.24KOHM, 1/10W	1	
	R16845	D1BD7152A044	M71.5KOHM, 1/10W	1	
	R16846	ERJ6ENF8202	M 82KOHM, 1/10W	1	
	R16847	ERJ6GEYJ472V	M 4.7K OHM J 1/10W	1	
	R16848	ERJ6GEYJ472V	M 4.7K OHM J 1/10W	1	
	R16851	ERJ6GEYJ474	M 470KOHM,J,1/10W	1	
	R16860	D0D28R2JA021	M 8.2 OHM,J,2W	1	

Safety	Ref. No.	Part No.	Part Name & Description	Pcs	Remarks
	R16869	ERJ8GEYJ473	M 47KOHM, J,1/8W	1	
	R16870	ERJ14YJ683	M 68KOHM, 1/2W	1	
	R16873	D1BD2491A044	M2.49KOHM, 1/10W	1	
	R16877	ERJ6GEYJG681	M 680 OHM,J,1/10W	1	
	R16886	ERJ6GEYJ224	M 220KOHM,J,1/10W	1	
	R16887	ERJ6GEYJ224	M 220KOHM,J,1/10W	1	
	R16888	ERJ6GEYJ224	M 220KOHM,J,1/10W	1	
	R16891	D1BD4702A044	M 47KOHM, 1/10W	1	
	R16892	D1BD4702A044	M 47KOHM, 1/10W	1	
	R16893	D1BD4702A044	M 47KOHM, 1/10W	1	
	R16894	D1BD4702A044	M 47KOHM, 1/10W	1	
	R16895	D1BD4702A044	M 47KOHM, 1/10W	1	
	R16896	D1BD3302A044	M 33KOHM, 1/10W	1	
	R16897	D1BD2741A044	M2.74KOHM, 1/10W	1	
	R16899	D1BD1471A044	M1.47KOHM, 1/10W	1	
	R16904	ERJ6GEYJ223	M 22KOHM,J,1/10W	1	
	R16920	D0GD103JA036	M 10KOHM,J,0.25W	1	
	R16921	D1BD1741A044	M1.74KOHM, 1/10W	1	
	R16922	D1BD3001A044	M 3KOHM, 1/10W	1	
	R16923	D0GD103JA036	M 10KOHM,J,0.25W	1	
	R16926	ERJ6GEYJ222V	M 2.2K OHM J 1/10W	1	
	R16927	ERJ6GEYJ223	M 22KOHM,J,1/10W	1	
	R17101	EXB38V470J	RESISTOR ARRAY	1	
	R17102	ERJ3GEYJ470	M 47 OHM,J,1/16W	1	
	R17103	EXB38V471J	RESISTOR ARRAY	1	
	R17104	ERJ3GEYJ471	M 470 OHM,J,1/16W	1	
	R17105	ERJ3GEYJ470	M 47 OHM,J,1/16W	1	
	R17106	ERJ3GEYJ471	M 470 OHM,J,1/16W	1	
	R17107	EXB38V470J	RESISTOR ARRAY	1	
	R17108	ERJ3GEYJ470	M 47 OHM,J,1/16W	1	
	R17109	EXB38V471J	RESISTOR ARRAY	1	
	R17110	ERJ3GEYJ471	M 470 OHM,J,1/16W	1	
	R17111	ERJ3GEYJ470	M 47 OHM,J,1/16W	1	
	R17112	ERJ3GEYJ471	M 470 OHM,J,1/16W	1	
	R17115	ERJ3GEY0R00	M 0 OHM, 1/16W	1	
	R17119	EXB38V470J	RESISTOR ARRAY	1	
	R17125	ERJ3GEY0R00	M 0 OHM, 1/16W	1	
	R17126	D0GZ6R8JA020	M 6.8 OHM,J,0.5W	1	
	R17127	D0GZ6R8JA020	M 6.8 OHM,J,0.5W	1	
	R17135	ERJ3GEY0R00	M 0 OHM, 1/16W	1	
	R17136	D0GZ6R8JA020	M 6.8 OHM,J,0.5W	1	
	R17137	D0GZ6R8JA020	M 6.8 OHM,J,0.5W	1	
	R17145	ERJ3GEY0R00	M 0 OHM, 1/16W	1	
	R17146	D0GZ6R8JA020	M 6.8 OHM,J,0.5W	1	
	R17147	D0GZ6R8JA020	M 6.8 OHM,J,0.5W	1	
	R17155	EXB38V102J	RESISTOR ARRAY	1	
	R17156	D0GZ6R8JA020	M 6.8 OHM,J,0.5W	1	
	R17157	D0GZ6R8JA020	M 6.8 OHM,J,0.5W	1	
	R17159	EXB38V470J	RESISTOR ARRAY	1	
	R17161	D0GDR00Z0002	M 0 OHM, 1/10W	1	
	R17177	EXB38V102J	RESISTOR ARRAY	1	
	R17180	ERJ3GEYJ470	M 47 OHM,J,1/16W	1	
	R17184	EXB38V470J	RESISTOR ARRAY	1	
	R17185	D0GB102JA041	M 1KOHM,J,1/16W	1	
	R17191	D0GF472JA047	M 4.7KOHM,J,0.33W	1	
	R17192	ERJ6GEYJ224	M 220KOHM,J,1/10W	1	
	R17194	ERJ3GEY0R00	M 0 OHM, 1/16W	1	
	R17195	ERJ3GEY0R00	M 0 OHM, 1/16W	1	

Safety	Ref. No.	Part No.	Part Name & Description	Pcs	Remarks
	R17196	ERJ6GEYJ102V	M 1K OHM J 1/10W	1	
	R17201	EXB38V470J	RESISTOR ARRAY	1	
	R17202	ERJ3GEYJ470	M 47 OHM,J,1/16W	1	
	R17203	EXB38V471J	RESISTOR ARRAY	1	
	R17204	ERJ3GEYJ471	M 470 OHM,J,1/16W	1	
	R17205	ERJ3GEYJ470	M 47 OHM,J,1/16W	1	
	R17206	ERJ3GEYJ471	M 470 OHM,J,1/16W	1	
	R17207	EXB38V470J	RESISTOR ARRAY	1	
	R17208	ERJ3GEYJ470	M 47 OHM,J,1/16W	1	
	R17209	EXB38V471J	RESISTOR ARRAY	1	
	R17210	ERJ3GEYJ471	M 470 OHM,J,1/16W	1	
	R17215	ERJ3GEYJ470	M 47 OHM,J,1/16W	1	
	R17216	D0GZ6R8JA020	M 6.8 OHM,J,0.5W	1	
	R17217	D0GZ6R8JA020	M 6.8 OHM,J,0.5W	1	
	R17219	ERJ6GEYJ224	M 220KOHM,J,1/10W	1	
	R17220	ERJ3GEYJ471	M 470 OHM,J,1/16W	1	
	R17223	D0GZ6R8JA020	M 6.8 OHM,J,0.5W	1	
	R17224	D0GZ6R8JA020	M 6.8 OHM,J,0.5W	1	
	R17225	EXB38V470J	RESISTOR ARRAY	1	
	R17226	D0GZ6R8JA020	M 6.8 OHM,J,0.5W	1	
	R17227	D0GZ6R8JA020	M 6.8 OHM,J,0.5W	1	
	R17228	ERJ3GEYJ470	M 47 OHM,J,1/16W	1	
	R17229	EXB38V471J	RESISTOR ARRAY	1	
	R17230	ERJ3GEYJ471	M 470 OHM,J,1/16W	1	
	R17235	ERJ3GEYJ470	M 47 OHM,J,1/16W	1	
	R17236	D0GZ6R8JA020	M 6.8 OHM,J,0.5W	1	
	R17237	D0GZ6R8JA020	M 6.8 OHM,J,0.5W	1	
	R17239	ERJ3GEYJ471	M 470 OHM,J,1/16W	1	
	R17240	EXB38V470J	RESISTOR ARRAY	1	
	R17241	ERJ3GEYJ470	M 47 OHM,J,1/16W	1	
	R17242	EXB38V471J	RESISTOR ARRAY	1	
	R17245	EXB38V102J	RESISTOR ARRAY	1	
	R17246	ERJ3GEYJ471	M 470 OHM,J,1/16W	1	
	R17248	ERJ3GEYJ470	M 47 OHM,J,1/16W	1	
	R17249	EXB38V470J	RESISTOR ARRAY	1	
	R17250	EXB38V470J	RESISTOR ARRAY	1	
	R17251	ERJ3GEYJ471	M 470 OHM,J,1/16W	1	
	R17252	ERJ3GEY0R00	M 0 OHM, 1/16W	1	
	R17253	D0GDR00Z0002	M 0 OHM, 1/10W	1	
	R17257	ERJ3GEYJ470	M 47 OHM,J,1/16W	1	
	R17258	EXB38V102J	RESISTOR ARRAY	1	
	R17261	D0GDR00Z0002	M 0 OHM, 1/10W	1	
	R17262	ERJ3GEY0R00	M 0 OHM, 1/16W	1	
	R17269	D0GF472JA047	M 4.7KOHM,J,0.33W	1	
	R17272	ERJ3GEY0R00	M 0 OHM, 1/16W	1	
	R17280	D0GB102JA041	M 1KOHM,J,1/16W	1	
	R17282	ERJ3GEY0R00	M 0 OHM, 1/16W	1	
	R17285	EXB38V470J	RESISTOR ARRAY	1	
	R17288	EXB38V222J	RESISTOR ARRAY	1	
	R17290	EXB38V470J	RESISTOR ARRAY	1	
	R17293	EXB38V220JV	RESISTOR ARRAY	1	
	R17294	EXB38V471J	RESISTOR ARRAY	1	
	R17295	ERJ3GEYJ220	M 22 OHM,J,1/16W	1	
	R17296	ERJ3GEYJ471	M 470 OHM,J,1/16W	1	
	R17297	EXB38V470J	RESISTOR ARRAY	1	
	R17298	EXB38V471J	RESISTOR ARRAY	1	
	R17299	ERJ3GEYJ470	M 47 OHM,J,1/16W	1	

Safety	Ref. No.	Part No.	Part Name & Description	Pcs	Remarks
	R17300	ERJ3GEYJ471	M 470 OHM,J,1/16W	1	
	R17301	ERJ3GEYJ471	M 470 OHM,J,1/16W	1	
	R17302	ERJ3GEYJ471	M 470 OHM,J,1/16W	1	
	R17303	ERJ3GEYJ220	M 22 OHM,J,1/16W	1	
	R17304	ERJ3GEYJ470	M 47 OHM,J,1/16W	1	
	RM2501	B3RAD0000160	REMOTE SENSOR	1	
	S1B	K1KA03BA0237	3P CONNECTOR	1	
	SC2	K1KA02A00676	2P CONNECTOR	1	
	SC3	K1KA03A00596	3P CONNECTOR	1	
	SC20	K1MN30BA0255	30P CONNECTOR	1	
	SC41	K1KA09A00239	9P CONNECTOR	1	
	SC42	K1KA09A00239	9P CONNECTOR	1	
	SC46	K1KA09A00239	9P CONNECTOR	1	
	SC50	K1KA02AA0193	2P CONNECTOR	1	
	SS3	K1KY03BA0236	3P CONNECTOR	1	
	SS11	K1KA03A00608	3P CONNECTOR	1	
	SS22	K1KY15AA0606	15P CONNECTOR	1	
	SS23	K1KA06B00220	6P CONNECTOR	1	
	SS24	K1KB15AA0032	15P CONNECTOR	1	
	SS53	K1MN13B00091	13P CONNECTOR	1	
	SS58	K1MN13B00091	13P CONNECTOR	1	
△	SW2500	K0F162B00002	SWITCH	1	
	SW3759	EVQ11G05R	SWITCH	1	
	SW3760	EVQ11G05R	SWITCH	1	
	SW3761	EVQ11G05R	SWITCH	1	
	SW3762	EVQ11G05R	SWITCH	1	
	SW3763	EVQ11G05R	SWITCH	1	
△	TU2901	ENG37E18KF	TUNER	1	
	VR16600	EVMEASA00B54	CONTROL 50KOHMB 0.3W	1	
	VR16601	EVMEASA00B53	CONTROL 5KOHMB 0.3W	1	
	X1100	HOJ100500035	CRYSTAL	1	
	X2010	HOJ245500089	CRYSTAL	1	
	X8001	HOJ270500120	CRYSTAL	1	
	X8301	HOJ300500027	CRYSTAL	1	
	X9900	HOJ200500076	CRYSTAL	1	
	ZA001	K4AZ01D00004	TERMINAL	1	
	ZA002	K4CD01000011	AV TERMINAL	1	
	ZA16401	K4CD01000011	AV TERMINAL	1	
	ZA16402	K4CD01000011	AV TERMINAL	1	
	ZA16403	K4CD01000011	AV TERMINAL	1	
	ZA17101	K4CD01000013	AV TERMINAL	1	
	ZA17102	K4CD01000013	AV TERMINAL	1	
	ZA17103	K4CD01000013	AV TERMINAL	1	
	ZA17104	K4CD01000013	AV TERMINAL	1	
	ZA17201	K4CD01000013	AV TERMINAL	1	
	ZA17202	K4CD01000013	AV TERMINAL	1	
	ZA17203	K4CD01000013	AV TERMINAL	1	
	ZA17204	K4CD01000013	AV TERMINAL	1	
△	C101	F0CAF334A021	C 0.33UF, 250V	1	
△	C102	F1BAF221A107	C 220UF, 250V	1	
△	C103	F1BAF221A107	C 220UF, 250V	1	
△	C104	F0CAF334A021	C 0.33UF, 250V	1	
	C105	F1J1H334A679	C 0.33UF. 50V	1	
△	C106	F1BAF221A107	C 220UF, 250V	1	
△	C107	F1BAF221A107	C 220UF, 250V	1	
△	C109	ECQE2W225L0	C 22UF, 450V	1	
△	C110	ECQE2W225L0	C 22UF, 450V	1	

Safety	Ref. No.	Part No.	Part Name & Description	Pcs	Remarks
	C111	ECJ1VB1H103K	C 0.001UF, K, 50V	1	
	C112	ECJ1VB1H102K	C 1000PF, K, 50V	1	
	C113	F1J1E225A209	C 2.2 UF 25V	1	
	C114	F1H1C224A065	C 0.22UF, K, 50V	1	
	C115	ECJ1VB1H103K	C 0.001UF, K, 50V	1	
	C116	ECJ1VB1H472K	C 4700PF, K, 50V	1	
	C117	ECJ1VB1E104K	C 0.10UF, K, 25V	1	
	C118	F1H1H221A832	C 220UF, K, 50V	1	
	C119	ECJ2XB1H104K	C 0.1UF, K, 50V	1	
	C120	F1E2J4730001	C 0.047PF, , 600V	1	
	C121	F1H1C105A071	C 1UF, K, 16V	1	
	C122	ECKD3A102KBP	C 1000PF, K, 1KV	1	
	C123	ECKD3A102KBP	C 1000PF, K, 1KV	1	
	C124	F1H1C105A071	C 1UF, K, 16V	1	
△	C125	F2B2W3310012	C 330UF, 450V	1	
	C126	ECJ1VB1H102K	C 1000PF, K, 50V	1	
	C127	F1H1C105A071	C 1UF, K, 16V	1	
	C130	F1H1H221A832	C 220UF, K, 50V	1	
	C132	ECJ1VB1E104K	C 0.10UF, K, 25V	1	
	C200	ECJ1VB1H102K	C 1000PF, K, 50V	1	
△	C201	F2A2W220A165	E 22UF 160V	1	
	C202	F1E2J4730001	C 0.047PF, , 600V	1	
	C204	F1H1C105A148	C 1UF, K, 16V	1	
	C205	F2A1H4700057	E 47UF, 50V	1	
	C206	ECJ1VB1E104K	C 0.10UF, K, 25V	1	
	C207	F2A1H1000083	E 10UF, 50V	1	
	C208	F1J1E105A231	C 1 UF 25V	1	
	C209	ECJ1VB1E104K	C 0.10UF, K, 25V	1	
	C210	F2A1H4700057	E 47UF, 50V	1	
	C213	F1J1E105A231	C 1 UF 25V	1	
	C300	ECJ1VB1H103K	C 0.001UF, K, 50V	1	
	C301	ECJ2XB1H104K	C 0.1UF, K, 50V	1	
	C303	ECJ2FB1E474K	C 47UF, K, 25V	1	
	C304	ECCD3D470JGE	C 47PF, K, 2KV	1	
	C305	ECJ2XB1H104K	C 0.1UF, K, 50V	1	
	C306	ECJ2FB1E474K	C 47UF, K, 25V	1	
	C307	ECJ2VB1H103K	C 0.01UF, K, 50V	1	
	C308	ECJ2FB1E224K	C 22UF, K, 25V	1	
	C309	ECKD3D122KBP	C 1200PF, K, 2KV	1	
	C310	ECJ2VB1H222K	C 2200P 50V	1	
	C311	ECJ2VC1H470J	C 47PF. K. 50V	1	
	C312	ECJ1VB1E104K	C 0.10UF, K, 25V	1	
△	C313	F0C2J104A104	E 0.10UF, 630V	1	
	C314	F0C2J104A104	E 0.10UF, 630V	1	
△	C315	F0C2J333A104	E 0.033UF, 630V	1	
	C316	F1A3D1000002	C 10PF. 2KV	1	
	C317	F1A3D221A010	C 220PF. 2KV	1	
△	C319	F1BAF3310003	C 330UF, 250V	1	
	C321	ECJ1VB1H103K	C 0.001UF, K, 50V	1	
	C322	ECJ2VB1H103K	C 0.01UF, K, 50V	1	
△	C323	ECQE2W225L0	C 22UF, 450V	1	
	C500	ECJ2FB1C334K	C 33UF, K, 25V	1	
	C502	ECJ1XC1H681J	C 680PF, J, 50V	1	
	C503	ECJ1XC1H681J	C 680PF, J, 50V	1	
	C504	ECJ1XC1H102J	C 1000PF, J, 50V	1	
	C505	F2A1A1820009	C 1800UF. 10V	1	
	C506	ECJ1XC1H681J	C 680PF, J, 50V	1	
	C507	F2A1V1820026	E 1800UF 35V	1	
	C510	ECJ1XC1H102J	C 1000PF, J, 50V	1	
	C511	F1J1E105A231	C 1 UF 25V	1	
	C513	F2A1E1010106	E 100UF, 25V	1	
	C515	ECJ2XB1H104K	C 0.1UF, K, 50V	1	
	C518	ECJ1VB1H103K	C 0.001UF, K, 50V	1	
	C519	ECJ1VB1H102K	C 1000PF, K, 50V	1	
	C520	ECJ1VB1H102K	C 1000PF, K, 50V	1	
	C521	ECJ1VB1H102K	C 1000PF, K, 50V	1	
	C522	F1J1E105A231	C 1 UF 25V	1	

Safety	Ref. No.	Part No.	Part Name & Description	Pcs	Remarks
	C600	ECJ1VB1H103K	C 0.001UF, K, 50V	1	
	C601	ECJ1VB1H103K	C 0.001UF, K, 50V	1	
	C603	ECJ1VB1H103K	C 0.001UF, K, 50V	1	
	C606	ECJ2VB1H223K	C 0.022UF, K, 50V	1	
	C607	ECJ1VB1H103K	C 0.001UF, K, 50V	1	
	C608	ECJ2VB1H223K	C 0.022UF, K, 50V	1	
	C610	ECJ2VB1H103K	C 0.01UF, K, 50V	1	
	C611	ECJ2VB1H103K	C 0.01UF, K, 50V	1	
	C613	ECJ2VB1H103K	C 0.01UF, K, 50V	1	
	C623	F1J0J4750018	C 4.7UF, K, 16V	1	
	C625	ECJ2VB1H102K	C 1000PF, J, 50V	1	
	C627	ECJ2VB1H103K	C 0.01UF, K, 50V	1	
	C628	ECJ2VB1H103K	C 0.01UF, K, 50V	1	
	C630	ECJ1VB1H102K	C 1000PF, K, 50V	1	
	C700	F2A1H1000083	E 10UF, 50V	1	
	C701	ECJ1VB1E104K	C 0.10UF, K, 25V	1	
	C702	ECJ2VB1E104K	C 0.1UF, K, 25V	1	
	C704	F1B3D1020012	C 1000PF, 2KV	1	
	C706	ECJ2XB1H104K	C 0.1UF, K, 50V	1	
△	C709	F2AZZ471A019	E 470UF, 80V	1	
△	C712	F2B2E2210011	C 220UF, Z, 250V	1	
	C713	ECJ2VB1C224K	C 0.22UF, K, 16V	1	
	C714	ECJ2VC1H471J	C 470PF, K, 50V	1	
	C715	ECJ2VC1H471J	C 470PF, K, 50V	1	
	C716	ECJ2VB1C224K	C 0.22UF, K, 16V	1	
	C717	F2A1E3320041	E 3300PF, 25V	1	
	C718	ECJ2XB1H104K	C 0.1UF, K, 50V	1	
	C720	F0C2E204A256	E 0.20UF, 250V	1	
	C721	F0C2E473A256	E 0.047UF, 250V	1	
	C722	F0C2E473A256	E 0.047UF, 250V	1	
	C723	F1J1E105A231	C 1 UF 25V	1	
	C724	F1J1E105A231	C 1 UF 25V	1	
	C726	F2A1E4710105	E 470UF, 25V	1	
	C727	ECJ1VB1E104K	C 0.10UF, K, 25V	1	
	C728	ECJ1VB1H102K	C 1000PF, K, 50V	1	
	C729	ECJ1VB1E104K	C 0.10UF, K, 25V	1	
	C731	ECJ1VB1E104K	C 0.10UF, K, 25V	1	
	C732	F0C2E204A256	E 0.20UF, 250V	1	
	C735	ECJ1VB1H102K	C 1000PF, K, 50V	1	
△	D100	B0FBAT000006	DIODE	1	
	D101	B0ACDJ000010	DIODE	1	
	D102	B0JCDD000002	DIODE	1	
	D103	B0BC01400033	ZENER DIODE	1	
	D104	B0JAME000099	DIODE	1	
	D105	B0ACDJ000010	DIODE	1	
	D106	B0EAKT000048	DIODE	1	
	D108	B0HAPR000016	DIODE	1	
	D109	B0HAPR000016	DIODE	1	
	D110	B0BC8R100015	ZENER DIODE	1	
	D111	B0ACDJ000010	DIODE	1	
	D114	B0ACDJ000010	DIODE	1	
△	D200	B0EBKT000007	DIODE	1	
	D202	B0EAKT000048	DIODE	1	
	D203	B0EAKT000048	DIODE	1	
	D204	B0HAMP000067	DIODE	1	
	D205	MTZJ10B	ZENER DIODE	1	
	D206	B0ACDJ000010	DIODE	1	
	D207	B0BB17000003	ZENER DIODE	1	
	D208	B0HAMM000122	DIODE	1	
	D209	B0HALP000007	DIODE	1	
	D210	B0EAAD000001	DIODE	1	
	D211	B0BC02000014	ZENER DIODE	1	
	D212	B0EAKT000048	DIODE	1	
	D213	B0JCME000029	DIODE	1	
	D300	B0BC8R100015	ZENER DIODE	1	
	D301	B0HAGR000010	DIODE	1	
	D302	B0EAAD000001	DIODE	1	

Safety	Ref. No.	Part No.	Part Name & Description	Pcs	Remarks
	D303	B0EAAD000001	DIODE	1	
	D304	B0HAGR000010	DIODE	1	
	D305	B0HAJP000004	DIODE	1	
	D307	B0JCME000029	DIODE	1	
	D308	B0ACDJ000010	DIODE	1	
	D310	B0EAKT000048	DIODE	1	
	D311	B0JCME000029	DIODE	1	
	D500	B0BC01300033	ZENER DIODE	1	
	D501	B0JANG000018	DIODE	1	
	D502	B0HBSM000043	DIODE	1	
	D506	B0JANG000018	DIODE	1	
	D510	B0JANG000018	DIODE	1	
	D511	B0ACDJ000010	DIODE	1	
	D600	B0ACDJ000010	DIODE	1	
	D603	B0BC5R100039	ZENER DIODE	1	
	D604	B0EAAD000001	DIODE	1	
	D605	B0EAAD000001	DIODE	1	
	D700	B0HBSN000013	DIODE	1	
	D703	B0EAKT000031	DIODE	1	
	D704	B0EAKT000031	DIODE	1	
	D705	B0JBSL000013	DIODE	1	
	D706	B0FAAT000002	DIODE	1	
	D708	B0BC01300033	ZENER DIODE	1	
	D710	B0JCPE000038	DIODE	1	
	D711	DAN202U	DIODE	1	
	D712	B0BC8R100015	ZENER DIODE	1	
	D713	B0ACDJ000010	DIODE	1	
	D715	B0BC01200047	ZENER DIODE	1	
	D716	B0ADCJ000025	DIODE	1	
	D718	B0JCPE000038	DIODE	1	
	D719	B0ACDJ000010	DIODE	1	
	D720	B0ACDJ000010	DIODE	1	
	D721	B0ACDJ000010	DIODE	1	
	D722	B0ACDJ000010	DIODE	1	
△	F100	K5E802BZ0002	FUSE	1	
△	F101	K5E802BZ0002	FUSE	1	
△	F200	K5G631B00008	FUSE	1	
△	F201	K5G631B00008	FUSE	1	
	IC100	C0DBZZ000084	IC	1	
	IC101	C0DAGKC00001	IC	1	
	IC102	C0DAGKC00002	IC	1	
	IC200	C0DBZMC00006	IC	1	
△	IC201	MIP3E40MY	IC	1	
△	IC202	B3PBA0000508	IC	1	
	IC300	C0ABBA000168	IC	1	
	IC301	C0DABYY00019	IC	1	
△	IC302	B3PBA0000508	IC	1	
△	IC303	B3PBA0000508	IC	1	
△	IC304	B3PBA0000508	IC	1	
	IC500	C0DBZMC00006	IC	1	
	IC502	C0CAAJG00015	IC	1	
△	IC600	CNC1S171R	IC	1	
△	IC601	CNC1S171R	IC	1	
	IC602	C0EBH0000210	IC	1	
	IC603	C2ABDB000122	IC	1	
	IC700	C0DBZMC00006	IC	1	
	IC701	C0DBZMC00006	IC	1	
	IC702	C0DAAZH00027	IC	1	
	J501	ERJ6GEY0R00V	M 0 OHM J 1/10W	1	
△	L100	G0B163J00001	CHOKE COIL	1	
△	L101	G0B163J00001	CHOKE COIL	1	
	L102	EXCELDR35V	CORE	1	
	L103	EXCELDR35V	CORE	1	
	L104	EXCELDR35V	CORE	1	
	L700	G0C680KA0207	CHOKE COIL	1	
	P2	K1KA02A00676	2P CONNECTOR	1	
	P6	K1KA12AA0191	12P CONNECTOR	1	

Safety	Ref. No.	Part No.	Part Name & Description	Pcs	Remarks
	P7	K1KA11AA0191	11P CONNECTOR	1	
	P9	K1KA02B00295	2P CONNECTOR	1	
	P11	K1KA03A00608	3P CONNECTOR	1	
	P25	K1KA13AA0082	13P CONNECTOR	1	
	P34	K1KA03AA0193	3P CONNECTOR	1	
	P35	K1KA03A00647	3P CONNECTOR	1	
△	PR101	K5Y502BA0001	FUSE	1	
△	PR600	ERBSE0R50U	FUSE	1	
△	PR700	K5G502B00015	FUSE	1	
△	PR702	ERBSE0R50U	FUSE	1	
	Q100	B1CHMG000004	FET	1	
	Q101	B1CFHG000013	FET	1	
	Q103	B1BCCF000022	TRANSISTOR	1	
△	Q104	B1CERR000027	FET	1	
	Q106	B1HFCA000021	TRANSISTOR	1	
	Q201	B1HFCA000021	TRANSISTOR	1	
	Q300	B1CBGD000001	FET	1	
	Q301	B1CHND000004	FET	1	
	Q302	B1HFPPA00001	TRANSISTOR	1	
	Q303	B1HFPPA00001	TRANSISTOR	1	
△	Q304	B1CERR000028	FET	1	
△	Q305	B1CERR000028	FET	1	
	Q500	B1CHND000004	FET	1	
	Q503	B1CHND000004	FET	1	
	Q504	B1CFQC000002	FET	1	
	Q505	B1CHND000004	FET	1	
	Q506	2SD1819ARL	TRANSISTOR	1	
	Q600	2SD1819ARL	TRANSISTOR	1	
	Q602	2SD1819ARL	TRANSISTOR	1	
	Q610	B1CBGD000001	FET	1	
	Q700	2SB1218ARL	TRANSISTOR	1	
	Q701	B1ADCF000111	TRANSISTOR	1	
	Q702	2SD1819ARL	TRANSISTOR	1	
	Q703	B1HBCFA00033	TRANSISTOR	1	
	Q704	B1HFCA000021	TRANSISTOR	1	
	Q705	B1HBCFA00033	TRANSISTOR	1	
△	R101	D0B1825JA033	M1.22MOHM,J,0.05W	1	
△	R102	ERF5TJ100	W 10 OHM, J, 5W	1	
	R103	ERJ6GEYJ333V	M 33KOHM,J,1/10W	1	
	R104	ERJ6GEYJ624	M 620KOHM,J,1/10W	1	
	R105	D1AB4303A023	CHIP RESISTOR	1	
	R106	ERJ3GEYJ434	M 430KOHM,J,1/16W	1	
	R107	D1AB4303A023	CHIP RESISTOR	1	
	R108	ERJ3GEYJ223	M 22KOHM,J,1/16W	1	
	R109	ERJ6GEYJ821	M 820 OHM,J,1/10W	1	
	R110	D1AB4303A023	CHIP RESISTOR	1	
	R112	ERJ6GEYJ472V	M 4.7K OHM J 1/10W	1	
	R113	ERJ3EKF1002	M 10KOHM, 1/16W	1	
	R114	D0BF6R8JA035	M 6.8OHM,J,0.05W	1	
	R115	D0BF6R8JA035	M 6.8OHM,J,0.05W	1	
	R116	ERJ8GEYJ153	M 15KOHM, J,1/8W	1	
	R117	ERJ8GEYJ153	M 15KOHM, J,1/8W	1	
	R118	D0GB183JA057	M 18K OHM J 1/16W	1	
	R119	D0GB103JA057	M 10K OHM J 1/16W	1	
	R120	ERG12SJ181	M 180 OHM, J,1/2W	1	
	R121	ERJ3GEYJ333	M 33KOHM,J,1/16W	1	
	R122	ERX12SJ4R7	M 4.7 OHM, J,1/2W	1	
	R123	D0GB103JA057	M 10K OHM J 1/16W	1	
	R125	DOXZR12JA011	M 0.12OHM,J, 5W	1	
	R126	DOXZR12JA011	M 0.12OHM,J, 5W	1	

Safety	Ref. No.	Part No.	Part Name & Description	Pcs	Remarks
	R127	ERJ6GEYJ331V	M 330 OHM J 1/10W	1	
	R128	ERJ6GEYJ103V	M 10K OHM J 1/10W	1	
	R129	D0GD4R7JA059	M 4.7 OHM,J,0.25W	1	
	R130	ERJ6GEYJ104V	M 100KOHM,J,1/10W	1	
	R131	ERJ6GEYJ331V	M 330 OHM J 1/10W	1	
	R132	D0GD2R2JA059	M 2.2 OHM,J,0.25W	1	
	R133	D1AB6803A023	CHIP RESISTOR	1	
	R134	D1AB6803A023	CHIP RESISTOR	1	
	R135	D1AB6803A023	CHIP RESISTOR	1	
	R136	ERJ6GEYJ104V	M 100KOHM,J,1/10W	1	
	R137	ERJ8GEYJ474	M 470KOHM, J,1/8W	1	
	R138	ERJ6GEYJ123V	M 12KOHM,J,1/10W	1	
	R139	ERJ6ENF1272	M12.7KOHM, 1/10W	1	
	R140	ERJ6GEYJ821	M 820 OHM,J,1/10W	1	
	R141	EVMAASA00B23	CONTROL 2KOHMB	1	
	R142	D0GB103JA057	M 10K OHM J 1/16W	1	
	R143	ERJ3GEYJ333	M 33KOHM,J,1/16W	1	
	R144	D0GB103JA057	M 10K OHM J 1/16W	1	
	R145	ERJ3GEYJ333	M 33KOHM,J,1/16W	1	
	R146	ERJ3GEYJ472	M 4.7KOHM,J,1/16W	1	
	R147	D1AB5603A023	CHIP RESISTOR	1	
	R148	D1AB5603A023	CHIP RESISTOR	1	
	R149	D1AB5103A023	CHIP RESISTOR	1	
	R150	ERJ6ENF3302	M 33KOHM, 1/10W	1	
	R151	ERJ6ENF2002	M 20KOHM, 1/10W	1	
	R200	D1AB2203A023	CHIP RESISTOR	1	
	R201	D1AB2203A023	CHIP RESISTOR	1	
	R202	D1AB2203A023	CHIP RESISTOR	1	
	R203	D1AB2203A023	CHIP RESISTOR	1	
	R204	D1AB2203A023	CHIP RESISTOR	1	
	R205	D1AB2203A023	CHIP RESISTOR	1	
	R206	ERJ6ENF3302	M 33KOHM, 1/10W	1	
	R207	ERJ6ENF4702	M 47KOHM, 1/10W	1	
	R208	ERJ6GEYJ222V	M 2.2K OHM J 1/10W	1	
	R209	D0GB102JA057	M 1KOHM,J,1/16W	1	
△	R210	ERF5TJ100	W 10 OHM, J, 5W	1	
	R211	ERJ6GEYJ6R8V	M 6.8 OHM,J,1/10W	1	
	R212	ERJ6GEYJ472V	M 4.7K OHM J 1/10W	1	
	R213	ERJ6GEYJ153V	M 15KOHM,J,1/10W	1	
	R214	ERJ6GEYJ221V	M 220 OHM,J,1/10W	1	
	R216	D0GD4R7JA059	M 4.7 OHM,J,0.25W	1	
	R217	D0GD4R7JA059	M 4.7 OHM,J,0.25W	1	
	R218	ERJ3GEY0R00	M 0 OHM, 1/16W	1	
	R219	ERJ6GEYF473	M 47KOHM,J,1/10W	1	
	R301	ERJ6GEYJ472V	M 4.7K OHM J 1/10W	1	
	R303	ERJ6GEYJ332V	M 3.3K OHM J 1/10W	1	
	R304	ERJ6GEYJ104V	M 100KOHM,J,1/10W	1	
	R305	D0GD180JA036	M 18 OHM,J,0.25W	1	
	R308	D0GB105JA057	M 1M OHM F 1/16W	1	
	R309	ERJ6GEYJ222V	M 2.2K OHM J 1/10W	1	
	R310	ERJ6GEYJ103V	M 10K OHM J 1/10W	1	
	R311	ERJ6GEYJ153V	M 15KOHM,J,1/10W	1	
	R312	ERJ6GEYJ333V	M 33KOHM,J,1/10W	1	
	R313	ERJ6GEYF473	M 47KOHM,J,1/10W	1	

Safety	Ref. No.	Part No.	Part Name & Description	Pcs	Remarks
	R314	ERJ6GEYJ100V	M 10 OHM,J,1/10W	1	
	R315	ERJ6GEYJ222V	M 2.2K OHM J 1/10W	1	
	R316	ERJ6GEYJ223	M 22KOHM,J,1/10W	1	
	R317	ERJ6GEYJ682	M 6.8KOHM,J,1/10W	1	
	R318	ERJ6GEYJ472V	M 4.7K OHM J 1/10W	1	
	R319	ERJ6GEYJ223	M 22KOHM,J,1/10W	1	
	R320	ERJ6GEYJ1R0	M 1 OHM,J,1/10W	1	
	R321	ERJ6GEYJ223	M 22KOHM,J,1/10W	1	
	R322	ERJ12YJ100	M 10 OHM,J, 1/2W	1	
	R323	ERJ12YJ101	M 100 OHM,J, 1/2W	1	
	R324	ERJ12YJ100	M 10 OHM,J, 1/2W	1	
	R325	ERJ12YJ101	M 100 OHM,J, 1/2W	1	
	R326	ERJ6GEYJ223	M 22KOHM,J,1/10W	1	
	R327	ERJ6GEYJ102V	M 1K OHM J 1/10W	1	
	R328	ERJ6GEYJ104V	M 100KOHM,J,1/10W	1	
	R330	ERJ6GEYJ100V	M 10 OHM,J,1/10W	1	
	R333	ERJ6GEYJ221V	M 220 OHM,J,1/10W	1	
	R334	ERJ6GEYJ104V	M 100KOHM,J,1/10W	1	
	R335	ERJ6GEYJ100V	M 10 OHM,J,1/10W	1	
	R337	ERJ6GEYJ221V	M 220 OHM,J,1/10W	1	
	R338	ERJ6GEYJ104V	M 100KOHM,J,1/10W	1	
	R341	D0XB105JA007	RESISTOR ARRAY	1	
	R342	ERJ6GEYJ102V	M 1K OHM J 1/10W	1	
	R343	ERJ6ENF1200	M 120 OHM, 1/10W	1	
	R344	ERJ6ENF22R0	M 22 OHM, 1/10W	1	
	R346	ERJ6GEYJ221V	M 220 OHM,J,1/10W	1	
	R500	ERJ6GEYJ221V	M 220 OHM,J,1/10W	1	
	R502	D0GB102JA057	M 1KOHM,J,1/16W	1	
	R503	ERJ3GEYJ104	M 100KOHM,J,1/16W	1	
	R504	D0GF1R5JA047	M 1.5 OHM,J, 0.33W	1	
	R505	ERJ8GEYJ100	M 10 OHM, J,1/8W	1	
	R506	ERJ3GEYJ104	M 100KOHM,J,1/16W	1	
	R507	ERJ6RBD333	M 33KOHM,J,1/10W	1	
	R508	ERJ3RBD333	M 33KOHM, 1/16W	1	
	R511	D0GB102JA057	M 1KOHM,J,1/16W	1	
	R512	ERJ3GEY0R00	M 0 OHM, 1/16W	1	
	R515	ERJ3EKF2702V	M27.0KOHM, 1/16W	1	
	R516	ERJ3EKF2401	M 2.4KOHM, 1/16W	1	
	R517	D0GB103JA057	M 10K OHM J 1/16W	1	
	R518	ERJ3GEYJ104	M 100KOHM,J,1/16W	1	
	R521	ERJ3GEYJ104	M 100KOHM,J,1/16W	1	
	R524	ERJ6GEYJ683V	M 68K OHM J 1/10W	1	
	R525	ERJ6GEYJ104V	M 100KOHM,J,1/10W	1	
	R526	ERJ6GEYJ393V	M 39KOHM,J,1/10W	1	
	R527	ERJ6GEYJ101V	M 100 OHM,J,1/10W	1	
	R528	D0GB103JA057	M 10K OHM J 1/16W	1	
	R529	ERJ3GEYJ104	M 100KOHM,J,1/16W	1	
	R530	ERJ6GEYJ104V	M 100KOHM,J,1/10W	1	
	R531	ERJ6GEYJ102V	M 1K OHM J 1/10W	1	
	R600	ERJ3GEY0R00	M 0 OHM, 1/16W	1	
	R601	ERJ6GEYJ102V	M 1K OHM J 1/10W	1	
	R602	ERJ3GEYJ224	M 220KOHM,J,1/16W	1	

Safety	Ref. No.	Part No.	Part Name & Description	Pcs	Remarks
	R603	ERJ3GEYJ101	M 100 OHM,J,1/16W	1	
	R604	ERJ6GEYJ104V	M 100KOHM,J,1/10W	1	
	R605	ERJ3GEYJ224	M 220KOHM,J,1/16W	1	
	R606	ERJ3GEYJ101	M 100 OHM,J,1/16W	1	
	R608	ERJ6GEYJ102V	M 1K OHM J 1/10W	1	
	R609	ERJ6GEYJ104V	M 100KOHM,J,1/10W	1	
	R610	ERJ6GEYJ101V	M 100 OHM,J,1/10W	1	
	R611	ERJ6GEYJ101V	M 100 OHM,J,1/10W	1	
	R612	ERJ3GEY0R00	M 0 OHM, 1/16W	1	
	R613	D0GB154JA057	M 150KOHM J 1/16W	1	
	R615	D0GB182JA057	M 1.8KOHM J 1/16W	1	
	R619	ERJ6GEYJ101V	M 100 OHM,J,1/10W	1	
	R620	ERJ6GEYJ102V	M 1K OHM J 1/10W	1	
	R621	ERJ3GEYJ104	M 100KOHM,J,1/16W	1	
	R622	ERJ6GEYJ102V	M 1K OHM J 1/10W	1	
	R623	ERJ6GEYJ104V	M 100KOHM,J,1/10W	1	
	R633	ERJ3GEYJ222	M 2.2KOHM,J,1/16W	1	
	R634	D0GB102JA057	M 1KOHM,J,1/16W	1	
	R635	ERJ6GEYJ102V	M 1K OHM J 1/10W	1	
	R636	ERJ6GEYJ102V	M 1K OHM J 1/10W	1	
	R637	D0GB152JA057	M 1.5KOHM J 1/16W	1	
	R638	ERJ3GEYJ101	M 100 OHM,J,1/16W	1	
	R639	D0GB152JA057	M 1.5KOHM J 1/16W	1	
	R640	D0GB102JA057	M 1KOHM,J,1/16W	1	
	R641	ERJ6RBD152	M 1.5KOHM,J,1/10W	1	
	R642	D0GB102JA057	M 1KOHM,J,1/16W	1	
	R643	ERJ6GEYJ332V	M 3.3K OHM J 1/10W	1	
	R644	ERJ8GEYJ330	M 33 OHM, J,1/8W	1	
	R645	ERJ3GEYJ104	M 100KOHM,J,1/16W	1	
	R646	ERJ6GEYF473	M 47KOHM,J,1/10W	1	
	R647	ERJ6GEYJ102V	M 1K OHM J 1/10W	1	
	R648	ERJ6GEYJ393V	M 39KOHM,J,1/10W	1	
	R652	ERJ6GEYJ392	M 3.9KOHM,J,1/10W	1	
	R653	ERJ6GEYJ392	M 3.9KOHM,J,1/10W	1	
	R701	ERJ3GEYJ104	M 100KOHM,J,1/16W	1	
	R702	ERJ3GEYJ683	M 68KOHM,J,1/16W	1	
	R703	ERJ6GEYJ222V	M 2.2K OHM J 1/10W	1	
	R704	ERJ6GEYJ102V	M 1K OHM J 1/10W	1	
	R705	ERJ6GEYJ222V	M 2.2K OHM J 1/10W	1	
	R706	ERJ3GEYJ104	M 100KOHM,J,1/16W	1	
	R707	ERG1SJW123	M 12KOHM, J, 1W	1	
	R708	ERJ3GEY0R00	M 0 OHM, 1/16W	1	
	R709	ERJ8GEYJ154	M 150KOHM, J,1/8W	1	
	R710	ERJ8GEYJ154	M 150KOHM, J,1/8W	1	
	R711	ERJ8GEYJ154	M 150KOHM, J,1/8W	1	
	R712	ERJ14YJ2R7U	M 2.7OHM, 1/4W	1	
	R713	ERJ14YJ2R7U	M 2.7OHM, 1/4W	1	
	R714	ERJ14YJ2R7U	M 2.7OHM, 1/4W	1	
	R715	ERJ14YJ2R7U	M 2.7OHM, 1/4W	1	
	R716	ERJ6GEYJ102V	M 1K OHM J 1/10W	1	

Safety	Ref. No.	Part No.	Part Name & Description	Pcs	Remarks
	R717	ERJ6GEYJ102V	M 1K OHM J 1/10W	1	
	R718	ERJ6GEYG681	M 680 OHM,J,1/10W	1	
	R720	ERJ6GEYJ103V	M 10K OHM J 1/10W	1	
	R721	ERJ6GEYJ101V	M 100 OHM,J,1/10W	1	
	R722	ERJ6GEYJ102V	M 1K OHM J 1/10W	1	
	R723	ERJ6GEYJ122V	M 1.2KOHM,J,1/10W	1	
	R724	ERJ6GEYJ102V	M 1K OHM J 1/10W	1	
	R725	ERJ8ENF1603	M 16KOHM, 1/8W	1	
	R726	ERJ8ENF1503	M 15KOHM, 1/8W	1	
	R727	ERJ8ENF1303	M 13KOHM, 1/8W	1	
	R728	ERJ8ENF1303	M 13KOHM, 1/8W	1	
	R730	ERJ6ENF6801	M 6.8KOHM, 1/10W	1	
	R731	ERJ6GEYJ222V	M 2.2K OHM J 1/10W	1	
	R732	ERJ8ENF5102	M 51K OHM, 1/8W	1	
	R733	ERJ8ENF4702	M 47K OHM, 1/8W	1	
	R735	EVMAASA00B23	CONTROL 2KOHMB	1	
	R736	ERJ6ENF3301	M 3.3KOHM, 1/10W	1	
	R737	EVMAASA00B23	CONTROL 2KOHMB	1	
	R738	ERJ6ENF1303	M 130KOHM, 1/10W	1	
	R739	ERJ6ENF1303	M 130KOHM, 1/10W	1	
	R740	ERJ6ENF3302	M 33KOHM, 1/10W	1	
	R741	ERJ6ENF1803	M 180KOHM, 1/10W	1	
	R742	ERJ6ENF1803	M 180KOHM, 1/10W	1	
	R743	ERJ6ENF1803	M 180KOHM, 1/10W	1	
	R744	ERJ6ENF1803	M 180KOHM, 1/10W	1	
	R745	ERJ6ENF3302	M 33KOHM, 1/10W	1	
	R748	ERJ8ENF3900	M 390 OHM, 1/8W	1	
	R749	ERJ3GEYJ472	M 4.7KOHM,J,1/16W	1	
	R750	ERJ3GEYJ333	M 33KOHM,J,1/16W	1	
	R751	ERJ6ENF1302	M 13KOHM, 1/10W	1	
	R752	ERJ6ENF1101	M 1.1KOHM, 1/10W	1	
	R753	ERJ6GEYJ101V	M 100 OHM,J,1/10W	1	
	R754	ERJ3EKF2002	M 20KOHM, 1/16W	1	
	R755	ERJ3EKF3302	M 33KOHM, 1/16W	1	
	R757	DOMA30MJ0001	M 30 OHM,J, 2W	1	
	R764	DOGB103JA057	M 10K OHM J 1/16W	1	
	R765	DOGB103JA057	M 10K OHM J 1/16W	1	
	R766	ERJ6GEYJ101V	M 100 OHM,J,1/10W	1	
	R768	ERJ8ENF3900	M 390 OHM, 1/8W	1	
	R769	ERJ6GEYJ102V	M 1K OHM J 1/10W	1	
	R770	DOGB103JA057	M 10K OHM J 1/16W	1	
	R777	DOMA30MJ0001	M 30 OHM,J, 2W	1	
	R784	ERJ6GEYJ102V	M 1K OHM J 1/10W	1	
	R785	ERJ3GEYJ222	M 2.2KOHM,J,1/16W	1	
	R788	ERJ6GEY0R00V	M 0 OHM J 1/10W	1	
	R792	ERJ3EKF2002	M 20KOHM, 1/16W	1	
	R793	ERJ3EKF3302	M 33KOHM, 1/16W	1	
	R795	ERJ3GEY0R00	M 0 OHM, 1/16W	1	
	R797	ERJ6GEYF561	M 560 OHM,F,1/10W	1	
△	RL101	K6B1AYY00047	REALY	1	
△	RL102	K6B1AYY00047	REALY	1	
△	S100	J0LT00000009	SWITCH	1	
△	S101	J0LT00000009	SWITCH	1	
	T100	G4DYA0000152	TRANSFORMER	1	
△	T200	ETS29AZ2U6AH	TRANSFORMER	1	
△	T300	G4D3A0000211	TRANSFORMER	1	
△	T301	G4D3A0000213	TRANSFORMER	1	
	X801	H2B400400021	CRYSTAL	1	

Safety	Ref. No.	Part No.	Part Name & Description	Pcs	Remarks
	Z1	K4ZZ01000206	TERMINAL	1	
	Z2	K4ZZ01000206	TERMINAL	1	
	Z3	K4ZZ01000206	TERMINAL	1	
△	ZN100	ERZVRED621	VARISTOR	1	
△	ZN101	ERZVGAD681T2	VARISTOR	1	
△	ZN102	ERZVRED621	VARISTOR	1	
△	ZN200	ERZVA7D511	VARISTOR	1	
△	ZN201	ERZVA7D511	VARISTOR	1	