

Service Manual

RN-271N



RN-272N



RN-273N



RN-274N



RN-331N



RN-332N



RN-333N



RN-334N



RN-335N



RN-336N



1. SPECIFICATION	
1-1. Model Information -----	2
1-2. Interior Parts -----	3
1-3. Machine Compartment View -----	5
1-4. Refrigerant Cycle -----	6
1-5. Temperature Diagram -----	7
1-6. Wire Diagram -----	8
1-7. Main PCB Circuit Diagram -----	9
2. FUNCTIONS	
2-1. 'PCB VOLUME' Control -----	10
2-2. Temperature Control of Refrigerator compartment -----	11
2-3. Defrost Mode -----	12
2-4. Function of Low Ambient Temperature -----	14
2-5. Time Saving Function -----	15
2-6. Control of R Sensor OFF Point -----	16
2-7. Error Display -----	17
3. DISASSEMBLY	
3-1. Door Switch -----	18
3-2. Cover Multi-Flow Duct As (in Fresh food Compartment) -----	19
3-3. Louver F As (in Frozen Food Compartment) -----	20
3-4. Door F/R -----	21
4. How to Change Door Position -----	23
5. How to Charge R-600a Refrigerant -----	24
6. Part List	
6-1. Cabinet/ Evaporator/ Compressor Compartment -----	29
6-2. Frozen Food Compartment -----	30
6-3. Fresh Food Compartment -----	31
6-4. Door Compartment -----	32

1. SPECIFICATIONS

1-1. Model Information

* is the Door Type

Buyer No.		RN-27*N	RN-33*N
Factory No.		RFP-24*N....N	RFP-301*N....N
Control Type		KNOB & Digital Smart Control	
Gross Vol. ISO 15502 (unit: L)	Total	271	337
	Freezer	110	111
	Refrigerator	161	226
Storage Vol. ISO 15502 (unit: L)	Total	240	305
	Freezer	83	84
	Refrigerator	157	221
Dimension (unit: mm)	Net Width (Packing)	545(584)	595(634)
	Net Depth (Packing)	629(667)	650(685)
	Net Height (Packing)	1800(1900)	1870(1970)
Cooling Cycle	Refrigerant Type	R-600a	
	Refrigerant Charge	0.044kg	
	Evaporator Type	Fin Type	
	Condenser Type	Natural Convection Cooling System	
	Dryer	Desiccant: Molecular Sieve xH-9	
	Capillary Tube (unit: mm)	ID0.7 x T0.55 x L2290	
Heater	Defrost Type	Automatic Start & Stop	
	Defrost Heater	AC230V, 130W	
	Defrost Shape	Sheath Type	
Electric Part	Freezer Fan Motor	AC 220V/50Hz, 2500RPM	
	Refrigerator Lighting	Bulb 15W x 1EA	
Net Weight (Packing)		63(68)kg	67(73)kg
Blowing Agent		C-Pentane	

1-2. Interior Parts

1-2-1. RN-271 model

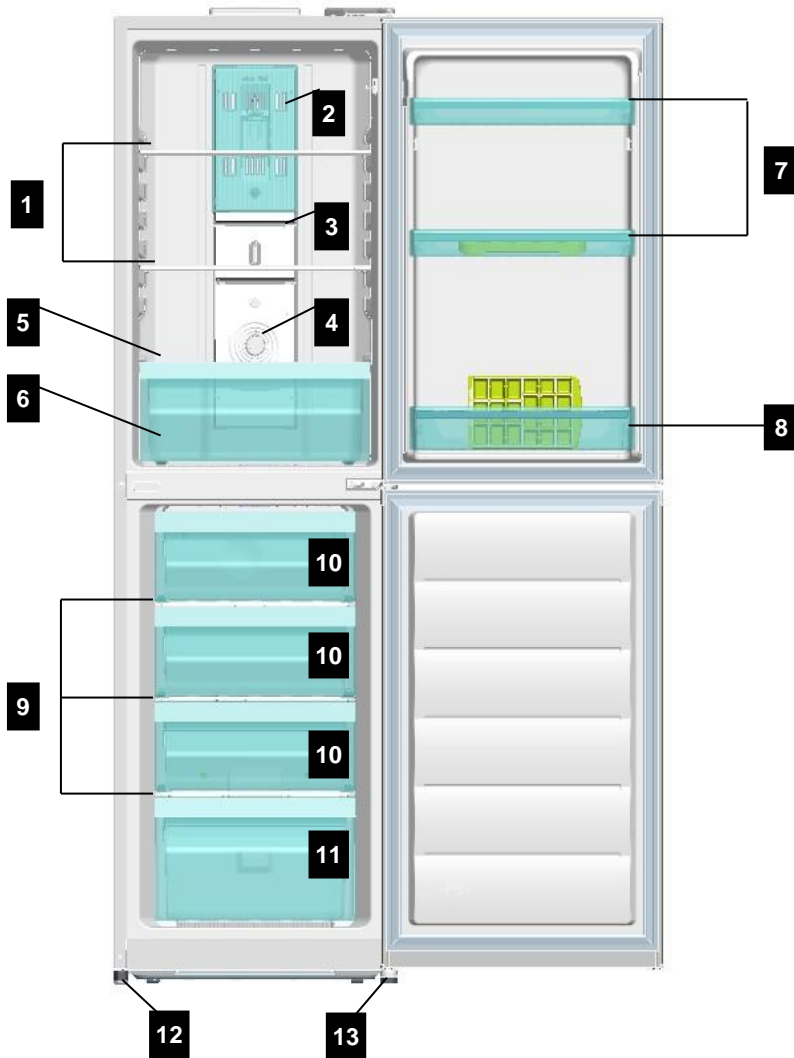

- 1. Refrigerator Shelves
- 2. Lamp Window
- 3. Multi Duct
- 4. Knob R Control
- 5. Cover Vegetable Case
- 6. Vegetable Case

- 7. Refrigerator Pocket "R"
- 8. Refrigerator Pocket "J"
- 9. Freezer Shelves
- 10. Freezer Case "A"
- 11. Freezer Case "B"
- 12. Adjusting Leg (Left)
- 13. Adjusting Leg (Right)

1-2. Interior Parts

1-2-2. RN-331 model

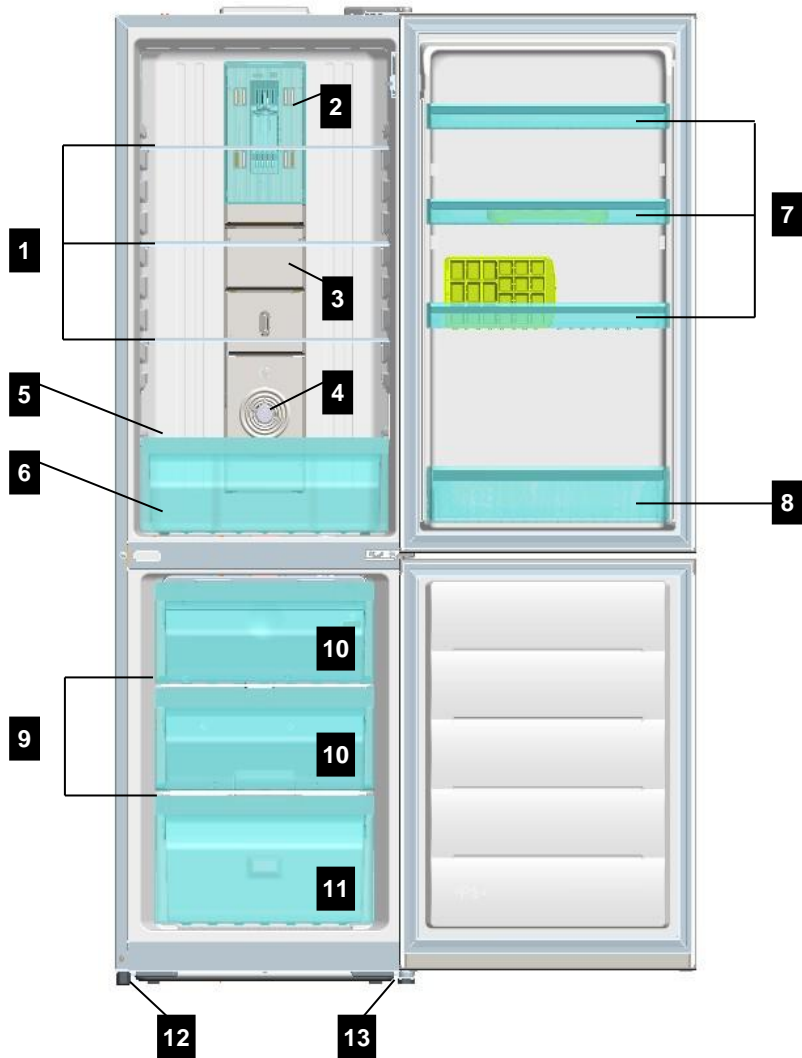

- 1. Refrigerator Shelves
- 2. Lamp Window
- 3. Multi Duct
- 4. Knob R Control
- 5. Cover Vegetable Case
- 6. Vegetable Case

- 7. Refrigerator Pocket "R"
- 8. Refrigerator Pocket "J"
- 9. Freezer Shelves
- 10. Freezer Case "A"
- 11. Freezer Case "B"
- 12. Adjusting Leg (Left)
- 13. Adjusting Leg (Right)

1-3. Machine (Compressor) Compartment View

- Features are model dependent (Below is RN-271 model)

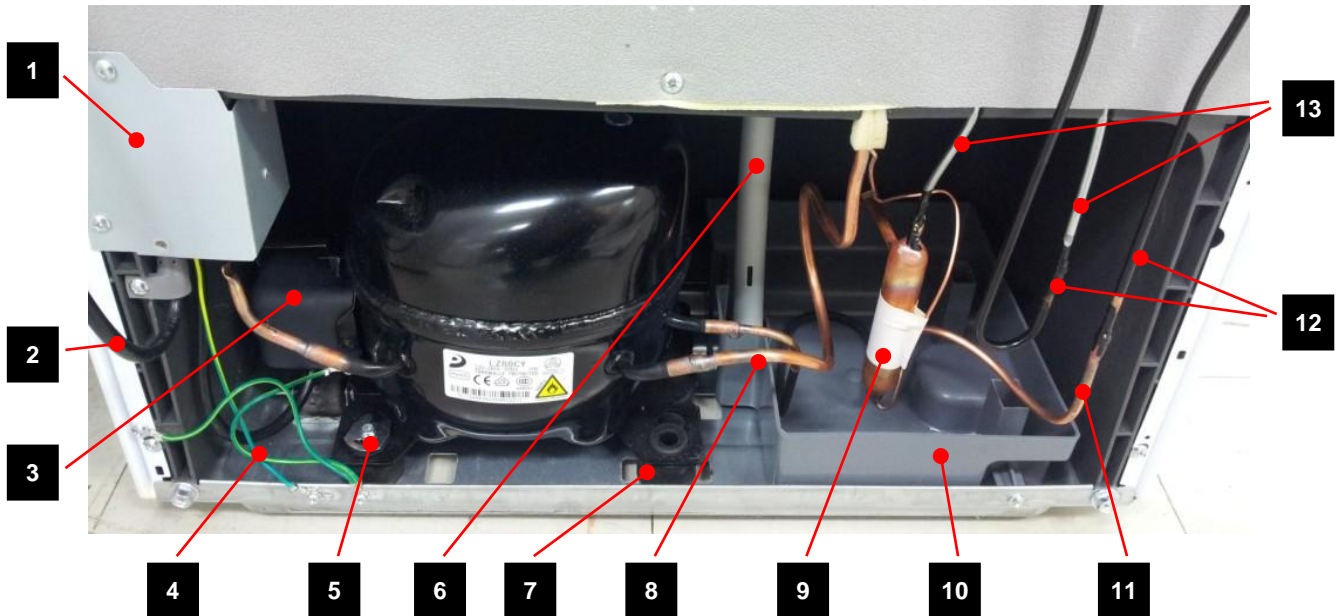

1.Box Power As (Capacitor Run)

2. Power Cord

3. Switch P Relay As

4. Earth Comp Wire

5. Fixture Compressor (Washer)

6. Drain Hose

7. Compressor Absorber

8. Suction Pipe As

9. Dryer As

10. Case vaporization As

11.Pipe connector A

12. Pipe Wire Condensor As

13. Pipe Hot

1-4. Refrigerant Cycle

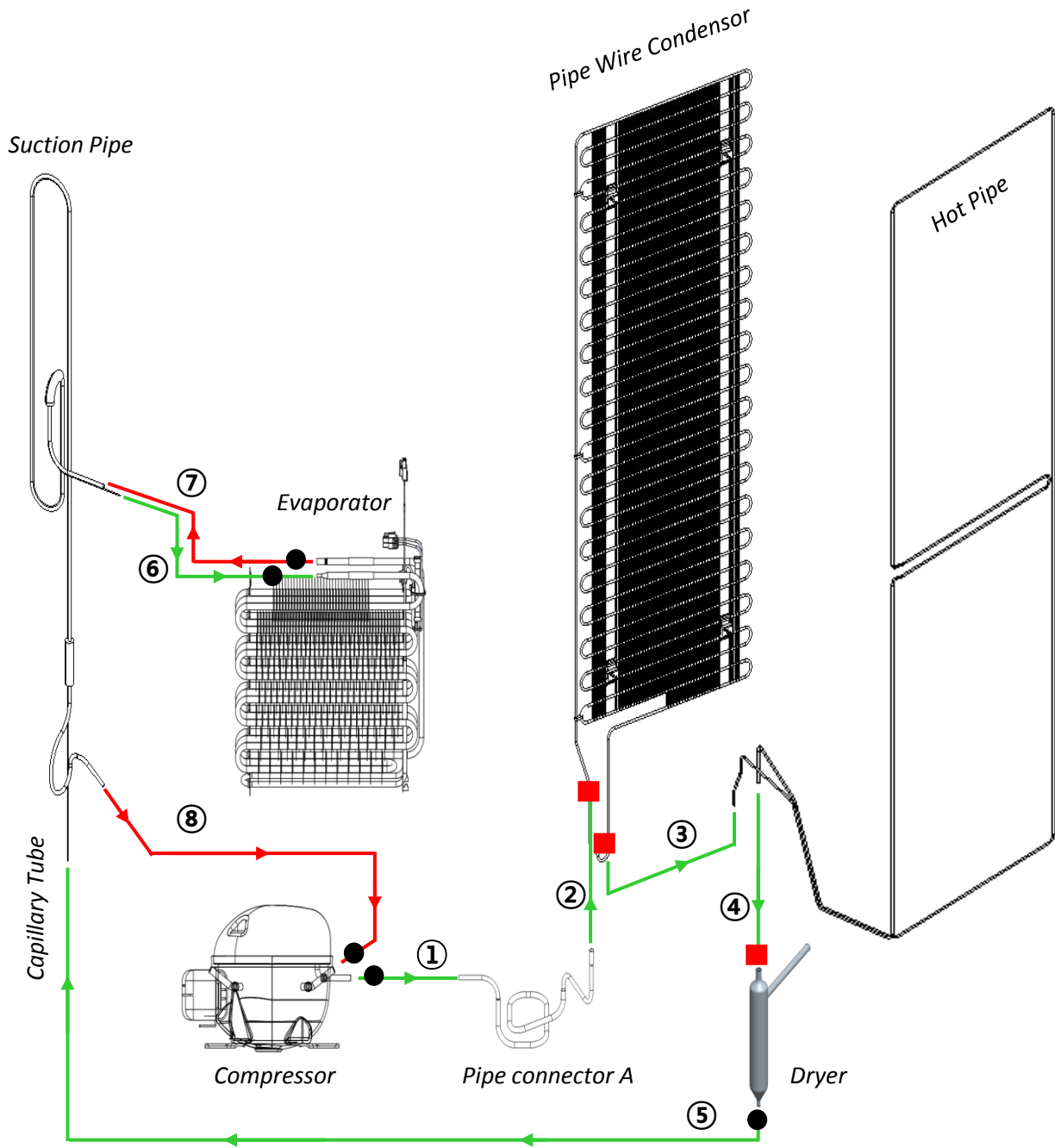

- Welding Point

●	Copper Welding (Ag 5%)	5 Point
■	Silver Welding (Ag 30%)	3 Point

1-5. Temperature Diagram

* Features are model dependent
 (Below is RN-271 model)

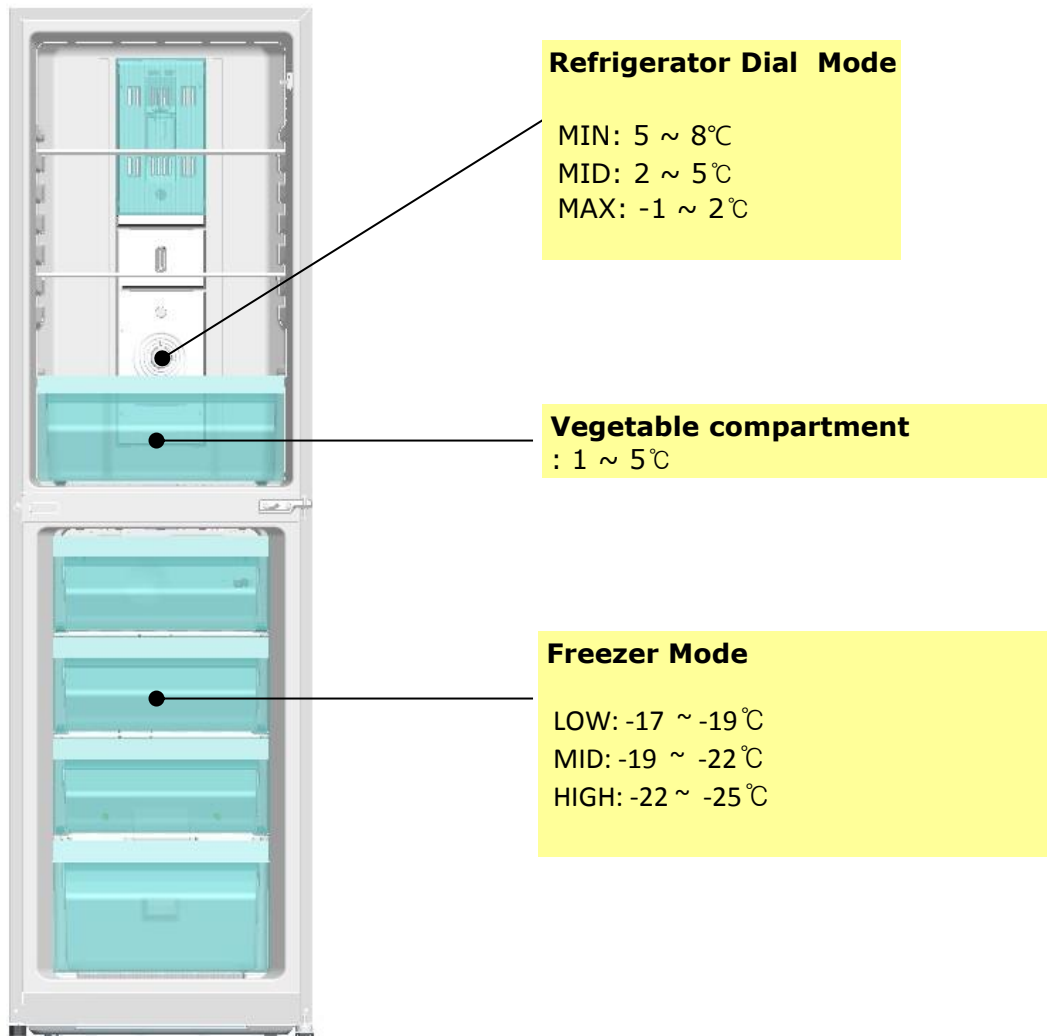

; The actual inner temperature varies depending on the food status, as the indicated setting temperature is a target temperature, not actual temperature within refrigerator.

; Refrigeration function is weak in the initial time.

Please adjust temperature as above after using refrigerator for minimum 1 ~ 2 days.

1-6. Wiring Diagram

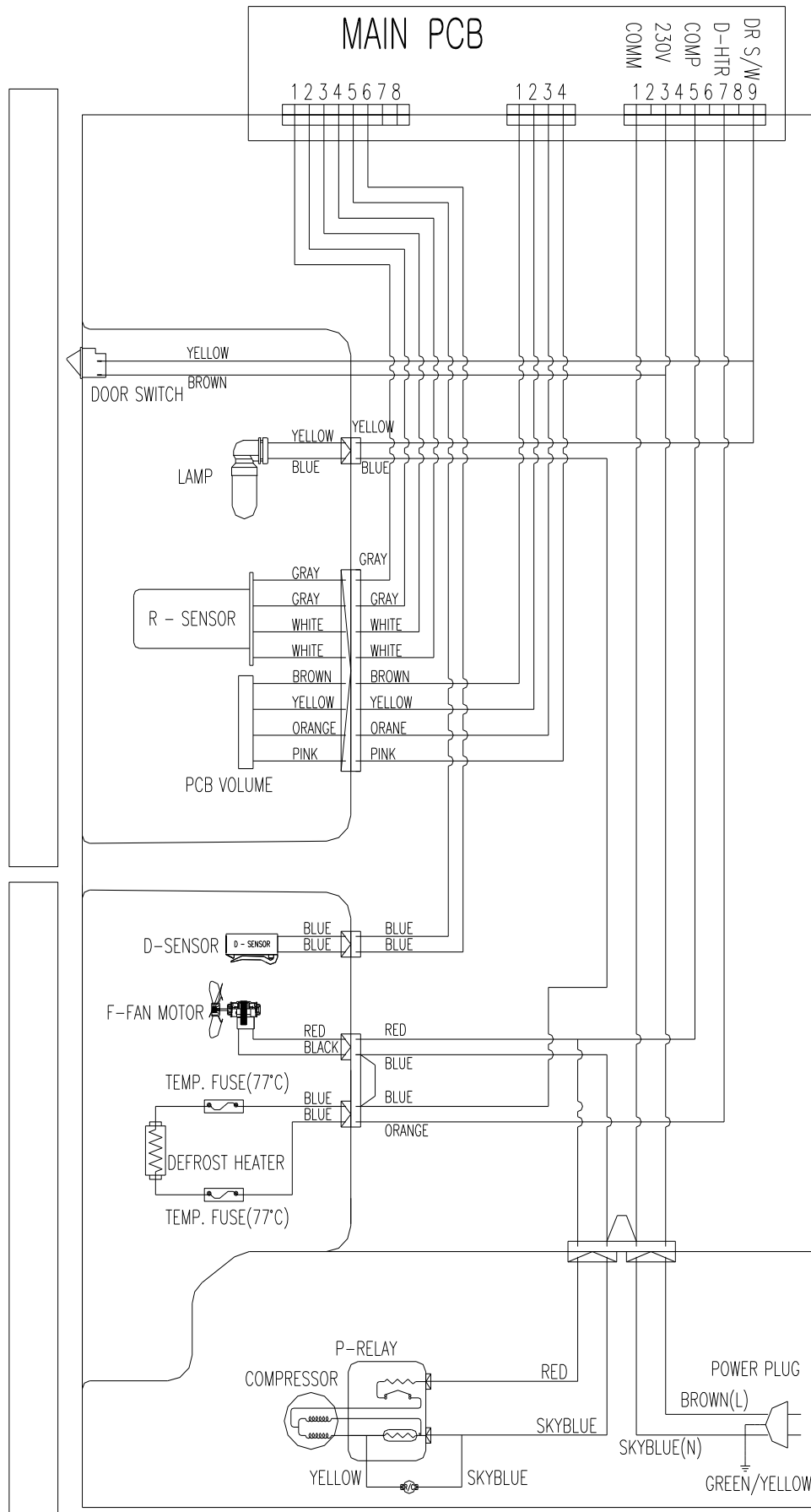

1.7. Main PCB Circuit Diagram

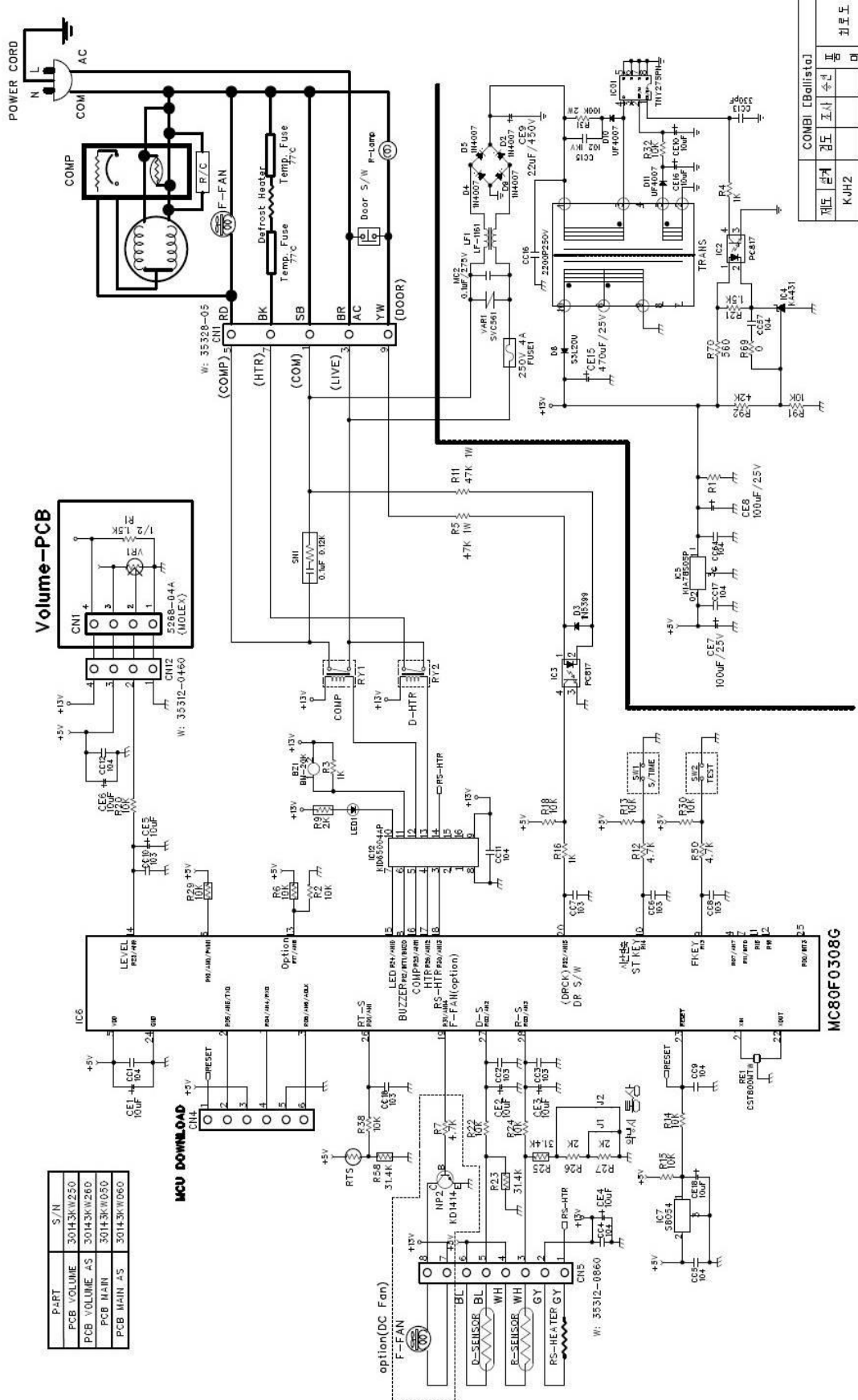

PART	S/N
PCB VOLUME	30143K/W250
PCB VOLUME AS	30143K/W260
PCB MAIN	30143K/U050
PCB MAIN AS	30143K/W060

COMBI [Ballistat]			
제도	상자	품	명
KJH2			

2-1. "PCB VOLUME" Control	
INPUT	CONTROL OBJECT
- Turn 'DIAL KNOB' on the 'COVER M/FLOW DUCT'.	-PCB Volume
<p>- Temperature is controlled by "PCB Volume" assembled with "Dial Knob".</p> <p>- 12step(0step ~ 11step) mode of successive temperature mode</p> <p>- Each model is different using range. RN_271 Model: step 0 ~ step 10 RN_331 Model: step 1 ~ step 11</p> <p>- Features are model dependent (Below is RN-271 model) <COVER M/FLOW DUCT AS: Air Duct Device in the Refrigerating Compartment></p>	

2-2. Temperature Control of Refrigerator Compartment												
INPUT						CONTROL OBJECT						
- Turn 'DIAL KNOB' - R sensor						- COMPRESSOR - FAN						
A. COMP and FAN will be controlled by the on/off condition of each mode.												
B. Temperature Difference of Refrigerator each step :												
STEP	0	1	2	3	4	5	6	7	8	9	10	11
ON(°C)	8.19	7.52	6.85	6.18	5.51	4.84	4.17	3.5	2.83	2.16	1.49	0.82
OFF(°C)	0.19	-0.48	-1.15	-1.82	-2.49	-3.16	-3.83	-4.5	-5.17	-5.84	-6.51	-7.18

C. Temperature of Refrigerator at Mid-'Dial Knob' OFF point :

- RN_271 Model : -3.16°C,
- RN_331 Model: -3.83°C

D. Refrigerator ON/OFF Temp.
Difference: 8.0C

E. Temperature of Freezer Control
-It will be only controlled by using "KNOB F LOUVER" in the Freezer Comaprtnent.

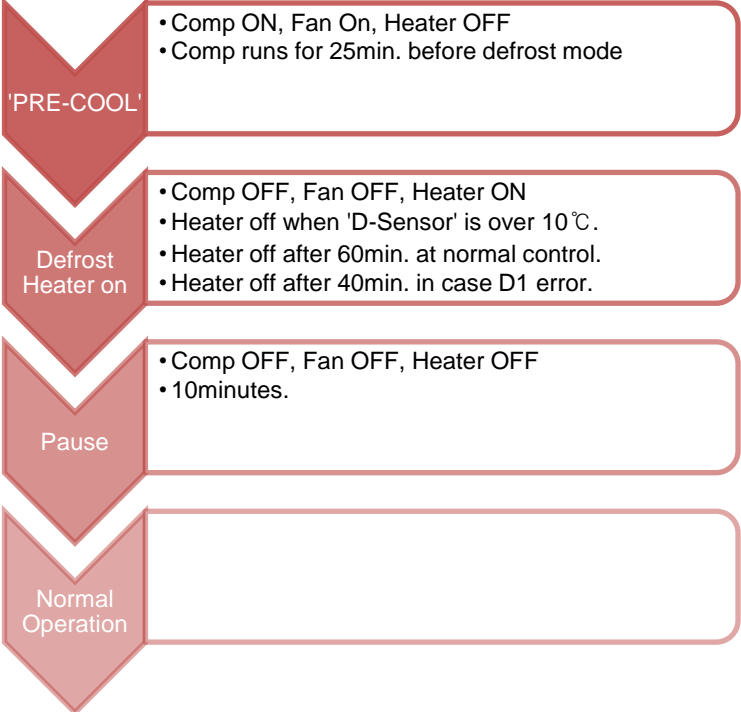
2-3. Defrost Mode	
INPUT	CONTROL OBJECT
<ul style="list-style-type: none"> - Accumulated Compressor Run Time - Running Time Ratio of Compressor - Accumulated Door Open Time - Ambient temperature (RT) 	<ul style="list-style-type: none"> - Compressor - F Fan - Defrost Heater
<p>A. Defrost Mode Operation condition</p> <p>(1) In case accumulated compressor run times: 6, 8, 10, 12 hours,</p> <ul style="list-style-type: none"> - when there occur any errors: R1, D1, C1, RT, Door SW error etc. (Check "2-9. ERROR DISPLAY") - or, running rate of COMP (per 2hrs of accumulated operation time) is more than 90% - or, accumulated door open time is over 2 minutes - or, ambient temperature (RT) is more than 38 °C <p>(2) Even if the above condition is not satisfied, defrost mode starts immediately when accumulated compressor run time is 14hrs.</p> <p>B. Normal Defrost Mode</p>  <pre> graph TD A["PRE-COOL • Comp ON, Fan On, Heater OFF • Comp runs for 25min. before defrost mode"] --> B["Defrost Heater on • Comp OFF, Fan OFF, Heater ON • Heater off when 'D-Sensor' is over 10°C. • Heater off after 60min. at normal control. • Heater off after 40min. in case D1 error."] B --> C["Pause • Comp OFF, Fan OFF, Heater OFF • 10minutes."] C --> D["Normal Operation"] </pre> <p>C. Forced Defrost Mode</p> <ul style="list-style-type: none"> - How to start: <ol style="list-style-type: none"> (1) by press Door S/W for continuously and Control 'Dial Knob'(MIN -> MAX) 1 times. (2) or, by press 'Test Key' 3 times on Main PCB - If appliance has any error, Forces Defrost Mode don't start. - Process: same as Normal Defrost Mode except 'PRE-COOL' ※ Heater is supposed to be on Initial 30sec. even though the temp. at "D SENSOR" is over 13 °C. (for TEST) - How to confirm: If Force Defrost Mode start, you can buzzer sound 	

2-3. Defrost Mode

D. Flow chart of How to Start Defrost Mode

- ※ A.C.R.T. : Accumulated Compressor Run Times
- ※ R.R.O.C. : Running Rate of Compressor
- ※ RT: Ambient temperature

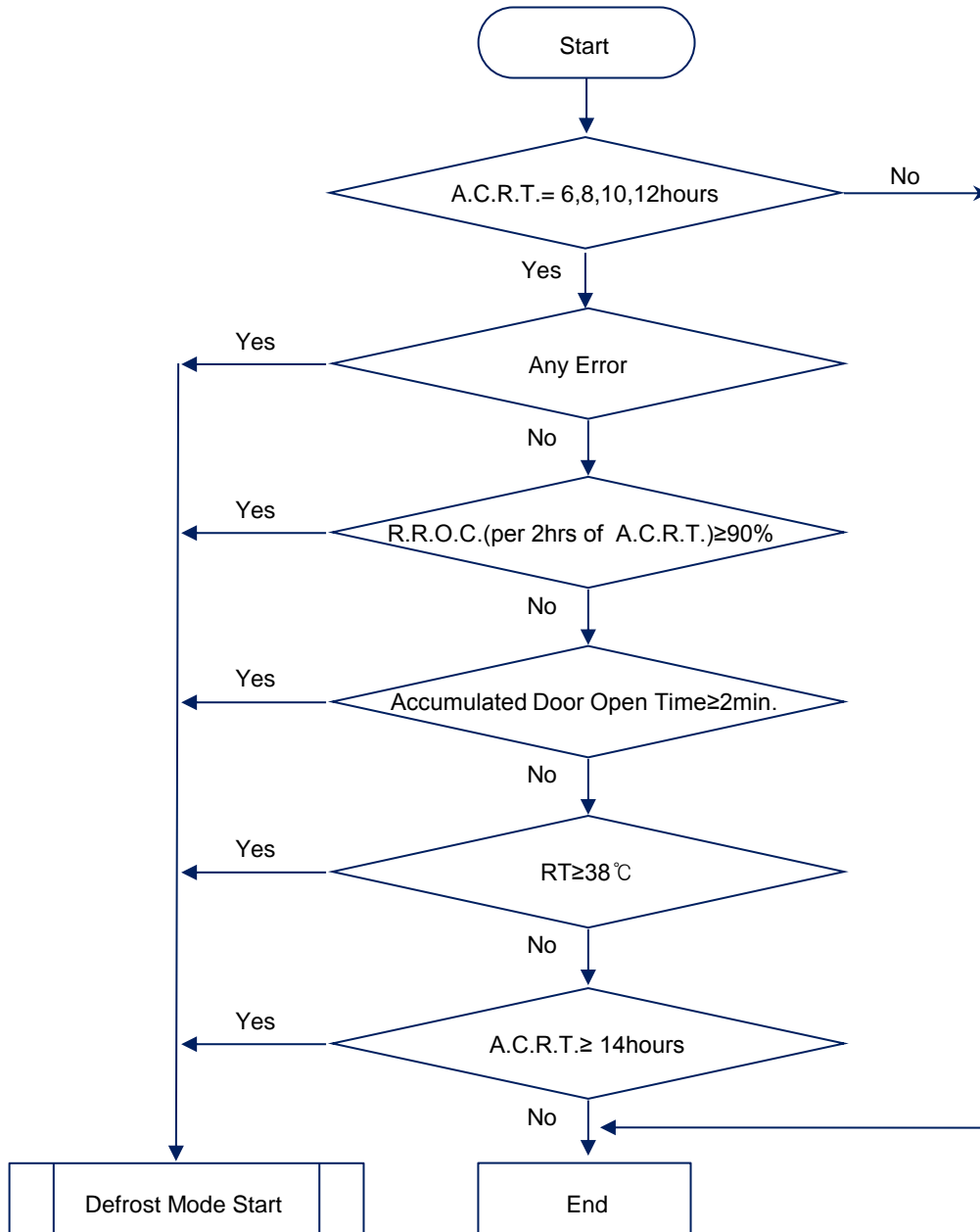

2-4. Function of Low Ambient Temperature (RT)	
INPUT	CONTROL OBJECT
RT	- R HTR - COMP
<p>A. Condition of LOW RT</p> <ul style="list-style-type: none"> - RT sensor below 19°C - When the RT sensor is over 20°C, the system comes to be "General Operation Mode". - When the RT sensor is between 19°C to 20°C, the system keeps the previous mode. <p>B. Control</p> <ul style="list-style-type: none"> - When the temp of RT sensor is between 14°C to 19°C, COMP on/off temp is 3°C UP - When the temp of RT sensor is below 14°C, COMP ON/OFF temp is 4°C UP 	

2-5. Prevention of Compressor Restart	
INPUT	CONTROL OBJECT
N/A	COMP
<p>It takes several minutes to protect Compressor:</p> <ul style="list-style-type: none"> (1) 6 minutes after Comp off (2) 30 minutes at operation of Low RT, but 6 minutes when the doors open more than 20 seconds 	

2-6. Buzzer Sound	
INPUT	CONTROL OBJECT
<ul style="list-style-type: none"> - Forced Defrost Mode start - Door Switch - Initial Power Input 	Buzzer
<p>A. When Forced Defrost Mode start, the buzzer rings 3times. B. After 2 minutes power's on, the buzzer rings 3 times. C. At Short Circuit Test, the buzzer rings 1 times. D. When door opens, the buzzer rings every 1 minute for 5 minutes.</p>	

2-7. Time Saving Function

INPUT	CONTROL OBJECT
"FAST KEY"	Buzzer

A. How to Save

- 1 min : Click FAST KEY one time on MAIN PCB.
- 30 min : If you press FAST KEY continuously, you can reduce 30 minutes on each 2.5 seconds with buzzer.

B. Example for usage: when reduce test time

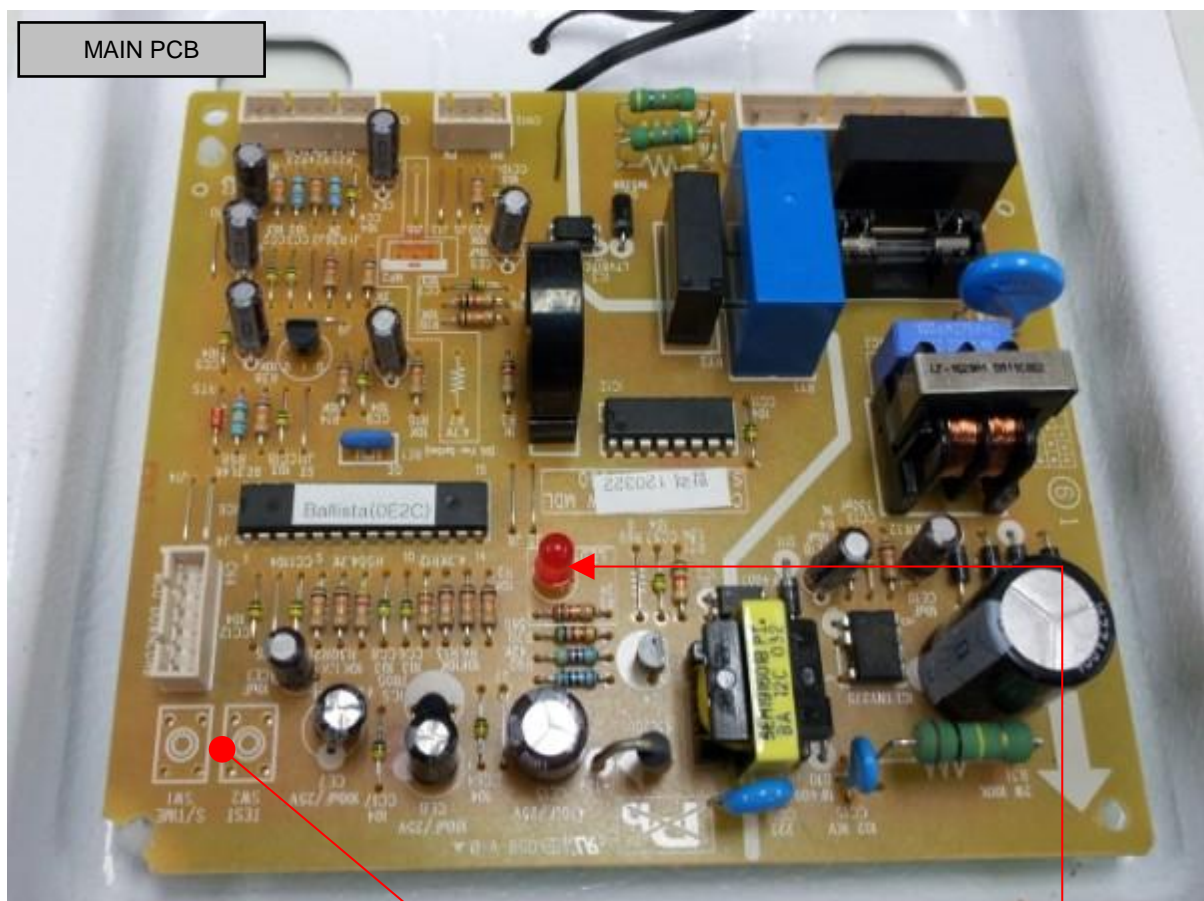

Fast Key
(purchased separately)

Test Key
(purchased separately)

LED

2-8. Control of R-sensor OFF Point

INPUT	CONTROL OBJECT
"J1", "J2" On Main PCB	Control Resistance of R sensor OFF Point

- When the refrigeration of refrigerator is poor or weak though Fan and COMP are working continuously, the following actions are recommended for service.

- (1) Resistance (R25) : Default resistance (31.4Kohms)
- (2) Resistance (R26) : Cut the "J1" off to reduce basic resistance by 1.5°C. (2Kohms up)
- (3) Resistance (R27) : Cut the "J2" off additionally to reduce basic resistance by 1.5°C. (total 4Kohms up)

※ R25 = R-SENSOR OFF point



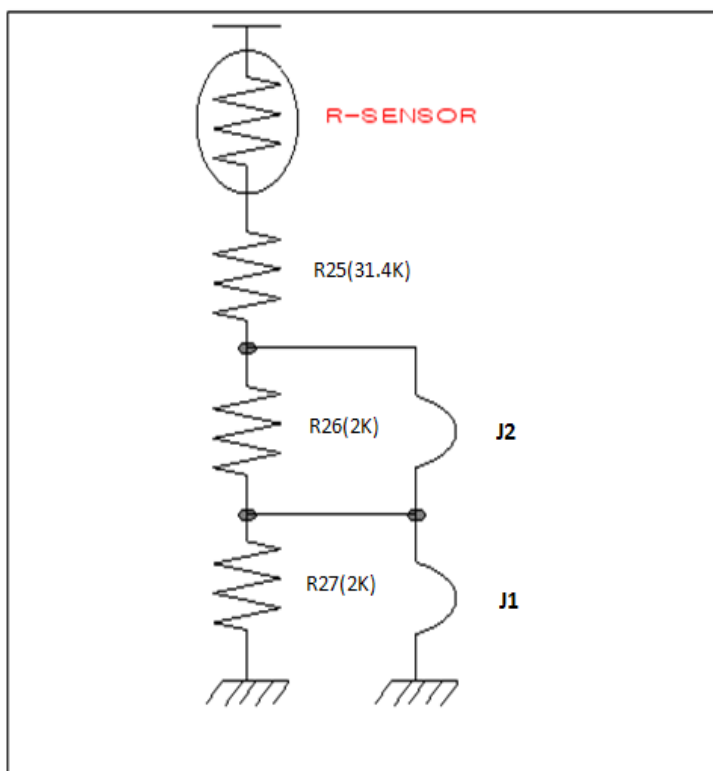

R25 + R26 = R-SENSOR OFF point - 1.5°C

R25 + R26 + R27 = R-SENSOR OFF point - 3°C









2-9. Error Display																										
INPUT	CONTROL OBJECT																									
Sensor Error	LED Lamp																									
<p>- ERROR DISPLAY</p> <ul style="list-style-type: none"> - If appliance has any errors, LED on the Main PCB is flickering. - If the appliance is normal (no error), LED IS off. <p>A. 'R1' ERROR</p> <p>: It happens when R-Sensor is OPEN or SHORT.</p> <p>(1) LED DISPLAY: Shortly flickering(0.3sec.) 1 times.</p> <p>(2) CONTROL:</p> <p>Controlled by the following condition of RT</p> <table border="1"> <thead> <tr> <th>RT sensor TEMP (unit:°C)</th> <th>~13</th> <th>~19</th> <th>~29</th> <th>29~</th> </tr> </thead> <tbody> <tr> <td>COMP. Operating ON/OFF TIME (unit:min.)</td> <td>6/34</td> <td>10/30</td> <td>16/24</td> <td>20/20</td> </tr> </tbody> </table> <p>※ If 'RT ERROR' happens at the same time, "COMP. ON/OFF Operating Time" is 16min/24min.</p> <p>(3) RELEASE: When R-Sensor is working normally.</p> <p>B. 'RT' ERROR</p> <p>: It happens when RT-Sensor is OPEN or SHORT.</p> <p>(1) LED DISPLAY: Shortly flickering(0.3sec.) 2 times.</p> <p>(2) CONTROL: Delete the conditions of 'RT-sensor Control' and operate normally.</p> <p>(3) RELEASE: When RT-Sensor is working normally.</p> <p>C. 'd1' ERROR</p> <p>: It happens when D-Sensor is OPEN or SHORT.</p> <p>(1) LED DISPLAY: Shortly flickering(0.3sec.) 3 times.</p> <p>(2) CONTROL: Return to next limit defrost time (40 min)</p> <p>(3) RELEASE: When D-Sensor is working normally.</p> <p>D. 'DR' ERROR</p> <p>: It happens when the system senses door opens more than 1 hour.</p> <p>(1) LED DISPLAY: Shortly flickering(0.3sec.) 4 times.</p> <p>(2) CONTROL: Delete function relating to door switch sensing</p> <p>(3) RELEASE: When sensing close from door S/W.</p> <p>※ When pusing 'TEST KEY' on the main PCB, LED is long(1.0sec.) flickering several times. ex. 'Forced Defrost Mode:' long flickering 2 times</p> <div style="text-align: right; margin-right: 20px;">  </div> <table border="1" style="margin-left: auto; margin-right: auto;"> <thead> <tr> <th>CODE</th> <th>LED</th> <th>ERROR</th> </tr> </thead> <tbody> <tr> <td>R1</td> <td>1time</td> <td>R sensor</td> </tr> <tr> <td>RT</td> <td>2times</td> <td>RT sensor</td> </tr> <tr> <td>d1</td> <td>3times</td> <td>D sensor</td> </tr> <tr> <td>DR</td> <td>4times</td> <td>DR Switch</td> </tr> </tbody> </table> <div style="margin-left: auto; margin-right: auto; margin-top: 10px;"> <p>- To Confirm Errors: Check LED on the main PCB</p> <p>- The Priorities of Error : R1→RT→D1→DR</p> </div>		RT sensor TEMP (unit:°C)	~13	~19	~29	29~	COMP. Operating ON/OFF TIME (unit:min.)	6/34	10/30	16/24	20/20	CODE	LED	ERROR	R1	1time	R sensor	RT	2times	RT sensor	d1	3times	D sensor	DR	4times	DR Switch
RT sensor TEMP (unit:°C)	~13	~19	~29	29~																						
COMP. Operating ON/OFF TIME (unit:min.)	6/34	10/30	16/24	20/20																						
CODE	LED	ERROR																								
R1	1time	R sensor																								
RT	2times	RT sensor																								
d1	3times	D sensor																								
DR	4times	DR Switch																								

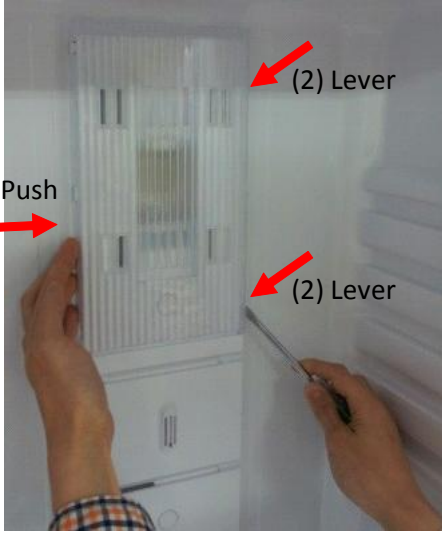

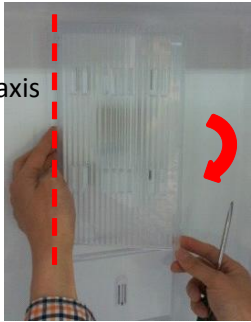

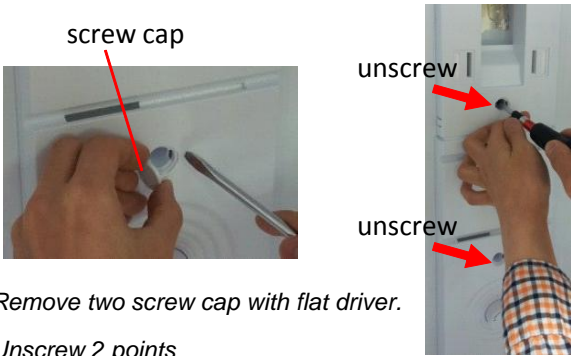
3-1. Door Switch

No	Procedure	No	Procedure
1	 <p><i>Inuput a thin driver in the upper part as above picture. And lift up 'Door Switch' carefully.</i></p>	3	
2	 <p><i>Inuput a thin driver in the lower part as above picture. And lift up 'Door Switch' carefully.</i></p>		 <p><i>Disconnect the wire housing.</i></p>

3-2. Cover Multi-Flow Duct As (in Fresh food Compartment)

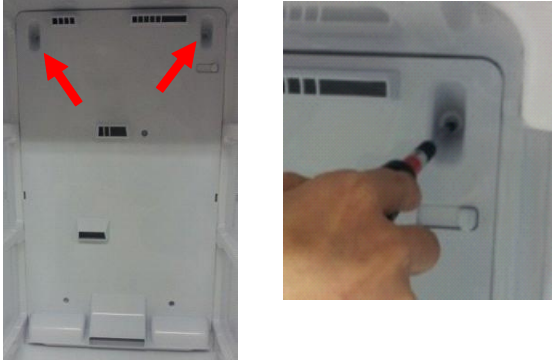
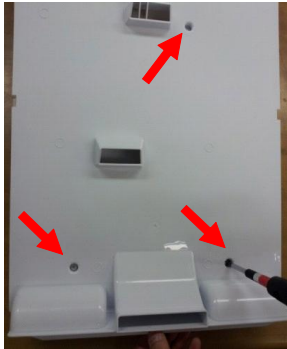

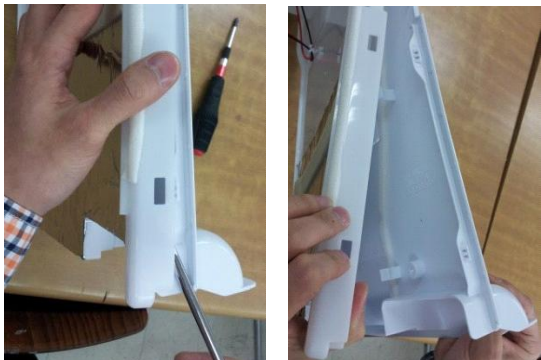

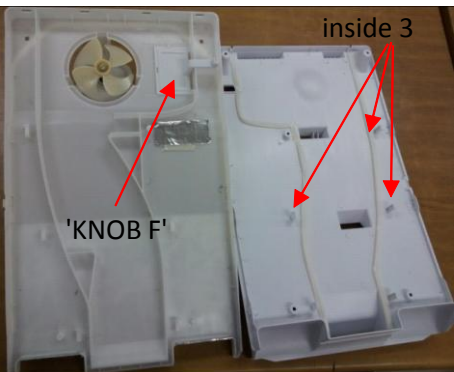
No	Procedure	No	Procedure
1	 <p>Unlock the lamp window (1) Push the window right side (2) Lever two window lock with flat driver</p>	4	 <p>Unlock the 'COVER M/FLOW DUCT' (1) Check the marks of locking position on 'Cover'. (Number of the marks are model dependent) (2) Push the 'cover' inside and Unlock.</p>
2	 <p>Open window turning on the axis 'A'</p>	5	
3	 <p>Remove two screw cap with flat driver. Unscrew 2 points</p>		 <p>Disconnect the Lamp & Sensor wire housing.</p>

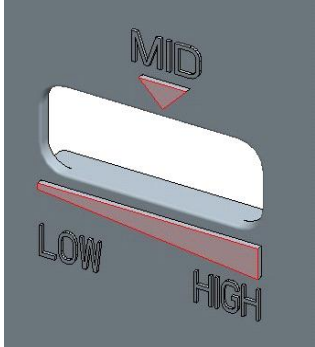
3-3. Louver F As (in Frozen Food Compartment)



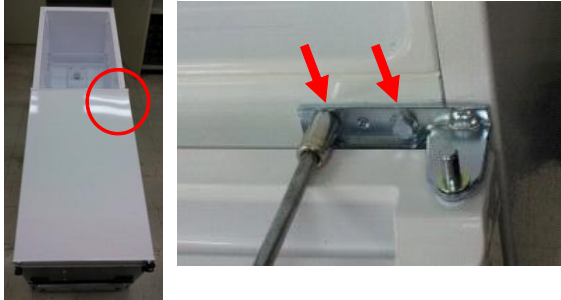

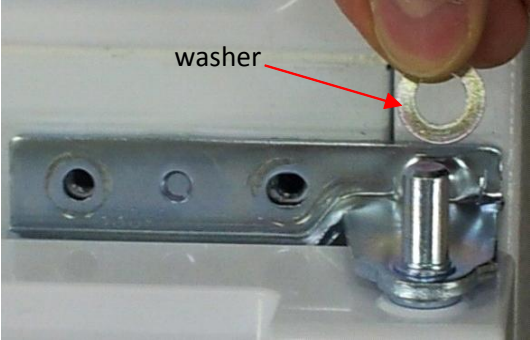
No	Procedure	No	Procedure
1	 <p>Unscrew to disassemble the 'Louver F As' from Freezer.</p>	4	 <p>Unscrew to disassemble as each component part.</p>
2	 <p>Remove the 'Louver F As' pulling the top side.</p>	5	 <p>Unlock carefully. (especially, inside 3 locks)</p>
3	 <p>Disconnect Fan motor wire housing.</p>		 <p>※Default position of 'KNOB F' is 'MID'</p>



3-4. DOOR F/R

No	Procedure	No	Procedure
1	 <p>Tilt down the appliance to the rear.</p>	4	 <p>Remove door in fresh food compartment. And unscrew middle hinge.</p>
2	 <p>Lift up top cover hinge to remove.</p>	5	 <p>※ Don't forget the washer for middle hinge.</p>
3	 <p>Unscrew and remove top hinge.</p>	5	 <p>Lift up middle cover hinge to remove.</p>

3-4. DOOR F/R

No	Procedure	No	Procedure
6	 <p data-bbox="193 1167 561 1193"><i>Unscrew and remove under hinge.</i></p>	7	 <p data-bbox="863 1167 1401 1193"><i>Turn the 'Adjusting Leg (Left)' CCW and Remove.</i></p>
	 <p data-bbox="193 1601 663 1720"> ※ Don't forget the washer for under hinge. ※ The washer for under hinge's bigger than middle one. </p>	8	 <p data-bbox="863 1693 1321 1720"><i>Remove door in frozen food compartment.</i></p>

4. How To Change Door Position

Features are model dependent (Below is RN-271 model)

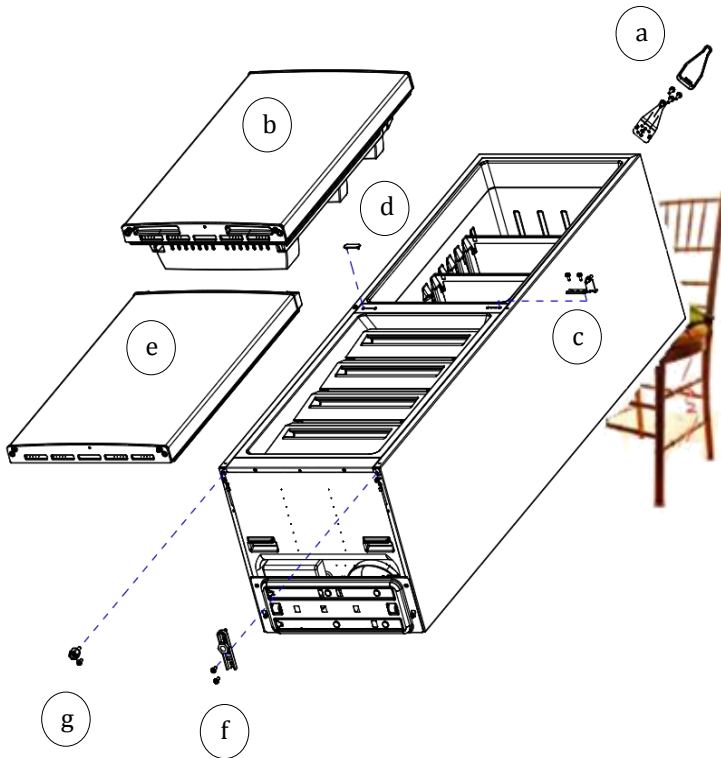

1-1> Tilt down the appliance to the rear.
(Watch out for "Pipe Wire Condensor" damage.)

1-2> Disassemble following parts in order.

- 'Top Cover Hinge' and 'Top Hinge'(a)
- 'Refrigerator Door'(b)
- 'Middle Hinge'(c)
- 'Middle Cover Hinge'(d)
- 'Freezer Door'(e)
- 'Under Hinge'(f)
- 'Adjusting Leg '(g)

1-3> Move following 'Door Accessories' in the opposite position:

- 'Cover Bushings'(i)
- 'Door Stoppers'(j)

1-4> Change the position of following parts each other and assemble them:

'Adjusting Leg '(g) & 'Under Hinge'(f)

1-5> Level and assemble the 'Freezer Door'(e)

1-6> Change the position of following parts each other and assemble them:

'Middle Cover Hinge'(d) & 'Middle Hinge'(c)

1-7>

Level and assemble the 'Refrigerator Door'(b).

1-8>

Assemble following parts on the opposite side:

'Top Cover Hinge' and 'Top Hinge'(a)

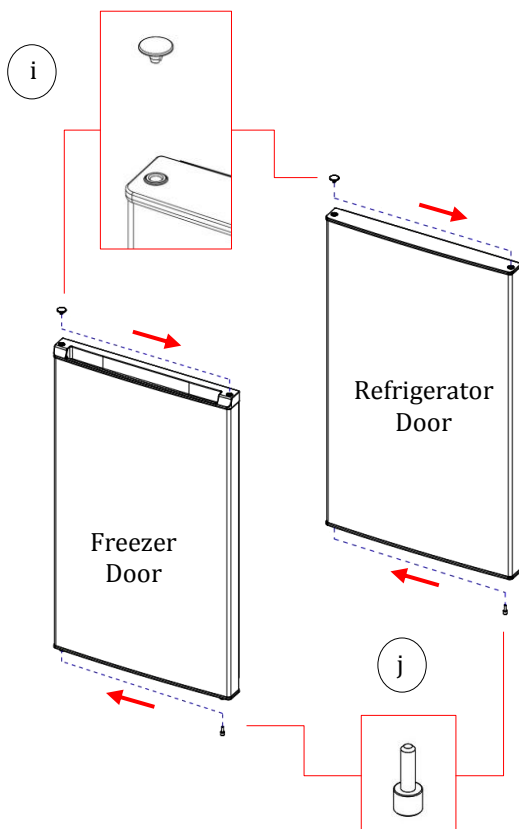

5-1. Safety Warning (R-600a Refrigerant Models Only)









This appliance contains a certain amount of isobutane refrigerant (R600a) a natural gas with high environmental compatibility that is, however, also combustible.

When transporting and installing the appliance, care should be taken to ensure that no parts of the refrigerating circuit are damaged.

Refrigerant squirting out of the pipes could ignite or cause an eye injury. If a leak is detected, avoid any naked flames or potential sources of ignition and air the room in which appliance is standing for several minutes.

- In order to avoid the creation of a flammable gas-air mixture if a leak in the refrigerating circuit occurs, the size of the room in which the appliance may be sited depends on the amount of refrigerant used. The room must be 1m³ in size for every 8g of R600a refrigerant inside the appliance. The amount of refrigerant is shown on the identification plate inside the appliance.
- Never start up an appliance showing any signs of damage. If in doubt, consult your dealer.



5-2. Tools

<p>1. R-600a ref. Can</p> 	<p>2. Can adapter</p> 	<p>3. Pinch Plier</p> 
<p>4. Ref. discharging hose</p> 	<p>5. Vacuum pump</p> 	<p>6. Welder</p> 
<p>7. Coupling Pipe</p> 	<p>8. Leakage Tester</p> 	<p>9. Electronic-scale</p> 

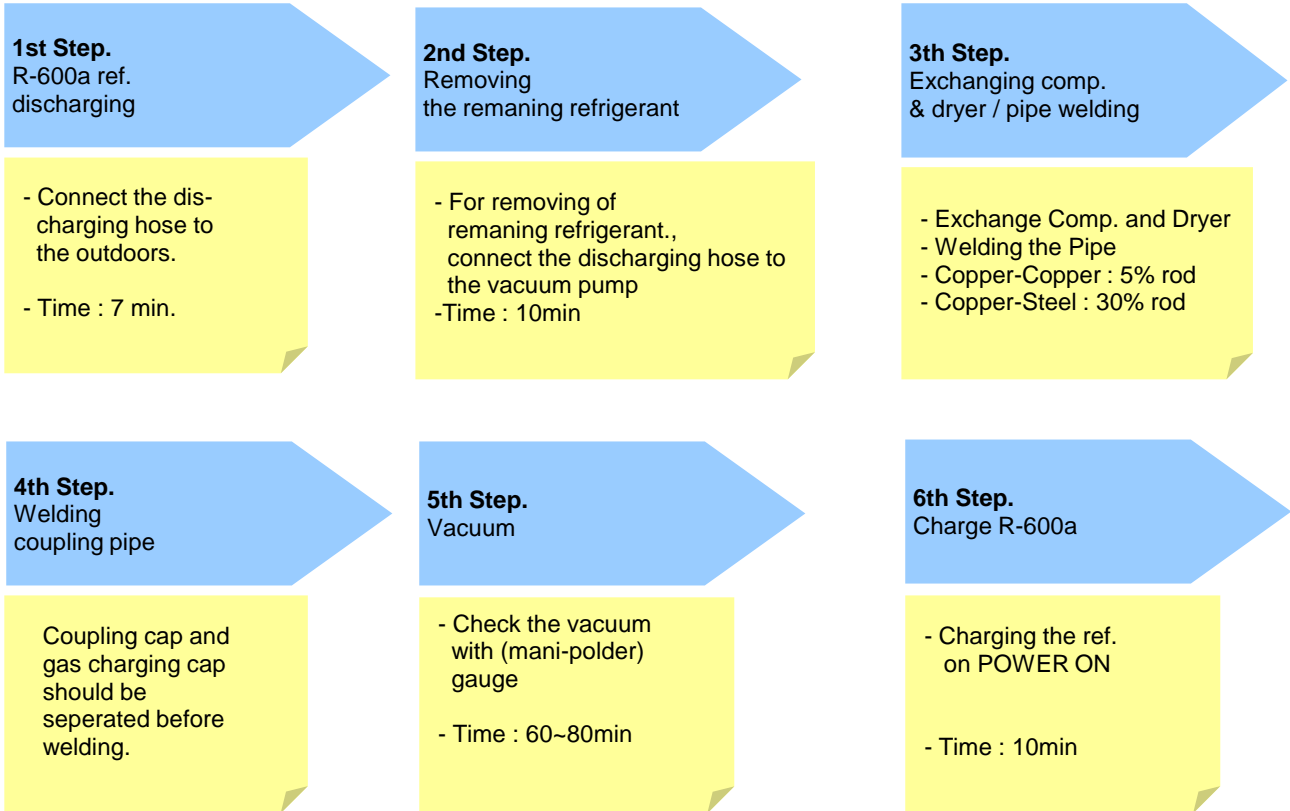



5-3. Process Summary





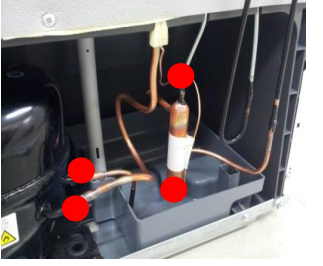

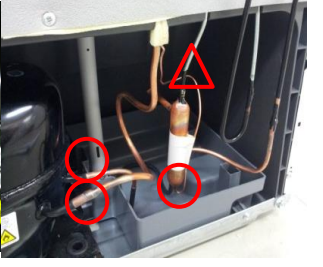
5-4. In Detail Precess

NO.	SVC process	Image	Details
1	Connecting the pinch-plier & discharging hose		<ol style="list-style-type: none"> 1. Connect the discharging hose to the pinch-plier 2. The outlet of discharging hose should be placed to the outdoor(window)
2	Fixing the pinch-plier & charging pipe		<ol style="list-style-type: none"> 1. Fix the pinch-plier to the compressor charging pipe. 2. Pinch-plier should not be moving freely. <p>※ If that is moving freely, it would cause fire/explosion as leakage gas in the room.</p>
3	Discharging the R-600a ref.		<ol style="list-style-type: none"> 1. Discharge the R-600a ref. to outdoor. [Befor connecting the vacuum pump] <p>※ It should have enough time more than 7 minutes to discharge.</p>



5. How To Charge R-600a Refrigerant

NO.	SVC process	Image	Details
4	Removing the remaining ref.		<p>1. And then, connect the vacuum pump to the outlet of discharging hose</p> <p>※ Vacuum pump should be placed at the outdoor where is able to clear air easily.</p> <p>※ It should have enough time more than 10 minutes to discharge.</p>
5	Removing the pinch-plier & pipe		<p>1. Disassemble the each pipe (Del-pipe, Suc-pipe, Capi-pipe, Dryer & Hot-pipe)</p> <p>※ Caution ; A part is easily damaged by flame so that disassembly should be done carefully.</p>
6	Exchanging comp & dryer		<p>1. Change the comp. & dryer.</p> <p>※ You should check the comp. spec. and assemble correctly.</p>
7	Welding	 	<p>1. Weld the each pipe.</p> <p>※ ○ Copper-Copper welding - 5% rod △ Copper-Steel welding - 35% rod</p>
8	Disassembly of charging valve (Coupling pipe)		<p>1. Decap the coupling pipe cap and disassemble the valve ass'y.</p> <p>※ If you don't disassemble, the coupling rubber would be melted.</p>

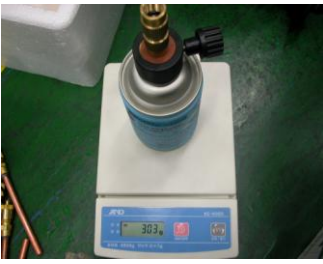
5. How To Charge R-600a Refrigerant

NO.	SVC process	Image	Details
9	Coupling pipe welding		<p>1. Weld after inserting the coupling pipe to the compressor.</p> <p>※ Use the wet cloth for preventing the other part of machinery-room from damage.</p>
10	Valve reass'y & guage connecting		<p>1. Reassemble the valve ass'y with coupling pipe to clockwise.</p> <p>2. Connect the blue hose of the guage to the coupling pipe and the yellow hose to the vacuum pump.</p> <p>3. Open the blue guage lever and start the vacuum pump</p>
11	Vacuum		<p>1. Be vacuumed the cycle with pump.</p> <p>※ Time : 60~80min</p> <p>=> If the vacuum time is less than 60min, ref. COP & air coolong would be weak.</p>
12	Check		<p>1. Check the guage : -76_{cm}Hg</p> <p>※ If the cycle is not vacuumed, it would be leak.</p>
13	Adjusting the amounts of refrigerants (R-600a can)		<p>1. Check the amounts of R-600a can with scale and discharge the surplus ref.</p> <p>※ Discharging is surely done at the outdoor where is able to clear air.</p> <p>※ Tip of adjusting.</p> <ul style="list-style-type: none"> - Can total weight :160g(Can 75g+Ref. 85g) - Adapter : 145g <p>=> Total : 305g</p> <ul style="list-style-type: none"> - The amounts of charging : 79g <p>=> Discharging : 6g => Total : 299g</p>

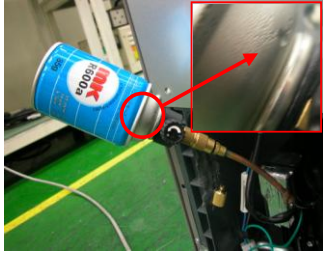
5. How To Charge R-600a Refrigerant

NO.	SVC process	Image	Details
14	Connecting of coupling pipe & adapta		<ol style="list-style-type: none"> 1. Conect can adapter to the coupling pipe. 2. Charge the ref. with open lever slowly. <p>※ Refrigerant should never leak in the room.</p>
15	Charging		<ol style="list-style-type: none"> 1. On the power of refrigerator and then start to charge the ref. (10min) <p>※ Charge the ref. until going out the water vapour condensing on the can outlet.</p>
16	Leakage Test		<ol style="list-style-type: none"> 1. Check the leakage. <p>※ You must rework from Step.1 when the leakage is detected.</p>
17	Finish		<ol style="list-style-type: none"> 1. Clean and clear around the machinery room when the service is finished. 2. Assemble the machinery room cover.

6. PART LIST

6-1. Cabinet / Evaporator / Compressor Compartment

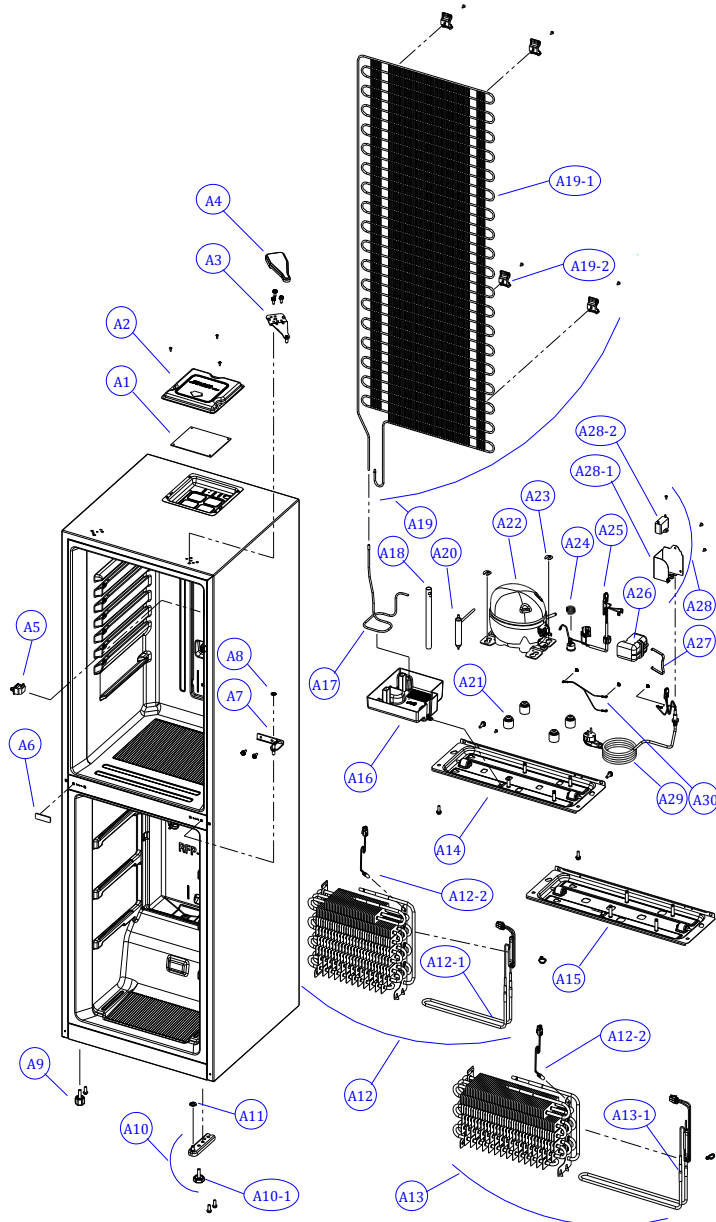

NO	PART-CODE	PART NAME	SPEC.	Q'ty	
				RN_27*	RN_33*
A1	30143KW060	PCB MAIN AS	RFP-301	1	1
A2	301149CB00	COVER M/PCB BOX AS	SECC (WHITE)	1	1
	301149CB10		SECC (GRAY)		
	301149CB20		SECC (BLACK)		
A3	3012937900	HINGE *T AS	RFP-301	1	1
A4	3001448500	COVER HI *T	PP (WHITE)	1	1
	3001448510		PP (GRAY)		
	3001448520		PP (BLACK)		
A5	301179DP00	DOOR S/W AS	HC-050K4 250V2.5A	1	1
A6	3010937720	CAP DV HI HOLE *M	HIPS	1	1
A7	3012938000	HINGE *M AS	RFP-301	1	1
A8	3016044410	SPECIAL WASHER *M HI	SGCC, T1.0 x I.D9.0 x O.D15	1	1
A9	3012106500	FOOT ADJ *L AS	PP+INSERT	1	1
A10	3012938100	HINGE *U AS	RFP-301	1	1
A10-1	3012105300	FOOT ADJ AS	PP+INSERT	1	1
A11	3816000200	SPECIAL WASHER	SPCC T1.0 x O.D21 x I.D8 MFZN	1	1
A12	3017069800	EVA AS	RFP-241(230V 130W)	1	0
A12-1	3012831100	HEATER SHEATH AS	RFP-241(230V 130W)	1	0
A12-2	3012764100	HARNESS D SENS	RFP-340(NBC-K43-24)	1	1
A13	3017070000	EVA AS	RFP-301(230V 130W)	0	1
A13-1	3012831200	HEATER SHEATH AS	RFP-301(230V 130W)	0	1
A14	3010365200	BASE COMP AS	RFP-241	1	0
A15	3010365500		RFP-301	0	1
A16	301119VJ00	CASE VAPORI AS	RFP-301	1	1
A17	3014479400	PIPE CONN A	DUCT1-0 OD4.76*TO.5	1	1
A18	3012513950	HOSE DRN B	PVC	1	1
A19	3014480010	PIPE WI-CON AS	RFP-301	1	1
A19-1	3014480000	PIPE WI-CON SAS	RFP-301	1	1
A19-2	3012041500	FIXTURE W-ICON	HIPS	4	4
A20	3016808200	DRYER AS	10G, SINGLE TUBE	1	1
A21	3010103400	ABSORBER COMP	RUBBER	4	4
A22	3956188C50	COMPRESSOR	LZ88CY(QLZ12Y) 220-240V 50HZ	1	1
A23	4019H09031	SPECIAL WASHER	SWRH	2	2
A24	3015103900	SPRING OVERLOAD PROTECTOR	LZ88CY OLP FIXING	1	1
A25	3018134600	SWITCH P RELAY AS	B60-120, QP2-15C(RSCR DONPER)	1	1
A26	3811402600	COVER RELAY	LZ88CY	1	1
A27	3015103800	SPRING COVER RELAY	LZ88CY COVER RELAY FIXING	1	1
A28	3010583700	BOX POWER AS	RFP-301(400V/4UF)	1	1
A28-1	3010552101	BOX POWER	GI/TO.5	1	1
A28-2	3016406010	CAPACITOR RUN	DMF-40405(400V 4UF)	1	1
A29	3011349001	CORD POWER AS	BS-1363A,M-240(N),250V/13A,BLACK	1	1
	3011348111	*dependent on the contry	FR-290, 250V 10/16A		
A30	3012763210	HARNESS EARTH COMP	FRM-241, L140	1	1

* Please check the color, some parts code color dependent.

6. PART LIST

6-2. Frozen Food Compartment

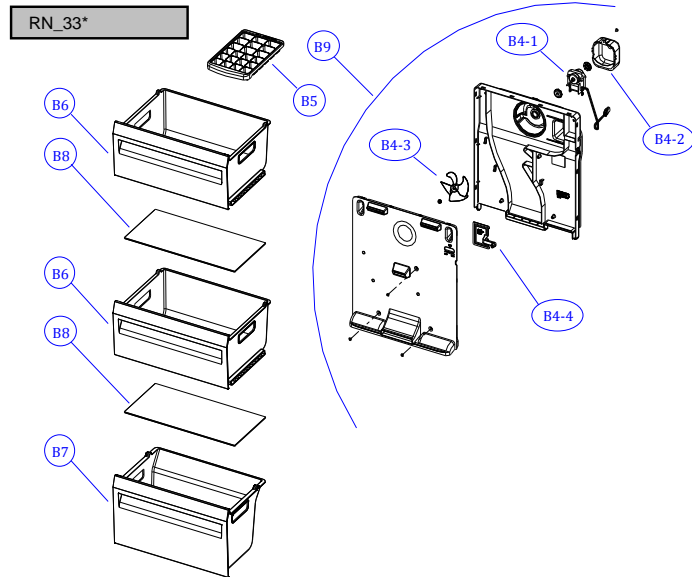
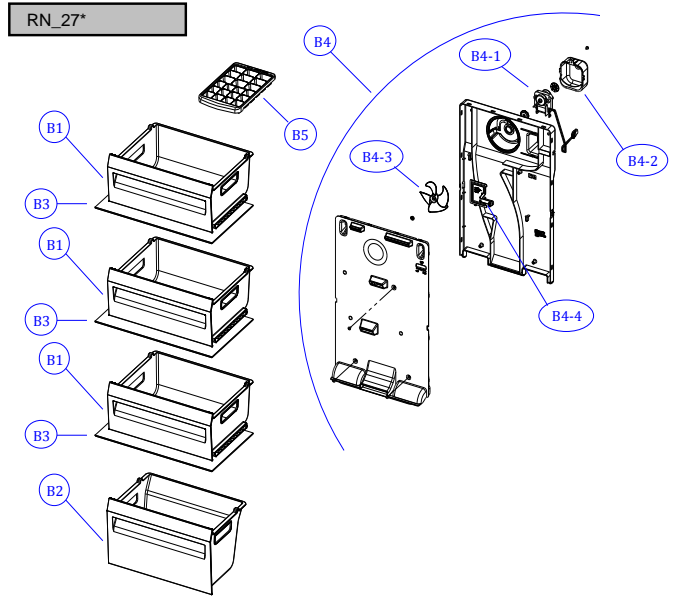

NO	PART-CODE	PART NAME	SPEC.	Q'ty	
				RN_27*	RN_33*
B1	301119UX00	CASE F A	GPPS(CRYSTAL)	3	0
	301119UX10		GPPS(GRAY)		
	301119UX20		GPPS(BLUE)		
B2	301119UY00	CASE F B	GPPS(CRYSTAL)	1	0
	301119UY10		GPPS(GRAY)		
	301119UY20		GPPS(BLUE)		
B3	3017861400	SHELF GLAS F	GLASS T3.2 RFP-241	3	0
B4	3018932200	LOUVER F AS	RFP-241(AC 230V 50HZ)	1	0
B4-1	3015922200	MOTOR F AS	AC220V/50HZ,2500RPM	1	1
B4-2	3010664700	BRACKET FAN MOTR	PP, T2.0 (AC)	1	1
B4-3	3011835900	FAN	OD100,SHAFT OD3.17	1	1
B4-4	3013415800	KNOB F CONTL	PP	1	1
B5	3010564910	CASE ICEING AS	CASE ICEING+VINYL	1	1
B6	301119V100	CASE F A	GPPS(CRYSTAL)	0	2
	301119V110		GPPS(GRAY)		
	301119V120		GPPS(BLUE)		
B7	301119V200	CASE F B	GPPS(CRYSTAL)	0	1
	301119V210		GPPS(GRAY)		
	301119V220		GPPS(BLUE)		
B8	3017861500	SHELF GLAS F	GLASS T3.2 RFP-301	0	2
B9	3018932500	LOUVER F AS	RFP-301(AC 230V 50HZ)	0	1

* Please check the color, some parts code color dependent.

6. PART LIST

6-3. Fresh Food Compartment

RN_27*

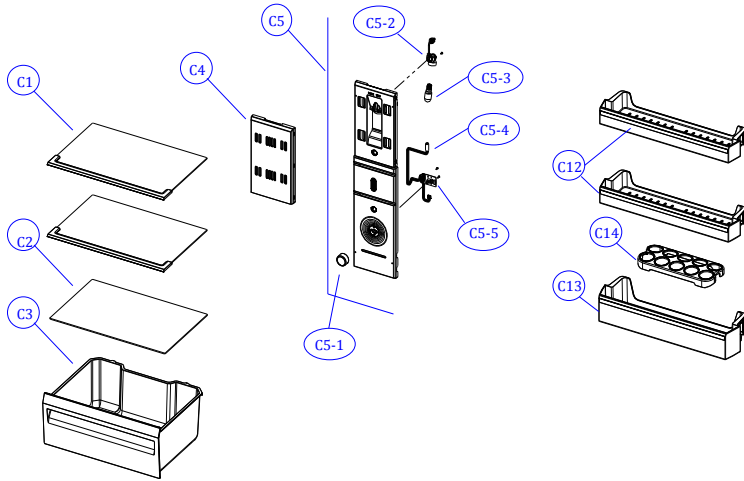

RN_33*

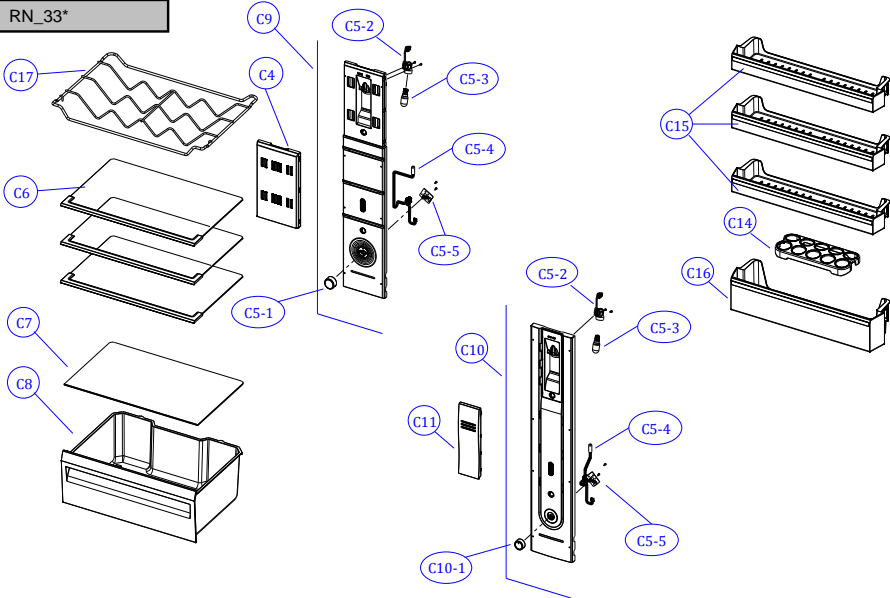

NO	PART-CODE	PART NAME	SPEC.	Q'ty		
				RN_27*	RN_331/2/3/4/5/6	RN_33 NEW
C1	3017860900	SHELF R AS	RFP-241	2	0	0
C2	301119U200	CASE GLAS VEGTB	T3.2	1	0	0
C3	301119UW00	CASE VEGTB	GPPS(CRYSTAL)	1	0	0
	301119UW10		GPPS(GRAY)			
	301119UW20		GPPS(BLUE)			
C4	3015523800	WINDOW M/FLOW DUCT	GPPS	1	1	0
C5	3001448400	COVER M/FLOW DUCT AS	RFP-241	1	0	0
C5-1	3013415700	KNOB R CONTL	HIPS + PRINT	1	1	0
C5-2	3017903900	SOCKET LAMP AS		1	1	1
C5-3	3013600020	LAMP AS	15W (E14,CC7A)	1	1	1
C5-4	3012783300	HARNESS PCB VOLUME AS	R SENSOR' + 'Wire lead'	1	1	1
C5-5	30143KW260	PCB VOLUME AS	BALLISTA VOLUME	1	1	1
C6	3017861100	SHELF R AS	RFP-241	0	3	3
C7	301119V400	CASE GLAS VEGTB	T3.2	0	1	1
C8	301119V000	CASE VEGTB	GPPS(CRYSTAL)	0	1	1
	301119V010		GPPS(GRAY)			
	301119V020		GPPS(BLUE)			
C9	301149C400	COVER M/FLOW DUCT AS	RFP-301	0	1	0
C10	301149CE00	COVER M/FLOW DUCT AS	RFP-30F	0	0	1
C10-1	3013415900	KNOB R CONTL	HIPS, RFP-30F	0	0	1
C11	3015523900	WINDOW M/FLOW DUCT	GPPS	0	0	1
C12	3019068500	POCKET R	GPPS(CRYSTAL)	2	0	0
	3019068510		GPPS(GRAY)			
	3019068520		GPPS(BLUE)			
C13	3019068600	POCKET J	GPPS(CRYSTAL)	1	0	0
	3019068610		GPPS(GRAY)			
	3019068620		GPPS(BLUE)			
C14	3011190800	CASE EGG TRAY	GPPS(CRYSTAL)	1	1	1
C15	3019068700	POCKET R	GPPS(CRYSTAL)	0	3	3
	3019068710		GPPS(GRAY)			
	3019068720		GPPS(BLUE)			
C16	3019068800	POCKET J	GPPS(CRYSTAL)	0	1	1
	3019068810		GPPS(GRAY)			
	3019068820		GPPS(BLUE)			
C17	3017861900	SHELF WINE	SUS 204	0	1(OPTION)	1(OPTION)

* Please check the color, some parts code color dependent.

6. PART LIST

6-4. Door Compartment

6-4-1. RN_27* Models

NO	PART-CODE	PART NAME	SPEC.	Q'ty			
				RN_271	RN_272	RN_273	RN_274
D1	30100B9M00	ASSY R DR	WHITE(DWG1C)	1	0	0	0
	30100B9M30		AL SILVER(ASG4P)				
	30100B9M40		TITANIUM SILVER(TSH1P)				
	30100B9M50		BLACK(BLH1C)				
	30100B9M60		PLATINUM SILVER(PSH1P)				
D1-1	3012330800	GASKET F R DR AS	RFP-241(GRAY)	2	2	2	2
	3012330710		RFP-241(BLACK)				
D1-2	3011450300	COVER CAP HOLE A	ABS(WHITE)	2	2	2	2
	3011450310		ABS(SILVER)				
	3011450340		ABS(BLACK)				
D2	30100B9L00	ASSY F DR	WHITE(DWG1C)	1	0	0	0
	30100B9L30		AL SILVER(ASG4P)				
	30100B9L40		TITANIUM SILVER(TSH1P)				
	30100B9L50		BLACK(BLH1C)				
	30100B9L60		PLATINUM SILVER(PSH1P)				
D3	30100B9M20	ASSY R DR	WHITE(DWG1C)	0	1	1	0
	30100B9MB0		AL SILVER(ASG4P)				
	30100B9MC0		TITANIUM SILVER(TSH1P)				
	30100B9MD0		BLACK(BLH1C)				
	30100B9ME0		PLATINUM SILVER(PSH1P)				
D3-1	301099BV00	CAP DR	ABS(WHITE)	0	4	4	4
	301099BV10		ABS(SILVER)				
	301099BV20		ABS(BLACK)				
D4	30100B9L20	ASSY F DR	WHITE(DWG1C)	0	1	1	0
	30100B9M70		AL SILVER(ASG4P)				
	30100B9M80		TITANIUM SILVER(TSH1P)				
	30100B9M90		BLACK(BLH1C)				
	30100B9MA0		PLATINUM SILVER(PSH1P)				
D5	3014011300	PACKING HNDL AS (*AL BAR TYPE)	DECO(WHITE)+BAR(NATURAL)	0	1	0	0
	3014011310		DECO(BLACK)+BAR(BLACK)				
	3014011320		DECO(SILVER)+BAR(NATURAL)				
	3014011330		DECO(TITANIUM)+BAR(TITANIUM)				
D5-1	3012659700	HANDLE BAR AS (*AL BAR TYPE)	AL(HAIR LINE+NATURAL COLOR)	0	2	0	0
	3012659710		AL(HAIR LINE+BLACK)				
	3012659720		AL(HAIR LINE+NATURAL COLOR)				
	3012659730		AL(HAIR LINE+TITANIUM SILVER)				
D5-2	3016040500	SPECIAL GRIP HNDL	M5XL16 MFZN	0	4	4	4
D5-3	3010985200	CAP HNDL	ABS (WHITE)	0	4	4	4
	3010985210		ABS (SILVER)				
	3010985220		ABS (BLACK)				

* Please check the color, some parts code color dependent.

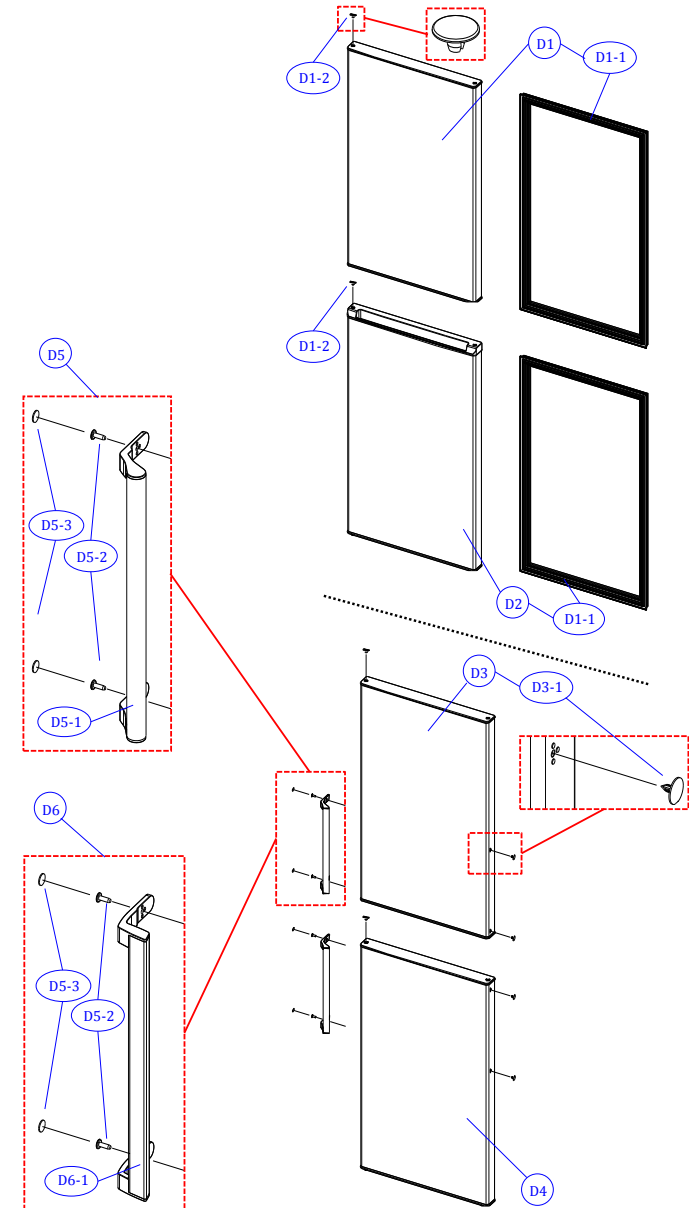

6. PART LIST

6-4. Door Compartment

6-4-1. RN_27* Models

NO	PART-CODE	PART NAME	SPEC.	Q'ty			
				RN_271	RN_272	RN_273	RN_274
D6	3014011400	PACKING HNDL AS	WHITE	0	0	1	0
	3014011410	(*ABS BAR TYPE)	BLACK				
	3014011420		SILVER				
	3014011430		TITANIUM SILVER				
D6-1	3012659800	HANDLE BAR AS	WHITE	0	0	2	0
	3012659810	(*ABS BAR TYPE)	BLACK				
	3012659820		SILVER				
	3012659830		TITANIUM SILVER				
D7	30100B9M10	ASSY R DR	WHITE(DWG1C)	0	0	0	1
	30100B9MF0		AL SILVER(ASG4P)				
	30100B9MG0		TITANIUM SILVER(TSH1P)				
	30100B9MH0		BLACK(BLH1C)				
	30100B9MJ0		PLATINUM SILVER(PSH1P)				
D8	30100B9L10	ASSY F DR	WHITE(DWG1C)	0	0	0	1
	30100B9L70		AL SILVER(ASG4P)				
	30100B9L80		TITANIUM SILVER(TSH1P)				
	30100B9L90		BLACK(BLH1C)				
	30100B9LA0		PLATINUM SILVER(PSH1P)				
D9	3014011100	PACKING HNDL AS (*GAS INJECTION TYPE)	RFP-304, WHITE	0	0	0	1
	3014011110		RFP-304, SILVER				
	3014011120		RFP-304, BLACK				
D9-1	3012659300	HANDLE (*GAS INJECTION TYPE)	ABS, WHITE	0	0	0	2
	3012659310		ABS, SILVER				
	3012659320		ABS, BLACK				

* Please check the color, some parts code color dependent.

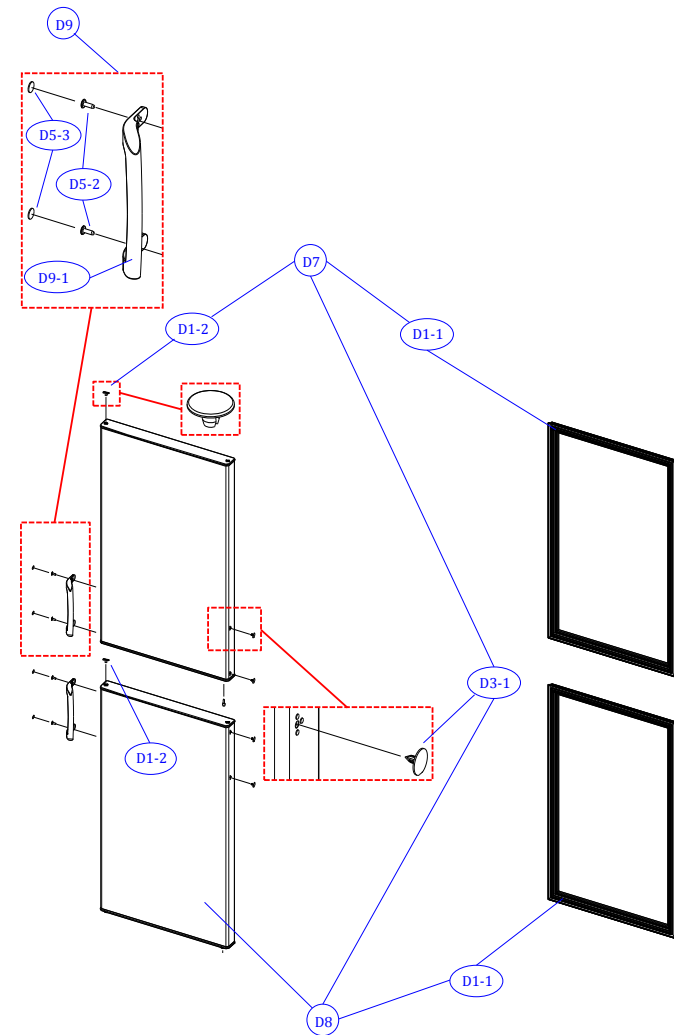

6. PART LIST

6-4. Door Compartment

6-4-2. RN_33* Models

NO	PART-CODE	PART NAME	SPEC.	Q'ty						
				RN_331	RN_332	RN_333	RN_334	RN_335	RN_336	Hidden Hinge
E1	30100B9Y00	ASSY R DR	WHITE(DWG1C)	1	0	0	0	0	0	0
	30100B9Y40		AL SILVER(ASG4P)							
	30100B9Y50		TITANIUM SILVER(TSH1P)							
	30100B9Y60		BLACK(BLH1C)							
	30100B9Y70		PLATINUM SILVER(PSH1P)							
E1-1	3012331000	GASKET R DR AS	RFP-241(GRAY)	1	1	1	1	1	1	1
	3012331010		RFP-241(BLACK)							
E1-2	3011450300	COVER CAP HOLE A	ABS(WHITE)	2	2	2	2	2	2	1
	3011450310		ABS(SILVER)							
	3011450340		ABS(BLACK)							
E2	30100B9X00	ASSY F DR	WHITE(DWG1C)	1	0	0	0	0	0	1
	30100B9X30		AL SILVER(ASG4P)							
	30100B9X40		TITANIUM SILVER(TSH1P)							
	30100B9X50		BLACK(BLH1C)							
	30100B9X60		PLATINUM SILVER(PSH1P)							
E2-1	3012330900	GASKET F R DR AS	RFP-241(GRAY)	1	1	1	1	1	1	1
	3012330910		RFP-241(BLACK)							
E**	-	ASSY R DR	WHITE(DWG1C)	0	0	0	0	0	0	1
	-		AL SILVER(ASG4P)							
	-		TITANIUM SILVER(TSH1P)							
	-		BLACK(BLH1C)							
	-		PLATINUM SILVER(PSH1P)							

* Please check the color, some parts code color dependent.

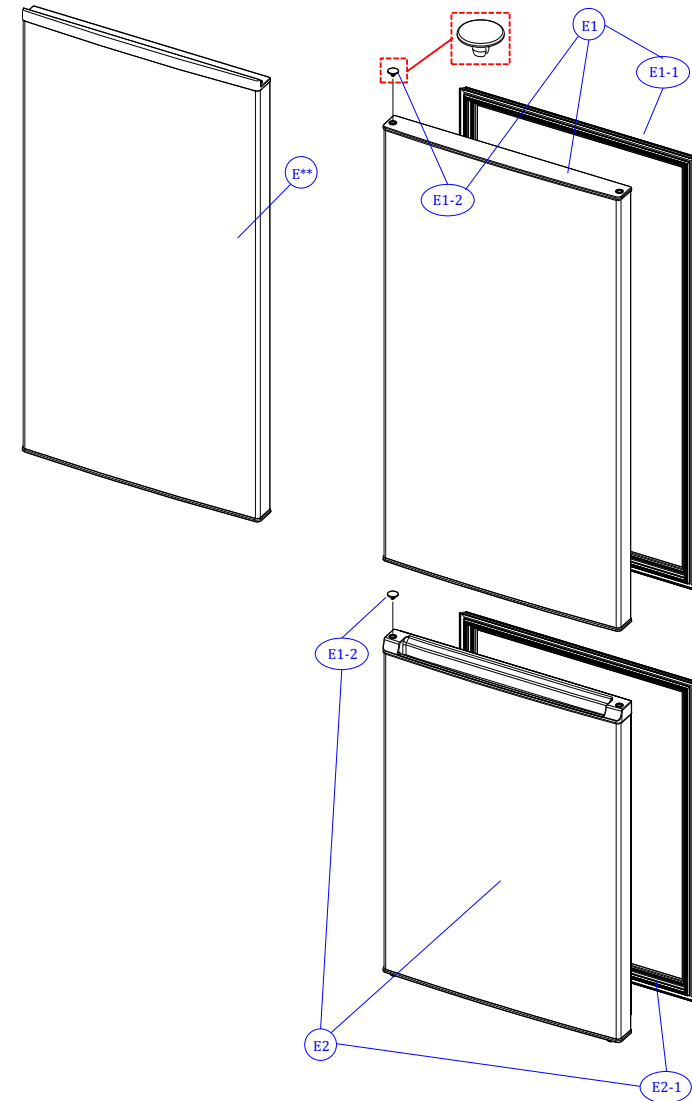

6. PART LIST

6-4. Door Compartment

6-4-2. RN_33* Models

NO	PART-CODE	PART NAME	SPEC.	Q'ty						
				RN_331	RN_332	RN_333	RN_334	RN_335	RN_336	Hidden Hinge
E3	30100B9Y20	ASSY R DR	WHITE(DWG1C)	0	1	1	0	0	0	0
	30100B9YL0		WHITE(DWH1L)							
	30100B9YC0		AL SILVER(ASG4P)							
	30100B9YD0		TITANIUM SILVER(TSH1P)							
	30100B9YE0		BLACK(BLH1C)							
	30100B9YF0		PLATINUM SILVER(PSH1P)							
E3-1	301099BV00	CAP DR	ABS(WHITE)	0	4	4	4	0	0	0
	301099BV10		ABS(SILVER)							
	301099BV20		ABS(BLACK)							
E4	30100B9X20	ASSY F DR	WHITE(DWG1C)	0	1	1	0	0	0	0
	30100B9XB0		WHITE(DWH1L)							
	30100B9Y80		AL SILVER(ASG4P)							
	30100B9Y90		TITANIUM SILVER(TSH1P)							
	30100B9YA0		BLACK(BLH1C)							
	30100B9YB0		PLATINUM SILVER(PSH1P)							
E5	3014011300	PACKING HNDL AS (*AL BAR TYPE)	DECO(WHITE)+BAR(NATURAL)	0	1	0	0	0	0	1(OPTION)
	3014011310		DECO(BLACK)+BAR(BLACK)							
	3014011320		DECO(SILVER)+BAR(NATURAL)							
	3014011330		DECO(TITANIUM)+BAR(TITANIUM)							
E5-1	3012659700	HANDLE BAR AS (*AL BAR TYPE)	AL(HAIR LINE+NATURAL COLOR)	0	2	0	0	0	0	2(OPTION)
	3012659710		AL(HAIR LINE+BLACK)							
	3012659720		AL(HAIR LINE+NATURAL COLOR)							
	3012659730		AL(HAIR LINE+TITANIUM SILVER)							
E5-2	3016040500	SPECIAL GRIP HNDL	M5XL16 MFZN	0	4	4	4	0	0	4(OPTION)
E5-3	3010985200	CAP HNDL	ABS (WHITE)	0	4	4	4	0	0	4(OPTION)
	3010985210		ABS (SILVER)							
	3010985220		ABS (BLACK)							
E6	3014011400	PACKING HNDL AS (*ABS BAR TYPE)	WHITE	0	0	1	0	0	0	1(OPTION)
	3014011410		BLACK							
	3014011420		SILVER							
	3014011430		TITANIUM SILVER							
E6-1	3012659800	HANDLE BAR AS (*ABS BAR TYPE)	WHITE	0	0	2	0	0	0	2(OPTION)
	3012659810		BLACK							
	3012659820		SILVER							
	3012659830		TITANIUM SILVER							

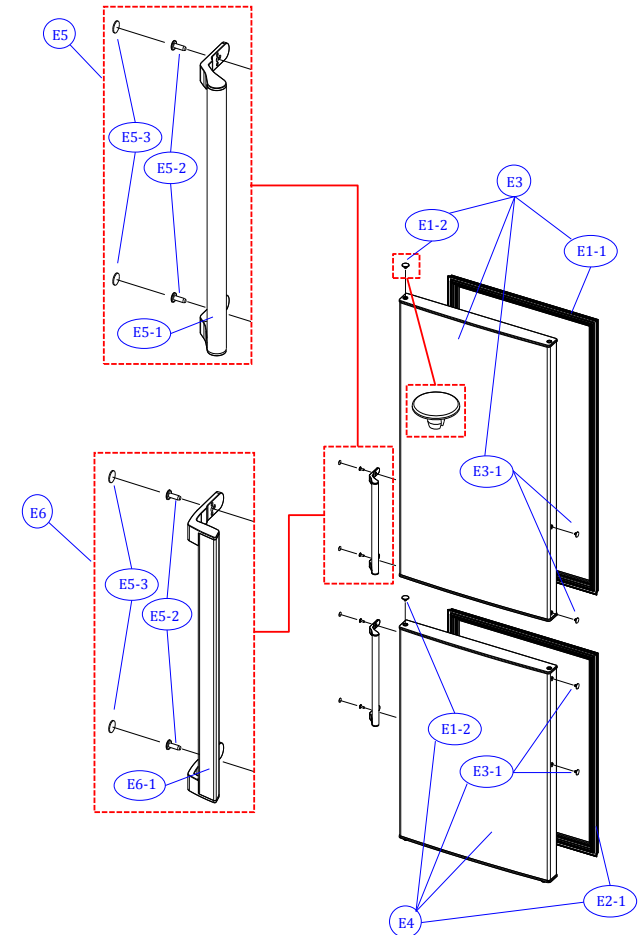

* Please check the color, some parts code color dependent.

6. PART LIST

6-4. Door Compartment

6-4-2. RN_33* Models

NO	PART-CODE	PART NAME	SPEC.	Q'ty						
				RN_331	RN_332	RN_333	RN_334	RN_335	RN_336	Hidden Hinge
E7	30100B9Y10	ASSY R DR	WHITE(DWG1C)	0	0	0	1	0	0	0
	30100B9YG0		AL SILVER(ASG4P)							
	30100B9YH0		TITANIUM SILVER(TSH1P)							
	30100B9YJ0		BLACK(BLH1C)							
	30100B9YK0		PLATINUM SILVER(PSH1P)							
E8	30100B9X10	ASSY F DR	WHITE(DWG1C)	0	0	0	1	0	0	0
	30100B9X70		AL SILVER(ASG4P)							
	30100B9X80		TITANIUM SILVER(TSH1P)							
	30100B9X90		BLACK(BLH1C)							
	30100B9XA0		PLATINUM SILVER(PSH1P)							
E9	3014011100	PACKING HNDL AS (*GAS INJECTION TYPE)	RFP-304, WHITE	0	0	0	1	0	0	1(OPTION)
	3014011110		RFP-304, SILVER							
	3014011120		RFP-304, BLACK							
E9-1	3012659300	HANDLE (*GAS INJECTION TYPE)	ABS, WHITE	0	0	0	2	0	0	2(OPTION)
	3012659310		ABS, SILVER							
	3012659320		ABS, BLACK							

* Please check the color, some parts code color dependent.

