

DISHWASHER SERVICE MANUAL



SEMI-INTEGRATED / FULLY-INTEGRATED

Electrical Components

Button (On / Off Switch)

Button is assembled in the control panel unit.
On / Off (two pole)

Voltage	250 V
Current	16 (4) A



Door Lock

It is a mechanical lock/release system that is closing the door, supplying the connection of electrical parts in the machine and cutting off the connection.

Current	16 (4) A
---------	------------



Circulation Pump

Voltage	220/240 V
Frequency	50 Hz / 60 HZ
Total Power	88 W
Coil Isolation Class	F
Main(First) Coil Ω	95% \pm 7 Ω
Sub(second) Coil Ω	126% \pm 7 Ω
Thermal Protector	109 $^{\circ}$ C
Pump Outlet Pressure	300 mbar
Pump Flowrate	60 l/min

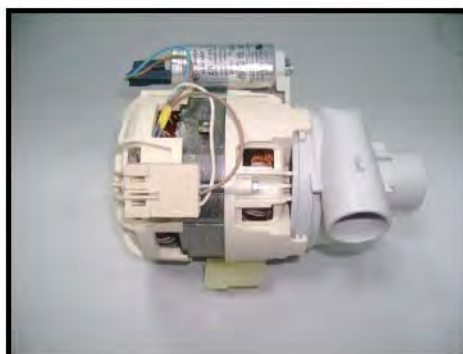

single direction, single phase, asynchronous and two pole.

It turns opposite clock direction.

It is assembled to the basement with rubber hangers.

Capacitor

2,5 μ F – 450 V class P2

Capacitor is permanently connected to the circulation pump coils.



Drain Pump

Voltage:	220/240 Volt
Frequency	50 Hz 60 HZ
Total Power	30 W
Flowrate	17 – 21 l/min
Coil Resistance	143 Ω \pm 7
Coil Isolation Class	F
Thermal Protection	120 °C



Heater Casing Group

Voltage 220/240 volt

Total Power 1800W

27.6-30.6 ohm



NTC with Thermal Protector

+25 °C	-	47.200	±	850	Ω
+30 °C	-	37.500	±	675	Ω
+40 °C	-	24.900	±	349	Ω
+50 °C	-	17.000	±	170	Ω
+60 °C	-	11.700	±	117	Ω
+70 °C	-	8.280	±	108	Ω
+80 °C	-	5.945	±	101	Ω



Pressure Switch

Voltage 220/240 v

Frequency 50/60 Hz

16 A – 3 Pins



• Diverter

*There is diverter at C31 and C41 models
It is assembled to the heater Casing Group.*

Voltage	220/240 V
Frequency	50 Hz 60 HZ
Power	8 W
Resistance	6840±5 Ω

2 Washing Position

1.Position	Upper spray arm complete
2.Position	Lower spray arm complete



Water Inlet Valve

Single inlet and single outlet standard single coil selenoid valve.

Voltage	220/240 Volt
Frequency	50-60 Hz
Total Power	6 W
Flowrate	2.5 lt/min
Coil Isolation Class	F
Resistance	$3750 \pm 10 \Omega$ (20 C°)

It is assembled to the basement and connect to the airbreak by hose.



Regeneration Valve

Voltage	220/240 V
Frequency	50/60 Hz
Total Power	6 W
Resistance	$4130 \pm 10 \Omega$ (25 C°)

Regeneration valve is assembled on the water softener.



Parasite Filter

Voltage	220/240 V
Frequency	50/60 Hz
0,1 uF (X1) + 2x0,027uF(Y2) + 1M Ω	

It is used to prevent parasites from the main supply. It has been assembled to basement.



Turbo Fan Motor

There is a thermal protector. Shaded pole motor , two pole temperature is between -40–150 C° .

There is Turbo Fan Motor only at C4 models.



Salt Sensor

Voltage 250 V
Current 50 mA

It is assembled to the water softener.
It warns if the salt is less than requested quantity.



Power Cord

Type Euro 3'lü 1 mm², copper conducting
Isolation TS 9760 H05VV-F
Plug TS-IEC 60884-1 PVC injected
Length 1800 mm



Drain Hose

Drain hose maximum height 110cm
Drain hose minimum height 50cm
Drain hose maximum length 400cm



Total Power 15 W
Voltage 220/240 V
Frequency 50 Hz, 60HZ
Resistance 238.6± 5 Ω

Coil isolation class: H

Detergent / Rinse Aid Dispanser

Detergant dispenser consists of rinse aid and detergent compartment. It has been assembled to the inner door by the snap fits. Only one bobbin has been used for operating the system.

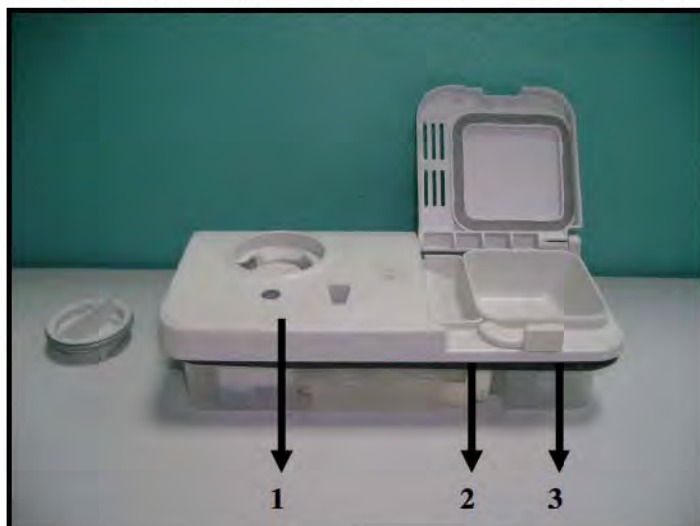

Detergant compartment

Main wash compartment (3) 40 cm³
 Prewash compartment (2) 5 cm³

Rinse aid compartment (1) :
 Dosage Quantities:

Level	Rinse aid dosage amount
Level 1	1 cc ± 0,5 cc
Level 2	2 cc ± 0,5 cc
Level 3	3 cc ± 20%
Level 4	4 cc ± 20%
Level 5	5 cc ± 20%
Level 6	6 cc ± 20%

Rinse aid compartnnet: 150 cm³
 Factory outlet setting position: level 3

Water Softener

Resin Quantity 0,6lt
 Capacity of salt compartment 2kg
 Total hardness adjustment level 6

Water Level	Hardness	German Hardness °dH	French hardness °dF	British hardness °dE	Water Liter
Level 1		0-5	0-9	0-6	-
Level 2		6-11	10-20	7-14	160lt
Level 3		12-17	21-30	15-21	89lt
Level 4		18-22	31-40	22-28	59lt
Level 5		23-31	41-55	29-39	46lt
Level 6		32-50	56-90	40-63	16lt

Name Plate

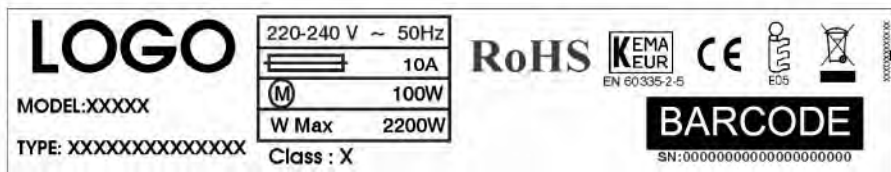

Serial Number

00614843000036440001

00 Empty

614843 Product codes

001 Serial Number

20655055071003

20655055 label number

07 Year

10 Month

03 Day

SETTING THE WATER HARDNESS

Test strip;

The washing effectiveness of your machine depends on the softness of the tap water. For this reason, your machine is equipped with a system that reduces the hardness in mains water supply. The washing effectiveness will increase when the system is correctly set. To make the system setting, use the testing strip, if it is available, and find the hardness of the mains water supply.

Open the testing strip.	Run water through your tap for 1 min.	Keep the testing strip in water for 1 sec.	Shake the testing strip after taking it out of water.	Wait for 1 min.	Make your machine's water hardness setting according to the result obtained through the testing strip.
-------------------------	---------------------------------------	--	---	-----------------	--

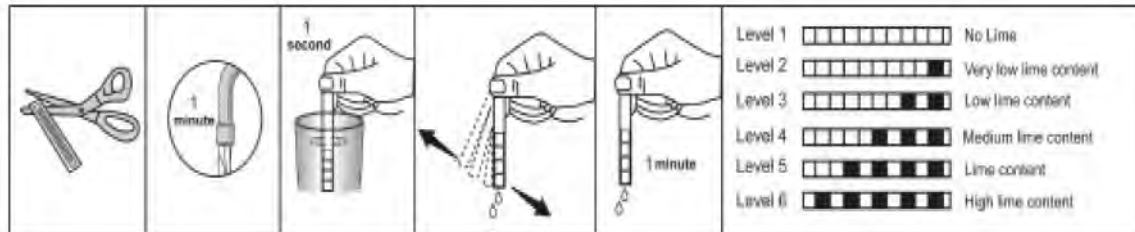

Semi- Integrated Models;

a) Move the programme selector knob to the 0(reset) position while your machine is not in operation.

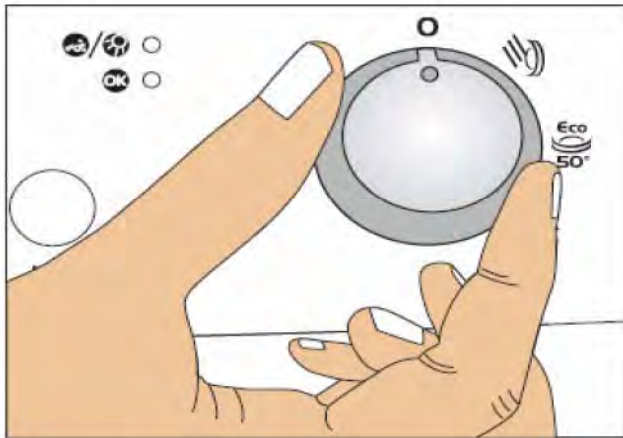

b) Press the Start/Pause button and keep it pressed down. Meanwhile, energise the machine by pressing the Power On/Off button.

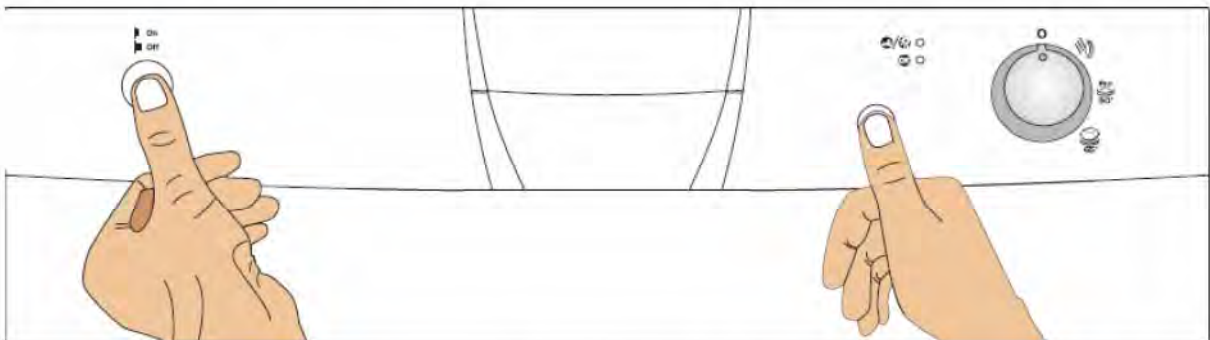

c) Keep Start/Pause button pressed until program monitor lights are on and off.

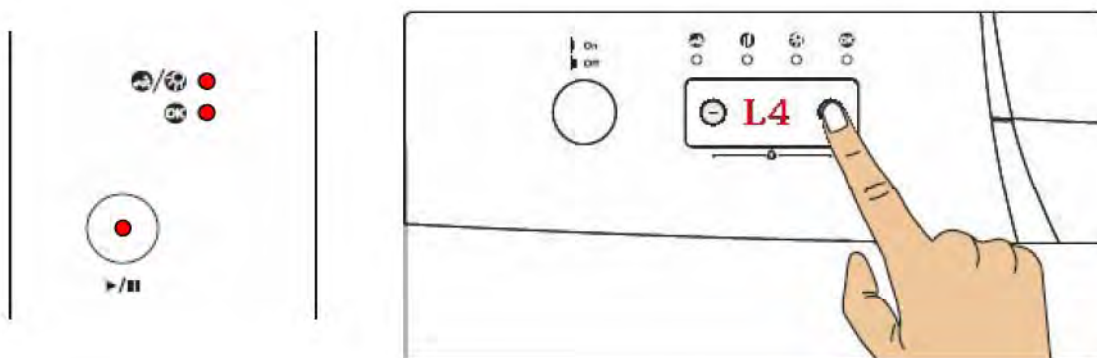

d) After the lights have flashed, release the Start/Pause button.

Your machine displays the latest entered water hardness setting. You can adjust the levels by pressing Start/Pause button according to the table of Water Hardness Level Settings. You can adjust the levels by pressing "+" and "-" buttons placed on display in FNAC31 and FNAC41 models.

C11, C12, C13

Water Hardness Level Indicators

Water Hardness Level	German Hardness dH	French Hardness dF	British Hardness dE	HARDNESS LEVEL INDICATORS
1	0-5	0-9	0-6	
2	6-11	10-20	7-14	
3	12-17	21-30	15-21	
4	18-22	31-40	22-28	
5	23-31	41-55	29-39	
6	32-50	56-90	40-63	

C21, C31 Water Hardness Level Indicators

Water Hardness Level	German Hardness dH	French Hardness dF	British Hardness dE	HARDNESS LEVEL INDICATORS
1	0-5	0-9	0-6	
2	6-11	10-20	7-14	
3	12-17	21-30	15-21	
4	18-22	31-40	22-28	
5	23-31	41-55	29-39	
6	32-50	56-90	40-63	

C41 Water Hardness Level Indicators

Water Hardness Level	German Hardness dH	French Hardness dF	British Hardness dE	HARDNESS LEVEL INDICATORS
1	0-5	0-9	0-6	<p>The control panel features four indicator lights at the top: 'off', 'on', 'off', and 'ok'. Below them is a digital display showing 'L1' in red. To the left of the display is a '-' button and to the right is a '+' button. A bracket below the display points to an 'i' icon.</p>
2	6-11	10-20	7-14	<p>The control panel features four indicator lights at the top: 'off', 'on', 'off', and 'ok'. Below them is a digital display showing 'L2' in red. To the left of the display is a '-' button and to the right is a '+' button. A bracket below the display points to an 'i' icon.</p>
3	12-17	21-30	15-21	<p>The control panel features four indicator lights at the top: 'off', 'on', 'off', and 'ok'. Below them is a digital display showing 'L3' in red. To the left of the display is a '-' button and to the right is a '+' button. A bracket below the display points to an 'i' icon.</p>
4	18-22	31-40	22-28	<p>The control panel features four indicator lights at the top: 'off', 'on', 'off', and 'ok'. Below them is a digital display showing 'L4' in red. To the left of the display is a '-' button and to the right is a '+' button. A bracket below the display points to an 'i' icon.</p>
5	23-31	41-55	29-39	<p>The control panel features four indicator lights at the top: 'off', 'on', 'off', and 'ok'. Below them is a digital display showing 'L5' in red. To the left of the display is a '-' button and to the right is a '+' button. A bracket below the display points to an 'i' icon.</p>
6	32-50	56-90	40-63	<p>The control panel features four indicator lights at the top: 'off', 'on', 'off', and 'ok'. Below them is a digital display showing 'L6' in red. To the left of the display is a '-' button and to the right is a '+' button. A bracket below the display points to an 'i' icon.</p>

Fully-Integrated Models; INRD 13 and FNTD13

a) Press the Program selector button and keep it pressed down while your machine is not in operation,



b) Meanwhile, energise the machine by pressing the On/Off button.

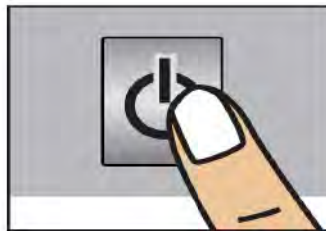

c) Keep Program selector button pressed until "P1– P2 – P3 – P4– End" lights are on and off.



d) After the "P1– P2 – P3 – P4– End" have flashed, release the Program selector button.



Your machine displays the latest entered water hardness setting.

e) You can adjust the levels by pressing Program selector button according to the table of Water Hardness Level Settings.



f) After adjusting the water hardness level, press on/off button to save settings in memory.



INRD 13 and FNTD13

Water Hardness Level	German Hardness dH	French Hardness dF	British Hardness dE	HARDNESS LEVEL INDICATORS
1	0-5	0-9	0-6	
2	6-11	10-20	7-14	
3	12-17	21-30	15-21	
4	18-22	31-40	22-28	
5	23-31	41-55	29-39	
6	32-50	56-90	40-63	

INRD21 and FNTD21

a) Press the Program selector button and keep it pressed down while your machine is not in operation,



b) Meanwhile, energise the machine by pressing the On/Off button.



c) Keep Program selector button pressed until "P1- P2 - P3 - P4- P5- 3h -6h- 9h- End" lights are on and off.



d) After the "P1- P2 - P3 - P4- P5- 3h -6h- 9h- End" have flashed, release the Program selector button.



Your machine displays the latest entered water hardness setting.

e) You can adjust the levels by pressing Program selector button according to the table of Water Hardness Level Settings.



f) After adjusting the water hardness level, press on/off button to save settings in memory.



INRD21 and FNTD21

Water Hardness Level	German Hardness dH	French Hardness dF	British Hardness dE	HARDNESS LEVEL INDICATORS
1	0-5	0-9	0-6	
2	6-11	10-20	7-14	
3	12-17	21-30	15-21	
4	18-22	31-40	22-28	
5	23-31	41-55	29-39	
6	32-50	56-90	40-63	

INRD41 and FNTD41

a) Press the Program selector button and keep it pressed down while your machine is not in operation,



b) Meanwhile, energise the machine by pressing the On/Off button.



c) Keep Program selector button pressed until "SL" expression is on and off.



d) After the "SL" expression have flashed, release the Program selector button.



Your machine displays the latest entered water hardness setting.

e) You can adjust the levels by pressing Program selector button according to the table of Water Hardness Level Settings.



f) After adjusting the water hardness level, press on/off button to save settings in memory..



INRD41 and FNTD41

Water Hardness Level	German Hardness dH	French Hardness dF	British Hardness dE	HARDNESS LEVEL INDICATORS
1	0-5	0-9	0-6	 
2	6-11	10-20	7-14	 
3	12-17	21-30	15-21	 
4	18-22	31-40	22-28	 
5	23-31	41-55	29-39	 
6	32-50	56-90	40-63	 

Child Lock:

C21, C31 and C41 models

Activate Child Lock: Press Start/Pause and Delay buttons simultaneously for 4 seconds. When activated, 3h (washing) lamp flashes once. In C41 model press "+" and "-" buttons on Remaining time indicator simultaneously for 4 seconds. At this time, "CL" appears for 2 seconds on remaining time indicator

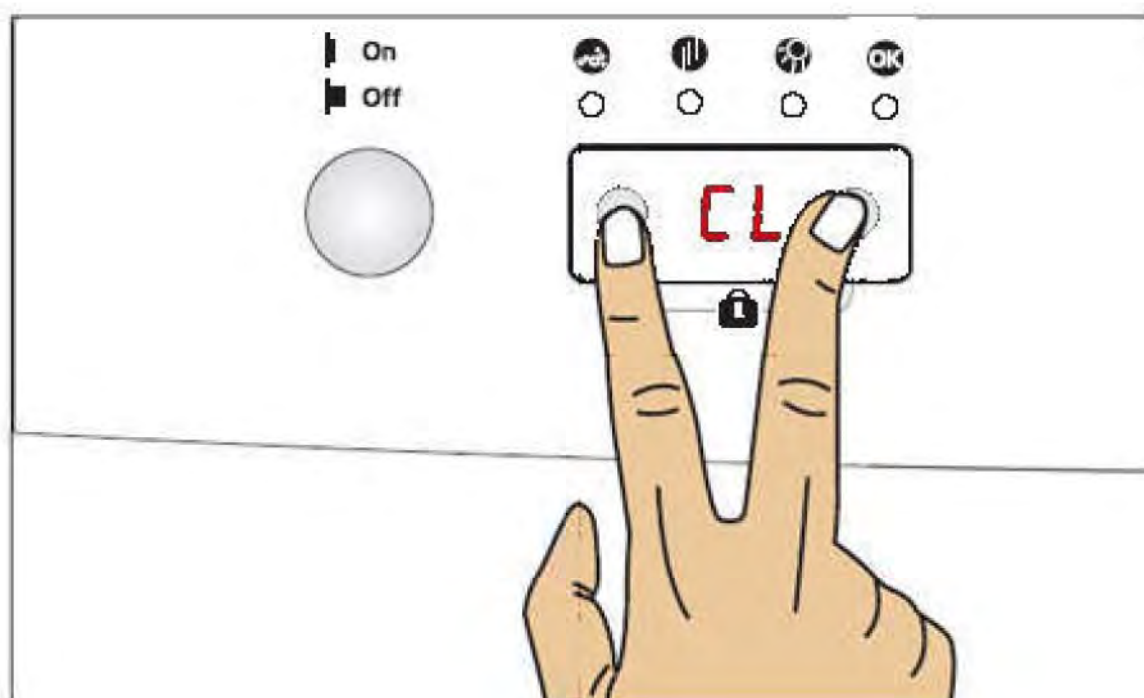
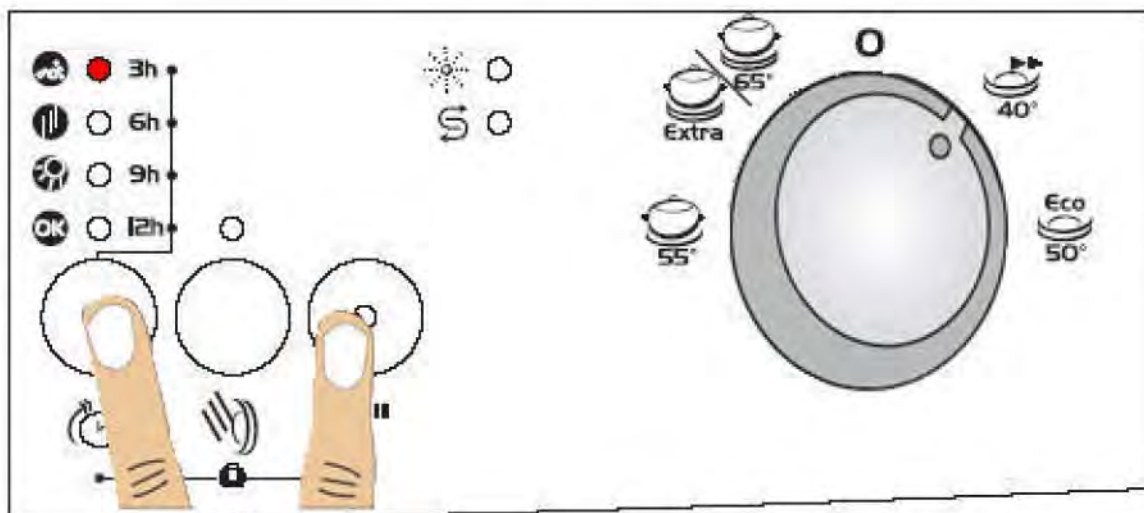

Inactivate Child Lock: Press Start/Pause and Delay buttons simultaneously for 4 seconds. When activated, 3h (washing) lamp flashes twice. In C41 model press "+" and "-" buttons again simultaneously for 4 seconds. "CL" will blink for 2 times.

Delay Timer:

C21 and C31,

When you press delay button, 3h (washing) lamp flashes. If you continue pressing delay button, 6h-9h-12h lamp will flash respectively for each press. If you select delay time and press Start/Pause button, then you activate delay time.

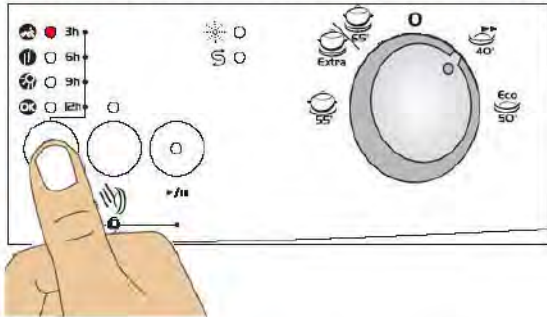

C41

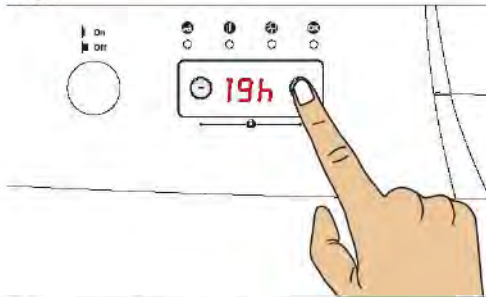

In these models you can select the delay time by pressing “+” and “-” buttons on display. For activating delay time press Start /Pause button.

IND21 and FNTD21

When you press delay button, 3h lamp flashes. If you continue pressing delay button, 6h-9h lamp will flash. If you press delay button again, after 9h lamp flashed, delay will reset. You may select the delay time, after selecting the programme.

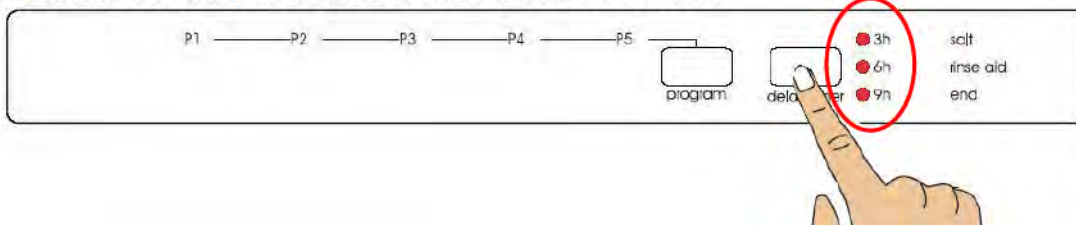

INRD41 and FNTD41

When you press delay button, "1h" appears on program display. If you continue pressing delay button, 1h-2h-...19h lamp will flash respectively for each pressing. You may select the delay time, after selecting the programme. For changing or resetting delay time, adjust the new time by pressing delay button. It will active according to the latest entered setting.

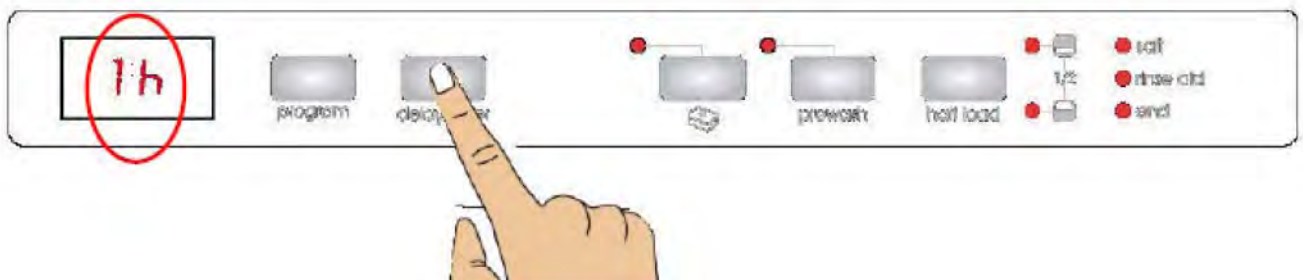

Program resetting;

For Free-Standing and Semi-Integrated Models,

a) Press Start/Pause button.

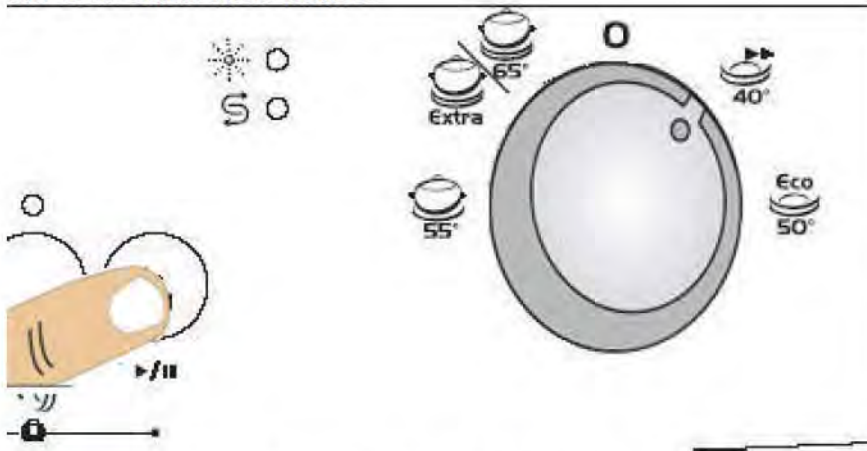

b) Turn the Program Selection Button to Reset.



c) Press once the Start/Pause button. The machine will drain the water in it for nearly 30 sec. When the end lamp is on, the program will have been cancelled.

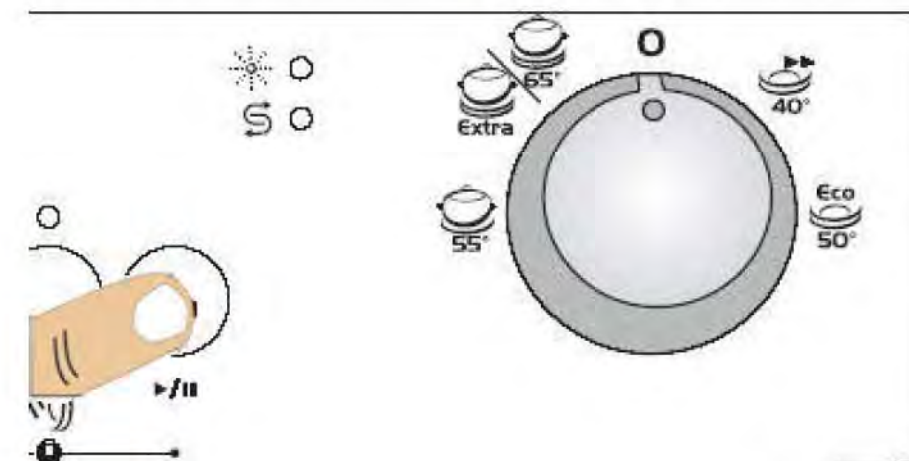

Fully-Integrated Models,

INRD13, INRD21, FNTD13 and FNTD21

a) If you want to reset the program while your machine is working, open the door and press program button along 3sec (until end lamp is highlighted) ,

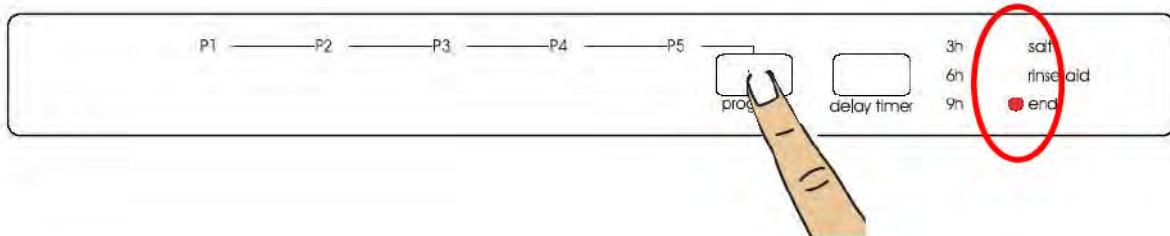

b. After closing the door, draining will start. The machine will drain the water in it for nearly 30 sec. When the program is cancelled, the machine signals and end lamp is on.

INRD41 and FNTD41

a) If you want to reset the program while your machine is working, open the door and press program button along 3sec (until "1" appears on display),

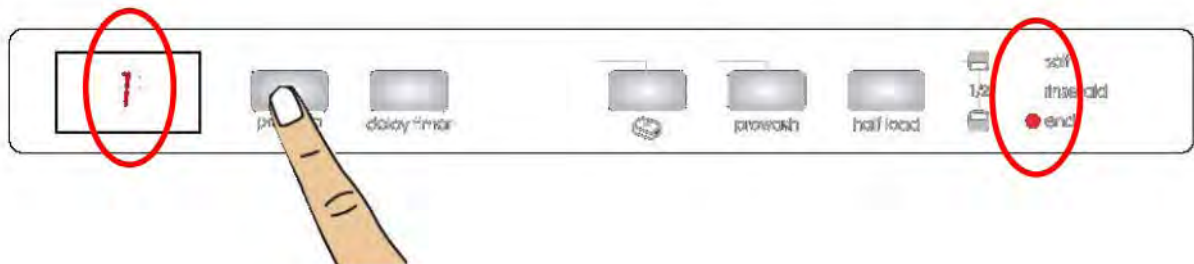

b) After closing the door, draining will start. The machine will drain the water in it for nearly 30 sec. When the program is cancelled, the machine signals and end lamp is on.

Changing A Program ;

For Free-Standing and Semi-Integrated Models,

a) Press Start/Pause button.

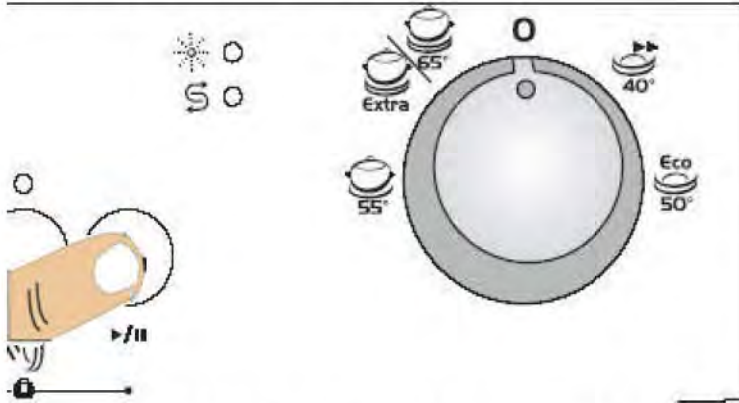

b) After the program stops select your desired program via the Program selection button.

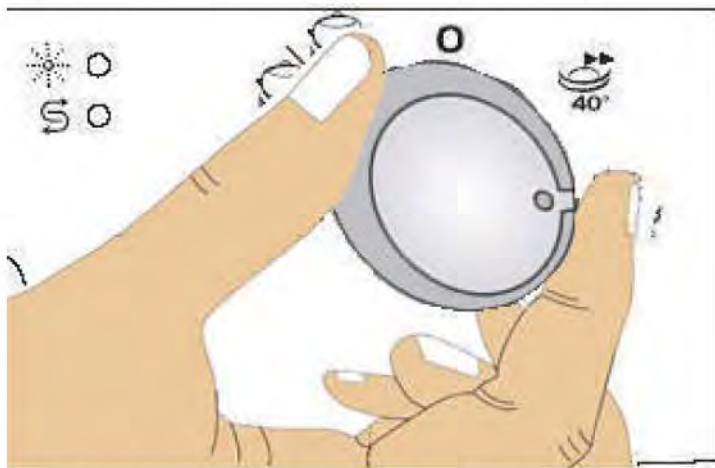

c) Start the program you have newly selected by pressing again Start/Pause button. **The new program started will resume the course of the old program.**

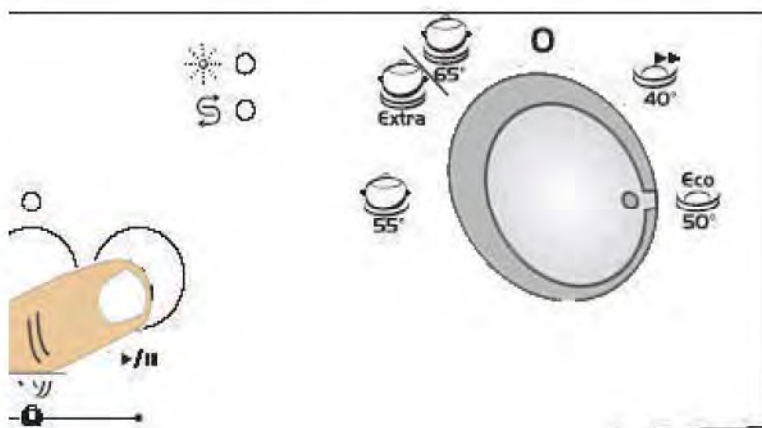

Fully-Integrated Models,

INRD13, INRD21, FNTD13 and FNTD21

a) Open the door and select your desired program via the Program selection button,

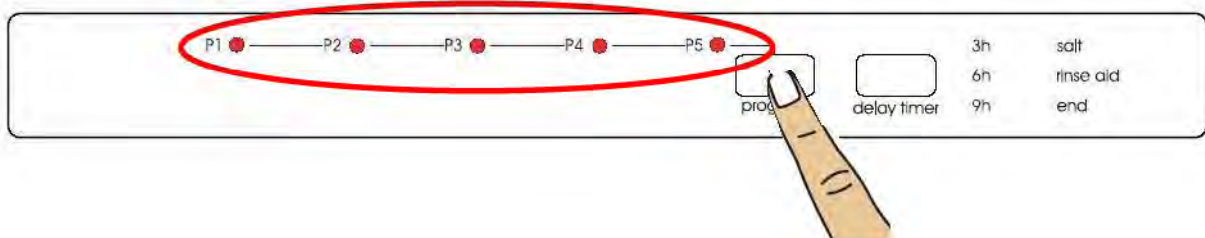

b) The new program started will resume the course of the old program.

INRD41 and FNTD41

a) Open the door and select your desired program via the Program selection button,

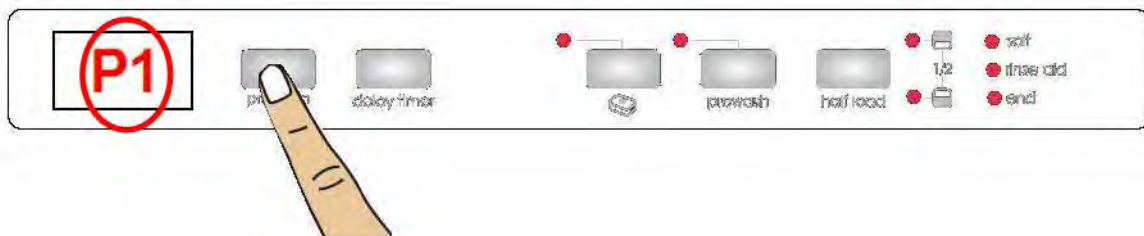

b) The new program started will resume the course of the old program.

SERVICE TEST PROGRAMME

For Free-Standing and Semi-Integrated Models,

First of all be sure that the machine isn't in operation.

a) Move the programme selector knob to the **first programme placed the right of reset** and press the **start/pause** button while your machine is not in operation. Keep the start/pause button pressed down meanwhile energise the machine by pressing the on/off button.

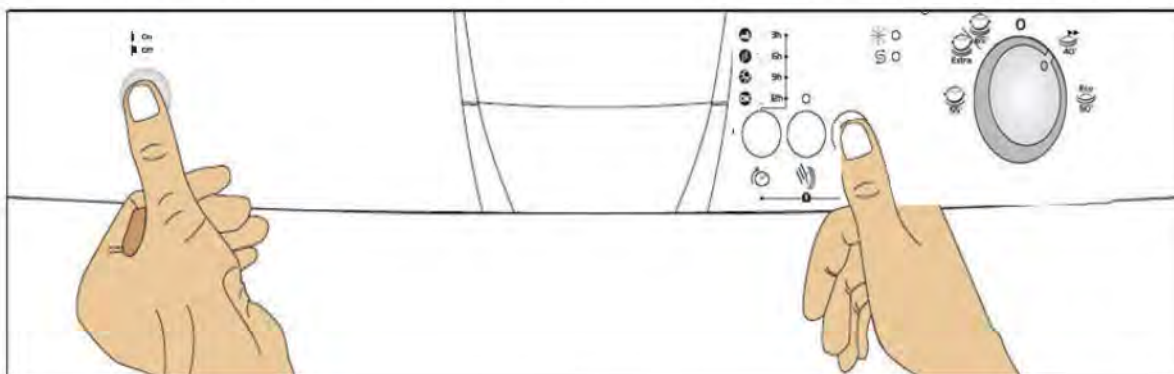

b) Keep the start/pause button pressed until the flow indicators are on and off. It takes ~5sec.

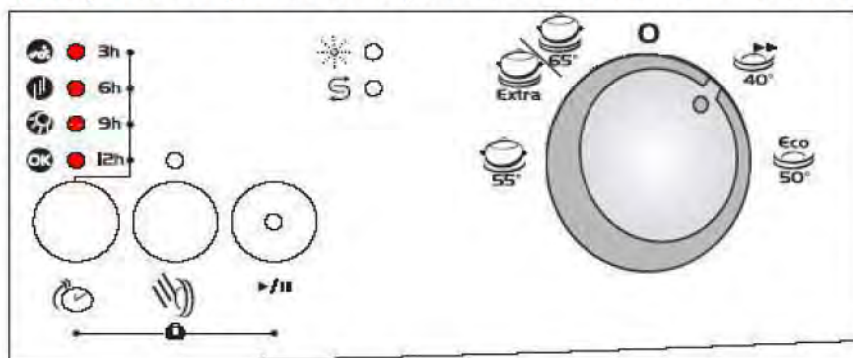

c) After the flow indicators are on and off, move the programme selector knob to the reset position. Keep the start/pause button pressed again until the flow indicators are on and off

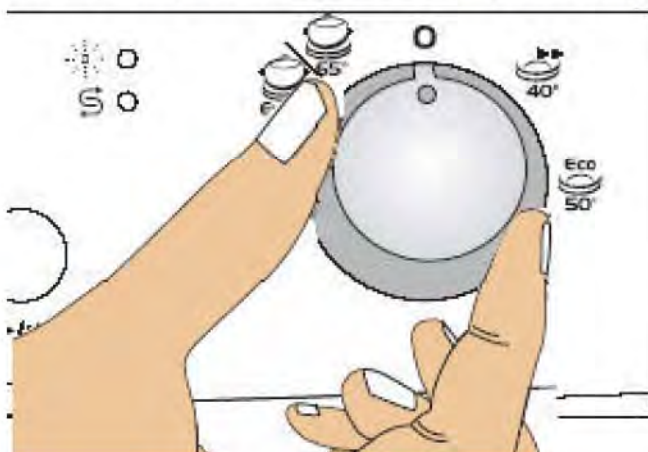

After finalizing the above processes; the service program starts automatically.

Fully-Integrated Models;

INRD13, INRD21, FNTD13 and FNTD21

a) Press the Program selector button and keep it pressed down while your machine is not in operation,



b) Meanwhile, energise the machine by pressing the On/Off button.



c) Keep Program selector button pressed until all indicators are on and off for the second time.



d) After all the lights have flashed, release the Program selector button..



The machine shows the last error, then starts to service programme.

e) End of the programme the end lamp is on. If the machine comes to error position, the lamps ,showed failure codes, are on and the machine shows the first failure code on service programme.

f) Press on/off button to close the machine.

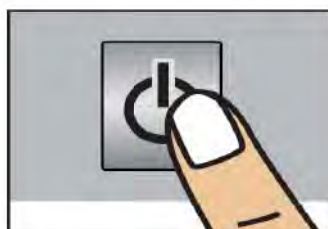

INRD41 and FNTD41

a) Press the Program selector button and keep it pressed down while your machine is not in operation,



b) Meanwhile, energise the machine by pressing the On/Off button.

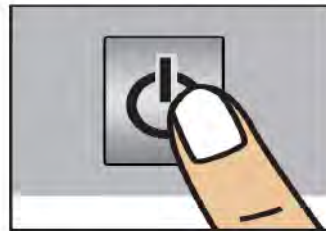

c) Keep Program selector button pressed until "SP" appears on display.



d) After all the lights have flashed, release the Program selector button.



The machine shows the last error, then starts to service programme.

e) End of the service programme the end lamp is on. If the machine comes to error position, the lamps, showed failure codes, are on and the machine shows the first failure code on service programme

f) Press on/off button to close the machine.

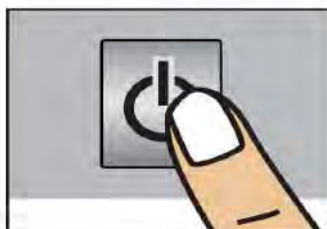

Auto test program algorithm steps:

Steps in program algorithm follows each other automatically. When there is a problem, program ends and gives failure code. You can learn the error from the Service Failure Code.

Steps	Process	Time	Control
0	Show the last failure occurred before	~6 sec	The machine shows the last error, before the service programme starts
1	Drain	~4 sec	Drain pump is running
2	Fill (~3,5lt)	~1min 25 sec	Water inlet valve and flowmeter is controlled. (At 2,5lt circulation pump starts to run)
3	Turbidity sensor	~30 sec	(For C4 models)
4	Washing pump	~1 min 10sec	Circulation pump – detergent dispenser
5	Wash pump + Heating	~5 min	Heater Casing (pressure switch)- NTC- diverter positions
6	Regeneration	~1 min	Regeneration valve
7	Drain	~ 20sec	Drain Pump
8	End led highlight		

Note: The values declared above are the values obtained under laboratory conditions according to the relevant standards. These values can change depending on conditions of product's use and environment (network tension, water input temperature and environment temperature)

SERVICE FAILURE CODE

While your machine is in operation, gives feedback informations. The indicators are on and off with different combinations or the failure code appears on display, then you can identify the possible problem by looking the following failure code tables.

FREE-STANDING and SEMI-INTEGRATED

C11,C12,C13 FAILURE CODES

1. Inadequate water supply

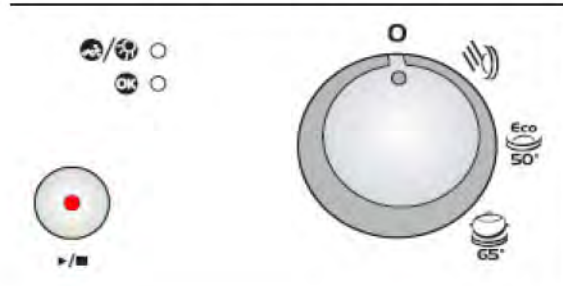

Possible problems:

- 1- Make sure the water input tap is totally open and that there is no water cut.
- 2- Close the water input tap, separate the water input hose from the tap and clean the filter at the connection end of the hose.
- 3- Water inlet hose can be out of order.
- 4- Water inlet valve filter can be clogged.
- 5- Water inlet valve can be out of order.
- 6- There can be a problem with the cable connection of water inlet valve.
- 7- Floater switch can be out of order or have a problem with the cable connection.
- 8- Pressure switch of the heater casing group can have a mechanical or cable connection problem.
- 9- Circulation pump can be out of order or have a problem with the cable connection.

2. Error of continuous water input

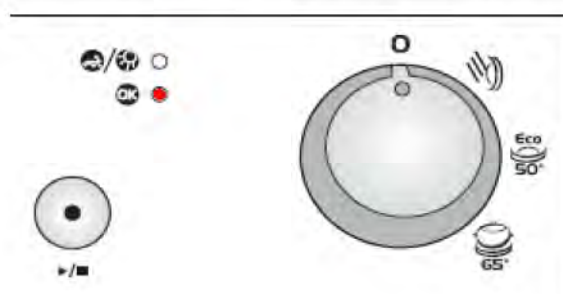

Possible problems:

- 1- Water inlet valve can be out of order or can not be closed.
- 2- Electronic card can be out of order.

3. The waste water in the machine cannot be discharged

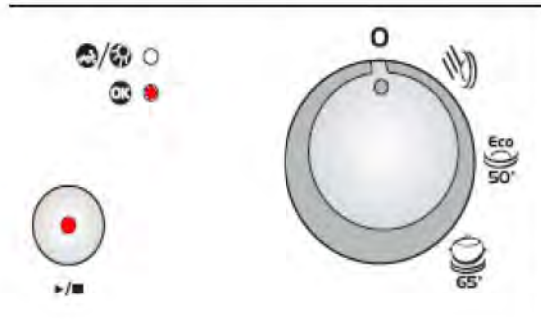

Possible problems:

- 1- Water outlet hose is clogged.
- 2- Water outlet hose position can be too high.
- 3- The drain pump can be out of order.
- 4- There can be a problem with cable connection of the drain pump.
- 5- Pressure switch of the heater casing group can have a mechanical or cable connection problem.

4. Intended water temperature could not be reached - faulty heater and/or heater sensor

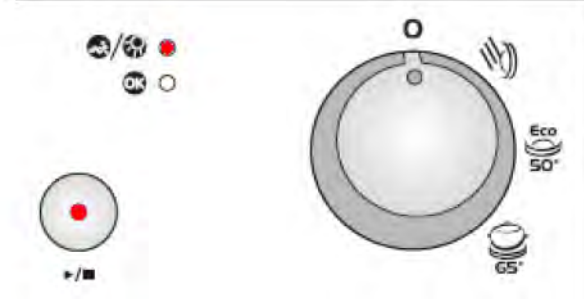

Possible problems:

- 1- NTC can be out of order.
- 2- NTC cable connection can be faulty. NTC can be short or open circuit.
- 3- Thermal protection can be out of order.
- 4- Heater can be out of order or cable connection can be faulty.

5. Alarm is active against water overflow

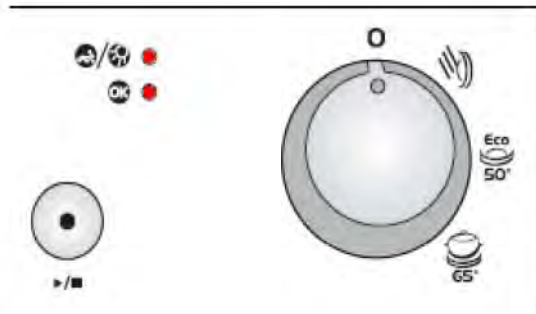

Possible problems:

- 1- There can be a water leakage from the tub.
- 2- Floater switch can be out of order or have a problem with the cable connection.
- 3- Drain pump and pressure switch can be out of order at the same time.
- 4- Electronic card can be out of order.

6. Electronic card parameter faulty

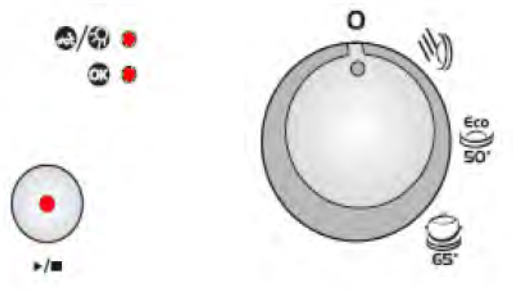

Possible problems:

- 1- By the immediate and continuous voltage decreases software variants can not be kept in the memory of electronic card.
- 2- The program continues, when you restart it. You should warn the user about controlling the network voltage.

7. Faulty Flowmeter

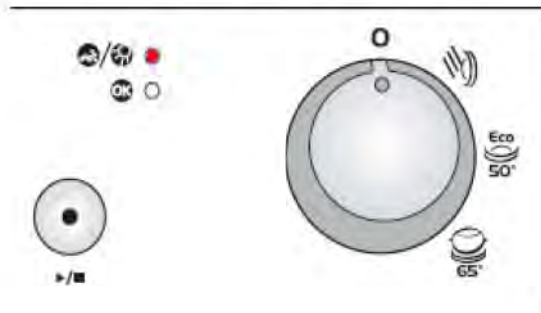

Possible problems:

- 1-Flowmeter can be out of order.
- 2- Cable connection of flowmeter can be faulty.
- 3- Electronic card can be out of order.

8. Door is open

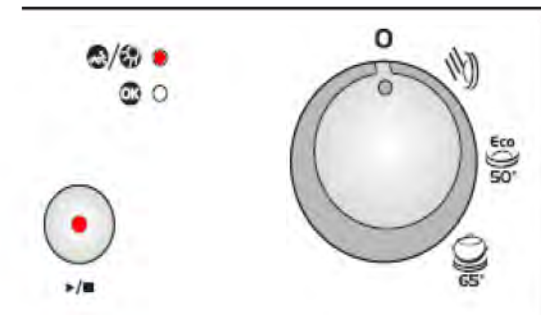

Possible problems:

- 1-Door lock mechanism can be out of order.
- 2- There can be a problem with the cable connection of door lock.
- 3- Electronic card can be out of order.

FREE-STANDING AND SEMI-INTEGRATED C21,C31,C41 FAILURE CODES

1. Inadequate water supply

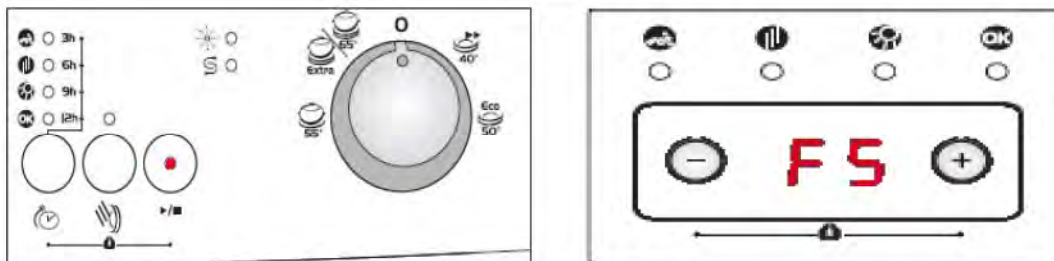

Possible problems:

- 1- Make sure the water input tap is totally open and that there is no water cut.
- 2- Close the water input tap, separate the water input hose from the tap and clean the filter at the connection end of the hose.
- 3- Water inlet hose can be out of order.
- 4- Water inlet valve filter can be clogged.
- 5- Water inlet valve can be out of order.
- 6- There can be a problem with the cable connection of water inlet valve.
- 7- Floater switch can be out of order or have a problem with the cable connection.
- 8- Pressure switch of the heater casing group can have a mechanical or cable connection problem.
- 9- Circulation pump can be out of order or have a problem with the cable connection.

2. Error of continuous water input

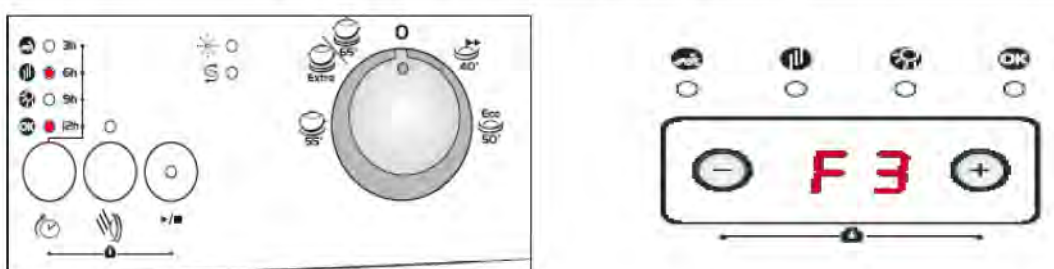

Possible problems:

- 1- Water inlet valve can be out of order or can not be closed.
- 2- Electronic card can be out of order.

3. The waste water in the machine cannot be discharged

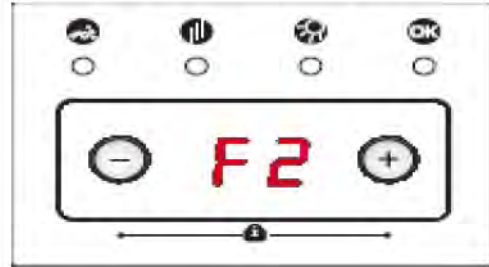
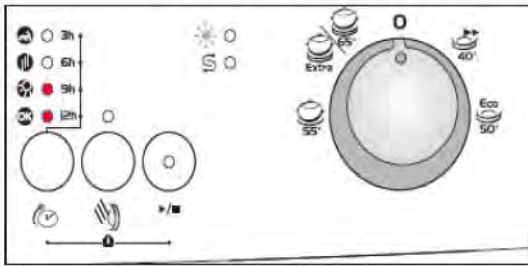

Possible problems:

- 1- Water outlet hose is clogged.
- 2- Water outlet hose position can be too high.
- 3- The drain pump can be out of order.
- 4- There can be a problem with cable connection of the drain pump.
- 5- Pressure switch of the heater casing group can have a mechanical or cable connection problem.

4. Heater Error: Inadequate heat

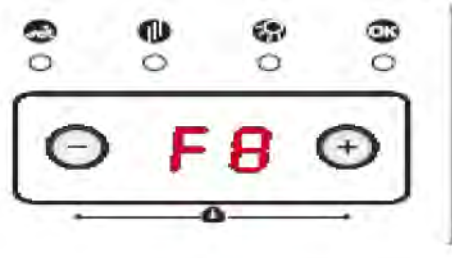
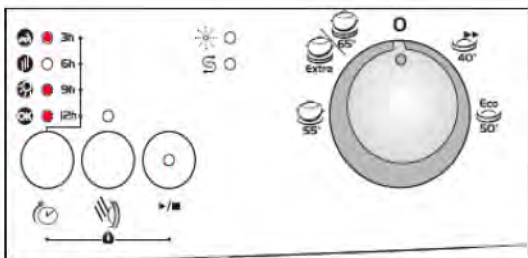

Possible problems:

- 1- Heater can be out of order.
- 2- There can be a problem with cable connection of the heater.
- 3- Thermal protection can be out of order.
- 4- Electronic card can be out of order.

5. Alarm is active against water overflow

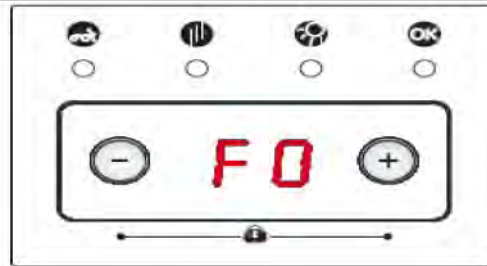
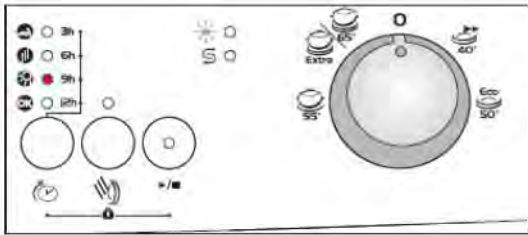

Possible problems:

- 1- Floater switch can be out of order or have a problem with the cable connection.
- 2- Electronic card can be out of order.

6. Alarm is active against water leakage

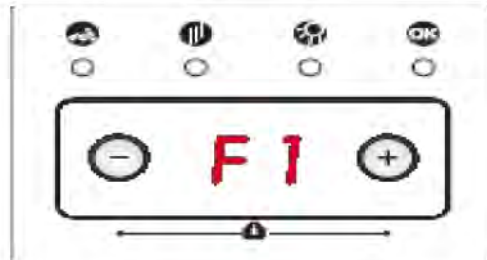
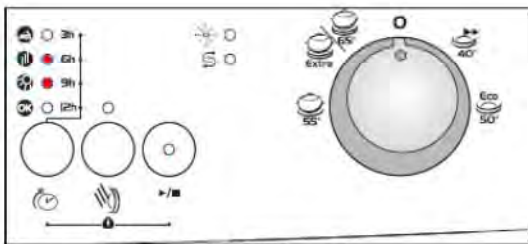

Possible problems:

- 1- There can be a water leakage from the tub.
- 2- Floater switch can be out of order or have a problem with the cable connection.
- 3- Drain pump and pressure switch can be out of order at the same time.
- 4- Electronic card can be out of order.

7. Exceed heating problem (water inside the machine is too high)

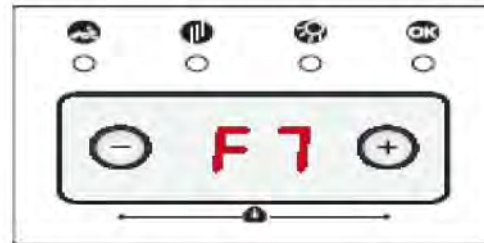
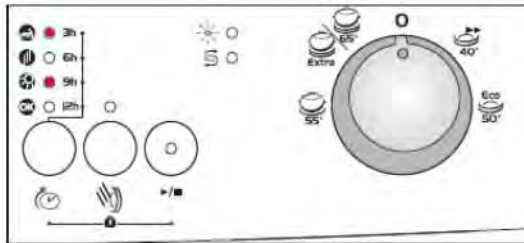

Possible problems:

- 1- Water inside the machine is $>77^{\circ}\text{C}$, NTC can be out of order.
- 2- Electronic card can be out of order.

8. Diverter position problem

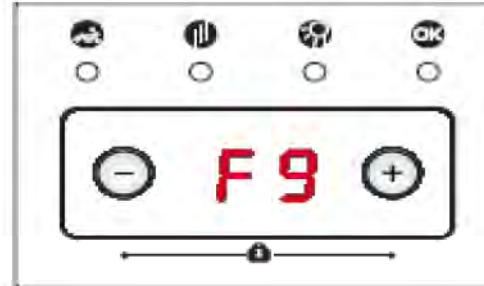
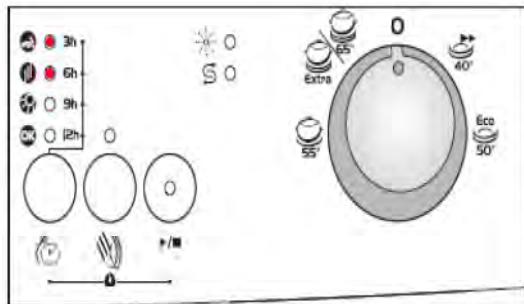

Possible problems:

- 1- There can be a water leakage to diverter contacts and diverter electric contacts can have open circuit
- 2- There can be a problem with cable connection of the diverter.
- 3- Electronic card can be out of order.

9. NTC faulty

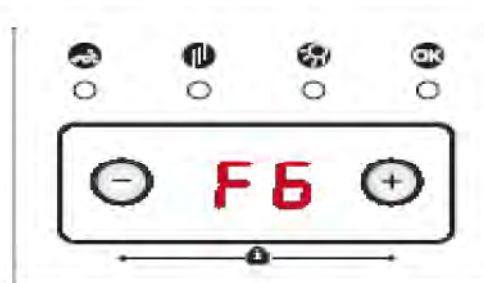
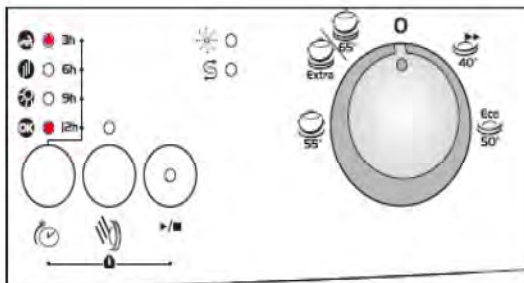

Possible problems:

- 1- NTC can be out of order.
- 2- NTC cable connection can be faulty. NTC can be short or open circuit.
- 3- Electronic card can be out of order.

10. Electronic card parameter faulty

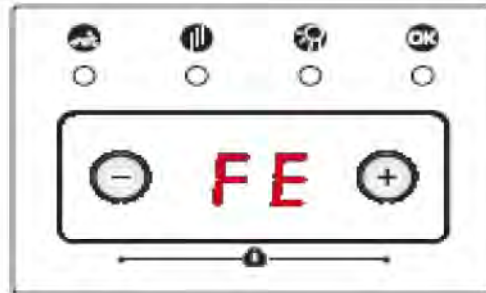
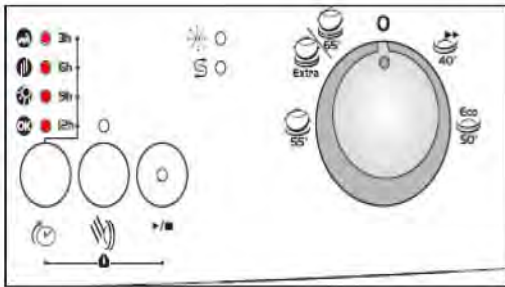

Possible problems:

- 1- By the immediate and continuous voltage decreases software variants can not be kept in the memory of electronic card.
- 2- The program continues, when you restart it. You should warn the user about controlling the network voltage.

11. Electronic card water hardness faulty

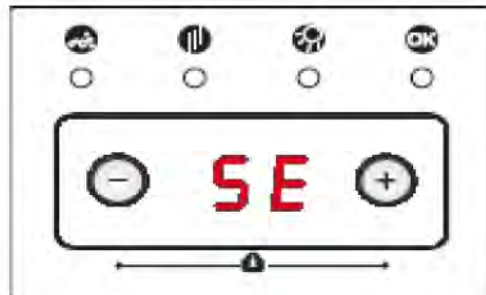
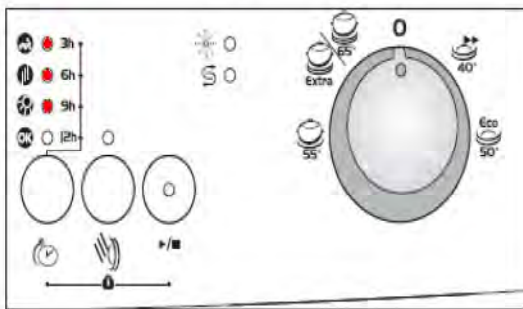

Possible problems:

- 1- Water Hardness is not adjusted or Water Hardness adjustment can not be kept in the electronic card memory.
- 2- Water Hardness should be adjusted by controlling the supply water.

12. Faulty Flowmeter

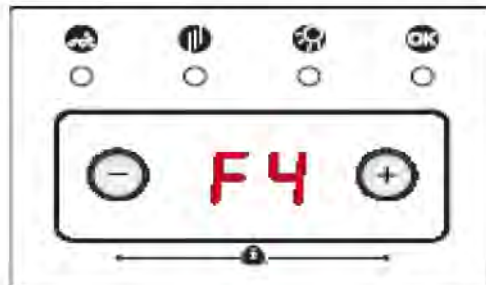
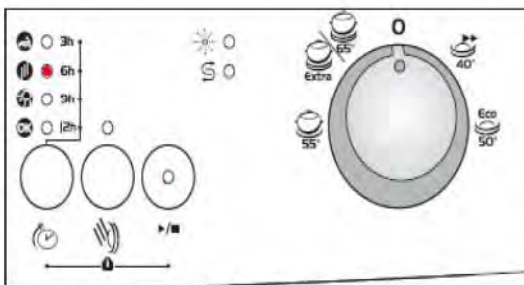

Possible problems:

- 1-Flowmeter can be out of order.
- 2- Cable connection of flowmeter can be faulty.
- 3- Electronic card can be out of order.

13. Faulty turbidity sensor

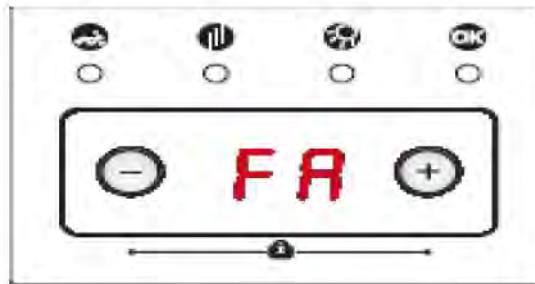

Possible problems:

- 1- Turbidity sensor can be out of order.
- 2- There can be some soil around the turbidity sensor.
- 3- Electronic card can be out of order.

14. Door is open

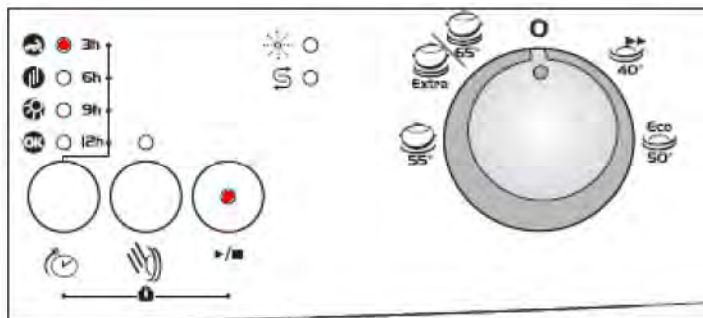

Possible problems:

- 1-Door lock mechanism can be out of order.
- 2- There can be a problem with the cable connection of door lock.
- 3- Electronic card can be out of order.

FULLY-INTEGRATED D13 FAILURE CODES

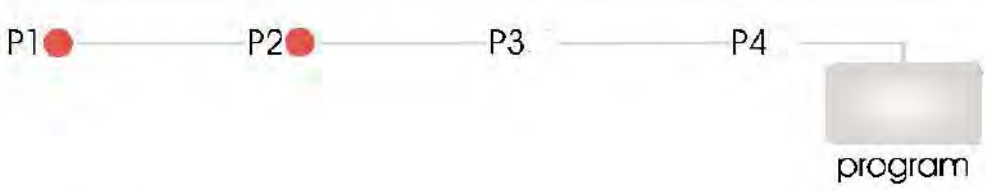
1. Inadequate water supply

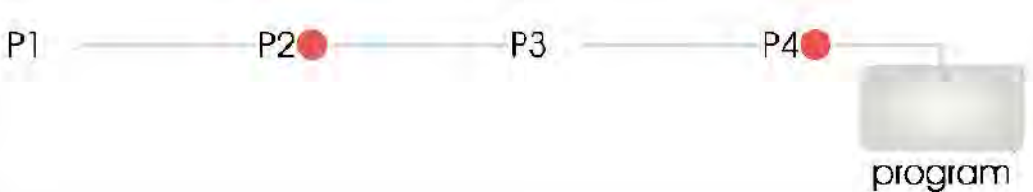
<p>Possible problems:</p> <ol style="list-style-type: none">1- Make sure the water input tap is totally open and that there is no water cut.2- Close the water input tap, separate the water input hose from the tap and clean the filter at the connection end of the hose.3- Water inlet hose can be out of order.4- Water inlet valve filter can be clogged.5- Water inlet valve can be out of order.6- There can be a problem with the cable connection of water inlet valve.7- Floater switch can be out of order or have a problem with the cable connection.8- Pressure switch of the heater casing group can have a mechanical or cable connection problem.9- Circulation pump can be out of order or have a problem with the cable connection.

2. Error of continuous water input

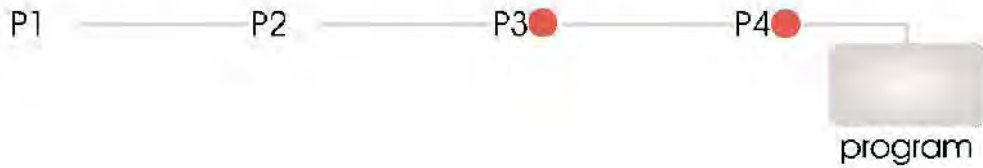
<p>Possible problems:</p> <ol style="list-style-type: none">1- Water inlet valve can be out of order or can not be closed.2- Electronic card can be out of order.

3. The waste water in the machine cannot be discharged



Possible problems:

- 1- Water outlet hose is clogged.
- 2- Water outlet hose position can be too high.
- 3- The drain pump can be out of order.
- 4- There can be a problem with cable connection of the drain pump.
- 5- Pressure switch of the heater casing group can have a mechanical or cable connection problem.

4. Heater Error: Inadequate heat

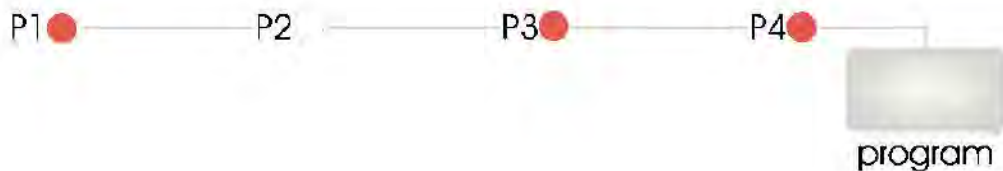

Possible problems:

- 1- Heater can be out of order.
- 2- There can be a problem with cable connection of the heater.
- 3- Thermal protection can be out of order.
- 4- Electronic card can be out of order.

5. Alarm is active against water overflow

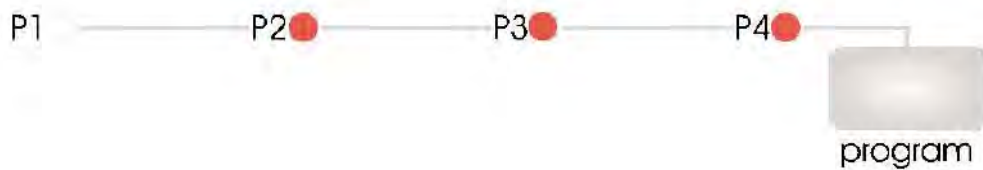

Possible problems:

- 1- Floater switch can be out of order or have a problem with the cable connection.
- 2- Electronic card can be out of order.

6. Alarm is active against water leakage

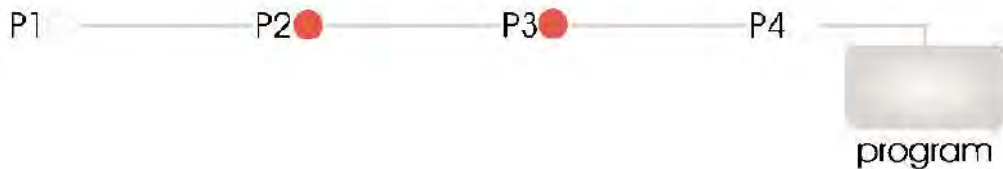

Possible problems:

- 1- There can be a water leakage from the tub.
- 2- Floater switch can be out of order or have a problem with the cable connection.
- 3- Drain pump and pressure switch can be out of order at the same time.
- 4- Electronic card can be out of order.

7. Exceed heating problem (temp. of water inside the machine is too high)

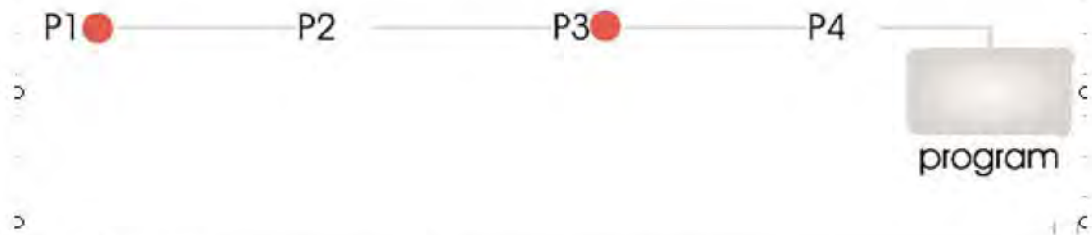

Possible problems:

- 1- Water inside the machine is $>77^{\circ}\text{C}$, NTC can be out of order.
- 2- Electronic card can be out of order.

8. NTC faulty

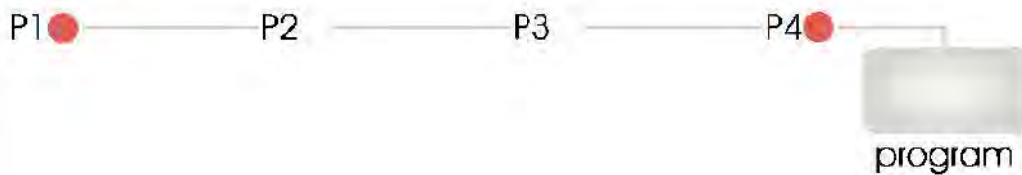

Possible problems:

- 1- NTC can be out of order.
- 2- NTC cable connection can be faulty. NTC can be short or open circuit.
- 3- Electronic card can be out of order.

9. Electronic card parameter faulty

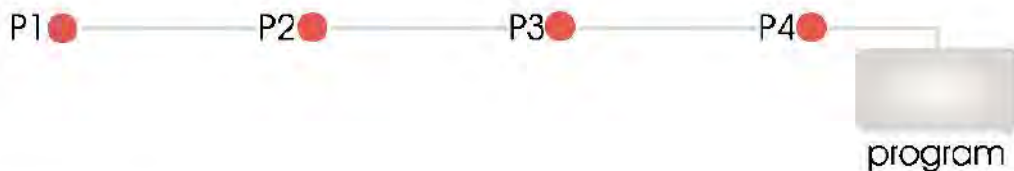

Possible problems:

- 1- By the immediate and continuous voltage decreases software variants can not be kept in the memory of electronic card.
- 2- The program continues, when you restart it. You should warn the user about controlling the network voltage.

10. Faulty Flowmeter

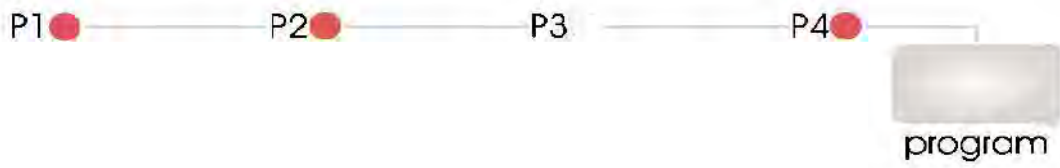

Possible problems:

- 1-Flowmeter can be out of order.
- 2- Cable connection of flowmeter can be faulty.
- 3- Electronic card can be out of order.

FULLY-INTEGRATED D21 FAILURE CODES

1. Inadequate water supply

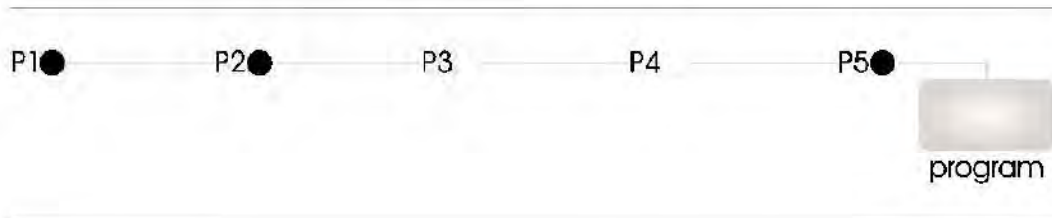

Possible problems:

- 1- Make sure the water input tap is totally open and that there is no water cut.
- 2- Close the water input tap, separate the water input hose from the tap and clean the filter at the connection end of the hose.
- 3- Water inlet hose can be out of order.
- 4- Water inlet valve filter can be clogged.
- 5- Water inlet valve can be out of order.
- 6- There can be a problem with the cable connection of water inlet valve.
- 7- Floater switch can be out of order or have a problem with the cable connection.
- 8- Pressure switch of the heater casing group can have a mechanical or cable connection problem.
- 9- Circulation pump can be out of order or have a problem with the cable connection.

2. Error of continuous water input

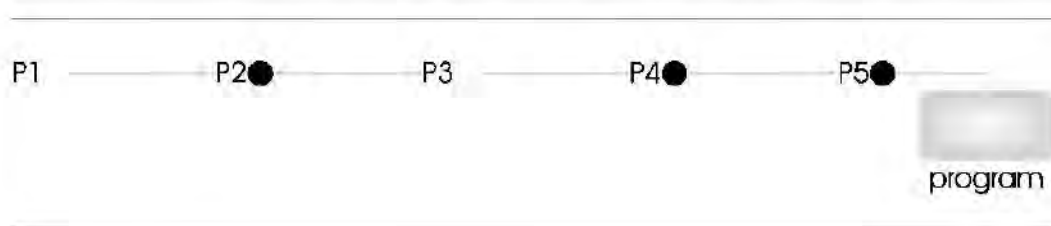

Possible problems:

- 1- Water inlet valve can be out of order or can not be closed.
- 2- Electronic card can be out of order.

3. The waste water in the machine cannot be discharged

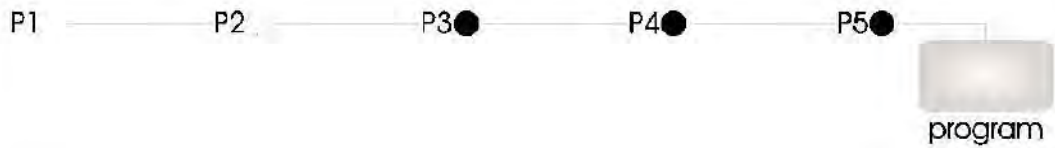

Possible problems:

- 1- Water outlet hose is clogged.
- 2- Water outlet hose position can be too high.
- 3- The drain pump can be out of order.
- 4- There can be a problem with cable connection of the drain pump.
- 5- Pressure switch of the heater casing group can have a mechanical or cable connection problem

4. Heater Error: Inadequate heat



Possible problems:

- 1- Heater can be out of order.
- 2- There can be a problem with cable connection of the heater.
- 3- Thermal protection can be out of order.
- 4- Electronic card can be out of order.

5. Alarm is active against water overflow

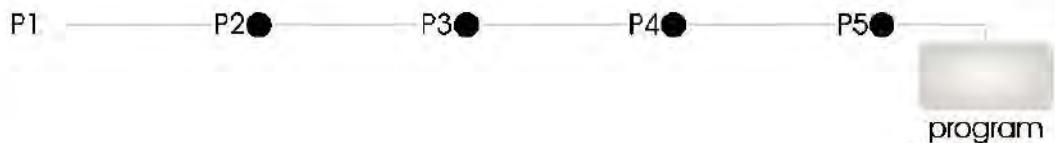

Possible problems:

- 1- Floater switch can be out of order or have a problem with the cable connection.
- 2- Electronic card can be out of order.

6. Alarm is active against water leakage



Possible problems:

- 1- There can be a water leakage from the tub.
- 2- Floater switch can be out of order or have a problem with the cable connection.
- 3- Drain pump and pressure switch can be out of order at the same time.
- 4- Electronic card can be out of order.

7. Exceed heating problem (temp. of water inside the machine is too high)

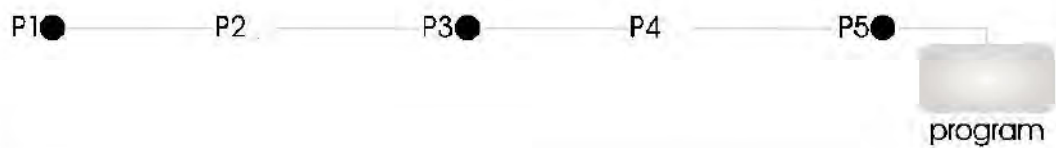

Possible problems:

- 1- Water inside the machine is $>77^{\circ}\text{C}$, NTC can be out of order.
- 2- Electronic card can be out of order.

8. NTC faulty



Possible problems:

- 1- NTC can be out of order.
- 2- NTC cable connection can be faulty. NTC can be short or open circuit.
- 3- Electronic card can be out of order.

9. Electronic card parameter faulty

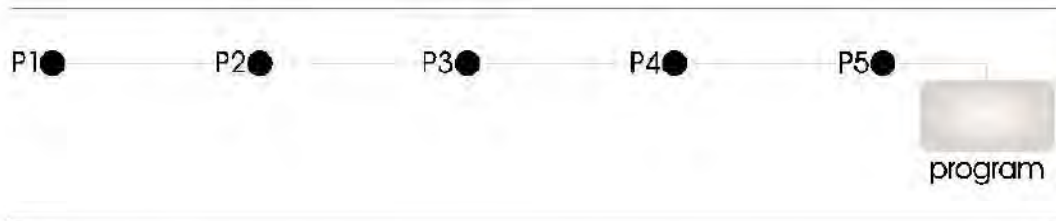

Possible problems:

- 1- By the immediate and continuous voltage decreases software variants can not be kept in the memory of electronic card.
- 2- The program continues, when you restart it. You should warn the user about controlling the network voltage.

10. Faulty Flowmeter

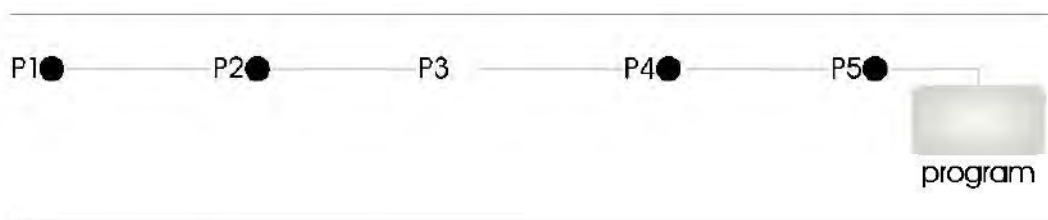

Possible problems:

- 1-Flowmeter can be out of order.
- 2- Cable connection of flowmeter can be faulty.
- 3- Electronic card can be out of order.

FULLY-INTEGRATED D41 FAILURE CODES

1. Inadequate water supply



F5



Possible problems:

- 1- Make sure the water input tap is totally open and that there is no water cut.
- 2- Close the water input tap, separate the water input hose from the tap and clean the filter at the connection end of the hose.
- 3- Water inlet hose can be out of order.
- 4- Water inlet valve filter can be clogged.
- 5- Water inlet valve can be out of order.
- 6- There can be a problem with the cable connection of water inlet valve.
- 7- Floater switch can be out of order or have a problem with the cable connection.
- 8- Pressure switch of the heater casing group can have a mechanical or cable connection problem.
- 9- Circulation pump can be out of order or have a problem with the cable connection.

2. Error of continuous water input



F3



Possible problems:

- 1- Water inlet valve can be out of order or can not be closed.
- 2- Electronic card can be out of order.

3. The waste water in the machine cannot be discharged



Possible problems:

- 1- Water outlet hose is clogged.
- 2- Water outlet hose position can be too high.
- 3- The drain pump can be out of order.
- 4- There can be a problem with cable connection of the drain pump.
- 5- Pressure switch of the heater casing group can have a mechanical or cable connection problem.

4. Heater Error: Inadequate heat



Possible problems:

- 1- Heater can be out of order.
- 2- There can be a problem with cable connection of the heater.
- 3- Thermal protection can be out of order.
- 4- Electronic card can be out of order.

5. Alarm is active against water overflow



Possible problems:

- 1- Floater switch can be out of order or have a problem with the cable connection.
- 2- Electronic card can be out of order.

6. Alarm is active against water leakage



Possible problems:

- 1- There can be a water leakage from the tub.
- 2- Floater switch can be out of order or have a problem with the cable connection.
- 3- Drain pump and pressure switch can be out of order at the same time.
- 4- Electronic card can be out of order.

7. Exceed heating problem (temp. of water inside the machine is too high)

F 7



Possible problems:

- 1- Water inside the machine is $>77^{\circ}\text{C}$, NTC can be out of order.
- 2- Electronic card can be out of order.

8. Diverter position problem

F 9



Possible problems:

- 1- There can be a water leakage to diverter contacts and diverter electric contacts can have open circuit
- 2- There can be a problem with cable connection of the diverter.
- 3- Electronic card can be out of order.

9. NTC faulty

F 6



Possible problems:

- 1- NTC can be out of order.
- 2- NTC cable connection can be faulty. NTC can be short or open circuit.
- 3- Electronic card can be out of order.

10. Electronic card parameter faulty



Possible problems:

- 1- By the immediate and continuous voltage decreases software variants can not be kept in the memory of electronic card.
- 2- The program continues, when you restart it. You should warn the user about controlling the network voltage.

11. Electronic card water hardness faulty



Possible problems:

- 1- Water Hardness is not adjusted or Water Hardness adjustment can not be kept in the electronic card memory.
- 2- Water Hardness should be adjusted by controlling the supply water.

12. Faulty Flowmeter



Possible problems:

- 1-Flowmeter can be out of order.
- 2- Cable connection of flowmeter can be faulty.
- 3- Electronic card can be out of order.

13. Faulty turbidity sensor



Possible problems:

- 1- Turbidity sensor can be out of order.
- 2- There can be some soil around the turbidity sensor.
- 3- Electronic card can be out of order.

NECESSARY INFORMATION HAVE TO BE GIVEN TO USERS WHILE INSTALLATING THE DISHWASHER

Customers should be informed about following items.

- Give general information to user about the product.
- General information about washing programmes and suggest to the customer using suitable program according to the dirtiness level.
- Give information about additional functions.
- Give information to the customer about starting the machine, following the program, resetting the program and changing the program.
- Give information about activate and inactivate the child lock. Customers should be informed about the child lock will not be inactivate automatically at the end of the programme.
- Models haved $\frac{1}{2}$ half load option;



In $\frac{1}{2}$ option, when only upper lamp is flashed, only upper spray will be in operation.



In $\frac{1}{2}$ option, when only lower lamp is flashed, only lower spray will be on operation



When both lamps are flashed, this function is half load function. If the customers have little amount of dishes, they should use this function.

When both lamps are not flashed, it means the machine will continue normal operation. When the lamps are not flashing, does not mean spray arms are not rotating.

- The customers should be informed about looking at instruction manual at first, when they face to failure.
- After installing the machine to a suitable place, run it unloaded for the first time.

This should be recommended to the customers that they should search the instruction manual carefully when there is a possible repair.

REPAIR TECHNIQUES

COMPONENTS AND RESISTANCE VALUES

COMPONENTS	REAL VALUES	NOTES
ON / OFF BUTTON	0 Ω on component	ON/OFF button is pressed
DOOR SWITCH (KAPI KİLİDİ)	CN2.9 – CN2.2 0 Ω	Door is close
PRESSURE SWITCH	CN2.10 – CN2.2 0 Ω ∞ Ω	FULL FILL WATER NO WATER
DRAIN PUMP	CN2.2 – CN2.4 143 Ω % \pm 7	
WATER INLET VALVE	CN2.6 – CN 2.9 3750 Ω \pm %10 (20C ^o)	
REGENERATION VALVE	CN2.10 – CN2.7 4130 Ω \pm %10(25 C ^o)	
SALT SENSOR	CN5.1 – CN5.2 0 Ω NO SALT ∞ Ω THERE IS SALT	MEASURE JUST ON THE ELECTRONIC CARD
HEATER	26.19 \pm 15 Ω	MEASURE JUST ON THE COMPONENT
DETERGENT DISPENSER	1660 Ω \pm %10 (25 C ^o)	MEASURE JUST ON THE COMPONENT
CIRCULATION PUMP	CN2.3 – CN2.9 95 \pm %7 Ω 126 \pm % 7 Ω	Primary winding Secondary winding (FROM THE COMPONENT)
SET NTC SENSOR	CN 3.2 25 ^o 5000 Ω % \pm 5.0 CN 3.1 35 ^o 3300 Ω % \pm 5.5 55 ^o 1520 Ω % \pm 6.5 63 ^o 1174 Ω % \pm 7.5 80 ^o 670 Ω % \pm 8.0 90 ^o 488 Ω % \pm 8.5	
FAN MOTOR	CN 6.2 – CN 2.9 238.6 \pm % 5	
DIVERTER	CN 6.1 – CN 2.9 6840 \pm % 5	
RINSE AID SENSOR	CN 5.3 – CN5.2 0 Ω ∞ Ω	RINSE AID OFF RINSE AID ON
FLOATER (MICROSWITCH)	CN2.1 – CN 2.5 0 Ω CN2.1 – CN 2.4 ∞ Ω	MICROSWITCH IS INACTIVE (NO WATER) MİKROSWITCH IS ACTIVE (THERE IS WATER)

MEASURING THE COMPONENTS FROM THE ELECTRONICAL CARD

You might measure the components either connectors of electronic card or directly on the component.

Measuring from the connectors of electronic card gives definite results to define the repair. If you know the specialities and values of tester, you can easily determine the repair.



a)



b)

In order to reach the connections of the electronic card; dismantle the control panel (Picture a) and probes of the tester should be applied on to the related connectors of the electrical card; control the values according to the resistance value table. (picture b)

Free-standing and semi-integrated electronic card



Fully-Integrated electronic card



Free-standing and semi-integrated display card



Fully-Integrated display card



Precaution: Always remove the plug from the power socket before touching internal components.

Washing Pump:

From the Electrical Card:

You can only measure the primary winding value from the electrical card. Resistance value of the primary winding must be **95 Ω on the connectors CN2.3 – CN2.9.**

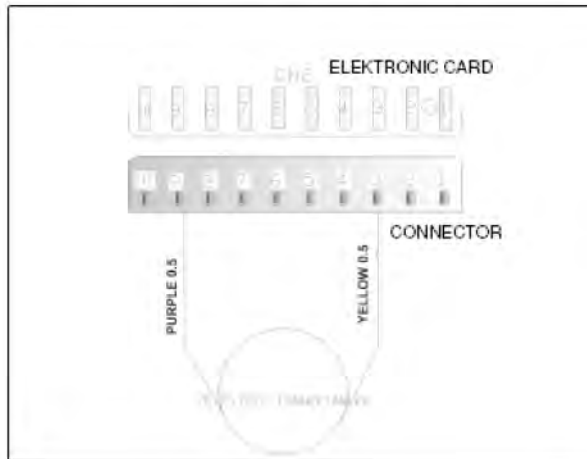

Above sketch show the connectors of the washing pump on the electrical card. Probes of the tester should be applied on to the related connectors.

From the component:



Measurement of the primary windings of the washing pump



Measurement of the secondary windings of the washing pump
(white cable – blue cable)

Probes of the tester should be applied on to the related connectors as shown on the pictures.

VALUES OF PUMP COILS

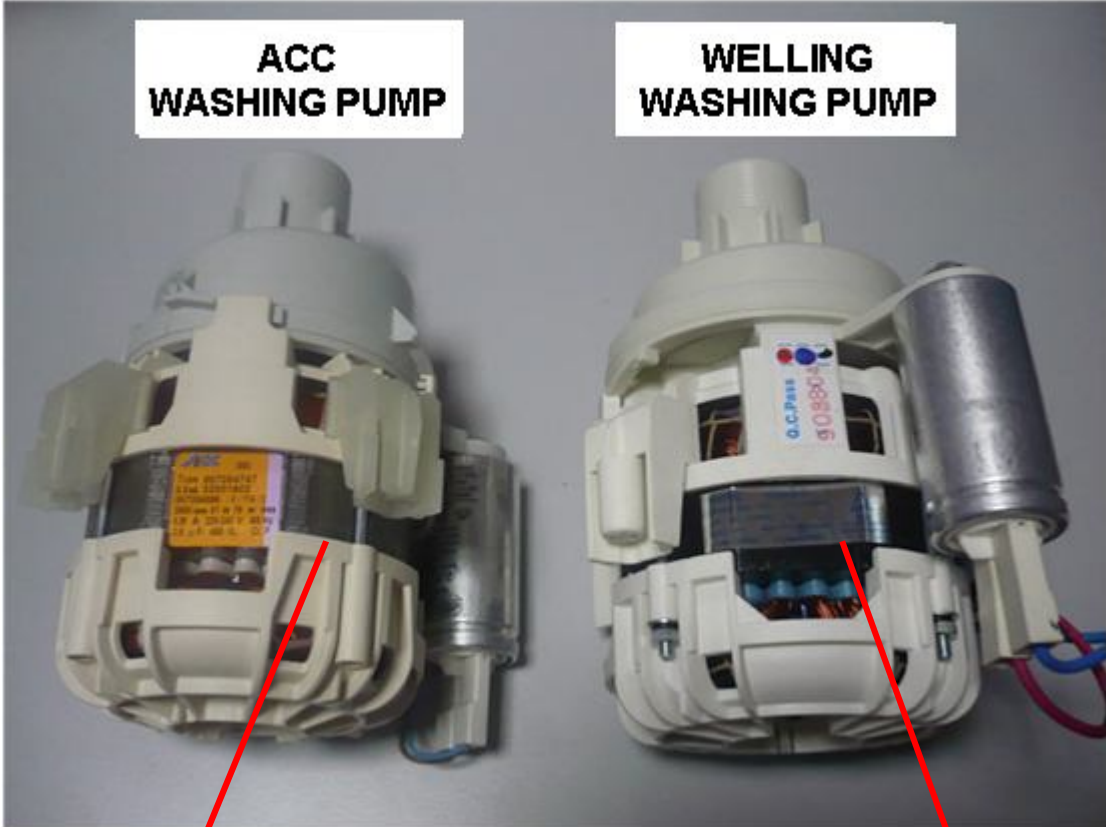

ACC WASHING POMP

MAIN COIL: 95 Ω ±7

SUB COIL: 125 Ω ±7

WELLING WASHING POMP

MAIN COIL: 120 Ω ± 7

SUB COIL: 116 Ω ± 7

Drain Pump:

From the Electronical Card:

$143 \pm 7 \Omega$ on the connectors CN2.2 – CN2.4

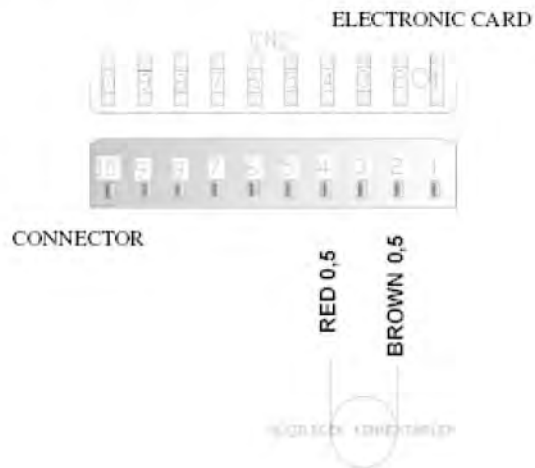

Above sketch show the connectors of the drain pump on the electronical card. Probes of the tester should be applied on to the related connectors.

From the component :



Probes of the tester should be applied on to the related connectors as shown on the pictures

VALUES OF PUMP COILS

**PLASET
DRAIN PUMP**

**HANYU
DRAIN PUMP**



PLASET DRAIN PUMP

143 Ω ± 7

HANYU DRAIN PUMP

210 Ω ± 6

Water inlet valve:

From the Electrical Card:

$3750 \pm 10 \ \Omega$ (20 C°) on the connectors CN2.6 – CN 2.9

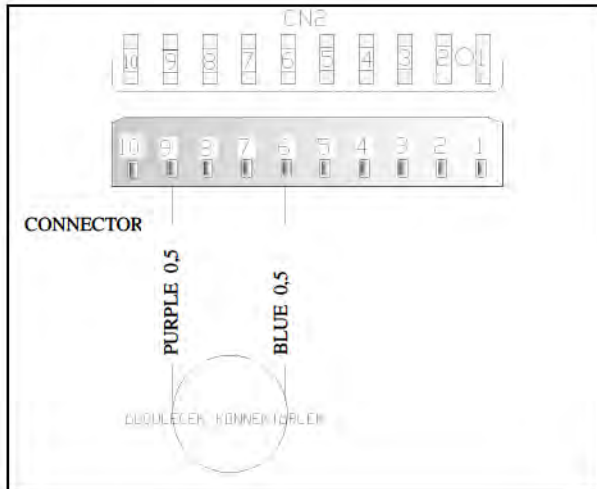

Above sketch show the connectors of the water inlet valve on the electrical card. Probes of the tester should be applied on to the related connectors.

From the component:



Probes of the tester should be applied on to the related connectors as shown on the pictures.

WATER INLET VALVES (OPTIONAL)

**BITRON ELBI
WATER INLET VALVE**



**TP
WATER INLET VALVE**



**3750 Ω \pm 10
(20 $^{\circ}$)**

Heater Casing:

It can't be measured from the electrical card.

From the component:

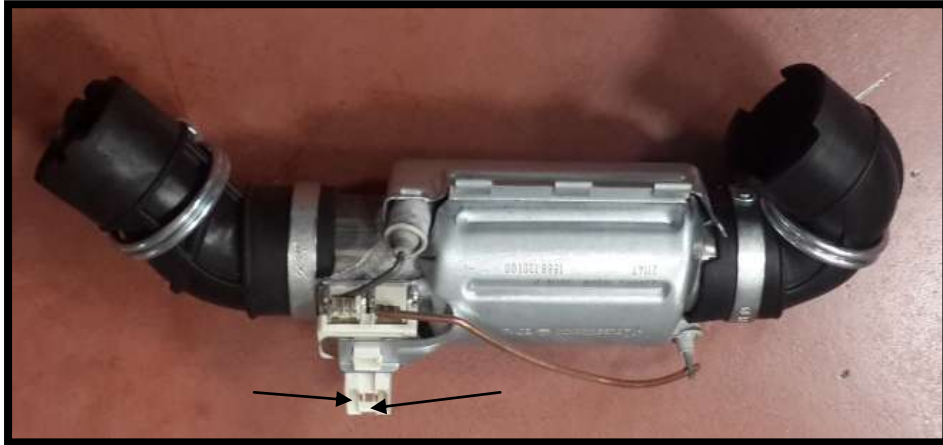

Detergent Dispenser:

It can't be measured from the electrical card.

$1660 \pm 10 \ \Omega$ (25 C °)

From the component:



Regeneration Valve:

From the Electrical Card:

$4130 \pm 10 \ \Omega$ (25 C °) on the connectors CN2.10 – CN2.7

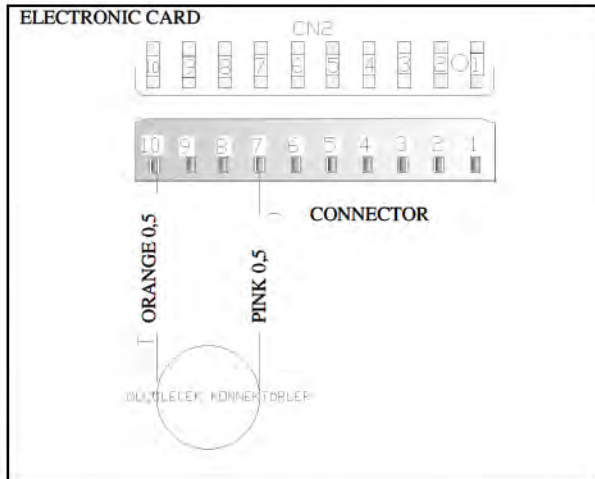

Above sketch show the connectors of the regeneration valve on the electrical card. Probes of the tester should be applied on to the related connectors.

From the component:



Probes of the tester should be applied on to the related connectors as shown on the pictures.

Pressure Switch:

From the Electrical Card:

CN2.10 - CN2.2 0Ω There is water (Full)
 $\infty \Omega$ There is not water (Empty)

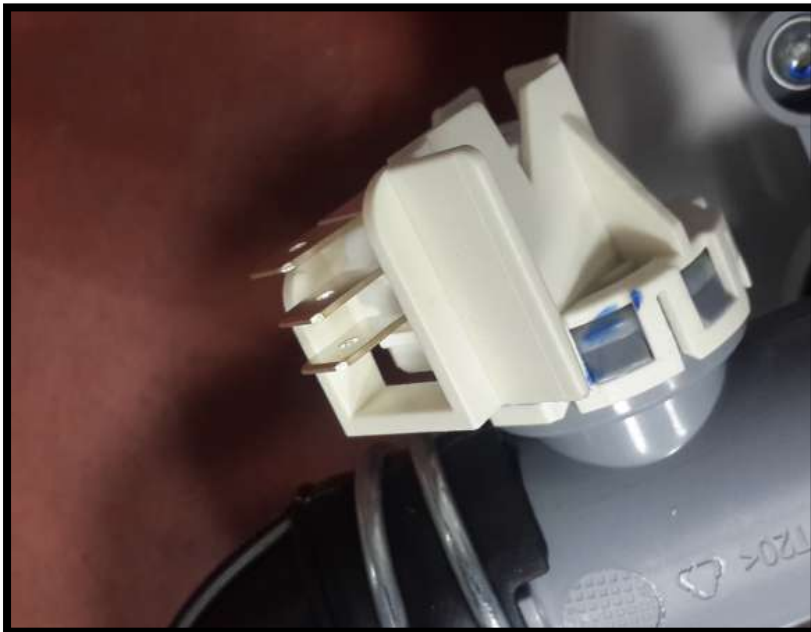
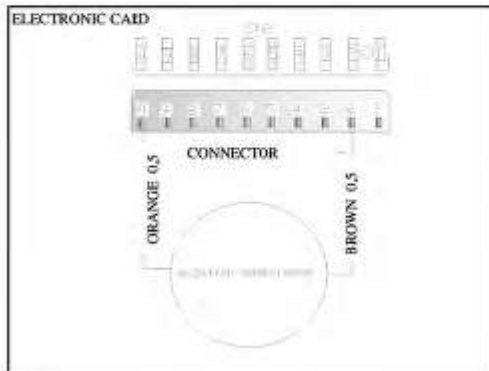

Pressure Switch:

From the Electrical Card:

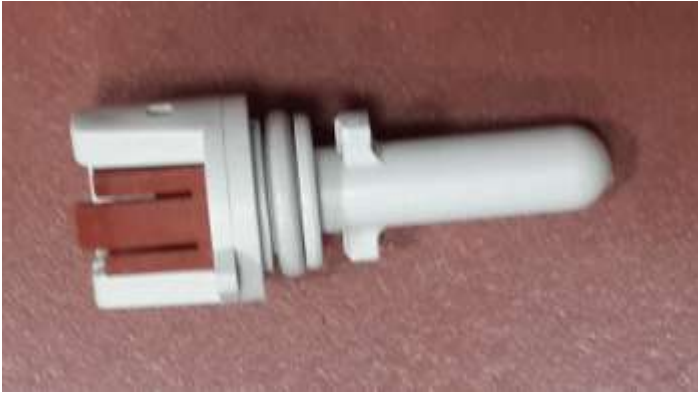

Diverter:

From the Electronical Card:

6840 Ω -% \pm 5.0 on the connectors CN6.1 – CN 2.9

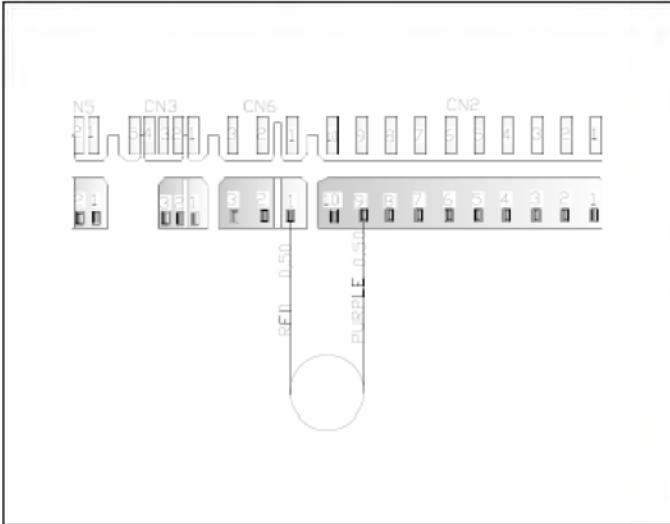

Sketch above show the connectors of the diverter on the electrical card. Probes of the tester should be applied on to the related connectors.

From the component:

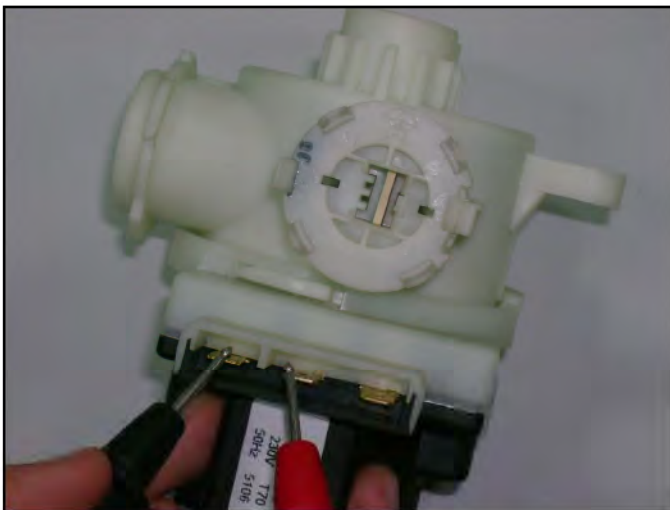

Probes of the tester should be applied on to the related connectors as shown on the pictures.

Salt Sensor:

From the Electronical Card:

CN5.1 – CN5.2 0 Ω NO SALT
 ∞ Ω THERE IS SALT

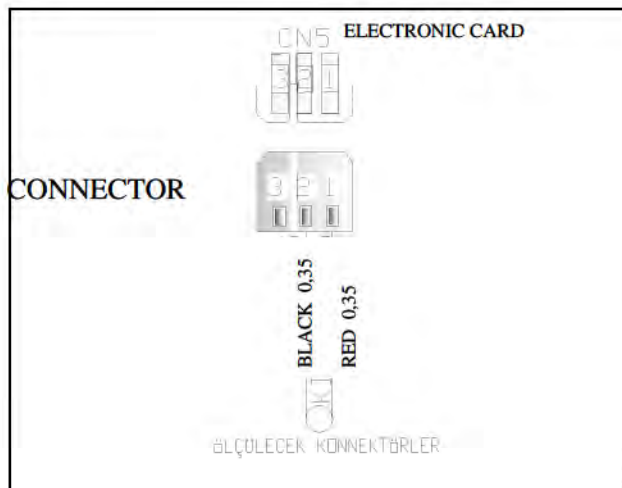

Sketch above show the connectors of the salt sensor on the electronic card. Probes of the tester should be applied on to the related connectors.

From the component :



Salt sensor can also be measured from the water softener when the salt sensor assembled on the water softener.

Probes of the tester should be applied on to the related connectors as shown on the pictures.

FLOATER:

From the Electrical Card:

CN2.1 – CN 2.5	0 Ω (Position1)	MICROSWITCH IS INACTIVE (NO WATER)
CN2.1–CN2.4	∞ Ω (Position2)	MICROSWITCH IS ACTIVE (WATER)

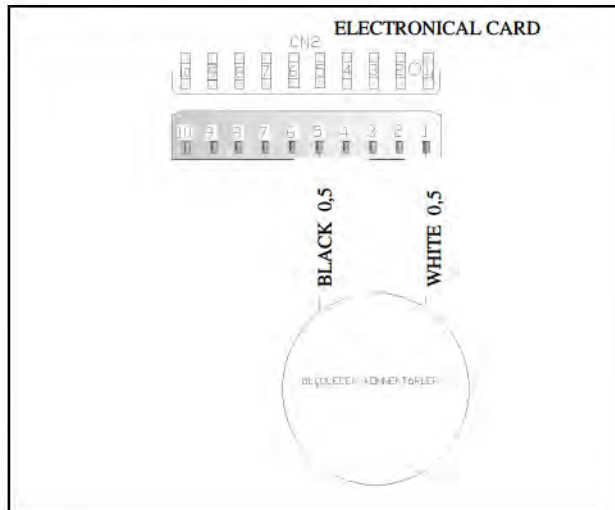

Position 1: You can check the floater by controlling the specified value intervals.

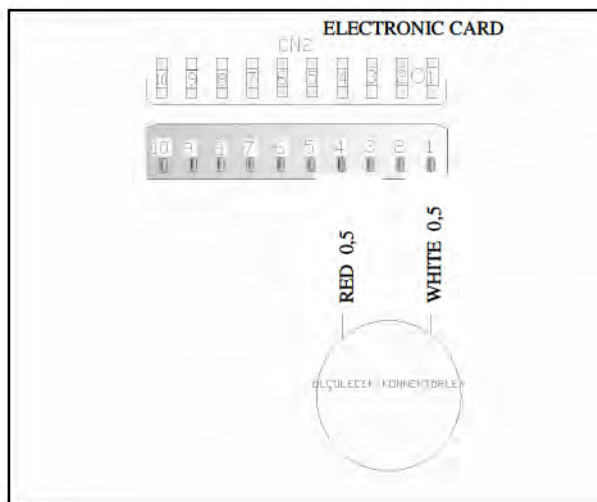

Position 2: If failure code is occurred related with the floater within control the above values; you can figure out whether leakage occurs or not.

Door Switch :

From the Electrical Card:

0 Ω on the connectors CN2.9 – CN2.2 (Door is close)

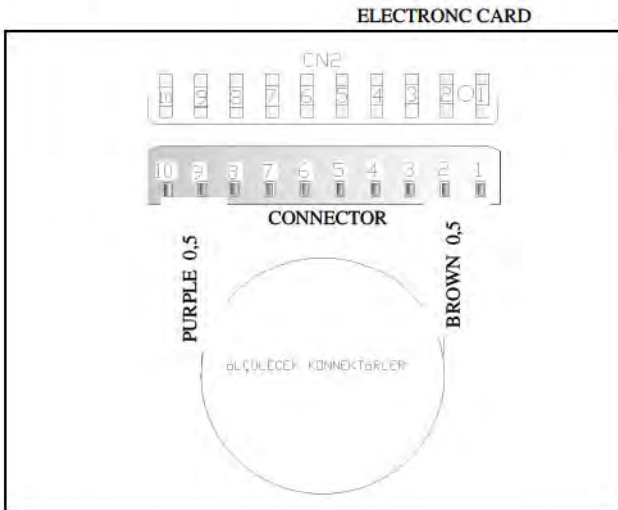

Above sketch show the connectors of the door switch on the electrical card.

From the component:



Probes of the tester should be applied on to the related connectors as shown on the pictures.

Fan Motor:

From the Electrical Card:

238.6 Ω \pm % 5 on the connectors CN 6.2 – CN 2.9

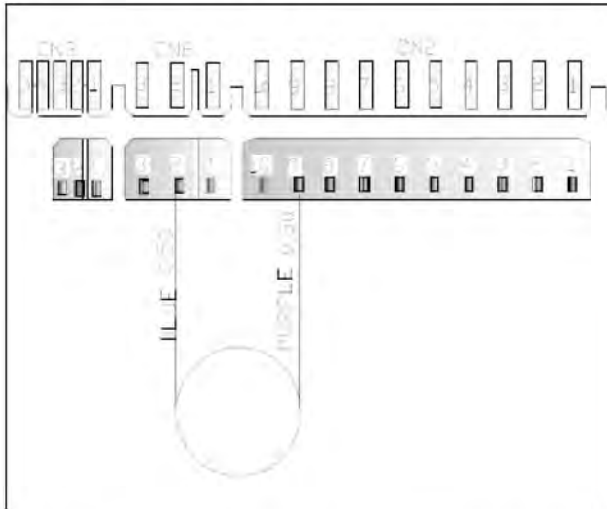

Above sketch shows the connectors of the fan motor on the electrical card.

From the component :



Probes of the tester should be applied on to the related connectors as shown on the pictures.

Rinse Aid Sensor:

From the Electrical Card:

CN 5.2 – CN 5.3	0 Ω	There isn't any rinse aid
	∞ Ω	There is rinse aid

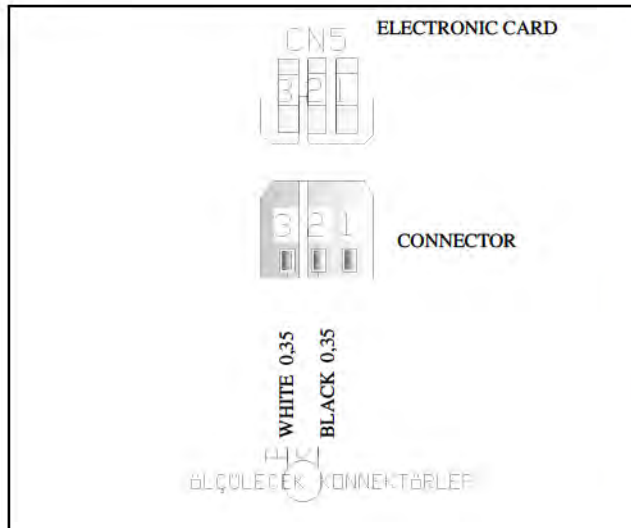

Above sketch shows the connectors of the rinse aid sensor on the electronic card.

From the component :



Probes of the tester should be applied on to the related connectors as shown on the pictures.

On/Off Button:

It can't be measured from the electrical card

From the component:

0 Ω	When the button is pressed
------------	----------------------------



ADDITIONAL INFORMATIONS

Machine does not work.

1-Check the plug is connected or not.



2-Control supply voltage.

3- Control the supply cord.

4- Control cable connections.



5-Control the connector connections of pcb card.



6-Control the pcb card.

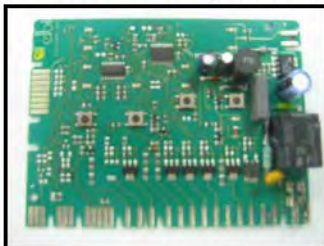

Poor drying

1- The programme which hasn't got a drying phase; could be selected. The customers should be informed about the programmes.

2- There might be lack of rinse aid at the rinse aid compartment.

FNPC11, FNPC12, FNPC13 haven't got any rinse aid indicator. Control the rinse aid by using the rinse aid level indicator



There isn't any rinse aid



There is rinse aid

FNPC21, FNPC31 and FNAC41 have rinse aid indicator on the control panel.



There isn't any rinse aid



There is rinse aid

4- There can be mechanical or electrical problem with the detergent dispenser.

5- There can be a problem on the PCB card..

DISASSEMBLY

1) ACCESSIBILITY

1.1) Front Panel

a) Remove six screws that fix the front panel.



b).Pull down the front panel as it shown in the Picture.



Front panel

Remove six screws that fix the front panel.



1.2) Side panels

While removing side panels ;

- a) Remove six screws that fix side panels at the back.



- b) Remove two cabine gaskets as it shown in the Picture.



b) Remove four screw covers carefully as it shown in the Picture.



b) Remove six screws which are in front of the machine.

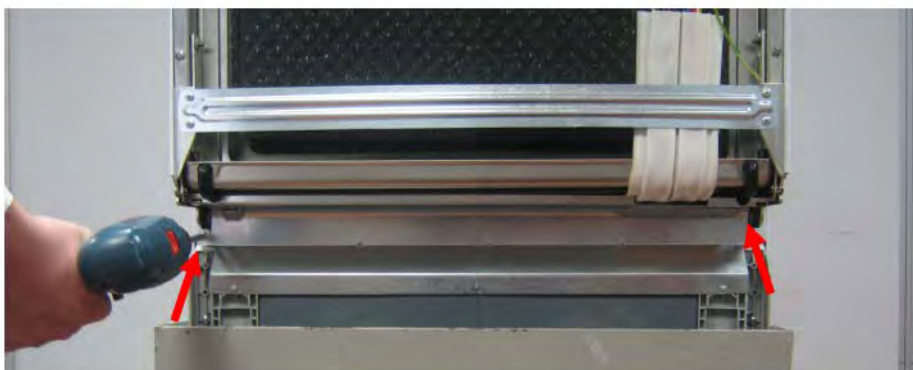

c) To remove the side panel , remove the upper plastic hinge and than the above one and pull it up.



1.3) Kick Plate Sheet Iron

a) Side panels. (see 1.2)

b) Remove three screws tat fix the kick plate sheet iron.

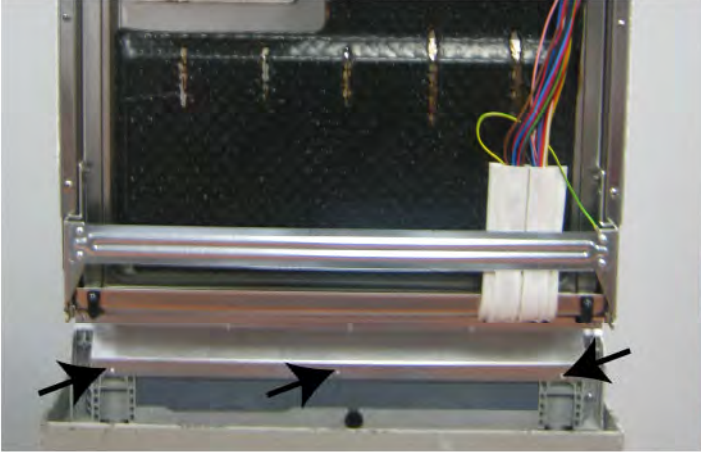

c) pull it down as shown in the picture.

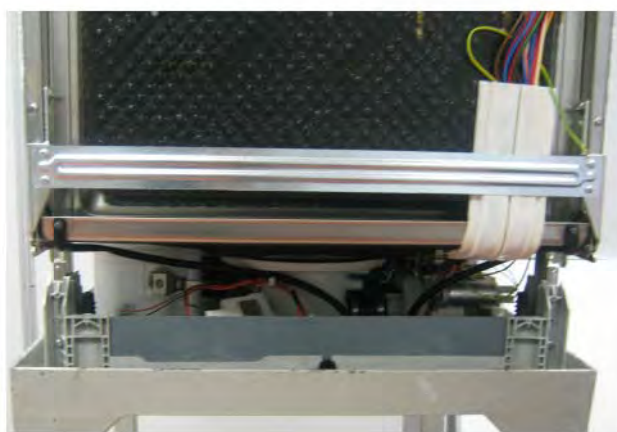

1.4) Basement front cover

a) Remove side panels and kick Plate Sheet Iron . (see 1.2 - 1.3)

b) pull it up as shown in the picture.

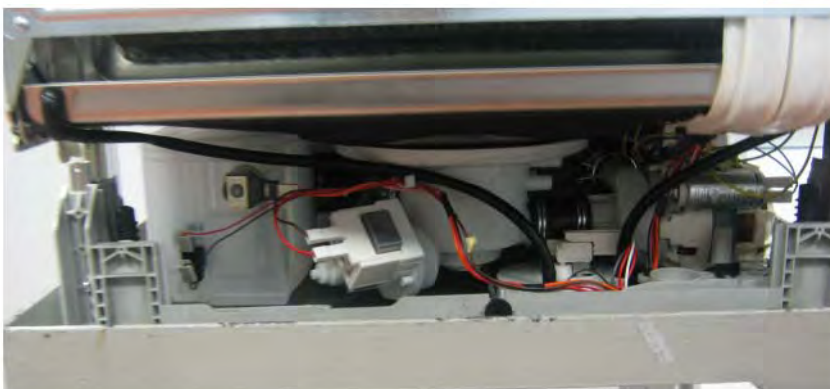

1.5) Control Panel - (For Semi Integrated Models)

a) Remove six screws that fix control panel to the door inside sheet iron.



b) Remove the cable connection plastic which fix cable harness to the control panel as shown in the Picture.



c) Remove the control panel group carefully as shown in the picture.



d) Remove the wires that are connected to control panel group.

1.5.1) Rotary Switch



- a) Remove the control panel.(see 1.5)
- b)Remove the wire that is connected to the electronic card.
- c) Remove two screws fixing to the control panel group.

1.5.2) Electronic Card



- a)Remove the wires that are shown in the picture. .

WARNING : while removing wires , do not pull them from wires , pull from connectors.

- b)Remove pcb box cover with pulling its plastic hinges.

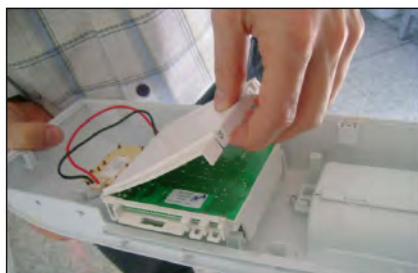



c) Remove the wire which is between rotary switch and electronic card.

d) Remove the electronic card from pcb box by removing pcb box's plastic hinges.



1.5.3 Display Card (Only for C4 models)



a) Remove the wire that is between display card and electronic card.

b) Remove display card from display card box's hinge carefully.



1.6) Control Panel - (Integrated Models)

a) Remove six screws that fix control panel to the door inside sheet iron.



b) Remove the cable connection plastic which fix cable harness to the control panel as shown in the Picture.



c) Remove the control panel group carefully as shown in the picture.



d) Detach the cable connections of the electronic board.



e) Detach the cable connections of the electronic board.

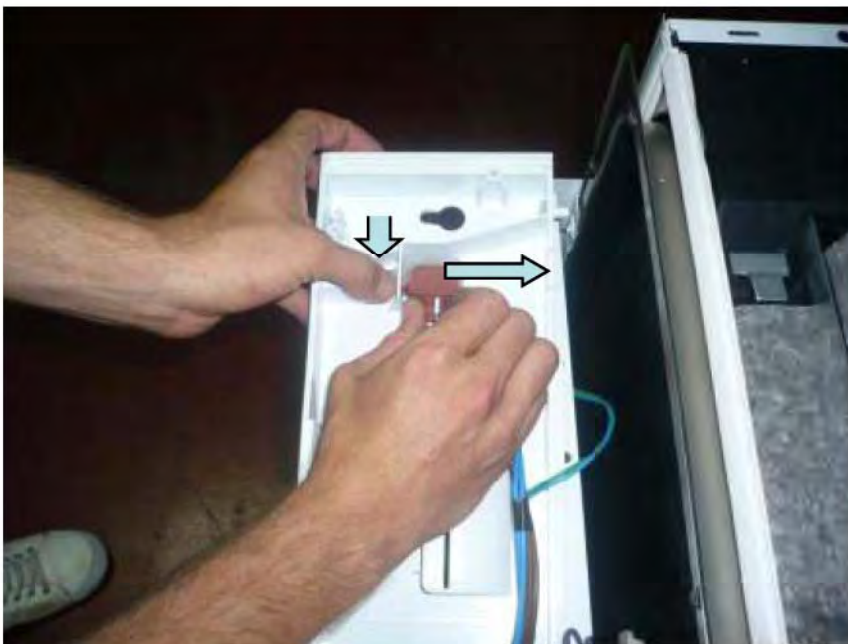

f)

Take the On/off switch off from the lower tab by pushing it downwards, and at the same time pulling in the direction of the arrow with your hand as shown in the picture, perform the same procedure for the other tab to disassemble.

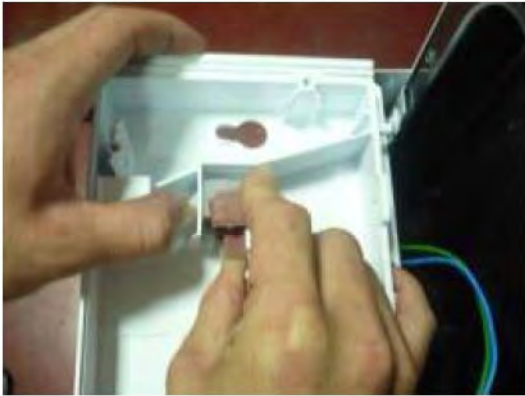

g) Disassemble by removing the screws retaining the PCB box.



h) Open the tabs of the PCB box (as shown in the picture) with a flat head screwdriver (take care not to break the plastic part)

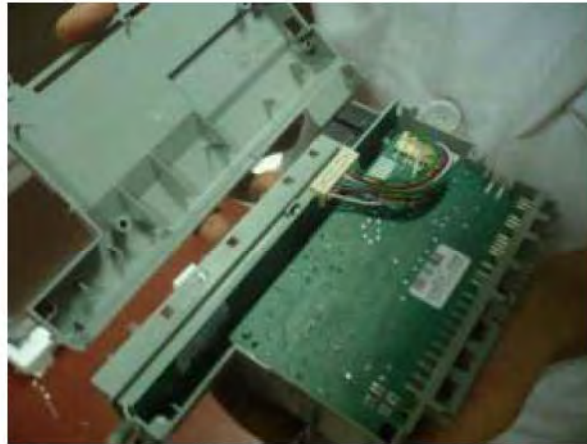

i) Detach the cable connections of the electronic board.

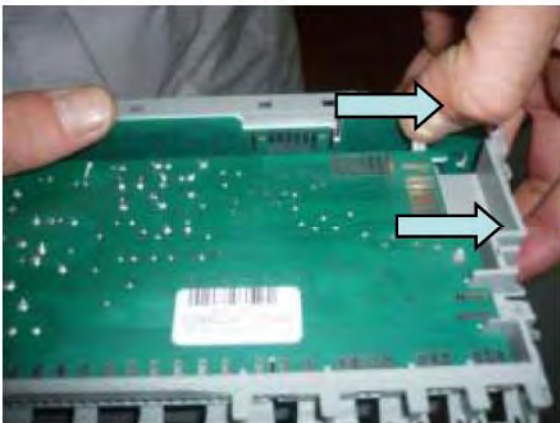
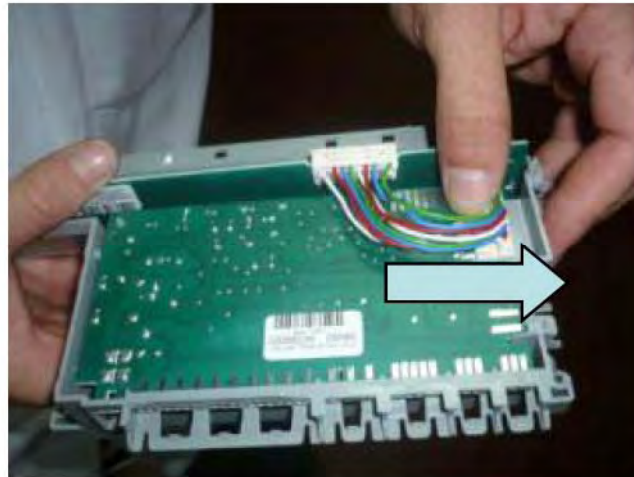

i) Disassemble the board by taking the electronic board off from the tabs retaining it to PCB box as shown in the picture.

1.7 Built-in setting assembly / 1.8 Built-in hinge spring setting assemblies

Our semi and full built-in models have the following components other than solo products ;

- Built-in setting assembly
- Built-in hinge spring setting assemblies.

Built-in setting assembly

You can adjust the rear leg of your dishwasher easily using the built-in setting assembly. Built-in setting assembly is composed of four main components.

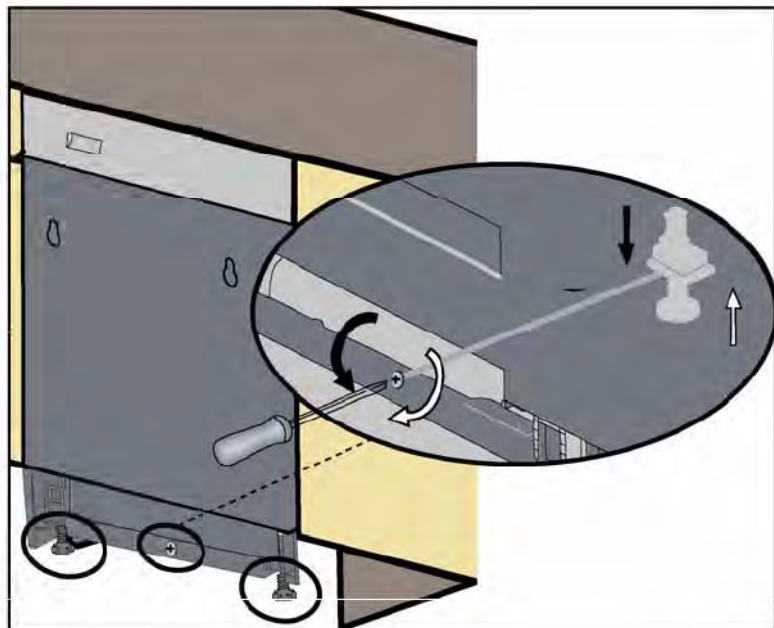
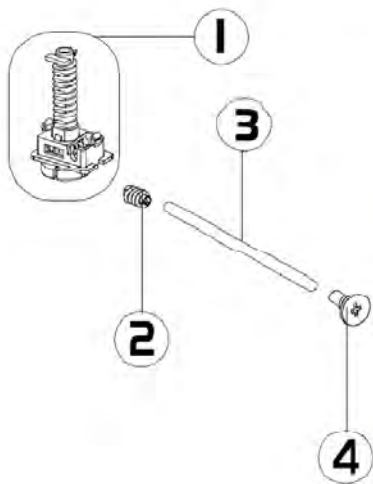

- 1 – Built-in setting assembly
- 2 – Built-in worm gear
- 3 – Built-in setting assembly shaft
- 4 – Built-in setting front rubber

1.7 Built-in setting assembly

a) Lay down your appliance so that the rear part is laid on the ground.



Note : Before laying down your appliance, collect the supply cord, discharge hose and water inlet hose on the rear part of appliance together as shown the picture to prevent damage to these components when you are laying down the appliance.



b) Remove the lower cover of the appliance by taking it off from the tabs shown in the figure using a flat head screwdriver.



c) Remove 5 screws shown in the figure to take off the kick plate.

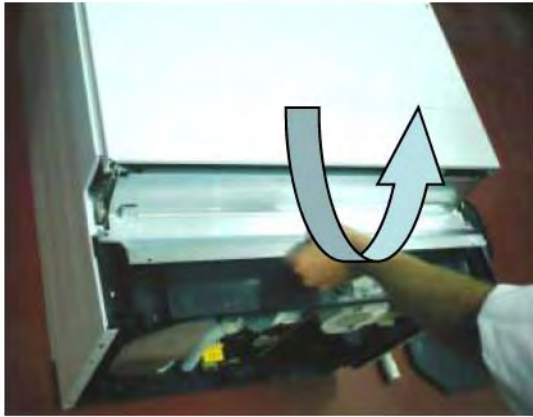

d) Remove the kick plate by pulling it towards you.



e) Remove the lower base front cover by pulling it towards you as shown in the picture.



f) Take the built-in setting front rubber off from the shaft that it is connected by pulling it as shown in the picture.



g) After removing the built-in setting front rubber, take the built-in setting assembly shaft and built-in worm gear off from the built-in setting assembly by pulling it towards you as shown in the picture.



h) Take the built-in setting assembly off from the left tab using a needle nose pliers, and at the same time, take the adjustable leg off the lower base by pulling it down with a screwdriver. Perform the same operation for the other tab.

Warning: Remove the built-in setting assembly carefully during disassembly; otherwise, it may break.



i) Take it off from the lower base by pulling it towards you.

1.8) Built-in Hinge Spring Setting Assembly

Built-in hinge spring setting assembly is a mechanism that allows you to adjust the door of your appliance according to the board you have installed on the appliance. There are 2 assemblies: a left one and a right one.

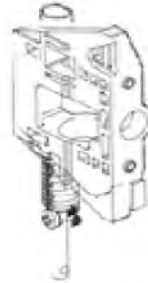

a) To disassemble the built-in hinge spring setting assembly, you should remove the side panel on the side that you would like to remove. (see 1.2)

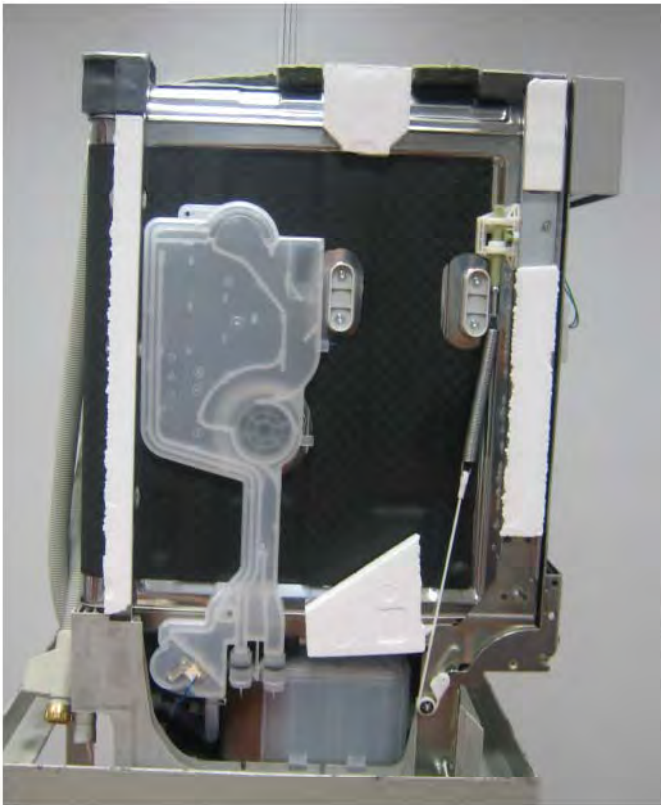

b) Remove the door strap from the hinge spring as shown in the picture.

c) Remove 2 screws retaining hinge spring setting assembly to the sink, and release the hinge spring setting assembly.



d) Disassemble the hinge spring, by removing it from the hinge spring setting assembly as shown in the picture.



1.9)Door Lock Group



- a) Remove control panel group. (see 1.6)
- b) Remove two screws that fix the door lock group.

1.10) Dispanser

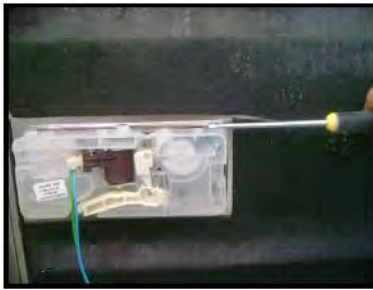

- a) Remove the front panel (see 1.2)
- b) Remove the wire.
- c) Remove dispenser from inside door's hinges by using slotted screwdriver.
- d) Push and remove the dispenser .

Warning : use work gloves otherwise inside door iron sheet can cut your hands.

1.11) Door Inside

- a) Remove side panels. (see 1.4)
- b) Remove Built-in Hinge Spring (see 1.8)

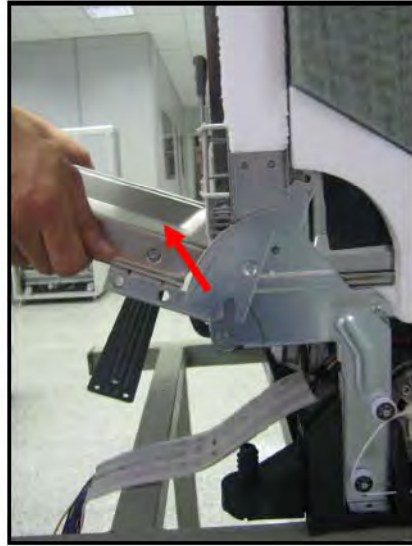

c) Pull the door inside up as it is shown in the picture..

d) remove two screws that fix hinge movement sheet iron to the door inside.



THE INNER COMPONENTS

2.) To Access The Components From Sides



a)Right Sight

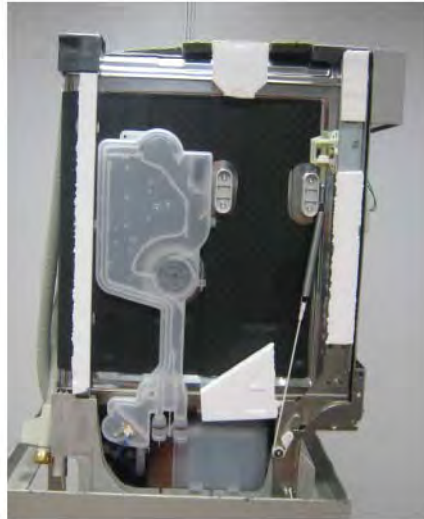

b)Left Sight

2.1 Steam Condenser (only in the models that have active or turbo drying systems)



- a)Remove right panel.
- b)Open the door , and remove steam condenser's nut.
- c) Pull steam condenser.

2.2) NTC with Thermal Protector



a) Remove right side panel.(see 1.4)



b) Remove the wires as it is shown in the Picture.

c) Pull the pim down as it is shown in the picture.

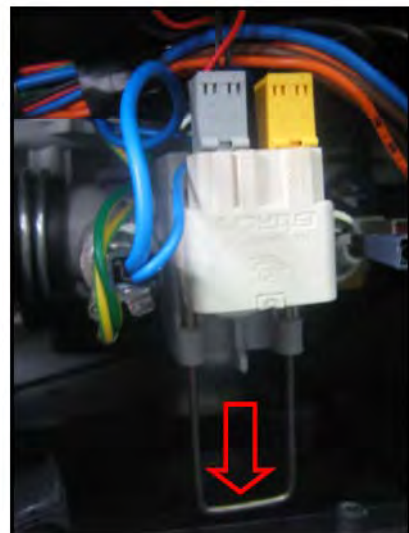

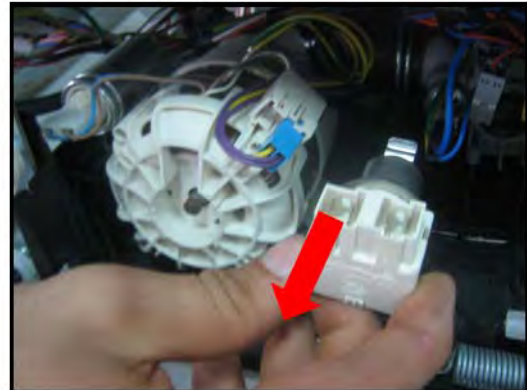
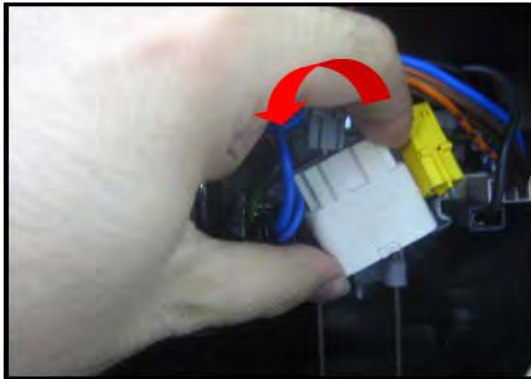

d) Remove the NTC as it is shown in the picture.

2.3) Air-Break

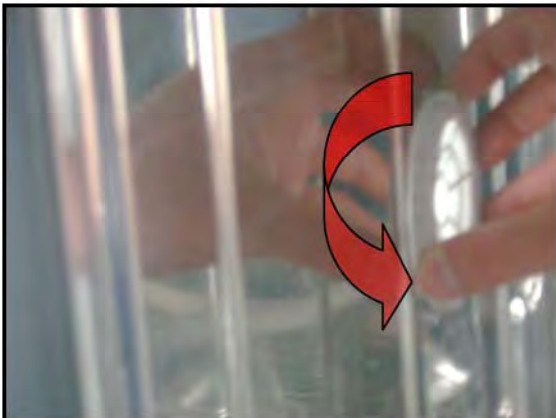

a) Remove the left side panel of the machine.. (see 1.4)

b) open machine's door..

c) Rotate counterclockwise air-break nut and remove it.



d) Remove air -break's connections with salt cap as it is shown in the picture.(be careful about plastic hinges)



2.4) Hose Connection Plastic



a) Remove left side panel. (see 1.4)



b)By using flat tip screwdriver remove hose connection plastic's hinge from the basement as it shown in the picture.



c)push the hose connection plastic.

Warning : If you do not obey instructions while disassembly of the hose connection plastic it can be broken.

2.5) Power Cord

a) Remove hose connection plastic.(see 2.3)



e) Remove the lower cover.(see)

f) Remove the wires that is between power cord and parasite filter.



e) Remove the power cord..

2.6 LED MODUL (Opsional)

a)- Remove the right side panel.

b)- Remove the electrical connections as in the picture.



c)- LED modules behind the nut by turning it counter-clockwise direction to remove.



3. To Access The Components From In Front Of The Machine



a) Remove Plastic kick plate iron sheet and casement front cover (see 1.3 – 1.4)

3.1) Regeneration Valve

a) Remove Plastic kick plate and .kick plate iron sheet.(see 1.3 – 1.5)

b) Remove the wires..

c) To remove regeneration Value rotate counterclockwise and pull it as it is shown in the picture.

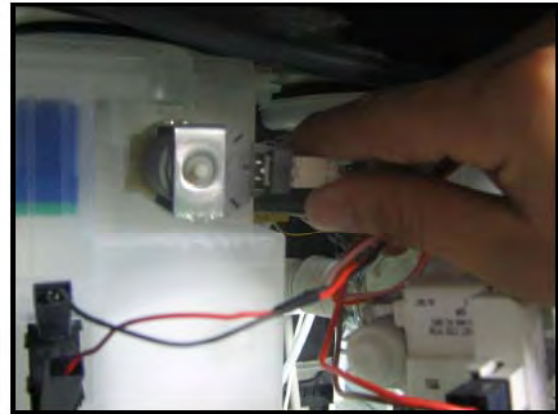

3.2) Drain Pump



a) Remove Plastic kick plate and .kick plate iron sheet.(see 1.3 – 1.5)

b) Remove the wires..

c) To remove the drain pump that fixes to the sump, rotate it in the direction of counterclockwise and pull .

4 To Access The Components from the Lower Cover

- a) Lay the appliance on the rear panel.



- b) Remove lower cover from the places that are shown in the picture.



4.1) Circulation Pump

a) Lay the appliance on the rear panel. (see 4)

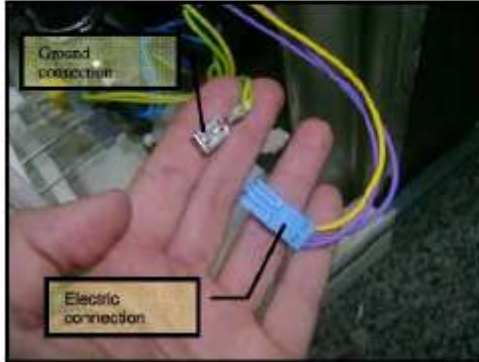

4.3)Water Softener



a) To remove salt cup cover, rotate it in the direction of counterclockwise .



b) To remove salt cup nut , rotate it in the direction of counterclockwise .

c) Remove left side panel (see 1.4)

d) detach the connections which are between water softener and air-break.



e) Remove lower cover.

f) Remove the hose that is between sump and salt camp.

4.4) Parasite Filtler

a) Remove lower cover.



b) Remove one screw fixing parasite filter.



b) Remove wires..

c) Push parasite filter as shown in the picture..



4.5) Floater

a) Remove lower cover. (see 6)

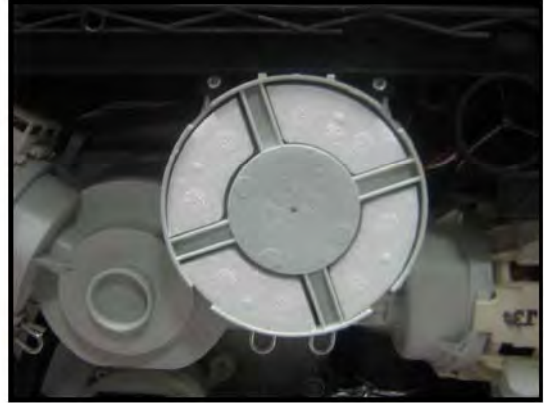

b) Remove two screws that fix floater as it is shown in the picture.



b)remove the two floater hoses .



c)Remove the wire that is connected to the floater.

4.6) Water Inlet valve

a) Remove lower cover.(see 6)

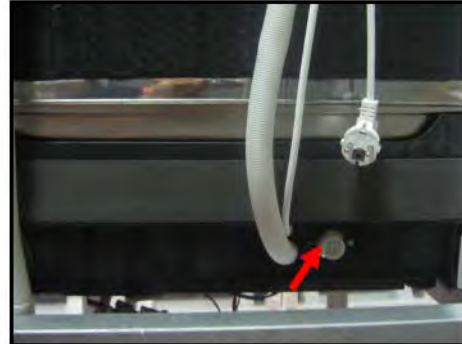

b) Remove the wire that is connected to the water inlet valve.

c) Remove the clamp that connects water inlet valve and air –break as it is shown in the picture.



c) To remove water inlet valve pull it back as it is shown in the direction of Picture then release water inlet valve from the pins that is connected to . and rotate it in the direction of counterclockwise.

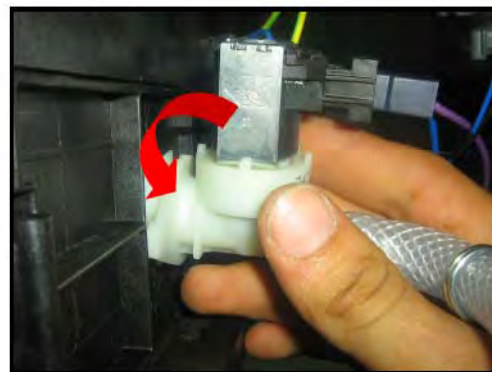

4.7) Draining Hose



- a) Remove the hose connection plastic.. (see 4.4)
- b) Remove lower cover. (see 6)
- c) Remove the clamp that fixes draining hose to the sump.
- d) Remove draining hose.

5) Basket Group

5.1) Lower Basket

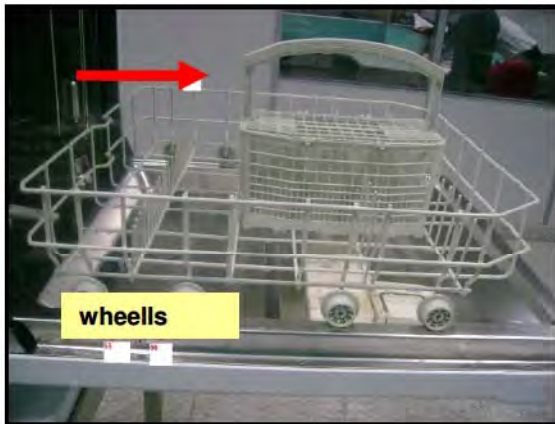

a) Open machine's door.

b) Pull the basket to yourself.

5.2) Upper Basket



a) Open machine's door.

b) Pull the basket to yourself.



c) Open Upper basket rail lock front.

d) Pull the basket to yourself and remove it.



5.3) Basket Rails

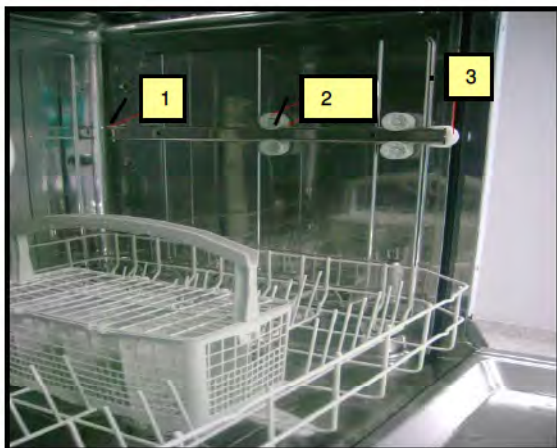

- 1- Upper basket rail stoper rear
- 2- Upper basket wheels
- 3- Upper basket rail lock front

6.) The Components That Are Inside the Tub

6.1) Course , Micro and metal filters

a)Open the door.

b)Remove lower basket.

c) to remove microfilter group rotate them in the direction of counterclockwise and pull them up as it is shown in the Picture.



d)To remove microfilter group (course filter and micro filter) pull them as it is shown in the picture.



e)to remove the metal filter pull it up as it is shown in the picture.





a) To remove the basket rails, open the door and take out baskets.



b) To remove basket rails release the rail from upper basket stopper rear.



6.2) Spray Arm System

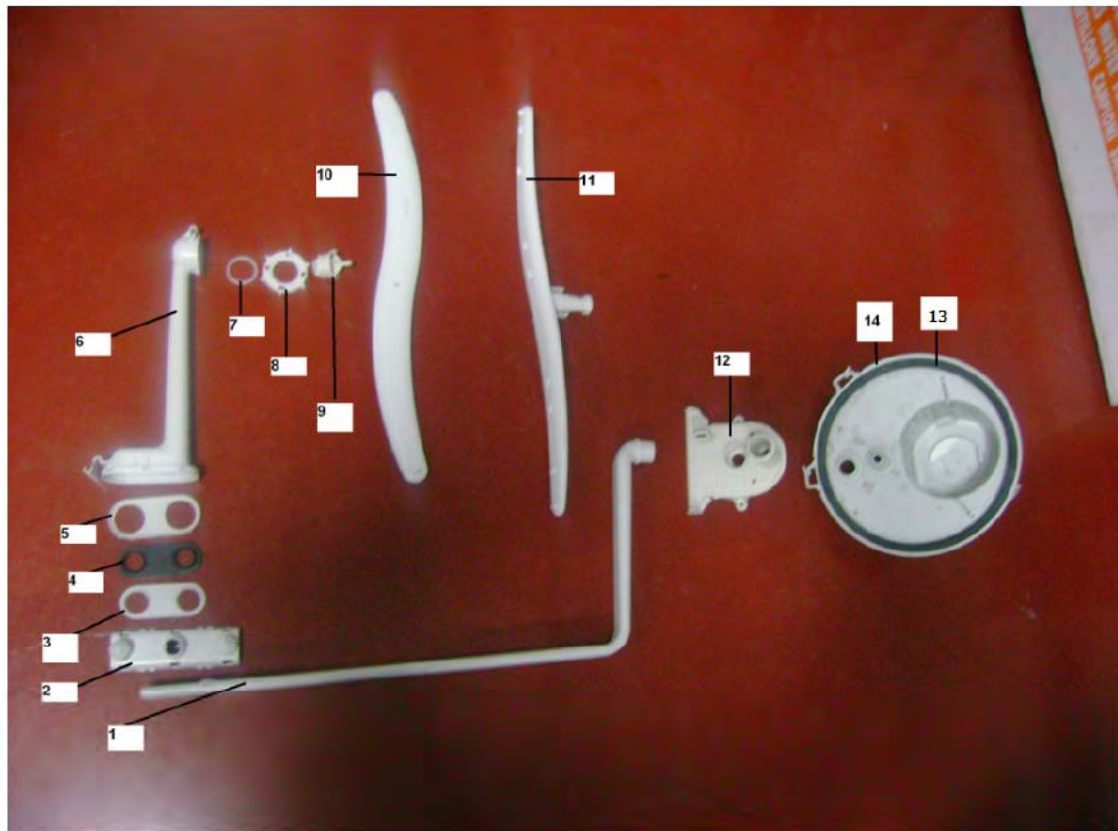

- 1 Upper spray arm feeding canal
- 2 Upper spray arm adjustment link
- 3 Upper spray arm adaptor flange
- 4 Upper spray arm adaptor gasket
- 5 Upper spray arm adaptor cover
- 6 Upper spray arm
- 7 Upper spray arm nut plastic
- 8 Upper spray arm nut
- 9 Upper spray arm shaft
- 10 Upper spray arm
- 11 Lower spray arm
- 12 Spray arm support
- 13 Sump seal
- 14 Sump



a)After removing the lower basket , pull the spray arm upwards .gripping it by the central hub.



b)to remove upper spray arm adjustment link pull it trough yourself as it is shown in the picture.



c) to remove upper spray feeding canal turn left it than pull it up as it is shown in the picture.

6.3) Sump

- a) Remove any residual water from the sump by suction so that it does not flow into the tub and the pressure switch tubes , then lay the appliance on the rear panel.
- b) Remove lover cover. (see 6)
- c) From inside tub ,remove the basket and lower spray arm .
- d) Remove the microfilter group and metal filter .
- c) detach all the hoses (sump – draining hose , circulation pump – sump, sump – water softener)



f) Remove the four screws that secure the sump to the tub.

g) Remove the two screws which secure the spray arm support to the sump.

h) detach the drain pump and pull the sump out ,taking care not to damage the tub seal.

INSTALLATION OF SEMI BUILT-IN DISHWASHERS UNDER THE COUNTER

INSTALLATION OF SEMI BUILT-IN DISHWASHERS UNDER THE COUNTER

Use the following items supplied in the document bag of the appliance for the installation of the semi and full built-in dishwashers.

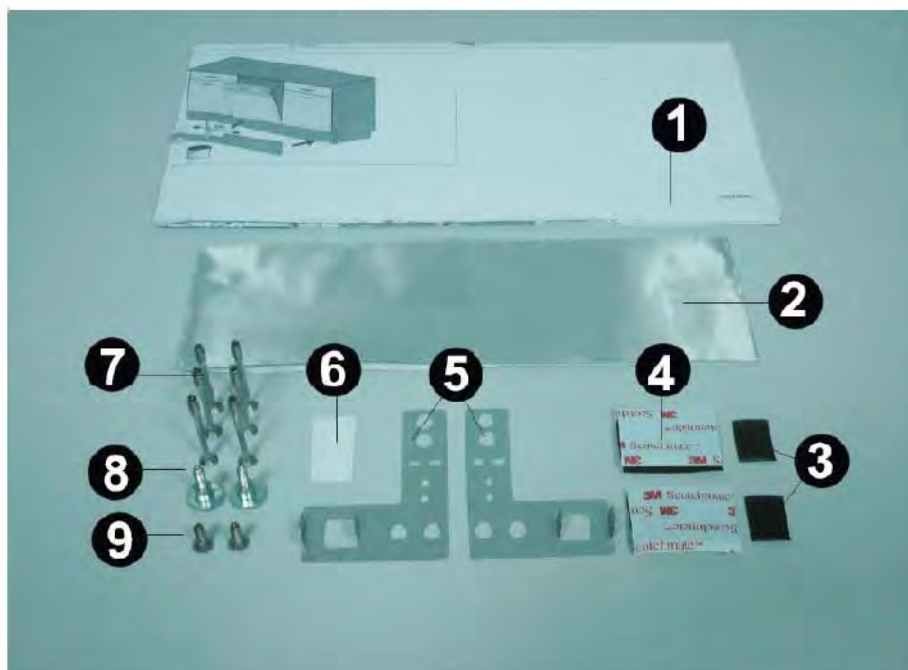

- 1 – Installation plan : manual describing the installation of the appliance under the counter.
- 2 – Vapour-proof foil
- 3 – Side retaining sticker (2 pcs)
- 4 – Board retaining sticker (2 pcs)
- 5 – Counter mounting plate, right and left
- 6 – Spring adjustment mechanism hole cover (2 pcs)
- 7 – Screw 4x42.5 YHB wallboard (4 pcs for semi built-in, 6 pcs for full built-in products)
- 8 – Board mounting screw (2 pcs)
- 9 – Screw 4x15 YHB wallboard (2 pcs)
- 10 – Stick (4 pcs supplied in semi built-in appliances)

Materials to be used in the installation process are



- 1 - Tape measure
- 2 – Drill bit (Ø 2)
- 3 – Flat head and Phillips screwdriver
- 4 – Water gauge
- 5 – Charged drill

Intall your semi built-in appliance under the counter according to semi built-in installation instructions supplied with your appliance. Installation manual includes the dimensions of the counter and board to be installed in fornt of the appliance. Consider these dimensions before starting the installation.

1 – If the counter that you will install the appliance is made of wood, stick the aluminum foil supplied in the document bag under the counter. (This prevents the vapour occurred by the opening and closing of your appliance's door from affecting the counter)



Open the aluminum foil carefully as shown in the picture.



Stick the aluminum foil under the counter that you place the appliance so that there is no clearance with the end of the counter as shown in the figure.

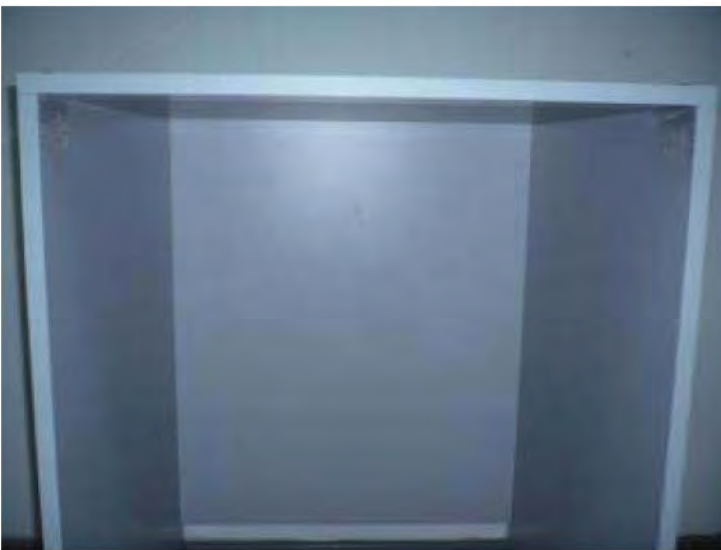

Before placing the appliance under the counter:



1 – Collect the discharge and water supply hoses and supply cord at the rear of your appliance (as shown in the figure) to prevent damage to them during installation under the counter.



2 – Install the counter mounting plates to the upper panel support bracket rubbers.

* At this stage, the counter mounting plates are installed in two ways according to the material (wood, granite, marble etc.) of the under counter that the appliance will be installed.



a) If the counter is made of wood, install the counter mounting plates so that the ends of the plates are faced inwards as shown in the figure.

* If the counter is made of wood, install the appliance to the upper side of the counter.

b) If the counter is made of a material like marble, granite, etc., install the counter mounting plates so that the ends of the plates are faced outwards as shown in the figure.



Crimp the from the point shown with an arrow in the figure after installing the counter mounting plate.

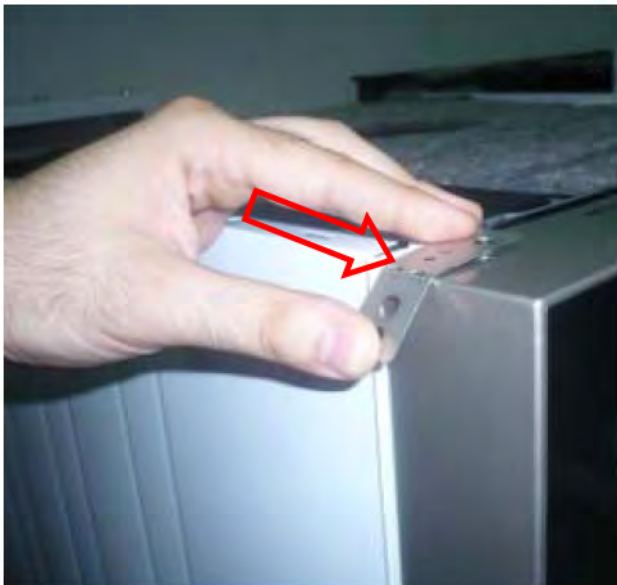

3 – Stick the side retaining stickers to the left and right panels of the appliance. The dimensions of the stickers are given in the installation manual.

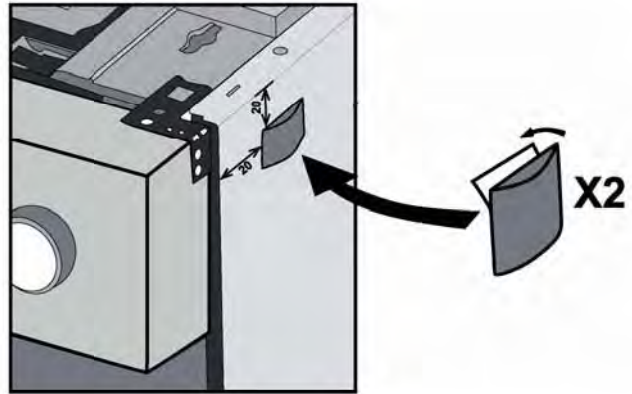

4– Place the appliance under the counter properly. Adjust the legs of the appliance so that the appliance is level with the upper panel of the counter, use a water gauge to check that the appliance is raised equally in all directions.



Use a flat head screwdriver to adjust the rear leg of your appliance. You can adjust the height of the appliance by turning the screwdriver right or left.

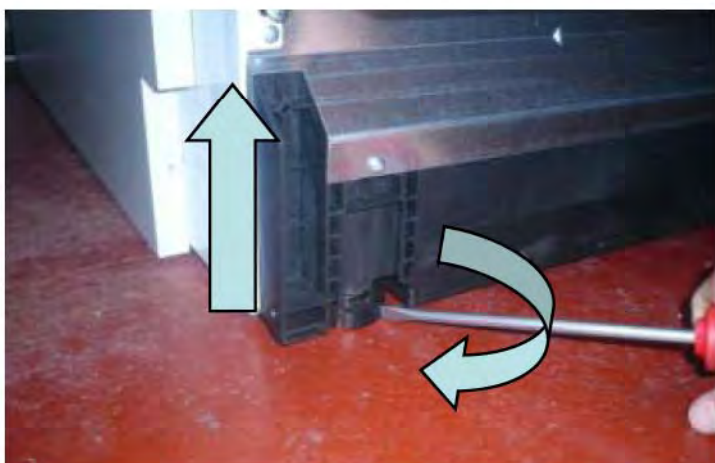
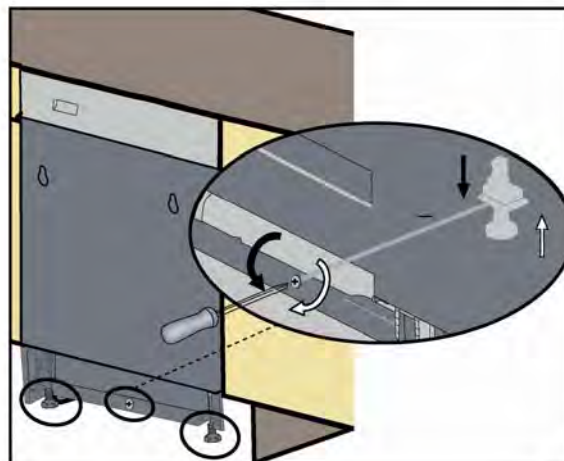

You can raise your appliance by turning the front legs of your appliance right or left as shown in the figure.

5- For the installation procedure of the furniture that will be installed in front of the appliance:

- Hold the installation manual supplied with your appliance under the control panel so that it is equal in both directions without slipping it. Mark the installation manual with your pen with respect to the drawer or cover in your kitchen that you need to align your machine with.

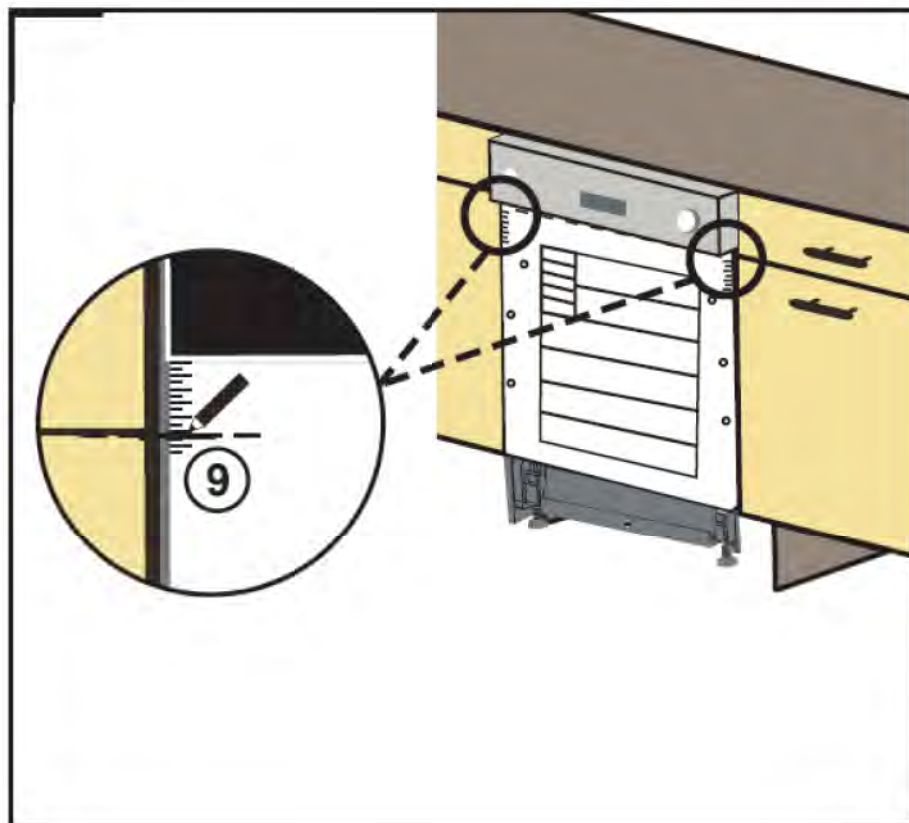
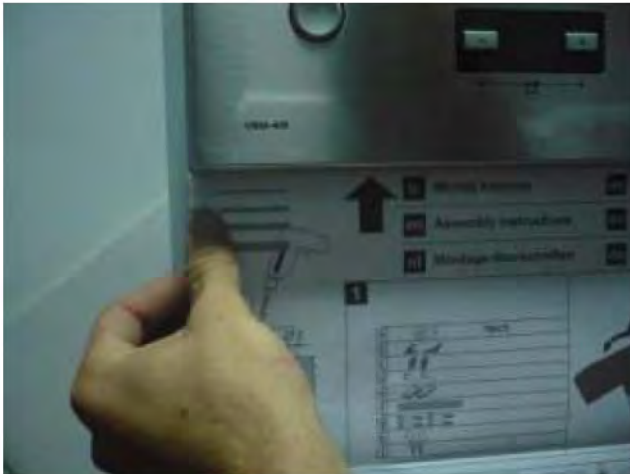

6 – Place the installation manual on the furniture properly, place it outwards to the extent that you have marked before.



7 – Drill screw holes on the furniture from the points shown on the installation manual.

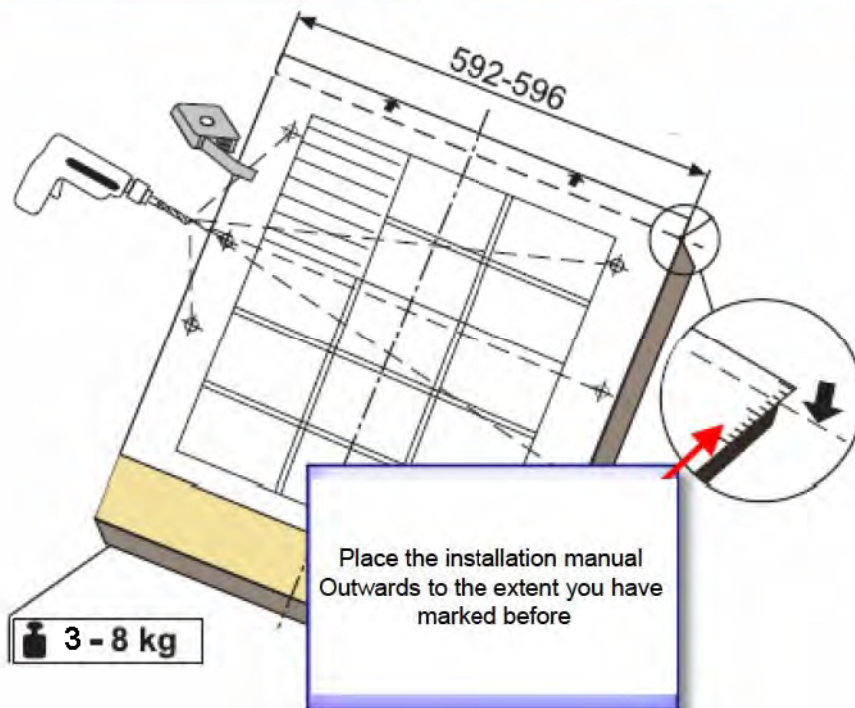
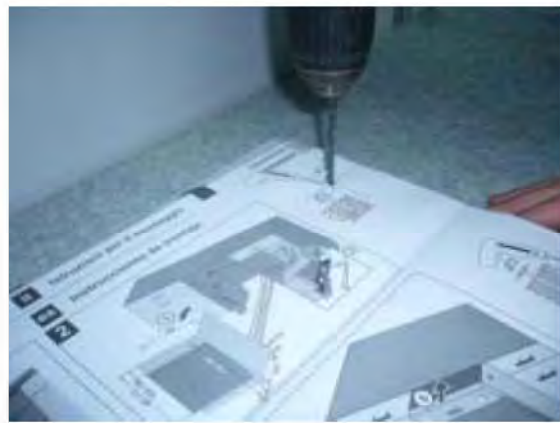

8 – Place the wood mounting screws to the screw holes you have drilled before.



1- Strip and stick the tape on the lower side to the furniture.
(Stickers should be placed in the dimensions shown in the figure)

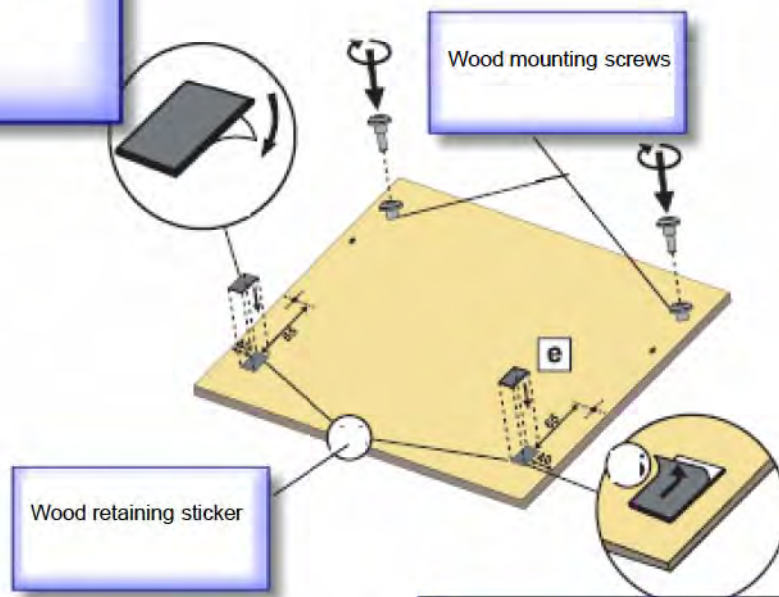

2- Remove the protective layer of the tape and prepare for installation after sticking it to the furniture.

9 – Install the sticks supplied with your appliance to the control panel. Refer to the installation manual to determine how many sticks you will install on the appliance.

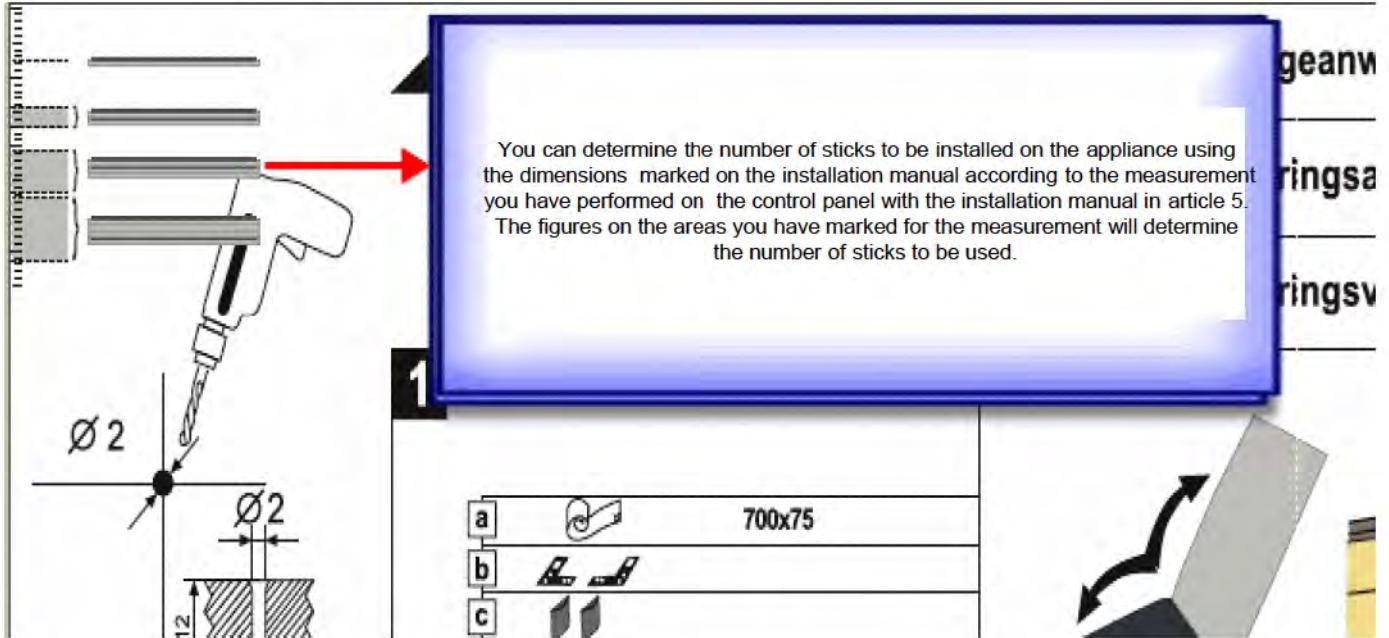

10 – Install the number of sticks specified in the installation manual to the control panel.

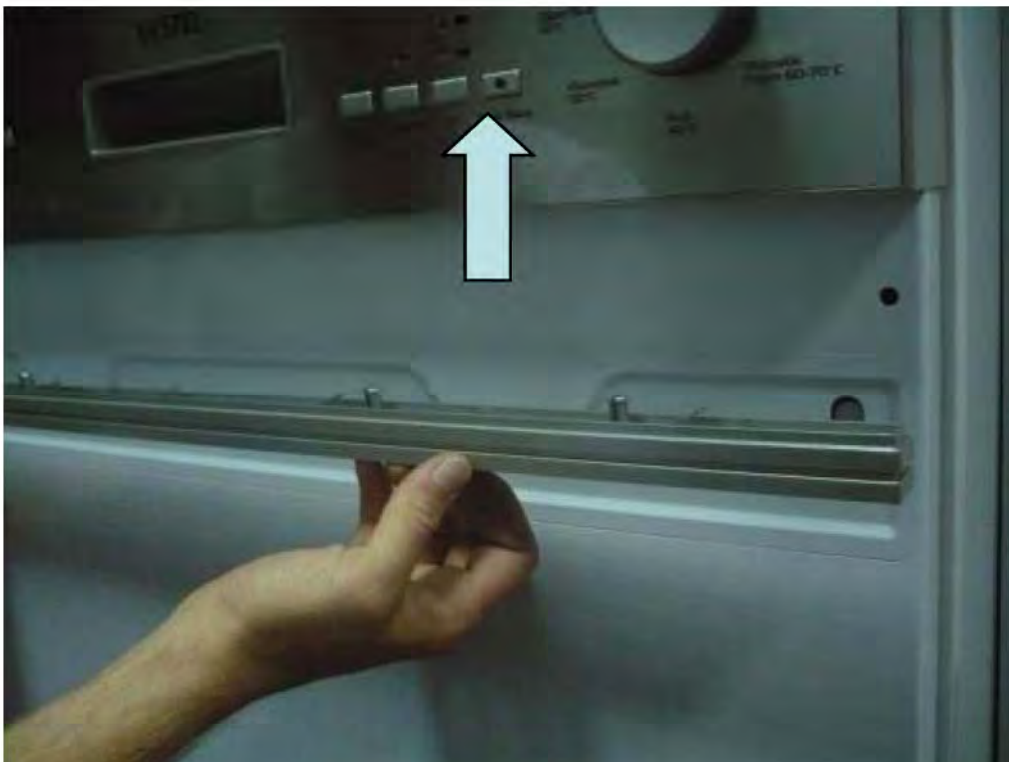

11 – Place the wood mounting screws so that they are aligned with their holes on the outer plate of the door. Ensure that the furniture is aligned and level with the sticks; then secure the lower part of the furniture by leaning it against the outer plate of the door.



- Proceed as shown in the pictures.

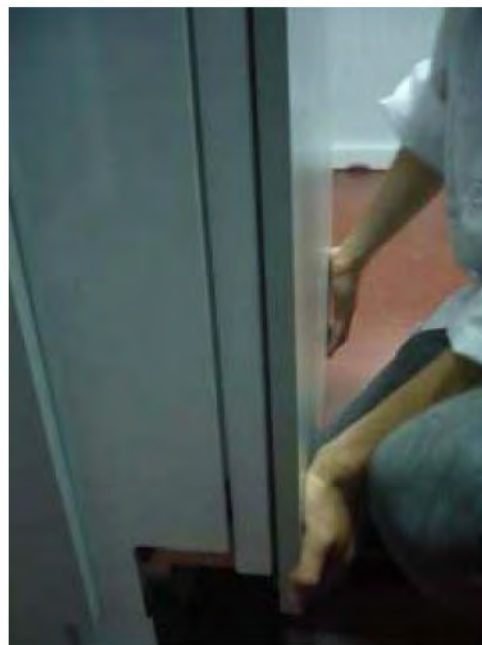
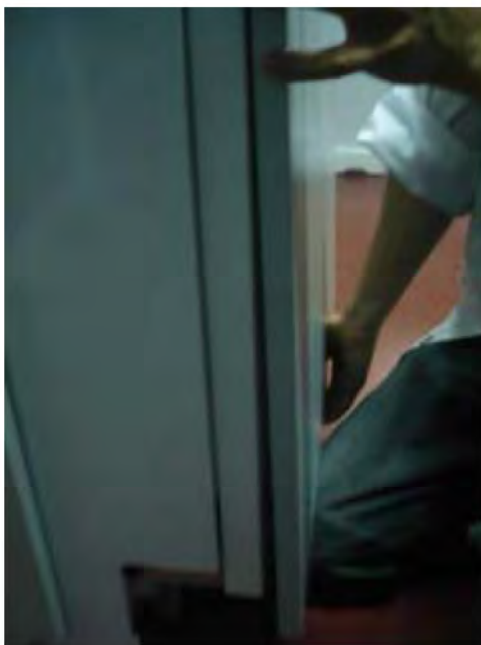

12 – Open the door of the appliance carefully (be careful to prevent it from falling)

Remove the screws on the appliance itself and place the Screws 4x42.5 YHB wallboard screws and secure the furniture to the appliance.

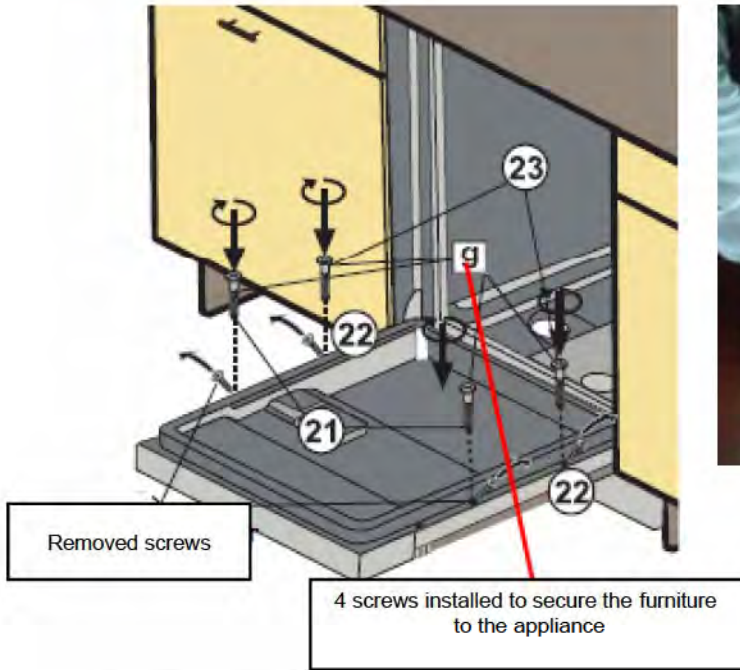

13 – Remove the rearmost screws 1 first, and place the wallboard screws instead of them, then proceed to the other screws 2.

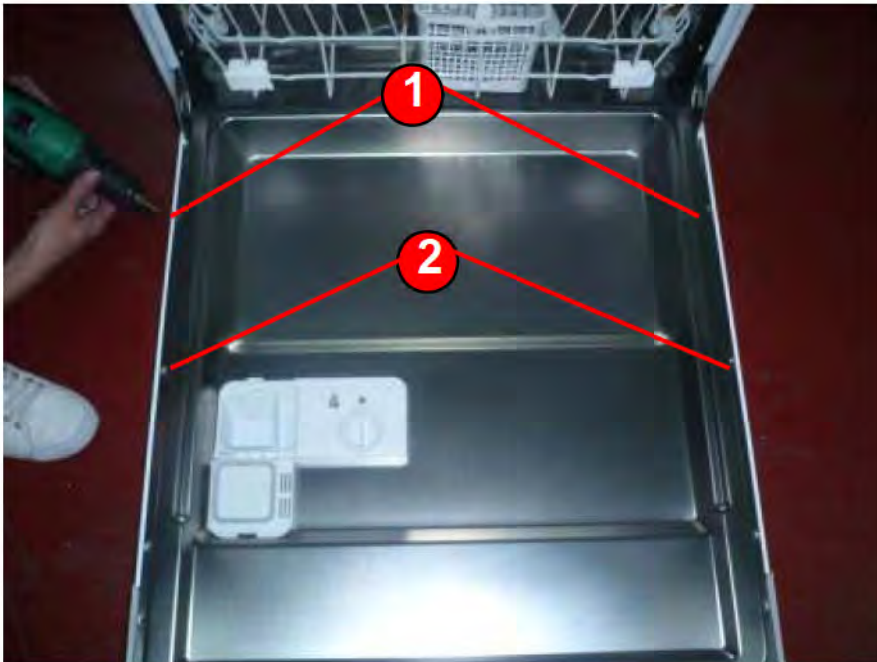

14 – After installing the furniture, adjust the door of your appliance according to the weight of the installed furniture.

Adjust the door of your appliance as shown in the figure using a flat head screwdriver.

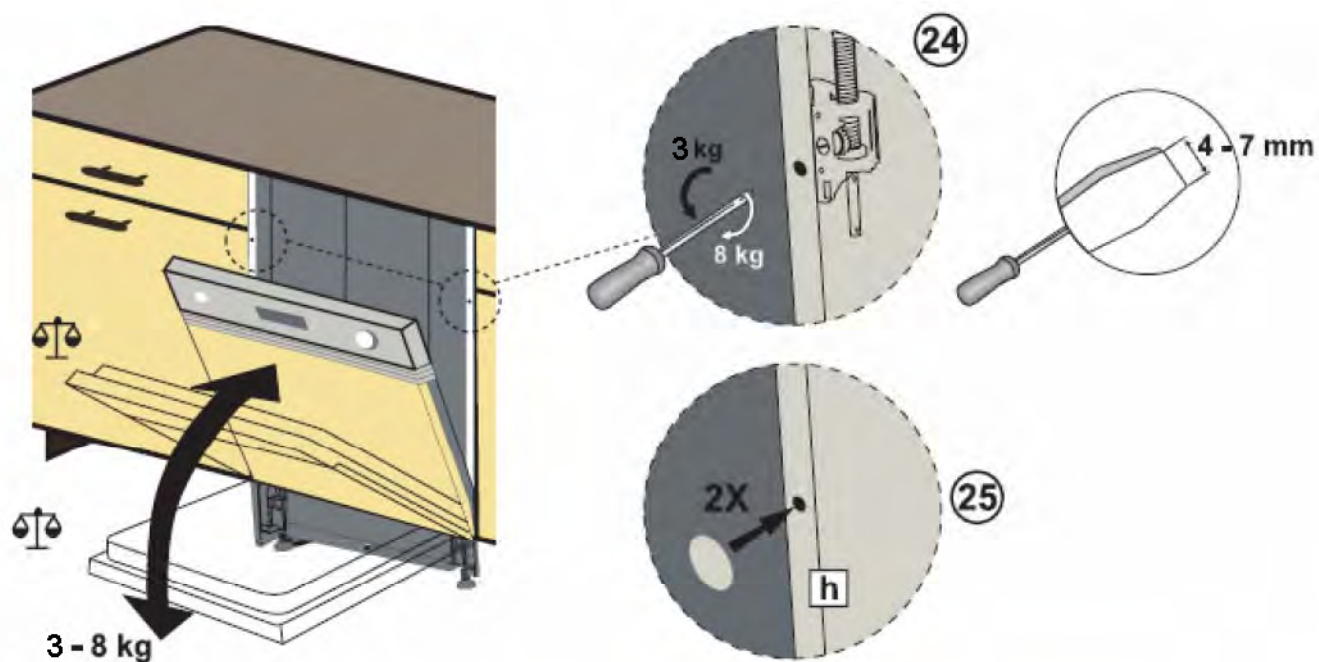

15 – After adjusting the door hinge springs according to the furniture you installed the appliance, plug the adjustment holes on the side panels by sticking the caps supplied with your appliance.



16 – Install your appliance to the upper panel of the counter as shown in figure 1 if the counter you install your appliance is made of wood, and to the side walls as shown in figure 2 if the counter you install your appliance is made of marble etc.

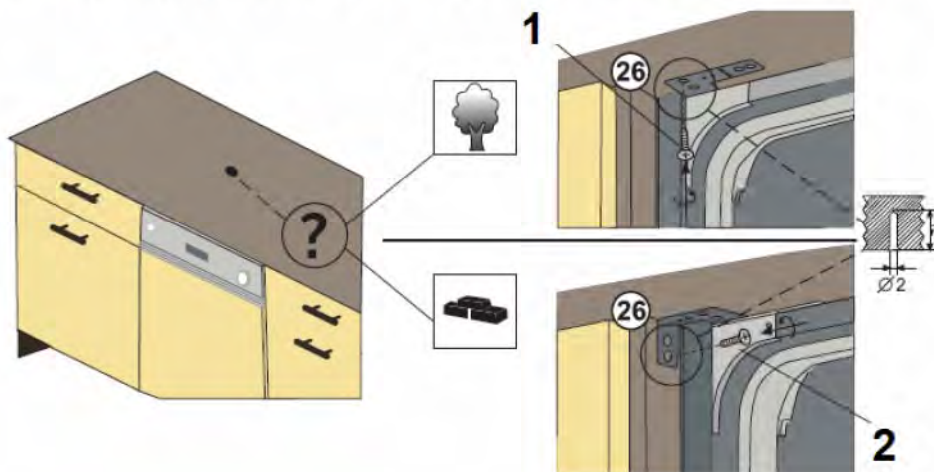

17– Finally, you should adjust the base according to the counter you have installed your appliance. Place the base cut according to the height of the other cupboards, and check whether the door can be opened or not. If the door of your appliance contacts the base, cut the contacting area of the base to ensure that the door can be opened or closed easily.

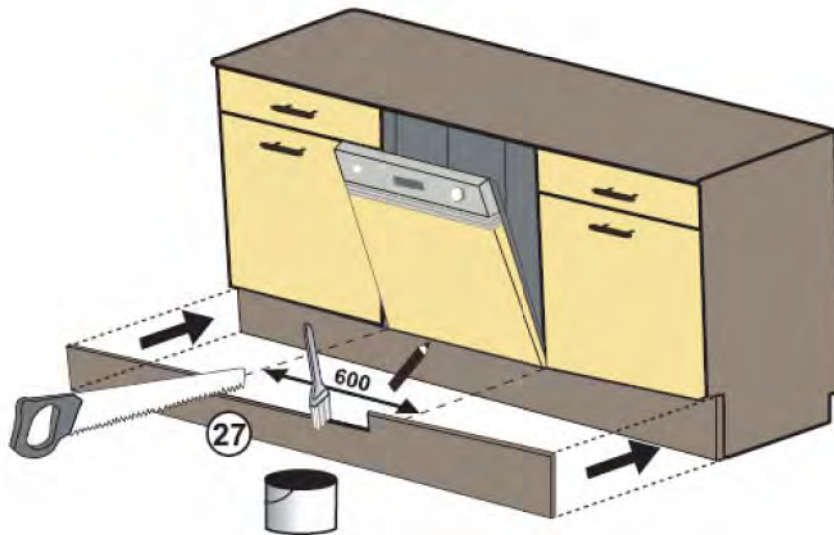

INSTALLATION OF FULL BUILT-IN DISHWASHERS UNDER THE COUNTER

INSTALLATION OF FULL BUILT-IN DISHWASHERS UNDER THE COUNTER

Use the following items supplied in the document bag of the appliance for the installation of the semi and full built-in dishwashers.

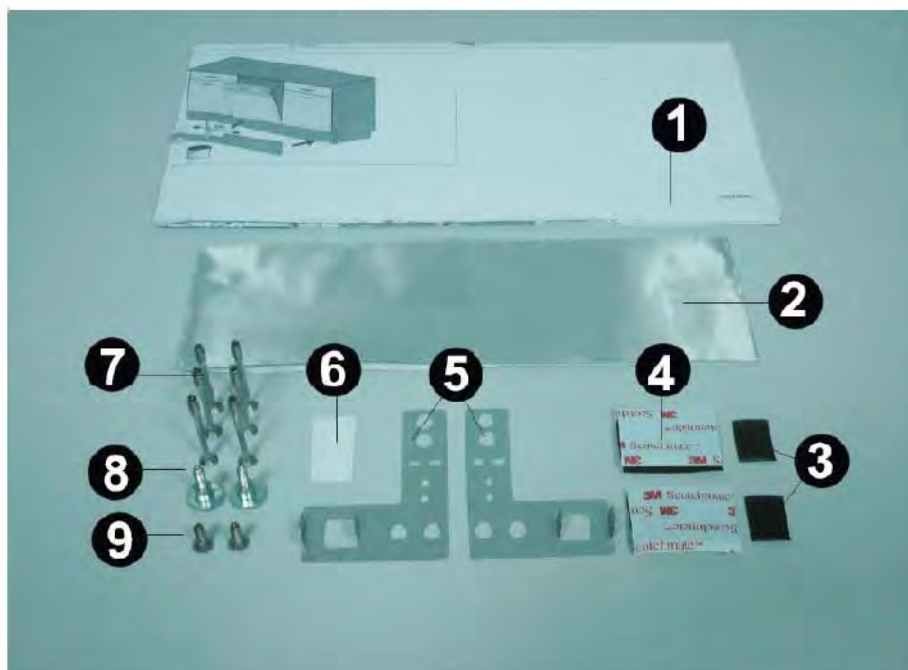

- 1 – Installation plan : manual describing the installation of the appliance under the counter.
- 2 – Vapour-proof foil
- 3 – Side retaining sticker (2 pcs)
- 4 – Board retaining sticker (2 pcs)
- 5 – Counter mounting plate, right and left
- 6 – Spring adjustment mechanism hole cover (2 pcs)
- 7 – Screw 4x42.5 YHB wallboard (4 pcs for semi built-in, 6 pcs for full built-in products)
- 8 – Board mounting screw (2 pcs)
- 9 – Screw 4x15 YHB wallboard (2 pcs)

Materials to be used in the installation process are



- 1- Tape measure
- 2 – Drill bit (Ø 2)
- 3 – Flat head and Phillips screwdriver
- 4 – Water gauge
- 5 – Charged drill

Intall your semi built-in appliance under the counter according to semi built-in installation instructions supplied with your appliance. Installation manual includes the dimensions of the counter and board to be installed in fornt of the appliance. Consider these dimensions before starting the installation.

1- If the counter that you will install the appliance is made of wood, stick the aluminum foil supplied in the document bag under the counter. (This prevents the vapour occurred by the opening and closing of your appliance's door from affecting the counter)



Open the aluminum foil carefully as shown in the picture.



Stick the aluminum foil under the counter that you place the appliance so that there is no clearance with the end of the counter as shown in the figure.



Before placing the appliance under the counter:



1 – Collect the discharge and water supply hoses and supply cord at the rear of your appliance (as shown in the figure) to prevent damage to them during installation under the counter.



2 – Install the counter mounting plates to the upper panel support bracket rubbers.

* At this stage, the counter mounting plates are installed in two ways according to the material (wood, granite, marble etc.) of the under counter that the appliance will be installed.



a) If the counter is made of wood, install the counter mounting plates so that the ends of the plates are faced inwards as shown in the figure.

* If the counter is made of wood, install the appliance to the upper side of the counter.

b) If the counter is made of a material like marble, granite, etc., install the counter mounting plates so that the ends of the plates are faced outwards as shown in the figure.



Crimp the from the point shown with an arrow in the figure after installing the counter mounting plate.

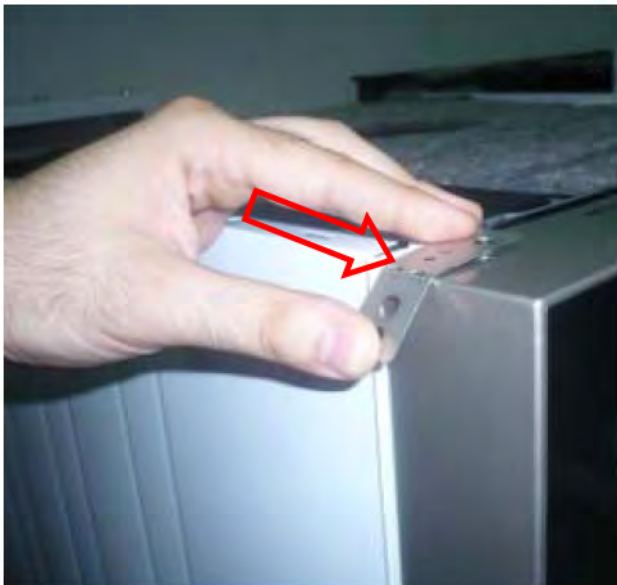

3 – Stick the side retaining stickers to the left and right panels of the appliance. The dimensions of the stickers are given in the installation manual.

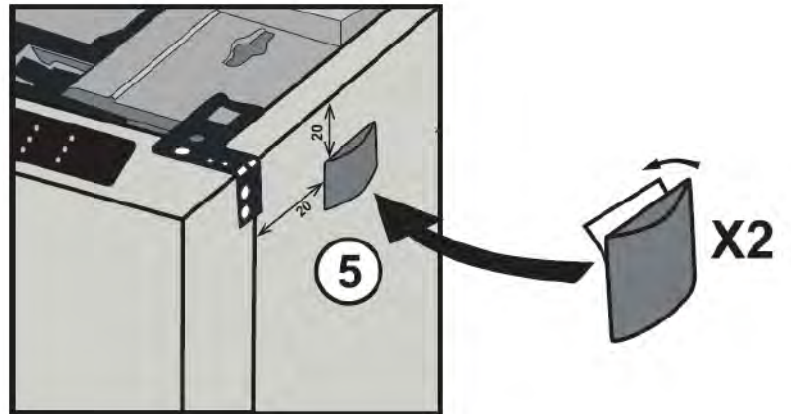

4– Place the appliance under the counter properly. Adjust the legs of the appliance so that the appliance is level with the upper panel of the counter, use a water gauge to check that the appliance is raised equally in all directions.

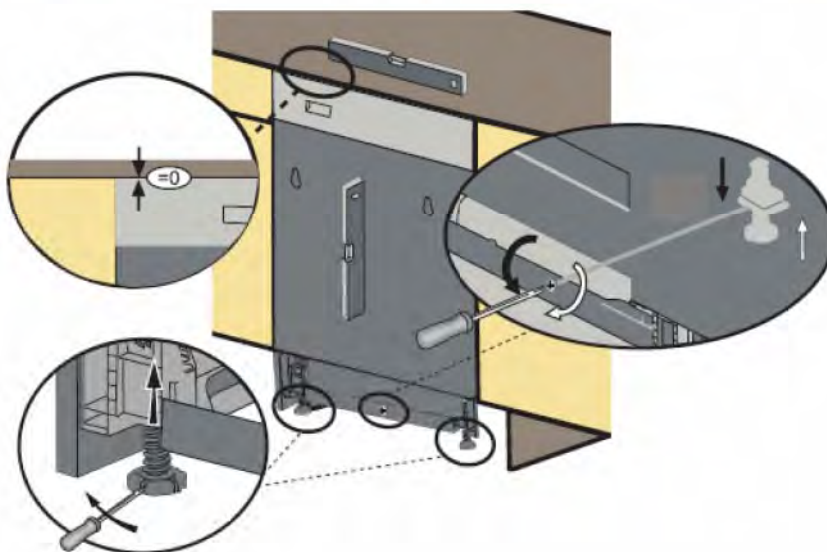

Use a flat head screwdriver to adjust the rear leg of your appliance. You can adjust the height of the appliance by turning the screwdriver right or left.

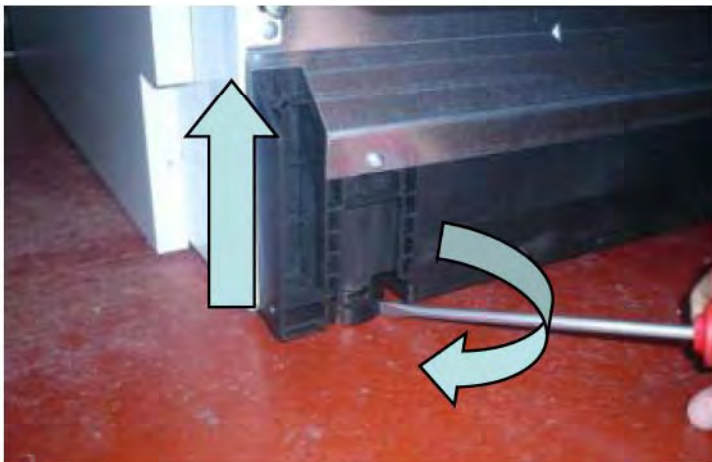
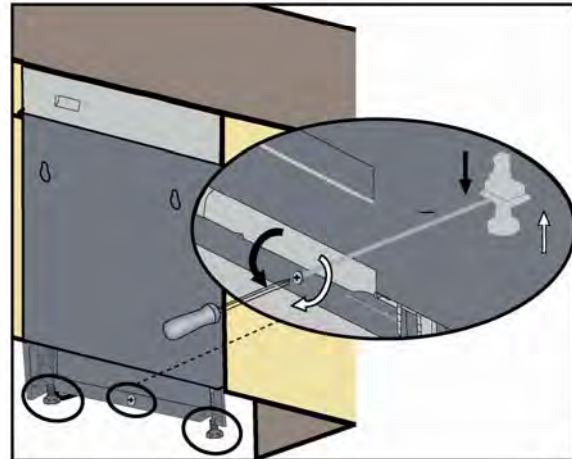

You can raise your appliance by turning the front legs of your appliance right or left as shown in the figure.

5 – Place the installation manual on the furniture properly.



6 – Drill screw holes on the furniture from the points shown on the installation manual. .
(use drill bits $\varnothing 2$)

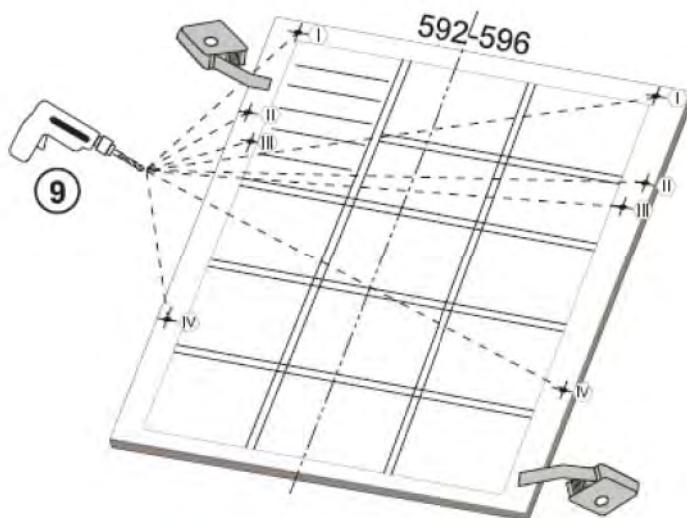

7 – Place the wood mounting screws to the screw holes you have drilled before, then stick the stickers with the specified dimensions.

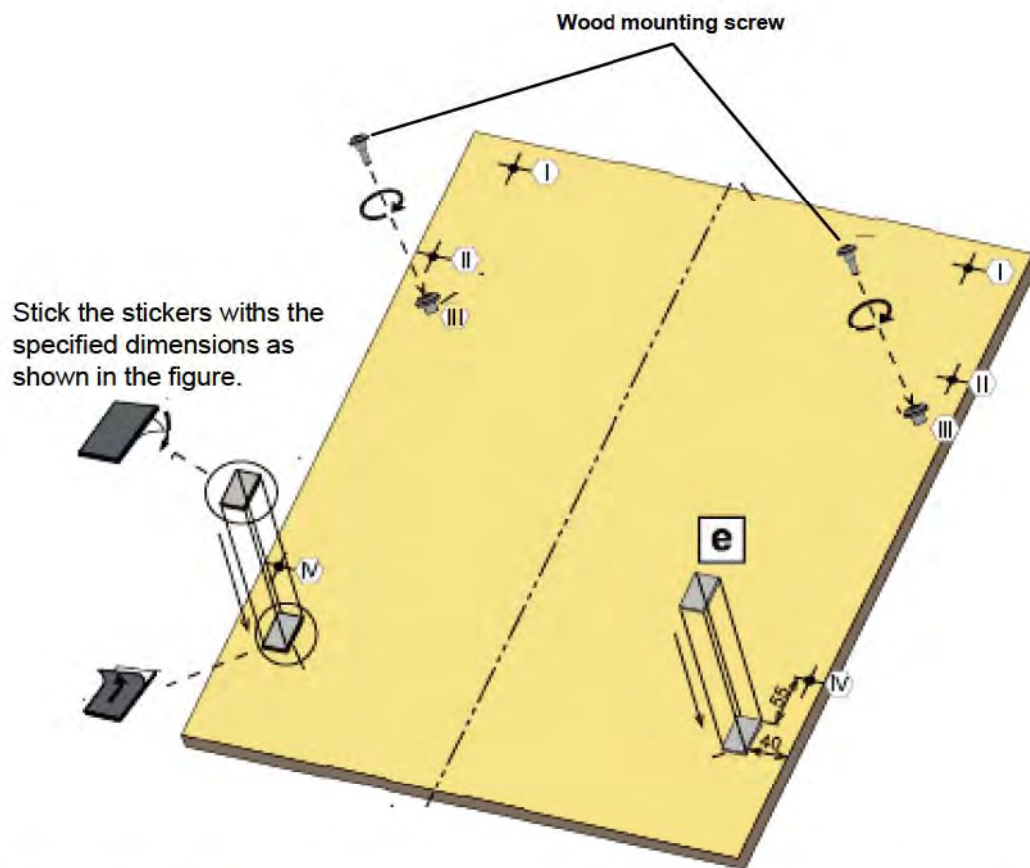

8 – When you are installing the door handles on the furniture, take the required measurements to ensure that the door handle is matched with the other drawers and covers on the counter, and drill your furniture according to these measurements.

When you are securing the door handle to your furniture:

Make sure that the mounting screw head of the door handle is embedded to the furniture (figure 1). (An installation as shown in figure 2 will cause problems when you are installing the furniture to the outer door plate of your appliance.)

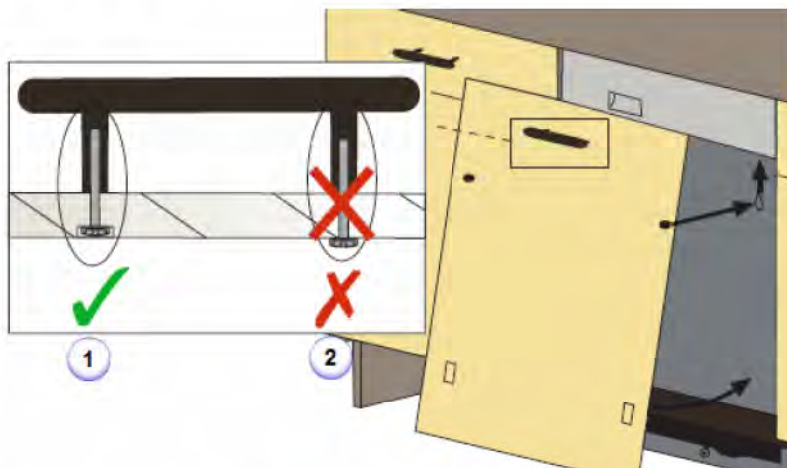

Adjust your furniture according to the door handle you have selected.



9 – Place the wood mounting screws so that they are aligned with their holes on the outer plate of the door. Ensure that the furniture is aligned and level with the sticks; then secure the lower part of the furniture by leaning it against the outer plate of the door.



- Proceed as shown in the pictures.

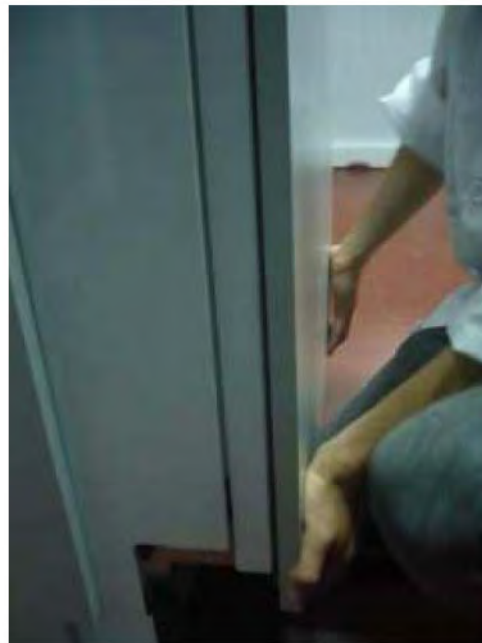

10 – Open the door of the appliance carefully (be careful to prevent it from falling)

Remove the screws on the appliance itself (the screws shown in figure 1) and place the Screws 4x42.5 YHB wallboard screws (the ones shown in figure 2) and secure the furniture to the appliance.

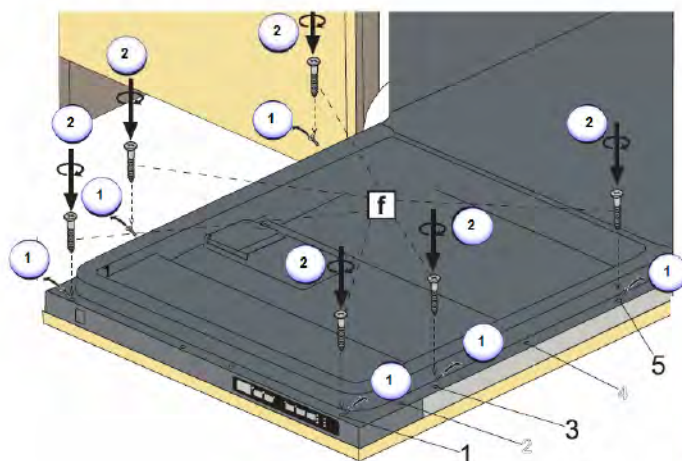

13 – Remove the rearmost screws 1 first, and place the wallboard screws instead of them, then proceed to the other screws 2 and 3 respectively.

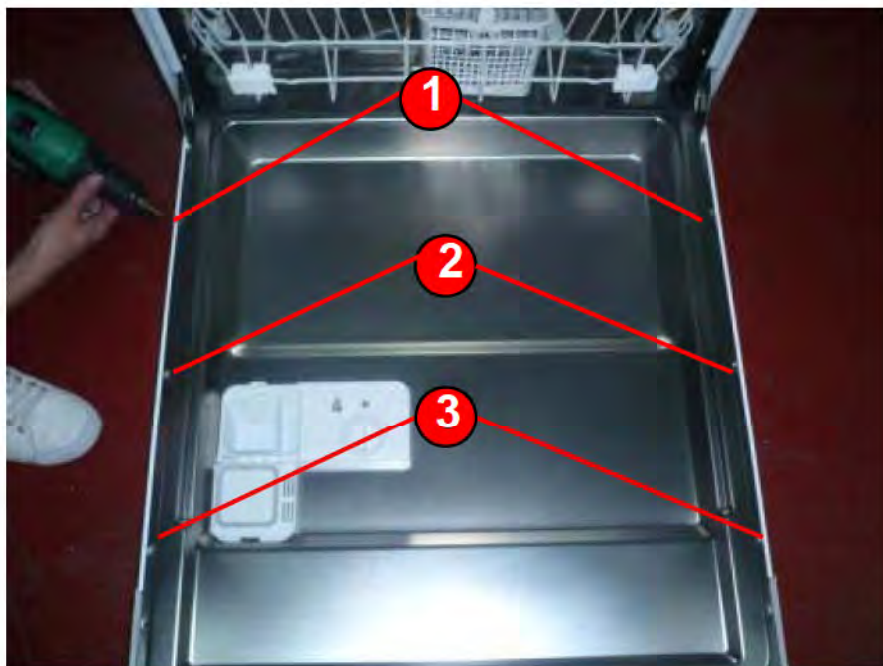

11 – After installing the furniture, adjust the door of your appliance according to the weight of the installed furniture.

Adjust the door of your appliance as shown in the figure using a flat head screwdriver.

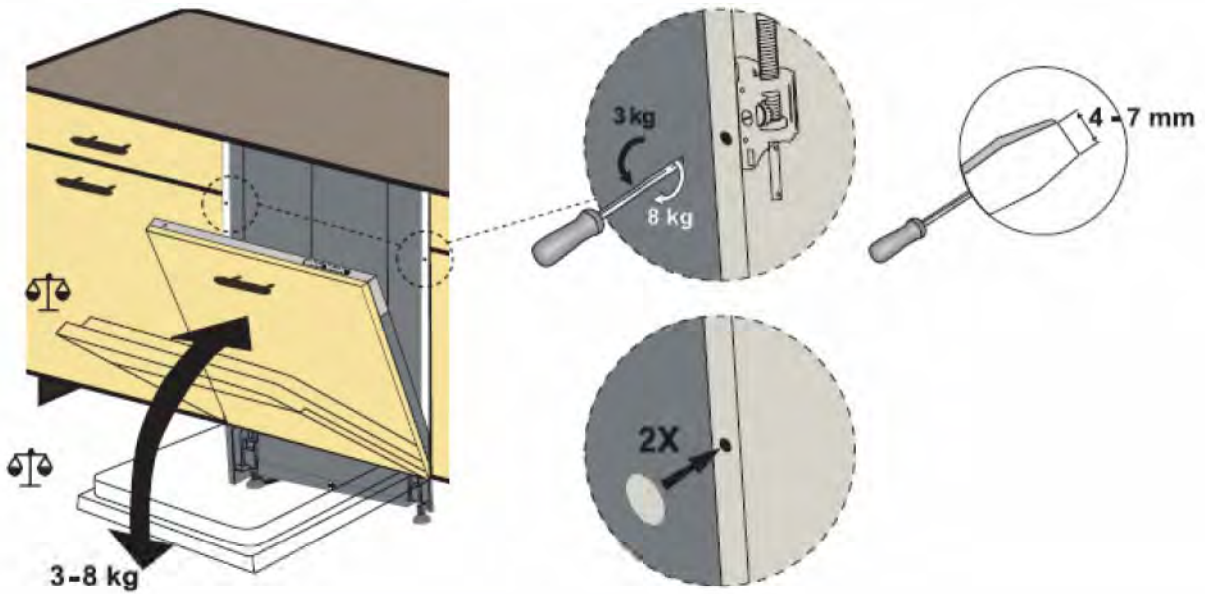

12 – After adjusting the door hinge springs according to the furniture you installed the appliance, plug the adjustment holes on the side panels by sticking the caps supplied with your appliance.



13 – Install your appliance to the upper panel of the counter as shown in figure 1 if the counter you install your appliance is made of wood, and to the side walls as shown in figure 2 if the counter you install your appliance is made of marble etc.

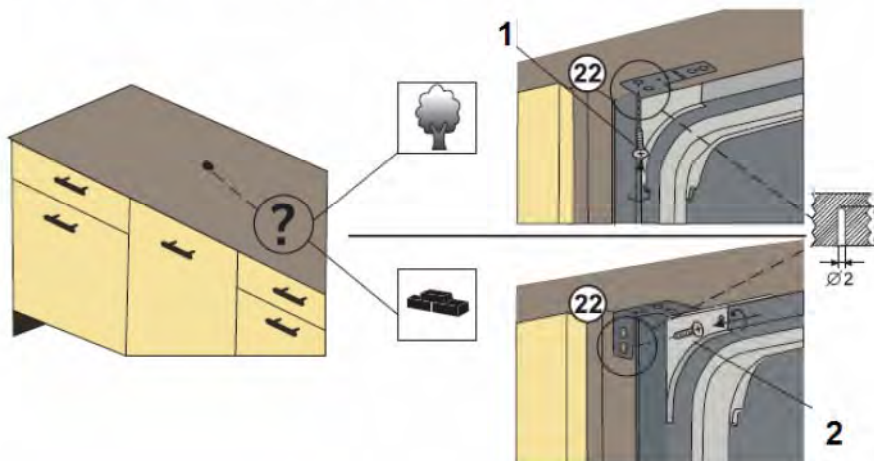

14– Finally, you should adjust the base according to the counter you have installed your appliance. Place the base cut according to the height of the other cupboards, and check whether the door can be opened or not. If the door of your appliance contacts the base, cut the contacting area of the base to ensure that the door can be opened or closed easily.

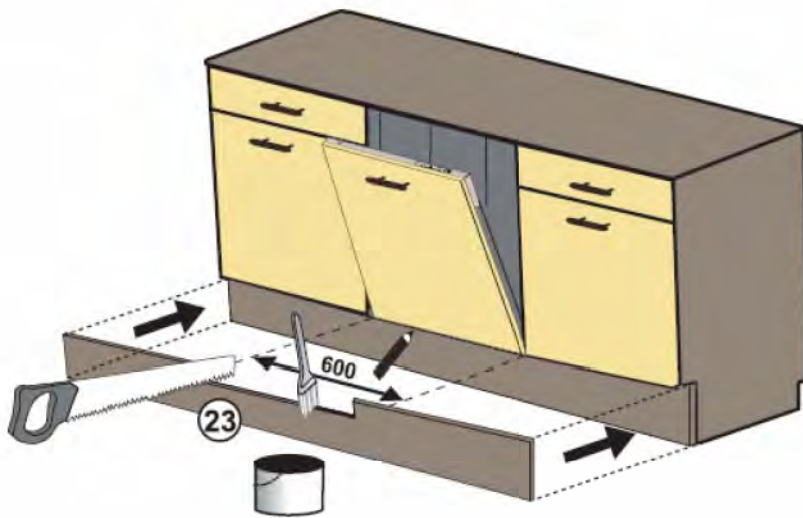

FAILURE CODES

ALARM IS ACTIVE FOR OVERFLOW

FOR C4 MODELS



FOR C3 MODELS

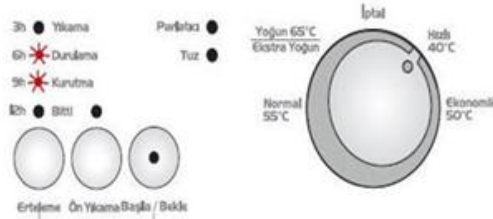

FOR C1 MODELS

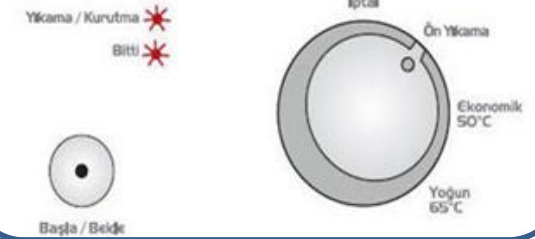

POSSIBLE PROBLEMS

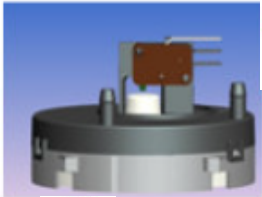

FLOATER

Floater switch can be out of order or have a problem with the cable connection.



TUB

There can be a water leakage from the tub.

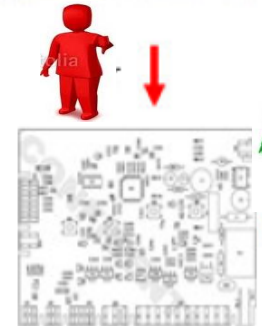

ELECTRONIC CARD

Electronic card can be out of order.

THE WASTE WATER IN THE MACHINE CANNOT BE DISCHARGED

FOR C4 MODELS



FOR C3 MODELS

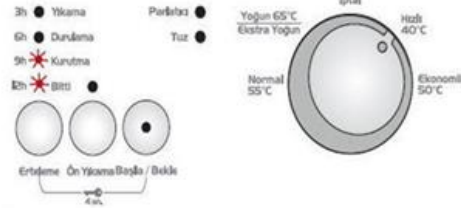

FOR C1 MODELS

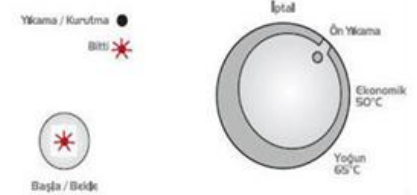

POSSIBLE PROBLEMS



DRAIN HOSE

- 1- Water outlet hose is clogged.
- 2-Check of the water outlet hose position



DRAIN PUMP

- 1-Check the drain pump resistance and power values
- 2-There can be a problem with cable connection of the drain

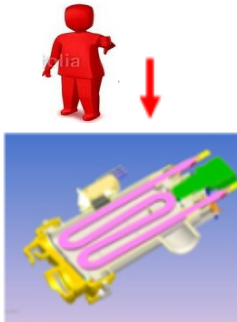

PRESSURE SWITCH

Pressure switch of the heater casing group can have a mechanical or cable connection problem.

ERROR OF CONTINUOUS WATER INPUT

FOR C4 MODELS



FOR C3 MODELS

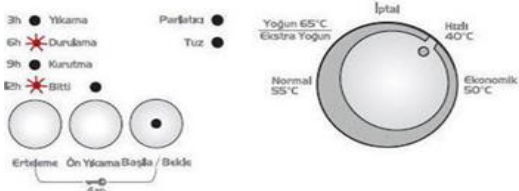

FOR C1 MODELS

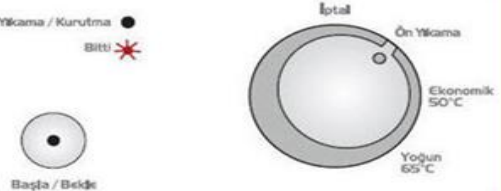

POSSIBLE PROBLEMS

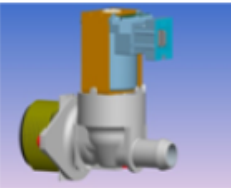



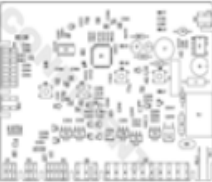

WATER INLET VALVE

Water inlet valve can be out of order or can not be closed.



ELECTRONIC CARD

Electronic card can be out of order.

FLOWMETER FAULTY

FOR C4 MODELS



FOR C3 MODELS

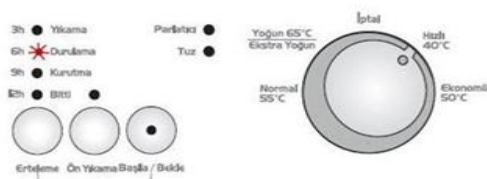

FOR C1 MODELS

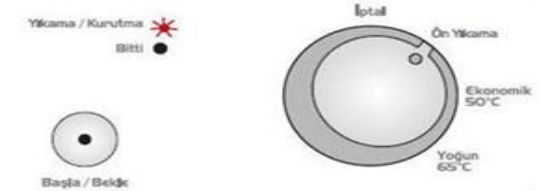

POSSIBLE PROBLEMS



FLOWMETER

- 1-Flowmeter can be out of order.
- 2- Cable connection of flowmeter can be faulty.



ELECTRONIC CARD

Electronic card can be out of order.





INADEQUATE WATER SUPPLY

POSSIBLE PROBLEMS



WATER TAP

Make sure the water input tap is totally open and that there is no water cut.

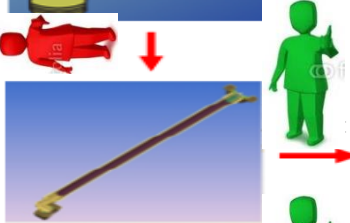

WATER INLET HOSE

Close the water input tap, separate the water input hose from the tap and clean the filter at the connection end of the hose.

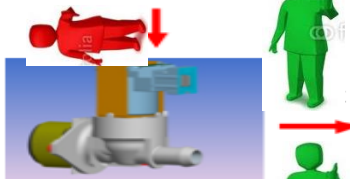

WATER INLET VALVE

- 1- Water inlet valve filter can be clogged.
- 2- Water inlet valve can be out of order. There can be a problem with the cable connection of water inlet valve.

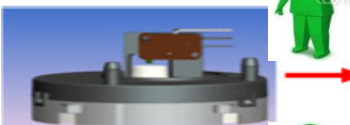

FLOATER

Floater switch can be out of order or have a problem with the cable connection.



PRESSURE SWITCH

Pressure switch of the heater casing group can have a mechanical or cable connection problem.



CIRCULATION PUMP

Circulation pump can be out of order or have a problem with the cable connection. External part can be blocked to the circulation pump

NTC FAULTY

FOR C4 MODELS



FOR C3 MODELS

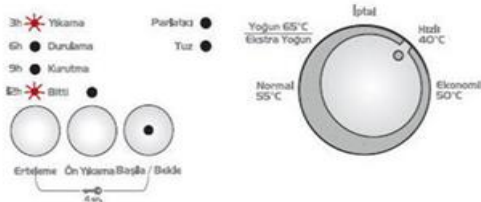

FOR C1 MODELS

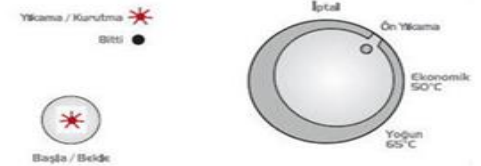

POSSIBLE PROBLEMS

NTC

- 1- NTC can be out of order.
- 2- NTC cable connection can be faulty. NTC can be short or open circuit.

ELECTRONIC CARD

- Check the power and resistance value of heater casing.
 Check the cable connection of the heater casing

EXTREME HEATING UP FAULTY

FOR C4 MODELS



FOR C3 MODELS

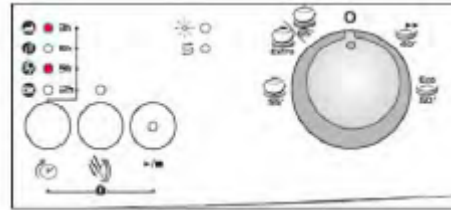

FOR C1 MODELS

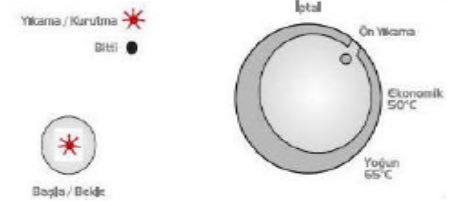

POSSIBLE PROBLEMS

NTC

If the water temperature inside machine higher than 77°C, NTC can be out of order.

ELECTRONIC CARD

Electronic card can be out of order.

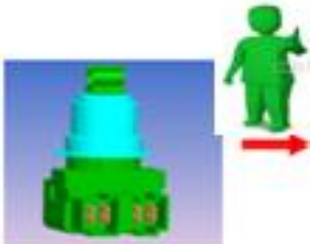

INADEQUATE HEAT

FOR C4 MODELS



FOR C3 MODELS

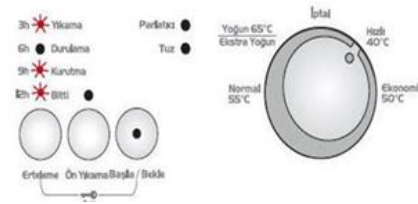

FOR C1 MODELS

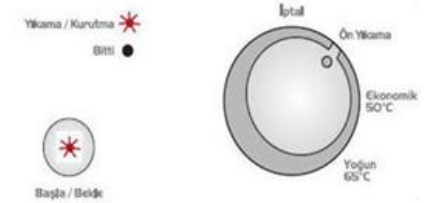

POSSIBLE PROBLEMS

HEATER



- 1- Check the power and resistance values
- 2- Check the cable connection of the heater.

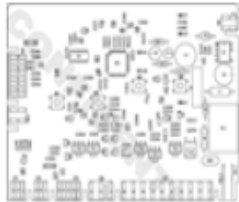

ELECTRONIC CARD

Check the electronic card

DIVERTER POSITION PROBLEM

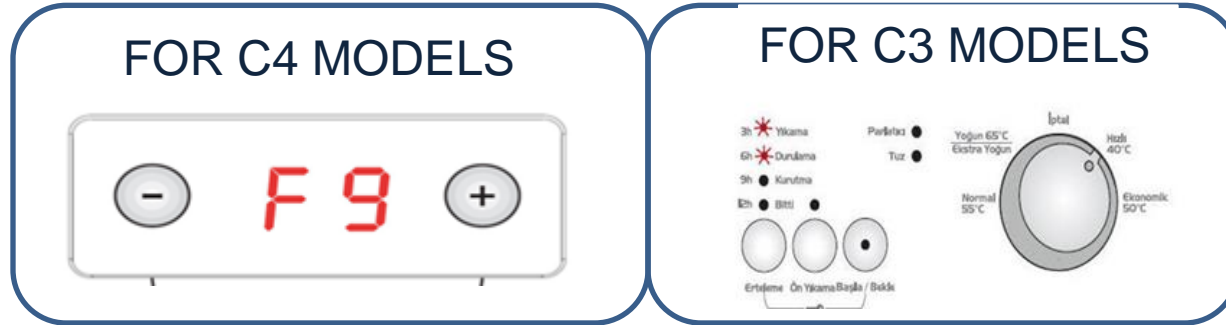

POSSIBLE PROBLEMS

DIVERTER

- 1-Check the values of the resistance of the diverter
- 2- Check the cable connection of the diverter

ELECTRONIC CARD

Check the electronic card



TURBIDITY SENSOR FAULTY

FOR C4 MODELS



POSSIBLE PROBLEMS

TURBIDITY SENSOR

- 
- 
- 
- 1- There can be some soil around the turbidity sensor.
 - 2- Check the cable connection of the turbidity sensor

ELECTRONIC CARD



Check the electronic card

MEASURING OF THE ELECTRICAL COMPONENTS

MEASURING OF THE COMPONENTS FROM THE ELECTRONIC CARD

1. CIRCULATION PUMP

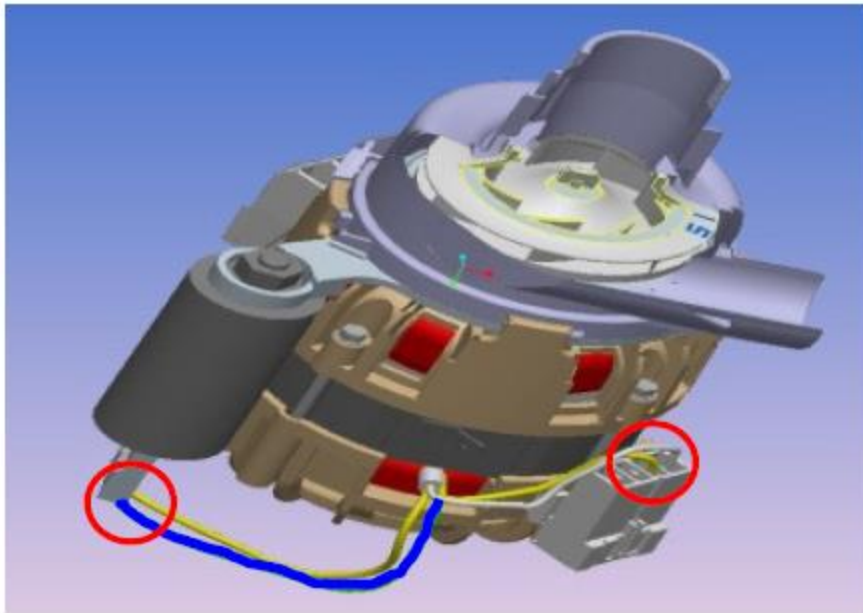

- Measurement of the secondary windings and primary windings of the washing pump

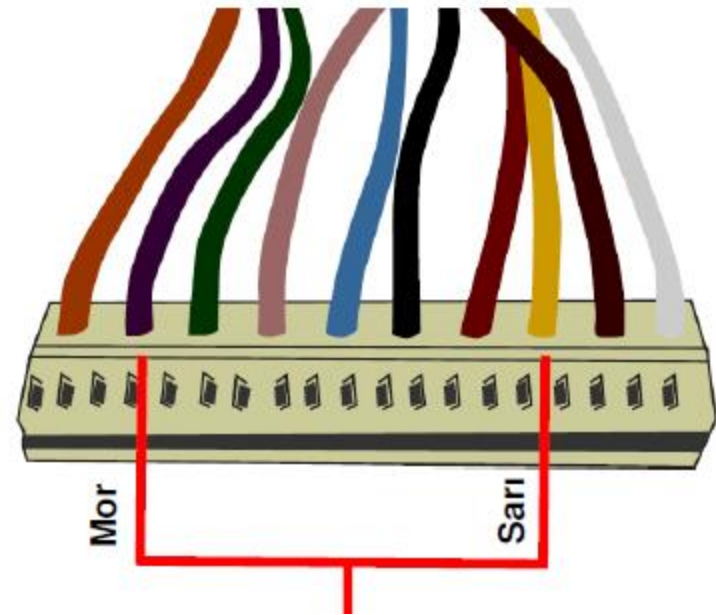

- Probes of the tester should be applied on to the related connectors. (purple and yellow cable)

MEASURING OF THE COMPONENTS FROM THE ELECTRONIC CARD

2. WATER INLET VALVE

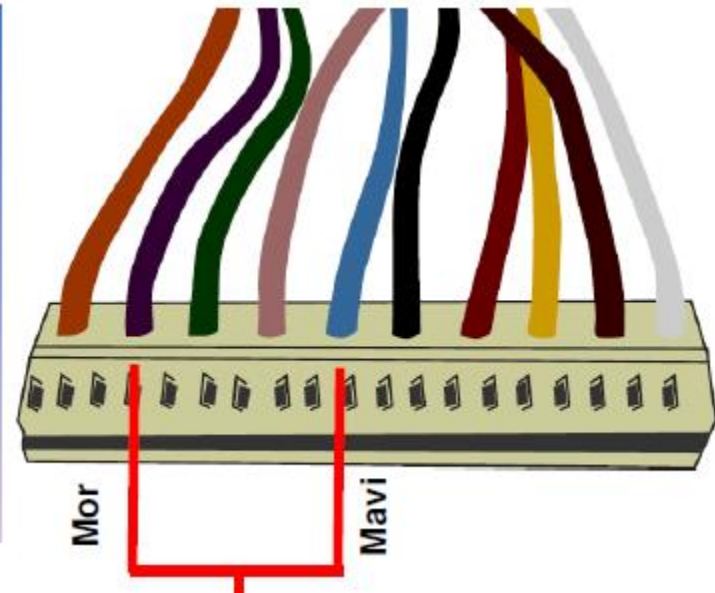
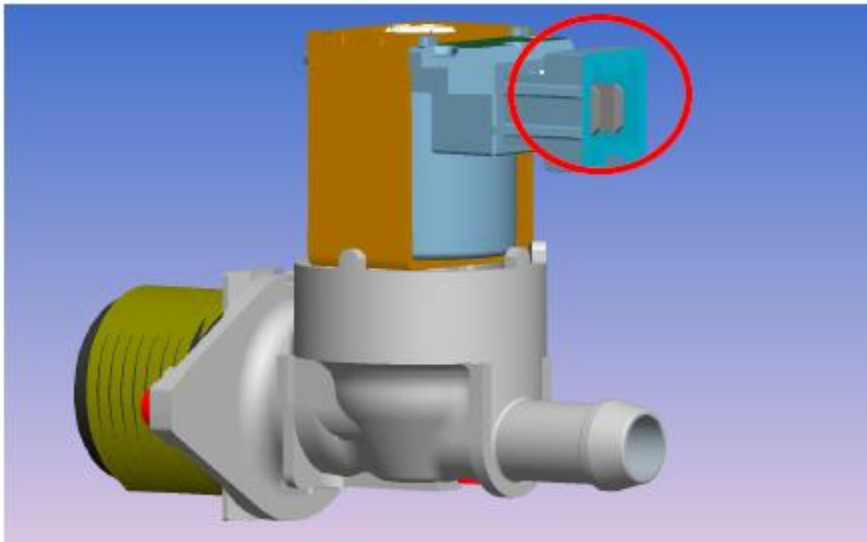

➤ Probes of the tester should be applied on to the related connectors. (purple and blue cable)

MEASURING OF THE COMPONENTS FROM THE ELECTRONIC CARD

3. TURBO FAN MOTOR

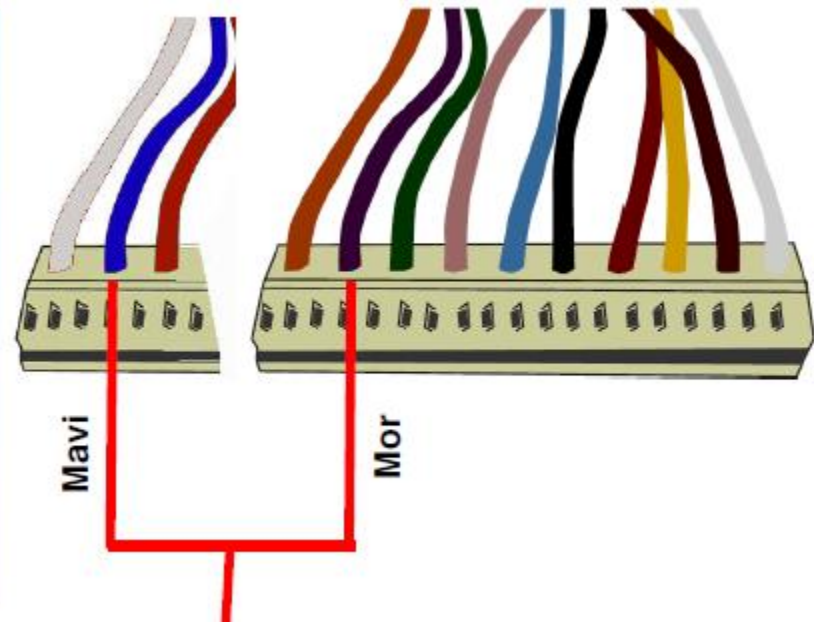
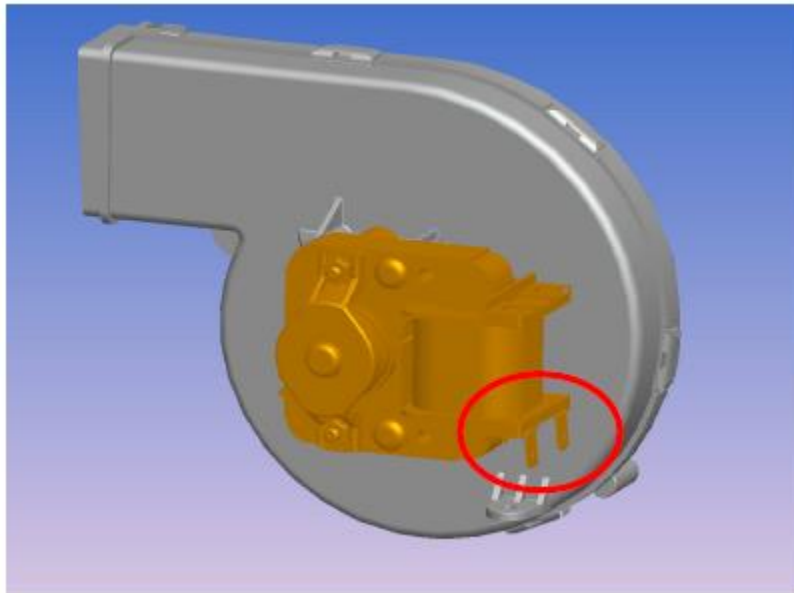

➤ Probes of the tester should be applied on to the related connectors. (blue and purple cable)

COMPONENTS COULD NOT BE MEASURED FROM THE ELECTRONIC CARD

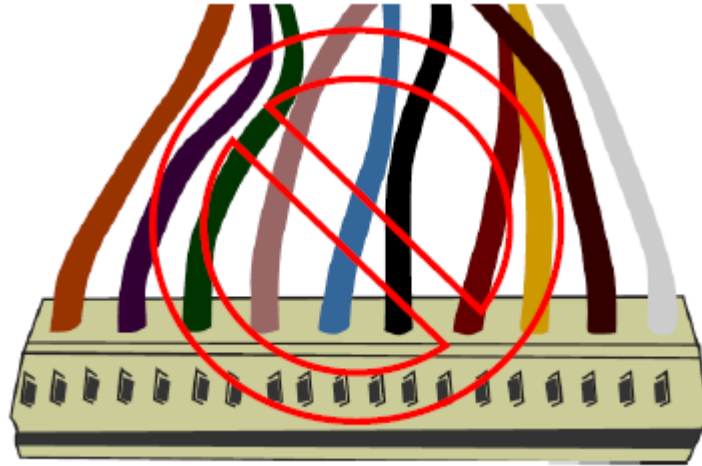

DETERGENT DISPENSER

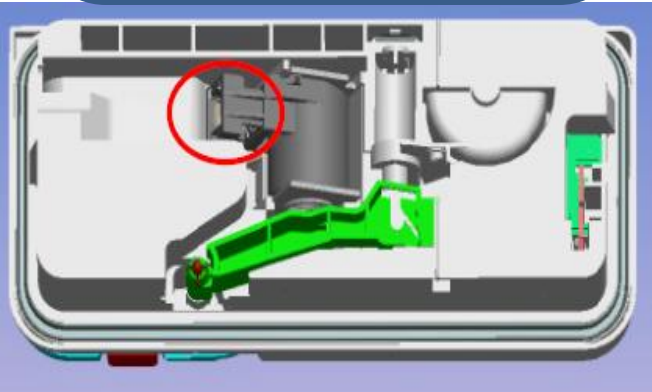

HEATER CASING

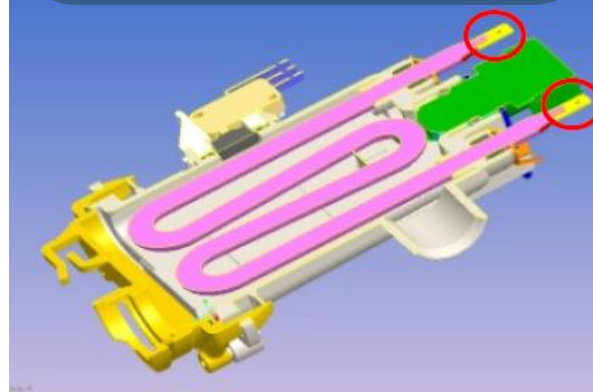

TURBIDITY SENSOR

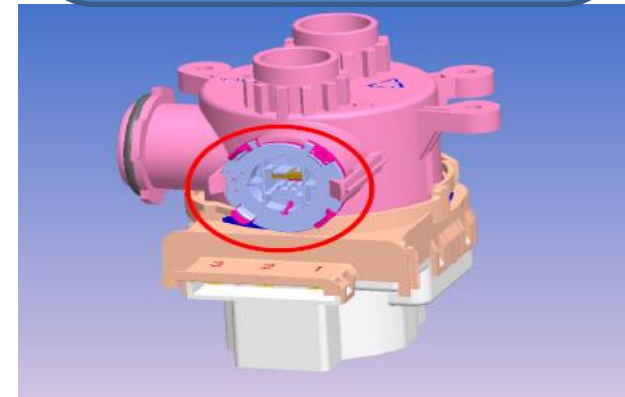



THANKS