

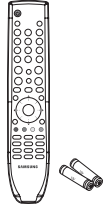

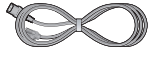

2-4. Accessories

Product	Description	Code. No	Remark
	Remote Control & Batteries (AAA x 2)	BN59-00683A	Samsung Electronics Service center
	Power Cord	3903-000145	
	Cover-Bottom	32" : P1 (BN63-04207A), P3 (BN63-04207B) 37" : P1 (BN63-04208A), P3 (BN63-04437A) 40" : P1 (BN63-04352B), P3 (BN63-04437A) 46" : P1 (BN63-04353B), P3 (BN63-04374A) 52" : P1 (BN63-04354B), P3 (BN63-04374A)	
	Owner's Instructions	BN68-01409A	
	Cleaning Cloth	BN63-01798A	
	Warranty Card / Registration Card / Safety Guide Manual (Not available in all locations)	BN68-00514E, AA68-03575A~G, AA68-03242K	

5. Exploded View & Part List

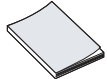
5-1. LE32A566P1MXZF Exploded View

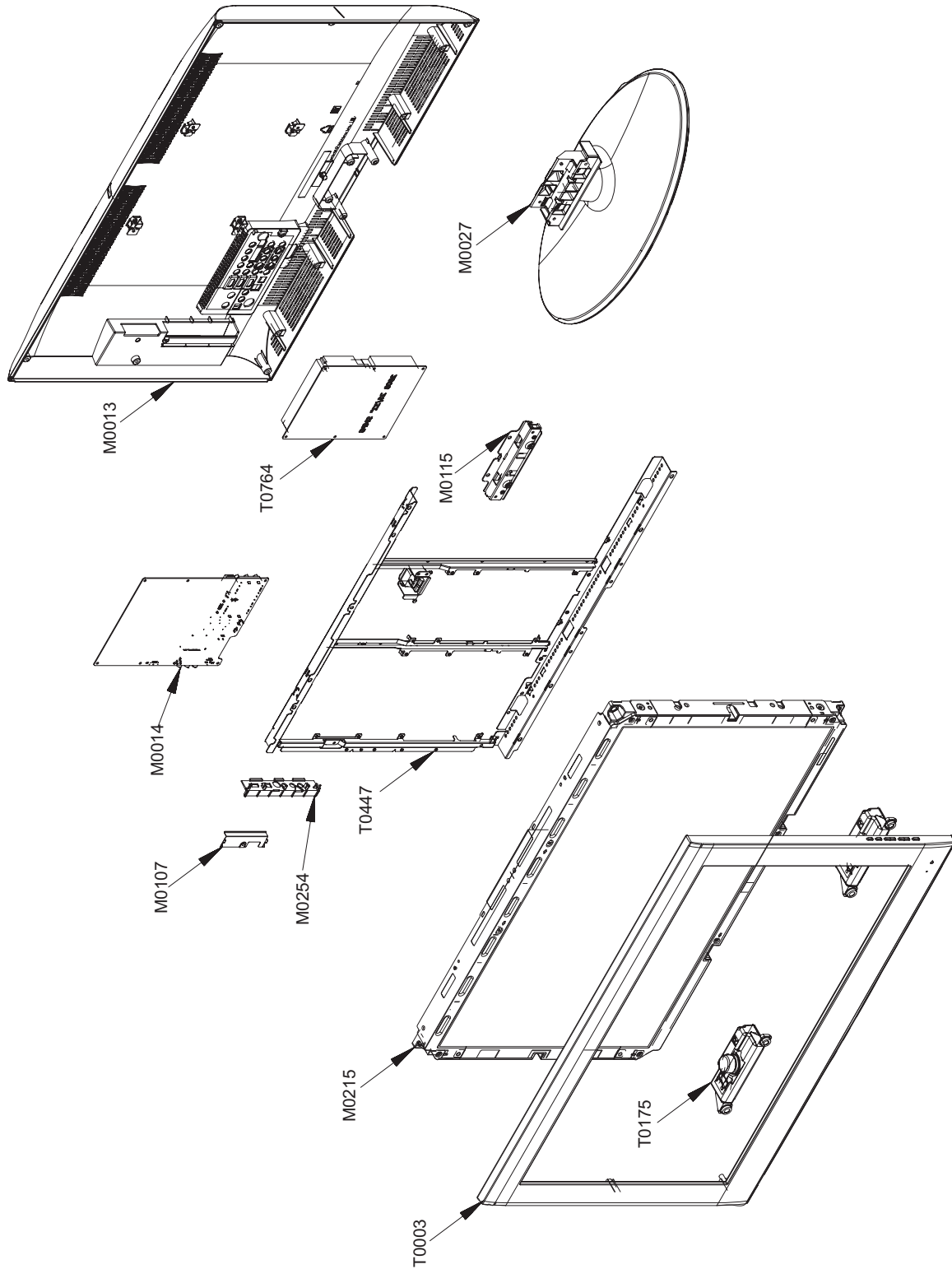

5-1-2. LE32A566P1MXZF Parts List

Location No.	Code No.	Description & Specification	Q'ty	S.A/S.N.A	Remark
T0003	BN96-06705H	ASSY COVER P-FRONT;PEARL 32",France,ABS+	1	S.A	
T0175	BN96-06819A	ASSY SPEAKER P;8ohm,PEARL,LCD,10W,100mm,	2	S.A	
M0215	BN07-00520A	LCD-PANEL;LTF320HA01	1	S.A	
T0447	BN96-04681G	ASSY BRACKET P-PANEL;-;32R81,-,-,-,-,CMO	1	S.N.A	
M0115	BN61-03706A	BRACKET-STAND LINK;BRACKET-STAND-LINK 32	1	S.A	
M0107	BN63-03039A	SHIELD-COVER;MURANO40,PCM,T0.5,IDTV	1	S.N.A	
M0254	BN61-02875E	HOLDER-SIDE AV;40F8,EO,HIPS V0,-,-,-,BK5	1	S.N.A	
M0014	BN94-01812A	ASSY PCB MAIN;LE32A566P1MXZF	1	S.A	
T0764	BN44-00208A	SMPS-LCDTV;MK32P5T,SEM,AC/DC,137W,AC100	1	S.A	
M0013	BN96-06719A	ASSY COVER P-REAR;L550 32Inch,EO,HIPS,HB	1	S.A	
M0027	BN96-06733A	ASSY STAND P-BASE;L550 32Inch,ABS+PMMA,H	1	S.A	