

## SECTION 5 EXPLODED VIEWS

**NOTE :**

- Non-serviceable items with no part number and no description are not stocked because they are not required for routine service.
- The construction parts of an assembled part are indicated with a collation number in the remarks column.
- Items marked “\*” are not stocked since they are seldom required for routine service. Some delay should be anticipated when ordering these items.

**Note :** Les composants identifiés par une trame et par une marque Δ sont d'une importance critique pour la securite. Ne les remplacer que par des pieces du numero specifie.

**Note :** The components identified by shading and marked Δ are critical for safety. Replace only with the part numbers specified in the parts list.

### 5-1. CHASSIS

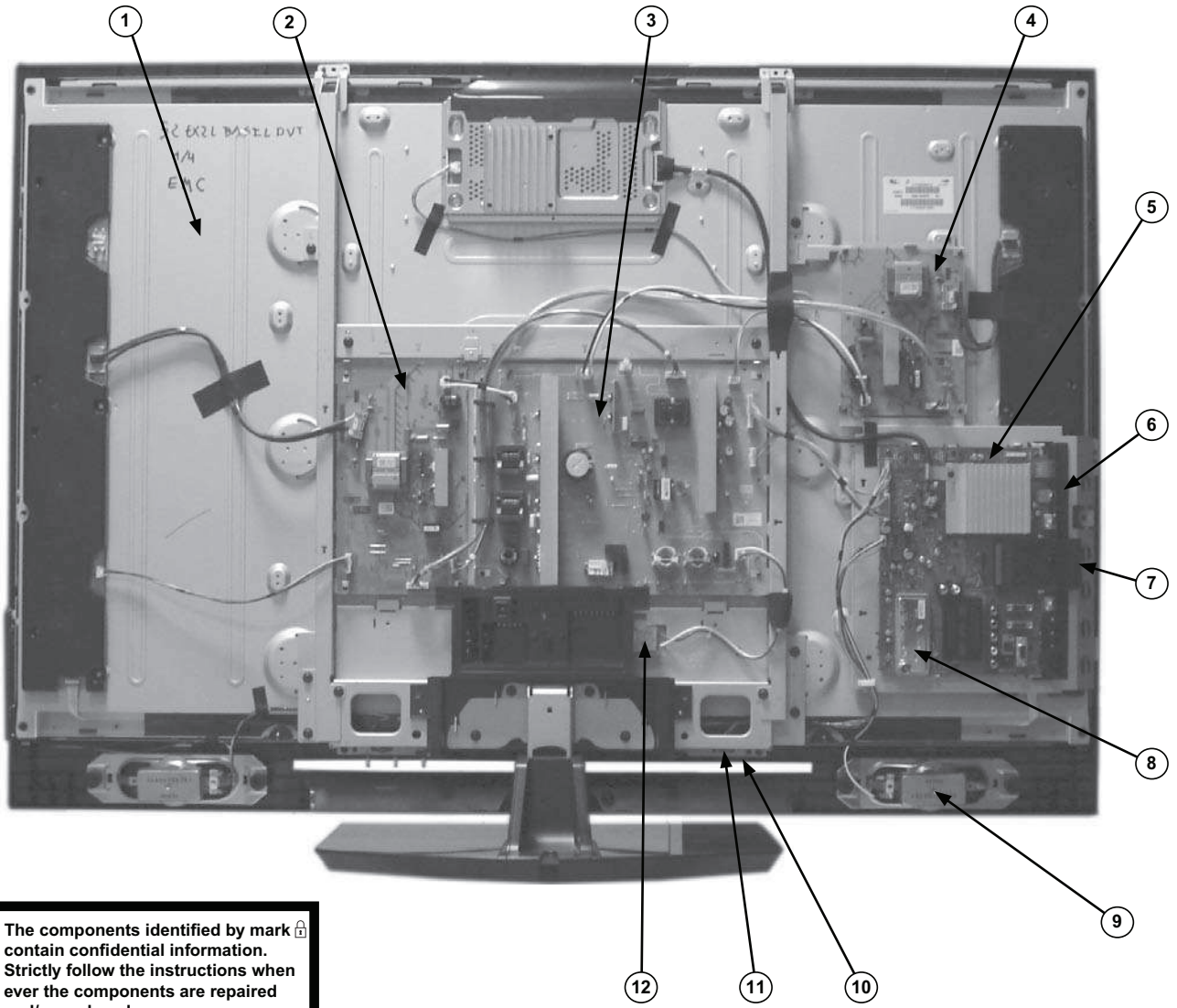

**Note :** The components identified by mark contain confidential information. Strictly follow the instructions when ever the components are repaired and/or replaced.

REF.NO.	PART.NO	DESCRIPTION	REMARK	REF.NO.	PART.NO	DESCRIPTION	REMARK
1	Δ 1-802-875-12	LCD PANEL (52 INCH FHD TFT)		7	*4-136-306-01	DUMMY CARD PCMCIA	
2	A-1663-196-A	D5N BOARD, COMPLETE		8	8-597-700-01	TUNER UNIT, DIGITAL BTD-HF422T	
3	1-487-340-11	POWER UNIT (G5N)		9	1-858-183-11	LOUDSPEAKER	
4	A-1663-200-A	D6N BOARD, COMPLETE		10	4-123-491-01	GUIDE, IR (B)	
5	A-1707-009-A	BA BOARD, COMPLETE		11	A-1704-202-A	HSN BOARD, COMPLETE	
6	4-132-225-02	BRACKET, SIDE JACK		12	Δ 1-822-622-11	AC INLET FILTER	

## 5-1. CHASSIS Cont.

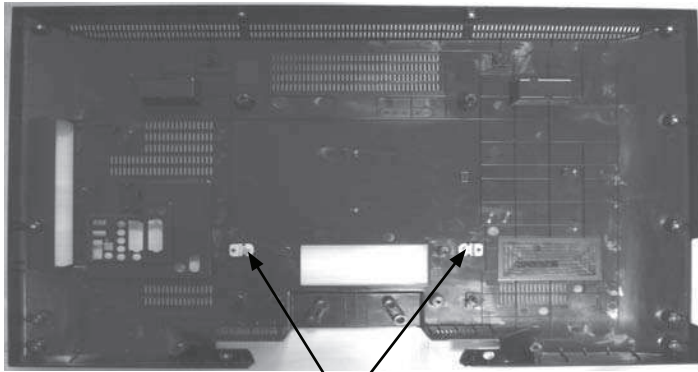

**Note :** Les composants indentifiés par une trame et par une marque  $\Delta$  sont d'une importance critique pour la sécurité. Ne les remplacer que par des pièces du numéro spécifié.

**Note :** The components identified by shading and marked  $\Delta$  are critical for safety. Replace only with the part numbers specified in the parts list.

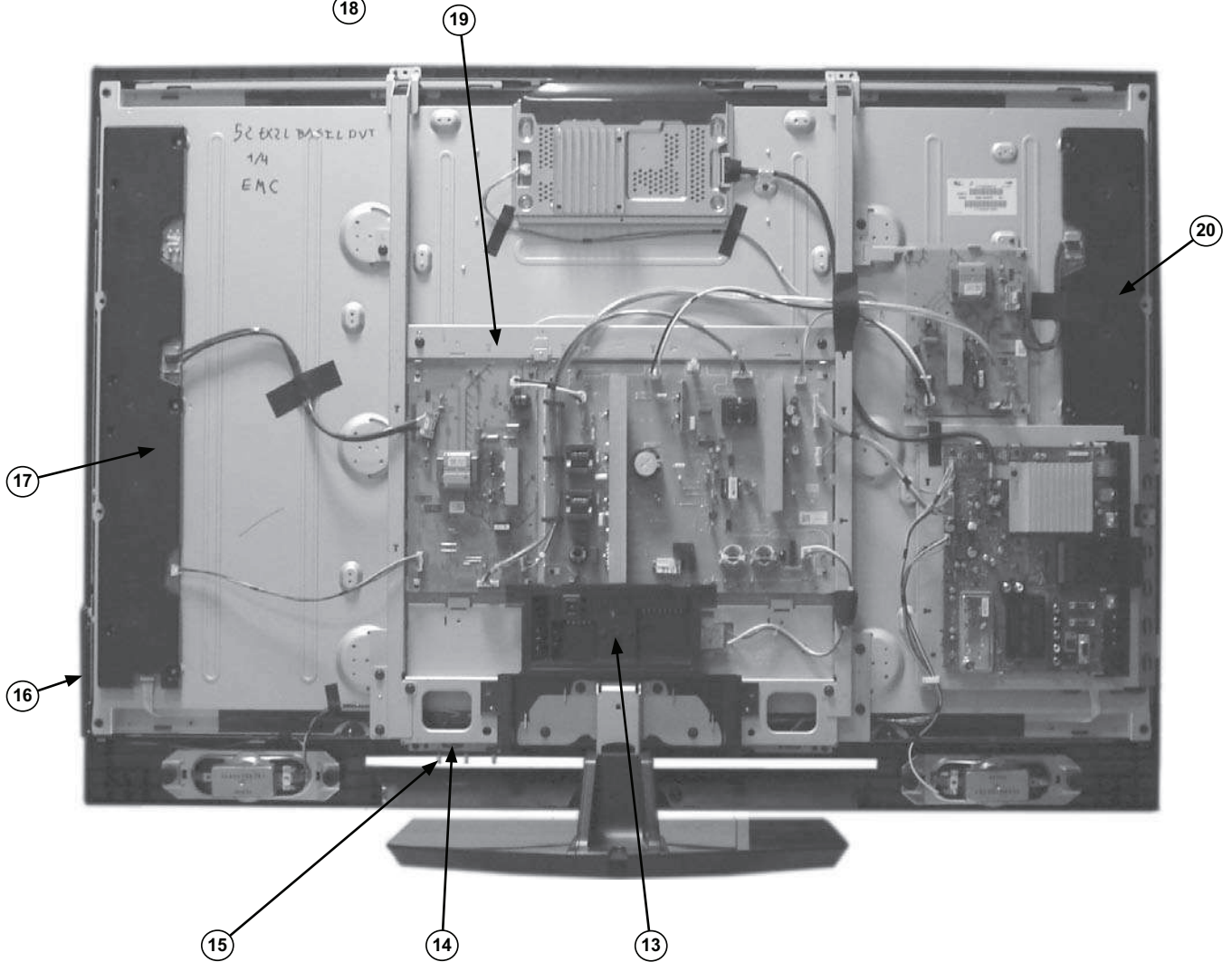

REF.NO.	PART.NO	DESCRIPTION	REMARK	REF.NO.	PART.NO	DESCRIPTION	REMARK
13	4-123-483-01	COVER, UNDER (L)		17	1-857-372-11	ETC-INVERTER MT BOARD (LEFT)	
14	A-1671-629-A	HL4A BOARD, COMPLETE		18	4-122-585-01	FRAME, VESA (M6)	
15	4-123-489-01	GUIDE, LED (B-L)		19	4-129-446-01	FRAME, VESA TOP (52)	
16	1-487-233-11	SWITCH UNIT		20	1-857-373-11	ETC-INVERTER MT BOARD (RIGHT)	

## 5-2. BEZEL ASSY & STAND ASSY

**Note :** Les composants indentifiés par une trame et par une marque  $\Delta$  sont d'une importance critique pour la securite. Ne les remplacer que par des pieces du numero specifie.

**Note :** The components identified by shading and marked  $\Delta$  are critical for safety. Replace only with the part numbers specified in the parts list.



REF.NO.	PART.NO	DESCRIPTION	REMARK	REF.NO.	PART.NO	DESCRIPTION	REMARK
51	X-2349-467-1	BEZEL ASSY (52)		52	X-2320-604-1	STAND ASSY (LI2A)	

### 5-3. REAR COVER & POWER SUPPLY CORDS

**Note :** Les composants indentifiés par une trame et par une marque  $\Delta$  sont d'une importance critique pour la securite. Ne les remplacer que par des pieces du numero specifie.

**Note :** The components identified by shading and marked  $\Delta$  are critical for safety. Replace only with the part numbers specified in the parts list.

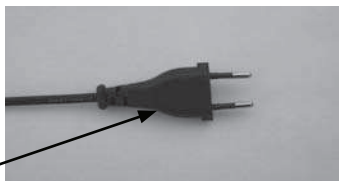
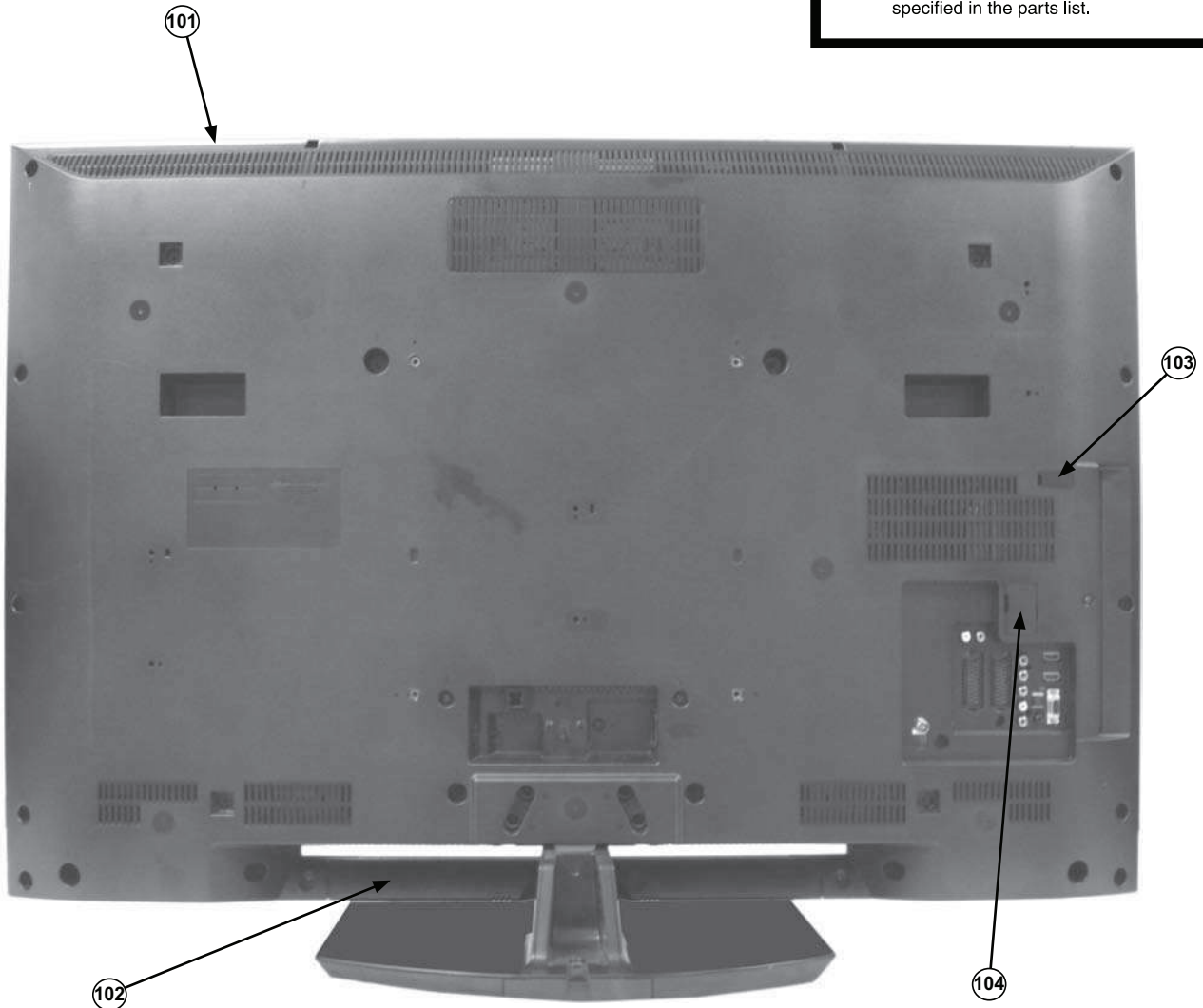

REF.NO.	PART.NO	DESCRIPTION	REMARK	REF.NO.	PART.NO	DESCRIPTION	REMARK
101	X-2345-909-1	REAR COVER ASSY (52C)		104	3-106-546-31	COVER, ECS	(Memory Stick)
102	4-123-486-01	BAR, UNDER (L)		105 $\Delta$	1-835-200-11	POWER-SUPPLY CORD (AEP)	
103	4-122-617-01	COVER, ECS (S)	(TL Jig)	106 $\Delta$	1-835-165-11	POWER-SUPPLY CORD (UK)	

## SECTION 6 ELECTRICAL PARTS LIST

### PARTS LISTING TABLE OF CONTENTS

	<u>Page</u>
BA BOARD COMPLETE Parts List : .....	46
HL4A BOARD COMPLETE Parts List : .....	61
HSN BOARD COMPLETE Parts List : .....	61
ACCESSORIES AND CONNECTORS : .....	62
REMOTE COMMANDER : .....	62

Note: To ensure safety and reliability it is Sony policy that power supply boards should not be repaired at component level in the field as a result... The G5N, D5N and D6N boards are regarded as non service items for exchange only and are not indicated in the parts list of this service manual.

Note : Items marked “\*” are not stocked since they are seldom required for routine service. Some delay should be anticipated when ordering these items.

Note : The components identified by mark  contain confidential information. Strictly follow the instructions when ever the components are repaired and/or replaced.



REF.NO.	PART.NO	DESCRIPTION	REMARK	REF.NO.	PART.NO	DESCRIPTION	REMARK
 A-1707-009-A BA Board, Complete							
< CAPACITOR >							
C1001	1-164-874-11	CERAMIC CHIP 100PF	5.00% 50V	C2015	1-112-777-11	CERAMIC CHIP 0.01UF	10% 25V
C1002	1-112-781-11	CERAMIC CHIP 1UF	10% 10V	C2016	1-112-777-11	CERAMIC CHIP 0.01UF	10% 25V
C1003	1-114-325-11	CERAMIC CHIP 0.1UF	10% 25V	C2017	1-112-777-11	CERAMIC CHIP 0.01UF	10% 25V
C1004	1-114-325-11	CERAMIC CHIP 0.1UF	10% 25V	C2018	1-112-777-11	CERAMIC CHIP 0.01UF	10% 25V
C1006	1-114-331-11	CERAMIC CHIP 4.7UF	10% 10V	C2019	1-112-777-11	CERAMIC CHIP 0.01UF	10% 25V
C1007	1-114-553-11	CERAMIC CHIP 10UF	10% 16V	C2020	1-112-777-11	CERAMIC CHIP 0.01UF	10% 25V
C1008	1-114-553-11	CERAMIC CHIP 10UF	10% 16V	C2021	1-112-777-11	CERAMIC CHIP 0.01UF	10% 25V
C1010	1-165-872-21	ELECT CHIP 47UF	20% 6.3V	C2022	1-112-777-11	CERAMIC CHIP 0.01UF	10% 25V
C1011	1-114-532-21	ELECT CHIP 330UF	20% 4V	C2023	1-112-777-11	CERAMIC CHIP 0.01UF	10% 25V
C1012	1-100-909-11	CERAMIC CHIP 10UF	10% 6.3V	C2024	1-112-777-11	CERAMIC CHIP 0.01UF	10% 25V
C1013	1-114-332-11	CERAMIC CHIP 22UF	10% 6.3V	C2025	1-112-777-11	CERAMIC CHIP 0.01UF	10% 25V
C1014	1-100-909-11	CERAMIC CHIP 10UF	10% 6.3V	C2026	1-112-777-11	CERAMIC CHIP 0.01UF	10% 25V
C1015	1-112-781-11	CERAMIC CHIP 1UF	10% 10V	C2027	1-112-777-11	CERAMIC CHIP 0.01UF	10% 25V
C1017	1-112-781-11	CERAMIC CHIP 1UF	10% 10V	C2028	1-112-777-11	CERAMIC CHIP 0.01UF	10% 25V
C1018	1-112-781-11	CERAMIC CHIP 1UF	10% 10V	C2029	1-112-777-11	CERAMIC CHIP 0.01UF	10% 25V
C1019	1-100-916-11	CERAMIC CHIP 0.1UF	10% 16V	C2030	1-112-777-11	CERAMIC CHIP 0.01UF	10% 25V
C1020	1-112-064-11	CERAMIC CHIP 2.2UF	10% 10V	C2031	1-112-777-11	CERAMIC CHIP 0.01UF	10% 25V
C1021	1-100-916-11	CERAMIC CHIP 0.1UF	10% 16V	C2033	1-112-777-11	CERAMIC CHIP 0.01UF	10% 25V
C1022	1-112-064-11	CERAMIC CHIP 2.2UF	10% 10V	C2034	1-100-916-11	CERAMIC CHIP 0.1UF	10% 16V
C1024	1-112-781-11	CERAMIC CHIP 1UF	10% 10V	C2035	1-100-916-11	CERAMIC CHIP 0.1UF	10% 16V
C1303	1-112-777-11	CERAMIC CHIP 0.01UF	10% 25V	C2036	1-100-916-11	CERAMIC CHIP 0.1UF	10% 16V
C1304	1-114-353-11	CAP, CERAMIC 0.01MF X7R (1410)		C2037	1-100-916-11	CERAMIC CHIP 0.1UF	10% 16V
C1306	1-112-777-11	CERAMIC CHIP 0.01UF	10% 25V	C2500	1-100-916-11	CERAMIC CHIP 0.1UF	10% 16V
C1321	1-112-777-11	CERAMIC CHIP 0.01UF	10% 25V	C2501	1-100-909-11	CERAMIC CHIP 10UF	10% 6.3V
C1322	1-114-331-11	CERAMIC CHIP 4.7UF	10% 10V	C2502	1-100-916-11	CERAMIC CHIP 0.1UF	10% 16V
C1324	1-112-777-11	CERAMIC CHIP 0.01UF	10% 25V	C2503	1-100-916-11	CERAMIC CHIP 0.1UF	10% 16V
C1328	1-112-777-11	CERAMIC CHIP 0.01UF	10% 25V	C2505	1-100-916-11	CERAMIC CHIP 0.1UF	10% 16V
C1355	1-100-916-11	CERAMIC CHIP 0.1UF	10% 16V	C2506	1-114-399-21	ELECT CHIP 47UF	20% 6.3V
C1357	1-100-912-11	CERAMIC CHIP 1UF	10% 25V	C3000	1-112-777-11	CERAMIC CHIP 0.01UF	10% 25V
C1374	1-100-912-11	CERAMIC CHIP 1UF	10% 25V	C3001	1-100-905-11	CERAMIC CHIP 0.001UF	10% 50V
C1380	1-100-916-11	CERAMIC CHIP 0.1UF	10% 16V	C3002	1-100-905-11	CERAMIC CHIP 0.001UF	10% 50V
C1381	1-112-776-11	CERAMIC CHIP 0.0047UF	10% 50V	C3003	1-112-064-11	CERAMIC CHIP 2.2UF	10% 10V
C1382	1-112-068-11	CERAMIC CHIP 220PF	10% 50V	C3004	1-100-905-11	CERAMIC CHIP 0.001UF	10% 50V
C1384	1-114-553-11	CERAMIC CHIP 10UF	10% 16V	C3005	1-100-905-11	CERAMIC CHIP 0.001UF	10% 50V
C1385	1-114-325-11	CERAMIC CHIP 0.1UF	10% 25V	C3006	1-100-905-11	CERAMIC CHIP 0.001UF	10% 50V
C1386	1-114-553-11	CERAMIC CHIP 10UF	10% 16V	C3007	1-112-064-11	CERAMIC CHIP 2.2UF	10% 10V
C2000	1-164-846-11	CERAMIC CHIP 6PF	0.50PF 50V	C3008	1-100-905-11	CERAMIC CHIP 0.001UF	10% 50V
C2001	1-164-846-11	CERAMIC CHIP 6PF	0.50PF 50V	C3009	1-100-905-11	CERAMIC CHIP 0.001UF	10% 50V
C2007	1-100-909-11	CERAMIC CHIP 10UF	10% 6.3V	C3010	1-112-777-11	CERAMIC CHIP 0.01UF	10% 25V
C2008	1-100-909-11	CERAMIC CHIP 10UF	10% 6.3V	C3011	1-100-905-11	CERAMIC CHIP 0.001UF	10% 50V
C2009	1-112-777-11	CERAMIC CHIP 0.01UF	10% 25V	C3012	1-100-905-11	CERAMIC CHIP 0.001UF	10% 50V
C2010	1-112-777-11	CERAMIC CHIP 0.01UF	10% 25V	C3013	1-100-905-11	CERAMIC CHIP 0.001UF	10% 50V
C2011	1-112-777-11	CERAMIC CHIP 0.01UF	10% 25V	C3014	1-100-905-11	CERAMIC CHIP 0.001UF	10% 50V
C2012	1-112-777-11	CERAMIC CHIP 0.01UF	10% 25V	C3015	1-112-781-11	CERAMIC CHIP 1UF	10% 10V
C2013	1-112-777-11	CERAMIC CHIP 0.01UF	10% 25V	C3016	1-112-777-11	CERAMIC CHIP 0.01UF	10% 25V
C2014	1-112-777-11	CERAMIC CHIP 0.01UF	10% 25V	C3017	1-100-905-11	CERAMIC CHIP 0.001UF	10% 50V
				C3018	1-100-916-11	CERAMIC CHIP 0.1UF	10% 16V
				C3019	1-100-916-11	CERAMIC CHIP 0.1UF	10% 16V
				C3020	1-100-909-11	CERAMIC CHIP 10UF	10% 6.3V
				C3021	1-100-909-11	CERAMIC CHIP 10UF	10% 6.3V



REF.NO.	PART.NO	DESCRIPTION	REMARK	REF.NO.	PART.NO	DESCRIPTION	REMARK
C3022	1-112-779-11	CERAMIC CHIP 0.047UF	10% 25V	C3083	1-100-905-11	CERAMIC CHIP 0.001UF	10% 50V
C3023	1-114-870-11	CERAMIC CHIP 4.7UF	10% 16V	C3084	1-100-905-11	CERAMIC CHIP 0.001UF	10% 50V
C3025	1-114-870-11	CERAMIC CHIP 4.7UF	10% 16V	C3085	1-100-909-11	CERAMIC CHIP 10UF	10% 6.3V
C3026	1-114-331-11	CERAMIC CHIP 4.7UF	10% 10V	C3086	1-100-909-11	CERAMIC CHIP 10UF	10% 6.3V
C3027	1-114-325-11	CERAMIC CHIP 0.1UF	10% 25V	C3087	1-100-909-11	CERAMIC CHIP 10UF	10% 6.3V
C3028	1-114-532-21	ELECT CHIP 330UF	20% 4V	C3088	1-100-916-11	CERAMIC CHIP 0.1UF	10% 16V
C3030	1-100-916-11	CERAMIC CHIP 0.1UF	10% 16V	C3089	1-100-905-11	CERAMIC CHIP 0.001UF	10% 50V
C3031	1-100-916-11	CERAMIC CHIP 0.1UF	10% 16V	C3501	1-100-909-11	CERAMIC CHIP 10UF	10% 6.3V
C3032	1-112-777-11	CERAMIC CHIP 0.01UF	10% 25V	C3502	1-100-909-11	CERAMIC CHIP 10UF	10% 6.3V
C3033	1-112-777-11	CERAMIC CHIP 0.01UF	10% 25V	C3503	1-100-916-11	CERAMIC CHIP 0.1UF	10% 16V
C3034	1-112-777-11	CERAMIC CHIP 0.01UF	10% 25V	C3505	1-100-909-11	CERAMIC CHIP 10UF	10% 6.3V
C3035	1-112-777-11	CERAMIC CHIP 0.01UF	10% 25V	C3506	1-100-916-11	CERAMIC CHIP 0.1UF	10% 16V
C3036	1-112-777-11	CERAMIC CHIP 0.01UF	10% 25V	C3507	1-100-916-11	CERAMIC CHIP 0.1UF	10% 16V
C3037	1-112-777-11	CERAMIC CHIP 0.01UF	10% 25V	C3508	1-100-916-11	CERAMIC CHIP 0.1UF	10% 16V
C3038	1-112-777-11	CERAMIC CHIP 0.01UF	10% 25V	C3509	1-100-916-11	CERAMIC CHIP 0.1UF	10% 16V
C3039	1-112-777-11	CERAMIC CHIP 0.01UF	10% 25V	C3510	1-100-916-11	CERAMIC CHIP 0.1UF	10% 16V
C3040	1-112-777-11	CERAMIC CHIP 0.01UF	10% 25V	C3511	1-100-916-11	CERAMIC CHIP 0.1UF	10% 16V
C3041	1-112-777-11	CERAMIC CHIP 0.01UF	10% 25V	C3512	1-164-874-11	CERAMIC CHIP 100PF	5.00% 50V
C3042	1-112-777-11	CERAMIC CHIP 0.01UF	10% 25V	C3513	1-100-916-11	CERAMIC CHIP 0.1UF	10% 16V
C3043	1-112-777-11	CERAMIC CHIP 0.01UF	10% 25V	C3514	1-100-909-11	CERAMIC CHIP 10UF	10% 6.3V
C3044	1-112-777-11	CERAMIC CHIP 0.01UF	10% 25V	C3515	1-100-916-11	CERAMIC CHIP 0.1UF	10% 16V
C3045	1-112-777-11	CERAMIC CHIP 0.01UF	10% 25V	C3516	1-114-400-21	ELECT CHIP 100UF	20% 6.3V
C3046	1-112-777-11	CERAMIC CHIP 0.01UF	10% 25V	C3517	1-112-777-11	CERAMIC CHIP 0.01UF	10% 25V
C3047	1-112-777-11	CERAMIC CHIP 0.01UF	10% 25V	C3518	1-112-777-11	CERAMIC CHIP 0.01UF	10% 25V
C3048	1-112-777-11	CERAMIC CHIP 0.01UF	10% 25V	C3519	1-100-905-11	CERAMIC CHIP 0.001UF	10% 50V
C3049	1-112-777-11	CERAMIC CHIP 0.01UF	10% 25V	C3520	1-100-916-11	CERAMIC CHIP 0.1UF	10% 16V
C3050	1-112-777-11	CERAMIC CHIP 0.01UF	10% 25V	C3523	1-100-905-11	CERAMIC CHIP 0.001UF	10% 50V
C3051	1-112-777-11	CERAMIC CHIP 0.01UF	10% 25V	C3524	1-100-767-21	ELECT CHIP 220UF	20% 16V
C3052	1-112-777-11	CERAMIC CHIP 0.01UF	10% 25V	C3525	1-100-916-11	CERAMIC CHIP 0.1UF	10% 16V
C3053	1-112-777-11	CERAMIC CHIP 0.01UF	10% 25V	C3526	1-100-909-11	CERAMIC CHIP 10UF	10% 6.3V
C3057	1-112-777-11	CERAMIC CHIP 0.01UF	10% 25V	C3527	1-100-909-11	CERAMIC CHIP 10UF	10% 6.3V
C3058	1-112-777-11	CERAMIC CHIP 0.01UF	10% 25V	C3801	1-100-916-11	CERAMIC CHIP 0.1UF	10% 16V
C3059	1-112-777-11	CERAMIC CHIP 0.01UF	10% 25V	C3806	1-100-916-11	CERAMIC CHIP 0.1UF	10% 16V
C3060	1-112-777-11	CERAMIC CHIP 0.01UF	10% 25V	C3807	1-100-916-11	CERAMIC CHIP 0.1UF	10% 16V
C3061	1-112-777-11	CERAMIC CHIP 0.01UF	10% 25V	C3808	1-100-916-11	CERAMIC CHIP 0.1UF	10% 16V
C3062	1-112-777-11	CERAMIC CHIP 0.01UF	10% 25V	C3809	1-100-916-11	CERAMIC CHIP 0.1UF	10% 16V
C3063	1-112-777-11	CERAMIC CHIP 0.01UF	10% 25V	C3810	1-100-916-11	CERAMIC CHIP 0.1UF	10% 16V
C3064	1-112-777-11	CERAMIC CHIP 0.01UF	10% 25V	C3811	1-100-916-11	CERAMIC CHIP 0.1UF	10% 16V
C3065	1-112-064-11	CERAMIC CHIP 2.2UF	10% 10V	C3812	1-100-916-11	CERAMIC CHIP 0.1UF	10% 16V
C3066	1-112-064-11	CERAMIC CHIP 2.2UF	10% 10V	C3813	1-100-905-11	CERAMIC CHIP 0.001UF	10% 50V
C3067	1-112-064-11	CERAMIC CHIP 2.2UF	10% 10V	C3814	1-114-331-11	CERAMIC CHIP 4.7UF	10% 10V
C3068	1-112-064-11	CERAMIC CHIP 2.2UF	10% 10V	C3815	1-100-916-11	CERAMIC CHIP 0.1UF	10% 16V
C3069	1-112-064-11	CERAMIC CHIP 2.2UF	10% 10V	C4000	1-100-916-11	CERAMIC CHIP 0.1UF	10% 16V
C3070	1-100-905-11	CERAMIC CHIP 0.001UF	10% 50V	C4001	1-100-916-11	CERAMIC CHIP 0.1UF	10% 16V
C3077	1-100-904-11	CERAMIC CHIP 330PF	10% 50V	C4003	1-164-850-11	CERAMIC CHIP 10PF	0.50PF 50V
C3078	1-100-905-11	CERAMIC CHIP 0.001UF	10% 50V	C4006	1-100-916-11	CERAMIC CHIP 0.1UF	10% 16V
C3079	1-100-916-11	CERAMIC CHIP 0.1UF	10% 16V	C4007	1-112-777-11	CERAMIC CHIP 0.01UF	10% 25V
C3080	1-100-916-11	CERAMIC CHIP 0.1UF	10% 16V	C4008	1-100-916-11	CERAMIC CHIP 0.1UF	10% 16V
C3081	1-100-916-11	CERAMIC CHIP 0.1UF	10% 16V	C4009	1-112-777-11	CERAMIC CHIP 0.01UF	10% 25V
C3082	1-100-905-11	CERAMIC CHIP 0.001UF	10% 50V	C4010	1-100-916-11	CERAMIC CHIP 0.1UF	10% 16V

REF.NO.	PART.NO	DESCRIPTION	REMARK	REF.NO.	PART.NO	DESCRIPTION	REMARK
C4011	1-112-777-11	CERAMIC CHIP 0.01UF	10% 25V	C4419	1-100-916-11	CERAMIC CHIP 0.1UF	10% 16V
C4012	1-100-916-11	CERAMIC CHIP 0.1UF	10% 16V	C4420	1-100-916-11	CERAMIC CHIP 0.1UF	10% 16V
C4013	1-100-916-11	CERAMIC CHIP 0.1UF	10% 16V	C4421	1-100-916-11	CERAMIC CHIP 0.1UF	10% 16V
C4014	1-100-916-11	CERAMIC CHIP 0.1UF	10% 16V	C4423	1-112-777-11	CERAMIC CHIP 0.01UF	10% 25V
C4015	1-100-916-11	CERAMIC CHIP 0.1UF	10% 16V	C4424	1-112-777-11	CERAMIC CHIP 0.01UF	10% 25V
C4016	1-112-779-11	CERAMIC CHIP 0.047UF	10% 25V	C4425	1-112-777-11	CERAMIC CHIP 0.01UF	10% 25V
C4017	1-164-874-11	CERAMIC CHIP 100PF	5.00% 50V	C4427	1-112-777-11	CERAMIC CHIP 0.01UF	10% 25V
C4018	1-164-878-11	CERAMIC CHIP 150PF	5% 50V	C4428	1-112-777-11	CERAMIC CHIP 0.01UF	10% 25V
C4019	1-100-916-11	CERAMIC CHIP 0.1UF	10% 16V	C4429	1-112-777-11	CERAMIC CHIP 0.01UF	10% 25V
C4020	1-100-916-11	CERAMIC CHIP 0.1UF	10% 16V	C4430	1-112-777-11	CERAMIC CHIP 0.01UF	10% 25V
C4021	1-100-916-11	CERAMIC CHIP 0.1UF	10% 16V	C4431	1-112-777-11	CERAMIC CHIP 0.01UF	10% 25V
C4022	1-100-909-11	CERAMIC CHIP 10UF	10% 6.3V	C4432	1-112-777-11	CERAMIC CHIP 0.01UF	10% 25V
C4027	1-100-909-11	CERAMIC CHIP 10UF	10% 6.3V	C4433	1-112-777-11	CERAMIC CHIP 0.01UF	10% 25V
C4028	1-100-909-11	CERAMIC CHIP 10UF	10% 6.3V	C4434	1-112-777-11	CERAMIC CHIP 0.01UF	10% 25V
C4029	1-100-909-11	CERAMIC CHIP 10UF	10% 6.3V	C4502	1-100-916-11	CERAMIC CHIP 0.1UF	10% 16V
C4030	1-100-909-11	CERAMIC CHIP 10UF	10% 6.3V	C4503	1-100-916-11	CERAMIC CHIP 0.1UF	10% 16V
C4031	1-100-909-11	CERAMIC CHIP 10UF	10% 6.3V	C4504	1-100-909-11	CERAMIC CHIP 10UF	10% 6.3V
C4032	1-100-909-11	CERAMIC CHIP 10UF	10% 6.3V	C4506	1-100-916-11	CERAMIC CHIP 0.1UF	10% 16V
C4033	1-100-909-11	CERAMIC CHIP 10UF	10% 6.3V	C4507	1-100-916-11	CERAMIC CHIP 0.1UF	10% 16V
C4034	1-100-909-11	CERAMIC CHIP 10UF	10% 6.3V	C4508	1-114-869-11	CERAMIC CHIP 2.2UF	10% 6.3V
C4035	1-100-909-11	CERAMIC CHIP 10UF	10% 6.3V	C4509	1-100-916-11	CERAMIC CHIP 0.1UF	10% 16V
C4036	1-100-909-11	CERAMIC CHIP 10UF	10% 6.3V	C4510	1-100-916-11	CERAMIC CHIP 0.1UF	10% 16V
C4037	1-100-909-11	CERAMIC CHIP 10UF	10% 6.3V	C4511	1-100-916-11	CERAMIC CHIP 0.1UF	10% 16V
C4038	1-100-909-11	CERAMIC CHIP 10UF	10% 6.3V	C4512	1-112-777-11	CERAMIC CHIP 0.01UF	10% 25V
C4039	1-100-909-11	CERAMIC CHIP 10UF	10% 6.3V	C4513	1-112-777-11	CERAMIC CHIP 0.01UF	10% 25V
C4056	1-114-354-11	CAP, CERAMIC 0.1MF X7R (1410)		C4514	1-112-777-11	CERAMIC CHIP 0.01UF	10% 25V
C4057	1-100-916-11	CERAMIC CHIP 0.1UF	10% 16V	C4515	1-112-777-11	CERAMIC CHIP 0.01UF	10% 25V
C4058	1-100-916-11	CERAMIC CHIP 0.1UF	10% 16V	C4516	1-100-916-11	CERAMIC CHIP 0.1UF	10% 16V
C4200	1-112-781-11	CERAMIC CHIP 1UF	10% 10V	C4517	1-100-916-11	CERAMIC CHIP 0.1UF	10% 16V
C4201	1-112-781-11	CERAMIC CHIP 1UF	10% 10V	C5004	1-100-916-11	CERAMIC CHIP 0.1UF	10% 16V
C4202	1-112-781-11	CERAMIC CHIP 1UF	10% 10V	C5005	1-100-916-11	CERAMIC CHIP 0.1UF	10% 16V
C4205	1-112-781-11	CERAMIC CHIP 1UF	10% 10V	C5006	1-100-916-11	CERAMIC CHIP 0.1UF	10% 16V
C4209	1-112-781-11	CERAMIC CHIP 1UF	10% 10V	C5007	1-100-916-11	CERAMIC CHIP 0.1UF	10% 16V
C4210	1-112-781-11	CERAMIC CHIP 1UF	10% 10V	C5009	1-100-916-11	CERAMIC CHIP 0.1UF	10% 16V
C4211	1-112-781-11	CERAMIC CHIP 1UF	10% 10V	C5010	1-100-916-11	CERAMIC CHIP 0.1UF	10% 16V
C4213	1-100-916-11	CERAMIC CHIP 0.1UF	10% 16V	C5011	1-100-916-11	CERAMIC CHIP 0.1UF	10% 16V
C4214	1-114-331-11	CERAMIC CHIP 4.7UF	10% 10V	C5012	1-100-916-11	CERAMIC CHIP 0.1UF	10% 16V
C4401	1-116-079-11	CERAMIC CHIP 10UF	10% 10V	C5027	1-100-916-11	CERAMIC CHIP 0.1UF	10% 16V
C4402	1-100-916-11	CERAMIC CHIP 0.1UF	10% 16V	C5500	1-100-905-11	CERAMIC CHIP 0.001UF	10% 50V
C4406	1-114-332-11	CERAMIC CHIP 22UF	10% 6.3V	C5501	1-100-905-11	CERAMIC CHIP 0.001UF	10% 50V
C4407	1-100-909-11	CERAMIC CHIP 10UF	10% 6.3V	C5505	1-112-781-11	CERAMIC CHIP 1UF	10% 10V
C4408	1-100-916-11	CERAMIC CHIP 0.1UF	10% 16V	C5506	1-100-916-11	CERAMIC CHIP 0.1UF	10% 16V
C4409	1-112-779-11	CERAMIC CHIP 0.047UF	10% 25V	C5507	1-114-813-11	CERAMIC CHIP 1UF	10% 16V
C4410	1-112-779-11	CERAMIC CHIP 0.047UF	10% 25V	C5509	1-100-916-11	CERAMIC CHIP 0.1UF	10% 16V
C4411	1-112-779-11	CERAMIC CHIP 0.047UF	10% 25V	C5510	1-100-916-11	CERAMIC CHIP 0.1UF	10% 16V
C4413	1-112-779-11	CERAMIC CHIP 0.047UF	10% 25V	C5511	1-100-916-11	CERAMIC CHIP 0.1UF	10% 16V
C4414	1-112-779-11	CERAMIC CHIP 0.047UF	10% 25V	C5512	1-100-916-11	CERAMIC CHIP 0.1UF	10% 16V
C4415	1-112-779-11	CERAMIC CHIP 0.047UF	10% 25V	C5514	1-100-916-11	CERAMIC CHIP 0.1UF	10% 16V
C4416	1-112-779-11	CERAMIC CHIP 0.047UF	10% 25V	C5516	1-100-916-11	CERAMIC CHIP 0.1UF	10% 16V
C4417	1-112-779-11	CERAMIC CHIP 0.047UF	10% 25V	C5517	1-100-916-11	CERAMIC CHIP 0.1UF	10% 16V



REF.NO.	PART.NO	DESCRIPTION	REMARK	REF.NO.	PART.NO	DESCRIPTION	REMARK
C5518	1-100-916-11	CERAMIC CHIP 0.1UF	10% 16V	C7039	1-114-354-11	CAP, CERAMIC 0.1MF X7R (1410)	
C5519	1-100-916-11	CERAMIC CHIP 0.1UF	10% 16V	C7040	1-100-916-11	CERAMIC CHIP 0.1UF	10% 16V
C5522	1-100-916-11	CERAMIC CHIP 0.1UF	10% 16V	C7041	1-112-777-11	CERAMIC CHIP 0.01UF	10% 25V
C5523	1-100-916-11	CERAMIC CHIP 0.1UF	10% 16V	C7042	1-164-850-11	CERAMIC CHIP 10PF	0.50PF 50V
C5525	1-100-916-11	CERAMIC CHIP 0.1UF	10% 16V	C7043	1-164-850-11	CERAMIC CHIP 10PF	0.50PF 50V
C5528	1-100-905-11	CERAMIC CHIP 0.001UF	10% 50V	C7202	1-112-777-11	CERAMIC CHIP 0.01UF	10% 25V
C5529	1-164-850-11	CERAMIC CHIP 10PF	0.50PF 50V	C7203	1-114-193-11	ELECT CHIP 470UF	20% 25V
C5530	1-164-852-11	CERAMIC CHIP 12PF	5.00% 50V	C7204	1-114-193-11	ELECT CHIP 470UF	20% 25V
C5531	1-100-916-11	CERAMIC CHIP 0.1UF	10% 16V	C7205	1-114-193-11	ELECT CHIP 470UF	20% 25V
C5533	1-100-916-11	CERAMIC CHIP 0.1UF	10% 16V	C7206	1-114-325-11	CERAMIC CHIP 0.1UF	10% 25V
C5535	1-112-777-11	CERAMIC CHIP 0.01UF	10% 25V	C7207	1-100-909-11	CERAMIC CHIP 10UF	10% 6.3V
C5536	1-114-130-11	CERAMIC CHIP 1UF	10% 6.3V	C7208	1-114-325-11	CERAMIC CHIP 0.1UF	10% 25V
C5540	1-112-777-11	CERAMIC CHIP 0.01UF	10% 25V	C7209	1-114-326-11	CERAMIC CHIP 0.22UF	10% 25V
C5542	1-164-874-11	CERAMIC CHIP 100PF	5.00% 50V	C7210	1-100-912-11	CERAMIC CHIP 1UF	10% 25V
C5543	1-100-909-11	CERAMIC CHIP 10UF	10% 6.3V	C7211	1-114-326-11	CERAMIC CHIP 0.22UF	10% 25V
C5544	1-112-777-11	CERAMIC CHIP 0.01UF	10% 25V	C7212	1-114-326-11	CERAMIC CHIP 0.22UF	10% 25V
C5546	1-100-916-11	CERAMIC CHIP 0.1UF	10% 16V	C7213	1-114-326-11	CERAMIC CHIP 0.22UF	10% 25V
C5548	1-100-916-11	CERAMIC CHIP 0.1UF	10% 16V	C7214	1-100-912-11	CERAMIC CHIP 1UF	10% 25V
C5550	1-100-905-11	CERAMIC CHIP 0.001UF	10% 50V	C7215	1-114-326-11	CERAMIC CHIP 0.22UF	10% 25V
C5551	1-100-905-11	CERAMIC CHIP 0.001UF	10% 50V	C7216	1-114-325-11	CERAMIC CHIP 0.1UF	10% 25V
C5552	1-112-781-11	CERAMIC CHIP 1UF	10% 10V	C7217	1-114-334-11	CERAMIC CHIP 10UF	10% 25V
C5553	1-112-781-11	CERAMIC CHIP 1UF	10% 10V	C7218	1-114-325-11	CERAMIC CHIP 0.1UF	10% 25V
C7001	1-100-916-11	CERAMIC CHIP 0.1UF	10% 16V	C7220	1-114-814-11	CERAMIC CHIP 0.33UF	10% 25V
C7007	1-100-916-11	CERAMIC CHIP 0.1UF	10% 16V	C7221	1-114-814-11	CERAMIC CHIP 0.33UF	10% 25V
C7008	1-100-767-21	ELECT CHIP 220UF	20% 16V	C7222	1-114-814-11	CERAMIC CHIP 0.33UF	10% 25V
C7009	1-114-354-11	CAP, CERAMIC 0.1MF X7R (1410)		C7223	1-114-814-11	CERAMIC CHIP 0.33UF	10% 25V
C7010	1-114-354-11	CAP, CERAMIC 0.1MF X7R (1410)		C7224	1-164-874-11	CERAMIC CHIP 100PF	5.00% 50V
C7011	1-114-331-11	CERAMIC CHIP 4.7UF	10% 10V	C7225	1-164-874-11	CERAMIC CHIP 100PF	5.00% 50V
C7012	1-100-916-11	CERAMIC CHIP 0.1UF	10% 16V	C7226	1-164-874-11	CERAMIC CHIP 100PF	5.00% 50V
C7013	1-100-767-21	ELECT CHIP 220UF	20% 16V	C7227	1-164-874-11	CERAMIC CHIP 100PF	5.00% 50V
C7014	1-114-331-11	CERAMIC CHIP 4.7UF	10% 10V	C7301	1-114-331-11	CERAMIC CHIP 4.7UF	10% 10V
C7016	1-100-916-11	CERAMIC CHIP 0.1UF	10% 16V	C7302	1-114-331-11	CERAMIC CHIP 4.7UF	10% 10V
C7017	1-114-130-11	CERAMIC CHIP 1UF	10% 6.3V	C7303	1-137-942-21	ELECT CHIP 47UF	20% 25V
C7018	1-114-130-11	CERAMIC CHIP 1UF	10% 6.3V	C7304	1-114-520-11	CAP, CERAMIC 1MF X6S (1410)	
C7020	1-114-354-11	CAP, CERAMIC 0.1MF X7R (1410)		C7305	1-112-776-11	CERAMIC CHIP 0.0047UF	10% 50V
C7021	1-100-916-11	CERAMIC CHIP 0.1UF	10% 16V	C7306	1-114-520-11	CAP, CERAMIC 1MF X6S (1410)	
C7023	1-100-916-11	CERAMIC CHIP 0.1UF	10% 16V	C7307	1-112-776-11	CERAMIC CHIP 0.0047UF	10% 50V
C7025	1-112-781-11	CERAMIC CHIP 1UF	10% 10V	C7308	1-114-325-11	CERAMIC CHIP 0.1UF	10% 25V
C7026	1-114-520-11	CAP, CERAMIC 1MF X6S (1410)		C7311	1-114-520-11	CAP, CERAMIC 1MF X6S (1410)	
C7027	1-100-916-11	CERAMIC CHIP 0.1UF	10% 16V	C7312	1-114-325-11	CERAMIC CHIP 0.1UF	10% 25V
C7029	1-114-354-11	CAP, CERAMIC 0.1MF X7R (1410)		C7313	1-114-331-11	CERAMIC CHIP 4.7UF	10% 10V
C7030	1-114-331-11	CERAMIC CHIP 4.7UF	10% 10V	C7314	1-100-916-11	CERAMIC CHIP 0.1UF	10% 16V
C7031	1-100-916-11	CERAMIC CHIP 0.1UF	10% 16V	C7315	1-114-325-11	CERAMIC CHIP 0.1UF	10% 25V
C7032	1-114-331-11	CERAMIC CHIP 4.7UF	10% 10V	C7316	1-114-331-11	CERAMIC CHIP 4.7UF	10% 10V
C7033	1-100-916-11	CERAMIC CHIP 0.1UF	10% 16V	C7318	1-114-325-11	CERAMIC CHIP 0.1UF	10% 25V
C7034	1-100-767-21	ELECT CHIP 220UF	20% 16V	C7319	1-114-334-11	CERAMIC CHIP 10UF	10% 25V
C7035	1-100-916-11	CERAMIC CHIP 0.1UF	10% 16V	C7320	1-100-916-11	CERAMIC CHIP 0.1UF	10% 16V
C7036	1-114-331-11	CERAMIC CHIP 4.7UF	10% 10V	C7321	1-114-331-11	CERAMIC CHIP 4.7UF	10% 10V
C7037	1-112-777-11	CERAMIC CHIP 0.01UF	10% 25V	C7322	1-116-079-11	CERAMIC CHIP 10UF	10% 10V
C7038	1-100-916-11	CERAMIC CHIP 0.1UF	10% 16V	C7326	1-114-520-11	CAP, CERAMIC 1MF X6S (1410)	

REF.NO.	PART.NO	DESCRIPTION	REMARK	REF.NO.	PART.NO	DESCRIPTION	REMARK
C7327	1-114-520-11	CAP, CERAMIC 1MF X6S (1410)		C7916	1-114-320-11	CERAMIC CHIP 0.22UF	10% 6.3V
C7328	1-112-781-11	CERAMIC CHIP 1UF	10% 10V	C7918	1-114-331-11	CERAMIC CHIP 4.7UF	10% 10V
C7329	1-112-781-11	CERAMIC CHIP 1UF	10% 10V	C7921	1-100-766-21	ELECT CHIP 47UF	20% 16V
C7330	1-114-334-11	CERAMIC CHIP 10UF	10% 25V	C7923	1-135-366-11	ELECT CHIP 100UF	20% 16V
C7331	1-100-766-21	ELECT CHIP 47UF	20% 16V	C7924	1-100-916-11	CERAMIC CHIP 0.1UF	10% 16V
C7332	1-100-766-21	ELECT CHIP 47UF	20% 16V	C7927	1-100-916-11	CERAMIC CHIP 0.1UF	10% 16V
C7335	1-112-781-11	CERAMIC CHIP 1UF	10% 10V	C7928	1-100-905-11	CERAMIC CHIP 0.001UF	10% 50V
C7336	1-112-781-11	CERAMIC CHIP 1UF	10% 10V	C7930	1-114-332-11	CERAMIC CHIP 22UF	10% 6.3V
C7337	1-112-781-11	CERAMIC CHIP 1UF	10% 10V	C7932	1-100-916-11	CERAMIC CHIP 0.1UF	10% 16V
C7338	1-112-781-11	CERAMIC CHIP 1UF	10% 10V	C7933	1-112-781-11	CERAMIC CHIP 1UF	10% 10V
C7341	1-112-781-11	CERAMIC CHIP 1UF	10% 10V	C7936	1-135-366-11	ELECT CHIP 100UF	20% 16V
C7342	1-112-781-11	CERAMIC CHIP 1UF	10% 10V	C7937	1-164-874-11	CERAMIC CHIP 100PF	5.00% 50V
C7343	1-112-781-11	CERAMIC CHIP 1UF	10% 10V	C7938	1-100-916-11	CERAMIC CHIP 0.1UF	10% 16V
C7344	1-112-781-11	CERAMIC CHIP 1UF	10% 10V	C7940	1-135-366-11	ELECT CHIP 100UF	20% 16V
C7345	1-112-781-11	CERAMIC CHIP 1UF	10% 10V	C7943	1-112-776-11	CERAMIC CHIP 0.0047UF	10% 50V
C7346	1-112-781-11	CERAMIC CHIP 1UF	10% 10V	C7944	1-100-916-11	CERAMIC CHIP 0.1UF	10% 16V
C7401	1-100-909-11	CERAMIC CHIP 10UF	10% 6.3V	C7945	1-100-916-11	CERAMIC CHIP 0.1UF	10% 16V
C7402	1-114-354-11	CAP, CERAMIC 0.1MF X7R (1410)		C7946	1-112-777-11	CERAMIC CHIP 0.01UF	10% 25V
C7403	1-100-909-11	CERAMIC CHIP 10UF	10% 6.3V	C7947	1-218-990-81	SHORT CHIP 0	
C7405	1-112-781-11	CERAMIC CHIP 1UF	10% 10V	C7955	1-112-781-11	CERAMIC CHIP 1UF	10% 10V
C7406	1-112-774-11	CERAMIC CHIP 470PF	10% 50V	C7956	1-114-331-11	CERAMIC CHIP 4.7UF	10% 10V
C7407	1-112-781-11	CERAMIC CHIP 1UF	10% 10V	C7957	1-164-874-11	CERAMIC CHIP 100PF	5.00% 50V
C7408	1-112-774-11	CERAMIC CHIP 470PF	10% 50V	C7961	1-100-912-11	CERAMIC CHIP 1UF	10% 25V
C7600	1-112-777-11	CERAMIC CHIP 0.01UF	10% 25V	C7962	1-100-916-11	CERAMIC CHIP 0.1UF	10% 16V
C7601	1-112-777-11	CERAMIC CHIP 0.01UF	10% 25V	C7963	1-112-064-11	CERAMIC CHIP 2.2UF	10% 10V
C7602	1-112-777-11	CERAMIC CHIP 0.01UF	10% 25V	C7964	1-100-912-11	CERAMIC CHIP 1UF	10% 25V
C7603	1-112-777-11	CERAMIC CHIP 0.01UF	10% 25V	C7965	1-100-912-11	CERAMIC CHIP 1UF	10% 25V
C7604	1-112-777-11	CERAMIC CHIP 0.01UF	10% 25V	C7966	1-114-817-11	CERAMIC CHIP 2.2UF	10% 50V
C7605	1-112-777-11	CERAMIC CHIP 0.01UF	10% 25V	C7970	1-114-868-11	CERAMIC CHIP 0.1UF	10% 50V
C7606	1-112-777-11	CERAMIC CHIP 0.01UF	10% 25V	C7976	1-135-366-11	ELECT CHIP 100UF	20% 16V
C7607	1-112-777-11	CERAMIC CHIP 0.01UF	10% 25V	C7977	1-135-366-11	ELECT CHIP 100UF	20% 16V
C7608	1-112-777-11	CERAMIC CHIP 0.01UF	10% 25V	C7978	1-112-777-11	CERAMIC CHIP 0.01UF	10% 25V
C7610	1-112-777-11	CERAMIC CHIP 0.01UF	10% 25V	C7979	1-112-777-11	CERAMIC CHIP 0.01UF	10% 25V
C7611	1-112-777-11	CERAMIC CHIP 0.01UF	10% 25V	C7982	1-112-781-11	CERAMIC CHIP 1UF	10% 10V
C7612	1-100-916-11	CERAMIC CHIP 0.1UF	10% 16V	C7983	1-100-916-11	CERAMIC CHIP 0.1UF	10% 16V
C7614	1-100-916-11	CERAMIC CHIP 0.1UF	10% 16V	C7984	1-112-781-11	CERAMIC CHIP 1UF	10% 10V
C7615	1-114-130-11	CERAMIC CHIP 1UF	10% 6.3V	C7985	1-100-916-11	CERAMIC CHIP 0.1UF	10% 16V
C7900	1-100-766-21	ELECT CHIP 47UF	20% 16V	C7986	1-164-872-11	CERAMIC CHIP 82PF	5.00% 50V
C7901	1-100-916-11	CERAMIC CHIP 0.1UF	10% 16V	C9602	1-100-916-11	CERAMIC CHIP 0.1UF	10% 16V
C7903	1-112-778-11	CERAMIC CHIP 0.022UF	10% 25V	C9608	1-112-781-11	CERAMIC CHIP 1UF	10% 10V
C7905	1-112-778-11	CERAMIC CHIP 0.022UF	10% 25V	C9610	1-112-777-11	CERAMIC CHIP 0.01UF	10% 25V
C7906	1-100-916-11	CERAMIC CHIP 0.1UF	10% 16V	C9612	1-100-831-91	CERAMIC CHIP 0.001UF	2% 50V
C7907	1-114-332-11	CERAMIC CHIP 22UF	10% 6.3V	C9614	1-100-831-91	CERAMIC CHIP 0.001UF	2% 50V
C7908	1-112-776-11	CERAMIC CHIP 0.0047UF	10% 50V	C9616	1-114-813-11	CERAMIC CHIP 1UF	10% 16V
C7909	1-100-916-11	CERAMIC CHIP 0.1UF	10% 16V	C9617	1-114-813-11	CERAMIC CHIP 1UF	10% 16V
C7910	1-100-916-11	CERAMIC CHIP 0.1UF	10% 16V	C9636	1-100-916-11	CERAMIC CHIP 0.1UF	10% 16V
C7911	1-100-916-11	CERAMIC CHIP 0.1UF	10% 16V	C9637	1-112-777-11	CERAMIC CHIP 0.01UF	10% 25V
C7913	1-114-399-21	ELECT CHIP 47UF	20% 6.3V	C9638	1-162-927-11	CERAMIC CHIP 100PF	5.00% 50V
C7914	1-112-775-11	CERAMIC CHIP 0.0022UF	10% 50V	C9639	1-162-927-11	CERAMIC CHIP 100PF	5.00% 50V
C7915	1-112-775-11	CERAMIC CHIP 0.0022UF	10% 50V	C9642	1-100-831-91	CERAMIC CHIP 0.001UF	2% 50V

REF.NO.	PART.NO	DESCRIPTION	REMARK	REF.NO.	PART.NO	DESCRIPTION	REMARK
C9643	1-100-831-91	CERAMIC CHIP 0.001UF	2% 50V			< DIODE >	
C9645	1-100-905-11	CERAMIC CHIP 0.001UF	10% 50V				
C9646	1-114-813-11	CERAMIC CHIP 1UF	10% 16V	D1300	6-501-614-01	DIODE PZU5.6B2	
C9647	1-114-813-11	CERAMIC CHIP 1UF	10% 16V	D1314	6-502-730-01	DI RSX301L-30USTE25	
C9648	1-112-068-11	CERAMIC CHIP 220PF	10% 50V	D3506	1-805-774-21	VARISTOR, CHIP	
				D3507	1-805-774-21	VARISTOR, CHIP	
C9649	1-112-068-11	CERAMIC CHIP 220PF	10% 50V	D5509	8-719-056-48	DIODE 1SS388(TPL3)	
C9650	1-112-778-11	CERAMIC CHIP 0.022UF	10% 25V				
C9651	1-112-778-11	CERAMIC CHIP 0.022UF	10% 25V	D7203	6-502-247-01	DI KDZTR3.6B	
C9803	1-100-831-91	CERAMIC CHIP 0.001UF	2% 50V	D7603	6-502-318-01	DI MA4J1130GLS0	
C9804	1-100-831-91	CERAMIC CHIP 0.001UF	2% 50V	D7604	6-502-318-01	DI MA4J1130GLS0	
				D7605	6-502-318-01	DI MA4J1130GLS0	
				D7607	6-502-318-01	DI MA4J1130GLS0	
C9805	1-100-831-91	CERAMIC CHIP 0.001UF	2% 50V				
C9806	1-100-831-91	CERAMIC CHIP 0.001UF	2% 50V				
C9809	1-114-813-11	CERAMIC CHIP 1UF	10% 16V	D7608	6-502-150-01	DI MA2SD320G8S0	
C9810	1-114-813-11	CERAMIC CHIP 1UF	10% 16V	D7609	6-502-150-01	DI MA2SD320G8S0	
C9811	1-114-410-21	CERAMIC CHIP 680PF	2% 50V	D7900	8-719-058-24	DIODE RB501V-40TE-17	
				D9600	6-502-177-01	DI UMZ9.1KTL	
C9818	1-100-831-91	CERAMIC CHIP 0.001UF	2% 50V	D9601	6-501-614-01	DIODE PZU5.6B2	
C9820	1-100-831-91	CERAMIC CHIP 0.001UF	2% 50V				
C9821	1-100-831-91	CERAMIC CHIP 0.001UF	2% 50V	D9602	6-502-318-01	DI MA4J1130GLS0	
C9822	1-100-831-91	CERAMIC CHIP 0.001UF	2% 50V	D9603	6-502-574-01	DI MALH120YGLS0	
C9823	1-100-831-91	CERAMIC CHIP 0.001UF	2% 50V	D9604	6-502-574-01	DI MALH120YGLS0	
				D9605	6-502-574-01	DI MALH120YGLS0	
				D9606	6-502-574-01	DI MALH120YGLS0	
C9824	1-100-831-91	CERAMIC CHIP 0.001UF	2% 50V				
C9825	1-114-813-11	CERAMIC CHIP 1UF	10% 16V				
C9826	1-114-813-11	CERAMIC CHIP 1UF	10% 16V	D9607	6-501-754-01	DIODE MAZ8091G0LS0	
C9827	1-112-781-11	CERAMIC CHIP 1UF	10% 10V	D9609	6-502-574-01	DI MALH120YGLS0	
C9828	1-112-781-11	CERAMIC CHIP 1UF	10% 10V	D9610	6-502-574-01	DI MALH120YGLS0	
				D9612	6-501-754-01	DIODE MAZ8091G0LS0	
				D9613	6-501-754-01	DIODE MAZ8091G0LS0	
C9839	1-100-916-11	CERAMIC CHIP 0.1UF	10% 16V				
C9840	1-114-331-11	CERAMIC CHIP 4.7UF	10% 10V				
C9841	1-100-909-11	CERAMIC CHIP 10UF	10% 6.3V	D9614	6-502-574-01	DI MALH120YGLS0	
C9842	1-100-909-11	CERAMIC CHIP 10UF	10% 6.3V	D9615	6-502-574-01	DI MALH120YGLS0	
C9843	1-114-410-21	CERAMIC CHIP 680PF	2% 50V	D9807	6-502-574-01	DI MALH120YGLS0	
				D9808	6-502-574-01	DI MALH120YGLS0	
				D9809	6-502-574-01	DI MALH120YGLS0	
		< CONNECTOR >					
CN1300	1-819-797-11	HEADER ASSEMBLY FOR PWB 13P		D9810	6-502-574-01	DI MALH120YGLS0	
CN1301	1-819-476-11	HEADER ASSEMBLY FOR PWB 8P		D9811	6-501-770-01	DIODE MAZ8130G0LS0	
CN2000	1-821-180-11	MEMORY STICK CONNECTOR		D9812	6-501-754-01	DIODE MAZ8091G0LS0	
CN3500	1-822-537-12	ETHERNET CONNECTOR		D9813	6-501-754-01	DIODE MAZ8091G0LS0	
CN3501	1-821-834-12	USB CONNECTOR		D9814	6-501-754-01	DIODE MAZ8091G0LS0	
CN3800	1-822-579-12	CARD CONNECTOR (PCMCIA CARD)		D9815	6-501-754-01	DIODE MAZ8091G0LS0	
CN4501	1-822-656-11	HEADER ASSEMBLY FOR PWB 51P		D9816	6-501-754-01	DIODE MAZ8091G0LS0	
CN5502	1-779-936-51	CONNECTOR, FFC/FPC 18P		D9817	6-501-754-01	DIODE MAZ8091G0LS0	
CN5503	1-820-235-11	HEADER ASSEMBLY 30P		D9818	6-502-574-01	DI MALH120YGLS0	
CN7201	1-819-461-11	HEADER ASSEMBLY FOR PWB 4P		D9819	6-502-574-01	DI MALH120YGLS0	
CN7600	1-822-483-11	HDMI CONNECTOR		D9820	6-502-574-01	DI MALH120YGLS0	
CN7601	1-822-483-11	HDMI CONNECTOR		D9821	6-502-574-01	DI MALH120YGLS0	
CN7602	1-822-485-11	HDMI CONNECTOR		D9822	6-501-770-01	DIODE MAZ8130G0LS0	
CN7603	1-822-485-11	HDMI CONNECTOR		D9823	6-501-754-01	DIODE MAZ8091G0LS0	
CN9600	1-821-827-21	D SUB CONNECTOR		D9824	6-501-754-01	DIODE MAZ8091G0LS0	
				D9825	6-501-754-01	DIODE MAZ8091G0LS0	
CN9602	1-822-525-11	OPTICAL OUT CONNECTOR		D9826	6-501-754-01	DIODE MAZ8091G0LS0	
CN9803	1-822-580-11	CONNECTOR DUAL SCART		D9827	6-501-754-01	DIODE MAZ8091G0LS0	

**Note :** The components identified by shading and marked  $\Delta$  are critical for safety. Replace only with the part numbers specified in the parts list.



REF.NO.	PART.NO	DESCRIPTION	REMARK	REF.NO.	PART.NO	DESCRIPTION	REMARK
D9828	6-501-754-01	DIODE MAZ8091G0LS0		FB5001	1-400-462-21	FERRITE	OUH
D9829	6-501-754-01	DIODE MAZ8091G0LS0		FB5500	1-500-922-11	FERRITE	OUH
D9832	6-502-574-01	DI MALH120YGLS0		FB5501	1-500-922-11	FERRITE	OUH
D9833	6-502-574-01	DI MALH120YGLS0		FB5502	1-500-922-11	FERRITE	OUH
D9835	6-501-754-01	DIODE MAZ8091G0LS0		FB7001	1-481-517-11	FERRITE	OUH
D9839	6-501-754-01	DIODE MAZ8091G0LS0		FB7201	1-400-089-21	FERRITE	OUH
D9840	6-501-754-01	DIODE MAZ8091G0LS0		FB7202	1-400-089-21	FERRITE	OUH
ET2000	1-780-638-21	CONTACT TERMINAL		FB7203	1-400-089-21	FERRITE	OUH
ET2001	1-780-638-21	CONTACT TERMINAL		FB7204	1-400-089-21	FERRITE	OUH
ET2002	1-780-638-21	CONTACT TERMINAL		FB7900	1-469-869-21	FERRITE	OUH
ET2003	1-780-638-21	CONTACT TERMINAL		FB7901	1-400-834-11	FERRITE	OUH
ET2004	1-780-638-21	CONTACT TERMINAL		FB7902	1-400-834-11	FERRITE	OUH
ET2005	1-780-638-21	CONTACT TERMINAL		FB7903	1-400-834-11	FERRITE	OUH
ET2006	1-780-638-21	CONTACT TERMINAL		FB7904	1-400-834-11	FERRITE	OUH
ET2007	1-780-317-11	TERMINAL		FB7905	1-400-834-11	FERRITE	OUH
< FUSE >				FB7906	1-400-834-11	FERRITE	OUH
F1000	$\Delta$ 1-576-603-11	FUSE	3.15A 24V	FB7907	1-400-834-11	FERRITE	OUH
F1300	$\Delta$ 1-576-603-11	FUSE	3.15A 24V	FB7908	1-400-834-11	FERRITE	OUH
F1301	$\Delta$ 1-576-603-11	FUSE	3.15A 24V	FB7909	1-400-834-11	FERRITE	OUH
F3000	$\Delta$ 1-576-603-11	FUSE	3.15A 24V	FB7910	1-400-834-11	FERRITE	OUH
F4200	$\Delta$ 1-576-406-11	FUSE	1.4A 32V	FB7911	1-400-834-11	FERRITE	OUH
F7001	$\Delta$ 1-576-913-11	FUSE	1.6A 36V	FB7917	1-400-462-21	FERRITE	OUH
F7201	$\Delta$ 1-576-933-21	FUSE	5A 24V	FB7918	1-400-462-21	FERRITE	OUH
F7401	$\Delta$ 1-576-646-11	FUSE	0.5A 50V	FB7919	1-400-461-21	FERRITE	OUH
F7900	$\Delta$ 1-576-646-11	FUSE	0.5A 50V	FB7920	1-400-461-21	FERRITE	OUH
F7902	$\Delta$ 1-576-406-11	FUSE	1.4A 32V	FB9804	1-400-461-21	FERRITE	OUH
F9600	$\Delta$ 1-576-646-11	FUSE	0.5A 50V	FB9805	1-400-461-21	FERRITE	OUH
F9800	$\Delta$ 1-576-406-11	FUSE	1.4A 32V	FB9806	1-400-461-21	FERRITE	OUH
< FERRITE BEAD >				FB9807	1-400-461-21	FERRITE	OUH
FB1000	1-481-515-11	FERRITE	OUH	< FILTER >			
FB1302	1-400-834-11	FERRITE	OUH	FL4500	1-234-494-21	FILTER, EMI REMOVAL (SMD)	
FB1303	1-400-834-11	FERRITE	OUH	FL4501	1-200-014-21	FILTER, EMI REMOVAL (SMD)	
FB1305	1-400-834-11	FERRITE	OUH	FL7600	1-234-939-21	FILTER, EMI REMOVAL (SMD)	
FB1309	1-400-834-11	FERRITE	OUH	< IC >			
FB1310	1-400-089-21	FERRITE	OUH	IC1000	6-713-863-01	IC BD9540EFV-E2	
FB2000	1-400-461-21	FERRITE	OUH	IC1001	6-711-047-01	IC S-1132B18-U5T1G	
FB2001	1-400-461-21	FERRITE	OUH	IC1002	6-710-941-01	IC MM3141ZNR(1.07V)	
FB3502	1-481-466-11	FERRITE	OUH	IC1003	6-711-238-01	IC NJM2878F3-15 (TE2)	
FB3503	1-481-466-11	FERRITE	OUH	IC1004	6-711-237-01	IC NJM2878F3-33 (TE2)	
FB3504	1-481-466-11	FERRITE	OUH	IC1308	6-714-032-01	IC BD9321EFJ-E2	
FB3505	1-481-466-11	FERRITE	OUH	IC2003	6-712-397-01	IC 74AHC1G08GW-125	
FB3506	1-481-466-11	FERRITE	OUH	IC2501	6-713-835-01	IC K9F1208U0C-PIB0T	
FB3800	1-481-517-11	FERRITE	OUH	IC2502	6-713-835-01	IC K9F1208U0C-PIB0T	
FB4000	1-400-462-21	FERRITE	OUH	IC3001	6-710-949-01	IC SN0608006PWPR	
FB4001	1-400-462-21	FERRITE	OUH	IC3002	6-713-800-01	IC K4T1G164QE-HCE7T	
FB4002	1-400-462-21	FERRITE	OUH	IC3003	6-713-838-01	IC EDE1116AEBG-8E-F-TR	
FB5000	1-400-462-21	FERRITE	OUH	IC3500	6-712-775-11	IC KSZ8041TLTR	
				IC3502	6-711-288-01	IC MIC2005-0.5YM6TR	

REF.NO.	PART.NO	DESCRIPTION	REMARK	REF.NO.	PART.NO	DESCRIPTION	REMARK
IC3801	6-711-471-01	IC TC74LCX245FK (EL,K)		L4401	1-481-521-11	INDUCTOR	1UH
IC3804	6-711-471-01	IC TC74LCX245FK (EL,K)		L4514	1-481-521-11	INDUCTOR	1UH
IC3805	6-711-471-01	IC TC74LCX245FK (EL,K)		L4515	1-457-539-11	INDUCTOR	0UH
IC3806	6-711-471-01	IC TC74LCX245FK (EL,K)		L4516	1-457-539-11	INDUCTOR	0UH
IC3807	6-711-471-01	IC TC74LCX245FK (EL,K)		L4517	1-457-539-11	INDUCTOR	0UH
IC3808	6-711-471-01	IC TC74LCX245FK (EL,K)		L4518	1-457-539-11	INDUCTOR	0UH
IC3809	6-711-471-01	IC TC74LCX245FK (EL,K)		L4519	1-457-539-11	INDUCTOR	0UH
IC3810	6-711-288-01	IC MIC2005-0.5YM6TR		L4520	1-457-539-11	INDUCTOR	0UH
IC4200	8-753-289-76	IC CXA2241Q-T4		L7002	1-481-524-11	INDUCTOR	10UH
IC4400	6-708-641-11	IC SAA7115AHL/V1,518		L7201	1-457-754-11	INDUCTOR	22UH
IC5500	6-713-333-01	IC PST8429UL		L7204	1-457-754-11	INDUCTOR	22UH
IC5501	6-711-047-01	IC S-1132B18-U5T1G		L7302	1-481-524-11	INDUCTOR	10UH
IC5502	6-713-820-01	IC MB91F313APMC-GE1		L7303	1-481-524-11	INDUCTOR	10UH
IC5503	6-710-786-01	IC TC7SH125FU (T5RSOYF)		L7401	1-481-524-11	INDUCTOR	10UH
IC5504	6-710-786-01	IC TC7SH125FU (T5RSOYF)		L7600	1-456-844-11	INDUCTOR	0UH
IC5505	6-704-573-01	IC M24C32-WMN6T (B)		L7601	1-456-844-11	INDUCTOR	0UH
IC5506	6-713-333-01	IC PST8429UL		L7602	1-456-844-11	INDUCTOR	0UH
IC5507	6-713-836-01	IC LM75BD		L7603	1-456-844-11	INDUCTOR	0UH
IC5508	6-706-482-01	IC TC7SH00FU (T5RSOYJF)		L7604	1-456-844-11	INDUCTOR	0UH
IC7001	6-706-489-01	IC TC7SH32FU (T5RSOYJF)		L7605	1-456-844-11	INDUCTOR	0UH
IC7003	6-712-974-01	IC CXD9926ATQ		L7606	1-456-844-11	INDUCTOR	0UH
IC7201	6-713-875-01	IC TAS5602DCAR		L7607	1-456-844-11	INDUCTOR	0UH
IC7301	8-753-314-50	IC CXA3785R-T6		L7901	1-469-549-21	INDUCTOR	1UH
IC7401	6-713-862-01	IC AK4388AET-E2		L7902	1-400-791-21	INDUCTOR	10UH
IC7453	6-711-237-01	IC NJM2878F3-33 (TE2)		L7903	1-412-990-41	INDUCTOR	8.2UH
IC7600	8-753-310-83	IC CXB1447R-T6		L7904	1-400-791-21	INDUCTOR	10UH
IC7601	6-704-600-01	IC M24C02-WMN6T (B)		L7905	1-400-791-21	INDUCTOR	10UH
IC7900	6-709-257-01	IC 74LVC4066PW		L7906	1-400-791-21	INDUCTOR	10UH
IC7902	6-711-132-01	IC MM3291CNRE		L7907	1-400-791-21	INDUCTOR	10UH
IC7903	6-709-607-01	IC LA5795T-TLM-E		L7913	1-469-555-21	INDUCTOR	10UH
IC7904	8-759-338-95	IC NJM2903V (TE2)		L9600	1-400-177-21	FERRITE	0UH
IC7905	6-710-532-01	IC NJM2878F4-25 (TE2)		L9800	1-469-557-21	INDUCTOR	22UH
IC9600	6-704-600-01	IC M24C02-WMN6T (B)		L9801	1-481-329-21	INDUCTOR	100NH
IC9601	6-708-132-01	IC 74LVC14APW		L9802	1-481-329-21	INDUCTOR	100NH
< SOCKET >				< TRANSISTOR >			
J9600	1-822-524-31	PHONO JACK 2P		Q1000	6-550-354-01	TRANSISTOR RTQ035P02TR	
J9601	1-822-528-11	JACK		Q1001	6-551-815-01	TR UNR52A1G0LS0	
J9605	1-822-581-11	MULTIPLE PHONO JACK 4P		Q1002	6-552-215-01	TR RRS100N03FPFTB1	
J9800	1-822-523-11	PHONO JACK 5P		Q1003	6-552-215-01	TR RRS100N03FPFTB1	
< COIL >				Q1004	6-552-212-01	TR MP6K61FU7TR	
L1002	1-457-714-11	INDUCTOR	4.7UH	Q1304	6-551-690-01	TRANSISTOR RT3N11M-TP-1	
L1003	1-457-744-11	INDUCTOR	1.5UH	Q1309	8-729-907-00	TRANSISTOR DTC114EU	
L1307	1-457-455-11	INDUCTOR	10UH	Q1312	6-550-369-01	TRANSISTOR TPC8109 (TE12L)	
L1308	1-424-918-21	INDUCTOR	10UH	Q1420	6-551-690-01	TRANSISTOR RT3N11M-TP-1	
L3000	1-457-730-11	INDUCTOR	2.2UH	Q2500	6-551-775-01	TR 2SA2122G0LS0	
L3500	1-457-223-11	INDUCTOR	0UH	Q2501	6-551-815-01	TR UNR52A1G0LS0	
L4001	1-469-556-21	INDUCTOR	15UH	Q3000	6-552-212-01	TR MP6K61FU7TR	
L4200	1-469-557-21	INDUCTOR	22UH	Q4000	8-729-026-53	TRANSISTOR 2SA1576A-T106-QR	
				Q4031	6-551-775-01	TR 2SA2122G0LS0	



REF.NO.	PART.NO	DESCRIPTION	REMARK	REF.NO.	PART.NO	DESCRIPTION	REMARK
Q4200	6-551-903-01	TR RT3S02M-T111-1		R1008	1-218-953-11	METAL CHIP 1K 5%	1/16W
Q4201	6-551-903-01	TR RT3S02M-T111-1		R1009	1-218-974-11	METAL CHIP 56K 5%	1/16W
Q4202	6-551-903-01	TR RT3S02M-T111-1		R1300	1-218-990-81	SHORT CHIP 0	
Q4401	6-551-321-01	TRANSISTOR RT3WLMM-TP-1F		R1301	1-218-990-81	SHORT CHIP 0	
Q5500	6-551-775-01	TR 2SA2122G0LS0		R1303	1-218-965-11	METAL CHIP 10K 5%	1/16W
Q5501	6-551-815-01	TR UNR52A1G0LS0		R1304	1-218-969-11	METAL CHIP 22K 5%	1/16W
Q5503	6-551-825-01	TR UNR52A5G0LS0		R1311	1-218-990-81	SHORT CHIP 0	
Q5504	6-551-321-01	TRANSISTOR RT3WLMM-TP-1F		R1313	1-218-957-11	METAL CHIP 2.2K 5%	1/16W
Q5507	6-551-815-01	TR UNR52A1G0LS0		R1317	1-208-911-11	METAL CHIP 10K 0.5%	1/16W
Q5510	6-551-824-01	TR UNR51A5G0LS0		R1321	1-218-965-11	METAL CHIP 10K 5%	1/16W
Q5512	6-552-110-01	TR UNR52AMG0LS0		R1322	1-218-965-11	METAL CHIP 10K 5%	1/16W
Q7201	6-551-969-01	TR RT3P55M-TP-1		R1324	1-218-965-11	METAL CHIP 10K 5%	1/16W
Q7302	6-551-551-01	TRANSISTOR RT3N77M-TP-1		R1328	1-218-941-81	METAL CHIP 100 5%	1/16W
Q7303	6-551-943-01	TR RT3XBBM-T111-1		R1331	1-218-983-11	METAL CHIP 330K 5%	1/16W
Q7304	6-551-551-01	TRANSISTOR RT3N77M-TP-1		R1362	1-208-931-11	METAL CHIP 68K 0.5%	1/16W
Q7305	6-551-551-01	TRANSISTOR RT3N77M-TP-1		R1363	1-218-977-11	METAL CHIP 100K 5%	1/16W
Q7306	6-551-943-01	TR RT3XBBM-T111-1		R1405	1-218-990-81	SHORT CHIP 0	
Q7307	6-551-943-01	TR RT3XBBM-T111-1		R1406	1-218-965-11	METAL CHIP 10K 5%	1/16W
Q7308	6-551-691-01	TRANSISTOR RT3P11M-TP-1		R1407	1-208-699-11	METAL CHIP 4.7K 0.5%	1/16W
Q7309	6-551-943-01	TR RT3XBBM-T111-1		R1408	1-208-709-11	METAL CHIP 12K 0.5%	1/16W
Q7901	6-551-904-01	TR RT3S03M-T111-1		R1410	1-208-911-11	METAL CHIP 10K 0.5%	1/16W
Q7902	6-551-904-01	TR RT3S03M-T111-1		R1420	1-218-977-11	METAL CHIP 100K 5%	1/16W
Q7903	6-551-775-01	TR 2SA2122G0LS0		R2001	1-218-941-81	METAL CHIP 100 5%	1/16W
Q7905	6-551-775-01	TR 2SA2122G0LS0		R2002	1-218-937-11	METAL CHIP 47 5%	1/16W
Q7906	6-551-775-01	TR 2SA2122G0LS0		R2008	1-218-965-11	METAL CHIP 10K 5%	1/16W
Q7907	6-550-871-01	TRANSISTOR 2SA2048TL QR		R2010	1-218-990-81	SHORT CHIP 0	
Q7908	6-550-871-01	TRANSISTOR 2SA2048TL QR		R2011	1-218-937-11	METAL CHIP 47 5%	1/16W
Q7909	6-551-776-01	TR 2SC5950G0LS0		R2012	1-218-965-11	METAL CHIP 10K 5%	1/16W
Q7910	6-551-776-01	TR 2SC5950G0LS0		R2017	1-218-937-11	METAL CHIP 47 5%	1/16W
Q7911	6-551-825-01	TR UNR52A5G0LS0		R2021	1-218-941-81	METAL CHIP 100 5%	1/16W
Q7914	6-551-904-01	TR RT3S03M-T111-1		R2035	1-218-941-81	METAL CHIP 100 5%	1/16W
Q7915	6-551-776-01	TR 2SC5950G0LS0		R2040	1-218-937-11	METAL CHIP 47 5%	1/16W
Q7916	6-551-776-01	TR 2SC5950G0LS0		R2041	1-218-937-11	METAL CHIP 47 5%	1/16W
Q7917	6-551-775-01	TR 2SA2122G0LS0		R2043	1-218-939-11	METAL CHIP 68 5%	1/16W
Q7919	6-551-815-01	TR UNR52A1G0LS0		R2045	1-218-965-11	METAL CHIP 10K 5%	1/16W
Q9601	6-551-815-01	TR UNR52A1G0LS0		R2046	1-218-965-11	METAL CHIP 10K 5%	1/16W
Q9806	6-551-776-01	TR 2SC5950G0LS0		R2047	1-218-957-11	METAL CHIP 2.2K 5%	1/16W
Q9812	6-551-776-01	TR 2SC5950G0LS0		R2048	1-218-965-11	METAL CHIP 10K 5%	1/16W
Q9813	6-551-272-01	TRANSISTOR RT3CLLM		R2049	1-218-957-11	METAL CHIP 2.2K 5%	1/16W
Q9814	6-551-272-01	TRANSISTOR RT3CLLM		R2050	1-218-961-11	METAL CHIP 4.7K 5%	1/16W
< RESISTOR >				R2051	1-218-961-11	METAL CHIP 4.7K 5%	1/16W
R1000	1-218-965-11	METAL CHIP 10K 5%	1/16W	R2056	1-218-965-11	METAL CHIP 10K 5%	1/16W
R1001	1-218-985-11	METAL CHIP 470K 5%	1/16W	R2057	1-218-965-11	METAL CHIP 10K 5%	1/16W
R1002	1-208-711-11	METAL CHIP 15K 0.5%	1/16W	R2067	1-218-965-11	METAL CHIP 10K 5%	1/16W
R1003	1-208-698-11	METAL CHIP 4.3K 0.5%	1/16W	R2069	1-218-965-11	METAL CHIP 10K 5%	1/16W
R1004	1-208-911-11	METAL CHIP 10K 0.5%	1/16W	R2071	1-218-965-11	METAL CHIP 10K 5%	1/16W
R1005	1-208-698-11	METAL CHIP 4.3K 0.5%	1/16W	R2076	1-218-965-11	METAL CHIP 10K 5%	1/16W
R1006	1-218-965-11	METAL CHIP 10K 5%	1/16W	R2086	1-208-883-81	METAL CHIP 680 0.5%	1/16W
R1007	1-218-978-11	METAL CHIP 120K 5%	1/16W	R2087	1-208-683-11	METAL CHIP 1K 0.5%	1/16W
				R2088	1-208-687-11	METAL CHIP 1.5K 0.5%	1/16W

REF.NO.	PART.NO	DESCRIPTION	REMARK	REF.NO.	PART.NO	DESCRIPTION	REMARK
R2100	1-218-937-11	METAL CHIP	47 5% 1/16W	R3050	1-208-663-11	METAL CHIP	150 0.5% 1/16W
R2138	1-218-937-11	METAL CHIP	47 5% 1/16W	R3051	1-208-663-11	METAL CHIP	150 0.5% 1/16W
R2139	1-218-937-11	METAL CHIP	47 5% 1/16W	R3052	1-208-911-11	METAL CHIP	10K 0.5% 1/16W
R2140	1-218-965-11	METAL CHIP	10K 5% 1/16W	R3053	1-208-911-11	METAL CHIP	10K 0.5% 1/16W
R2141	1-218-937-11	METAL CHIP	47 5% 1/16W	R3054	1-208-911-11	METAL CHIP	10K 0.5% 1/16W
R2142	1-218-937-11	METAL CHIP	47 5% 1/16W	R3055	1-208-911-11	METAL CHIP	10K 0.5% 1/16W
R2143	1-218-965-11	METAL CHIP	10K 5% 1/16W	R3057	1-218-990-81	SHORT CHIP	0
R2144	1-218-965-11	METAL CHIP	10K 5% 1/16W	R3060	1-218-965-11	METAL CHIP	10K 5% 1/16W
R2145	1-218-990-81	SHORT CHIP	0	R3061	1-208-711-11	METAL CHIP	15K 0.5% 1/16W
R2146	1-218-990-81	SHORT CHIP	0	R3501	1-218-941-11	METAL CHIP	100 5% 1/16W
R2147	1-218-990-81	SHORT CHIP	0	R3502	1-218-941-11	METAL CHIP	100 5% 1/16W
R2148	1-218-990-81	SHORT CHIP	0	R3503	1-218-941-11	METAL CHIP	100 5% 1/16W
R2149	1-218-990-81	SHORT CHIP	0	R3504	1-218-941-11	METAL CHIP	100 5% 1/16W
R2150	1-218-990-81	SHORT CHIP	0	R3505	1-218-941-11	METAL CHIP	100 5% 1/16W
R2151	1-218-990-81	SHORT CHIP	0	R3506	1-218-941-11	METAL CHIP	100 5% 1/16W
R2152	1-218-990-81	SHORT CHIP	0	R3507	1-218-941-11	METAL CHIP	100 5% 1/16W
R2506	1-218-937-11	METAL CHIP	47 5% 1/16W	R3508	1-218-941-11	METAL CHIP	100 5% 1/16W
R2510	1-218-937-11	METAL CHIP	47 5% 1/16W	R3510	1-208-703-11	METAL CHIP	6.8K 0.5% 1/16W
R2514	1-218-937-11	METAL CHIP	47 5% 1/16W	R3511	1-218-939-11	METAL CHIP	68 5% 1/16W
R2517	1-218-933-11	METAL CHIP	22 5% 1/16W	R3512	1-218-937-11	METAL CHIP	47 5% 1/16W
R2518	1-218-933-11	METAL CHIP	22 5% 1/16W	R3513	1-218-978-11	METAL CHIP	120K 5% 1/16W
R2519	1-218-933-11	METAL CHIP	22 5% 1/16W	R3518	1-218-961-11	METAL CHIP	4.7K 5% 1/16W
R2530	1-218-965-11	METAL CHIP	10K 5% 1/16W	R3524	1-218-953-11	METAL CHIP	1K 5% 1/16W
R2579	1-218-937-11	METAL CHIP	47 5% 1/16W	R3525	1-218-961-11	METAL CHIP	4.7K 5% 1/16W
R2580	1-218-937-11	METAL CHIP	47 5% 1/16W	R3528	1-218-953-11	METAL CHIP	1K 5% 1/16W
R2605	1-218-965-11	METAL CHIP	10K 5% 1/16W	R3530	1-218-953-11	METAL CHIP	1K 5% 1/16W
R2608	1-218-965-11	METAL CHIP	10K 5% 1/16W	R3534	1-218-953-11	METAL CHIP	1K 5% 1/16W
R2612	1-218-965-11	METAL CHIP	10K 5% 1/16W	R3536	1-218-953-11	METAL CHIP	1K 5% 1/16W
R2616	1-218-949-11	METAL CHIP	470 5% 1/16W	R3541	1-220-884-81	METAL CHIP	39 0.5% 1/16W
R2657	1-218-965-11	METAL CHIP	10K 5% 1/16W	R3542	1-220-884-81	METAL CHIP	39 0.5% 1/16W
R2674	1-218-965-11	METAL CHIP	10K 5% 1/16W	R3544	1-208-688-11	METAL CHIP	1.6K 0.5% 1/16W
R2675	1-218-965-11	METAL CHIP	10K 5% 1/16W	R3545	1-218-967-11	METAL CHIP	15K 5% 1/16W
R2704	1-218-953-11	METAL CHIP	1K 5% 1/16W	R3546	1-218-967-11	METAL CHIP	15K 5% 1/16W
R2705	1-218-965-11	METAL CHIP	10K 5% 1/16W	R3558	1-218-937-11	METAL CHIP	47 5% 1/16W
R2706	1-218-961-11	METAL CHIP	4.7K 5% 1/16W	R3561	1-218-937-11	METAL CHIP	47 5% 1/16W
R2707	1-218-937-11	METAL CHIP	47 5% 1/16W	R3803	1-218-965-11	METAL CHIP	10K 5% 1/16W
R2709	1-218-941-81	METAL CHIP	100 5% 1/16W	R3806	1-218-965-11	METAL CHIP	10K 5% 1/16W
R3000	1-208-911-11	METAL CHIP	10K 0.5% 1/16W	R3807	1-218-965-11	METAL CHIP	10K 5% 1/16W
R3001	1-208-911-11	METAL CHIP	10K 0.5% 1/16W	R3809	1-218-965-11	METAL CHIP	10K 5% 1/16W
R3002	1-208-663-11	METAL CHIP	150 0.5% 1/16W	R3810	1-218-937-11	METAL CHIP	47 5% 1/16W
R3003	1-208-663-11	METAL CHIP	150 0.5% 1/16W	R3811	1-218-965-11	METAL CHIP	10K 5% 1/16W
R3009	1-218-933-11	METAL CHIP	22 5% 1/16W	R3812	1-218-965-11	METAL CHIP	10K 5% 1/16W
R3010	1-218-990-81	SHORT CHIP	0	R3813	1-218-965-11	METAL CHIP	10K 5% 1/16W
R3011	1-218-990-81	SHORT CHIP	0	R3814	1-218-941-81	METAL CHIP	100 5% 1/16W
R3013	1-218-965-11	METAL CHIP	10K 5% 1/16W	R3815	1-218-941-81	METAL CHIP	100 5% 1/16W
R3038	1-218-929-11	METAL CHIP	10 5% 1/16W	R3816	1-218-941-81	METAL CHIP	100 5% 1/16W
R3044	1-208-860-81	METAL CHIP	75 0.5% 1/16W	R3817	1-218-965-11	METAL CHIP	10K 5% 1/16W
R3045	1-208-860-81	METAL CHIP	75 0.5% 1/16W	R3818	1-218-965-11	METAL CHIP	10K 5% 1/16W
R3046	1-208-860-81	METAL CHIP	75 0.5% 1/16W	R3819	1-218-965-11	METAL CHIP	10K 5% 1/16W
R3047	1-208-860-81	METAL CHIP	75 0.5% 1/16W	R3820	1-218-953-11	METAL CHIP	1K 5% 1/16W

REF.NO.	PART.NO	DESCRIPTION	REMARK			REF.NO.	PART.NO	DESCRIPTION	REMARK		
R3821	1-218-937-11	METAL CHIP	47	5%	1/16W	R4153	1-208-683-11	METAL CHIP	1K	0.5%	1/16W
R3822	1-218-953-11	METAL CHIP	1K	5%	1/16W	R4154	1-218-990-81	SHORT CHIP	0		
R3823	1-218-965-11	METAL CHIP	10K	5%	1/16W	R4200	1-218-990-81	SHORT CHIP	0		
R4001	1-218-990-81	SHORT CHIP	0			R4201	1-218-941-81	METAL CHIP	100	5%	1/16W
R4002	1-218-990-81	SHORT CHIP	0			R4202	1-218-990-81	SHORT CHIP	0		
R4003	1-218-941-81	METAL CHIP	100	5%	1/16W	R4203	1-218-962-11	METAL CHIP	5.6K	5%	1/16W
R4004	1-218-945-11	METAL CHIP	220	5%	1/16W	R4204	1-218-962-11	METAL CHIP	5.6K	5%	1/16W
R4005	1-220-177-81	METAL CHIP	360	5%	1/16W	R4205	1-218-941-81	METAL CHIP	100	5%	1/16W
R4006	1-218-990-81	SHORT CHIP	0			R4207	1-218-965-11	METAL CHIP	10K	5%	1/16W
R4008	1-218-943-11	METAL CHIP	150	5%	1/16W	R4208	1-218-965-11	METAL CHIP	10K	5%	1/16W
R4010	1-208-635-11	METAL CHIP	10	0.5%	1/16W	R4216	1-218-990-81	SHORT CHIP	0		
R4011	1-208-635-11	METAL CHIP	10	0.5%	1/16W	R4217	1-218-965-11	METAL CHIP	10K	5%	1/16W
R4012	1-208-635-11	METAL CHIP	10	0.5%	1/16W	R4218	1-218-965-11	METAL CHIP	10K	5%	1/16W
R4013	1-218-939-11	METAL CHIP	68	5%	1/16W	R4401	1-208-889-11	METAL CHIP	1.2K	0.5%	1/16W
R4014	1-218-939-11	METAL CHIP	68	5%	1/16W	R4402	1-218-990-81	SHORT CHIP	0		
R4015	1-218-939-11	METAL CHIP	68	5%	1/16W	R4403	1-218-958-11	METAL CHIP	2.7K	5%	1/16W
R4042	1-218-949-11	METAL CHIP	470	5%	1/16W	R4405	1-208-677-11	METAL CHIP	560	0.5%	1/16W
R4043	1-218-990-81	SHORT CHIP	0			R4407	1-218-990-81	SHORT CHIP	0		
R4047	1-218-990-81	SHORT CHIP	0			R4409	1-218-990-81	SHORT CHIP	0		
R4049	1-218-990-81	SHORT CHIP	0			R4411	1-218-933-11	METAL CHIP	22	5%	1/16W
R4070	1-218-938-11	METAL CHIP	56	5%	1/16W	R4417	1-218-990-81	SHORT CHIP	0		
R4072	1-218-939-11	METAL CHIP	68	5%	1/16W	R4418	1-218-990-81	SHORT CHIP	0		
R4074	1-218-939-11	METAL CHIP	68	5%	1/16W	R4420	1-218-937-11	METAL CHIP	47	5%	1/16W
R4091	1-208-855-81	METAL CHIP	47	0.5%	1/16W	R4421	1-218-937-11	METAL CHIP	47	5%	1/16W
R4093	1-208-855-81	METAL CHIP	47	0.5%	1/16W	R4422	1-216-295-91	SHORT CHIP	0		
R4095	1-208-855-81	METAL CHIP	47	0.5%	1/16W	R4505	1-208-893-11	METAL CHIP	1.8K	0.5%	1/16W
R4097	1-208-855-81	METAL CHIP	47	0.5%	1/16W	R4506	1-208-635-11	METAL CHIP	10	0.5%	1/16W
R4099	1-208-855-81	METAL CHIP	47	0.5%	1/16W	R4507	1-218-990-81	SHORT CHIP	0		
R4101	1-208-855-81	METAL CHIP	47	0.5%	1/16W	R4512	1-216-864-11	SHORT CHIP	0		
R4102	1-208-687-11	METAL CHIP	1.5K	0.5%	1/16W	R4513	1-216-864-11	SHORT CHIP	0		
R4103	1-208-687-11	METAL CHIP	1.5K	0.5%	1/16W	R4514	1-242-967-81	METAL CHIP	1	5%	1/16W
R4119	1-218-990-81	SHORT CHIP	0			R4517	1-208-635-11	METAL CHIP	10	0.5%	1/16W
R4120	1-218-990-81	SHORT CHIP	0			R4518	1-218-990-81	SHORT CHIP	0		
R4121	1-218-941-81	METAL CHIP	100	5%	1/16W	R4525	1-218-941-81	METAL CHIP	100	5%	1/16W
R4122	1-218-941-81	METAL CHIP	100	5%	1/16W	R4527	1-218-990-81	SHORT CHIP	0		
R4123	1-208-643-11	METAL CHIP	22	0.5%	1/16W	R4528	1-218-990-81	SHORT CHIP	0		
R4124	1-208-635-11	METAL CHIP	10	0.5%	1/16W	R4530	1-218-990-81	SHORT CHIP	0		
R4125	1-208-635-11	METAL CHIP	10	0.5%	1/16W	R4532	1-218-990-81	SHORT CHIP	0		
R4126	1-220-880-81	METAL CHIP	27	0.5%	1/16W	R5020	1-218-937-11	METAL CHIP	47	5%	1/16W
R4127	1-220-880-81	METAL CHIP	27	0.5%	1/16W	R5023	1-218-937-11	METAL CHIP	47	5%	1/16W
R4128	1-220-880-81	METAL CHIP	27	0.5%	1/16W	R5024	1-218-937-11	METAL CHIP	47	5%	1/16W
R4129	1-220-880-81	METAL CHIP	27	0.5%	1/16W	R5025	1-218-937-11	METAL CHIP	47	5%	1/16W
R4130	1-220-880-81	METAL CHIP	27	0.5%	1/16W	R5051	1-218-937-11	METAL CHIP	47	5%	1/16W
R4131	1-220-880-81	METAL CHIP	27	0.5%	1/16W	R5500	1-208-703-11	METAL CHIP	6.8K	0.5%	1/16W
R4137	1-234-106-81	RES, NETWORK	0			R5501	1-208-935-11	METAL CHIP	100K	0.5%	1/16W
R4140	1-218-990-81	SHORT CHIP	0			R5502	1-208-695-11	METAL CHIP	3.3K	0.5%	1/16W
R4142	1-218-990-81	SHORT CHIP	0			R5503	1-218-961-11	METAL CHIP	4.7K	5%	1/16W
R4144	1-208-687-11	METAL CHIP	1.5K	0.5%	1/16W	R5504	1-218-965-11	METAL CHIP	10K	5%	1/16W
R4145	1-208-687-11	METAL CHIP	1.5K	0.5%	1/16W	R5507	1-218-977-11	METAL CHIP	100K	5%	1/16W
R4146	1-208-687-11	METAL CHIP	1.5K	0.5%	1/16W	R5508	1-218-965-11	METAL CHIP	10K	5%	1/16W





REF.NO.	PART.NO	DESCRIPTION	REMARK			REF.NO.	PART.NO	DESCRIPTION	REMARK		
R5510	1-218-949-11	METAL CHIP	470	5%	1/16W	R7010	1-218-990-81	SHORT CHIP	0		
R5511	1-218-937-11	METAL CHIP	47	5%	1/16W	R7014	1-218-990-81	SHORT CHIP	0		
R5512	1-218-937-11	METAL CHIP	47	5%	1/16W	R7017	1-218-953-11	METAL CHIP	1K	5%	1/16W
R5513	1-218-965-11	METAL CHIP	10K	5%	1/16W	R7018	1-218-990-81	SHORT CHIP	0		
R5514	1-218-965-11	METAL CHIP	10K	5%	1/16W	R7019	1-218-990-81	SHORT CHIP	0		
R5518	1-245-604-11	METAL CHIP	10M	5%	1/16W	R7020	1-218-990-81	SHORT CHIP	0		
R5519	1-218-941-81	METAL CHIP	100	5%	1/16W	R7024	1-220-199-81	METAL CHIP	24K	5%	1/16W
R5520	1-218-981-91	METAL CHIP	220K	5%	1/16W	R7025	1-218-990-81	SHORT CHIP	0		
R5521	1-208-911-11	METAL CHIP	10K	0.5%	1/16W	R7026	1-218-945-11	METAL CHIP	220	5%	1/16W
R5523	1-218-965-11	METAL CHIP	10K	5%	1/16W	R7027	1-218-945-11	METAL CHIP	220	5%	1/16W
R5526	1-218-965-11	METAL CHIP	10K	5%	1/16W	R7028	1-218-989-11	METAL CHIP	1M	5%	1/16W
R5529	1-208-683-11	METAL CHIP	1K	0.5%	1/16W	R7029	1-218-990-81	SHORT CHIP	0		
R5532	1-218-965-11	METAL CHIP	10K	5%	1/16W	R7030	1-218-990-81	SHORT CHIP	0		
R5534	1-208-691-11	METAL CHIP	2.2K	0.5%	1/16W	R7031	1-218-990-81	SHORT CHIP	0		
R5535	1-218-953-11	METAL CHIP	1K	5%	1/16W	R7034	1-218-990-81	SHORT CHIP	0		
R5536	1-218-990-81	SHORT CHIP	0			R7035	1-218-990-81	SHORT CHIP	0		
R5538	1-218-945-11	METAL CHIP	220	5%	1/16W	R7036	1-218-965-11	METAL CHIP	10K	5%	1/16W
R5540	1-208-711-11	METAL CHIP	15K	0.5%	1/16W	R7037	1-218-965-11	METAL CHIP	10K	5%	1/16W
R5542	1-208-703-11	METAL CHIP	6.8K	0.5%	1/16W	R7038	1-218-990-81	SHORT CHIP	0		
R5545	1-218-965-11	METAL CHIP	10K	5%	1/16W	R7201	1-218-990-81	SHORT CHIP	0		
R5546	1-208-931-11	METAL CHIP	68K	0.5%	1/16W	R7202	1-218-990-81	SHORT CHIP	0		
R5550	1-218-965-11	METAL CHIP	10K	5%	1/16W	R7204	1-218-990-81	SHORT CHIP	0		
R5552	1-218-965-11	METAL CHIP	10K	5%	1/16W	R7209	1-218-953-11	METAL CHIP	1K	5%	1/16W
R5553	1-218-965-11	METAL CHIP	10K	5%	1/16W	R7211	1-218-977-11	METAL CHIP	100K	5%	1/16W
R5554	1-218-965-11	METAL CHIP	10K	5%	1/16W	R7212	1-218-977-11	METAL CHIP	100K	5%	1/16W
R5555	1-218-965-11	METAL CHIP	10K	5%	1/16W	R7213	1-218-977-11	METAL CHIP	100K	5%	1/16W
R5559	1-218-937-11	METAL CHIP	47	5%	1/16W	R7214	1-218-977-11	METAL CHIP	100K	5%	1/16W
R5560	1-218-937-11	METAL CHIP	47	5%	1/16W	R7301	1-218-990-81	SHORT CHIP	0		
R5561	1-218-965-11	METAL CHIP	10K	5%	1/16W	R7302	1-218-990-81	SHORT CHIP	0		
R5562	1-218-965-11	METAL CHIP	10K	5%	1/16W	R7303	1-218-990-81	SHORT CHIP	0		
R5563	1-218-941-81	METAL CHIP	100	5%	1/16W	R7304	1-218-990-81	SHORT CHIP	0		
R5564	1-218-941-81	METAL CHIP	100	5%	1/16W	R7305	1-218-965-11	METAL CHIP	10K	5%	1/16W
R5567	1-218-941-81	METAL CHIP	100	5%	1/16W	R7313	1-218-990-81	SHORT CHIP	0		
R5568	1-218-941-81	METAL CHIP	100	5%	1/16W	R7314	1-218-990-81	SHORT CHIP	0		
R5569	1-218-965-11	METAL CHIP	10K	5%	1/16W	R7401	1-218-953-11	METAL CHIP	1K	5%	1/16W
R5570	1-218-953-11	METAL CHIP	1K	5%	1/16W	R7403	1-218-990-81	SHORT CHIP	0		
R5571	1-218-977-11	METAL CHIP	100K	5%	1/16W	R7404	1-218-990-81	SHORT CHIP	0		
R5572	1-218-977-11	METAL CHIP	100K	5%	1/16W	R7600	1-218-929-11	METAL CHIP	10	5%	1/16W
R5576	1-218-965-11	METAL CHIP	10K	5%	1/16W	R7601	1-218-929-11	METAL CHIP	10	5%	1/16W
R5577	1-218-965-11	METAL CHIP	10K	5%	1/16W	R7602	1-218-929-11	METAL CHIP	10	5%	1/16W
R5578	1-208-939-11	METAL CHIP	150K	0.5%	1/16W	R7603	1-208-683-11	METAL CHIP	1K	0.5%	1/16W
R5579	1-208-935-11	METAL CHIP	100K	0.5%	1/16W	R7604	1-208-683-11	METAL CHIP	1K	0.5%	1/16W
R5582	1-218-965-11	METAL CHIP	10K	5%	1/16W	R7605	1-208-683-11	METAL CHIP	1K	0.5%	1/16W
R5594	1-218-941-81	METAL CHIP	100	5%	1/16W	R7606	1-218-929-11	METAL CHIP	10	5%	1/16W
R5599	1-218-953-11	METAL CHIP	1K	5%	1/16W	R7607	1-208-683-11	METAL CHIP	1K	0.5%	1/16W
R5603	1-218-953-11	METAL CHIP	1K	5%	1/16W	R7608	1-218-941-81	METAL CHIP	100	5%	1/16W
R5604	1-218-990-81	SHORT CHIP	0			R7609	1-218-941-81	METAL CHIP	100	5%	1/16W
R5605	1-218-965-11	METAL CHIP	10K	5%	1/16W	R7610	1-218-941-81	METAL CHIP	100	5%	1/16W
R7002	1-218-990-81	SHORT CHIP	0			R7611	1-218-941-81	METAL CHIP	100	5%	1/16W
R7003	1-218-965-11	METAL CHIP	10K	5%	1/16W	R7612	1-218-961-11	METAL CHIP	4.7K	5%	1/16W

REF.NO.	PART.NO	DESCRIPTION	REMARK			REF.NO.	PART.NO	DESCRIPTION	REMARK		
R7613	1-218-973-11	METAL CHIP	47K	5%	1/16W	R7980	1-218-957-11	METAL CHIP	2.2K	5%	1/16W
R7621	1-218-965-11	METAL CHIP	10K	5%	1/16W	R7981	1-218-965-11	METAL CHIP	10K	5%	1/16W
R7622	1-218-990-81	SHORT CHIP	0			R7982	1-218-961-11	METAL CHIP	4.7K	5%	1/16W
R7624	1-218-970-11	METAL CHIP	27K	5%	1/16W	R7984	1-218-965-11	METAL CHIP	10K	5%	1/16W
R7625	1-218-941-81	METAL CHIP	100	5%	1/16W	R7985	1-218-965-11	METAL CHIP	10K	5%	1/16W
R7626	1-218-953-11	METAL CHIP	1K	5%	1/16W	R7992	1-208-671-11	METAL CHIP	330	0.5%	1/16W
R7627	1-218-953-11	METAL CHIP	1K	5%	1/16W	R7999	1-218-990-81	SHORT CHIP	0		
R7628	1-218-953-11	METAL CHIP	1K	5%	1/16W	R8003	1-218-990-81	SHORT CHIP	0		
R7634	1-218-965-11	METAL CHIP	10K	5%	1/16W	R8005	1-218-965-11	METAL CHIP	10K	5%	1/16W
R7902	1-218-941-81	METAL CHIP	100	5%	1/16W	R9600	1-218-990-81	SHORT CHIP	0		
R7905	1-218-957-11	METAL CHIP	2.2K	5%	1/16W	R9601	1-218-990-81	SHORT CHIP	0		
R7907	1-218-961-11	METAL CHIP	4.7K	5%	1/16W	R9602	1-218-990-81	SHORT CHIP	0		
R7908	1-218-961-11	METAL CHIP	4.7K	5%	1/16W	R9603	1-216-853-11	METAL CHIP	470K	5%	1/10W
R7910	1-208-943-11	METAL CHIP	220K	0.5%	1/16W	R9604	1-216-853-11	METAL CHIP	470K	5%	1/10W
R7911	1-218-989-11	METAL CHIP	1M	5%	1/16W	R9605	1-218-990-81	SHORT CHIP	0		
R7912	1-218-989-11	METAL CHIP	1M	5%	1/16W	R9606	1-218-990-81	SHORT CHIP	0		
R7914	1-218-957-11	METAL CHIP	2.2K	5%	1/16W	R9607	1-218-990-81	SHORT CHIP	0		
R7916	1-218-959-11	METAL CHIP	3.3K	5%	1/16W	R9610	1-218-990-81	SHORT CHIP	0		
R7917	1-218-990-81	SHORT CHIP	0			R9612	1-218-990-81	SHORT CHIP	0		
R7918	1-218-958-11	METAL CHIP	2.7K	5%	1/16W	R9614	1-218-990-81	SHORT CHIP	0		
R7919	1-208-697-11	METAL CHIP	3.9K	0.5%	1/16W	R9617	1-218-965-11	METAL CHIP	10K	5%	1/16W
R7922	1-218-957-11	METAL CHIP	2.2K	5%	1/16W	R9618	1-216-853-11	METAL CHIP	470K	5%	1/10W
R7924	1-218-969-11	METAL CHIP	22K	5%	1/16W	R9619	1-208-860-81	METAL CHIP	75	0.5%	1/16W
R7926	1-218-989-11	METAL CHIP	1M	5%	1/16W	R9620	1-216-853-11	METAL CHIP	470K	5%	1/10W
R7929	1-218-969-11	METAL CHIP	22K	5%	1/16W	R9621	1-218-945-11	METAL CHIP	220	5%	1/16W
R7931	1-218-949-11	METAL CHIP	470	5%	1/16W	R9622	1-218-945-11	METAL CHIP	220	5%	1/16W
R7932	1-218-949-11	METAL CHIP	470	5%	1/16W	R9623	1-218-953-11	METAL CHIP	1K	5%	1/16W
R7933	1-218-959-11	METAL CHIP	3.3K	5%	1/16W	R9624	1-218-953-11	METAL CHIP	1K	5%	1/16W
R7935	1-218-959-11	METAL CHIP	3.3K	5%	1/16W	R9625	1-218-953-11	METAL CHIP	1K	5%	1/16W
R7937	1-218-965-11	METAL CHIP	10K	5%	1/16W	R9626	1-218-953-11	METAL CHIP	1K	5%	1/16W
R7939	1-218-990-81	SHORT CHIP	0			R9627	1-218-965-11	METAL CHIP	10K	5%	1/16W
R7940	1-218-969-11	METAL CHIP	22K	5%	1/16W	R9628	1-218-965-11	METAL CHIP	10K	5%	1/16W
R7941	1-218-941-81	METAL CHIP	100	5%	1/16W	R9630	1-218-990-81	SHORT CHIP	0		
R7943	1-218-990-81	SHORT CHIP	0			R9631	1-218-990-81	SHORT CHIP	0		
R7944	1-218-990-81	SHORT CHIP	0			R9632	1-218-990-81	SHORT CHIP	0		
R7945	1-218-957-11	METAL CHIP	2.2K	5%	1/16W	R9633	1-216-853-11	METAL CHIP	470K	5%	1/10W
R7948	1-218-990-81	SHORT CHIP	0			R9634	1-216-853-11	METAL CHIP	470K	5%	1/10W
R7950	1-218-941-81	METAL CHIP	100	5%	1/16W	R9635	1-216-809-11	METAL CHIP	100	5%	1/10W
R7951	1-216-864-11	SHORT CHIP	0			R9636	1-218-941-81	METAL CHIP	100	5%	1/16W
R7963	1-218-990-81	SHORT CHIP	0			R9637	1-218-941-81	METAL CHIP	100	5%	1/16W
R7965	1-218-990-81	SHORT CHIP	0			R9639	1-218-933-11	METAL CHIP	22	5%	1/16W
R7966	1-218-990-81	SHORT CHIP	0			R9640	1-218-933-11	METAL CHIP	22	5%	1/16W
R7967	1-218-990-81	SHORT CHIP	0			R9641	1-218-990-81	SHORT CHIP	0		
R7969	1-218-990-81	SHORT CHIP	0			R9642	1-218-990-81	SHORT CHIP	0		
R7970	1-218-990-81	SHORT CHIP	0			R9643	1-218-990-81	SHORT CHIP	0		
R7973	1-218-957-11	METAL CHIP	2.2K	5%	1/16W	R9801	1-218-965-11	METAL CHIP	10K	5%	1/16W
R7974	1-218-933-11	METAL CHIP	22	5%	1/16W	R9811	1-218-945-11	METAL CHIP	220	5%	1/16W
R7975	1-218-933-11	METAL CHIP	22	5%	1/16W	R9812	1-218-953-11	METAL CHIP	1K	5%	1/16W
R7978	1-218-957-11	METAL CHIP	2.2K	5%	1/16W	R9813	1-218-953-11	METAL CHIP	1K	5%	1/16W
R7979	1-218-965-11	METAL CHIP	10K	5%	1/16W	R9816	1-216-853-11	METAL CHIP	470K	5%	1/10W



REF.NO.	PART.NO	DESCRIPTION	REMARK	REF.NO.	PART.NO	DESCRIPTION	REMARK
R9817	1-216-853-11	METAL CHIP	470K 5% 1/10W	R9921	1-208-911-11	METAL CHIP	10K 0.5% 1/16W
R9818	1-216-853-11	METAL CHIP	470K 5% 1/10W	R9922	1-218-941-81	METAL CHIP	100 5% 1/16W
R9819	1-211-990-11	METAL CHIP	75 0.5% 1/10W	R9923	1-218-990-81	SHORT CHIP	0
R9820	1-216-809-11	METAL CHIP	100 5% 1/10W	R9924	1-218-953-11	METAL CHIP	1K 5% 1/16W
R9821	1-216-853-11	METAL CHIP	470K 5% 1/10W	R9925	1-208-909-11	METAL CHIP	8.2K 0.5% 1/16W
R9822	1-218-969-11	METAL CHIP	22K 5% 1/16W	R9926	1-208-911-11	METAL CHIP	10K 0.5% 1/16W
R9823	1-218-966-11	METAL CHIP	12K 5% 1/16W	R9927	1-218-941-81	METAL CHIP	100 5% 1/16W
R9824	1-216-813-11	METAL CHIP	220 5% 1/10W	R9933	1-208-683-11	METAL CHIP	1K 0.5% 1/16W
R9825	1-218-990-81	SHORT CHIP	0	R9934	1-208-683-11	METAL CHIP	1K 0.5% 1/16W
R9833	1-218-969-11	METAL CHIP	22K 5% 1/16W	R9935	1-218-990-81	SHORT CHIP	0
R9834	1-218-966-11	METAL CHIP	12K 5% 1/16W	R9936	1-218-990-81	SHORT CHIP	0
R9835	1-218-990-81	SHORT CHIP	0			< RESISTOR CHIP >	
R9836	1-218-990-81	SHORT CHIP	0				
R9837	1-218-953-11	METAL CHIP	1K 5% 1/16W	RB1420	1-234-378-21	RES, NETWORK 10K	(1005X4)
R9838	1-218-953-11	METAL CHIP	1K 5% 1/16W	RB2001	1-234-799-21	RES, CHIP NETWORK 10KX8	(3816)
R9839	1-216-813-11	METAL CHIP	220 5% 1/10W	RB2002	1-234-378-21	RES, NETWORK 10K	(1005X4)
R9840	1-216-809-11	METAL CHIP	100 5% 1/10W	RB2003	1-234-371-21	RES, NETWORK 47	(1005X4)
R9841	1-216-853-11	METAL CHIP	470K 5% 1/10W	RB2004	1-234-378-21	RES, NETWORK 10K	(1005X4)
R9842	1-218-990-81	SHORT CHIP	0				
R9843	1-216-853-11	METAL CHIP	470K 5% 1/10W	RB2006	1-239-670-81	RESISTOR, NETWORK 47	
R9844	1-211-990-11	METAL CHIP	75 0.5% 1/10W	RB2009	1-234-378-21	RES, NETWORK 10K	(1005X4)
R9845	1-216-853-11	METAL CHIP	470K 5% 1/10W	RB2010	1-234-371-21	RES, NETWORK 47	(1005X4)
R9846	1-218-953-11	METAL CHIP	1K 5% 1/16W	RB2013	1-234-371-21	RES, NETWORK 47	(1005X4)
R9847	1-218-953-11	METAL CHIP	1K 5% 1/16W	RB2504	1-234-710-21	RES, CHIP NETWORK 47X8	(3816)
R9848	1-216-853-11	METAL CHIP	470K 5% 1/10W				
R9849	1-218-985-11	METAL CHIP	470K 5% 1/16W	RB2505	1-234-710-21	RES, CHIP NETWORK 47X8	(3816)
R9850	1-218-985-11	METAL CHIP	470K 5% 1/16W	RB2506	1-234-785-21	RES, CHIP NETWORK 100X8	(3816)
R9854	1-216-809-11	METAL CHIP	100 5% 1/10W	RB2507	1-234-371-21	RES, NETWORK 47	(1005X4)
R9855	1-216-809-11	METAL CHIP	100 5% 1/10W	RB2508	1-234-711-21	RES, CHIP NETWORK 22X8	(3816)
R9861	1-218-990-81	SHORT CHIP	0	RB2509	1-234-711-21	RES, CHIP NETWORK 22X8	(3816)
R9862	1-216-809-11	METAL CHIP	100 5% 1/10W				
R9866	1-208-683-11	METAL CHIP	1K 0.5% 1/16W	RB2510	1-234-370-21	RES, NETWORK 22	(1005X4)
R9868	1-208-683-11	METAL CHIP	1K 0.5% 1/16W	RB2512	1-234-378-21	RES, NETWORK 10K	(1005X4)
R9869	1-208-683-11	METAL CHIP	1K 0.5% 1/16W	RB2513	1-234-378-21	RES, NETWORK 10K	(1005X4)
R9873	1-218-990-81	SHORT CHIP	0	RB2516	1-234-799-21	RES, CHIP NETWORK 10KX8	(3816)
R9874	1-218-990-81	SHORT CHIP	0	RB2517	1-234-378-21	RES, NETWORK 10K	(1005X4)
R9875	1-218-990-81	SHORT CHIP	0				
R9876	1-208-683-11	METAL CHIP	1K 0.5% 1/16W	RB2518	1-234-371-21	RES, NETWORK 47	(1005X4)
R9877	1-218-990-81	SHORT CHIP	0	RB2519	1-234-378-21	RES, NETWORK 10K	(1005X4)
R9878	1-218-990-81	SHORT CHIP	0	RB2520	1-234-378-21	RES, NETWORK 10K	(1005X4)
R9879	1-218-990-81	SHORT CHIP	0	RB2521	1-234-378-21	RES, NETWORK 10K	(1005X4)
R9881	1-208-860-81	METAL CHIP	75 0.5% 1/16W	RB2522	1-234-378-21	RES, NETWORK 10K	(1005X4)
R9885	1-208-860-81	METAL CHIP	75 0.5% 1/16W				
R9886	1-208-860-81	METAL CHIP	75 0.5% 1/16W	RB2523	1-234-799-21	RES, CHIP NETWORK 10KX8	(3816)
R9897	1-218-945-11	METAL CHIP	220 5% 1/16W	RB3000	1-234-723-21	RES, NETWORK 75	(1005X4)
R9898	1-218-945-11	METAL CHIP	220 5% 1/16W	RB3001	1-234-723-21	RES, NETWORK 75	(1005X4)
R9899	1-218-945-11	METAL CHIP	220 5% 1/16W	RB3002	1-234-723-21	RES, NETWORK 75	(1005X4)
R9916	1-208-860-81	METAL CHIP	75 0.5% 1/16W	RB3003	1-234-723-21	RES, NETWORK 75	(1005X4)
R9919	1-218-953-11	METAL CHIP	1K 5% 1/16W				
R9920	1-208-909-11	METAL CHIP	8.2K 0.5% 1/16W	RB3004	1-234-723-21	RES, NETWORK 75	(1005X4)
				RB3006	1-234-369-21	RES, NETWORK 10	(1005X4)
				RB3007	1-242-963-21	RES, NETWORK 33	(1005X4)
				RB3008	1-234-891-21	RES, CHIP NETWORK 10X8	(3816)
				RB3009	1-234-891-21	RES, CHIP NETWORK 10X8	(3816)
				RB3010	1-239-666-81	RESISTOR, NETWORK 22	



REF.NO.	PART.NO	DESCRIPTION	REMARK	REF.NO.	PART.NO	DESCRIPTION	REMARK
RB3011	1-239-666-81	RESISTOR, NETWORK 22		RB5532	1-234-376-11	RES, NETWORK 2.2K	(1005X4)
RB3500	1-234-371-21	RES, NETWORK 47	(1005X4)	RB5533	1-234-376-11	RES, NETWORK 2.2K	(1005X4)
RB3501	1-239-698-11	RESISTOR, NETWORK 10K		RB7001	1-234-378-21	RES, NETWORK 10K	(1005X4)
RB3502	1-234-377-21	RES, NETWORK 4.7K	(1005X4)	RB7002	1-234-372-11	RES, NETWORK 100	(1005X4)
RB3503	1-234-371-21	RES, NETWORK 47	(1005X4)	RB7003	1-234-372-11	RES, NETWORK 100	(1005X4)
RB3504	1-234-371-21	RES, NETWORK 47	(1005X4)	RB7004	1-234-372-11	RES, NETWORK 100	(1005X4)
RB3802	1-234-799-21	RES, CHIP NETWORK 10KX8	(3816)	RB7005	1-234-882-21	RES, CHIP NETWORK 47KX8	(3816)
RB3803	1-234-378-21	RES, NETWORK 10K	(1005X4)	RB7007	1-234-882-21	RES, CHIP NETWORK 47KX8	(3816)
RB3804	1-234-710-21	RES, CHIP NETWORK 47X8	(3816)	RB7008	1-234-378-21	RES, NETWORK 10K	(1005X4)
RB3805	1-234-710-21	RES, CHIP NETWORK 47X8	(3816)	RB7009	1-234-380-21	RES, NETWORK 47K	(1005X4)
RB3806	1-234-371-21	RES, NETWORK 47	(1005X4)	RB7013	1-234-379-21	RES, NETWORK 22K	(1005X4)
RB3807	1-234-378-21	RES, NETWORK 10K	(1005X4)	RB7301	1-234-381-11	RES, NETWORK 100K	(1005X4)
RB3809	1-234-378-21	RES, NETWORK 10K	(1005X4)	RB7302	1-234-372-11	RES, NETWORK 100	(1005X4)
RB3810	1-234-371-21	RES, NETWORK 47	(1005X4)	RB7303	1-234-381-11	RES, NETWORK 100K	(1005X4)
RB3811	1-234-371-21	RES, NETWORK 47	(1005X4)	RB7304	1-234-375-21	RES, NETWORK 1K	(1005X4)
RB3812	1-234-710-21	RES, CHIP NETWORK 47X8	(3816)	RB7305	1-234-723-21	RES, NETWORK 75	(1005X4)
RB4200	1-234-372-11	RES, NETWORK 100	(1005X4)	RB7306	1-234-375-21	RES, NETWORK 1K	(1005X4)
RB4201	1-234-372-11	RES, NETWORK 100	(1005X4)	RB7307	1-234-373-21	RES, NETWORK 220	(1005X4)
RB4203	1-234-372-11	RES, NETWORK 100	(1005X4)	RB7308	1-234-381-11	RES, NETWORK 100K	(1005X4)
RB4204	1-234-372-11	RES, NETWORK 100	(1005X4)	RB7310	1-234-373-21	RES, NETWORK 220	(1005X4)
RB4401	1-234-711-21	RES, CHIP NETWORK 22X8	(3816)	RB7311	1-234-381-11	RES, NETWORK 100K	(1005X4)
RB4503	1-239-662-81	RESISTOR, NETWORK 10		RB7312	1-234-373-21	RES, NETWORK 220	(1005X4)
RB4505	1-234-371-21	RES, NETWORK 47	(1005X4)	RB7313	1-234-373-21	RES, NETWORK 220	(1005X4)
RB5000	1-234-710-21	RES, CHIP NETWORK 47X8	(3816)	RB7401	1-234-372-11	RES, NETWORK 100	(1005X4)
RB5001	1-234-371-21	RES, NETWORK 47	(1005X4)	RB7402	1-234-378-21	RES, NETWORK 10K	(1005X4)
RB5501	1-234-376-11	RES, NETWORK 2.2K	(1005X4)	RB7403	1-234-378-21	RES, NETWORK 10K	(1005X4)
RB5502	1-234-372-11	RES, NETWORK 100	(1005X4)	RB7406	1-234-375-21	RES, NETWORK 1K	(1005X4)
RB5503	1-234-372-11	RES, NETWORK 100	(1005X4)	RB7600	1-239-674-81	RESISTOR, NETWORK 100	
RB5505	1-234-372-11	RES, NETWORK 100	(1005X4)	RB7601	1-239-674-81	RESISTOR, NETWORK 100	
RB5506	1-234-785-21	RES, CHIP NETWORK 100X8	(3816)	RB7602	1-239-674-81	RESISTOR, NETWORK 100	
RB5507	1-234-372-11	RES, NETWORK 100	(1005X4)	RB7603	1-239-706-81	RESISTOR, NETWORK 47K	
RB5508	1-234-372-11	RES, NETWORK 100	(1005X4)	RB7604	1-239-706-81	RESISTOR, NETWORK 47K	
RB5509	1-234-376-11	RES, NETWORK 2.2K	(1005X4)	RB7605	1-239-706-81	RESISTOR, NETWORK 47K	
RB5510	1-234-710-21	RES, CHIP NETWORK 47X8	(3816)	RB7606	1-234-378-21	RES, NETWORK 10K	(1005X4)
RB5512	1-234-372-11	RES, NETWORK 100	(1005X4)	RB7607	1-239-674-81	RESISTOR, NETWORK 100	
RB5513	1-234-372-11	RES, NETWORK 100	(1005X4)	RB7608	1-239-706-81	RESISTOR, NETWORK 47K	
RB5514	1-234-372-11	RES, NETWORK 100	(1005X4)	RB7610	1-239-690-81	RESISTOR, NETWORK 2.2K	
RB5516	1-234-375-21	RES, NETWORK 1K	(1005X4)	RB7901	1-234-372-11	RES, NETWORK 100	(1005X4)
RB5518	1-234-372-11	RES, NETWORK 100	(1005X4)	RB7902	1-234-785-21	RES, CHIP NETWORK 100X8	(3816)
RB5519	1-234-375-21	RES, NETWORK 1K	(1005X4)	RB7903	1-234-372-11	RES, NETWORK 100	(1005X4)
RB5520	1-234-378-21	RES, NETWORK 10K	(1005X4)	RB7904	1-239-690-81	RESISTOR, NETWORK 2.2K	
RB5521	1-234-378-21	RES, NETWORK 10K	(1005X4)	RB7906	1-239-690-81	RESISTOR, NETWORK 2.2K	
RB5522	1-234-375-21	RES, NETWORK 1K	(1005X4)	RB7907	1-234-378-21	RES, NETWORK 10K	(1005X4)
RB5524	1-234-375-21	RES, NETWORK 1K	(1005X4)	RB7908	1-234-370-21	RES, NETWORK 22	(1005X4)
RB5525	1-234-375-21	RES, NETWORK 1K	(1005X4)				
RB5526	1-234-375-21	RES, NETWORK 1K	(1005X4)				
RB5527	1-234-372-11	RES, NETWORK 100	(1005X4)				
RB5528	1-234-372-11	RES, NETWORK 100	(1005X4)				
RB5530	1-234-375-21	RES, NETWORK 1K	(1005X4)				
RB5531	1-234-372-11	RES, NETWORK 100	(1005X4)				

< VARISTOR >

VD3500	1-802-090-21	VARISTOR, CHIP
VD5502	1-802-090-21	VARISTOR, CHIP
VD5503	1-802-090-21	VARISTOR, CHIP
VD5504	1-802-090-21	VARISTOR, CHIP

REF.NO.	PART.NO	DESCRIPTION	REMARK	REF.NO.	PART.NO	DESCRIPTION	REMARK
VD5505	1-802-090-21	VARISTOR, CHIP		C404	1-100-916-11	CERAMIC CHIP 0.1UF	10% 16V
VD9601	1-802-090-21	VARISTOR, CHIP		C405	1-114-399-21	ELECT CHIP 47UF	20% 6.3V
VD9602	1-802-090-21	VARISTOR, CHIP		C406	1-114-130-11	CERAMIC CHIP 1UF	10% 6.3V
VD9603	1-802-090-21	VARISTOR, CHIP					
VD9604	1-802-090-21	VARISTOR, CHIP				< CONNECTOR >	
				CN401	*1-821-132-11	HEADER ASSEMBLY FOR PWB 5P	
VD9605	1-802-090-21	VARISTOR, CHIP				< DIODE >	
VD9617	1-802-090-21	VARISTOR, CHIP		D402	6-501-732-01	DIODE MAZ8056G0LS0	
VD9834	1-802-090-21	VARISTOR, CHIP				< IC >	
VD9835	1-802-090-21	VARISTOR, CHIP		IC401	6-600-681-01	IC RS-770N	
VD9836	1-802-090-21	VARISTOR, CHIP		IC402	6-600-680-01	PHOTO DIODE BH1690FVC-TR	
		< CRYSTAL >				< TRANSISTOR >	
X2000	1-814-253-11	QUARTZ CRYSTAL UNIT		Q401	6-551-775-01	TR 2SA2122G0LS0	
X3500	1-814-147-11	QUARTZ CRYSTAL OSCILLATOR				< RESISTOR >	
X3501	1-814-252-11	PIEZOELECTRIC OSCILLATOR 30MHZ		R401	1-218-949-11	METAL CHIP 470 5% 1/16W	
X5500	1-813-070-21	PIEZOELECTRIC OSCILLATOR		R402	1-218-937-11	METAL CHIP 47 5% 1/16W	
X5501	1-813-784-21	VIBRATOR, CRYSTAL		R403	1-218-990-81	SHORT CHIP 0	
				R404	1-218-955-11	METAL CHIP 1.5K 5% 1/16W	
X7001	1-814-267-11	QUARTZ CRYSTAL UNIT		R406	1-218-990-81	SHORT CHIP 0	
				R407	1-218-979-11	METAL CHIP 150K 5% 1/16W	
A-1671-629-A HL4A Board, Complete				R408	1-218-965-11	METAL CHIP 10K 5% 1/16W	
		< CAPACITOR >		R409	1-218-971-11	METAL CHIP 33K 5% 1/16W	
C304	1-100-916-11	CERAMIC CHIP 0.1UF	10% 16V	R411	1-218-953-11	METAL CHIP 1K 5% 1/16W	
		< CONNECTOR >					
CN301	*1-821-147-11	HEADER ASSEMBLY FOR PWB 7P					
		< DIODE >					
D301	6-502-615-01	DI SML-Z14MTT86A					
D302	6-502-609-01	DI SML-Z14VTT86A					
D303	6-502-615-01	DI SML-Z14MTT86A					
D305	6-502-609-01	DI SML-Z14VTT86A					
		< TRANSISTOR >					
Q301	6-551-815-01	TR UNR52A1G0LS0					
Q302	6-551-815-01	TR UNR52A1G0LS0					
Q303	6-551-815-01	TR UNR52A1G0LS0					
Q305	6-551-815-01	TR UNR52A1G0LS0					
		< RESISTOR >					
R301	1-208-883-81	METAL CHIP 680 0.5% 1/16W					
R302	1-208-695-11	METAL CHIP 3.3K 0.5% 1/16W					
R303	1-208-675-11	METAL CHIP 470 0.5% 1/16W					
R305	1-218-958-11	METAL CHIP 2.7K 5% 1/16W					
A-1704-202-A HSN Board, Complete							
		< CAPACITOR >					
C401	1-112-068-11	CERAMIC CHIP 220PF	10% 50V				
C402	1-100-909-11	CERAMIC CHIP 10UF	10% 6.3V				

REF.NO.	PART.NO	DESCRIPTION	REMARK	REF.NO.	PART.NO	DESCRIPTION	REMARK
---------	---------	-------------	--------	---------	---------	-------------	--------

**ACCESSORIES AND CONNECTORS**

- \*1-835-715-11 CONNECTOR ASSY 2P (D5N-G5N)
- \*1-836-138-11 CONNECTOR ASSY 2P (D6N-G5N)
- \*1-836-417-21 CONNECTOR ASSY MDF61 (BALANCER-D5N)
- \*1-836-418-21 CONNECTOR ASSY MDF61 (BALANCER-D6N)
- 1-836-673-11 LEAD WIRE CONNECTOR(LVDS) (TCON-BA(CN4501))
  
- \*1-910-054-68 HARNESS ASSY (BA(CN1300/1301)-G5N)
- \*1-910-054-72 CONNECTOR ASSY 8P (D5N-G5N)
- \*1-910-054-73 CONNECTOR ASSY 10P (D5N-D6N)
- \*1-910-054-74 CONNECTOR ASSY 7P (BALANCER-D5N)
- \*1-910-054-84 CONNECTOR ASSY 4P (G5N-TCON)
  
- \*1-910-057-47 MULTI HARNESS SPEAKER ASSY (BA(CN5503/7201)-HL4A(CN301)-HSN(CN401)-SWITCH UNIT-SPEAKERS)
  
- \*4-136-143-13 INSTRUCTION MANUAL (UK) ENGLISH
- \*4-136-143-23 INSTRUCTION MANUAL (WE) FRENCH/ITALIAN/  
GERMAN/DUTCH/SPANISH/PORTUGUESE
- \*4-136-143-33 INSTRUCTION MANUAL (OIRT) DANISH/NORWEGIAN/  
SWEDISH/FINNISH/POLISH/ROMAINIAN
  
- \*4-136-143-43 INSTRUCTION MANUAL (OIRT) HUNGARIAN/CZECH/  
GREEK/SLOVAK/TURKISH/BULGARIAN
- \*4-136-143-53 INSTRUCTION MANUAL (OIRT) RUSSIAN/UKRAINIAN

**REMOTE COMMANDER**

- 1-487-228-11 REMOTE COMMANDER (RM-ED016)

