

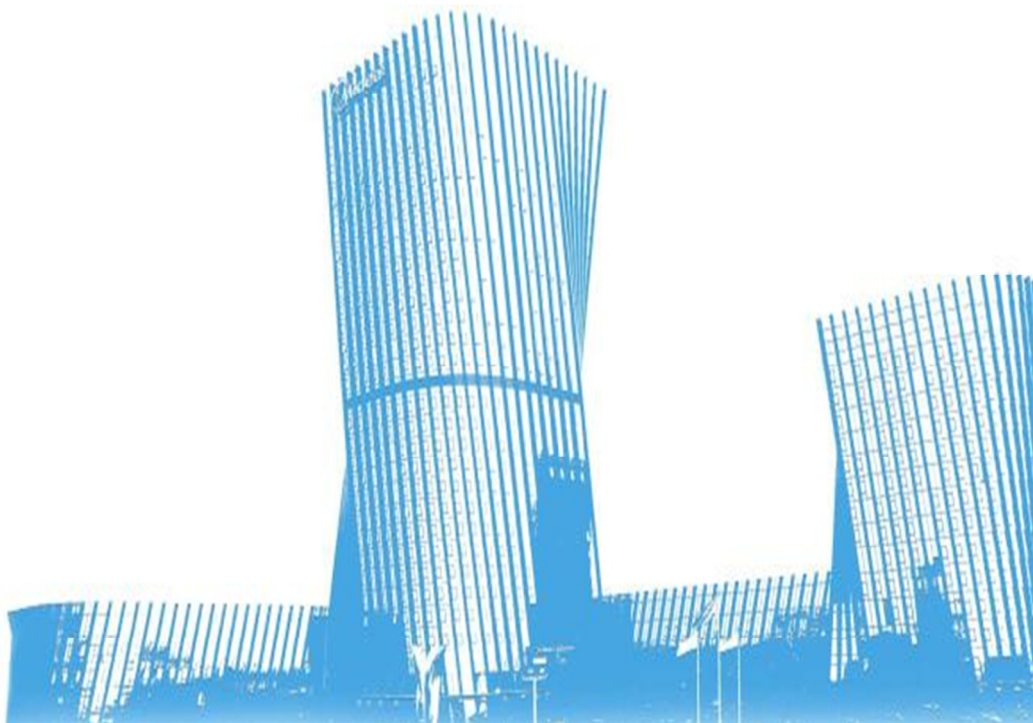

# **SBS SERIES**

**Service Manual 2016**



# Service Manual

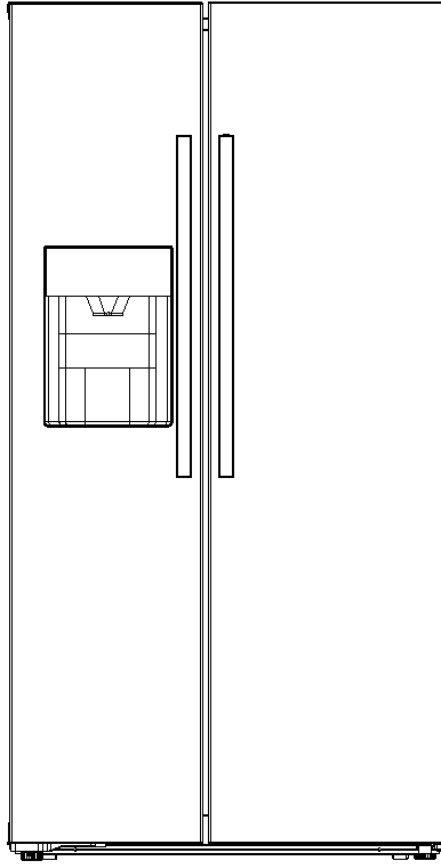

(The picture is only for reference, and specific appearance and configuration are subject to the real product)

Prepared by R&D:HuDahong

---

Reviewed by QA:WangTao  
SVC:Zhang Kun

---

Approved by R&D:ZhangHaixing  
SVC:GuangTaoshuai

---



### **Important Safety Notice**

The Maintenance Manual is only for the use of maintenance personnel with certain experience and background in electrical, electronic and mechanical field.

Any attempt to repair main devices may lead to personal injury and property loss.

Manufacturers or distributors are not responsible for the content of the Manual and interpretation thereof.

### **Midea Refrigerators**

Technical Maintenance Manual

Copyright @2016

All rights reserved. Replication of all or part of the Manual in any forms shall not be allowed without written approval by the Overseas Sales Corporation of Midea Refrigerators.

**※The specifications, designs, and information in this book are subject to change without notice for product improvement.**

# Contents

1.Safety Warning Code .....	6
1.1 Warning for operation safety .....	6
1.2 Safety instruction for refrigerant.....	9
2.Description for product features .....	10
3.Installation and commissioning .....	11
3.1 Handling .....	11
3.2 Door Disassembly and Assembly .....	11
3.3 Installation location .....	15
3.4 Leveling of the refrigerator.....	15
3.5 Door reversal (None).....	15
3.6 Installation of handle .....	15
3.7 Installation of door lock(None).....	16
3.8 Adjustment to level the door .....	16
3.9 Adjustment to shelves(None).....	16
4.Terms .....	17
4.1 Definition of model(None) .....	17
4.2 Location of nameplate .....	17
5.Product specification .....	17
5.1 Typespecification(None).....	17
5.2 Electrical parameters .....	17
5.3 Inside temperature .....	18
5.4 Defrosting parts .....	19
5.5 Circuit diagram .....	19
6.Internal view and dimension.....	21
6.1 Main parts and their names.....	21
6.2 External dimension .....	21
7.Refrigerating piping system and circulating route of cooling air .....	23
7.1 Refrigerating piping system.....	23
7.2 Circulating route of cooling air.....	24
8. 8. Dismantling of parts .....	25
8.1 Parts on the door .....	25
8.2 Parts inside the refrigerator.....	25
8.3 Light system .....	26
8.4 Air duct components refrigerating chamber .....	27
8.5 Air duct components in freezing chamber and fan motor.....	28
8.6 Evaporator and temperature sensing system.....	29
8.7 Compressor case .....	32
8.8 Display control board .....	34
8.9 Main control boardl .....	34
8.10 Bar counter(None) .....	35
8.11 Water dispenser(None).....	35
8.12 Ice maker .....	36

9. Function and operation	38
9.1 Operation panel.....	38
9.2 Temperature control.....	38
9.3 give an alarm .....	39
9.4 Defrosting .....	39
9.5 Function Selection .....	39
9.6 Self-diagnosis .....	40
9.7 Compressor fan control(None) .....	40
9.8 Error code and solution.....	40
10. Circuit description .....	41
10.1 Power Supply.....	41
10.2 Test circuit for door switch .....	41
10.3 Temperature test circuit.....	41
10.4 Freezer fan motor circuit.....	42
10.5 REF. fan motor circuit(None) .....	42
10.6 Condenser fan motor circuit(None) .....	42
10.7 Damper motor circuit.....	42
10.8 Sensor resistance(R/T).....	42
11. Troubleshooting Method.....	44
11.1 No cooling(Air cooling-Electronic).....	44
11.2 No working of compressor.....	45
11.3 Inside frosting, no defrosting .....	45
11.4-Inside frosting, no defrosting-Maintenance guidelines.....	46
11.5 Light is not on .....	47
11.6 Air duct not operated(electronically) .....	47
11.7 Fan failure .....	48
11.8 Defective defrost circuit.....	48
11.9 Noise .....	49
12. Figures and details of repair parts(Documents are provided separately).....	49
12.1 Figures .....	49
12.2 List of parts and components .....	49
13 Appendix: .....	49
13.1 Electrical Schematic Diagram .....	49
13.2 Refrigerator maintenance tooling and equipment and material .....	50

## 1.Safety Warning Code

### 1.1Warning for operation safety

## Important Safety Instructions

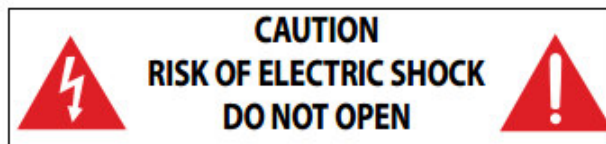

This symbol indicates that dangerous voltage constituting a risk of electric shock is present within your freezer.



This symbol indicates that there are important operating and maintenance instructions in the literature accompanying your freezer.

### **WARNING**

- 1 Read these instructions.
- 2 Keep these instructions.
- 3 Heed all warnings.
- 4 Follow all instructions.
- 5 Do not use this appliance near water.
- 6 Clean only with a damp cloth.
- 7 Do not block any ventilation openings.
- 8 Install in accordance with the manufacturer's instructions.
- 9 Do not install near any heat sources, such as radiators, heat registers, stoves, or other apparatus that produce heat.
- 10 Do not defeat the safety purpose of the polarized or grounding-type plug. A polarized plug has two blades with one wider than the other. A grounding type plug has two blades and a third grounding prong. The wide blade or the third prong are provided for your safety. If the provided plug does not fit into your outlet, consult an electrician for replacement of the obsolete outlet.
- 11 Protect the power cord from being walked on or pinched, particularly at plugs, convenience receptacles, and the point where they exit from the appliance.
- 12 Do not attempt to modify or extend the power cord of this appliance.
- 13 Unplug this appliance during lightning storms or when it will not be used for long periods of time.
- 14 Make sure that the available AC power matches the voltage requirements of this appliance.

- 15 Do not handle the plug with wet hands. This could result in an electric shock.
- 16 Unplug the power cord by holding the plug, never by pulling the cord.
- 17 Do not turn the appliance on or off by plugging or unplugging the power cord.
- 18 Refer all servicing to qualified service personnel. Servicing is required when the appliance has been damaged in any way, such as the power-supply cord or plug is damaged, liquid has been spilled or objects have fallen into the appliance, the appliance has been exposed to rain or moisture, does not operate normally, or has been dropped.
- 19 To reduce the risk of fire or electric shock, do not expose this appliance to rain, moisture, dripping, or splashing, and no objects filled with liquids should be placed on top of it.
- 20 Do not use extension cords or ungrounded (two prong) adapters.
- 21 This appliance is not intended for use by persons (including children) with reduced physical, sensory or mental capabilities, or lack of experience and knowledge, unless they have been given supervision or instruction concerning use of the appliance by a person responsible for their safety.
- 22 Children should be supervised to ensure that they do not play with the appliance.
- 23 If the supply cord is damaged, it must be replaced by the manufacturer, its service agent, or similarly qualified person, in order to avoid a hazard.
- 24 Take off the doors and leave the shelves in place so that children may not easily climb inside.



## WARNING

### Electric Shock Hazard

**Failure to follow these instructions can result in electric shock, fire, or death.**

- 1 **WARNING**—Keep ventilation openings, in both the freezer and the built-in structure, clear of obstruction.
- 2 **WARNING**—Do not touch the interior of the freezer with wet hands. This could result in frost bite.
- 3 **WARNING**—Do not use mechanical devices or other means to accelerate the defrosting process, other than those recommended by the manufacturer.
- 4 **WARNING**—Do not damage the refrigerant circuit.



- 5 **WARNING**—Do not damage the refrigerant tubing when handling, moving, or using the freezer.
- 6 **WARNING–DANGER**—Never allow children to play with, operate, or crawl inside the freezer.  
Risk of child entrapment. Before you throw away your old freezer:
  - 1) Take off the doors
  - 2) Leave the shelves in place so that children may not easily climb inside
- 7 Unplug the freezer before carrying out user maintenance on it.
- 8 This freezer can be used by children age eight years and older and persons with reduced physical or mental capabilities or lack of experience and knowledge if they are given supervision or instruction concerning the use of the freezer in a safe way and understand the hazards involved. Children should not play with the freezer. Cleaning and maintenance should not be performed by children without supervision.
- 5 **WARNING**—Do not damage the refrigerant tubing when handling, moving, or using the freezer.
- 6 **WARNING–DANGER**—Never allow children to play with, operate, or crawl inside the freezer.  
Risk of child entrapment. Before you throw away your old freezer:
  - 1) Take off the doors
  - 2) Leave the shelves in place so that children may not easily climb inside
- 7 Unplug the freezer before carrying out user maintenance on it.
- 8 This freezer can be used by children age eight years and older and persons with reduced physical or mental capabilities or lack of experience and knowledge if they are given supervision or instruction concerning the use of the freezer in a safe way and understand the hazards involved. Children should not play with the freezer. Cleaning and maintenance should not be performed by children without supervision.
- 9 If a component part is damaged, it must be replaced by the manufacturer, its service agent, or similar qualified persons in order to avoid a hazard.
- 10 Please dispose of the freezer according to local regulations as the freezer contains flammable gas and refrigerant.
- 11 Follow local regulations regarding disposal of the freezer due to flammable refrigerant and gas. All refrigeration products contain refrigerants, which under the guidelines of federal law must be removed before disposal. It is the consumer's responsibility to comply with federal and local regulations when disposing of this product.





- 12** This freezer is intended to be used in household and similar environments.
- 13** Do not store or use gasoline or any flammable liquids inside or in the vicinity of this freezer.
- 14** Do not use extension cords or ungrounded (two-prong) adapters with this freezer. If the power cord is too short, have a qualified electrician install an outlet near the freezer. Use of an extension cord can negatively affect the freezer's performance.

### Grounding requirement

This freezer must be grounded. This freezer is equipped with a cord having a grounding wire with a grounding plug. The plug must be inserted into an outlet that is properly installed and grounded.

Improper use of the grounding plug can result in a risk of electric shock. Consult a qualified electrician or service person if the grounding instructions are not completely understood, or if doubt exists as to whether the freezer is properly grounded.

### 1.2 Safety instruction for refrigerant

 <b>WARNING</b>  <b>Explosion Hazard.</b>
<p>Keep flammable materials and vapors, such as gasoline, away from freezer. Failure to do so can result in fire, explosion, or death.</p>

<p>DANGER—Risk of Fire or Explosion. Flammable Refrigerant Used. To Be Repaired Only By Trained Service Personnel. Do Not Use Mechanical Devices. Do Not Puncture Refrigerant Tubing.</p> <p>CAUTION—Risk of Fire or Explosion. Flammable Refrigerant Used. Consult Repair Manual/Owner's Guide Before Attempting To Service This Product. All Safety Precautions Must be Followed.</p> <p>CAUTION—Risk of Fire or Explosion. Dispose of Properly In Accordance With Federal Or Local Regulations. Flammable Refrigerant Used.</p> <p>CAUTION—Risk of Fire or Explosion Due To Puncture Of Refrigerant Tubing; Follow Handling Instructions Carefully. Flammable Refrigerant Used.</p>	
--	---

## **2.Description for product features**

This product is provided with following features:



(The picture is only for reference, and specific appearance and configuration are subject to the real product)

- 1) Frost free design.
- 2) Electronic temperature control, more accurate temperature control.
- 3) Automatic ice maker, options for ice cube, crushed ice and cooling water.



### **3.Installation and commissioning**





#### **3.1 Handling**



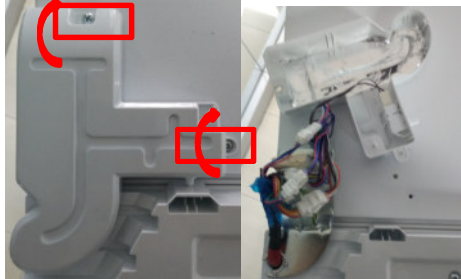

<p>1) Protect the refrigerator in moving it ,Same as shown as left photo, please move it by hand cart with cushion</p> <p>2) Remove all packing materials and bottom cushion, then move into house for placement</p> <p>3) After moving it to appropriate location, wait for 2 hours before power on.</p>	
---	--

#### **3.2 Door Disassembly and Assembly**

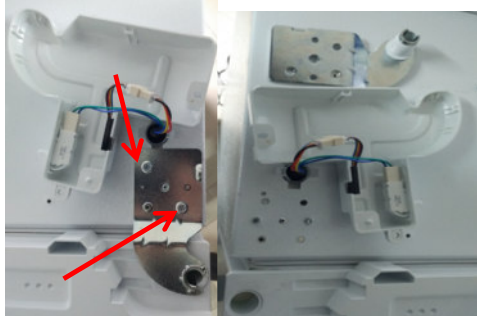

The refrigerator door needs to be dismantled if it cannot enter the room in the whole.

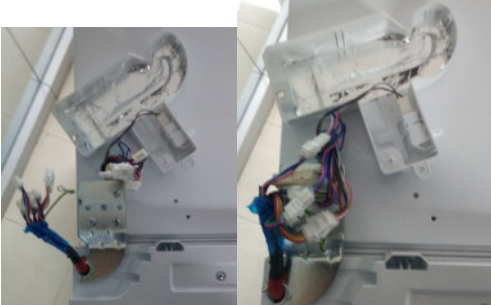
<b>disassembly</b>	
<b>Disassembly of Freezer door</b>	
<p>1. Use cross screwdriver to remove the screws by anticlockwise, and then take out the protective cover.</p>	
<p>2. Pull out the spacing guard sheet at the two ends of water connector, and then push the locked cushion inwards, meantime pull out water pipe.</p> <p>Note: please make sure the fast connector can't be left at the end of water pipe of door</p>	

<p>3.2As shown as right photos, use screwdriver to remove the 2 pcs screws, and then remove the upper hinge cover.</p>	
<p>4.Disconnect the fast connectors, then use cross screwdriver or socket spanner to remove the 2pcs M5 screws and 1 pc grounding screw by anticlockwise.</p>	
<p>5.Lift up the freezer door until the hinge axis separated from the axis hole of door, then carry the door to a suitable place.</p>	
<p><b>Disassembly of refrigerator door</b></p>	
<p>1.Use screwdriver to remove the 2 pcs screws, and then remove the upper hinge cover.</p>	
<p>2.Use cross screwdriver or socket spanner to remove the 2 pcs M5 screws by anticlockwise, and then remove the upper hinge.</p> <p>Note: please make sure the refrigerator door fit closely to the cabinet; otherwise the refrigerator door may fall down during above operation.</p>	

<p>3.Lift up the refrigerator door until the hinge axis separated from the axis hole of door, then carry the door to a suitable place.</p>	
<p><b>Assembly</b></p>	
<p><b>Assembly of freezer door</b></p>	
<p>1.Put the freezer door down gently until the axis of hinge inserted into the axis hole of door completely.</p>	
<p>2.Put the upper hinge on suitable position, then use cross screwdriver or socket spanner to fix the 2 pcs M5 screws and 1 pc grounding screw by clockwise, and connect the 6 pcs fast connectors.</p>	
<p>3.Put the cover of upper hinge on suitable position, then use screwdriver to fix the 2 pcs screws</p>	
<p>4.Push the locked cushion of water connector inwards, then insert the water pipe into the water connector to the end, and finally assemble the spacing guard sheet. Note: the water pipe cant be connected incorrectly, only the water pipes in same color can be connected</p>	

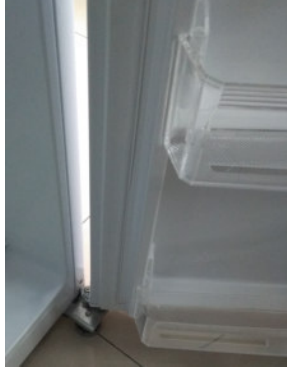
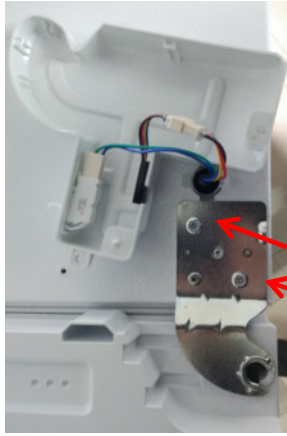

<p>5.Assemble the protective cover and fix the screws</p>	
<p><b>assembly of refrigerator door</b></p>	
<p>1.Put the refrigerator door down gently until the axis of hinge inserted into the axis hole of door completely, and then closes the door, to make sure the refrigerator door fit the cabinet closely.</p>	
<p>2.Put the upper hinge on suitable position, then use cross screwdriver or socket spanner to fix the 2 pcs M5 screws.</p>	
<p>3.Put the hinge cover on suitable position, and then use the screwdriver to fix the 2 pcs screws.</p>	

### 3.3 Installation location

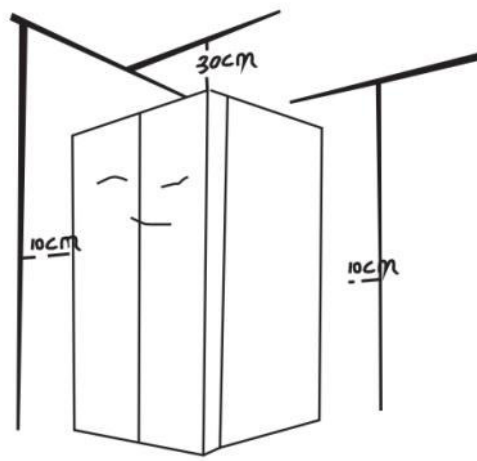
<p>Location that is easy for ventilation shall be chosen to facilitate heat dissipation, enhance its performance and reduce the energy consumption.</p>	 <p>A line drawing of a refrigerator with a smiley face on its door. It is positioned between two vertical lines representing walls. Dimension lines indicate a 30cm clearance above the top of the refrigerator, and 10cm clearances on both the left and right sides.</p>
---	---

### 3.4 Leveling of the refrigerator

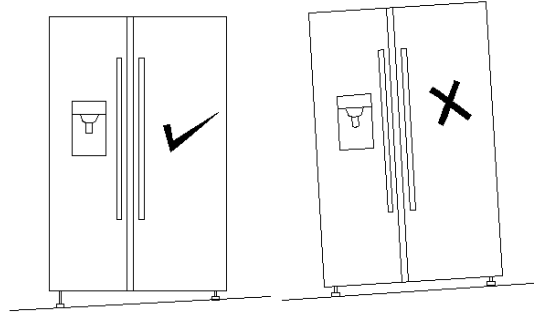
<p>If the refrigerator cannot be placed steadily, adjust the footing to level it.</p>	 <p>Two side-by-side diagrams of a refrigerator. The left diagram shows the refrigerator perfectly level on a flat surface, with a checkmark to its right. The right diagram shows the refrigerator tilted to the right on an uneven surface, with an 'X' to its right.</p>
---	--

### 3.5 Door reversal (None)

### 3.6 Installation of handle

Note: Figures in the user manual are only for reference. The actual product may differ slightly.  
The refrigerator must be disconnected from the source of electrical supply before attempting the installation of accessory.

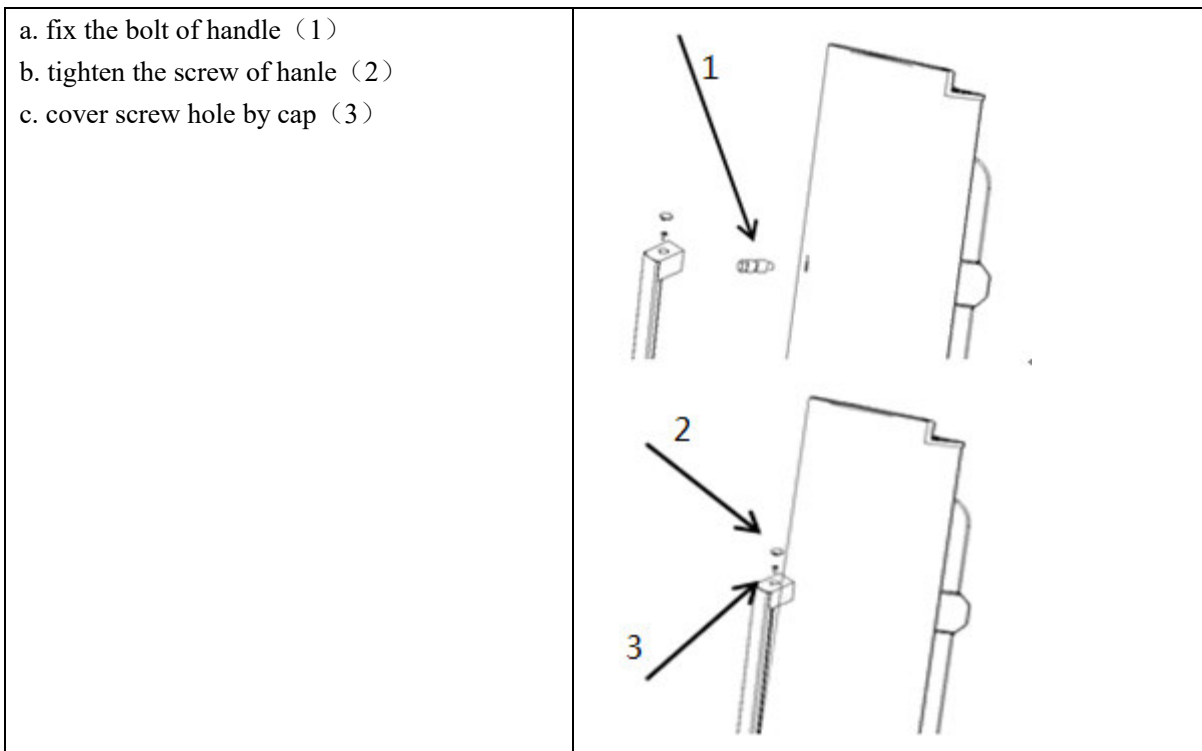

(Pictures and objects are not consistent, in order to prevail in kind)

### 3.7 Installation of door lock(None)

### 3.8 Adjustment to level the door

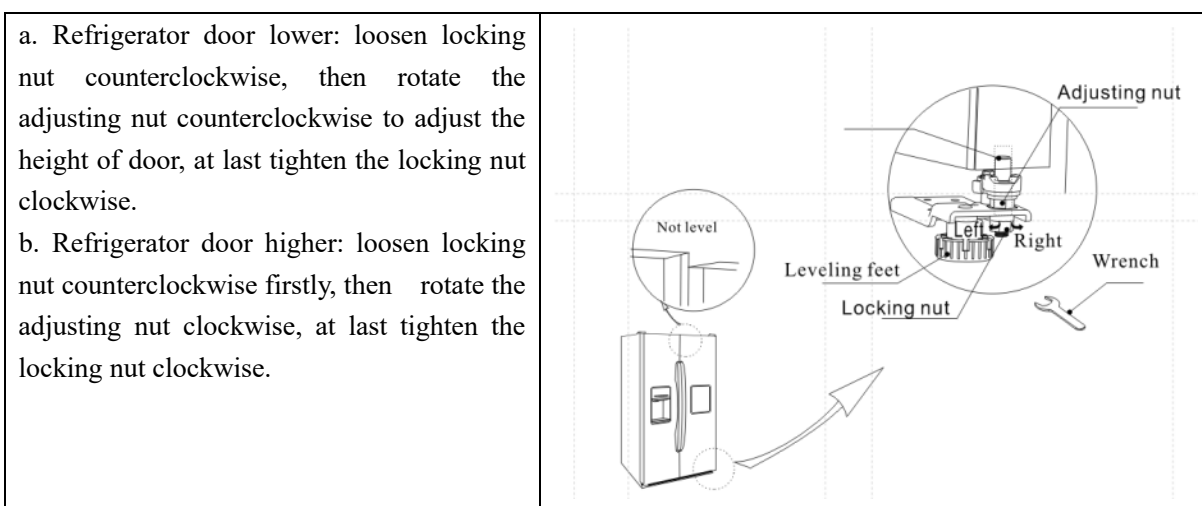

### 3.9 Adjustment to shelves(None)

## 4. Terms

### 4.1 Definition of model(None)

### 4.2 Location of nameplate

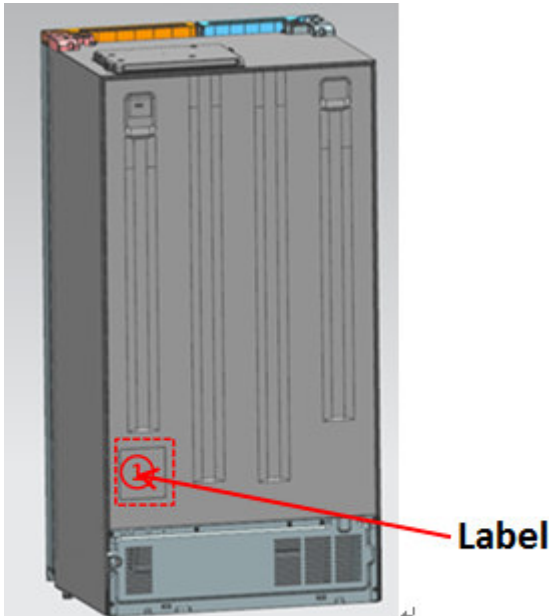

(The picture is only for reference, and specific appearance and configuration are subject to the real product)

## 5. Product specification

### 5.1 Typespecification(None)

### 5.2 Electrical parameters

Product Name			CE-BCD508W E-ST	CE-BCD508W E-JT	CE-BCD508W E-FT	CE-BCD508W E-ST	SR-BCD508W E
Product Code			220310500003 82	220310500002 01	220310500000 81	220310500000 05	220310500003 01
Name	Item	Type	Specification	Specification	Specification	Specification	Specification
Compressor	Compressor	/	ERI120E13DC H	LU118PY1	KJ248CY	KJ248CY	PZ130H1A-M
	Starter	PTC	/	/	DRB25T61A1	TY-QZ-003	TY-QZ-003/QP E2-A15MD3
	Overload protector	OLP	MM3-71CCX	B69-120 P A	DRB25T61A1	DRB25T61A1	DRB25T61A1

	<b>Winding resistance of compressor wiring terminal</b>	/	20°C U-V 9.2Ω±15% 20°C V-W 9.2Ω±15% 20°C W-V 9.2Ω±15%	20°C U-V 12.4Ω±5% 20°C U-W 12.4Ω±5% 20°C W-V 12.4Ω±5%	primary winding resistance:12.3 ±7%Ω secondary winding resistance:18.8 ±7%Ω	primary winding resistance:12.3 ±7%Ω secondary winding resistance:18.8 ±7%Ω	primary winding resistance:10.08±7%Ω secondary winding resistance:10.94±7%Ω
	<b>Variable frequency driver board</b>	/	DBFC-CTCL M-V1.0 220-240V(50/60)Hz	ITRP04BX1.9 220-240V(50/60)Hz	/	/	/
<b>Motor</b>	<b>Fan motor of the freezing chamber</b>	BLDC	DC12V/≤4W	DC12V/≤4W	DC12V/≤4W	DC12V/≤4W	DC12V/≤4W
	<b>Ventilation door of the refrigerating chamber</b>	/	DC12V	DC12V	DC12V	DC12V	DC12V
	<b>Condensation fan</b>	/	/	DC12V	/	/	/
	<b>separation the ice motor</b>	/	DC12V	DC12V	DC12V	DC12V	DC12V
	<b>ice output motor</b>	/	DC12V	DC12V	DC12V	DC12V	DC12V
	<b>Open door motor</b>	/	DC12V	DC12V	DC12V	DC12V	DC12V
<b>Lights inside the refrigerator</b>	<b>Lights inside the freezing chamber</b>	LED	12V≤2.5W	12V≤2.5W	12V≤2.5W	12V≤2.5W	12V≤2.5W
	<b>Lights inside the refrigerating chamber</b>	LED	12V≤2.5W	12V≤2.5W	12V≤2.5W	12V≤2.5W	12V≤2.5W
	<b>Switch of the refrigerator door</b>	LED	5V≤0.4W	5V≤0.4W	5V≤0.4W	5V≤0.4W	5V≤0.4W

### 5.3 Inside temperature

Temperature tolerance ≤ 2 °C

Compartment	The highest (°C)	Lowest (°C)
Freezing	-14	-24
Refrigerating	9	1
Variable temperature	/	/



## 5.4 Defrosting parts

Defrosting period	Initial defrosting period	Normal defrosting period
		Temperature is lower than 0 °C
Defrosting sensor	NTC	B3839
Defrosting temperature controller	/	/
Thermal fuse	Can't be restored	77 °C
Defrosting heater in freezing chamber	/	Defrosting heater 230V/250W

## 5.5 Circuit diagram

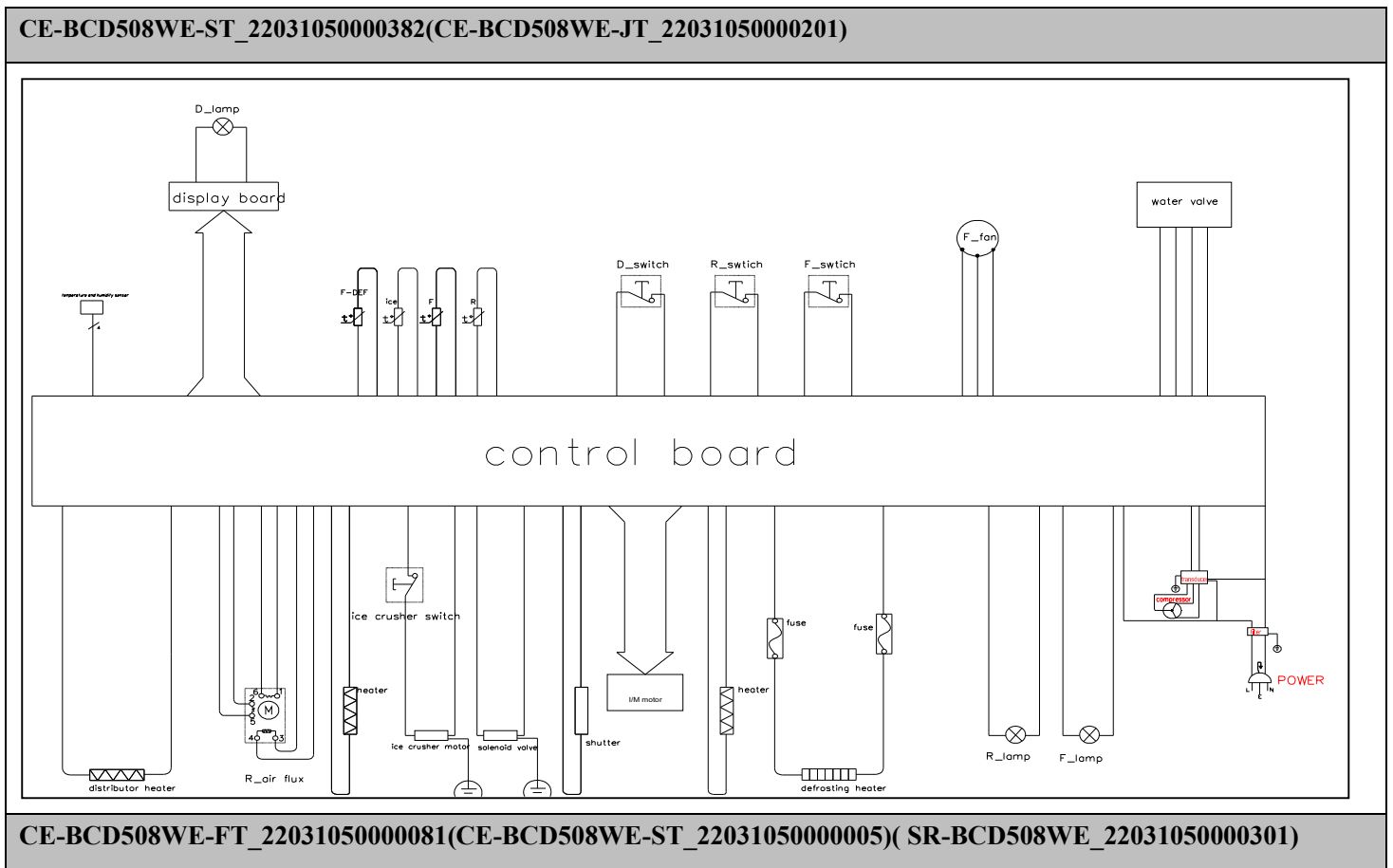

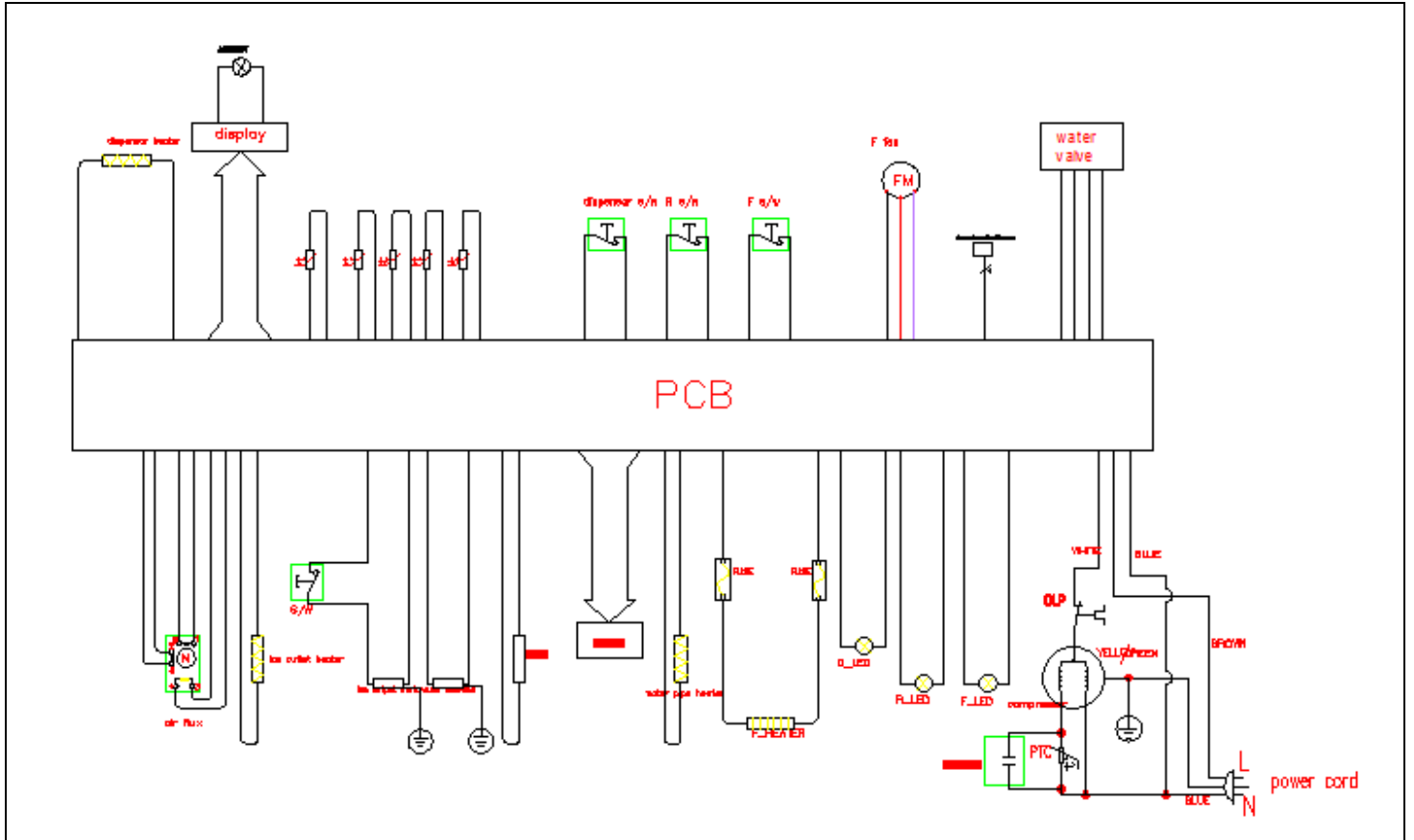

## 6. Internal view and dimension

### 6.1 Main parts and their names

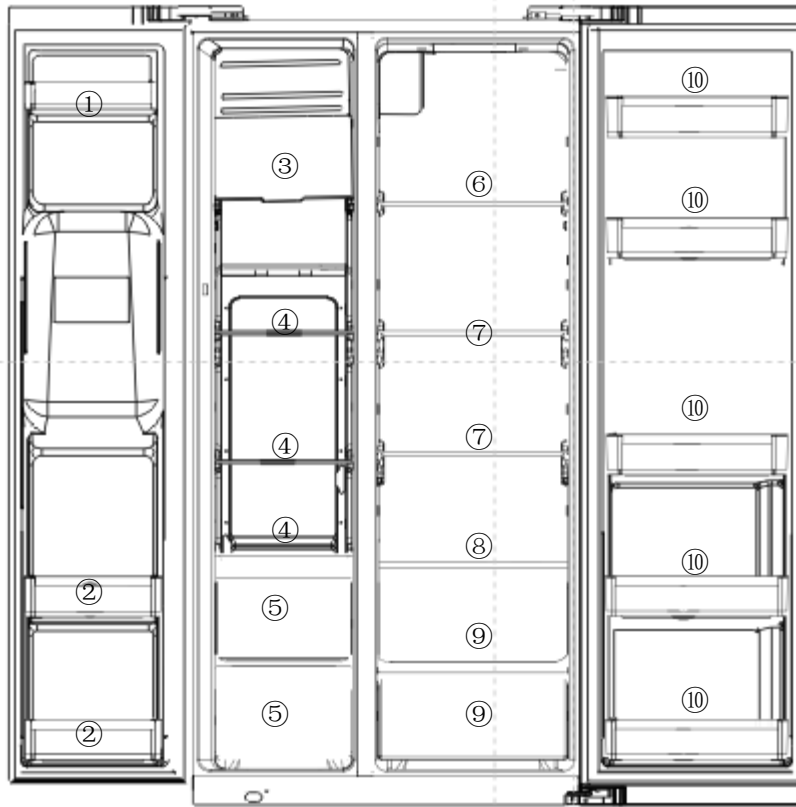

(The picture is only for reference, and specific appearance and configuration are subject to the real product)

Freezer	Refrigerator
1.door rack	6.shelf
2.door rack3.ice tank	7.shelf
4.shelf	8.shelf
5.drawer	9.vegetable crisper
	10.bottle rack

### 6.2 External dimension

Front view	Side view
------------	-----------

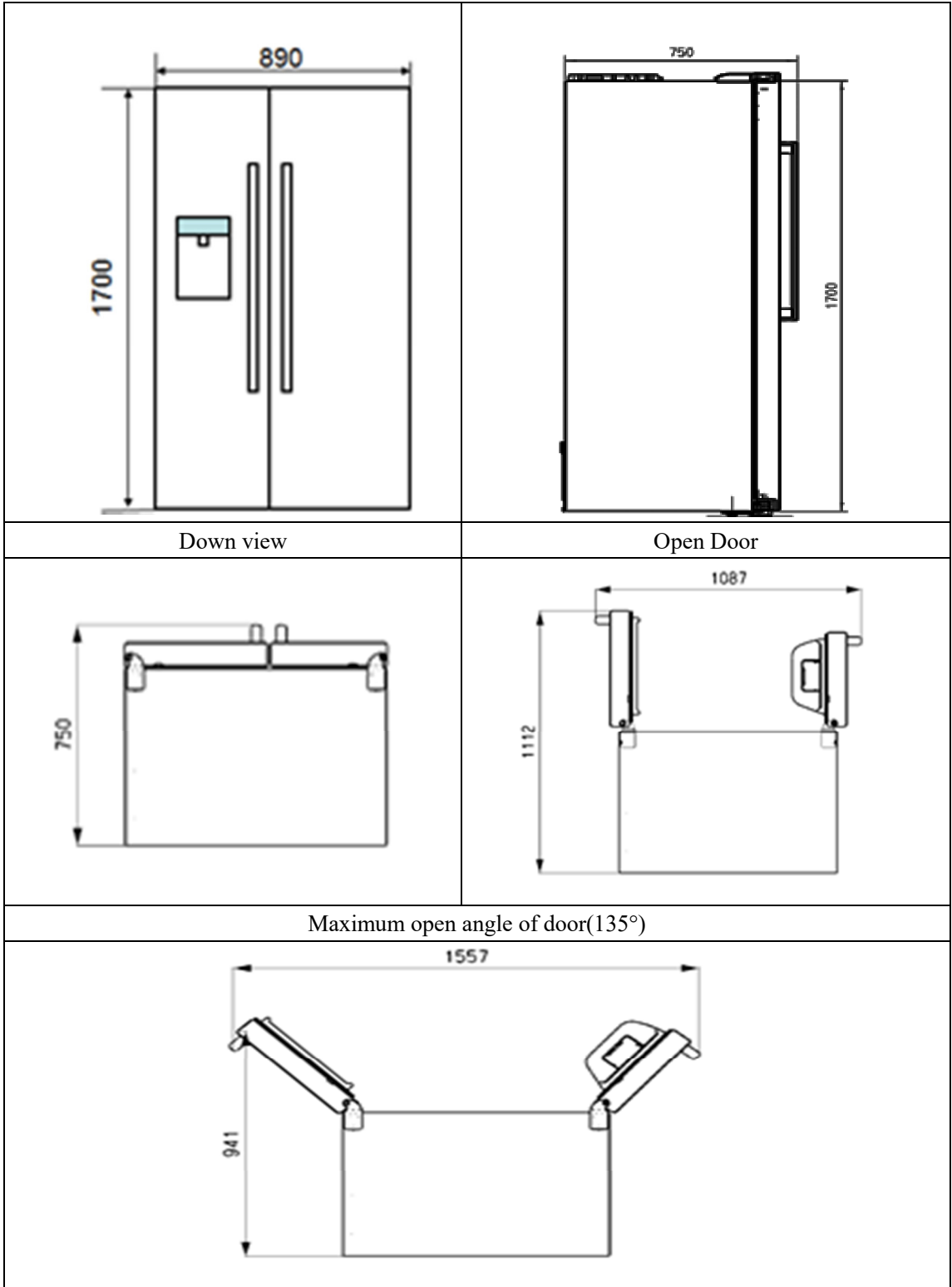

(The picture is only for reference, and specific appearance and configuration are subject to the real product)

## 7. Refrigerating piping system and circulating route of cooling air

### 7.1 Refrigerating piping system

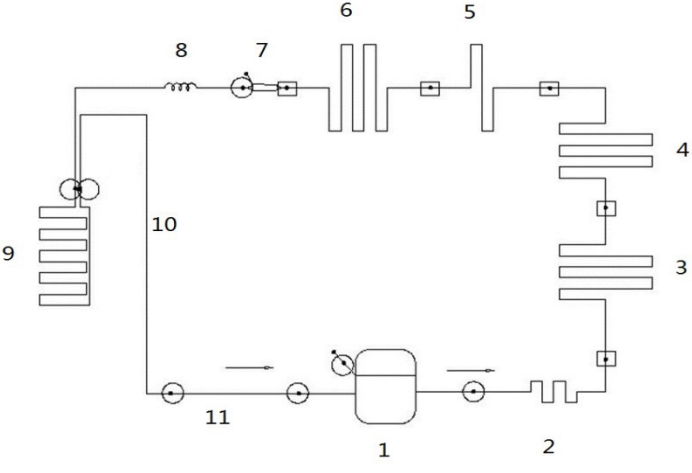
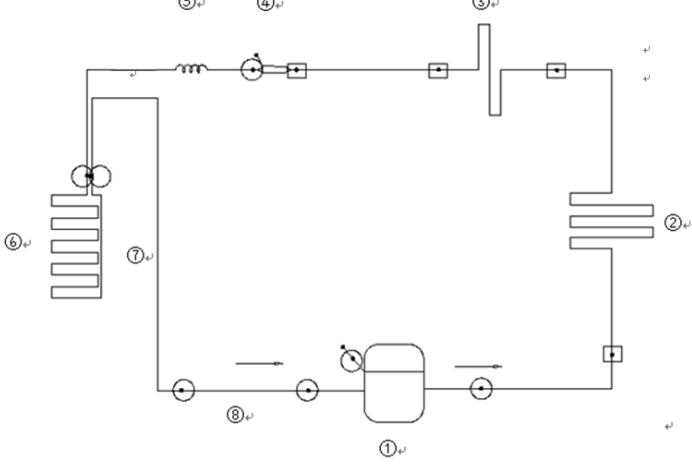
<p>CE-BCD508WE-ST_22031050000382  CE-BCD508WE-FT_22031050000081  CE-BCD508WE-ST_22031050000005  SR-BCD508WE_22031050000301</p>	<p>CE-BCD508WE-JT_22031050000201</p>
<p>1 Compressor→2 Transition pipe→3 Back Condenser→4 Left Condenser→5 Anti-water condensed pipe→6 Right Condenser→7 Drier→8 Capillary Tube→9 Evaporator→10 Suction Pipe→11 Suction connection Pipe→1 Compressor</p>	<p>1 Compressor→2 Condenser→3 Anti-water condensed pipe→4 Drier→5 Capillary Tube→6 Evaporator→7 Suction Pipe→8 Suction connection Pipe→1 Compressor</p>
	

(The picture is only for reference, and specific appearance and configuration are subject to the real product)



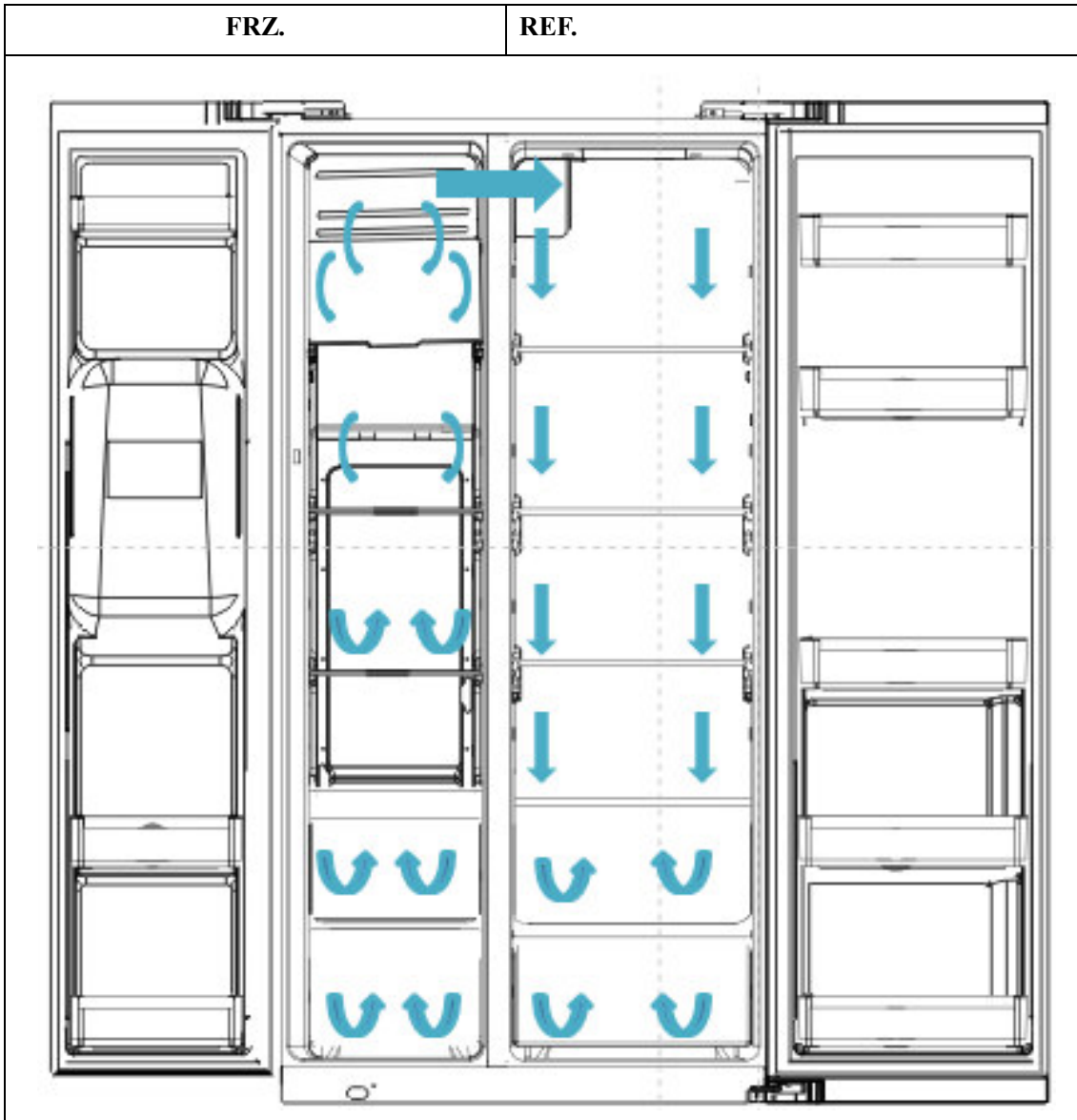

## 7.2 Circulating route of cooling air



(The picture is only for reference, and specific appearance and configuration are subject to the real product)

## 8. 8. Dismantling of parts

### 8.1 Parts on the door



<b>Door seal</b>	
<p>1) 2) Door seal is installed into door liner groove. Open the refrigerator door; Take the door seal ① out of door liner;</p>	
<b>Door tray</b>	
<p>While squeezing it inward, lift up the baffle and take it out from refrigerator liner.</p>	
Door stopper	None
rollover beam	None



### 8.2 Parts inside the refrigerator

<b>Shelves</b>	
<p>1) Lift up the division plate with a proper force and pull it out towards yourself;</p>	

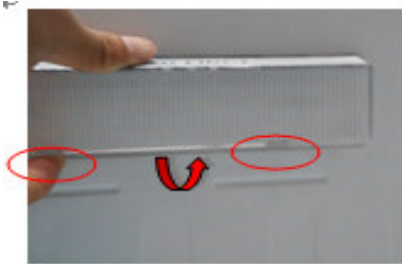

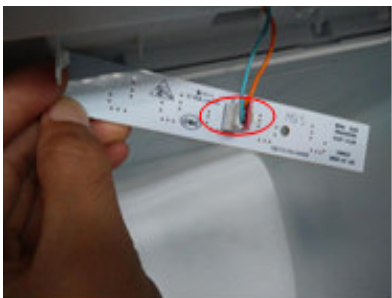
<b>Drawer</b>	
<p>1) 2) The drawer is located at the bottom of freezing and refrigerating chambers; Pull the drawer out completely; Lift it up slightly and take it out from the refrigerator.</p>	

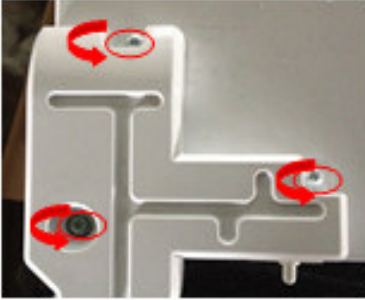
### 8.3 Light system

<b>Light</b>	
<p>1) Turn over the lampshade hard with your hands or two flat-blade screwdrivers at two grooves marked with red circles shown in the picture and take it down</p>	
<p>2 ) Push away the hook with your hand along the arrow direction shown in the picture and separate LED light panel from the hook; then take down LED light panel</p>	
<p>3 ) Remove the connecting harness terminals on LED light panel and take down the LED light panel.</p>	
<b>Light switch</b>	



<p>1) As shown in the picture, loosen by screwdriver 3 fixing screws of the hinge cover and take it down</p>	
<p>2) Press the snap joint in the circle and push it outward along the arrow direction. Complete the disassembly of door light switch.</p>	
<p>Pilot light</p>	<p>None</p>
<p>Fresh light</p>	<p>None</p>

#### 8.4 Air duct components refrigerating chamber

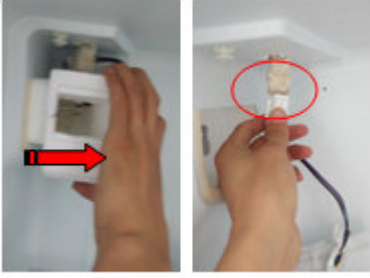
<p><b>Air duct components refrigerating chamber</b></p>	
<p>1 ) Remove by cross screwdriver the screws on the positions shown in the picture anticlockwise.</p>	
<p>2 ) Pull the decoration cover of refrigerating air duct to the right along horizontal direction until air duct decoration cover completely falls off from refrigerator body and air duct foam and take out the decoration cover of refrigerating air duct.</p>	

<p>3 )</p> <p>Catch hold of air duct foam in refrigerating chamber and pull it towards the right along the arrow direction shown in the picture until air duct foam is separated from refrigerator body, remove connecting terminals of ventilation door and take out refrigerating air duct foam.</p>	
--	--

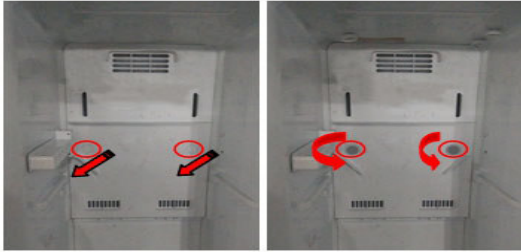
### 8.5 Air duct components in freezing chamber and fan motor

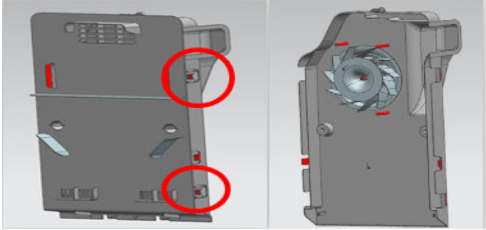
Disassembly and installation of Air duct	
<p>1 )</p> <p>First, take out the screw cap of air duct cover with flat-blade screwdriver or blade; then, remove by cross screwdriver the two screws fixing air duct cover anticlockwise.</p>	
<p>2 )</p> <p>As shown in the right picture, catch hold of upper part of freezing air duct as shown in the picture, pull it outward along the arrow direction with strength until air duct is separated from refrigerator body, remove the connecting harness between fan and refrigerator body, and take down freezing air duct.</p>	
<p>3 )</p> <p>Pull the snap joint of upper air duct outward to make cover plate of upper air duct in freezing chamber fall off from air duct.</p>	

<p>4 )</p> <p>Evaporator cover ahead of freezing chamber After the removal of upper air duct in freezing chamber.</p> <p>Catch hold of cover plate of freezing lower air duct shown in the picture, pull it out along the arrow direction until it is separated from refrigerator body and take it out.</p>	
---	--

**Fan motor of air duct**

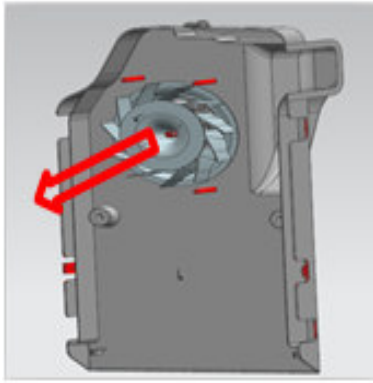
<p>1 )After the removal of cover plate of upper air duct in freezing chamber. Pull the motor fan of upper air duct in freezing chamber outward to make the fan blade separate from the motor.</p>	
---	---

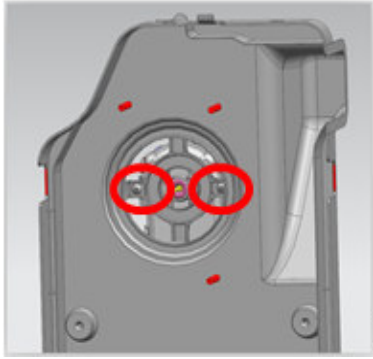
<p>2 )Remove by cross screwdriver the two fixing screws anticlockwise. Complete disassembly of the motor</p>	
--	--

**8.6Evaporator and temperature sensing system**

**Evaporator in freezing chamber**

### Evaporator in freezing chamber

- 1.Remove the air duct components in freezing chamber.
- 2.Disconnect all connectors.
- 3.Remove the welding on inlet and outlet tubes.
- 4.Remove two screws which are used to fix the evaporator and remove the evaporator.

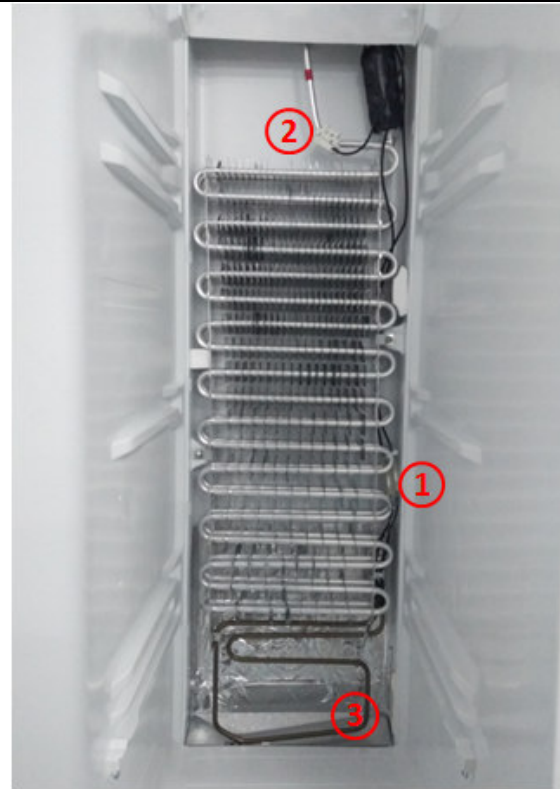

### Components on the evaporator

#### Fuse (①)

- 1.Disconnect the fuse connector.
  - 2.Cut off the band which fixes the fuse.
  - 3.Separate the fuse and the evaporator.
- \*Don't break the welding of the evaporator in case that only the fuse needs to be replaced.

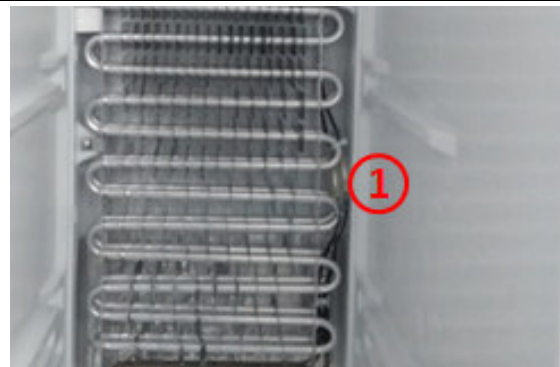



#### Defrost sensor (②)

- The defrost sensor is located on top of the evaporator.
- 1.Disconnect the connector of defrost sensor
  - 2.Cut off the band which fixes the sensor.
  - 3.Separate the sensor and the evaporator.
- \*Don't break the welding of the evaporator in case that only the sensor needs to be replaced.





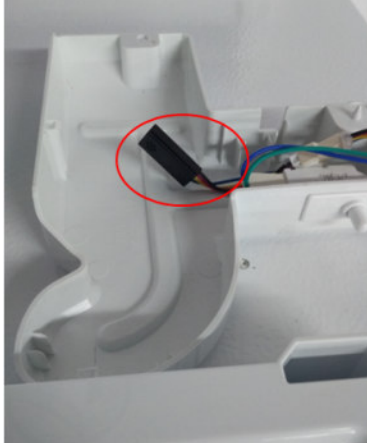

<p><b>Defrost heater(③)</b></p> <p>The defrost heater is located at bottom of the evaporator.</p> <ol style="list-style-type: none"> <li>1.Disconnect the connector of defrost heater.</li> <li>2.Cut off the band which fixes the defrost heater.</li> <li>3.Take off the defrost heater from the evaporator.</li> </ol> <p>*Don't break the welding of the evaporator in case that only the defrost heater needs to be replaced.</p>	
<p><b>Evaporator in refrigerating chamber</b></p>	
<p>Evaporator in refrigerating chamber</p>	<p>None</p>
<p>Components on the evaporator</p>	<p>None</p>
<p>Temperature Controller</p>	<p>None</p>
<p><b>Sensor</b></p>	
<p>Sensor in freezing chamber</p> <p>To remove the sensor cover, you may squeeze it up and down;</p> <p>Take the sensor out from card slot;</p>	
<p>Sensor in refrigerating chamber</p>	<p>Refer to the method of disassembling the freezer compartment sensor.</p>
<p>Sensor in Variable temperature chamber</p>	<p>None</p>
<p>Ambient temperature sensor</p> <p>The sensor used for measurement of ambient temperature is located within upper hinge cover of refrigerating chamber door;</p>	



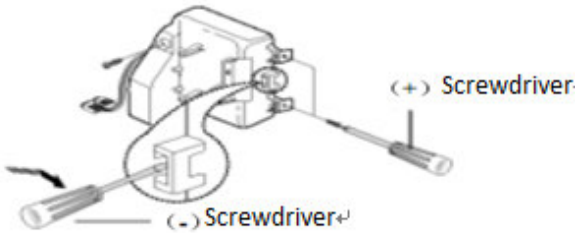
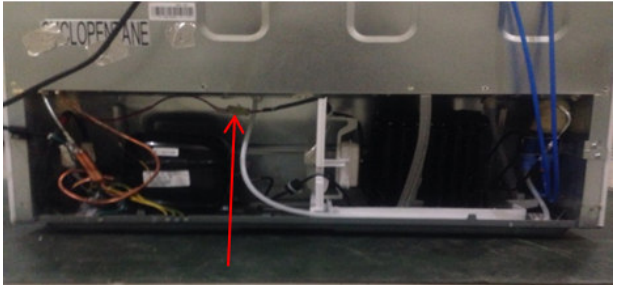
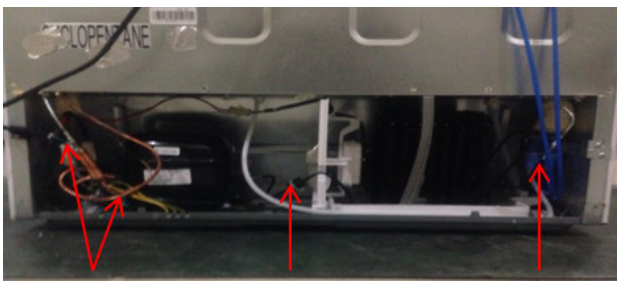

## 8.7 Compressor case

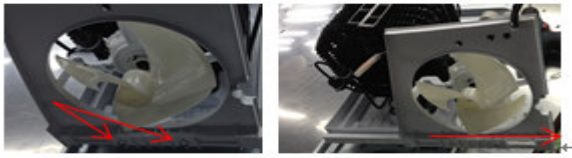
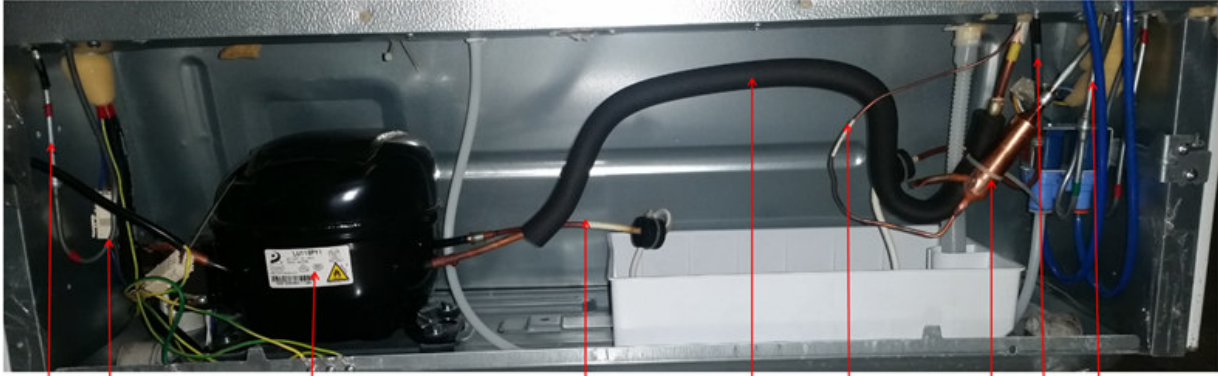
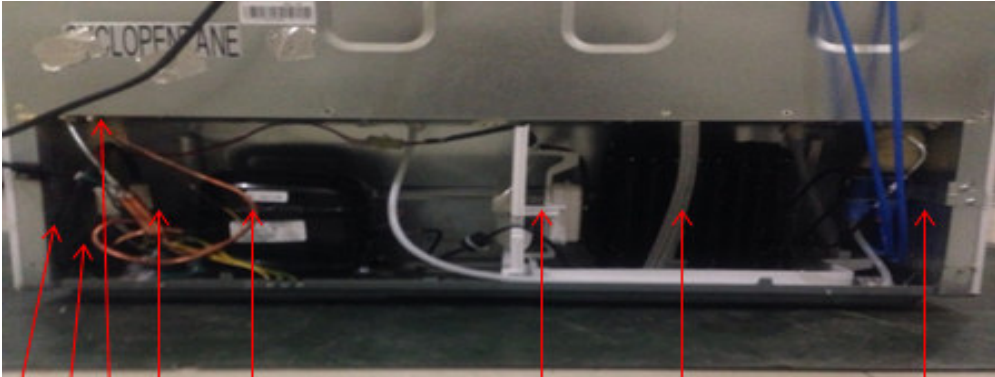
<p>Rear cover and compressor case</p> <p>1) Remove by cross screwdriver the screws fixing back cover plate of compressor chamber anticlockwise</p> <p>2) Take the back cover plate of compressor chamber upward.</p>	
<p>Terminal box of the compressor</p> <p>Remove the screws fixing block terminal, press the tap on block terminal and take down block terminal cover with flat-blade screwdriver.</p>	
<p><b>Condenser fan motor</b></p>	
<p><b>CE-BCD508WE-JT_22031050000201</b></p>	
<p>1) Unplug the wiring connector by pressing the terminal lock</p>	
<p>2) Cut off the pipe what the arrows indicate, then discharge all gas</p>	
<p>3) Lay down the refrigerator in the direction of door towards the ground</p>	

<p>4) rotate the screw anti-clockwise what the arrows indicates in left picture, then pull out the fan bracket towards the direction what the arrows indicate.</p>	
<p><b>Standby condenser</b></p>	<p>None</p>
<p><b>Piping system in the compressor case</b></p>	
<p>CE-BCD508WE-ST_22031050000382 (CE-BCD508WE-FT_22031050000081)  (CE-BCD508WE-ST_22031050000005) (SR-BCD508WE_22031050000301)</p>	
 <p style="text-align: center;">6    5                    1                    2                    9                    8                    7    3    4</p>	
<p>1.Compressor  2.Transition pipe  3.Back Condenser  4.Left Condenser  5.Anti-water condensed pipe</p>	<p>6.Right Condenser  7.Drier  8.Capillary Tube  9.Suction connection Pipe</p>
<p>CE-BCD508WE-JT_22031050000201</p>	
 <p style="text-align: center;">1    2    3    4    5                    6                    7                    8</p>	
<p>1. Suction PipeCapillary TubeAnti-water condensed pipeDrier</p>	<p>2. CompressorCondenser fanCondenserAnti-water condensed pipe</p>

## 8.8 Display control board

1) Use vacuum cap to pull the control panel outwards	
2) Disconnect the fast connector, then remove the control PCB	 

## 8.9 Main control board

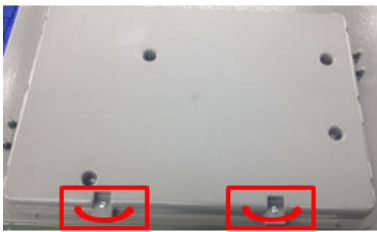
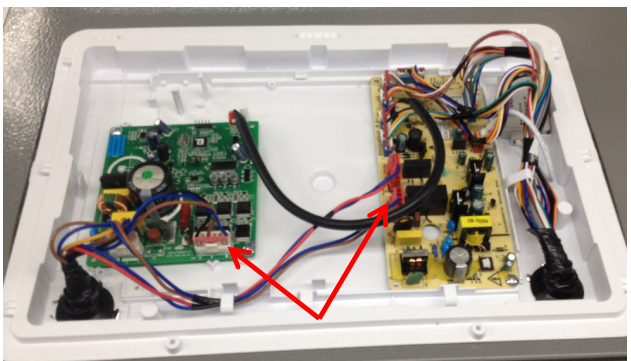
<b>Have variable frequency driver board</b>	
CE-BCD508WE-ST_22031050000382(CE-BCD508WE-JT_22031050000201)	
1) remove the screw anticlockwise, then remove the PCB housing cover	
2) Pull the lock of fast connector upwards, then disconnect the fast connector	

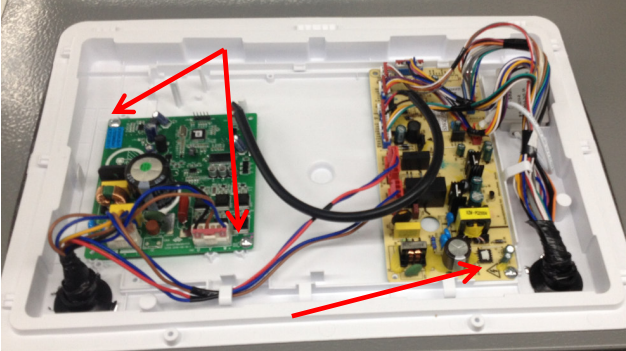
<p>3) Remove the screw anticlockwise, then remove the PCB and variable frequency driver board.</p>	
--	--

**Without variable frequency driver board**  
**CE-BCD508WE-FT\_22031050000081(CE-BCD508WE-ST\_22031050000005)**  
**(SR-BCD508WE\_22031050000301)**

<p>1) remove the screw anticlockwise, then remove the PCB housing cover</p>	
---	--

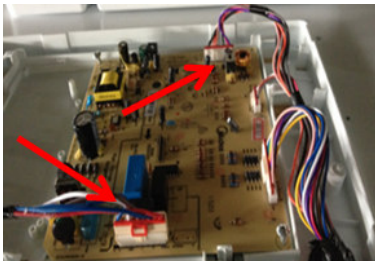
<p>2) Pull the lock of fast connector upwards, then disconnect the fast connector</p>	
---	---

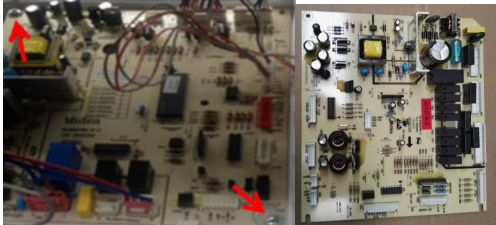
<p>3) Remove the screw anticlockwise, then remove the control PCB</p>	
---	--

**8.10 Bar counter(None)**





Disassembly and installation of bar counter	None
Disassembly and installation bar doorseal	None

**8.11 Water dispenser(None)**

Disassembly and installation of water valve	None
Disassembly and installation of water tank	None

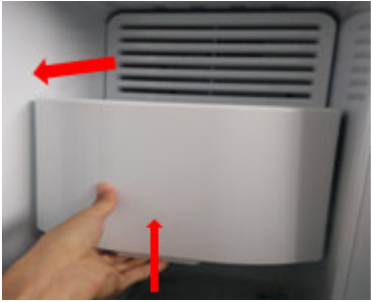

## 8.12 Ice maker

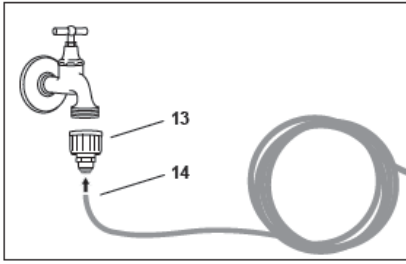
disassembly of ice maker(only professionals are permitted to operate)	
<p>1) As shown in the photo, please up lift the ice storage box assembly and pull it out, then the ice storage box can be taken out.</p>	
<p>2) Pull the ice tray assembly outwards forcefully, and disconnect the wiring connector, then the ice tray assembly can be taken out from refrigerator.</p>	
<p>3) Use cross screwdriver(anticlockwise) to remove the screws of protective cover of wiring connector</p>	
<p>4) Use cross screwdriver (anticlockwise) to remove the 4 screws of motor of ice releasing, then the motor can be taken out from refrigerator.</p>	
assembly of water system	
<p>You need a suitable adapter for connecting the water pipe with the water tap.</p> <p>1) Please insert the water pipe(14) into one end of adapter(13);</p> <p>2) Fix another end of adapter on the water tap.</p>	

- 3) Remove the cap of water pipe(16);
- 4) Insert the end of water pipe into one end of fast connector(15);

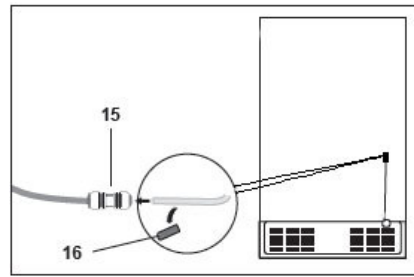

**Disassembly of filter(refer to A or B)**

**Disassembly of filter built-in**

**CE-BCD508WE-FT\_22031050000081(CE-BCD508WE-ST\_22031050000005)( CE-BCD508WE-JT\_22031050000201) (SR-BCD508WE\_22031050000301)**

The filter is located in the upper right of the refrigerator, rotate 90 ° in the direction of the arrow to remove the filter.

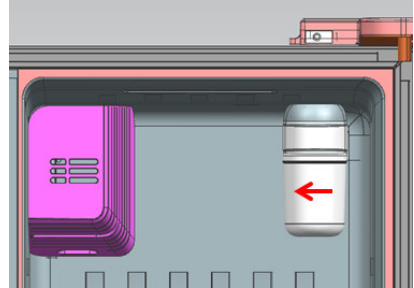

**Disassembly of filter external**

**CE-BCD508WE-ST\_22031050000382**

Pull out the plug. Turn off the water intake. Take off the filter and the snap ring on the quick connector and then pull out the water pipe. Insert the new filter into the quick connector and then install the snap ring. Re-supply water and check whether there is water flowing out.

If necessary, please repeat above steps. Insert the plug again. Keep pressing the button for 3 seconds to start up the filter. The display of disappears.

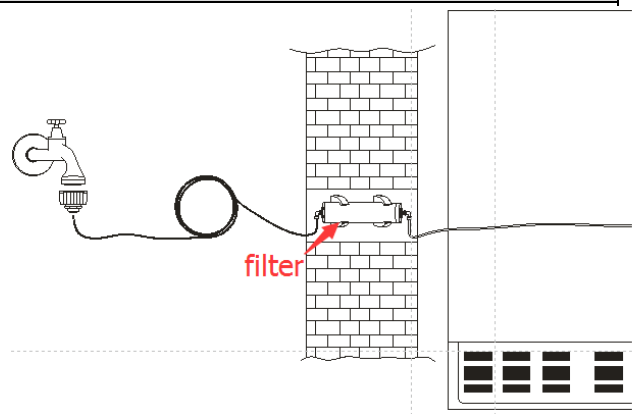

## 9. Function and operation 9.1 Operation panel

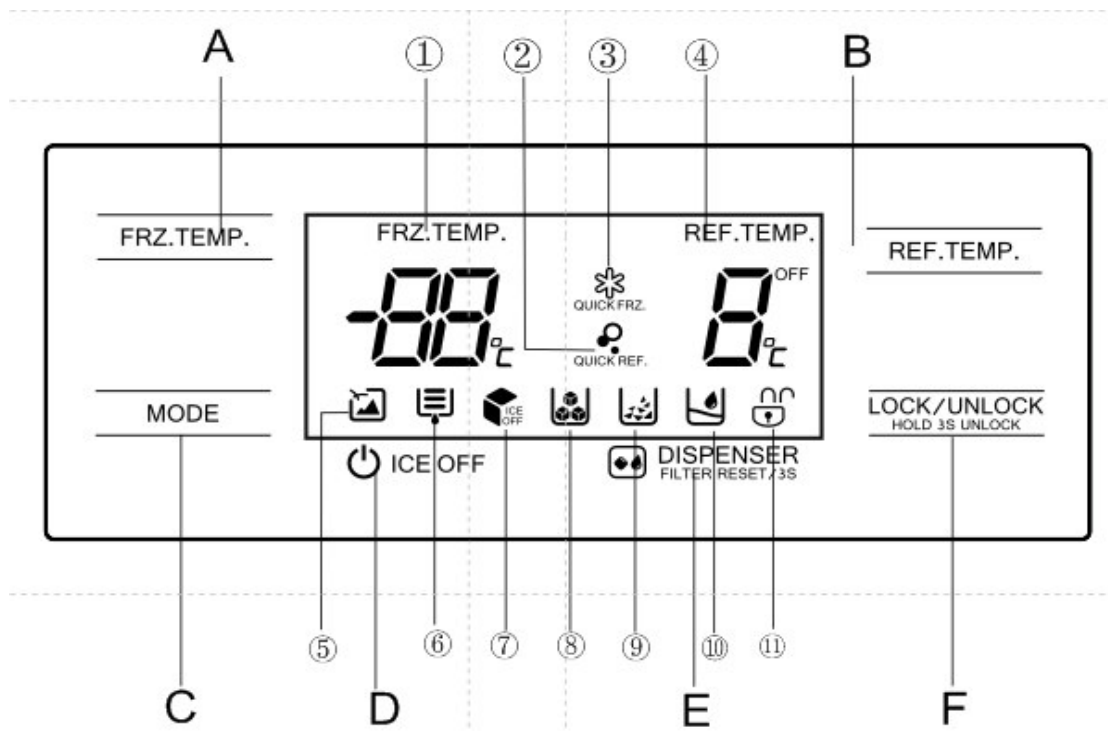

<p>Icons:</p> <ol style="list-style-type: none"> <li>1. display zone of frozen temperature</li> <li>2. icon of fast cooling</li> <li>3. icon of fast freezing</li> <li>4. display zone of cooling temperature</li> <li>5. vacation icon</li> <li>6. reminding icon of filter replacement</li> <li>7. icon of ice maker turn off</li> <li>8. ice taking icon</li> <li>9. crushed ice taking icon</li> <li>10. cooling water taking icon</li> </ol>	<p>Button:</p> <p>A FRZ. TEMP.          B REF. TEMP.          C MODE          D ICE OFF          E DISPENSER          F LOCK/UNLOCK</p>
---	---

### 9.2 Temperature control

#### 1) Temperature adjustment of refrigerator compartment

Press “REF. TEMP” button, the display digital of cooling temperature will blink, then press “REF. TEMP” to adjust setting temperature, the setting temperature is changed circularly “8°C · 7°C... · 2°C · 8°C.....”

#### 2) Temperature adjustment of Freezer compartment

Press “FRZ. TEMP” button, the display digital of frozen temperature will blink, and then press “FRZ. TEMP” to adjust setting temperature, the setting temperature is changed circularly “-16°C → -17°C... → -24°C → -16°C.....”

#### 3) Frequently-used MODE

Press “MODE” button, consumer can set “vacation”->”fast freezing”->”fast freezing + fast cooling”->”fast cooling”->”vacation”->...” circularly, the icons of corresponding modes will light on/off synchronously

Vacation mode: the freezer compartment will work as the setting temperature is -18°C, the refrigerator

compartment is turn off;

Fast freezing mode: the freezer compartment will work as the setting temperature is  $-24^{\circ}\text{C}$ , and after 26 hours the freezer compartment will quit this mode automatically and work according to last temperature setting;

Fast cooling mode: the refrigerator compartment will work as the setting temperature is  $2^{\circ}\text{C}$ , and after 150 minutes the refrigerator compartment quit this mode automatically and work according to last temperature setting;

When press "REF. TEMP" or "FRZ. TMEP" button, the "Vacation Mode" will be stopped, the refrigerator compartment and freezer compartment will work according to last temperature setting;

When press "FRZ. TEMP" button, the "Fast Freezing Mode" will be stopped, the freezer compartment will work according to last temperature setting;

When press "REF. TEMP" button, the "Fast Cooling Mode" will be stopped, the refrigerator compartment will work according to last temperature setting;

### 9.3 give an alarm

When refrigerator door or freezer door is open, the display panel is light on.

there is no notification tone when open door; if refrigerator door or freezer door is open last for 120s, there will be buzzer alarm, afterwards give alarm one time per second, press any buttons on control panel can cancel this buzzer alarm.

Note: under the situation of the refrigerator compartment turn off, the door switch and internal lamp works properly.

Note:hen open the door, the display panel is light on; when the door is closed, the display panel will be light off after 30s if there is no any operation on display panel

### 9.4 Defrosting

#### Defrosting theory and steps:

Defrosting theory:

The defrosting of evaporator is realized by the heating of heater, following the temperature rise, the frost on evaporator becomes water, and the water flow into the evaporating pan via the draining system, the water in evaporating pan evaporate away finally

Defrosting steps:

Compressor switch off- -air duct closed---the fan in freezer chamber works for 3~10 min(for different kinds of refrigerators, the time is different too)---the heater start working---the heater switch off when the temperature rise to setting---defrosting done.

### 9.5 Function Selection

1) Ice maker on/off

Press "ICE OFF" button to turn on/off ice maker, the default setting is off

2) Options for ice /cooling water

Press "DISPENSER" button to choose "ice taking", "crushed ice taking" and "cooling water taking" circularly, the corresponding icons will light on/off

The reminding icon of filter replacement will light on after the filter works last for 150 days., and the icon will blink after the filter works last for 180 day, reset the timer by pressing "DISPENSER" button for 3s.

3) Time setting of water intake of ice maker

Press both "FRZ. TEMP" button and "REF. TEMP" button last for 2 s, the control panel will enter into setting status, press "REF. TEMP" button or "FRZ. TEMP" to increase or reduce the intake time

(The adjustable range is from 5s to 25s), the setting time is displayed in FRZ. Temperature zone.

Lock the panel or press both "FRZ. TEMP" button and "REF. TEMP" button last for 2 s will quit the setting status.

4) Mandatory mode (mandatory compressor starting, mandatory defrosting and mandatory ice making)

All below functions are only for diagnosis purpose, we advise to restart the refrigerator by power on/off if have



used these functions.

Buttons operation:

Press both “LOCK/UNLOCK” and “FRZ.TEMP” button last for 3s to enter into/quit mandatory mode, the setting will take effect after locking.

Press “FRZ.TEMP” button, the ref. temperature zone will display “1” “2” “3” “4” circularly,

Different figures represent different functions:

- 1) When display “0”, the refrigerator will not enter into anyone mandatory mode, and quit the mandatory mode.
- 2) When display “1”, the compressor will start working last for 36 hours, then it will quit this mode automatically and back to normal working status.
- 3) When display “2”, the evaporator heater will start work last for 2 min at least.
- 4) When display “3”, the ice maker will turn over the ice for twice, then intake water.

### 9.6 Self-diagnosis

Communication self-diagnosis

The system will verify the communication with 8s after 1<sup>st</sup> time power on. If failure happens, it will display the error code immediately. During normal working, if the failure happens last for 1 minute, it will display the error code.

The ice maker will conduct self-diagnosis during working

If the failures can be recovered automatically, the error can be lifting automatically

### 9.7 Compressor fan control(None)

### 9.8 Error code and solution

Table 9-1: Fault Codes Table

Error Code	Failure Type	Solution
E0	Mechanical fault of ice maker	to check relevant connectors, feedback signal of ice maker, motor of ice maker and main PCB
E1	Circuit fault of refrigerating temperature sensor	to check relevant connectors, sensor and main PCB
E2	Circuit fault of Freezing temperature sensor	to check relevant connectors, sensor and main PCB
E5	Circuit fault of evaporator heater sensor	to check relevant connectors, sensor and main PCB
E6	Communication fault	to check relevant connectors, main PCB
E7	Circuit fault of ambient temperature sensor	to check relevant connectors, sensor and main PCB
EE	Circuit fault of ice maker sensor	to check relevant connectors, sensor and main PCB
EH	Circuit fault of ambient humidity sensor	to check relevant connectors, main PCB

## 10. Circuit description

### 10.1 Power Supply

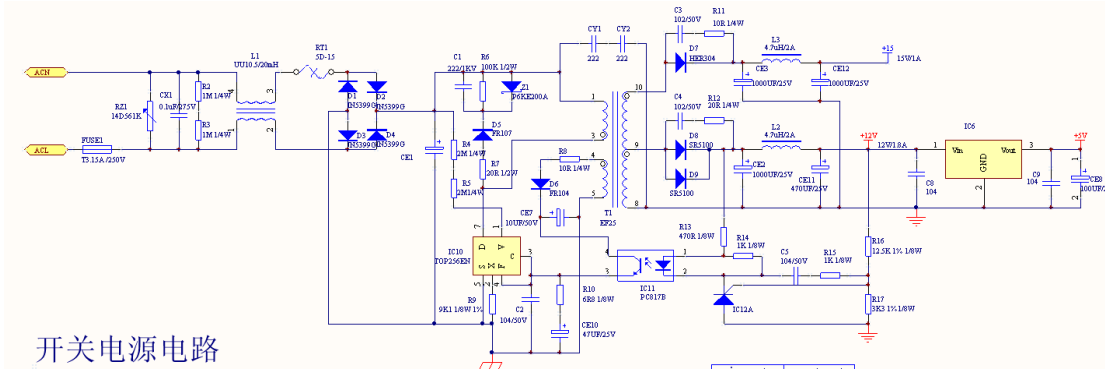

AC input power would be reduced by SMPS control chip, then output stable DC12V and DC15V power after treated by LC and filter. DC12V power is provided to relay (control strong electricity), internal lamp and control panel, DC15V powers are provided to fan motor (voltage variation control the RPM of motor, lowest voltage is 8V). DC12V power is changed into DC5V power by regulator, to provide main control chip with power, monitoring the temperature status of refrigerator

### 10.2 Test circuit for door switch

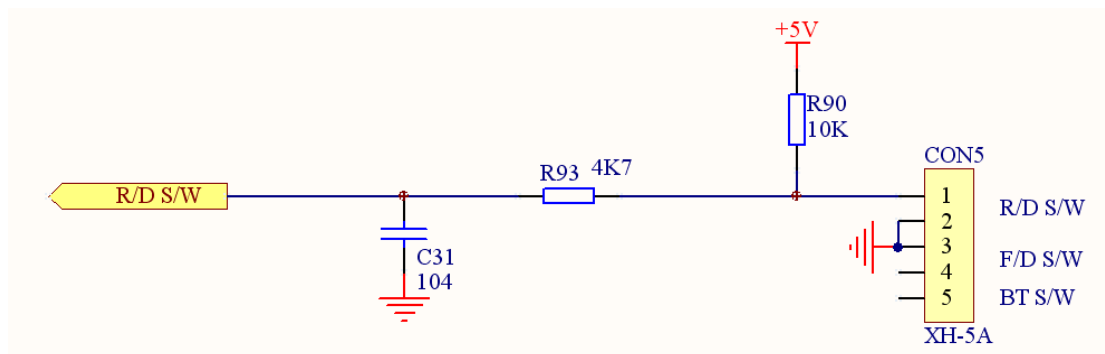

As show as above picture, take the door switch of refrigerator as example, the door switch is connected between 1 and 2 serially, when door is closed, the switch is in off-state, high-level be be detected at MCU port; when the door is open, the switch is in on-state, low-level can be detected at MCU port. by high-level or low level detected, MCU can judge the door is closed or open.

### 10.3 Temperature test circuit

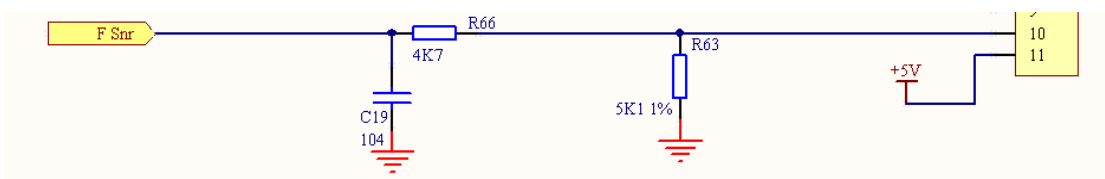

Take the temperature sensor of freezer compartment as example, this sensor is connected between 10 and 11 serially, by utilizing the characteristic of Ohmic value reduced following the temperature rise, sensor and

temperature acquisition circuit constitute voltage divider circuit, MCU figure out the Ohmic value by the divider value, and conclude the freezer compartment temperature according to Ohmic value-temperature value table

### 10.4 Freezer fan motor circuit

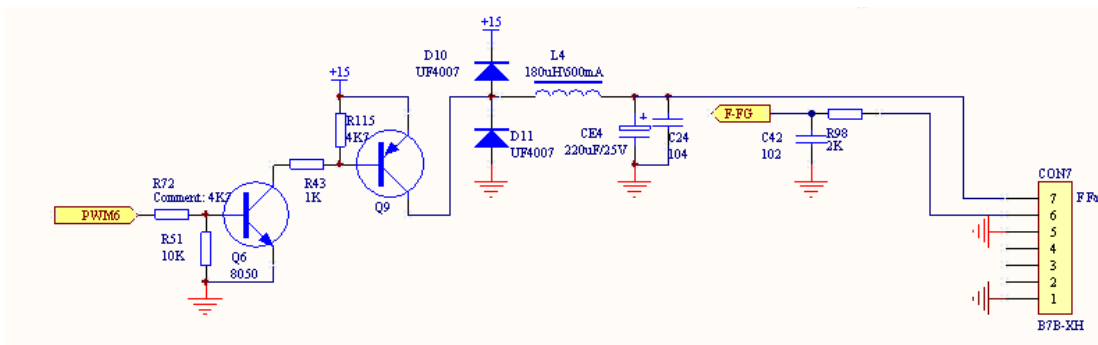

The freezer fan is connected between 7 and 5. When the fan is requested to work, MCU send controlling signal to output PWM wave, and Q9 turn on and turn off periodically ,Periodical current will be filtered by LC,and output regular voltage, MCU can change the PWM wave shape so as to adjust the voltage value

### 10.5 REF.fan motor circuit(None)

### 10.6 Condenser fan motor circuit(None)

### 10.7 Damper motor circuit

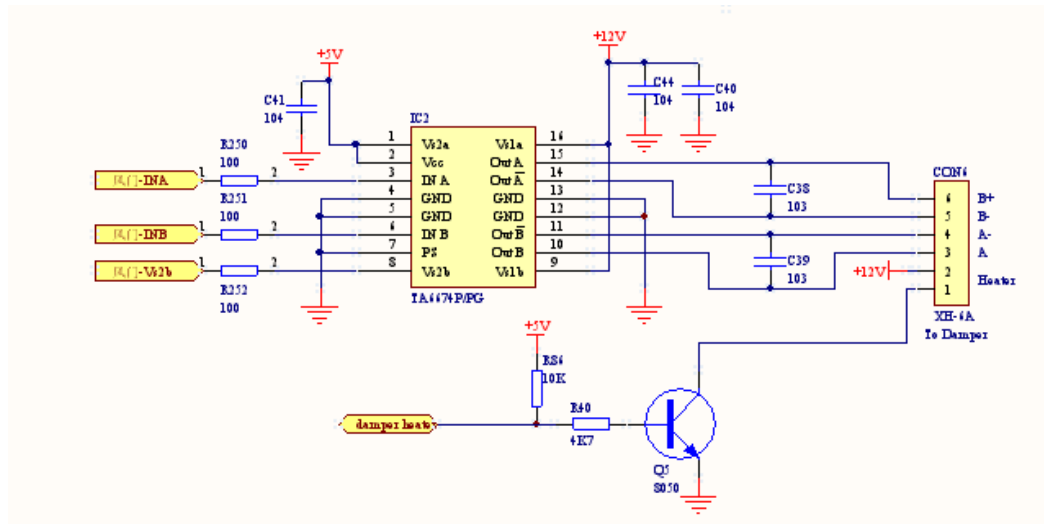

The damper is controlled by stepping motor, the output is square wave by control of speical control chip, when the refrigerator comparment request cooling , the motor switch on, otherwise, the motor switch off.

### 10.8 Sensor resistance(R/T)

Tx(°C)	R ( KΩ )	Tx(°C)	R ( KΩ )	Tx(°C)	R ( KΩ )	Tx(°C)	R ( KΩ )	Tx(°C)	R ( KΩ )
-30	33.81	-15	14.31	0	6.495	15	3.141	30	1.617

-29	31.85	-14	13.55	1	6.175	16	2.999	31	1.55
-28	30.01	-13	12.83	2	5.873	17	2.865	32	1.486
-27	28.29	-12	12.16	3	5.587	18	2.737	33	1.426
-26	26.68	-11	11.52	4	5.315	19	2.616	34	1.368
-25	25.17	-10	10.92	5	5.06	20	2.501	35	1.312
-24	23.76	-9	10.35	6	4.818	21	2.391	36	1.259
-23	22.43	-8	9.82	7	4.589	22	2.287	37	1.209
-22	21.18	-7	9.316	8	4.372	23	2.188	38	1.161
-21	20.01	-6	8.841	9	4.167	24	2.094	39	1.115
-20	18.9	-5	8.392	10	3.972	25	2.005	40	1.071
-19	17.87	-4	7.968	11	3.788	26	1.919	41	1.029
-18	16.9	-3	7.568	12	3.613	27	1.838	42	0.9885
-17	15.98	-2	7.19	13	3.447	28	1.761	43	0.9506
-16	15.12	-1	6.833	14	3.29	29	1.687	44	0.914

# 11. Troubleshooting Method

## 11.1 No cooling (Air cooling-Electronic)

### No cooling of F room and R room

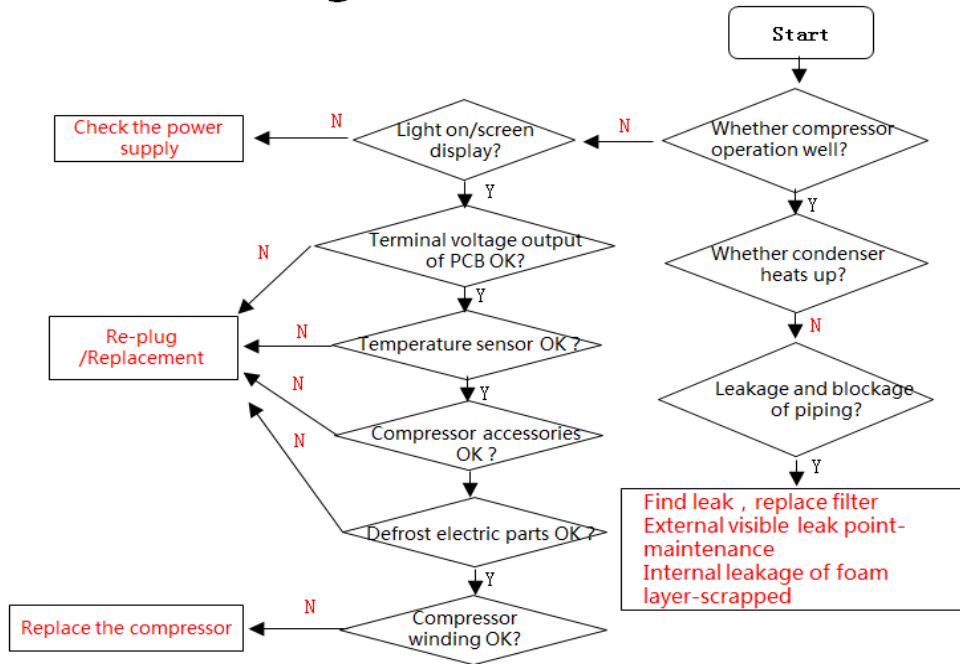

### F room cooling, R room no cooling

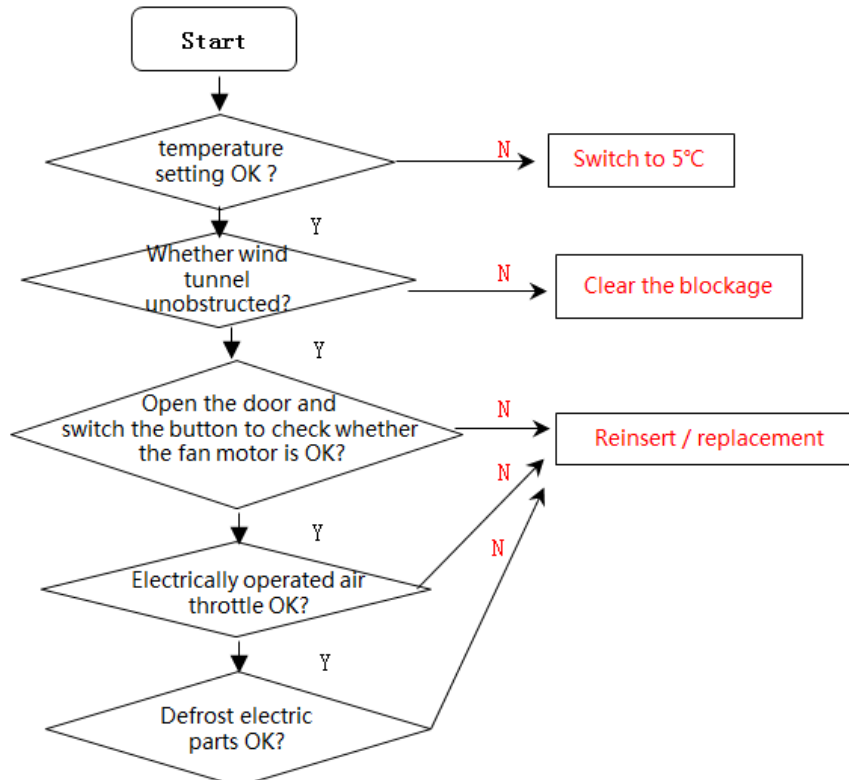

### 11.2 No working of compressor

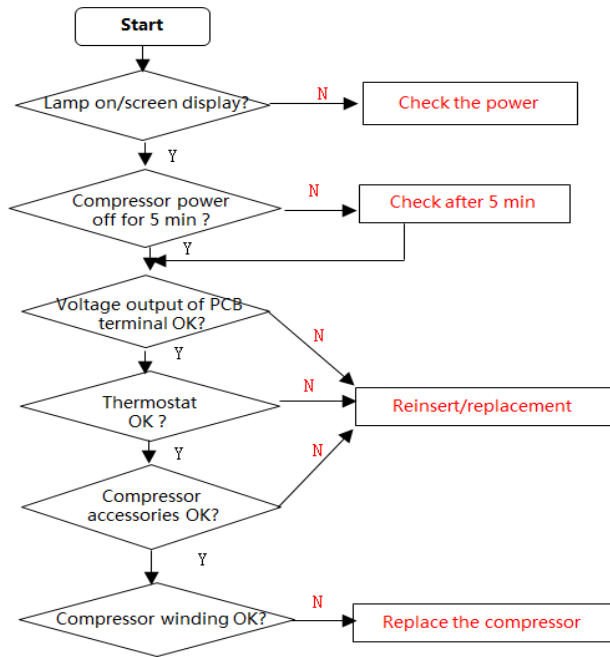

### 11.3 Inside frosting, no defrosting

#### Inside frosting, no defrosting

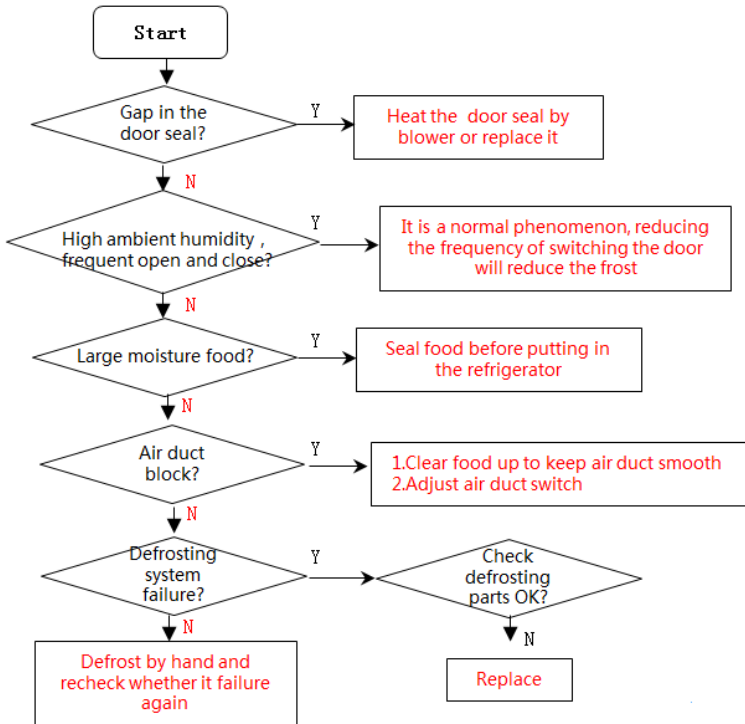

## 11.4-Inside frosting, no defrosting-Maintenance guidelines

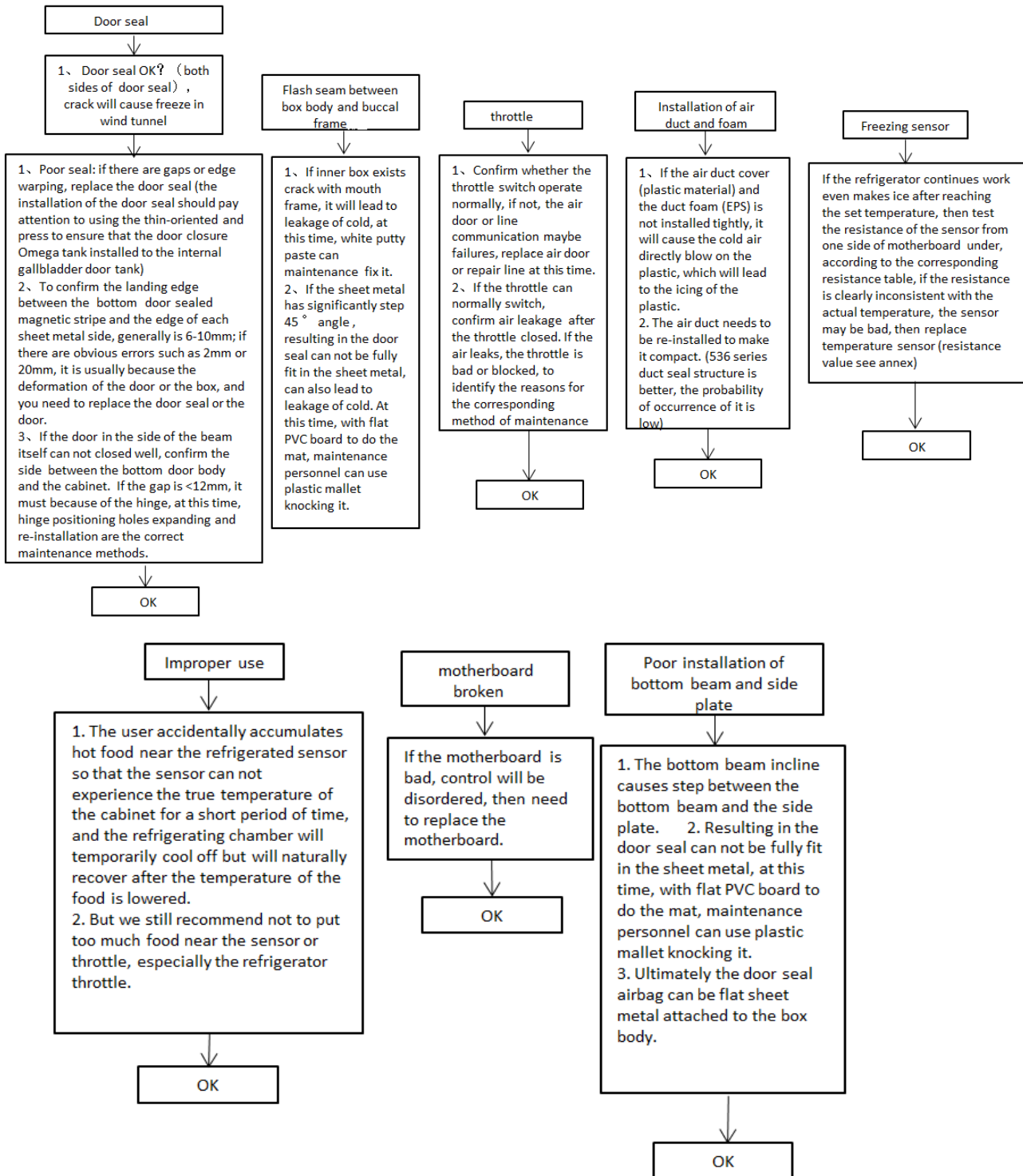

### 11.5 Light is not on

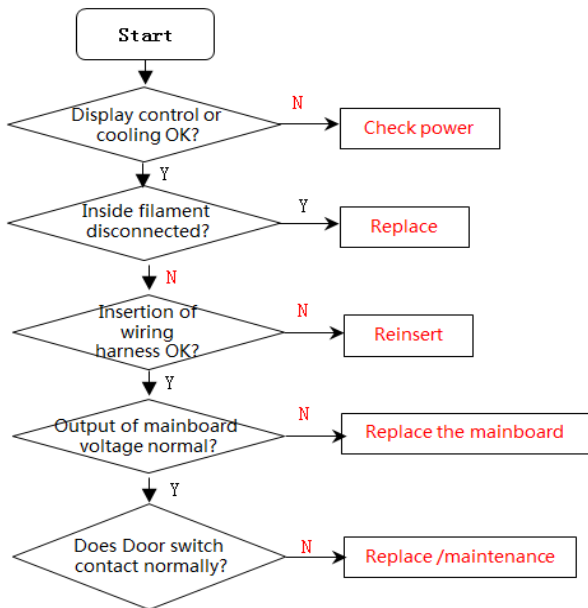

### 11.6 Air duct not operated(electronically)

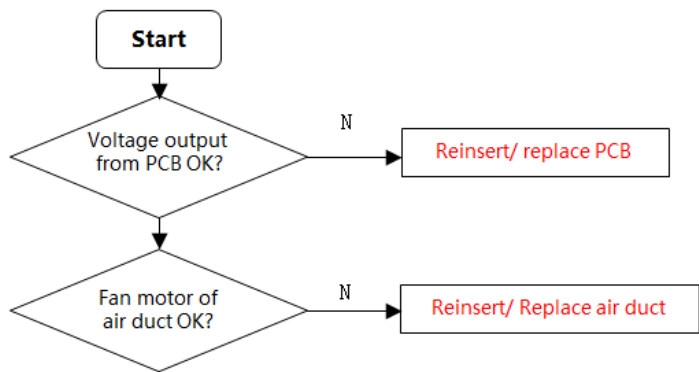



## 11.7 Fan failure

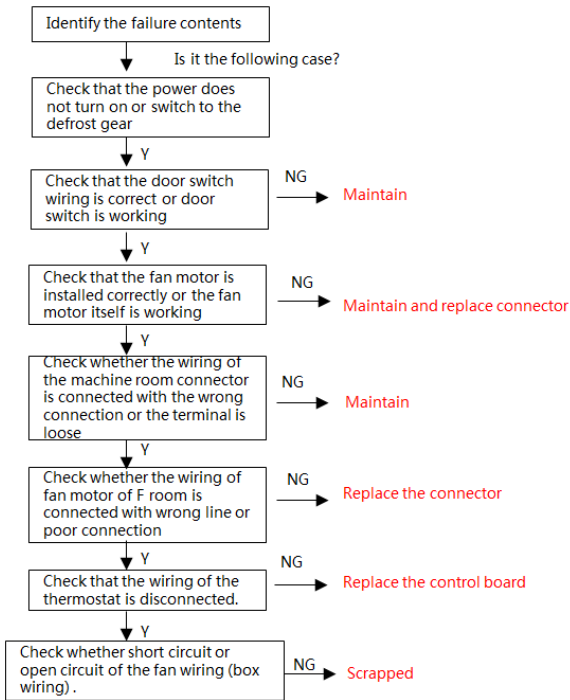

Normal phenomenon for no working of the fan:

1. Poor fan connection or poor installation, loose or reverse of the door switch connector
2. Poor fan installation, leaf contact with the inner board of the foam or touch the line.
3. Insurance circuit of the fan wiring.
4. The timer is not reset in the defrost position .
5. The wire terminals inside the machine compartment connector or control board connector are loose.
- 6 . The door switch itself is defective or the circuit board is defective (electronic refrigerator).

## 11.8 Defective defrost circuit

### Defective defrost circuit

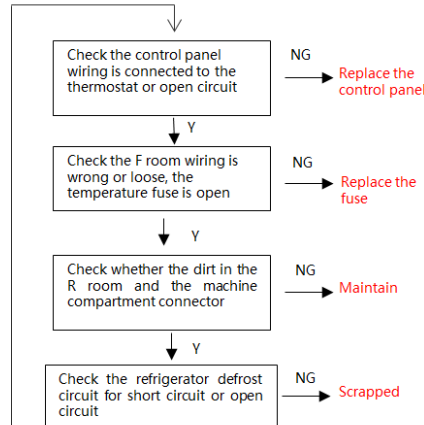
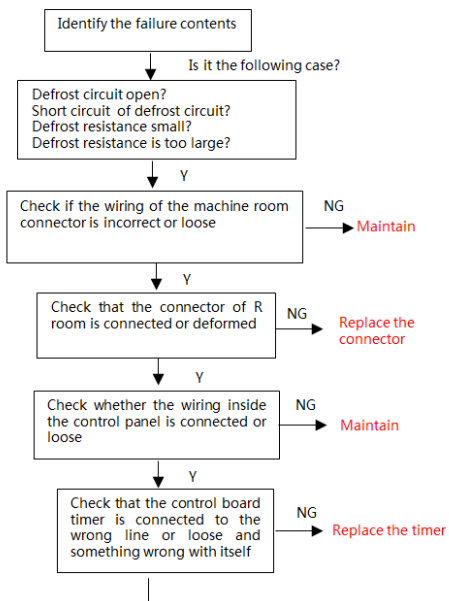

△With a multimeter to measure the refrigerator power plug poles, the timer transferred to defrost position measured resistance should be in the range of 6 ~ 8K for qualified  
 △Check whether the mating of the terminal and the hole is strong and the wiring of the female and male connector is matched (in general, the color line corresponds to the color line)  
 △Check that the timers are wired for compliance  
 △Inspect leaks or deformation of the connector

Common phenomenon of poor defrost circuit :

1. The defrost fuse is open.
2. The timer is connected to the wrong line.
3. The connector has a leaky bubble liquid that is not clean.
4. The connector is not tight enough to be loose.
5. The internal wiring of the box is open.

## 11.9 Noise

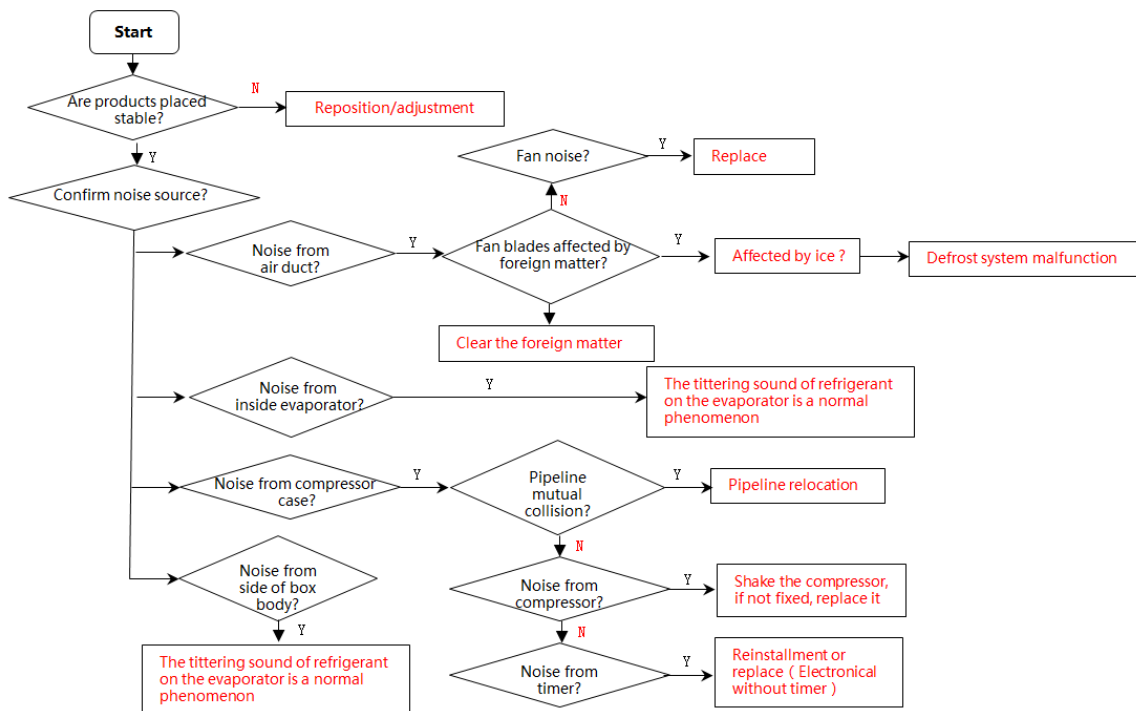

## 12. Figures and details of repair parts(Documents are provided separately)

### 12.1 Figures

### 12.2 List of parts and components

## 13 Appendix:

### 13.1 Electrical Schematic Diagram

(Model: \*\*\*)

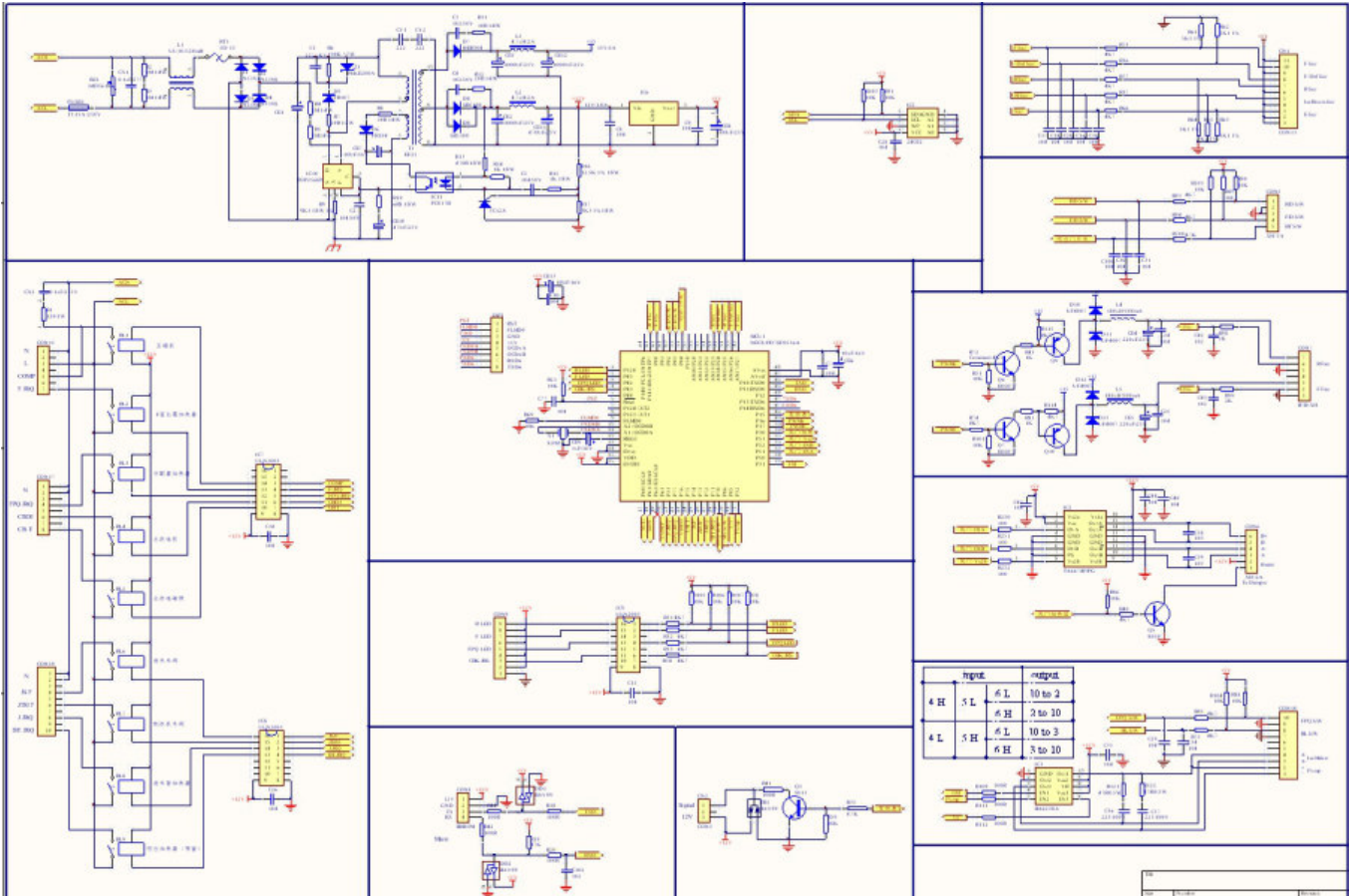

13.2 Refrigerator maintenance tooling and equipment and material

**Tooling**

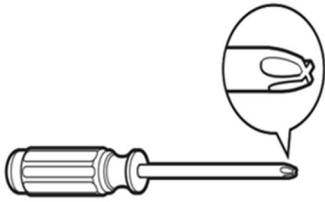
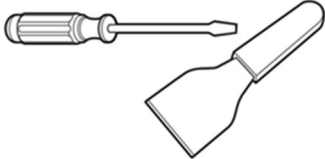
No.	Name	Photo	Main Usage
1	Phillips screwdriver		screw assemble and disassemble
2	slotted screwdriver/scrapper		screw and rivet assemble and disassemble

## **Midea Refrigerators**

If you need to get detailed technical information from the manufacturer, please contact:

[xxx@midea.com](mailto:xxx@midea.com)

**Refrigeration Division**

**Overseas Sales Company**

Address: No. 176, Jinxiu Avenue, Economic-Technological Development Area, Hefei, Anhui, China

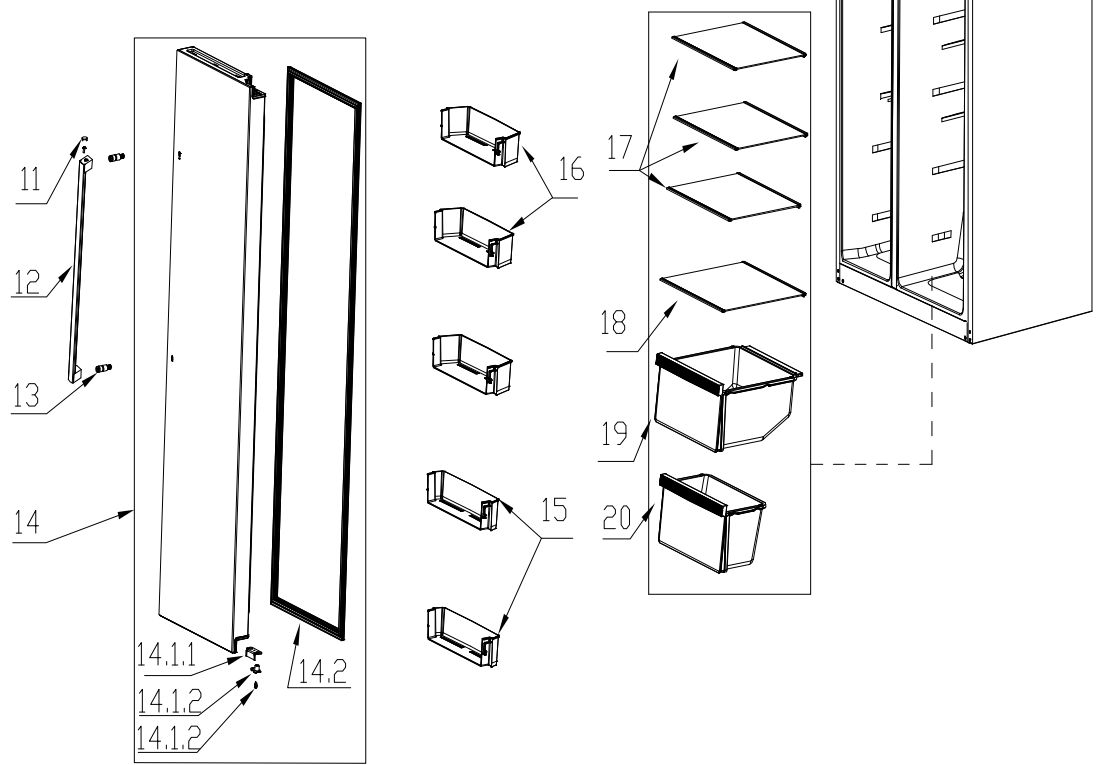
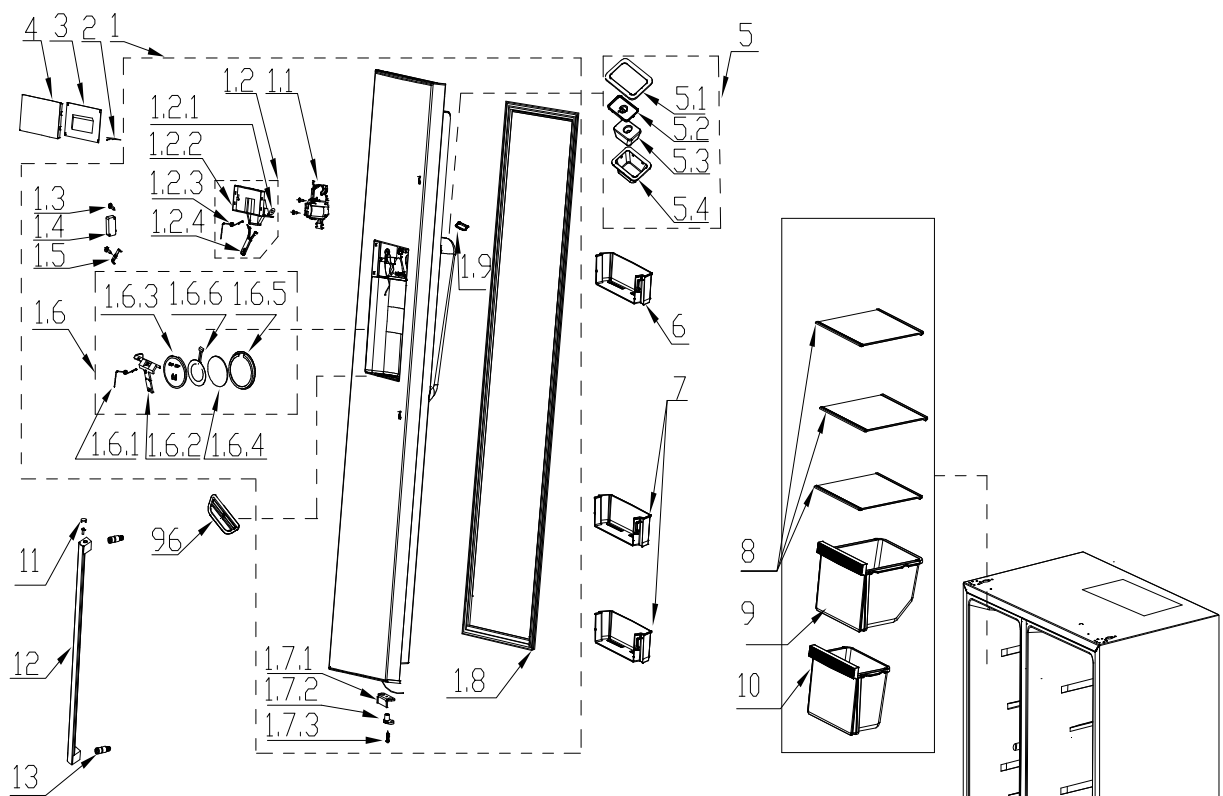

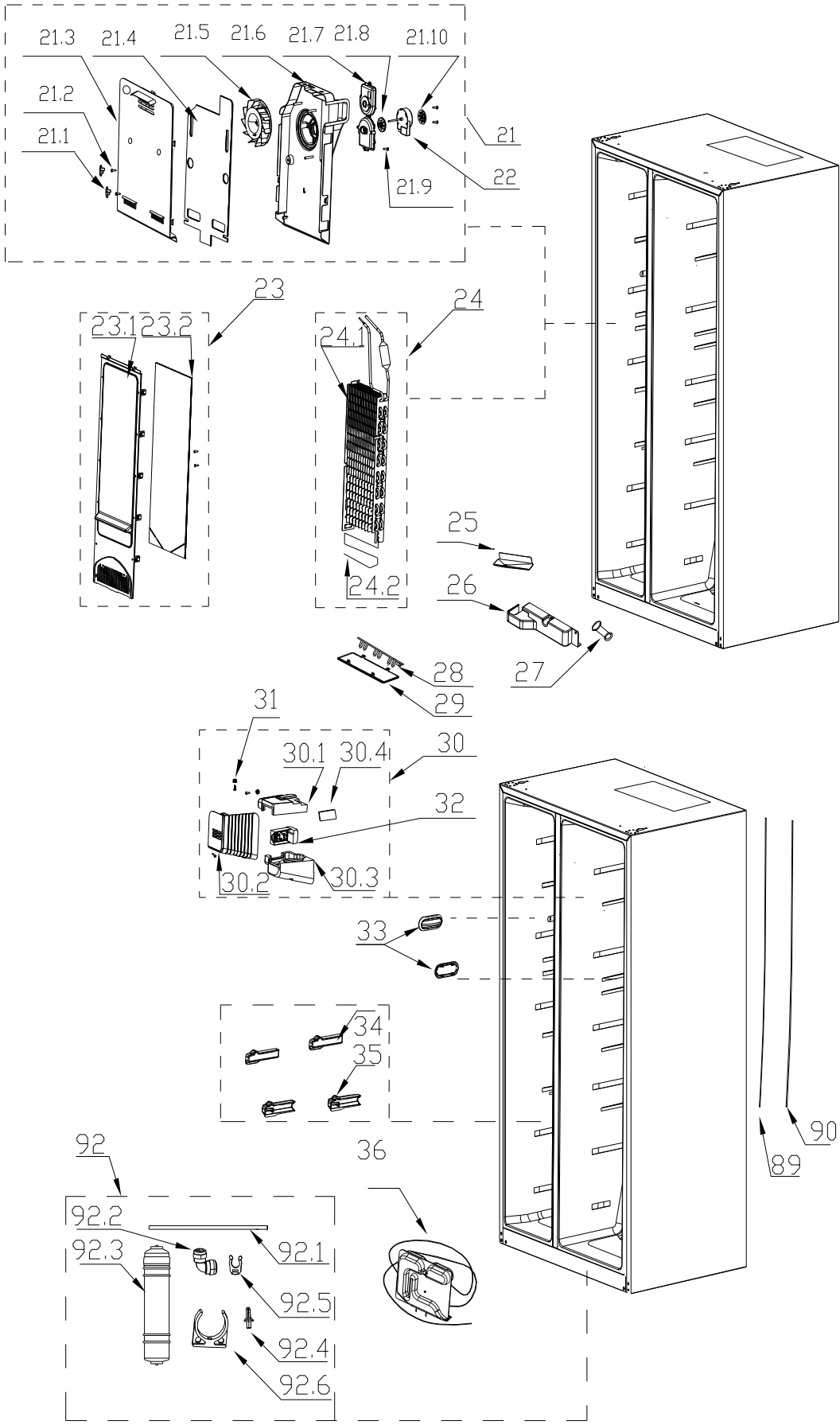

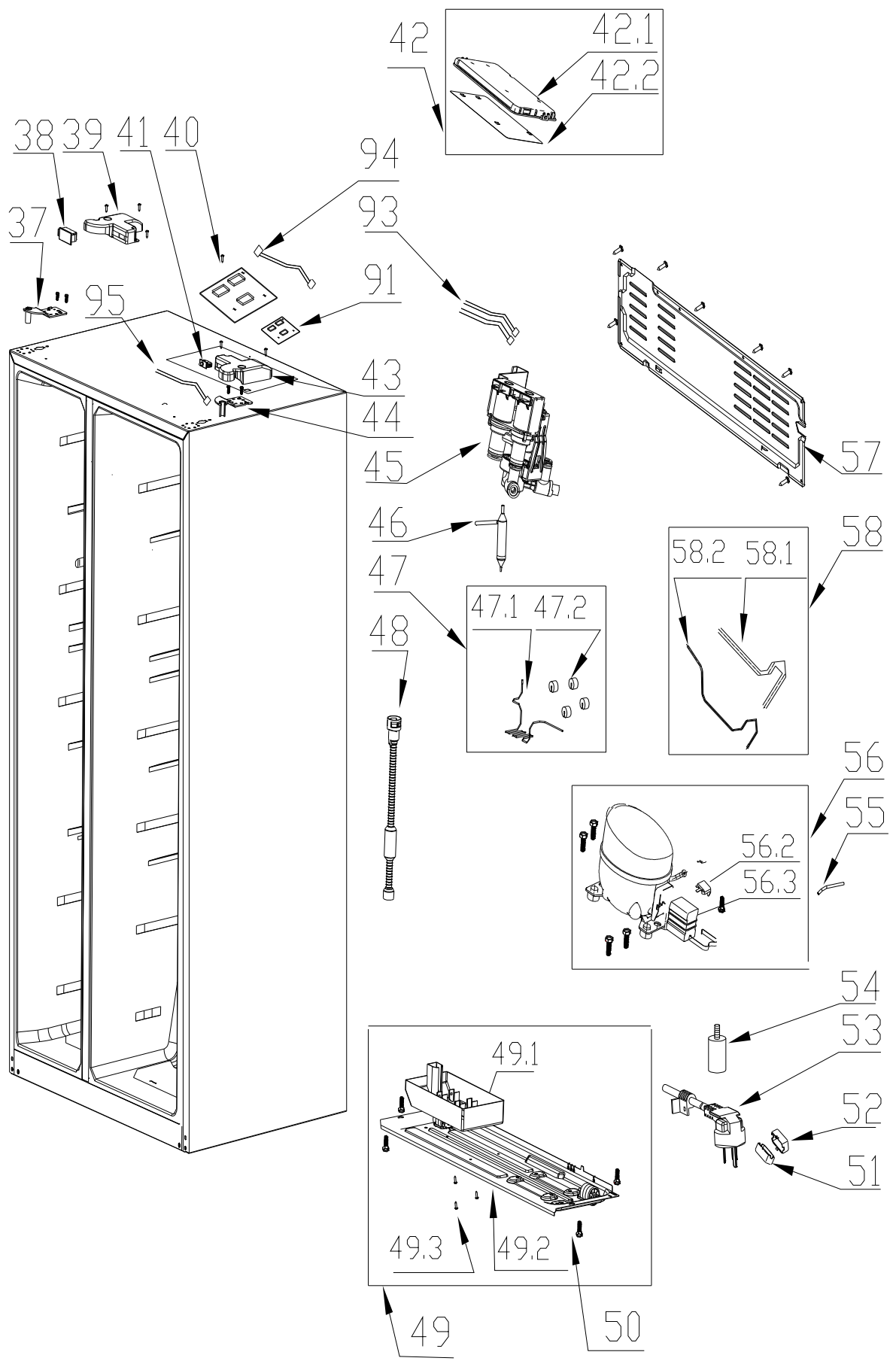

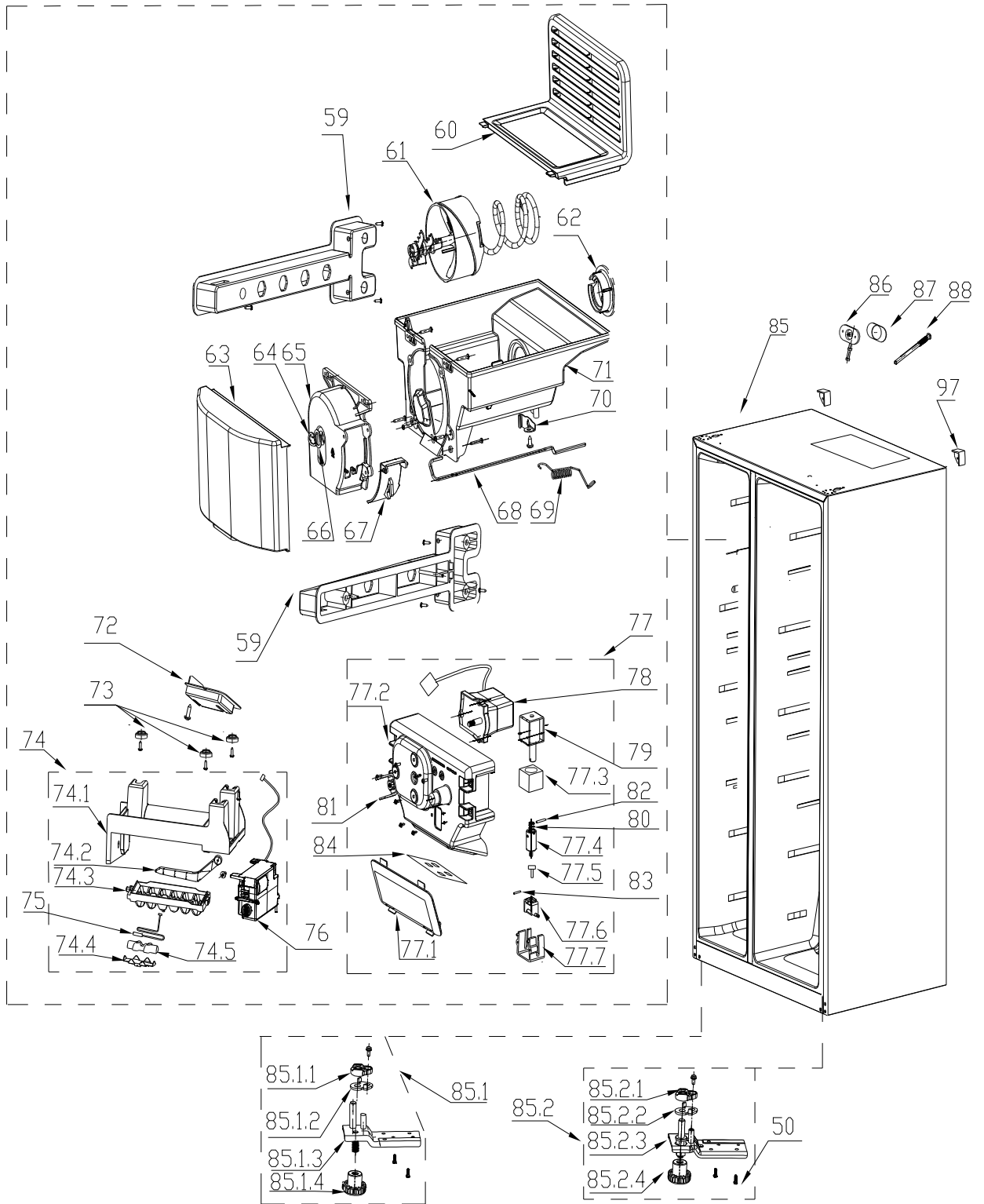



No.		Part Name		BOM Code
1		Freezer door assembly		12831000002245
1.1		open door motor		17431000000346
1.2		Cover assembly		12131000029361
1.2.1		Gasket		/
1.2.2		Plastic cover		/
1.2.3		Spring		/
1.2.4		Distributor block		/
1.3		tapping screw		11303120000160
1.4		Pillar switch		17431000000375
1.5		Fixing plate		12231000006450
1.6		Seal plate assembly		12131000029501
1.6.1		Spring		12931000000643
1.6.2		Valve tocker		12131000004663
1.6.3		Fixed blocks		12131000000820
1.6.4		Sponge block		12431000000256
1.6.5		Sealed box cover		12631000000267
1.7		End cap assembly of freezer		/
1.7.1		Reinforcement iron bar		12231000006156
1.7.2		Door self-locking		12131000003250
1.7.3		tapping screw		11303119000195
1.8		Door gasket assembly of freezer		12131000010171
1.9		Decoration component		12131000005627
2		LED lamp		17431000000228
3		Display control panel		17131000000097
4		Display control panel		12131000003062
5		Sealed case assembly		12131000011278
5.1		Sealed box cover		12631000000271
5.2		Seal cover		12131000006076
5.3		Sealing foam		16331000001064
5.4		Sealed box		12131000001662
6		F small tray		12131000006004
7		F small tray		12131000005683
8		Freezer glass shelf assembly		12531000001325
9		F upper drawer assembly		12131000000256
10		F bottom drawer assembly		12131000000261

12		Door handle of fridge compartment		12931000000521
13		bolt		12931000000613
14		Refrigerator door assembly		12831000001436
14.1		end cap assembly of refrigerator		/
14.1.1		Reinforcement iron bar		12231000006156
14.1.2		Door self-locking		12131000003250
14.1.3		tapping screw		11303119000195
14.2		Door gasket assembly of refrigerator		12131000010269
15		R small tray		12131000005702
16		R middle tray		12131000005957
17		Glass shelf assembly of refrigerator		12531000001128
18		Glass shelf assembly of refrigerator		12531000001094
19		Fruits and vegetables box component		12131000004728
20		Fruits and vegetables box component		12131000004879
21		Air duct assembly of freezer		12131000017194
21.1		Seal cover		12131000000539
21.2		tapping screw		11303125000574
21.3		Air duct front plate		12131000001421
21.4		Shape sponge		12431000000593
21.5		Flabellum		12131000006650
21.6		Back plate of air duct		12131000001448
21.7		Fixing clip		12131000000837
21.8		Damping cushion		12631000000143
21.9		Damping cushion		12631000000129
21.10		tapping screw		11303119000193
22		fan motor		11002015001688
23		Air duct assembly of freezer		12131000000399
23.1		Air duct front plate		12131000001461
23.2		Shape sponge		12431000000544
24		Component supplying fin evaporator		15831000001041
24.1		Vertical fin evaporator		15831000000006
24.2		Defrost heater		17431000005003
25		Drain tray		12231000010116
26		Cover plate		12131000001228
27		Fixing clip		12131000000793
28		LED lamp		17431000000072
29		Lamp cover		12131000017290

30		Air duct components of refrigerator		12131000000329
30.1		Air duct block		16331000000907
30.2		Air duct front plate		12131000001542
30.3		Air duct foaming of refrigerator		16331000000838
30.4		Sponge seal ring		12431000000424
32		Electric damper		17431000000895
33		Box cover		12131000001072
34		Stopper		12131000018576
35		Stopper		12131000018577
36		Water tank		12131000007677
37		Upper hinge		12231000007002
38		Magnetism control switch		17431000000119
39		Hinge cover assembly		12131000017215
40		Main control board		17131000000252
41		Pillar switch		17431000000396
42		Main control board mounting box assembly		12131000018107
42.1		Box cover		12131000015244
42.2		Reinforcement iron bar		12231000007242
43		Hinge cover assembly		12131000010152
44		Upper hinge assembly		12231000007140
45		Water valve		17431000001483
46		Dry filter		15531000000125
47		Component supplying pipe connector		15531000000012
47.1		Venting Connection tube		/
47.2		Rubber block		/
48		Drain-pipe		12131000005870
49		Compressor mounting panel assembly		12231000010143
49.1		Drain tray		12131000004261
49.2		Compressor mounting panel assembly		/
49.3		tapping screw		11303119000193
50		tapping locking screw		11303305000045
51		Mounting box		12131000001661
52		Mounting box		12131000001672
53		Power cord		17431000001116
54		Power filter		17431000000246
55		Processing tubes		15533000000081
56		DC Inverter Reciprocating Compressor		11101020000522

57		Compressor back cover		12231000005669
58		Component supplying pipe connector		15531000000019
58.1		Suction connection tube		/
58.2		Insulating tube		/
59		Guide		12131000003792
60		Box cover		12131000001127
61		Screw assembly		12931000002481
62		Gear		12131000004651
63		Box cover		12131000001160
64		Fixing plate		12231000006428
65		Plastic cover		12131000001210
66		Spacer		12231000006512
67		Selected ice door		12131000006743
68		Selected ice rod		12931000000568
69		Spring		12931000000642
70		Fixing plate		12231000006534
71		Ice storage box		12131000000175
72		Mounting box		12131000017773
73		Hook		12131000000810
74		Parts of Ice cube box		12131000000312
74.1		Support		12131000006451
74.2		Ice-probing rod		12131000004666
74.3		Ice box		12131000000178
74.4		Plastic cover		12131000001161
74.5		Thermal insulation foam		16331000001082
75		temperature sensor		11201007000779
76		motor im		17431000000342
77		Crushed ice assembly		12131000017245
77.1		Lamp cover		12131000005461
77.2		Box cover		12131000001128
77.3		Sponge block		12431000000284
77.4		Hook		12131000000733
77.5		Hook		12131000000732
77.6		Hook		12131000000815
77.7		Guide seat		12131000004539
78		ice output motor		17431000000344
79		Electromagent		17431000000905

80		Spring		12931000000645
81		Drive lever		12931000000566
82		Pin		12931000000601
83		Pin		12931000000597
84		LED lamp		17431000000146
85		Cabinet assembly		/
85.1		Lower hinge assembly		12231000010013
85.1.1		Door self-locking		12131000015734
85.1.2		Door self-locking block		12231000009980
85.1.3		Lower hinge		/
85.1.4		Levelling feet		/
85.2		Lower hinge adjust feet assembly		12231000010021
85.2.1		Door self-locking		12131000015733
85.2.2		Door self-locking block		12231000009980
85.2.3		Lower hinge		/
85.2.4		Levelling feet		/
86		ater pipe connector		12631000000255
87		Metal cover plate		12231000006644
88		Compensation heater\		17431000001507
89		Drain-pipe		12131000005860
90		Drain-pipe		12131000005969
91		Variable frequency driver board		17131000002002
92		Filter assembly		12131000030121
92.1		PP		12163200000388
92.2		Plastic part		12163200000462
92.3		filter		15663200001784
92.4		Plastic part		12163200000577
92.5		Plastic part		12163200000492
92.6		Fixed blocks		12163200000375
93		Wires		17431000001326
94		Wires		17431000001017
95		humidity sensor		11201004000089
96		Drain tray		12131000004383
97		Corner protecting cover		12131000000926