

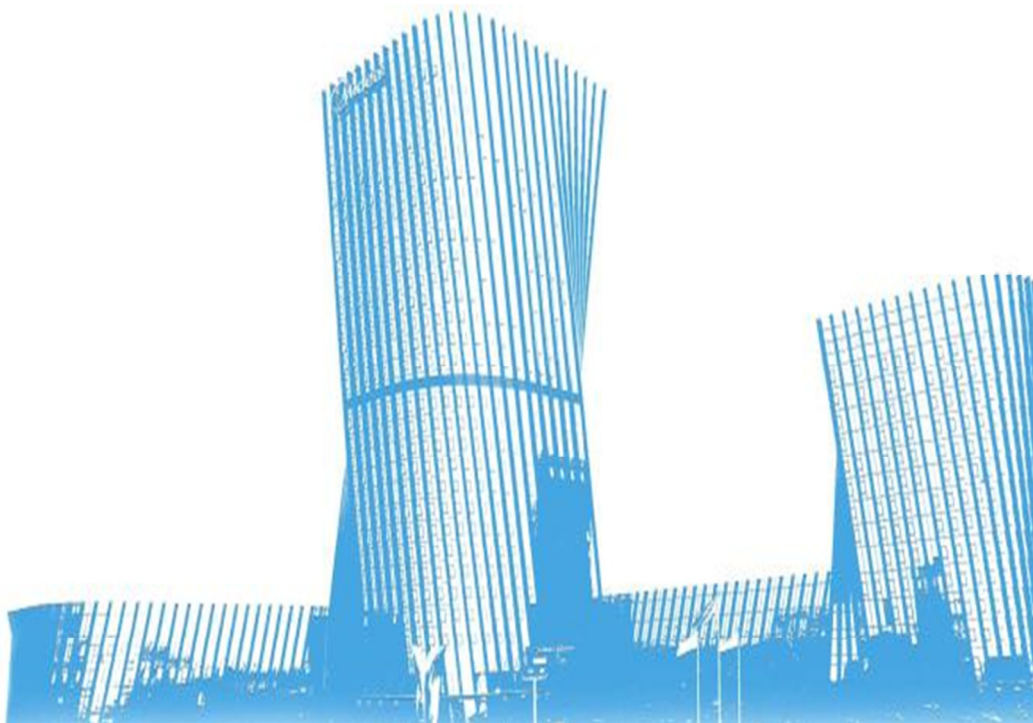

SBS SERIES

Service Manual 2016



Service Manual

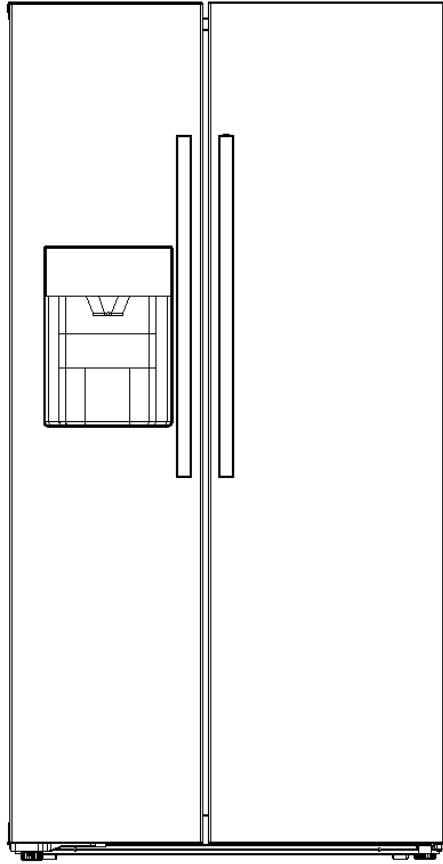

(The picture is only for reference, and specific appearance and configuration are subject to the real product)

Prepared by	R&D:HuDahong
-------------	--------------

Reviewed by	QA:WangTao SVC:Zhang Kun
-------------	-----------------------------

Approved by	R&D:ZhangHaixing SVC:GuangTaoshuai
-------------	---------------------------------------



Warning

Important Safety Notice

The Maintenance Manual is only for the use of maintenance personnel with certain experience and background in electrical, electronic and mechanical field.

Any attempt to repair main devices may lead to personal injury and property loss.

Manufacturers or distributors are not responsible for the content of the Manual and interpretation thereof.

Midea Refrigerators

Technical Maintenance Manual

Copyright @2016

All rights reserved. Replication of all or part of the Manual in any forms shall not be allowed without written approval by the Overseas Sales Corporation of Midea Refrigerators.

※The specifications, designs, and information in this book are subject to change without notice for product improvement.

Contents

1.Safety Warning Code	6
1.1 Warning for operation safety	6
1.2 Safety instruction for refrigerant.....	9
2.Description for product features	10
3.Installation and commissioning	11
3.1 Handling	11
3.2 Door Disassembly and Assembly	11
3.3 Installation location	15
3.4 Leveling of the refrigerator.....	15
3.5 Door reversal (None).....	15
3.6 Installation of handle	15
3.7 Installation of door lock(None).....	16
3.8 Adjustment to level the door	16
3.9 Adjustment to shelves(None).....	16
4.Terms	17
4.1 Definition of model(None)	17
4.2 Location of nameplate	17
5.Product specification	17
5.1 Typespecification(None).....	17
5.2 Electrical parameters	17
5.3 Inside temperature	18
5.4 Defrosting parts	19
5.5 Circuit diagram	19
6.Internal view and dimension.....	21
6.1 Main parts and their names.....	21
6.2 External dimension	21
7.Refrigerating piping system and circulating route of cooling air	23
7.1 Refrigerating piping system.....	23
7.2 Circulating route of cooling air.....	24
8. 8. Dismantling of parts	25
8.1 Parts on the door	25
8.2 Parts inside the refrigerator.....	25
8.3 Light system	26
8.4 Air duct components refrigeratingchamber	27
8.5 Air duct components in freezing chamber and fan motor.....	28
8.6 Evaporator and temperature sensing system.....	29
8.7 Compressor case	32
8.8 Display control board	34
8.9 Main control boardl	34
8.10 Bar counter(None)	35
8.11 Water dispenser(None).....	35
8.12 Ice maker	36

9. Function and operation	38
9.1 Operation panel.....	38
9.2 Temperature control.....	38
9.3 give an alarm	39
9.4 Defrosting	39
9.5 Function Selection	39
9.6 Self-diagnosis	40
9.7 Compressor fan control(None)	40
9.8 Error code and solution.....	40
10. Circuit description	41
10.1 Power Supply.....	41
10.2 Test circuit for door switch	41
10.3 Temperature test circuit.....	41
10.4 Freezer fan motor circuit.....	42
10.5 REF. fan motor circuit(None)	42
10.6 Condenser fan motor circuit(None)	42
10.7 Damper motor circuit.....	42
10.8 Sensor resistance(R/T).....	42
11. Troubleshooting Method.....	44
11.1 No cooling(Air cooling-Electronic).....	44
11.2 No working of compressor.....	45
11.3 Inside frosting, no defrosting	45
11.4-Inside frosting, no defrosting-Maintenance guidelines.....	46
11.5 Light is not on	47
11.6 Air duct not operated(electronically)	47
11.7 Fan failure	48
11.8 Defective defrost circuit.....	48
11.9 Noise	49
12. Figures and details of repair parts(Documents are provided separately).....	49
12.1 Figures	49
12.2 List of parts and components	49
13 Appendix:	49
13.1 Electrical Schematic Diagram	49
13.2 Refrigerator maintenance tooling and equipment and material	50

1.Safety Warning Code

1.1Warning for operation safety

Important Safety Instructions

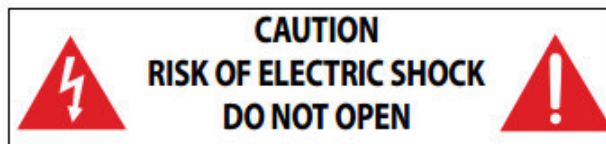

This symbol indicates that dangerous voltage constituting a risk of electric shock is present within your freezer.



This symbol indicates that there are important operating and maintenance instructions in the literature accompanying your freezer.

WARNING

- 1 Read these instructions.
- 2 Keep these instructions.
- 3 Heed all warnings.
- 4 Follow all instructions.
- 5 Do not use this appliance near water.
- 6 Clean only with a damp cloth.
- 7 Do not block any ventilation openings.
- 8 Install in accordance with the manufacturer's instructions.
- 9 Do not install near any heat sources, such as radiators, heat registers, stoves, or other apparatus that produce heat.
- 10 Do not defeat the safety purpose of the polarized or grounding-type plug. A polarized plug has two blades with one wider than the other. A grounding type plug has two blades and a third grounding prong. The wide blade or the third prong are provided for your safety. If the provided plug does not fit into your outlet, consult an electrician for replacement of the obsolete outlet.
- 11 Protect the power cord from being walked on or pinched, particularly at plugs, convenience receptacles, and the point where they exit from the appliance.
- 12 Do not attempt to modify or extend the power cord of this appliance.
- 13 Unplug this appliance during lightning storms or when it will not be used for long periods of time.
- 14 Make sure that the available AC power matches the voltage requirements of this appliance.

- 15 Do not handle the plug with wet hands. This could result in an electric shock.
- 16 Unplug the power cord by holding the plug, never by pulling the cord.
- 17 Do not turn the appliance on or off by plugging or unplugging the power cord.
- 18 Refer all servicing to qualified service personnel. Servicing is required when the appliance has been damaged in any way, such as the power-supply cord or plug is damaged, liquid has been spilled or objects have fallen into the appliance, the appliance has been exposed to rain or moisture, does not operate normally, or has been dropped.
- 19 To reduce the risk of fire or electric shock, do not expose this appliance to rain, moisture, dripping, or splashing, and no objects filled with liquids should be placed on top of it.
- 20 Do not use extension cords or ungrounded (two prong) adapters.
- 21 This appliance is not intended for use by persons (including children) with reduced physical, sensory or mental capabilities, or lack of experience and knowledge, unless they have been given supervision or instruction concerning use of the appliance by a person responsible for their safety.
- 22 Children should be supervised to ensure that they do not play with the appliance.
- 23 If the supply cord is damaged, it must be replaced by the manufacturer, its service agent, or similarly qualified person, in order to avoid a hazard.
- 24 Take off the doors and leave the shelves in place so that children may not easily climb inside.



WARNING

Electric Shock Hazard

Failure to follow these instructions can result in electric shock, fire, or death.

- 1 **WARNING**—Keep ventilation openings, in both the freezer and the built-in structure, clear of obstruction.
- 2 **WARNING**—Do not touch the interior of the freezer with wet hands. This could result in frost bite.
- 3 **WARNING**—Do not use mechanical devices or other means to accelerate the defrosting process, other than those recommended by the manufacturer.
- 4 **WARNING**—Do not damage the refrigerant circuit.

- 5 **WARNING**—Do not damage the refrigerant tubing when handling, moving, or using the freezer.
- 6 **WARNING–DANGER**—Never allow children to play with, operate, or crawl inside the freezer.
Risk of child entrapment. Before you throw away your old freezer:
 - 1) Take off the doors
 - 2) Leave the shelves in place so that children may not easily climb inside
- 7 Unplug the freezer before carrying out user maintenance on it.
- 8 This freezer can be used by children age eight years and older and persons with reduced physical or mental capabilities or lack of experience and knowledge if they are given supervision or instruction concerning the use of the freezer in a safe way and understand the hazards involved. Children should not play with the freezer. Cleaning and maintenance should not be performed by children without supervision.
- 5 **WARNING**—Do not damage the refrigerant tubing when handling, moving, or using the freezer.
- 6 **WARNING–DANGER**—Never allow children to play with, operate, or crawl inside the freezer.
Risk of child entrapment. Before you throw away your old freezer:
 - 1) Take off the doors
 - 2) Leave the shelves in place so that children may not easily climb inside
- 7 Unplug the freezer before carrying out user maintenance on it.
- 8 This freezer can be used by children age eight years and older and persons with reduced physical or mental capabilities or lack of experience and knowledge if they are given supervision or instruction concerning the use of the freezer in a safe way and understand the hazards involved. Children should not play with the freezer. Cleaning and maintenance should not be performed by children without supervision.
- 9 If a component part is damaged, it must be replaced by the manufacturer, its service agent, or similar qualified persons in order to avoid a hazard.
- 10 Please dispose of the freezer according to local regulations as the freezer contains flammable gas and refrigerant.
- 11 Follow local regulations regarding disposal of the freezer due to flammable refrigerant and gas. All refrigeration products contain refrigerants, which under the guidelines of federal law must be removed before disposal. It is the consumer's responsibility to comply with federal and local regulations when disposing of this product.



- 12** This freezer is intended to be used in household and similar environments.
- 13** Do not store or use gasoline or any flammable liquids inside or in the vicinity of this freezer.
- 14** Do not use extension cords or ungrounded (two-prong) adapters with this freezer. If the power cord is too short, have a qualified electrician install an outlet near the freezer. Use of an extension cord can negatively affect the freezer's performance.

Grounding requirement

This freezer must be grounded. This freezer is equipped with a cord having a grounding wire with a grounding plug. The plug must be inserted into an outlet that is properly installed and grounded.

Improper use of the grounding plug can result in a risk of electric shock. Consult a qualified electrician or service person if the grounding instructions are not completely understood, or if doubt exists as to whether the freezer is properly grounded.

1.2 Safety instruction for refrigerant

 WARNING	 Explosion Hazard.
Keep flammable materials and vapors, such as gasoline, away from freezer. Failure to do so can result in fire, explosion, or death.	

<p>DANGER—Risk of Fire or Explosion. Flammable Refrigerant Used. To Be Repaired Only By Trained Service Personnel. Do Not Use Mechanical Devices. Do Not Puncture Refrigerant Tubing.</p> <p>CAUTION—Risk of Fire or Explosion. Flammable Refrigerant Used. Consult Repair Manual/Owner's Guide Before Attempting To Service This Product. All Safety Precautions Must be Followed.</p> <p>CAUTION—Risk of Fire or Explosion. Dispose of Properly In Accordance With Federal Or Local Regulations. Flammable Refrigerant Used.</p> <p>CAUTION—Risk of Fire or Explosion Due To Puncture Of Refrigerant Tubing; Follow Handling Instructions Carefully. Flammable Refrigerant Used.</p>	
--	---

2.Description for product features

This product is provided with following features:



(The picture is only for reference, and specific appearance and configuration are subject to the real product)

- 1) Frost free design.
- 2) Electronic temperature control, more accurate temperature control.
- 3) Automatic ice maker, options for ice cube, crushed ice and cooling water.



3.Installation and commissioning





3.1 Handling



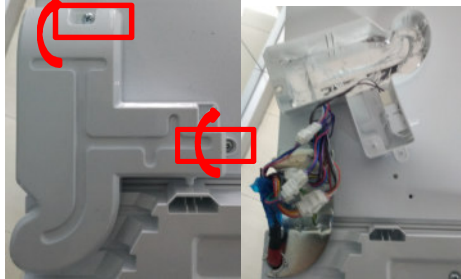

<p>1) Protect the refrigerator in moving it, Same as shown as left photo, please move it by hand cart with cushion</p> <p>2) Remove all packing materials and bottom cushion, then move into house for placement</p> <p>3) After moving it to appropriate location, wait for 2 hours before power on.</p>	
---	--



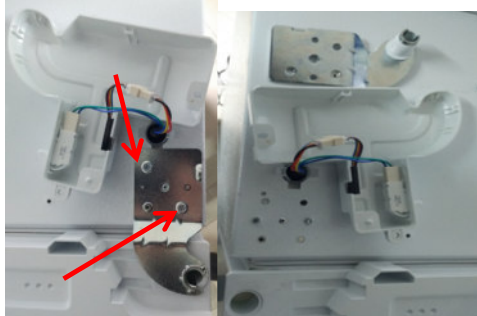

3.2 Door Disassembly and Assembly

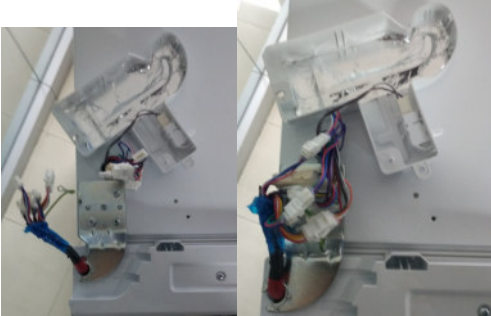
The refrigerator door needs to be dismantled if it cannot enter the room in the whole.

disassembly	
Disassembly of Freezer door	
<p>1. Use cross screwdriver to remove the screws by anticlockwise, and then take out the protective cover.</p>	
<p>2. Pull out the spacing guard sheet at the two ends of water connector, and then push the locked cushion inwards, meantime pull out water pipe.</p> <p>Note: please make sure the fast connector can't be left at the end of water pipe of door</p>	

<p>3.2As shown as right photos, use screwdriver to remove the 2 pcs screws, and then remove the upper hinge cover.</p>	
<p>4.Disconnect the fast connectors, then use cross screwdriver or socket spanner to remove the 2pcs M5 screws and 1 pc grounding screw by anticlockwise.</p>	
<p>5.Lift up the freezer door until the hinge axis separated from the axis hole of door, then carry the door to a suitable place.</p>	
<p>Disassembly of refrigerator door</p>	
<p>1.Use screwdriver to remove the 2 pcs screws, and then remove the upper hinge cover.</p>	
<p>2.Use cross screwdriver or socket spanner to remove the 2 pcs M5 screws by anticlockwise, and then remove the upper hinge.</p> <p>Note: please make sure the refrigerator door fit closely to the cabinet; otherwise the refrigerator door may fall down during above operation.</p>	

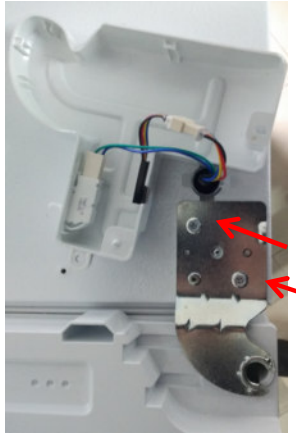
<p>3.Lift up the refrigerator door until the hinge axis separated from the axis hole of door, then carry the door to a suitable place.</p>	
<p>Assembly</p>	
<p>Assembly of freezer door</p>	
<p>1.Put the freezer door down gently until the axis of hinge inserted into the axis hole of door completely.</p>	
<p>2.Put the upper hinge on suitable position, then use cross screwdriver or socket spanner to fix the 2 pcs M5 screws and 1 pc grounding screw by clockwise, and connect the 6 pcs fast connectors.</p>	
<p>3.Put the cover of upper hinge on suitable position, then use screwdriver to fix the 2 pcs screws</p>	
<p>4.Push the locked cushion of water connector inwards, then insert the water pipe into the water connector to the end, and finally assemble the spacing guard sheet. Note: the water pipe cant be connected incorrectly, only the water pipes in same color can be connected</p>	

<p>5.Assemble the protective cover and fix the screws</p>	
<p>assembly of refrigerator door</p>	
<p>1.Put the refrigerator door down gently until the axis of hinge inserted into the axis hole of door completely, and then closes the door, to make sure the refrigerator door fit the cabinet closely.</p>	
<p>2.Put the upper hinge on suitable position, then use cross screwdriver or socket spanner to fix the 2 pcs M5 screws.</p>	
<p>3.Put the hinge cover on suitable position, and then use the screwdriver to fix the 2 pcs screws.</p>	

3.3 Installation location

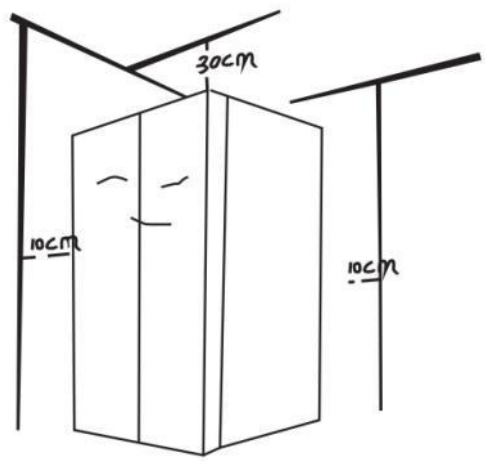
<p>Location that is easy for ventilation shall be chosen to facilitate heat dissipation, enhance its performance and reduce the energy consumption.</p>	 <p>A line drawing of a refrigerator with its doors closed. It is positioned in a corner. Hand-drawn dimension lines indicate the required clearances: 30cm at the top, 10cm on the left side, and 10cm on the right side.</p>
---	--

3.4 Leveling of the refrigerator

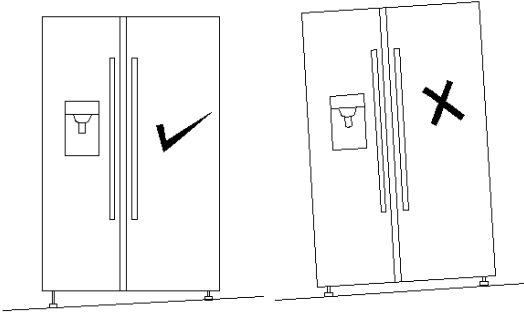
<p>If the refrigerator cannot be placed steadily, adjust the footing to level it.</p>	 <p>Two side-by-side diagrams of a refrigerator. The left diagram shows the refrigerator perfectly level on a flat surface, with a checkmark (✓) next to it. The right diagram shows the refrigerator tilted to the right on a sloped surface, with an 'X' next to it, indicating it is not level.</p>
---	---

3.5 Door reversal (None)

3.6 Installation of handle

Note: Figures in the user manual are only for reference. The actual product may differ slightly.
The refrigerator must be disconnected from the source of electrical supply before attempting the installation of accessory.

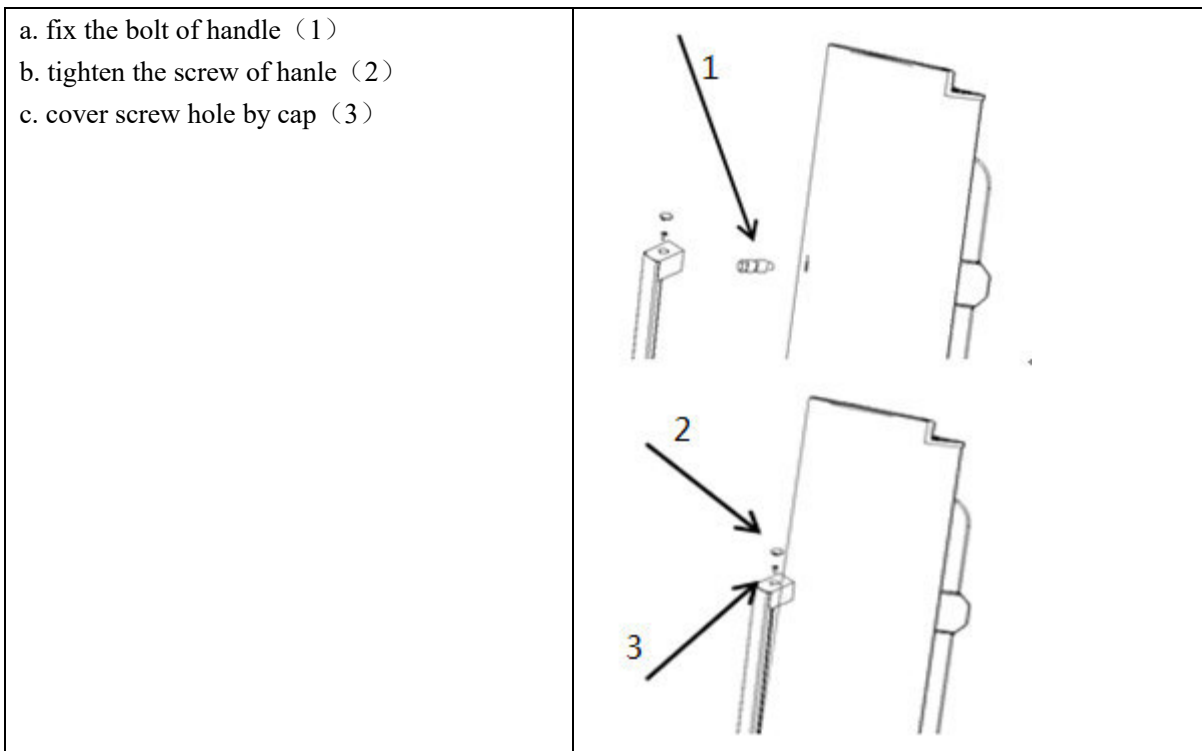

(Pictures and objects are not consistent, in order to prevail in kind)

3.7 Installation of door lock(None)

3.8 Adjustment to level the door

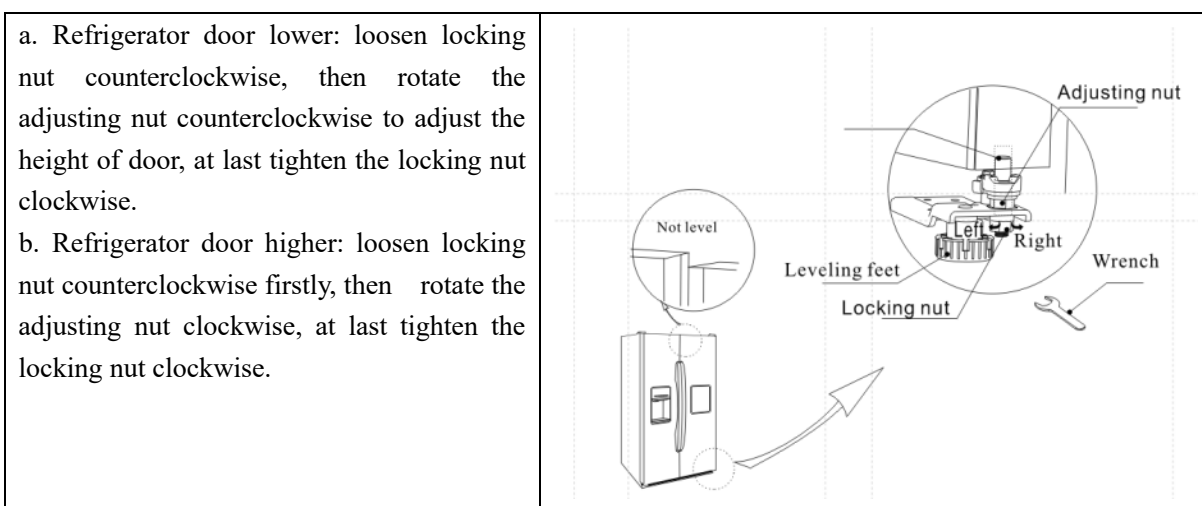

3.9 Adjustment to shelves(None)

4. Terms

4.1 Definition of model(None)

4.2 Location of nameplate

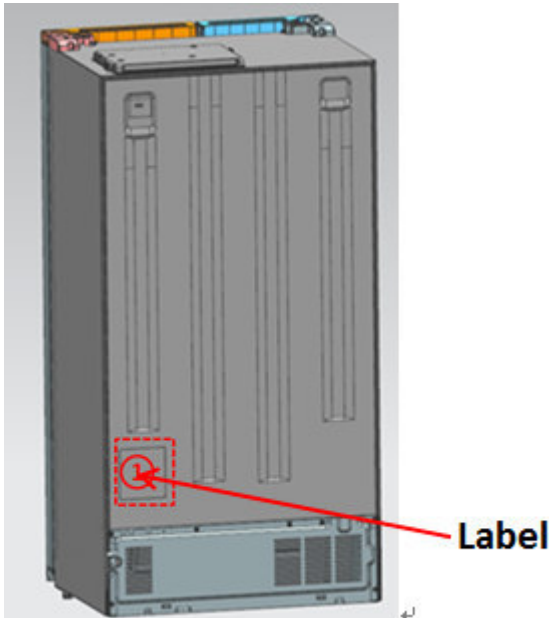

(The picture is only for reference, and specific appearance and configuration are subject to the real product)

5. Product specification

5.1 Typespecification(None)

5.2 Electrical parameters

Product Name			CE-BCD508W E-ST	CE-BCD508W E-JT	CE-BCD508W E-FT	CE-BCD508W E-ST	SR-BCD508W E
Product Code			220310500003 82	220310500002 01	220310500000 81	220310500000 05	220310500003 01
Name	Item	Type	Specification	Specification	Specification	Specification	Specification
Compressor	Compressor	/	ERI120E13DC H	LU118PY1	KJ248CY	KJ248CY	PZ130H1A-M
	Starter	PTC	/	/	DRB25T61A1	TY-QZ-003	TY-QZ-003/QP E2-A15MD3
	Overload protector	OLP	MM3-71CCX	B69-120 P A	DRB25T61A1	DRB25T61A1	DRB25T61A1

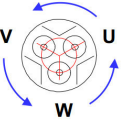
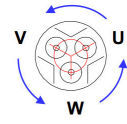
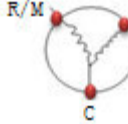
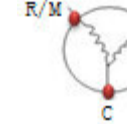
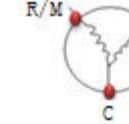
	Winding resistance of compressor wiring terminal	/	20°C U-V 9.2Ω±15% 20°C V-W 9.2Ω±15% 20°C W-V 9.2Ω±15%	20°C U-V 12.4Ω±5% 20°C U-W 12.4Ω±5% 20°C W-V 12.4Ω±5%	primary winding resistance:12.3 ±7%Ω secondary winding resistance:18.8 ±7%Ω	primary winding resistance:12.3 ±7%Ω secondary winding resistance:18.8 ±7%Ω	primary winding resistance:10.08±7%Ω secondary winding resistance:10.94±7%Ω
							
	Variable frequency driver board	/	DBFC-CTCL M-V1.0 220-240V(50/60)Hz	ITRP04BX1.9 220-240V(50/60)Hz	/	/	/
Motor	Fan motor of the freezing chamber	BLDC	DC12V/≤4W	DC12V/≤4W	DC12V/≤4W	DC12V/≤4W	DC12V/≤4W
	Ventilation door of the refrigerating chamber	/	DC12V	DC12V	DC12V	DC12V	DC12V
	Condensation fan	/	/	DC12V	/	/	/
	separation the ice motor	/	DC12V	DC12V	DC12V	DC12V	DC12V
	ice output motor	/	DC12V	DC12V	DC12V	DC12V	DC12V
	Open door motor	/	DC12V	DC12V	DC12V	DC12V	DC12V
Lights inside the refrigerator	Lights inside the freezing chamber	LED	12V≤2.5W	12V≤2.5W	12V≤2.5W	12V≤2.5W	12V≤2.5W
	Lights inside the refrigerating chamber	LED	12V≤2.5W	12V≤2.5W	12V≤2.5W	12V≤2.5W	12V≤2.5W
	Switch of the refrigerator door	LED	5V≤0.4W	5V≤0.4W	5V≤0.4W	5V≤0.4W	5V≤0.4W

5.3 Inside temperature

Temperature tolerance ≤ 2 °C

Compartment	The highest (°C)	Lowest (°C)
Freezing	-14	-24
Refrigerating	9	1
Variable temperature	/	/

5.4 Defrosting parts

Defrosting period	Initial defrosting period	Normal defrosting period
	Temperature is lower than 0 °C	6~24 hours
Defrosting sensor	NTC	B3839
Defrosting temperature controller	/	/
Thermal fuse	Can't be restored	77 °C
Defrosting heater in freezing chamber	/	Defrosting heater 230V/250W

5.5 Circuit diagram

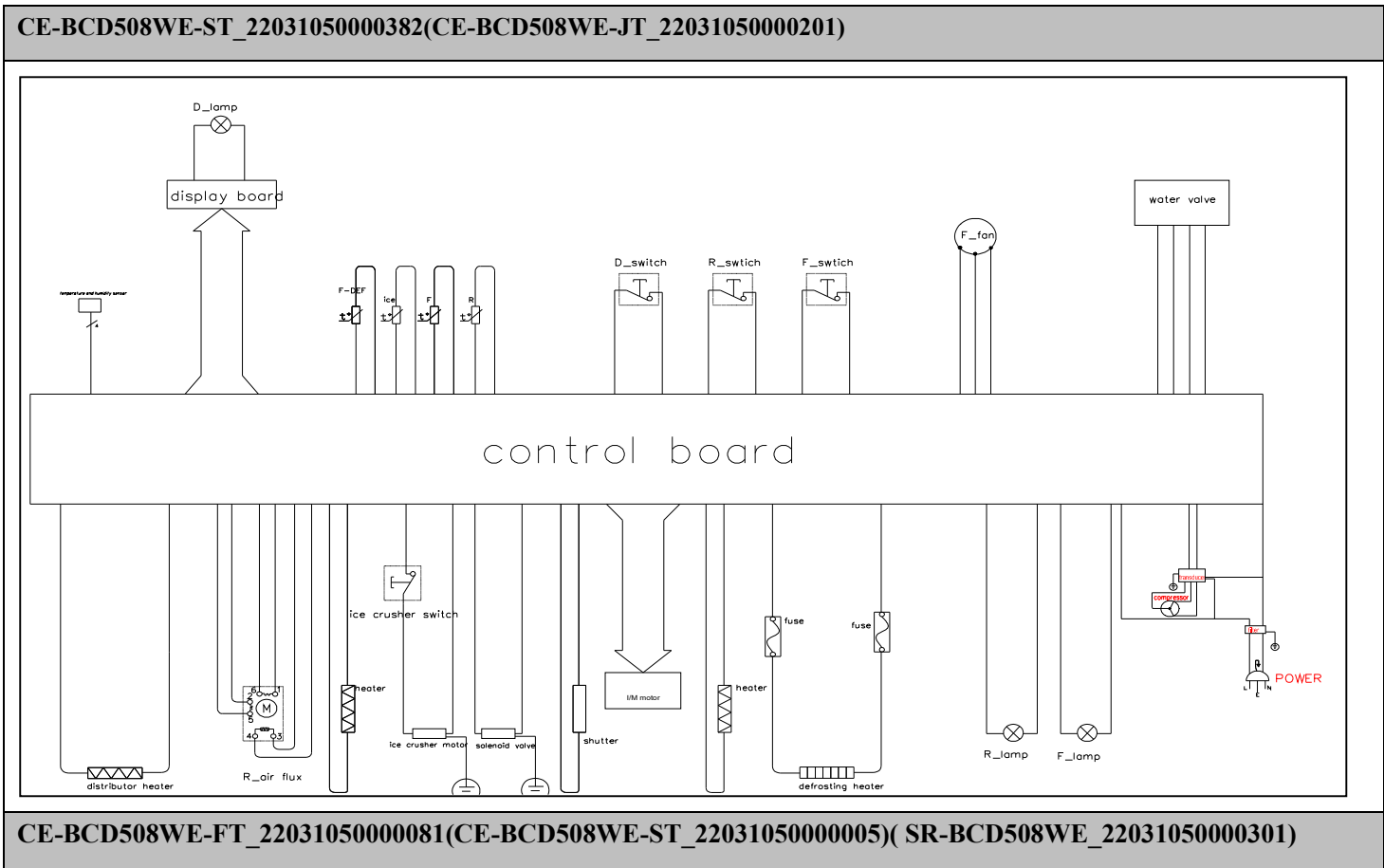

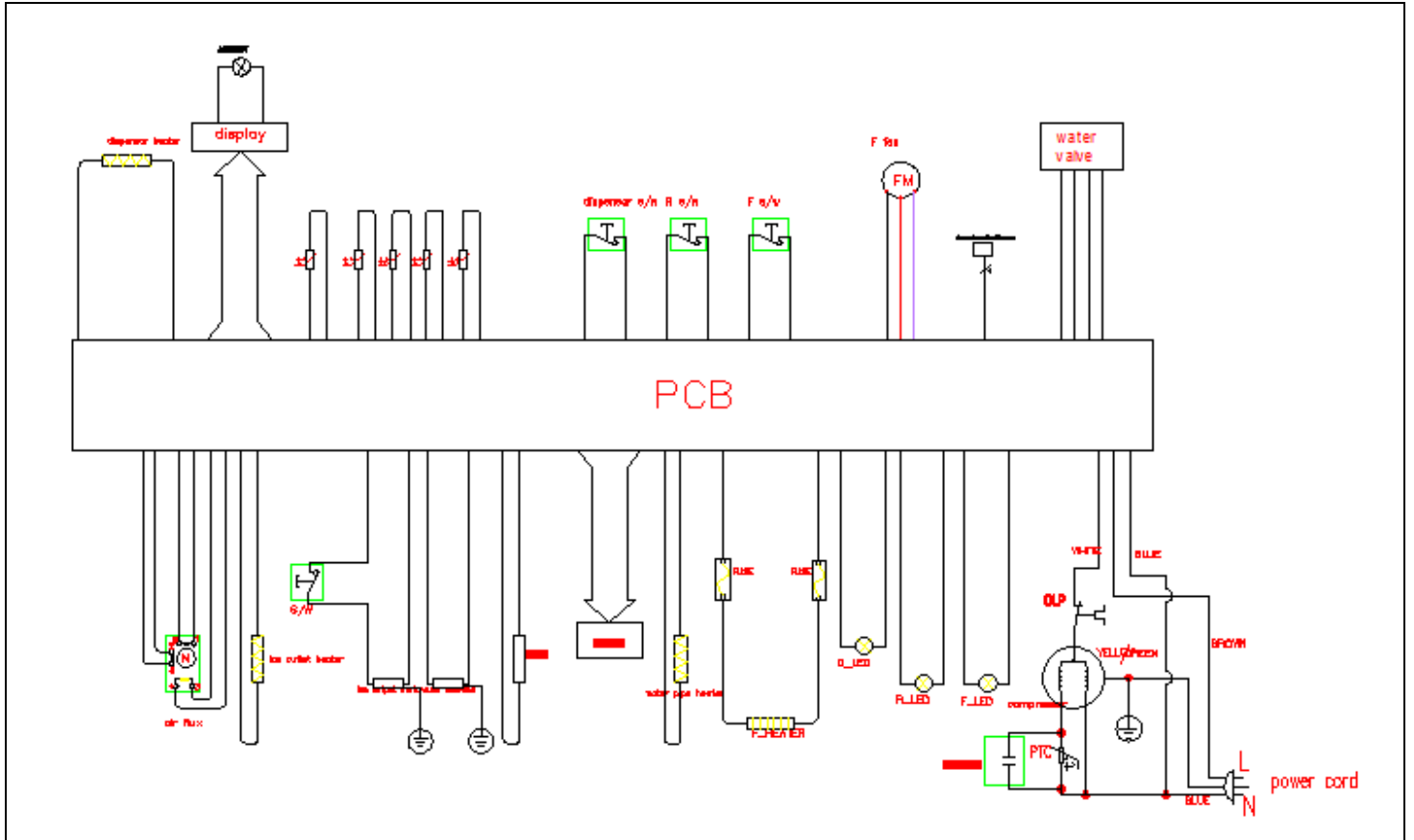

6. Internal view and dimension

6.1 Main parts and their names

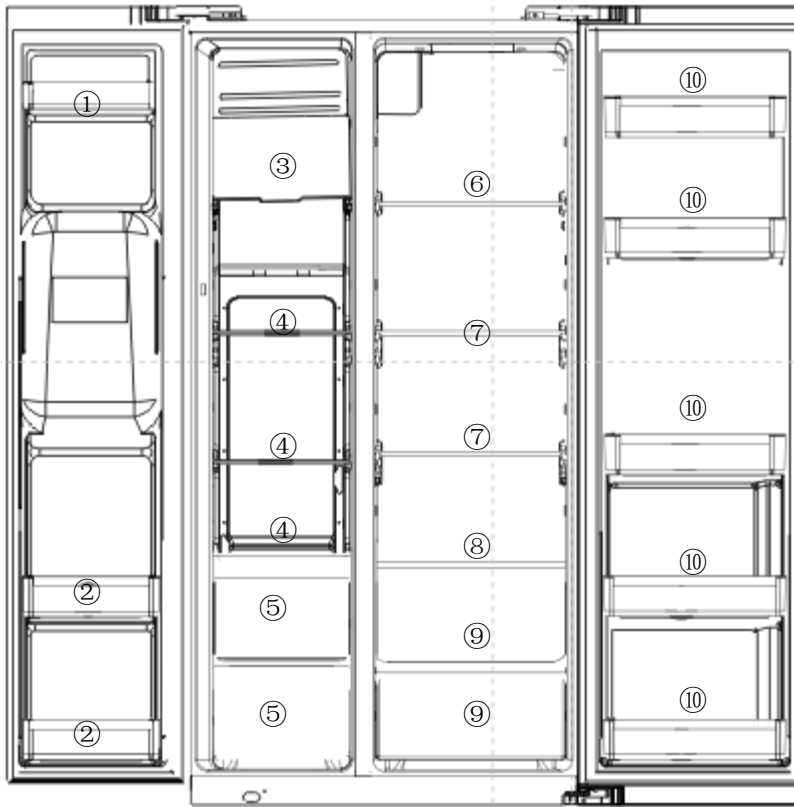

(The picture is only for reference, and specific appearance and configuration are subject to the real product)

Freezer	Refrigerator
1. door rack	6. shelf
2. door rack 3. ice tank	7. shelf
4. shelf	8. shelf
5. drawer	9. vegetable crisper
	10. bottle rack

6.2 External dimension

Front view	Side view
------------	-----------

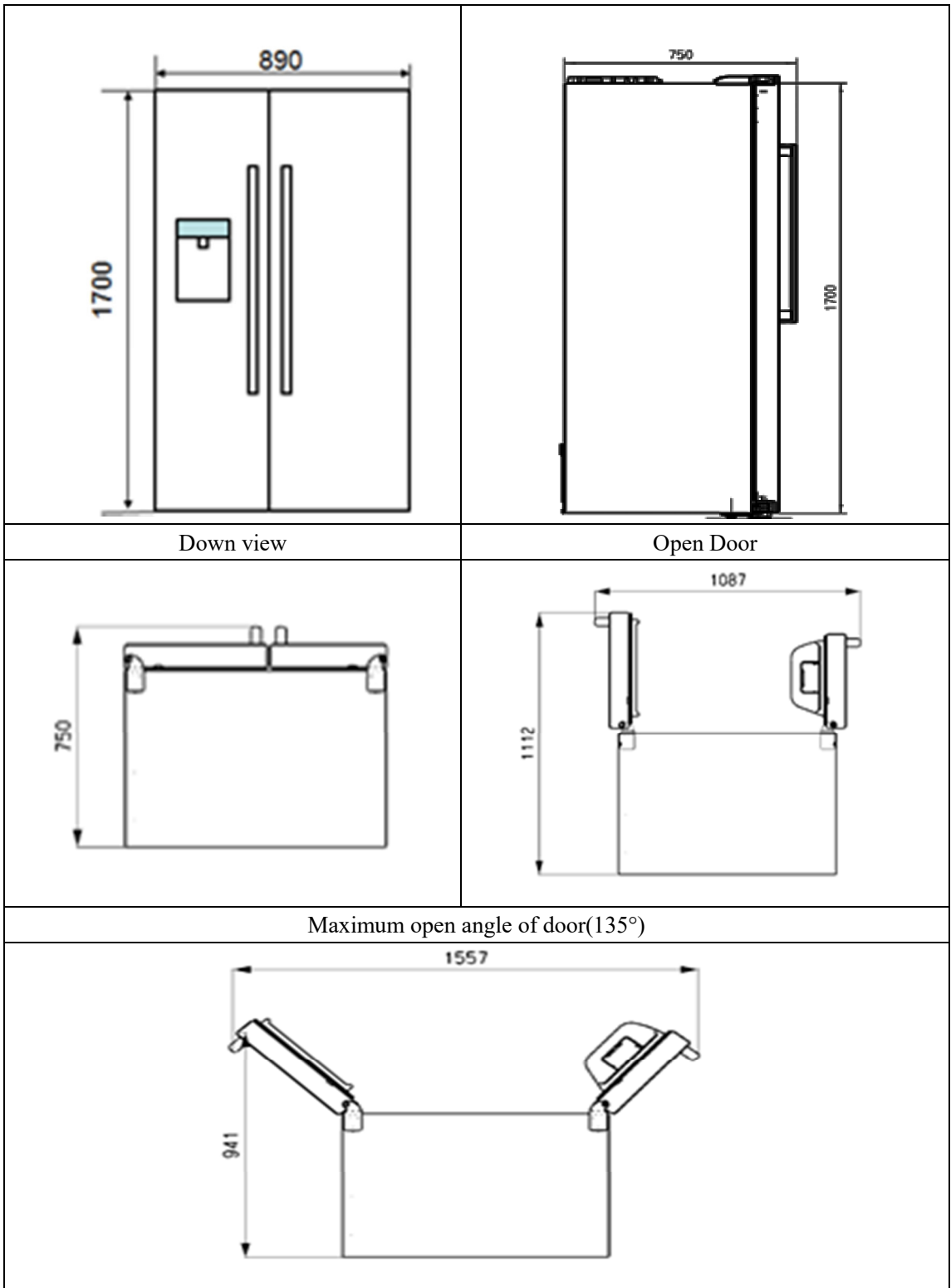

(The picture is only for reference, and specific appearance and configuration are subject to the real product)

7. Refrigerating piping system and circulating route of cooling air

7.1 Refrigerating piping system

<p>CE-BCD508WE-ST_22031050000382 CE-BCD508WE-FT_22031050000081 CE-BCD508WE-ST_22031050000005 SR-BCD508WE_22031050000301</p>	<p>CE-BCD508WE-JT_22031050000201</p>
<p>1 Compressor→2 Transition pipe→3 Back Condenser→4 Left Condenser→5 Anti-water condensed pipe→6 Right Condenser→7 Drier→8 Capillary Tube→9 Evaporator→10 Suction Pipe→11 Suction connection Pipe→1 Compressor</p>	<p>1 Compressor→2 Condenser→3 Anti-water condensed pipe→4 Drier→5 Capillary Tube→6 Evaporator→7 Suction Pipe→8 Suction connection Pipe→1 Compressor</p>

(The picture is only for reference, and specific appearance and configuration are subject to the real product)

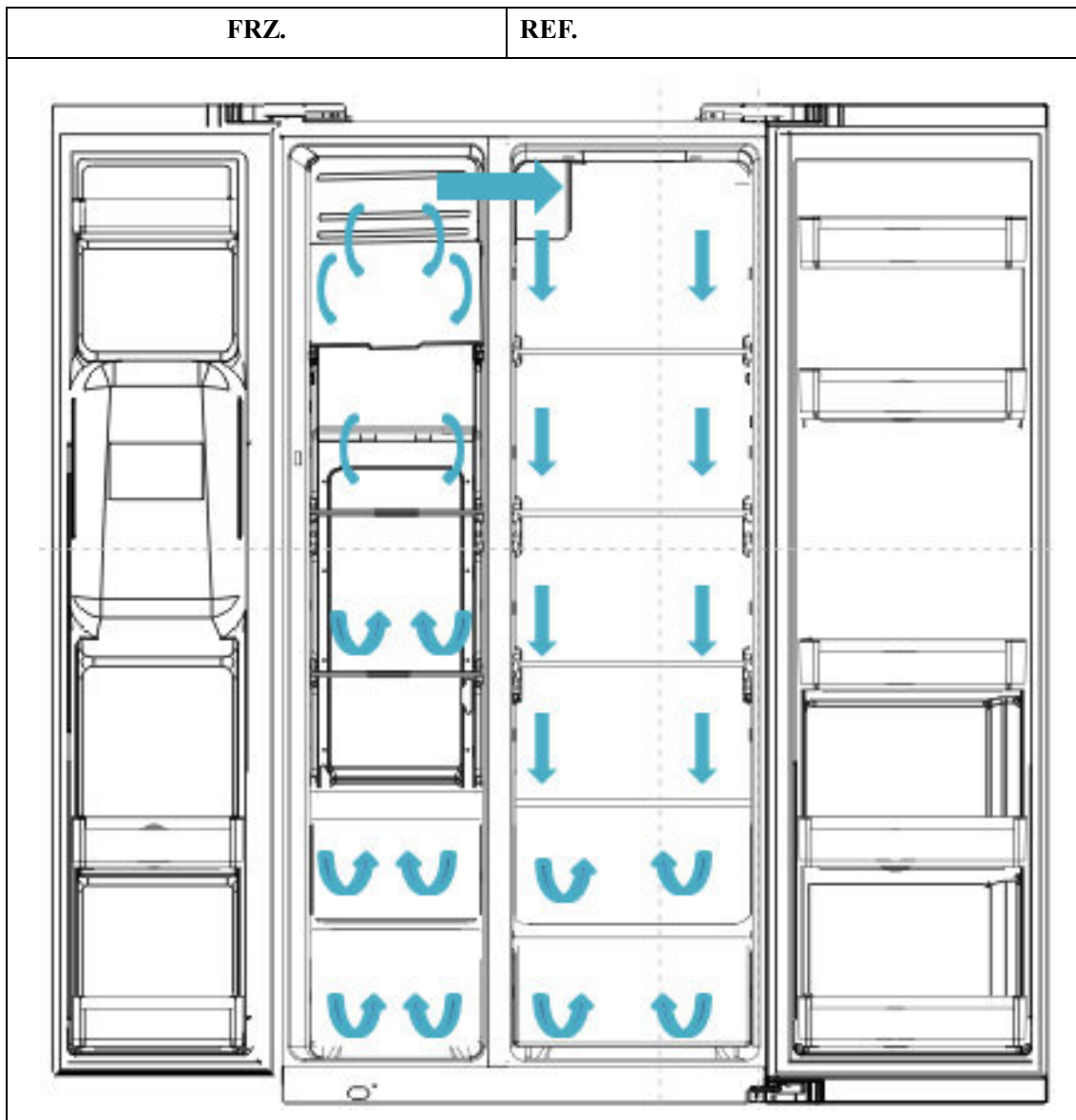

7.2 Circulating route of cooling air



(The picture is only for reference, and specific appearance and configuration are subject to the real product)

8. 8. Dismantling of parts

8.1 Parts on the door



Door seal	
<p>1) 2) Door seal is installed into door liner groove. Open the refrigerator door; Take the door seal ① out of door liner;</p>	
Door tray	
<p>While squeezing it inward, lift up the baffle and take it out from refrigerator liner.</p>	
Door stopper	None
rollover beam	None



8.2 Parts inside the refrigerator

Shelves	
<p>1) Lift up the division plate with a proper force and pull it out towards yourself;</p>	

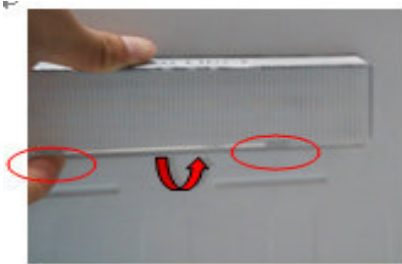

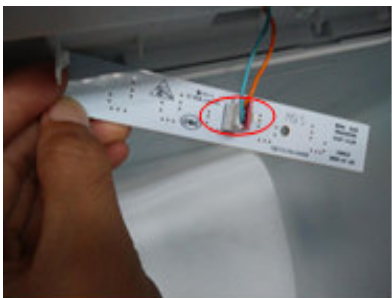
Drawer	
<p>1) 2) The drawer is located at the bottom of freezing and refrigerating chambers; Pull the drawer out completely; Lift it up slightly and take it out from the refrigerator.</p>	

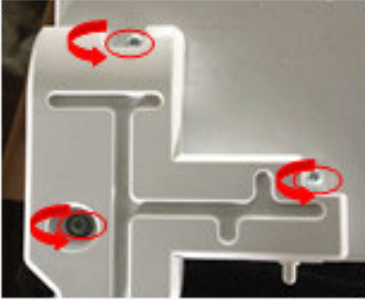
8.3 Light system

Light	
<p>1) Turn over the lampshade hard with your hands or two flat-blade screwdrivers at two grooves marked with red circles shown in the picture and take it down</p>	
<p>2) Push away the hook with your hand along the arrow direction shown in the picture and separate LED light panel from the hook; then take down LED light panel</p>	
<p>3) Remove the connecting harness terminals on LED light panel and take down the LED light panel.</p>	
Light switch	



<p>1) As shown in the picture, loosen by screwdriver 3 fixing screws of the hinge cover and take it down</p>	
<p>2) Press the snap joint in the circle and push it outward along the arrow direction. Complete the disassembly of door light switch.</p>	
<p>Pilot light</p>	<p>None</p>
<p>Fresh light</p>	<p>None</p>

8.4 Air duct components refrigerating chamber

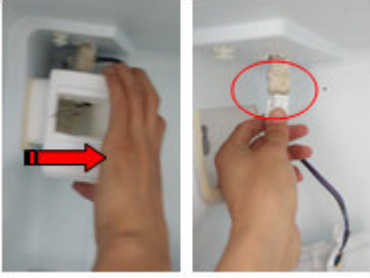
<p>Air duct components refrigerating chamber</p>	
<p>1) Remove by cross screwdriver the screws on the positions shown in the picture anticlockwise.</p>	
<p>2) Pull the decoration cover of refrigerating air duct to the right along horizontal direction until air duct decoration cover completely falls off from refrigerator body and air duct foam and take out the decoration cover of refrigerating air duct.</p>	

<p>3)</p> <p>Catch hold of air duct foam in refrigerating chamber and pull it towards the right along the arrow direction shown in the picture until air duct foam is separated from refrigerator body, remove connecting terminals of ventilation door and take out refrigerating air duct foam.</p>	
--	--

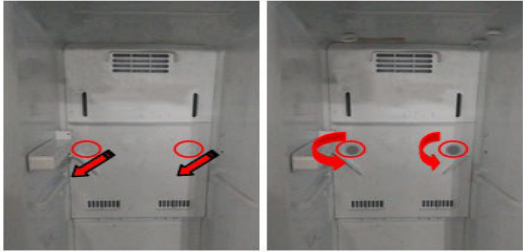
8.5 Air duct components in freezing chamber and fan motor

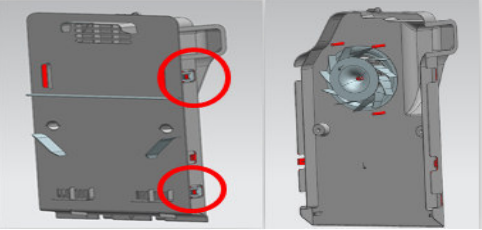
Disassembly and installation of Air duct	
<p>1)</p> <p>First, take out the screw cap of air duct cover with flat-blade screwdriver or blade; then, remove by cross screwdriver the two screws fixing air duct cover anticlockwise.</p>	
<p>2)</p> <p>As shown in the right picture, catch hold of upper part of freezing air duct as shown in the picture, pull it outward along the arrow direction with strength until air duct is separated from refrigerator body, remove the connecting harness between fan and refrigerator body, and take down freezing air duct.</p>	
<p>3)</p> <p>Pull the snap joint of upper air duct outward to make cover plate of upper air duct in freezing chamber fall off from air duct.</p>	

<p>4)</p> <p>Evaporator cover ahead of freezing chamber After the removal of upper air duct in freezing chamber.</p> <p>Catch hold of cover plate of freezing lower air duct shown in the picture, pull it out along the arrow direction until it is separated from refrigerator body and take it out.</p>	
---	--

Fan motor of air duct

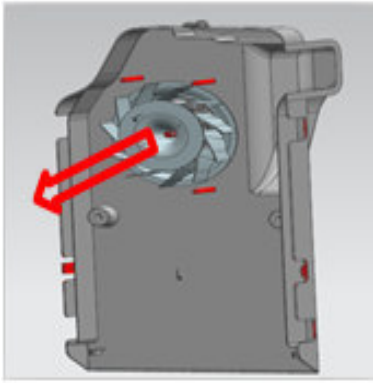
<p>1)After the removal of cover plate of upper air duct in freezing chamber. Pull the motor fan of upper air duct in freezing chamber outward to make the fan blade separate from the motor.</p>	
---	---

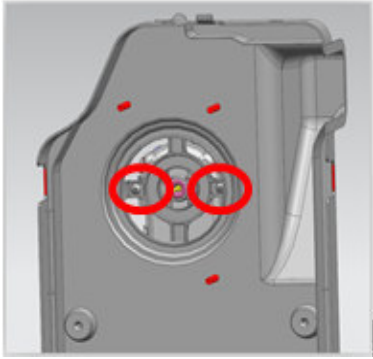
<p>2)Remove by cross screwdriver the two fixing screws anticlockwise. Complete disassembly of the motor</p>	
--	--

8.6Evaporator and temperature sensing system

Evaporator in freezing chamber

Evaporator in freezing chamber

- 1.Remove the air duct components in freezing chamber.
- 2.Disconnect all connectors.
- 3.Remove the welding on inlet and outlet tubes.
- 4.Remove two screws which are used to fix the evaporator and remove the evaporator.

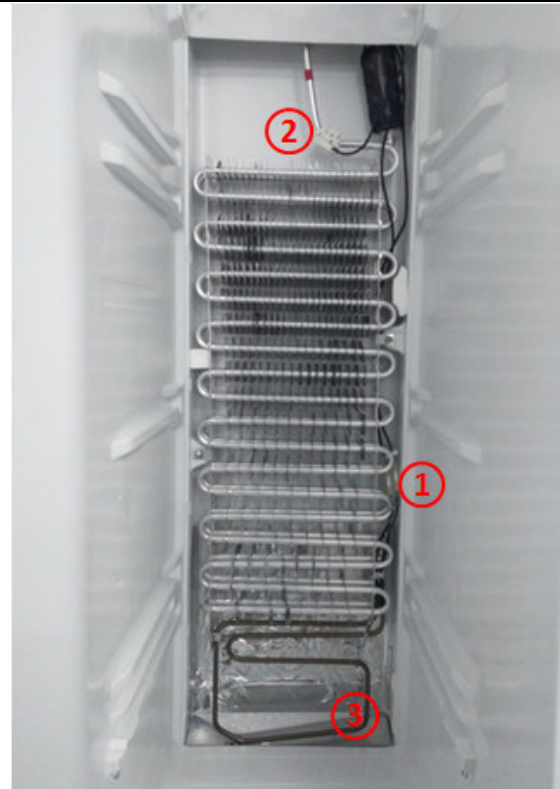

Components on the evaporator

Fuse (①)



- 1.Disconnect the fuse connector.
 - 2.Cut off the band which fixes the fuse.
 - 3.Separate the fuse and the evaporator.
- *Don't break the welding of the evaporator in case that only the fuse needs to be replaced.





Defrost sensor (②)

- The defrost sensor is located on top of the evaporator.
- 1.Disconnect the connector of defrost sensor
 - 2.Cut off the band which fixes the sensor.
 - 3.Separate the sensor and the evaporator.
- *Don't break the welding of the evaporator in case that only the sensor needs to be replaced.

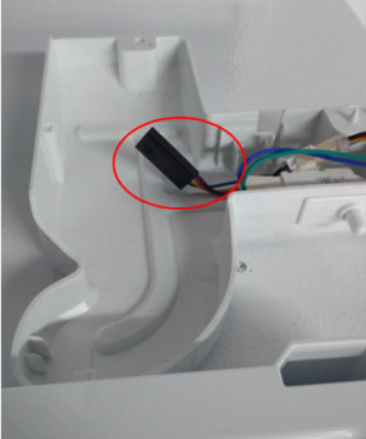

<p>Defrost heater(③)</p> <p>The defrost heater is located at bottom of the evaporator.</p> <ol style="list-style-type: none"> 1.Disconnect the connector of defrost heater. 2.Cut off the band which fixes the defrost heater. 3.Take off the defrost heater from the evaporator. <p>*Don't break the welding of the evaporator in case that only the defrost heater needs to be replaced.</p>	
<p>Evaporator in refrigerating chamber</p>	
<p>Evaporator in refrigerating chamber</p>	<p>None</p>
<p>Components on the evaporator</p>	<p>None</p>
<p>Temperature Controller</p>	<p>None</p>
<p>Sensor</p>	
<p>Sensor in freezing chamber</p> <p>To remove the sensor cover, you may squeeze it up and down;</p> <p>Take the sensor out from card slot;</p>	
<p>Sensor in refrigerating chamber</p>	<p>Refer to the method of disassembling the freezer compartment sensor.</p>
<p>Sensor in Variable temperature chamber</p>	<p>None</p>
<p>Ambient temperature sensor</p> <p>The sensor used for measurement of ambient temperature is located within upper hinge cover of refrigerating chamber door;</p>	

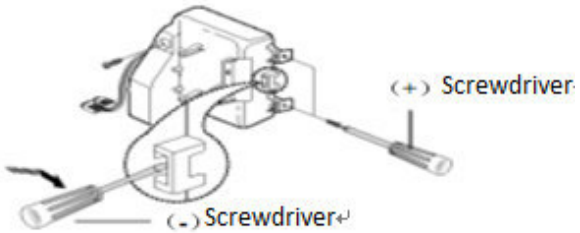
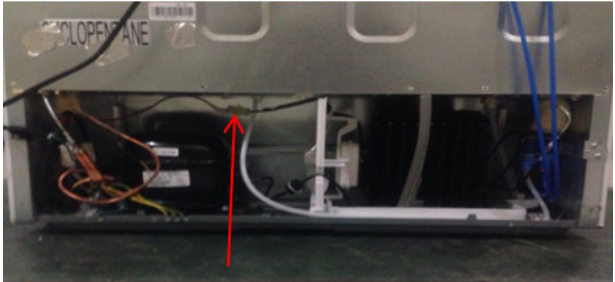
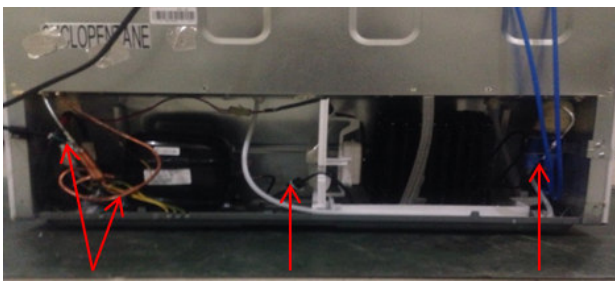
8.7 Compressor case

<p>Rear cover and compressor case</p> <p>1) Remove by cross screwdriver the screws fixing back cover plate of compressor chamber anticlockwise</p> <p>2) Take the back cover plate of compressor chamber upward.</p>	
<p>Terminal box of the compressor</p> <p>Remove the screws fixing block terminal, press the tap on block terminal and take down block terminal cover with flat-blade screwdriver.</p>	
<p>Condenser fan motor</p>	
<p>CE-BCD508WE-JT_22031050000201</p>	
<p>1) Unplug the wiring connector by pressing the terminal lock</p>	
<p>2) Cut off the pipe what the arrows indicate, then discharge all gas</p>	
<p>3) Lay down the refrigerator in the direction of door towards the ground</p>	

4) rotate the screw anti-clockwise what the arrows indicates in left picture, then pull out the fan bracket towards the direction what the arrows indicate.

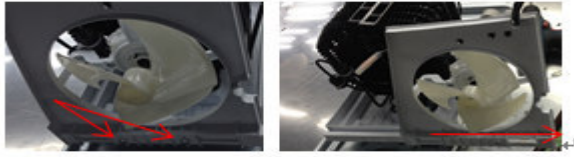

Standby condenser None

Piping system in the compressor case

CE-BCD508WE-ST_22031050000382 (CE-BCD508WE-FT_22031050000081)
 (CE-BCD508WE-ST_22031050000005) (SR-BCD508WE_22031050000301)

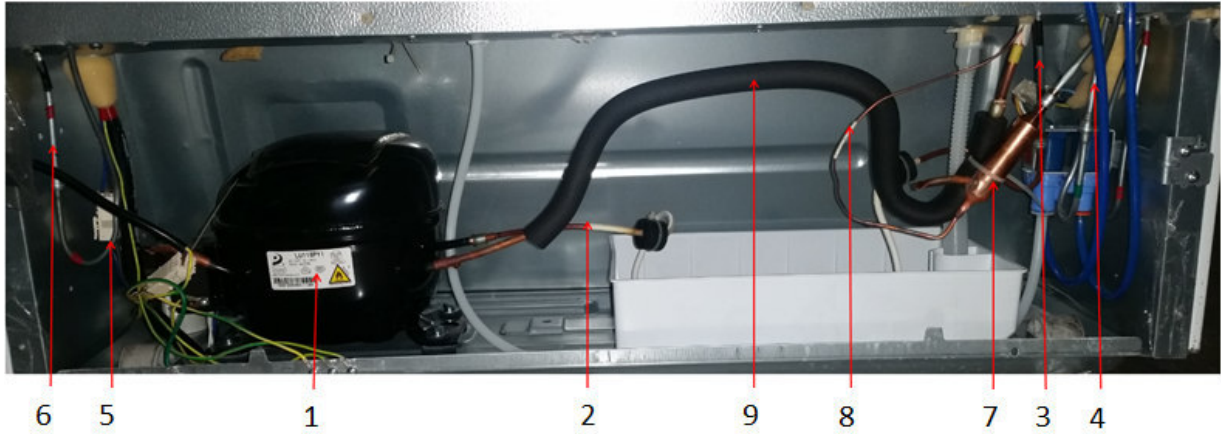

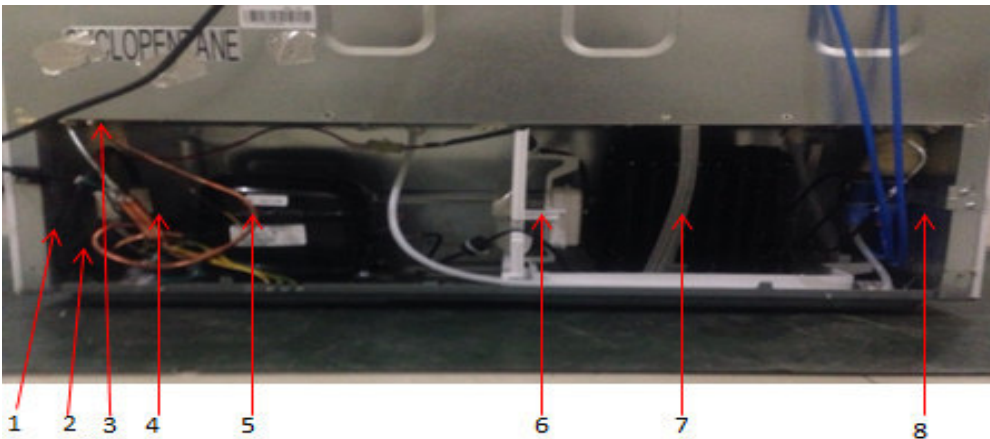

- | | |
|--|---|
| <ul style="list-style-type: none"> 1.Compressor 2.Transition pipe 3.Back Condenser 4.Left Condenser 5.Anti-water condensed pipe | <ul style="list-style-type: none"> 6.Right Condenser 7.Drier 8.Capillary Tube 9.Suction connection Pipe |
|--|---|

CE-BCD508WE-JT_22031050000201



- | | |
|---|--|
| <ul style="list-style-type: none"> 1. Suction PipeCapillary TubeAnti-water condensed pipeDrier | <ul style="list-style-type: none"> 2. CompressorCondenser fanCondenserAnti-water condensed pipe |
|---|--|

8.8 Display control board

1) Use vacuum cap to pull the control panel outwards	
2) Disconnect the fast connector, then remove the control PCB	 

8.9 Main control board

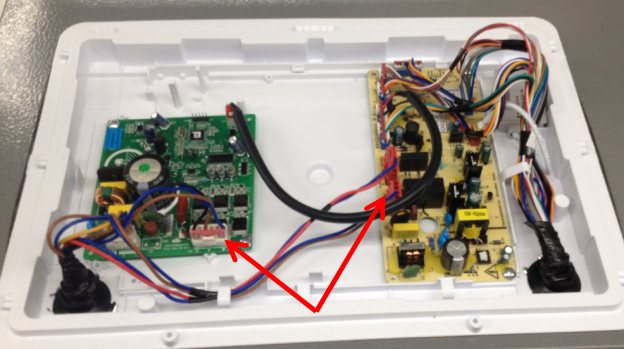
Have variable frequency driver board	
CE-BCD508WE-ST_22031050000382(CE-BCD508WE-JT_22031050000201)	
1) remove the screw anticlockwise, then remove the PCB housing cover	
2) Pull the lock of fast connector upwards, then disconnect the fast connector	

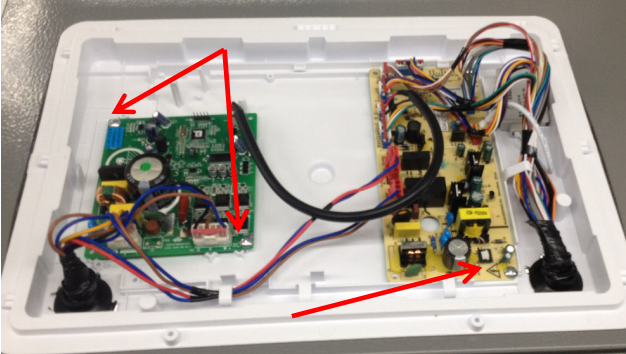
<p>3) Remove the screw anticlockwise, then remove the PCB and variable frequency driver board.</p>	
--	--

Without variable frequency driver board
CE-BCD508WE-FT_22031050000081(CE-BCD508WE-ST_22031050000005)
(SR-BCD508WE_22031050000301)

<p>1) remove the screw anticlockwise, then remove the PCB housing cover</p>	
---	--

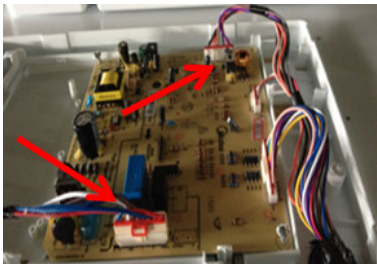
<p>2) Pull the lock of fast connector upwards, then disconnect the fast connector</p>	
---	---

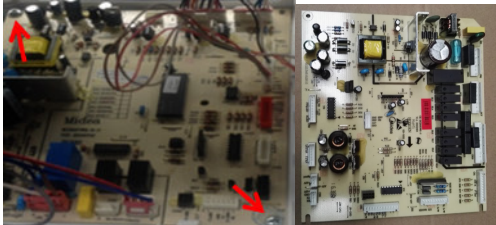
<p>3) Remove the screw anticlockwise, then remove the control PCB</p>	
---	--





8.10 Bar counter(None)

Disassembly and installation of bar counter	None
Disassembly and installation bar doorseal	None

8.11 Water dispenser(None)

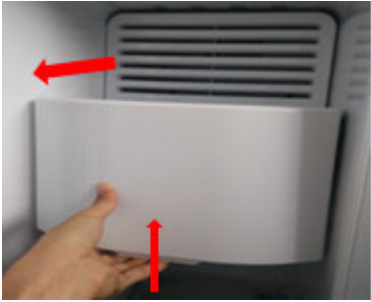
Disassembly and installation of water valve	None
Disassembly and installation of water tank	None

8.12 Ice maker

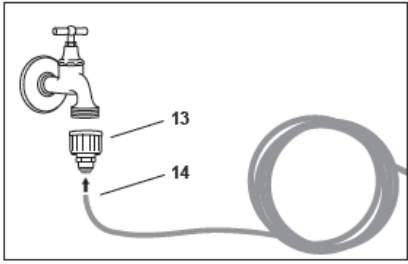
disassembly of ice maker(only professionals are permitted to operate)	
<p>1) As shown in the photo, please up lift the ice storage box assembly and pull it out, then the ice storage box can be taken out.</p>	
<p>2) Pull the ice tray assembly outwards forcefully, and disconnect the wiring connector, then the ice tray assembly can be taken out from refrigerator.</p>	
<p>3) Use cross screwdriver(anticlockwise) to remove the screws of protective cover of wiring connector</p>	
<p>4) Use cross screwdriver (anticlockwise) to remove the 4 screws of motor of ice releasing, then the motor can be taken out from refrigerator.</p>	
assembly of water system	
<p>You need a suitable adapter for connecting the water pipe with the water tap.</p> <p>1) Please insert the water pipe(14) into one end of adapter(13);</p> <p>2) Fix another end of adapter on the water tap.</p>	

- 3) Remove the cap of water pipe(16);
- 4) Insert the end of water pipe into one end of fast connector(15);

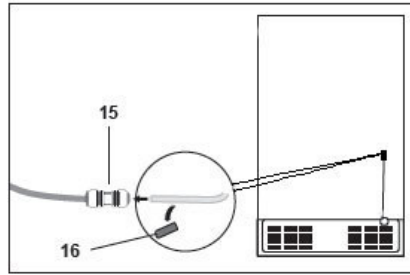

Disassembly of filter(refer to A or B)

Disassembly of filter built-in

CE-BCD508WE-FT_22031050000081(CE-BCD508WE-ST_22031050000005)(CE-BCD508WE-JT_22031050000201) (SR-BCD508WE_22031050000301)

The filter is located in the upper right of the refrigerator, rotate 90 ° in the direction of the arrow to remove the filter.

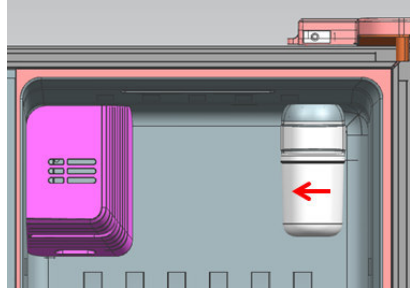

Disassembly of filter external

CE-BCD508WE-ST_22031050000382

Pull out the plug. Turn off the water intake. Take off the filter and the snap ring on the quick connector and then pull out the water pipe. Insert the new filter into the quick connector and then install the snap ring. Re-supply water and check whether there is water flowing out.

If necessary, please repeat above steps. Insert the plug again. Keep pressing the button for 3 seconds to start up the filter. The display of disappears.

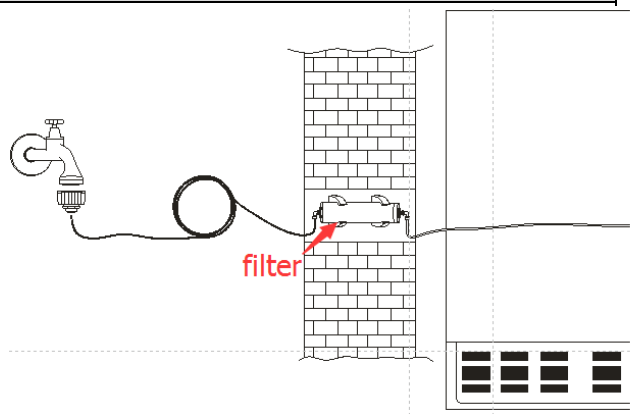

9. Function and operation 9.1 Operation panel

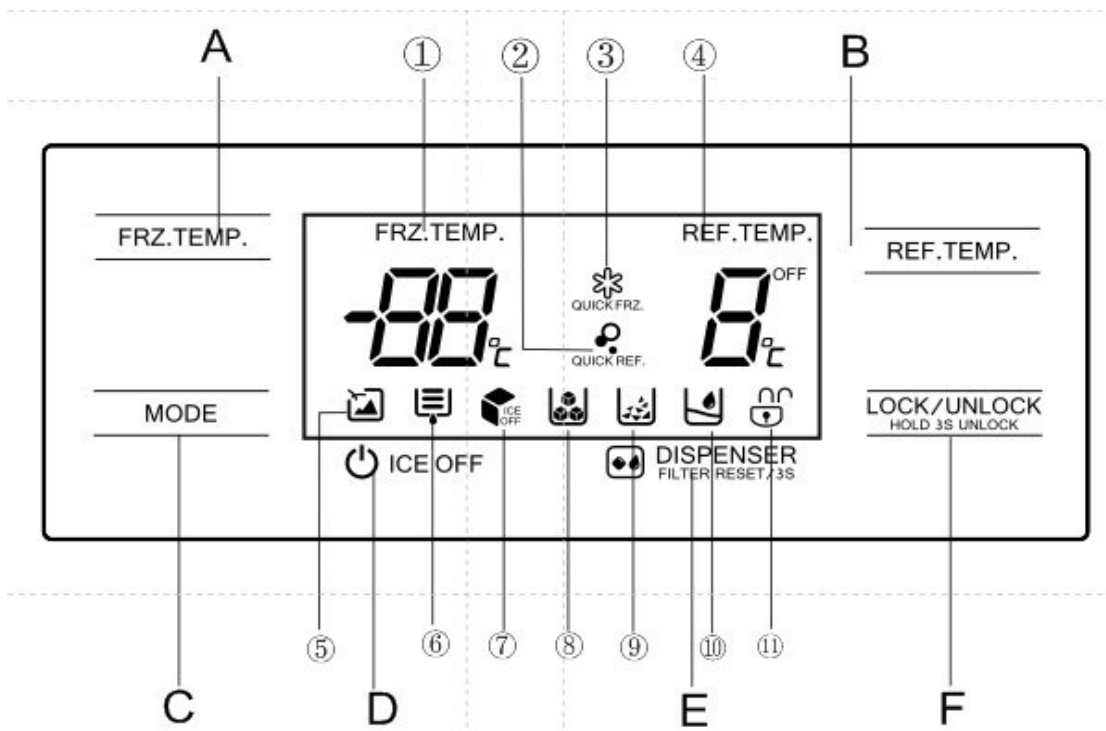

<p>Icons:</p> <ol style="list-style-type: none"> 1. display zone of frozen temperature 2. icon of fast cooling 3. icon of fast freezing 4. display zone of cooling temperature 5. vacation icon 6. reminding icon of filter replacement 7. icon of ice maker turn off 8. ice taking icon 9. crushed ice taking icon 10. cooling water taking icon 	<p>Button:</p> <p>A FRZ. TEMP. B REF. TEMP. C MODE D ICE OFF E DISPENSER F LOCK/UNLOCK</p>
---	---

9.2 Temperature control

1) Temperature adjustment of refrigerator compartment

Press “REF. TEMP” button, the display digital of cooling temperature will blink, then press “REF. TEMP” to adjust setting temperature, the setting temperature is changed circularly “8°C · 7°C... · 2°C · 8°C.....”

2) Temperature adjustment of Freezer compartment

Press “FRZ. TEMP” button, the display digital of frozen temperature will blink, and then press “FRZ. TEMP” to adjust setting temperature, the setting temperature is changed circularly “-16°C → -17°C... → -24°C → -16°C.....”

3) Frequently-used MODE

Press “MODE” button, consumer can set “vacation”->”fast freezing”->”fast freezing + fast cooling”->”fast cooling”->”vacation”->...” circularly, the icons of corresponding modes will light on/off synchronously

Vacation mode: the freezer compartment will work as the setting temperature is -18°C, the refrigerator

compartment is turn off;

Fast freezing mode: the freezer compartment will work as the setting temperature is -24°C , and after 26 hours the freezer compartment will quit this mode automatically and work according to last temperature setting;

Fast cooling mode: the refrigerator compartment will work as the setting temperature is 2°C , and after 150 minutes the refrigerator compartment quit this mode automatically and work according to last temperature setting;

When press "REF. TEMP" or "FRZ. TMEP" button, the "Vacation Mode" will be stopped, the refrigerator compartment and freezer compartment will work according to last temperature setting;

When press "FRZ. TEMP" button, the "Fast Freezing Mode" will be stopped, the freezer compartment will work according to last temperature setting;

When press "REF. TEMP" button, the "Fast Cooling Mode" will be stopped, the refrigerator compartment will work according to last temperature setting;

9.3 give an alarm

When refrigerator door or freezer door is open, the display panel is light on.

there is no notification tone when open door; if refrigerator door or freezer door is open last for 120s, there will be buzzer alarm, afterwards give alarm one time per second, press any buttons on control panel can cancel this buzzer alarm.

Note: under the situation of the refrigerator compartment turn off, the door switch and internal lamp works properly.

Note:hen open the door, the display panel is light on; when the door is closed, the display panel will be light off after 30s if there is no any operation on display panel

9.4 Defrosting

Defrosting theory and steps:

Defrosting theory:

The defrosting of evaporator is realized by the heating of heater, following the temperature rise, the frost on evaporator becomes water, and the water flow into the evaporating pan via the draining system, the water in evaporating pan evaporate away finally

Defrosting steps:

Compressor switch off- -air duct closed---the fan in freezer chamber works for 3~10 min(for different kinds of refrigerators, the time is different too)---the heater start working---the heater switch off when the temperature rise to setting---defrosting done.

9.5 Function Selection

1) Ice maker on/off

Press "ICE OFF" button to turn on/off ice maker, the default setting is off

2) Options for ice /cooling water

Press "DISPENSER" button to choose "ice taking", "crushed ice taking" and "cooling water taking" circularly, the corresponding icons will light on/off

The reminding icon of filter replacement will light on after the filter works last for 150 days., and the icon will blink after the filter works last for 180 day, reset the timer by pressing "DISPENSER" button for 3s.

3) Time setting of water intake of ice maker

Press both "FRZ. TEMP" button and "REF. TEMP" button last for 2 s, the control panel will enter into setting status, press "REF.TEMP" button or "FRZ. TEMP" to increase or reduce the intake time

(The adjustable range is from 5s to 25s), the setting time is displayed in FRZ. Temperature zone.

Lock the panel or press both "FRZ. TEMP" button and "REF. TEMP" button last for 2 s will quit the setting status.

4) Mandatory mode (mandatory compressor starting, mandatory defrosting and mandatory ice making)

All below functions are only for diagnosis purpose, we advise to restart the refrigerator by power on/off if have

used these functions.

Buttons operation:

Press both “LOCK/UNLOCK” and “FRZ.TEMP” button last for 3s to enter into/quit mandatory mode, the setting will take effect after locking.

Press “FRZ.TEMP” button, the ref. temperature zone will display “1” “2” “3” “4” circularly,

Different figures represent different functions:

- 1) When display “0”, the refrigerator will not enter into anyone mandatory mode, and quit the mandatory mode.
- 2) When display “1”, the compressor will start working last for 36 hours, then it will quit this mode automatically and back to normal working status.
- 3) When display “2”, the evaporator heater will start work last for 2 min at least.
- 4) When display “3”, the ice maker will turn over the ice for twice, then intake water.

9.6 Self-diagnosis

Communication self-diagnosis

The system will verify the communication with 8s after 1st time power on. If failure happens, it will display the error code immediately. During normal working, if the failure happens last for 1 minute, it will display the error code.

The ice maker will conduct self-diagnosis during working

If the failures can be recovered automatically, the error can be lifting automatically

9.7 Compressor fan control(None)

9.8 Error code and solution

Table 9-1: Fault Codes Table

Error Code	Failure Type	Solution
E0	Mechanical fault of ice maker	to check relevant connectors, feedback signal of ice maker, motor of ice maker and main PCB
E1	Circuit fault of refrigerating temperature sensor	to check relevant connectors, sensor and main PCB
E2	Circuit fault of Freezing temperature sensor	to check relevant connectors, sensor and main PCB
E5	Circuit fault of evaporator heater sensor	to check relevant connectors, sensor and main PCB
E6	Communication fault	to check relevant connectors, main PCB
E7	Circuit fault of ambient temperature sensor	to check relevant connectors, sensor and main PCB
EE	Circuit fault of ice maker sensor	to check relevant connectors, sensor and main PCB
EH	Circuit fault of ambient humidity sensor	to check relevant connectors, main PCB

10. Circuit description

10.1 Power Supply

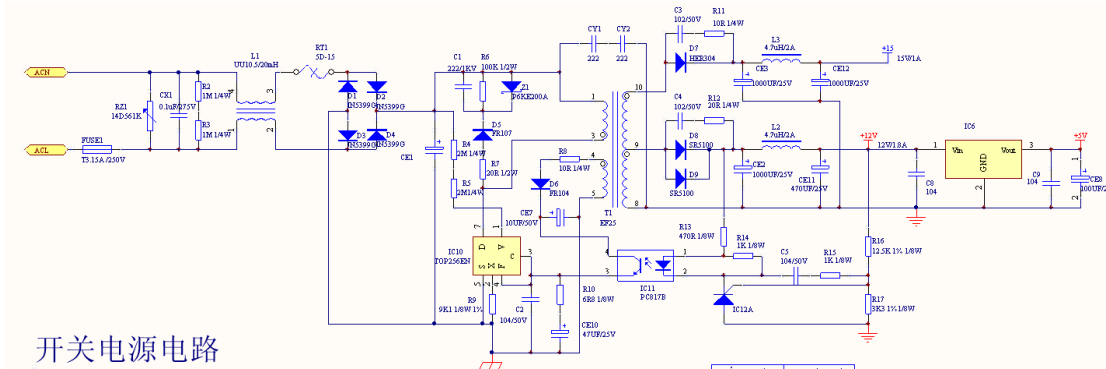

AC input power would be reduced by SMPS control chip, then output stable DC12V and DC15V power after treated by LC and filter. DC12V power is provided to relay (control strong electricity), internal lamp and control panel, DC15V powers are provided to fan motor (voltage variation control the RPM of motor, lowest voltage is 8V). DC12V power is changed into DC5V power by regulator, to provide main control chip with power, monitoring the temperature status of refrigerator

10.2 Test circuit for door switch

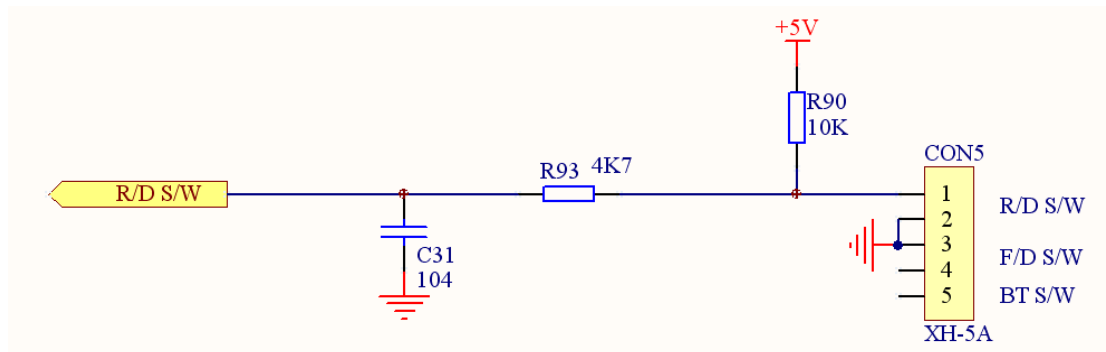

As show as above picture, take the door switch of refrigerator as example, the door switch is connected between 1 and 2 serially, when door is closed, the switch is in off-state, high-level be detected at MCU port; when the door is open, the switch is in on-state, low-level can be detected at MCU port. by high-level or low level detected, MCU can judge the door is closed or open.

10.3 Temperature test circuit

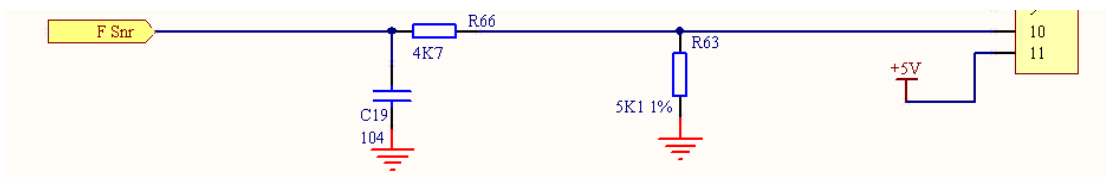

Take the temperature sensor of freezer compartment as example, this sensor is connected between 10 and 11 serially, by utilizing the characteristic of Ohmic value reduced following the temperature rise, sensor and

temperature acquisition circuit constitute voltage divider circuit, MCU figure out the Ohmic value by the divider value, and conclude the freezer compartment temperature according to Ohmic value-temperature value table

10.4 Freezer fan motor circuit

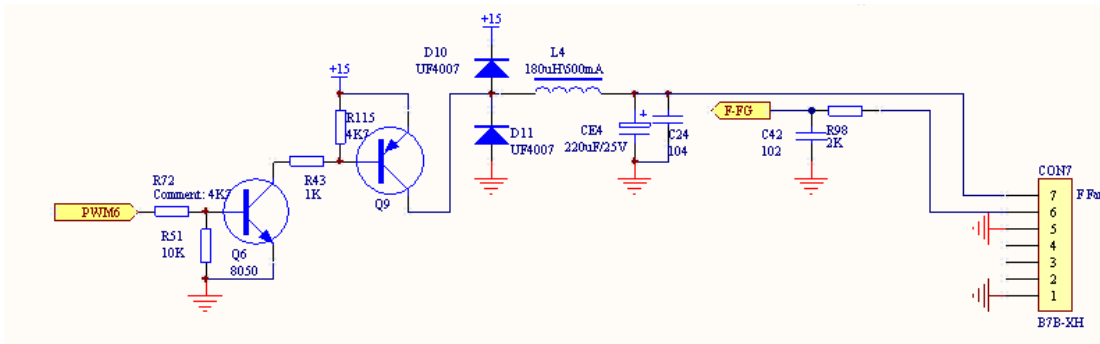

The freezer fan is connected between 7 and 5. When the fan is requested to work, MCU send controlling signal to output PWM wave, and Q9 turn on and turn off periodically, Periodical current will be filtered by LC, and output regular voltage, MCU can change the PWM wave shape so as to adjust the voltage value

10.5 REF.fan motor circuit(None)

10.6 Condenser fan motor circuit(None)

10.7 Damper motor circuit

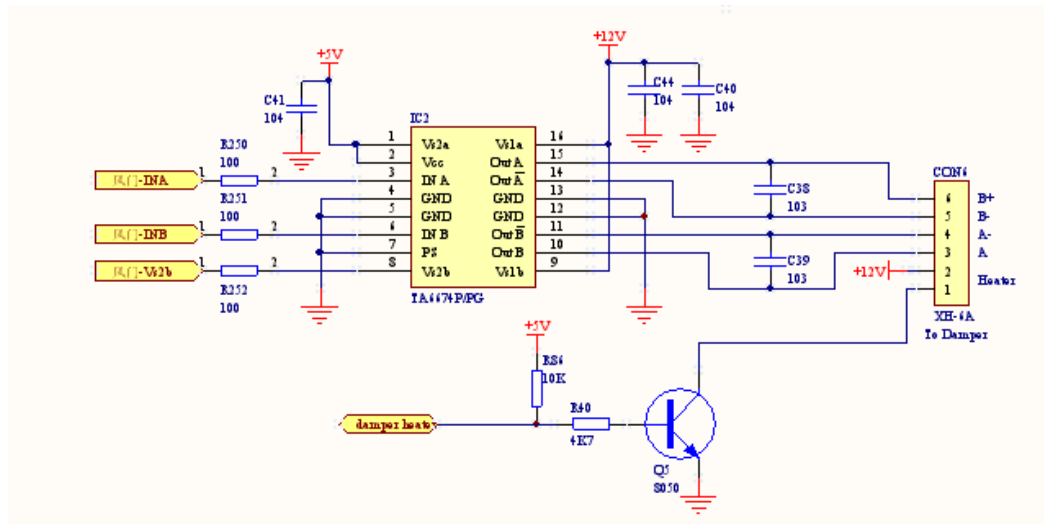

The damper is controlled by stepping motor, the output is square wave by control of special control chip, when the refrigerator compartment request cooling, the motor switch on, otherwise, the motor switch off.

10.8 Sensor resistance(R/T)

Tx(°C)	R (KΩ)	Tx(°C)	R (KΩ)	Tx(°C)	R (KΩ)	Tx(°C)	R (KΩ)	Tx(°C)	R (KΩ)
-30	33.81	-15	14.31	0	6.495	15	3.141	30	1.617

-29	31.85	-14	13.55	1	6.175	16	2.999	31	1.55
-28	30.01	-13	12.83	2	5.873	17	2.865	32	1.486
-27	28.29	-12	12.16	3	5.587	18	2.737	33	1.426
-26	26.68	-11	11.52	4	5.315	19	2.616	34	1.368
-25	25.17	-10	10.92	5	5.06	20	2.501	35	1.312
-24	23.76	-9	10.35	6	4.818	21	2.391	36	1.259
-23	22.43	-8	9.82	7	4.589	22	2.287	37	1.209
-22	21.18	-7	9.316	8	4.372	23	2.188	38	1.161
-21	20.01	-6	8.841	9	4.167	24	2.094	39	1.115
-20	18.9	-5	8.392	10	3.972	25	2.005	40	1.071
-19	17.87	-4	7.968	11	3.788	26	1.919	41	1.029
-18	16.9	-3	7.568	12	3.613	27	1.838	42	0.9885
-17	15.98	-2	7.19	13	3.447	28	1.761	43	0.9506
-16	15.12	-1	6.833	14	3.29	29	1.687	44	0.914

11. Troubleshooting Method

11.1 No cooling (Air cooling-Electronic)

No cooling of F room and R room

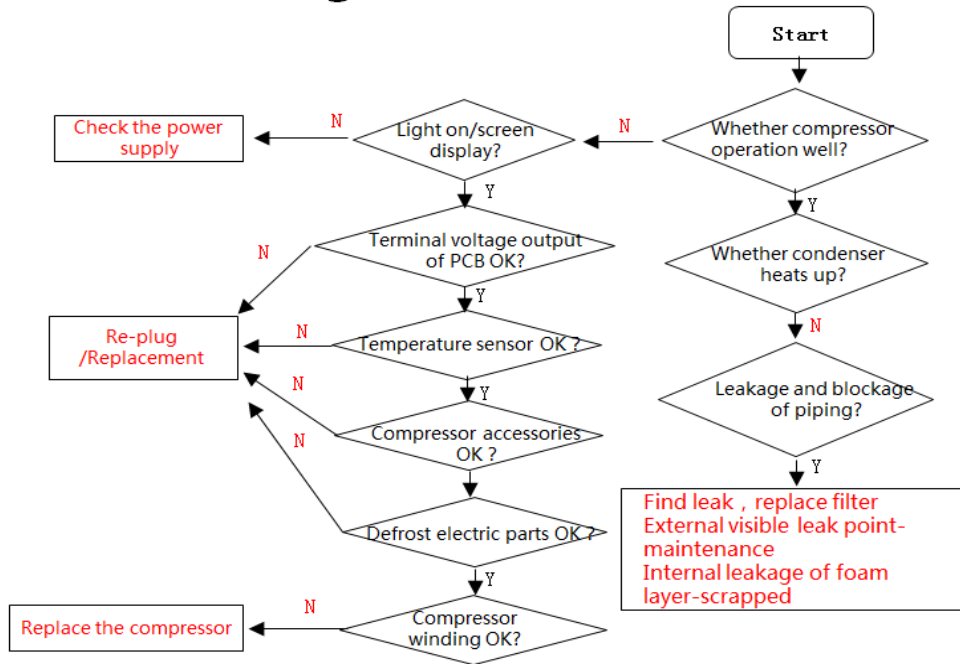

F room cooling, R room no cooling

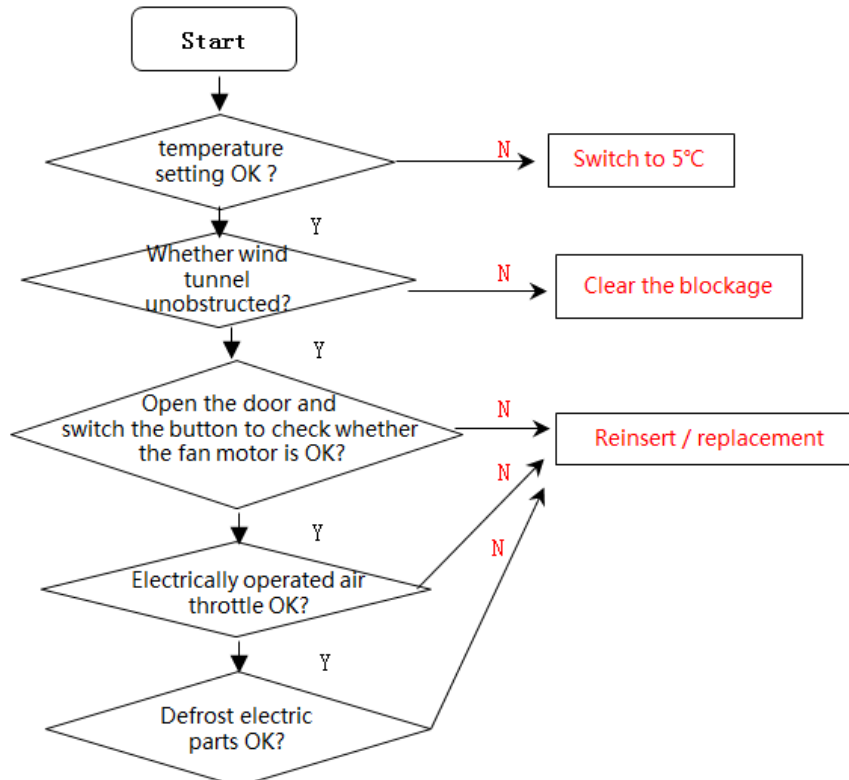

11.2 No working of compressor

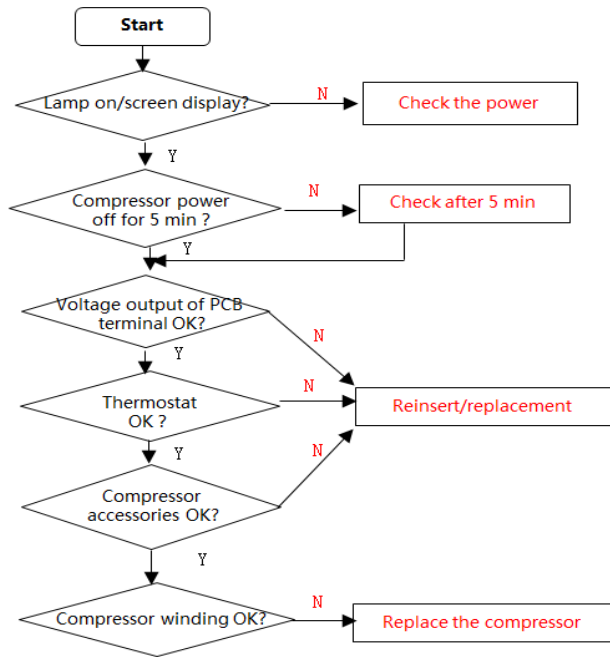

11.3 Inside frosting, no defrosting

Inside frosting, no defrosting

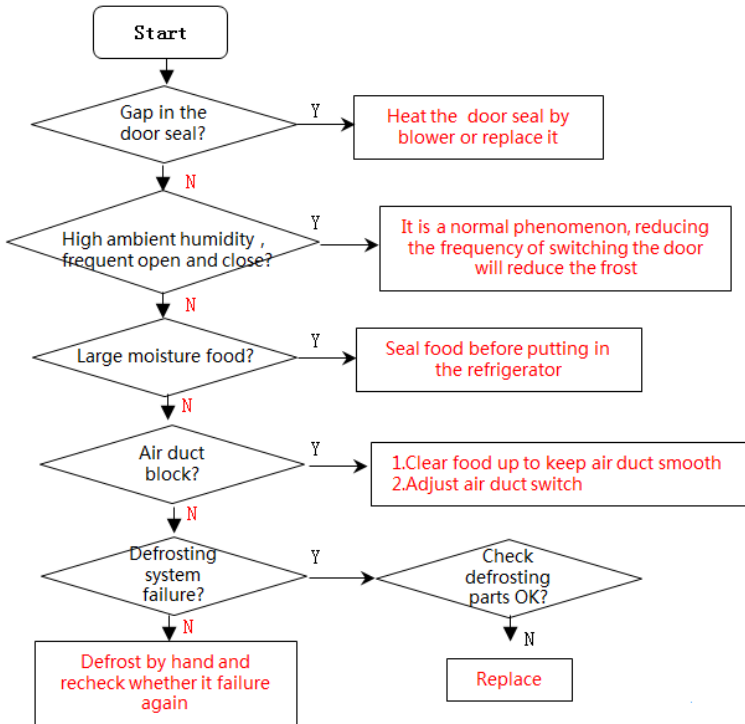

11.4-Inside frosting, no defrosting-Maintenance guidelines

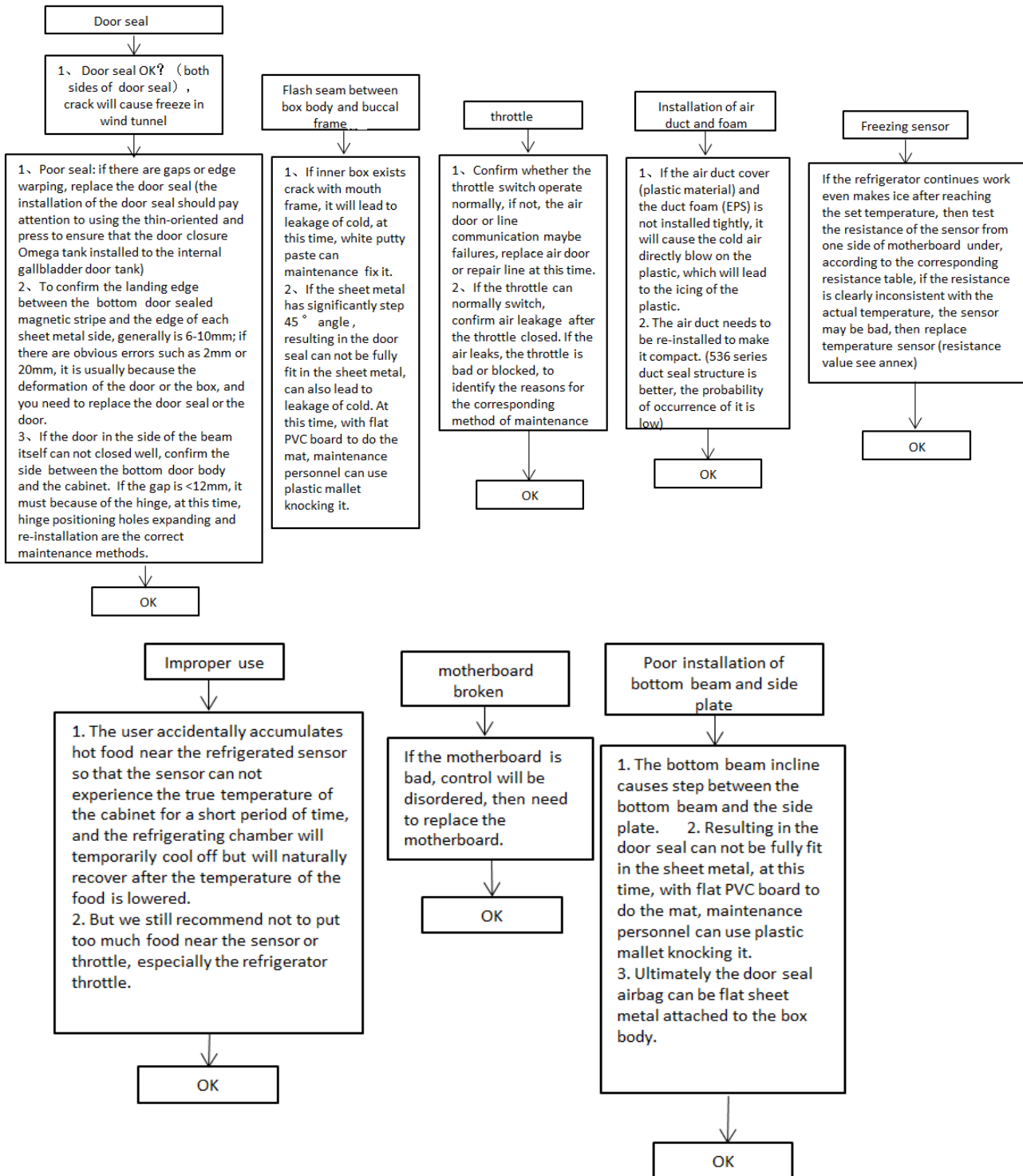

11.5 Light is not on

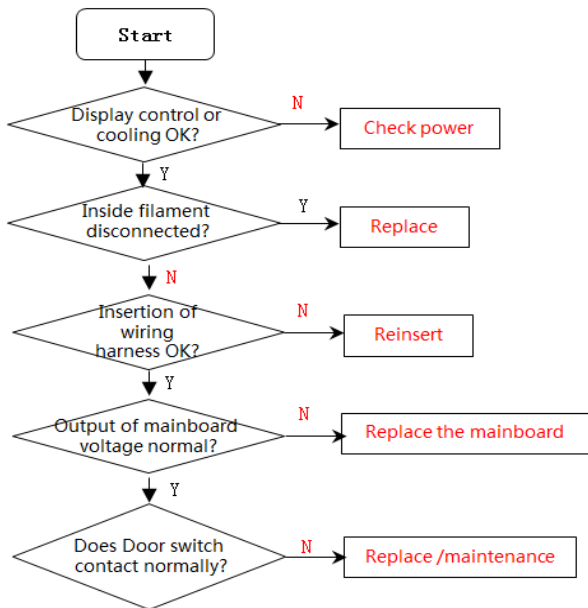

11.6 Air duct not operated(electronically)

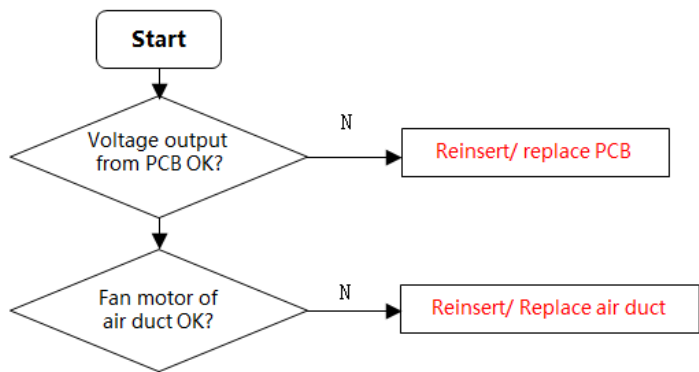

11.7 Fan failure

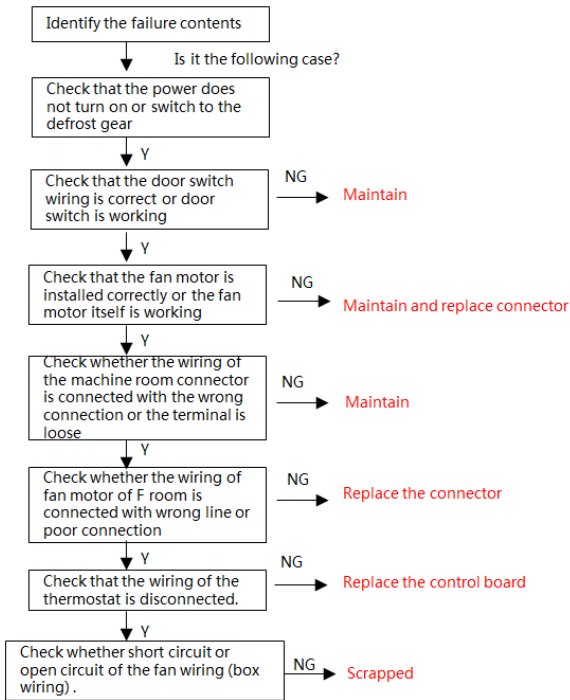

Normal phenomenon for no working of the fan:

1. Poor fan connection or poor installation, loose or reverse of the door switch connector
2. Poor fan installation, leaf contact with the inner board of the foam or touch the line.
3. Insurance circuit of the fan wiring.
4. The timer is not reset in the defrost position .
5. The wire terminals inside the machine compartment connector or control board connector are loose.
- 6 . The door switch itself is defective or the circuit board is defective (electronic refrigerator).

11.8 Defective defrost circuit

Defective defrost circuit

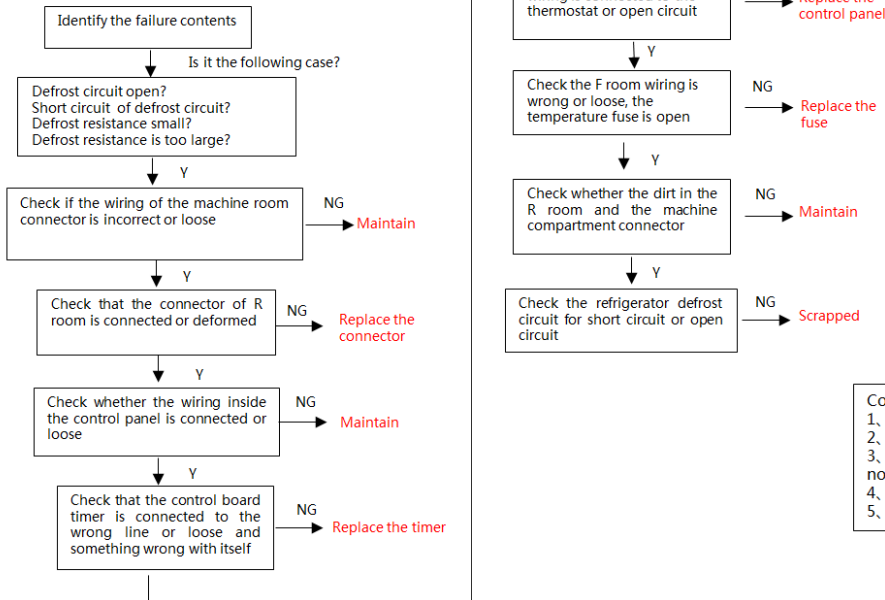

△With a multimeter to measure the refrigerator power plug poles, the timer transferred to defrost position measured resistance should be in the range of 6 ~ 8K for qualified
 △Check whether the mating of the terminal and the hole is strong and the wiring of the female and male connector is matched (in general, the color line corresponds to the color line)
 △Check that the timers are wired for compliance
 △Inspect leaks or deformation of the connector

Common phenomenon of poor defrost circuit :

1. The defrost fuse is open.
2. The timer is connected to the wrong line.
3. The connector has a leaky bubble liquid that is not clean.
4. The connector is not tight enough to be loose.
5. The internal wiring of the box is open.

11.9 Noise

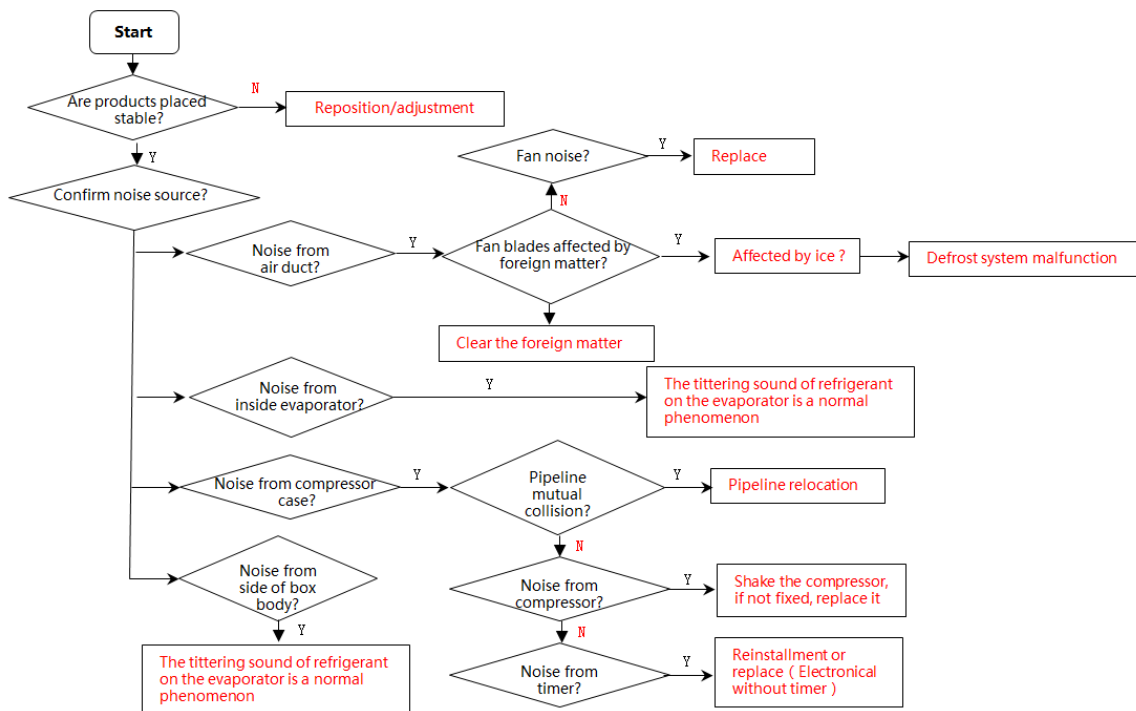

12. Figures and details of repair parts(Documents are provided separately)

12.1 Figures

12.2 List of parts and components

13 Appendix:

13.1 Electrical Schematic Diagram

(Model: ***)

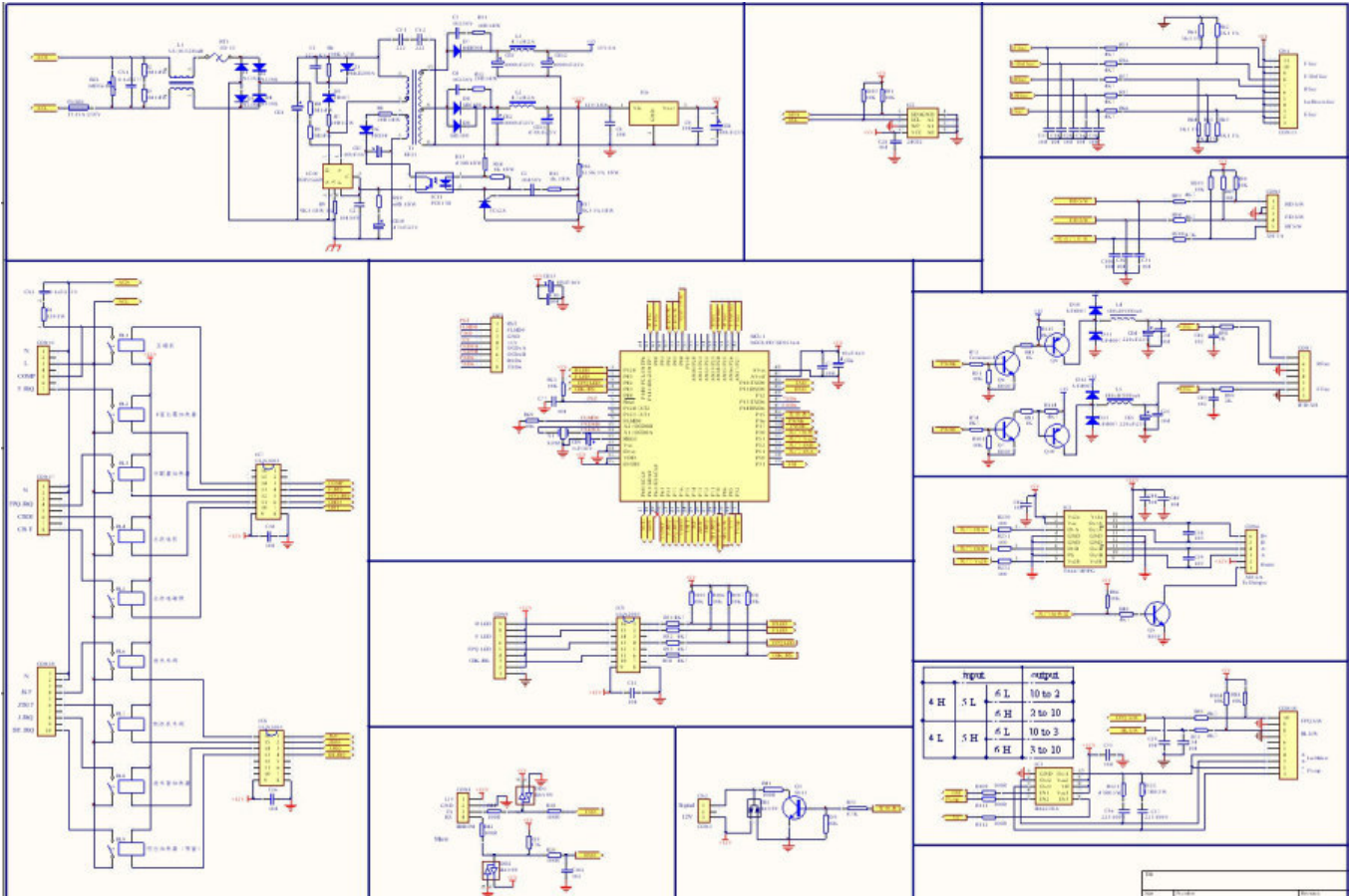

13.2 Refrigerator maintenance tooling and equipment and material

Tooling

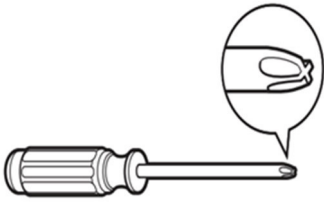
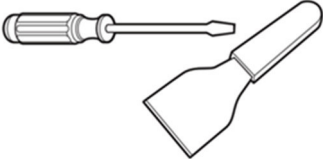
No.	Name	Photo	Main Usage
1	Phillips screwdriver		screw assemble and disassemble
2	slotted screwdriver/scrapper		screw and rivet assemble and disassemble

Midea Refrigerators

If you need to get detailed technical information from the manufacturer, please contact:

xxx@midea.com

Refrigeration Division

Overseas Sales Company

Address: No. 176, Jinxiu Avenue, Economic-Technological Development Area, Hefei, Anhui, China

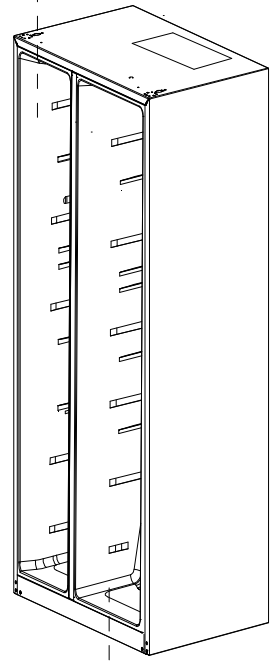
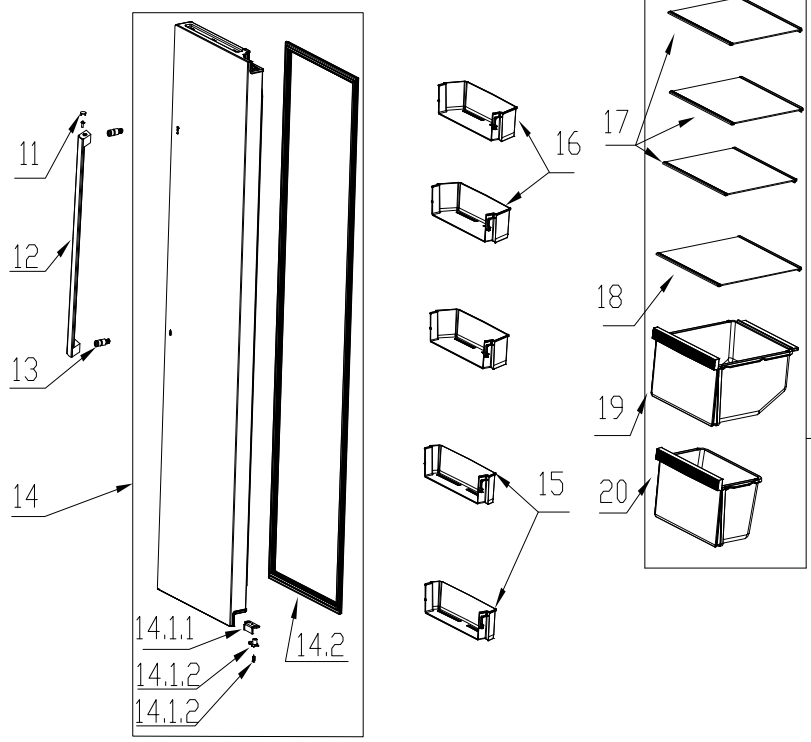
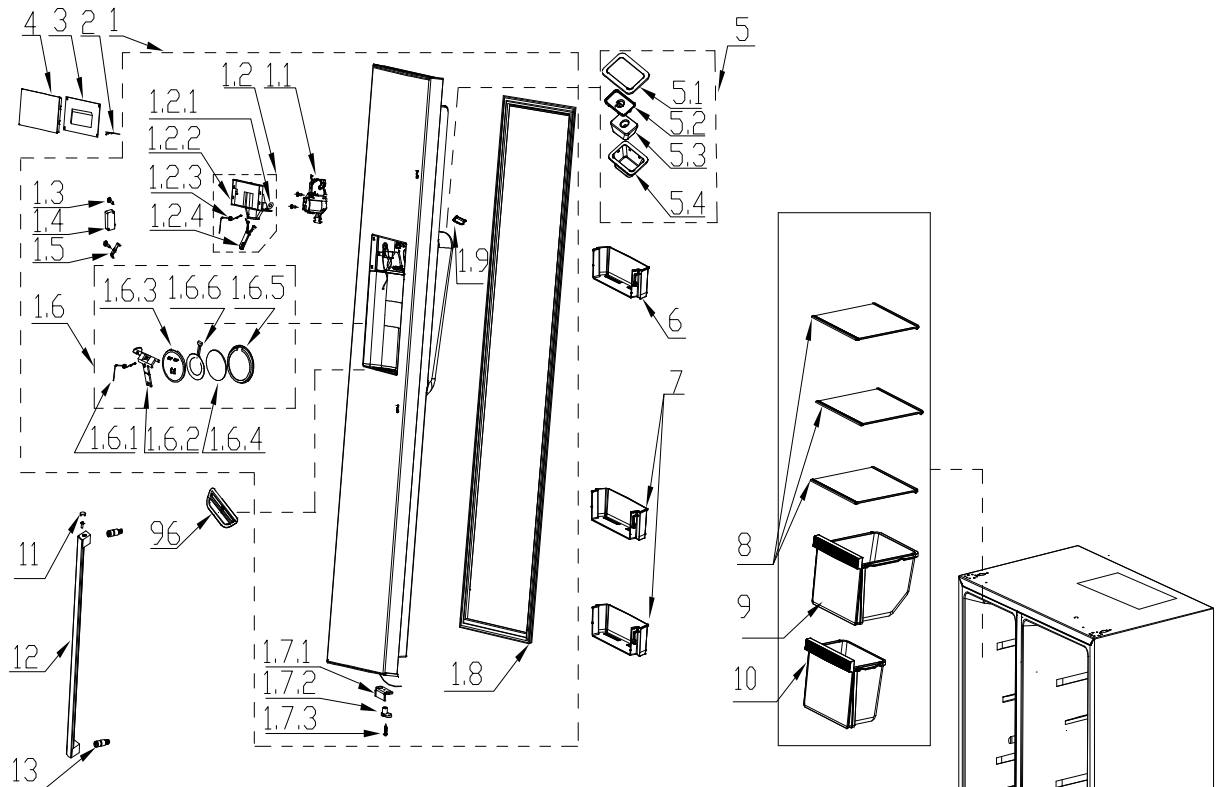

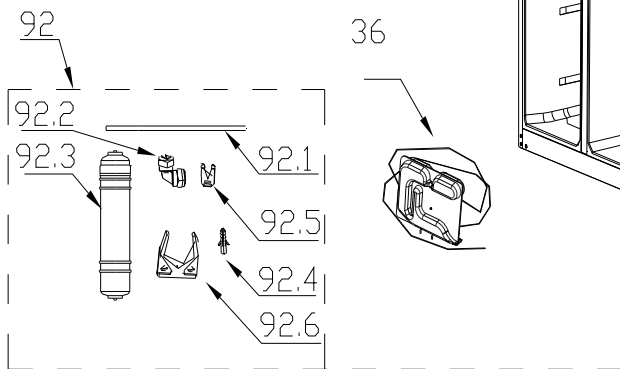
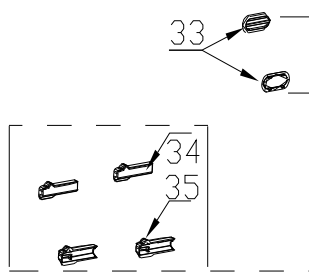
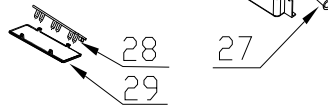
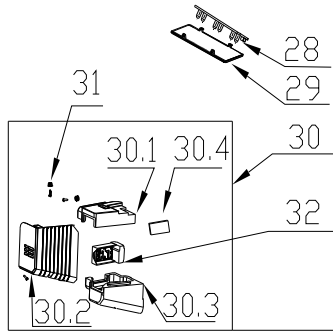
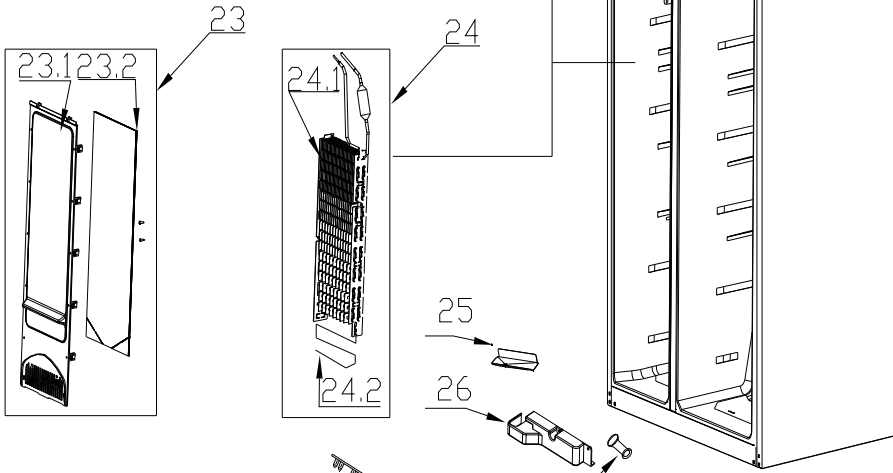
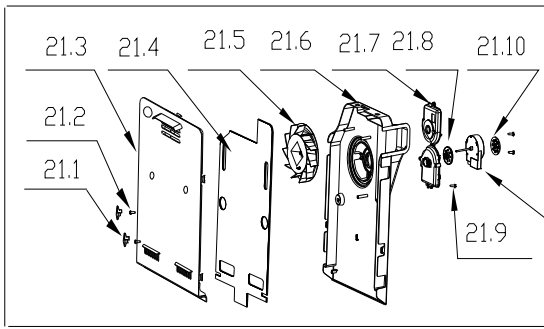

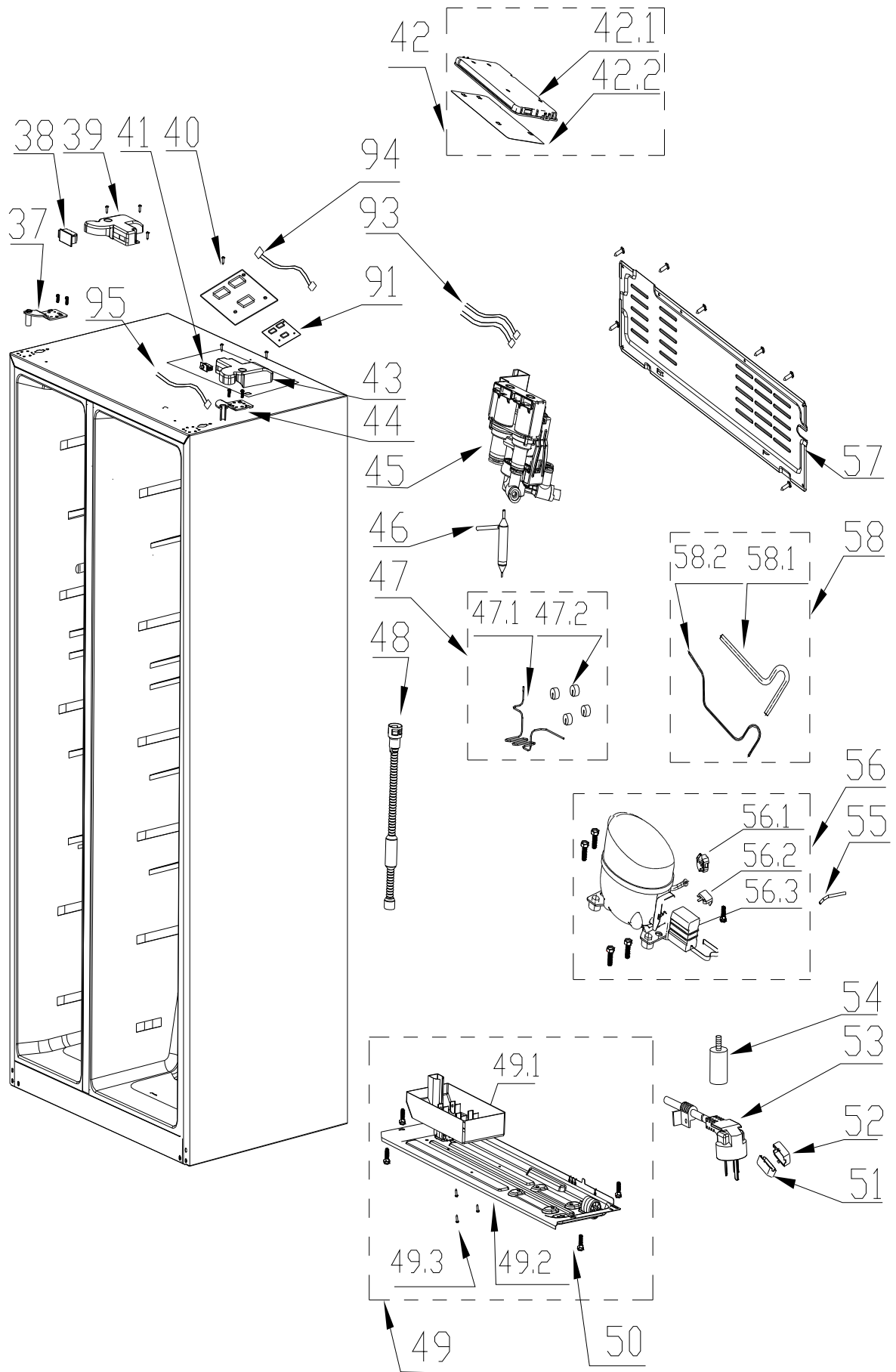

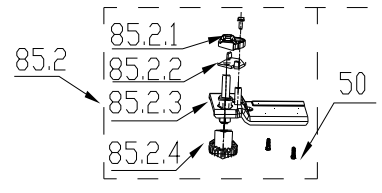
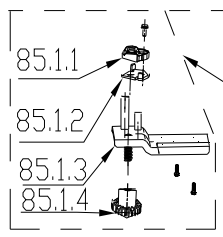
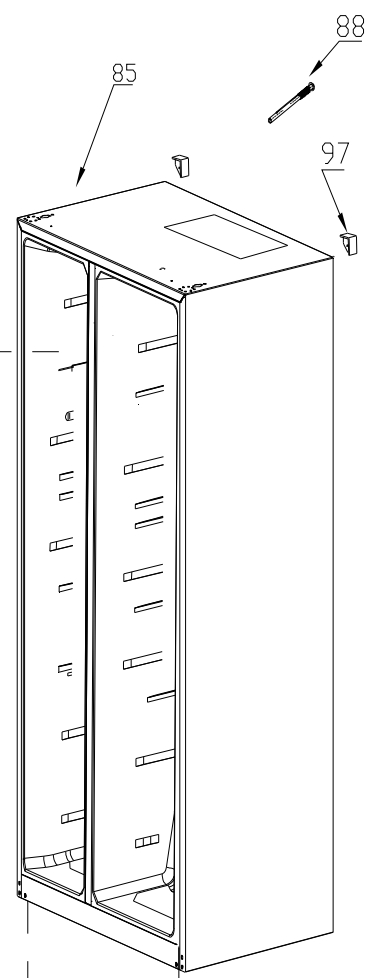
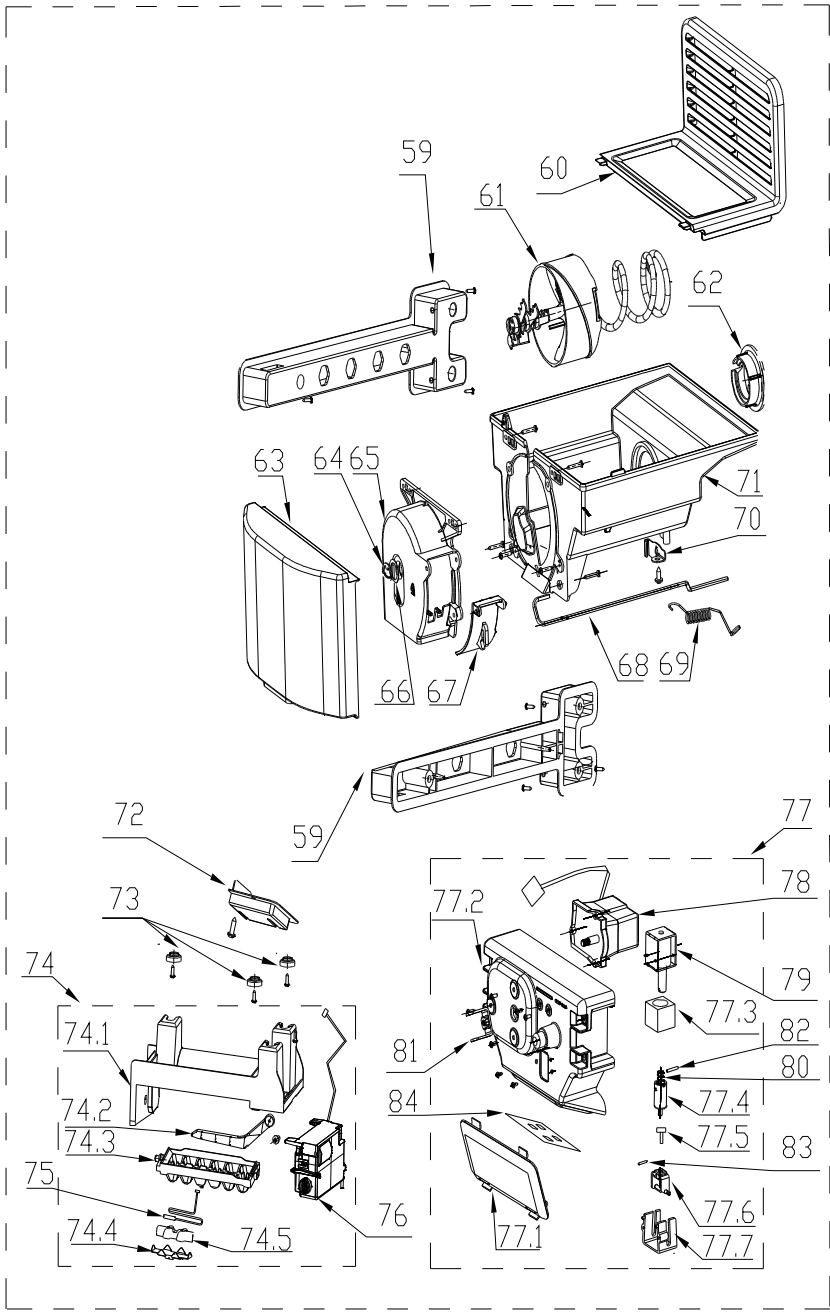

50

No.	Part Name	BOM Code	Remark
1	Freezer door assembly	12831000009724	
1.1	open door motor	17431000000346	
1.2	Cover assembly	12131000029865	
1.2.1	Gasket	12131000015730	Not as service parts
1.2.2	Plastic cover	12131000015245	Not as service parts
1.2.3	Spring	12931000000640	Not as service parts
1.2.4	Distributor block	12131000001295	Not as service parts
1.3	tapping screw	11303120000160	
1.4	Pillar switch	17431000000375	
1.5	Fixing plate	12231000006450	
1.6	Seal plate assembly	12131000029501	
1.6.1	Spring	12931000000643	
1.6.2	Valve tocker	12131000004663	
1.6.3	Fixed blocks	12131000000820	
1.6.4	Sponge block	12431000000256	
1.6.5	Sealed box cover	12631000000267	
1.7	End cap assembly of freezer	12131000013037	Not as service parts
1.7.1	Reinforcement iron bar	12231000006156	
1.7.2	Door self-locking	12131000003250	
1.7.3	tapping screw	11303119000195	
1.8	Door gasket assembly of freezer	12131000009957	
1.9	Decoration component	12131000005627	
2	LED lamp	17431000000228	
3	Display control panel	17131000004721	
4	Display control panel	12131000036684	
5	Sealed case assembly	12131000011278	
5.1	Sealed box cover	12631000000271	
5.2	Seal cover	12131000006076	
5.3	Sealing foam	16331000001064	
5.4	Sealed box	12131000001662	
6	F small tray	12131000006004	
7	F small tray	12131000005683	
8	Freezer glass shelf assembly	12531000002588	
9	F upper drawer assembly	12131000036643	
10	F bottom drawer assembly	12131000036642	

12	Door handle of fridge compartment	12931000000447	
13	bolt	11301803000063	Not as service parts
14	Refrigerator door assembly	12831000005748	
14.1	end cap assembly of refrigerator	12131000009370	Not as service parts
14.1.1	Reinforcement iron bar	12231000006156	
14.1.2	Door self-locking	12131000003250	
14.1.3	tapping screw	11303119000195	
14.2	Door gasket assembly of refrigerator	12131000010479	
15	R small tray	12131000005702	
16	R middle tray	12131000005957	
17	Glass shelf assembly of refrigerator	12531000002587	
18	Glass shelf assembly of refrigerator	12531000002585	
19	Fruits and vegetables box component	12131000036641	
20	Fruits and vegetables box component	12131000036644	
21	Air duct assembly of freezer	12131000017194	
21.1	Seal cover	12131000000539	
21.2	tapping screw	11303125000574	
21.3	Air duct front plate	12131000001421	
21.4	Shape sponge	12431000000593	
21.5	Flabellum	12131000006650	
21.6	Back plate of air duct	12131000001448	
21.7	Fixing clip	12131000000837	
21.8	Damping cushion	12631000000143	
21.9	Damping cushion	12631000000129	
21.10	tapping screw	11303119000193	
22	fan motor	11002015001688	
23	Air duct assembly of freezer	12131000000399	
23.1	Air duct front plate	12131000001461	
23.2	Shape sponge	12431000000544	
24	Component supplying fin evaporator	15831000001041	
24.1	Vertical fin evaporator	15831000000006	
24.2	Defrost heater	17431000005003	
25	Drain tray	12231000010116	
26	Cover plate	12131000001228	
27	Fixing clip	12131000000793	
28	LED lamp	17431000000072	
29	Lamp cover	12131000005489	

30	Air duct components of refrigerator	12131000036701	
30.1	Air duct block	16331000000907	
30.2	Air duct front plate	12131000036524	
30.3	Air duct foaming of refrigerator	16331000000838	
30.4	Sponge seal ring	12431000000424	
32	Electric damper	17431000000895	
33	Box cover	12131000001072	
36	Water tank	12131000007677	
37	Upper hinge	12231000007002	
38	Magnetism control switch	17431000000119	
39	Hinge cover assembly	12131000018244	
40	Main control board	17131000000252	
41	Pillar switch	17431000000375	
42	Main control board mounting box assembly	12131000018245	Not as service parts
42.1	Box cover	12131000018114	Not as service parts
42.2	Reinforcement iron bar	12231000007242	
43	Hinge cover assembly	12131000010140	
44	Upper hinge assembly	12231000007140	
45	Water valve	17431000001483	
46	Dry filter	15531000000125	
47	Component supplying pipe connector	15531000000012	
47.1	Venting Connection tube	15531000000095	Not as service parts
47.2	Rubber block	12631000000244	Not as service parts
48	Drain-pipe	12131000005870	
49	Compressor mounting panel assembly	12231000010143	
49.1	Drain tray	12131000004261	
49.2	Compressor mounting panel assembly	12231000018085	Not as service parts
49.3	tapping screw	11303119000193	
50	tapping locking screw	11303305000045	
51	Mounting box	12131000001661	
52	Mounting box	12131000001672	
53	Power cord	17431000001116	
54	Power filter	17431000000246	
54	Power filter	17431000008661	
55	Processing tubes	15533000000081	
56	DC Inverter Reciprocating Compressor	11101020000522	
57	Compressor back cover	12231000005669	

58	Component supplying pipe connector	15531000000019	
58.1	Suction connection tube	15531000000142	Not as service parts
58.2	Insulating tube	12631000000742	Not as service parts
59	Guide	12131000003792	
60	Box cover	12131000001127	
61	Screw assembly	12931000002481	
62	Gear	12131000004651	
63	Box cover	12131000036523	
64	Fixing plate	12231000006428	
65	Plastic cover	12131000001210	
66	Spacer	12231000006512	
67	Selected ice door	12131000006743	
68	Selected ice rod	12931000000568	
69	Spring	12931000000642	
70	Fixing plate	12231000006534	
71	Ice storage box	12131000000175	
72	Mounting box	12131000017773	
73	Hook	12131000000810	
74	Parts of Ice cube box	12131000000312	
74.1	Support	12131000006451	
74.2	Ice-probing rod	12131000004666	
74.3	Ice box	12131000000178	
74.4	Plastic cover	12131000001161	
74.5	Thermal insulation foam	16331000001082	
75	temperature sensor	11201007000779	
76	motor im	17431000000342	
77	Crushed ice assembly	12131000017245	
77.1	Lamp cover	12131000005461	
77.2	Box cover	12131000001128	
77.3	Sponge block	12431000000284	
77.4	Hook	12131000000733	
77.5	Hook	12131000000732	
77.6	Hook	12131000000815	
77.7	Guide seat	12131000004539	
78	ice output motor	17431000000344	
79	Electromagnet	17431000000905	
80	Spring	12931000000645	

81	Drive lever	12931000000566	
82	Pin	12931000000601	
83	Pin	12931000000597	
84	LED lamp	17431000000146	
85	Cabinet assembly	12831000017101	Not as service parts
85.1	Lower hinge assembly	12231000010013	
85.1.1	Door self-locking	12131000015734	
85.1.2	Door self-locking block	12231000009980	
85.1.3	Lower hinge	12231000010024	Not as service parts
85.1.4	Levelling feet	12131000015856	Not as service parts
85.2	Lower hinge adjust feet assembly	12231000010021	
85.2.1	Door self-locking	12131000015733	
85.2.2	Door self-locking block	12231000009980	
85.2.3	Lower hinge	12231000010019	Not as service parts
85.2.4	Levelling feet	12131000015856	Not as service parts
88	Compensation heater\	17431000001507	
89	Drain-pipe assembly	12131000037462	
90	Drain-pipe	12131000005969	
91	Variable frequency driver board	17131000002002	
92	Filter assembly	12131000030121	
92.1	PP	12163200000388	Not as service parts
92.2		12163200000462	Not as service parts
92.3	filter	15663200001784	Not as service parts
92.4	plastic small parts	12163200000577	Not as service parts
92.5		12163200000492	Not as service parts
92.6	fixing block	12163200000375	Not as service parts
93	Wires	17431000001326	
94	Wires	17431000001017	
95	humidity sensor	11201004000089	
96	Drain tray	12131000012792	Not as service parts
97	Corner protecting cover	12131000000923	Not as service parts
101	drain-pipe connector	12131000006772	
102	drain-pipe	12131000005984	
103	egg tray	12131000006189	
104	Ice box	12131000000178	