

S/M No: FRM5101001

Service Manual

Refrigerator

FR-561K*

FR-640K*

FR-641K*



Factory No. FRM-510**

FRM-511**

✓ **Caution**

: In this Manual, some parts can be changed for improving, their performance without notice in the parts list. So, if you need the latest parts information, please refer to PPL(Parts Price List) in Service Information Center (<http://svc.dwe.co.kr>).

DAEWOO
ELECTRONICS



<http://svc.dwe.co.kr>

- June, 2007

DAEWOO
ELECTRONICS

WARNINGS AND PRECAUTIONS FOR SAFETY

Please observe the following safety precautions in order to use safely and correctly the refrigerator and to prevent accident and danger during repair.

1. Be care of an electric shock. Disconnect power cord from wall outlet and wait for more than three minutes before replacing PCB parts.
Shut off the power whenever replacing and repairing electric components.
2. When connecting power cord, please wait for more than five minutes after power cord was disconnected from the wall outlet.
3. Please check if the power plug is pressed down by the refrigerator against the wall.
If the power plug was damaged, it may cause fire or electric shock.
4. If the wall outlet is over loaded, it may cause fire.
Please use its own individual electrical outlet for the refrigerator.
5. Please make sure the outlet is properly earthed, particularly in wet or damp area.
6. Use standard electrical components when replacing them.
7. Make sure the hook is correctly engaged.
Remove dust and foreign materials from the housing and connecting parts.
8. Do not fray, damage, machine, heavily bend, pull out or twist the power cord.
9. Please check the evidence of moisture intrusion in the electrical components.
Replace the parts or mask it with insulation tapes if moisture intrusion was confirmed.
10. Do not touch the icemaker with hands or tools to confirm the operation of geared motor.
11. Do not let the customers repair, disassemble and reconstruct the refrigerator for themselves.
It may cause accident, electric shock, or fire.
12. Do not store flammable materials such as ether, benzene, alcohol, chemicals, gas, or medicine in the refrigerator.
13. Do not put flower vase, cup, cosmetics, chemicals, etc., or container with full of water on the top of the refrigerator.
14. Do not put glass bottles with full of water into the freezer.
The contents shall freeze and break the glass bottles.
15. When you scrap the refrigerator, please disconnect the door gasket first and scrap it where children are not accessible.

1. SPECIFICATION

Item		Specification		
Model Name		FR-561K*	FR-640K*	FR-641K*
ISO Gross Volume (Li)	Total	507 Li		
	Freezer	144 Li		
	Refrigerator	363 Li		
ISO Storage Volume (Li)	Total	477 Li		
	Freezer	129 Li		
	Refrigerator	348 Li		
Weight		83 kg		
External Dimension (Width x Depth x Height)		770 mm x 762 mm x 1772 mm		

2. Name Of Each Part

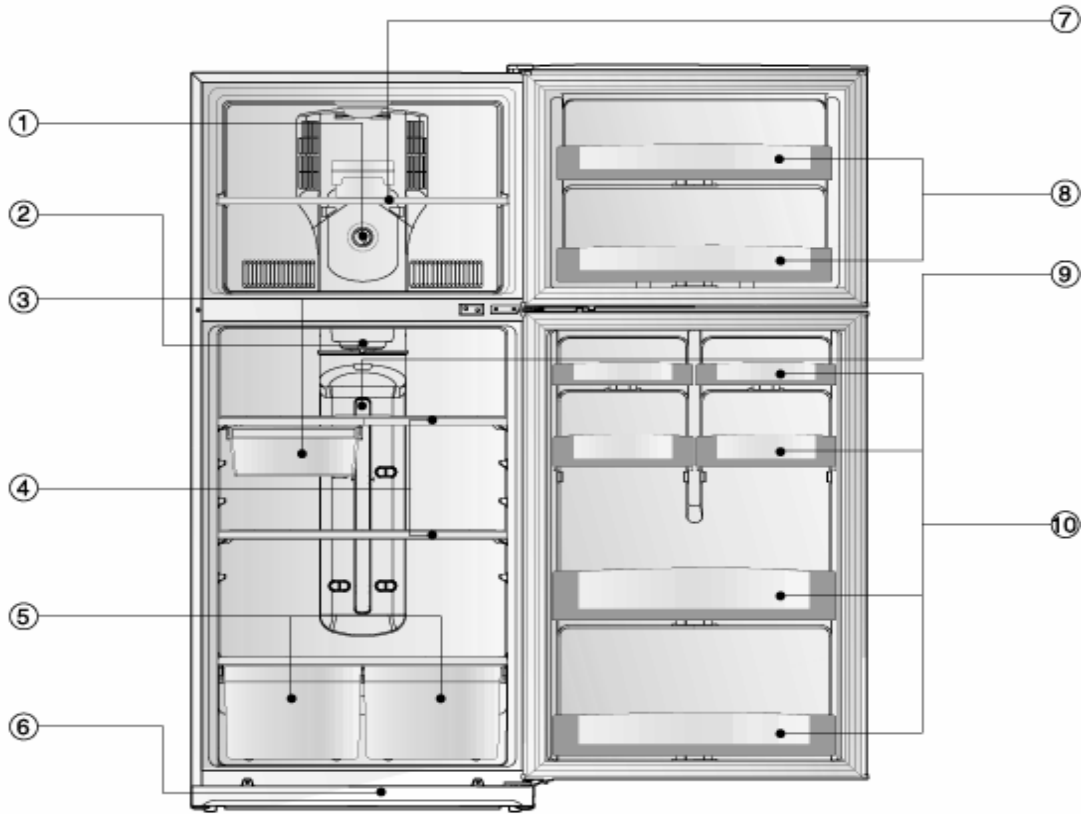

※ Features are model dependent.

1. Freezer Temperature Control	7. Freezer Compartment Shelf
2. Refreshment Temperature Control	8. Freezer Compartment Pocket
3. Fresh Case	9. Shelf Lock Fixture *
4. Fresh Food Compartment Shelves	10. Fresh Food Compartment Pockets
5. High Humidity Vegetable Case	
6. Kick Plate	

* Not all models

3. Cold Air Circulation

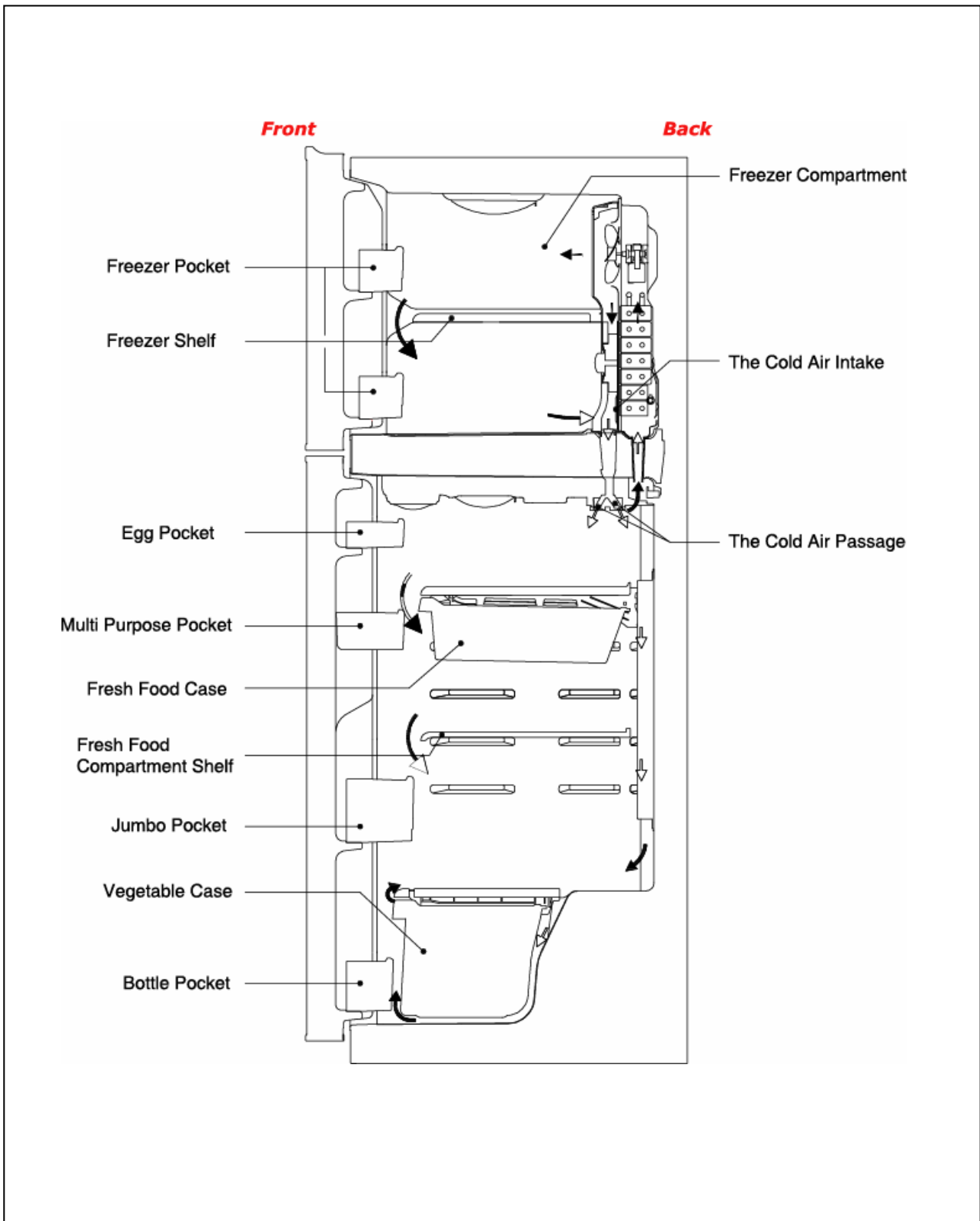



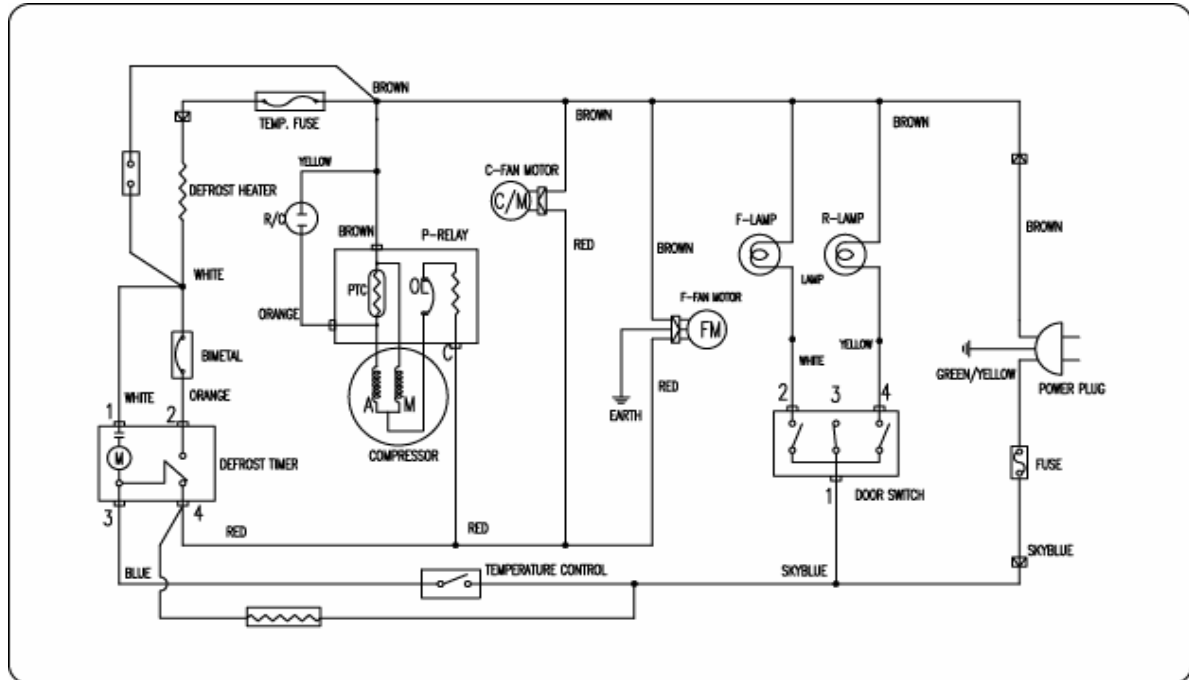

4. Wiring Diagram





5. How To Replace The Parts



5-1. Freezer Louver Part

No	Photos	Description
1		<ul style="list-style-type: none"> - Remove 'Freezer Shelf' at first. - Remove 'Freezer Lamp Window'.
2		<ul style="list-style-type: none"> - Remove 4 screws on 'Freezer Louver'.
3		<ul style="list-style-type: none"> - Pull forward the 'Freezer Louver'. - Then disconnect 'Freezer Motor'.
4		<ul style="list-style-type: none"> - Disassemble the 'Cover Fan F As'. - Be careful not to damage the hook.



5-2. Cover Fan F As

No	Photos	Description
1		- Remove 'Cover Fan B'.
2		- Replace 'Knob F Control'.



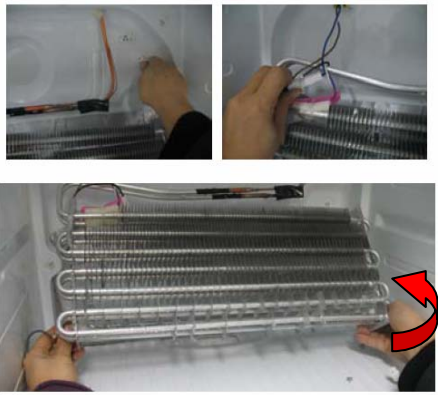

5-3. Freezer Motor As

No	Photos	Description
1		<ul style="list-style-type: none"> - Remove 2 screws. - Remove Clamp Fan with pliers and then disassemble 'Fan' with (-) driver. - Remove lead wire. - Unscrew the earth wire bolt.
2		<ul style="list-style-type: none"> - Remove the screws holding the bracket.
3		<ul style="list-style-type: none"> - Now disassemble the 'Freezer Motor'.

5-4. Evaporator

No	Photos	Description
1		<ul style="list-style-type: none"> - Remove the screw which fixes evaporator.
2		<ul style="list-style-type: none"> - Pull forward the evaporator and pipes. - Be careful not to bend the pipes.
3	<p>Defrost Heater</p> 	<p>< Defrost Heater ></p> <ul style="list-style-type: none"> - Disconnect 'Defrost Heater' lead wire on the right. - Disconnect 'Temperature Fuse' lead wire On the left. - Disassemble the 'Defrost Heater'.

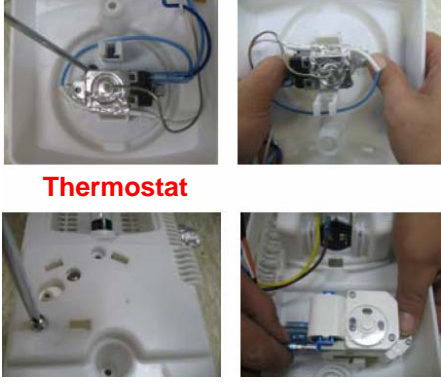
5-5. Control Box

No	Photos	Description
1		<ul style="list-style-type: none"> - Remove the 'Shelf Fixture' to disassemble the shelves and Cover Duct. (Push down the fixture and pull out.)
2		<ul style="list-style-type: none"> - Remove 'Deco M/Flow Duct' with (-) driver. - Pull out the 'Cover M/Flow Duct'.
3		<ul style="list-style-type: none"> - Remove 2 screws on the 'Control Box'. - Disconnect wire to remove the 'Control Box'.
4	 <p style="text-align: center; color: red;">Thermostat</p> <p style="text-align: center; color: red;">Defrost Timer</p>	<p>< Thermostat ></p> <ul style="list-style-type: none"> - Disassemble the 'Thermostat' with (-) driver. - Be careful not to damage the knob. - Disconnect the lead wire. <p>< Defrost Timer ></p> <ul style="list-style-type: none"> - Remove 2 screws which fix the 'Defrost Timer'. - Disconnect the wire and replace.
5		<p>< Deodorizer ></p> <ul style="list-style-type: none"> - Deodorizer locates inside of 'Control Box'. - Pull out the old arrow direction and exchange.

5-6. Handle Installation

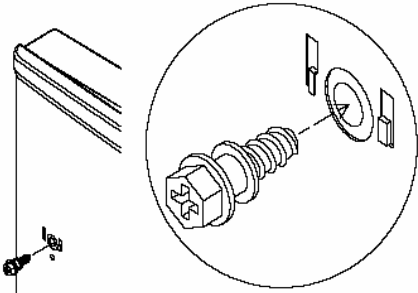
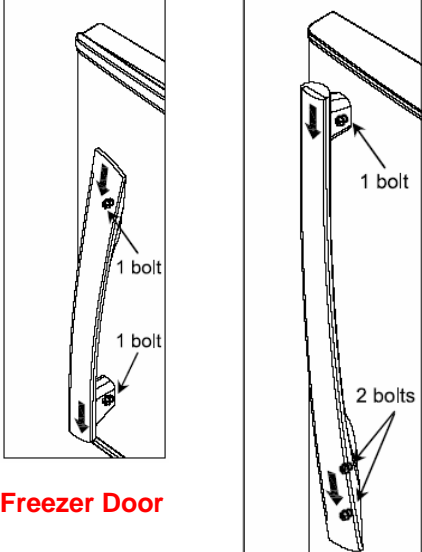
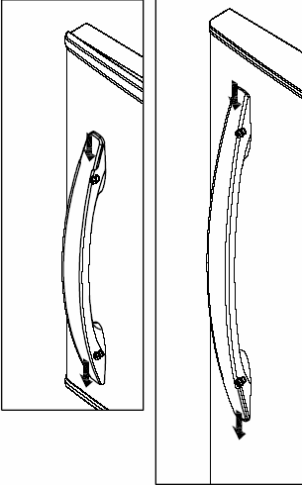
No	Photos	Description
1		<p>- Screw the bolt.</p>
2	 <p style="text-align: center;">Freezer Door</p> <p style="text-align: center;">Refrigerator Door</p>	<p>< FR-640K* / FR-561K* Model > - Assemble and pull down the handle. (Be careful the direction.)</p>
3		<p>< FR-641K* Model ></p>

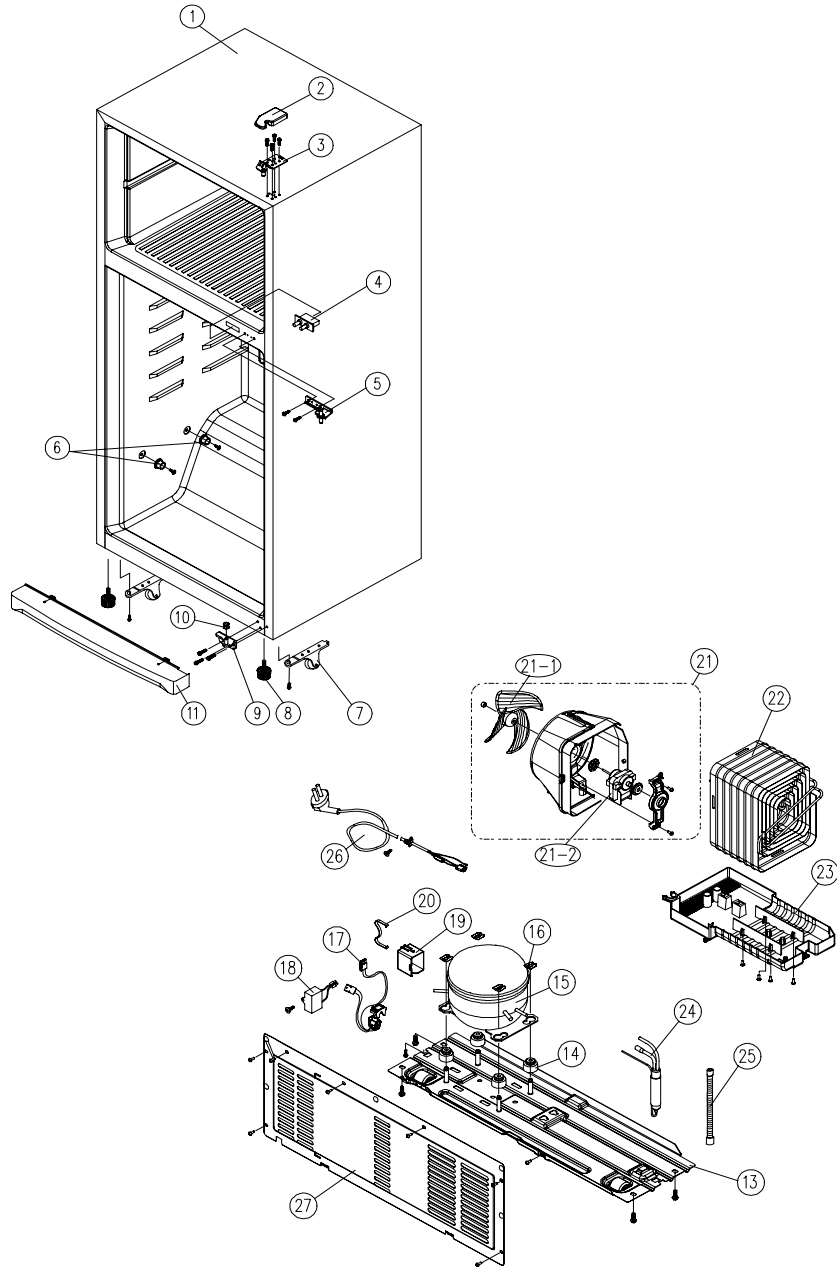

Cabinet Part

NO	PART-CODE	PART NAME	SPEC.	Q'ty	Remark
1	3000066300	ASSY CAB URT	FR-B512FH	1	
2	3001403900	COVER *T HI	PP	1	
3	3012925800	HINGE *T AS	FR-B512FH	1	
4	3018100010	SWITCH DR	2 BUTTON/4P,DSD-5	1	
5	3012925600	HINGE *M AS	FR-B512FH	1	
6	3012517500	GUIDE COVR VEGETB	PP	4	
7	3016502110	CASTER *F AS	FR-B512FH	2	
8	3012105100	FOOT ADJ AS	PP	2	
9	3012906401	HINGE *U AS	FR-B442CB	1	
10	3016007000	SPECIAL WASHER	SBHG T0.6	2	
11	3001404200	COVER CAB BRKT *F	WHITE	1	

Machine Room Part

NO	PART-CODE	PART NAME	SPEC.	Q'ty	Remark
13	3010345200	BASE COMP AS	FR-B512FH	1	
14	3010101600	ABSORBER COMP	NBR	4	
15	3956180F50	COMPRESSOR	DH80LHP5 220V 50HZ	1	DH80LHP5
	3956183D50		MK183Q-L2U 220-240V-50HZ		MK183Q-L2U
16	3016002500	SPECIAL WASHER	SK-5 T0.8	3	
17	3018130610	SWITCH P RELAY AS	FR-640K 197SHBY-52,S330	1	DH80LHP5
	3018130620		FR-640K,265RHB,330		MK183Q-L2U
18	3016401960	CAPACITOR RUN	400VAC 6UF(WIRE)	1	DH80LHP5
	3016401170		350VAC 5UF(EUROPEAN)		MK183Q-L2U
19	3811400503	COVER RELAY	PP(SW5101SW) 40*54*45*T2.0	1	DH80LHP5
	3811402100		DS3-3NORYL S/S		MK183Q-L2U
20	3012610000	CLAMP BAND RELAY	SK-5 0.7T	1	DH80LHP5
21	3018410110	MOUTHBELL AS	FR-640K(AC230V/50HZ)	1	
21-1	3011834700	FAN	ABS OD3.17XD150	1	
21-2	3015918000	MOTOR C FAN	AC230/50HZ DA1-6122DETCC	1	
22	3014467200	PIPE WICON AS	FR-B512FH	1	
23	3011190900	CASE VAPORI AS	FR-B512FH	1	
24	3016808100	DRYER AS	C1220T-M OD19.05XL135	1	
25	3013202700	HOSE DRN B	PP	1	
26	3011348410	CORD POWER AS	FRM-510, 250V/16A	1	
27	3012407000	GRILLE AS	GRILL+SEAL	1	

- Some parts can be changed for improving their performance without notice.
- Above parts number doesn't describe your own colour & printing.

Date	Amendment Note

Freezer Compartment

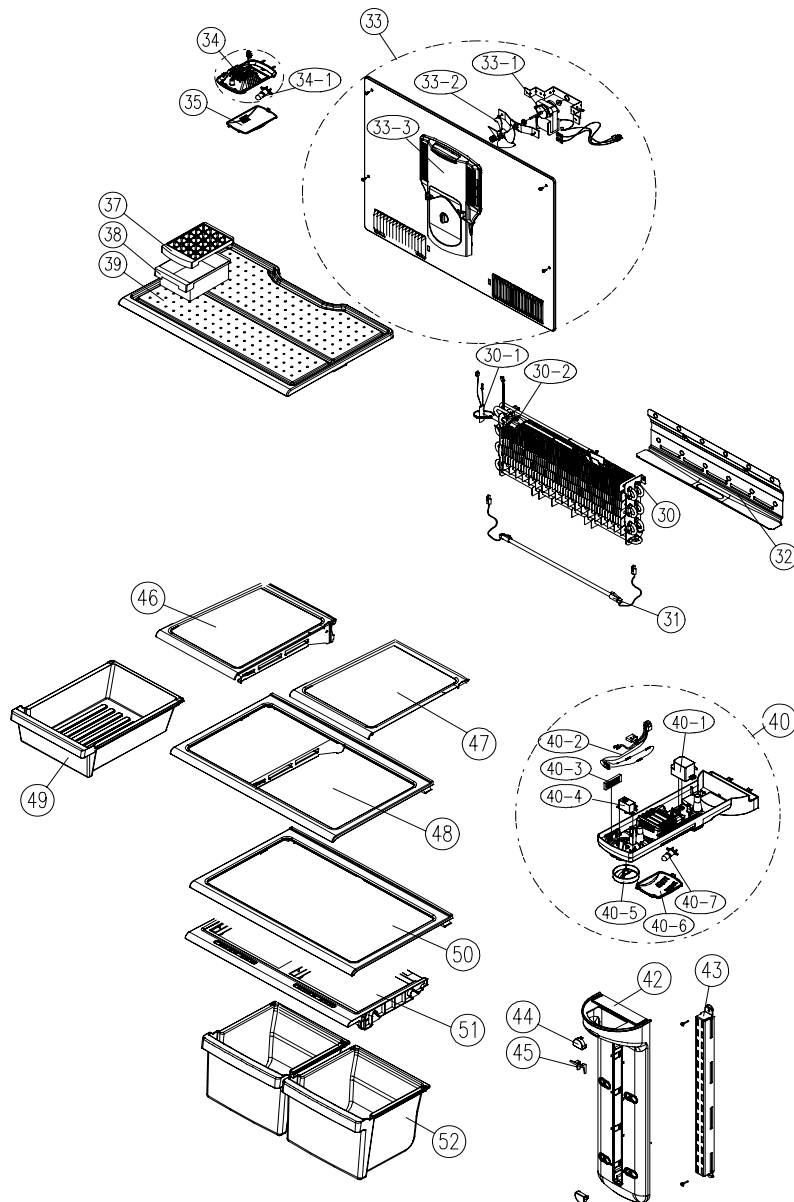

NO	PART-CODE	PART NAME	SPEC.	FR-561K* FR-640K*	FR-641K*
30	3017063400	EVA AS	.	1	1
30-1	3017202700	FUSE TEMP AS	FR-B512FH	1	1
30-2	3018130700	SWITCH BIMTL AS	PCC	1	1
31	3012821900	HEATER D AS	230V 395W	1	1
32	3012530800	GUIDE DRN	GL T0.4X550X240	1	1
33	3018923400	LOUVER F AS	FRM-510(230V/50HZ ECM)	1	1
	3018922810		FRM-510(230V/50HZ)		
33-1	3015918300	MOTOR F FAN AS	FRM-510	1	1
	3015917410		AC 230V/50HZ(FRM-510)		
33-2	3011802700	FAN AS	FAN(OD110)+CLAMP	1	1
33-3	3001410500	COVER F FAN AS	FR-B512FH	1	1
34	3010551700	BOX F LAMP AS	FR-B512FH	1	
34-1	3013600020	LAMP AS	240V/15W (E14,CC7A)	1	1
35	3015511600	WINDOW F LAMP	PP	1	1
37	4010G56012	CASE ICING	PP(J-360)	1	1
38	4017Z99112	CASE ICE	HC-2	1	1
39	3956183D50	SHELF F	HIPS	1	1

3018130610

Refrigerator Compartment

NO	PART-CODE	PART NAME	SPEC.	FR-561K* FR-640K*	FR-641K*
40	3010551500	BOX CONTL MULTI AS	HIPS	1	1
40-1	3018120001	SWITCH DEF TIMER	12HR	1	1
40-2	3012758600	HARNESS BOX CONTL AS	FR-B512FH	1	1
40-3	3018702000	DEO ANTI AS	FR-B512FH	1	1
40-4	3018305600	THERMOSTAT	FR-B512FH, GNF-175D-02F	1	1
40-5	3013412700	KNOB R DIAL	HIPS(BLUE)+SILK PRINT	1	1
40-6	3015511500	WINDOW R LAMP	PP	1	1
40-7	3017907700	SOCKET R LAMP AS	240V, 15W	1	1
42	3001403400	COVER M/F DUCT AS	COVER+INSU AS	1	1
43	3015310800	SUPPORTER SHELF R *M	SECC(EGI)+PAINT	1	x
	3015310900		SUPPORTER M/FLOW DUCT	SECC(EGI)+PAINT	x
44	3011641200	DECO M/FLOW DUCT	HIPS, BLUE	2	x
45	3015204800	STOPPER SHELF SM	HIPS	1	x
46	3017844700	SHELF CHILD CASE SM AS	FR-B512FH	1	x
47	3017845000	SHELF SM *R AS	FR-B512FH	1	x
48	3017846300	SHELF CHILD CASE INJEC AS	FR-B512FM/L	x	1
49	3011190600	CASE CHILD	GPPS + SILK PRINT	1	1
50	3017846900	SHELF INJECT AS	FR-B512FH	1	1
51	3001404000	COVER V/CASE AS	FR-B512FH	1	1
52	3011190700	CASE VEGETB	GPPS + SILK PRINT	2	2

Freezer Door

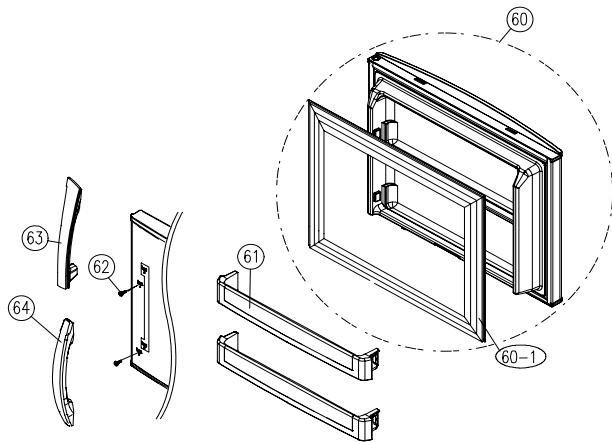

NO	PART-CODE	PART NAME	SPEC.	FR-561K* FR-640K*	FR-641K*
60	3000066500	ASSY F DR TOTAL	FRM-510(WHITE EMBO)	1	x
	3000066510		FRM-510(O3 SILVER)		
	3000066520		FRM-510(VCM)		
	3000067200		FRM-511(WHITE EMBO)	x	1
	3000067210		FRM-511(O3 SILVER)		
3000067220	FRM-511(VCM)				
60-1	3012320200	GASKET F DR AS	PVC, GRAY	1	1
61	3019029200	POCKET F DR	HIPS	2	2
62	3016042700	SPECIAL BOLT HNDL A	M6	2	2
63	3012644210	HANDLE F AS	FR-B512FH	1	x
64	3012644610		FR-B512FM/L	x	1

Refrigerator Door

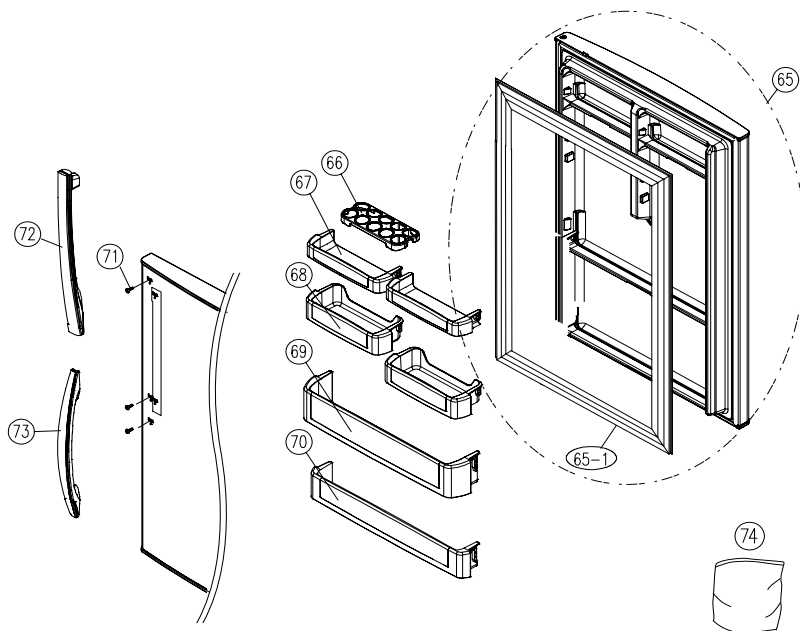

NO	PART-CODE	PART NAME	SPEC.	FR-561K* FR-640K*	FR-641K*
65	3000066700	ASSY R DR TOTAL	FRM-510(WHITE EMBO)	1	x
	3018130610		FRM-510K(WHITE EMBO)		
	3000066720		FRM-510(O3 SILVER)		
	3000066730		FRM-510K(O3 SILVER)		
	3000066740		FRM-510(VCM)		
	3000066750		FRM-510K(VCM)		
	3000067400		FRM-511(WHITE EMBO)	x	1
	3000067410		FRM-511K(WHITE EMBO)		
	3000067420		FRM-511(O3 SILVER)		
	3000067430		FRM-511K(O3 SILVER)		
	3000067440		FRM-511(VCM)		
3000067450	FRM-511K(VCM)				
65-1	3012320300	GASKET R DR AS	PVC, GRAY	1	1
66	3011190800	CASE EGG TRAY	GPPS	1	1
67	3019029300	POCKET EGG	HIPS	2	2
68	3019029400	POCKET UTILITY	HIPS	2	2
69	3019029600	POCKET JUMBO	HIPS	1	1
70	3019029500	POCKET BOTL	HIPS	1	1
71	3016042700	SPECIAL BOLT HNDL A	M6	3	2
72	3012644410	HANDLE R AS	FR-B512FH	1	x
73	3012644710		FR-B512FM/L	x	1
74	3012648300	HANDLE A AS	FRM-510	1	x
	3012648400	HANDLE B AS	FRM-511	x	1