

matr.40801.0001

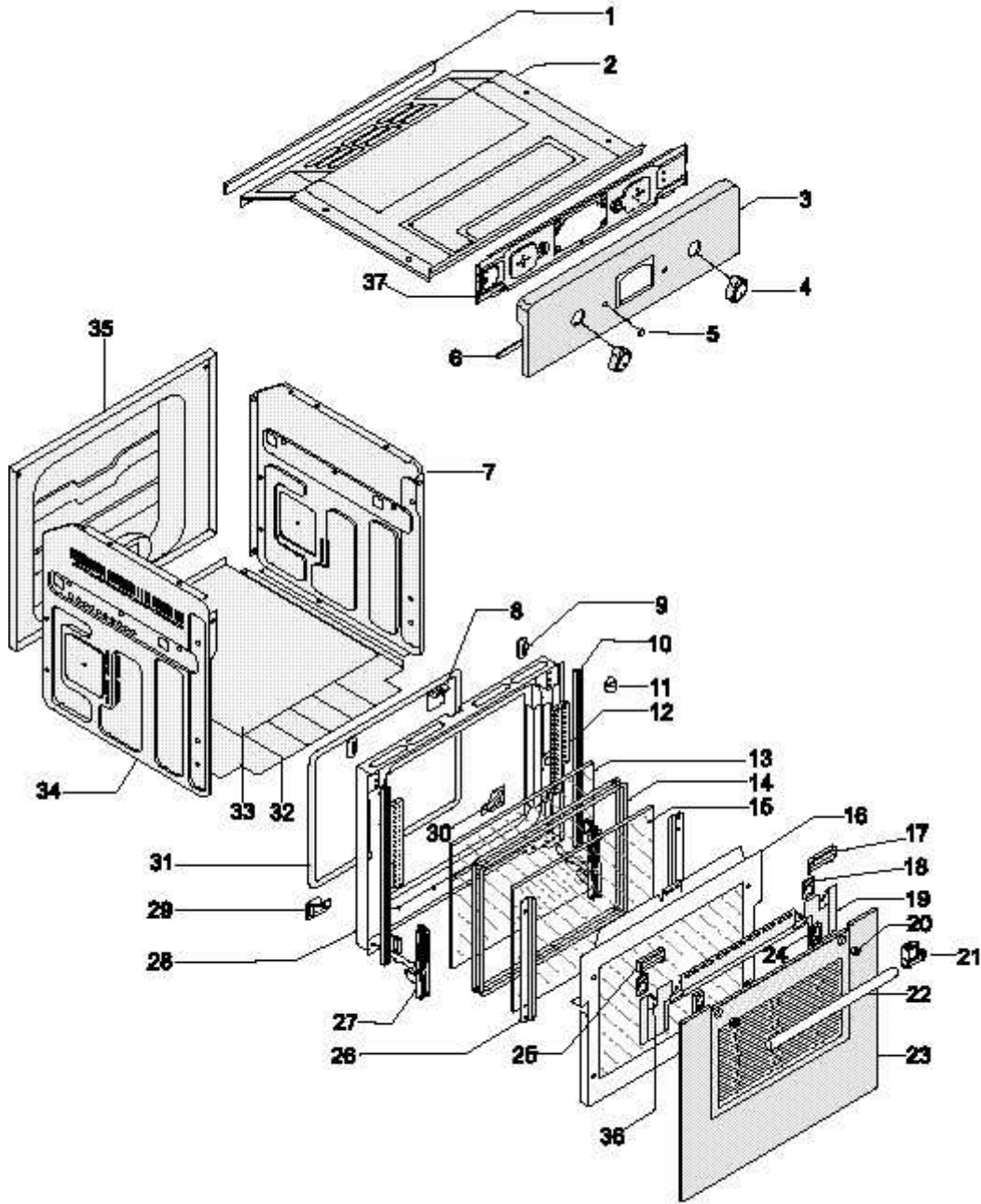

4310170