

<b>PNC</b>	<b>ELC</b>	<b>Marque</b>	<b>Modèle</b>	<b>Marché</b>
942640502	00	ArthurMartinElux	AFC6000W	FR

Ventilateurs de cuisine

**Electrolux Italia S.p.A.**  
**Corso Lino Zanussi 30**  
**I - 33080 Porcia**  
**Italy**  
Fax +39 (0)434 394096

**No. de publication**  
**599364921**  
**2008/01/17**  
9BX

122

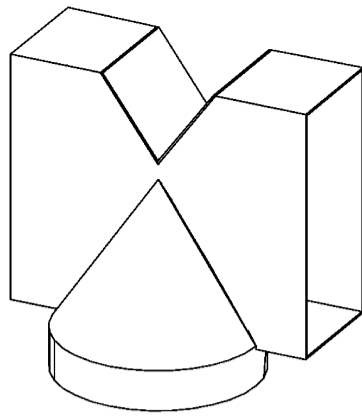

120

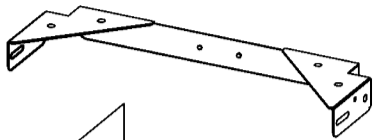

119

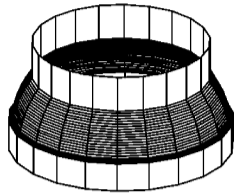
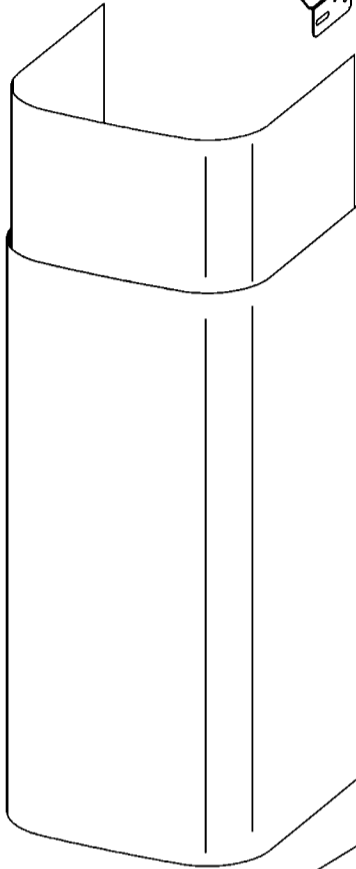

58

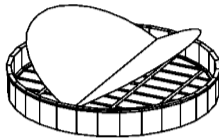

86

118

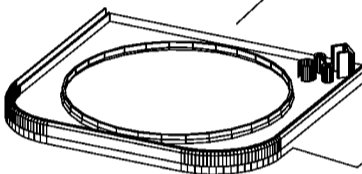

477

478

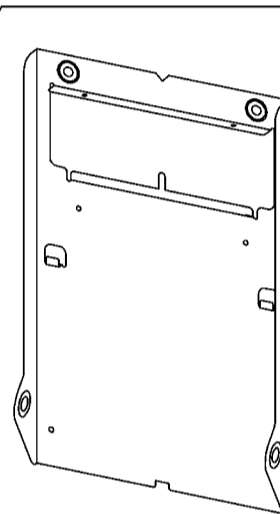

407

195

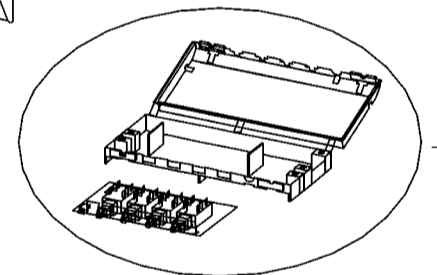
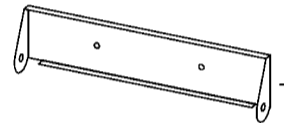

38

229

223



112

49

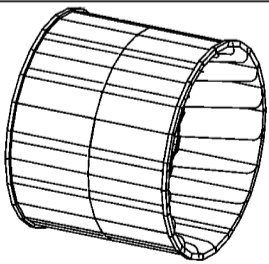

48

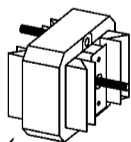

45

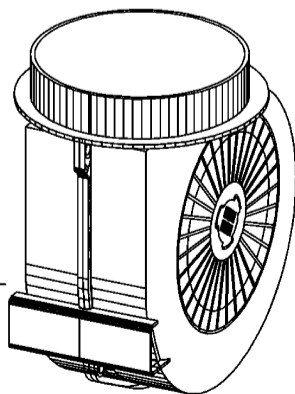

26

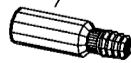

28

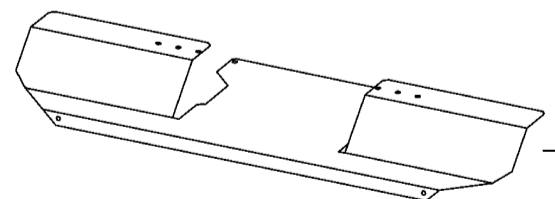

16

24

25

23

29

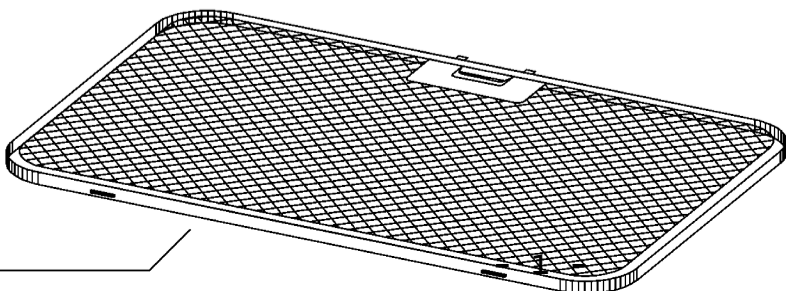

Matrice	PNC	ELC	Date Prod.	Modèle
A	942640502	00	20040614	AFC6000W

Pos.	Réf.	Matrice	Description
9	50253939008	A	Filtre à graisse,239x298,5
16	50262425007	A	Support,boîte,rampe
23	50240140009	A	Support,support de lampe
24	50240141007	A	Support,inférieur,support de lampe
25	50232636006	A	Fermeture,support de lampe
26	50232652003	A	Lampe
28	50214777000	A	Support de lampe
29	50267402001	A	Support diffuseur de lumière
38	50278284000	A	Platine de commandes,complet
45	50253885003	A	Convoyeur
48	50262492007	A	Moteur principal,rotation sens SAM
49	50253887009	A	Hélice,rotation sens SAM
58	50253902006	A	Réducteur
86	50253899004	A	Bride
112	50240087002	A	Chape
118	50253950005	A	Cheminée,inférieur
119	50253951003	A	Cheminée,supérieur
120	50253913003	A	Support,supérieur,cheminée télescopique
122	50253912005	A	Défecteur
195	50253909001	A	Support
223	50262426005	A	Touche
229	50233959001	A	Voyant
407	50253893007	A	Étrier de support,convoyeur
477	50253946003	A	Fermeture
478	50279516004	A	Cloison
999	50254332005	A	Filtre charbon,CA200R D.190 2pz.
999	50269301003	A	Assemblage,sac,accessoires
999	50279928001	A	Sachet documents,avec,mode d'emploi

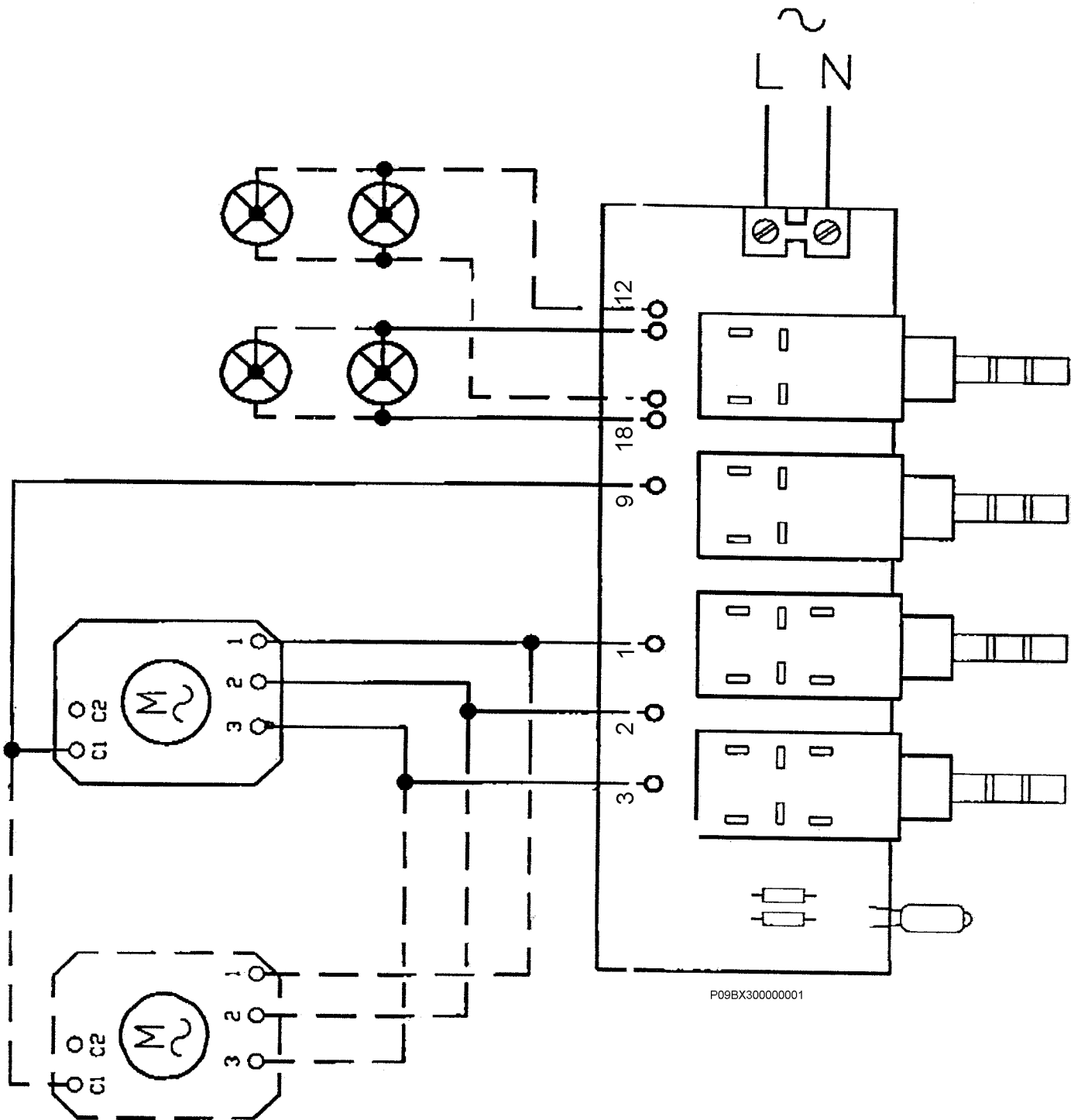

P09BX300000001