

Matr. 00630.0003

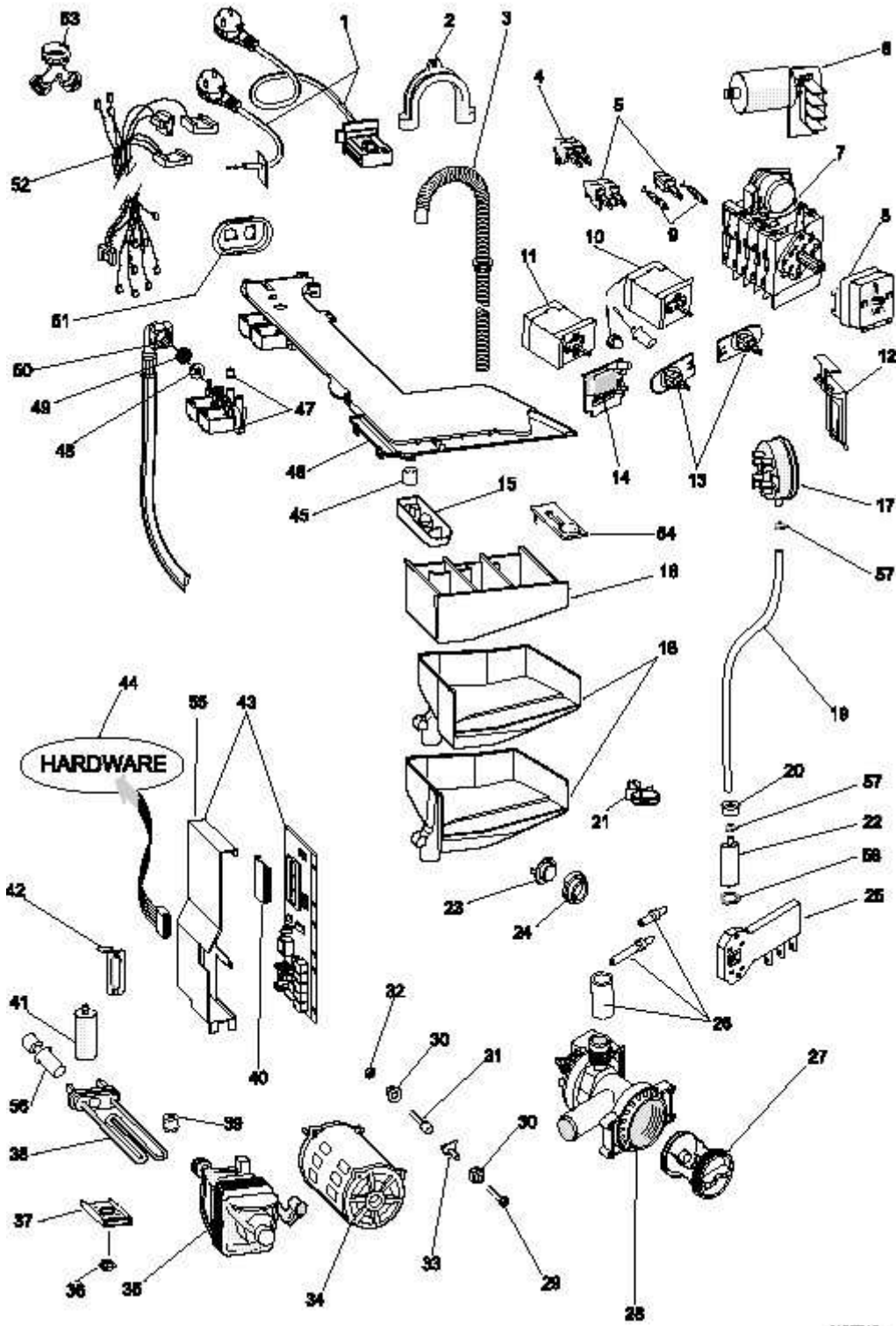

1160010