

# 13 Exploded View and Replacement Parts List

## 13.1. Exploded View and Mechanical Replacement Parts List

### 13.1.1. Exploded View

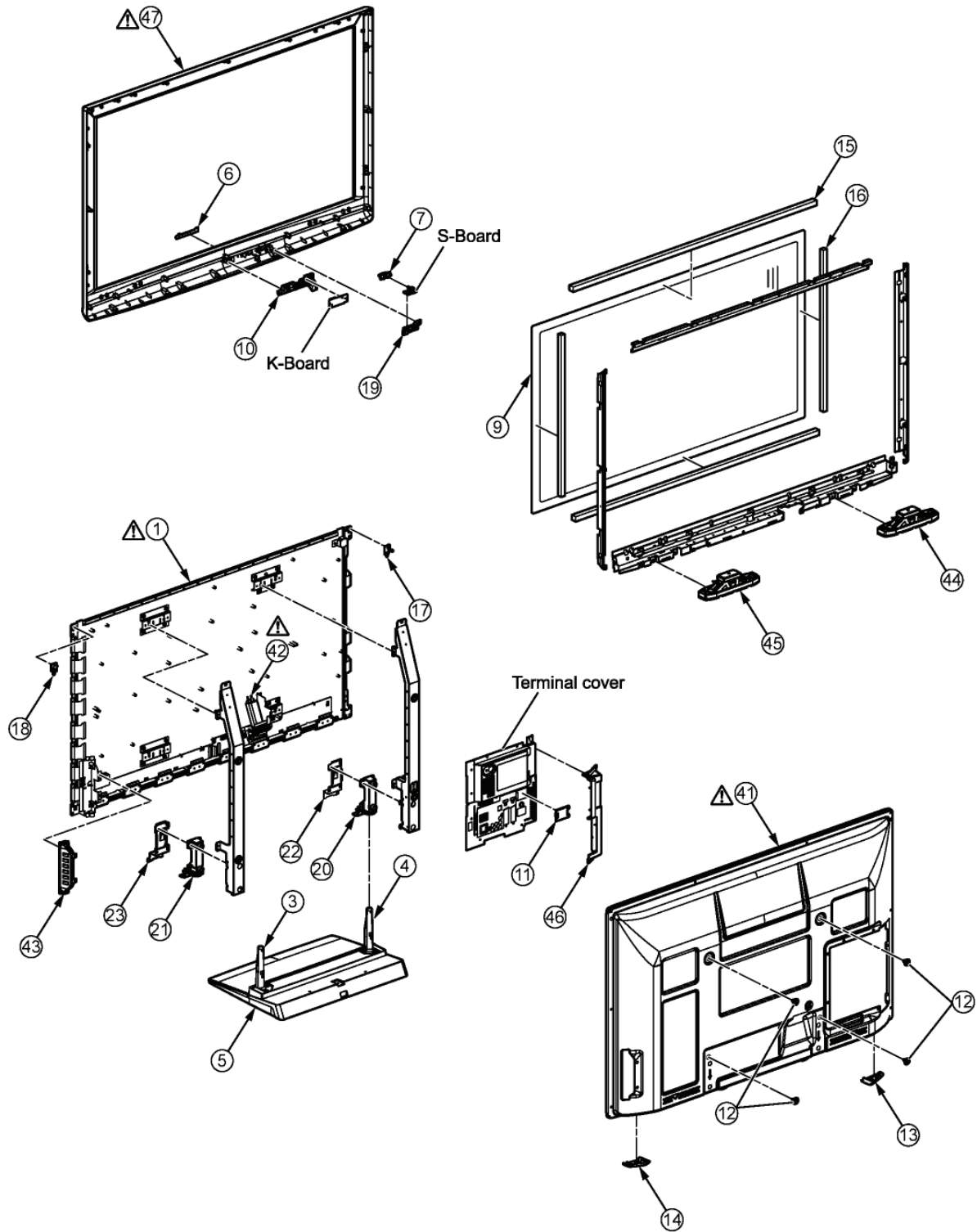

### 13.1.2. Packing 1

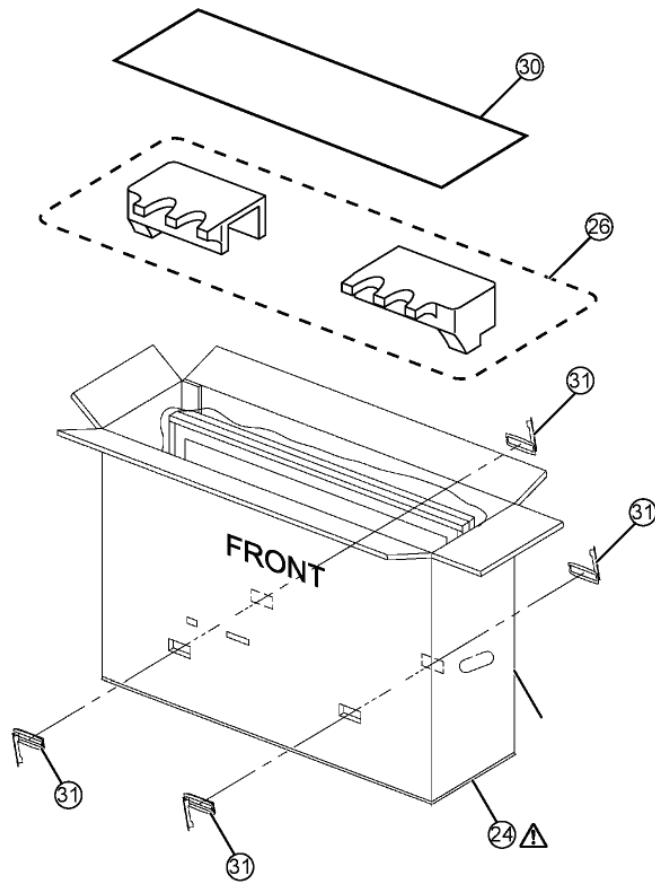



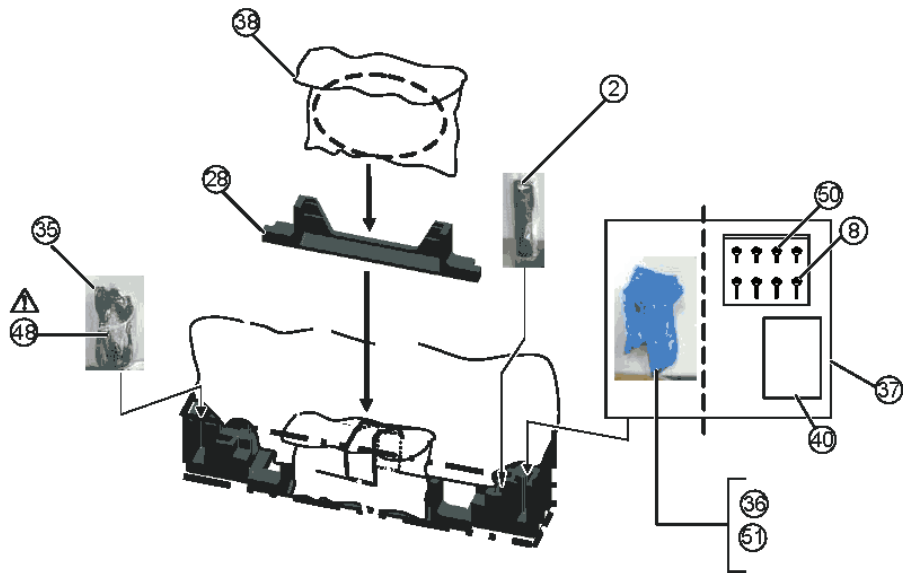
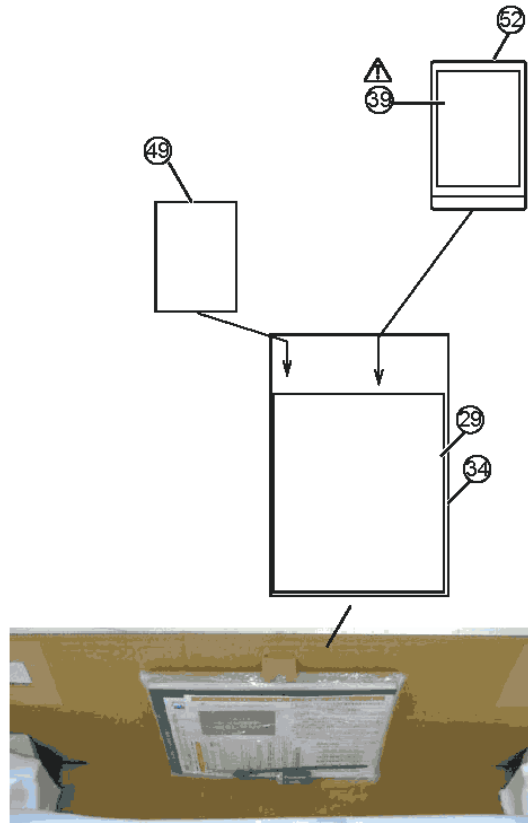
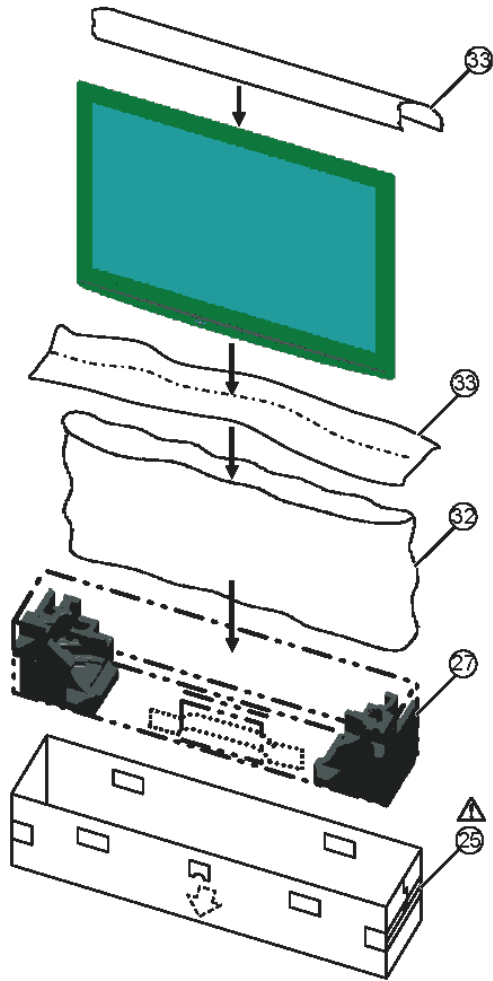

























### 13.1.3. Packing 2







#### 13.1.4. Mechanical Replacement Parts List

**Note:** All parts except parts mentioned [PAVCCZ] in the Remarks column are supplied by AVC-CSPC.  
Parts mentioned [PAVCCZ] are supplied by PAVCCZ.

| Safety  | Ref. No. | Part No.     | Part Name & Description | Q'ty | Remarks |
|---|----------|--------------|-------------------------|------|---------|
|    | 1        | MD50H12A2J   | PLASMA DISPLAY PANEL    | 1    | PAVCCZ  |
|   | 2        | N2QAYB000328 | REMOTE CONTROL          | 1    | PAVCCZ  |
|   | 3        | TBLA3685     | STAND POLE R            | 1    | PAVCCZ  |
|   | 4        | TBLA3686     | STAND POLE L            | 1    | PAVCCZ  |
|   | 5        | TBLX0097     | PEDESTAL STAND          | 1    | PAVCCZ  |
|   | 6        | TBMA282      | PANASONIC BADGE         | 1    |         |
|   | 7        | TBX3EA00101  | POWER BUTTON            | 1    | PAVCCZ  |
|   |          | THEC128N     | SLIM SCREW(M4X6)        | 2    | PAVCCZ  |
|   |          | THEJ016J     | SCREW(AC INRET:2)       | 2    |         |
|   |          | THEL0429     | SCREW                   | 11   |         |
|   |          | THEL052Z     | SCREW (BC TOP:4)        | 2    |         |
|   | 8        | THEL061N     | SCREW                   | 4    |         |
|   |          | THEL069J     | SCREW                   | 64   | PAVCCZ  |
|   |          | THTD020J     | SCREW(A-PRINT:4)        | 4    |         |
|   |          | THTF013J     | SCREW                   | 2    |         |
|   | 9        | TKGA5542     | FRONT GLASS             | 1    | PAVCCZ  |
|   | 10       | TKK3EC5001   | LED PANEL               | 1    | PAVCCZ  |
|   | 11       | TKK3EL5001   | ADJUSTMENT COVER        | 1    | PAVCCZ  |
|   | 12       | TKKL5472     | M8 CAP                  | 4    |         |
|   | 13       | TKR0E1901    | REAR COVER HANDLE L     | 1    | PAVCCZ  |
|   | 14       | TKR0E2001    | REAR COVER HANDLE R     | 1    | PAVCCZ  |
|   | 15       | TMK0EG016    | SPONGE (UPPER/BOTTOM)   | 2    | PAVCCZ  |
|   | 16       | TMK0EG017    | SPONGE (LEFT/RIGHT)     | 2    | PAVCCZ  |
|   |          | TMM23417     | CLAMPER                 | 2    |         |
|   | 17       | TMMD014-1    | REAR COVER HOOK L       | 1    | PAVCCZ  |
|   | 18       | TMMD015-1    | REAR COVER HOOK R       | 1    | PAVCCZ  |
|   |          | TMME061      | CLAMPER                 | 1    |         |
|   |          | TMME224      | CLAMPER                 | 5    |         |
|   |          | TMME287      | CLAMPER                 | 2    |         |
|   |          | TMME292      | CLAMPER                 | 2    |         |
|   |          | TMME331      | CLAMPER                 | 1    |         |
|   |          | TMME332      | CLAMPER                 | 6    |         |
|   |          | TMME341      | CLAMPER                 | 1    |         |
|   |          | TMME345      | SPACER                  | 1    |         |
|   | 19       | TMW3EC001    | POWER BUTTON BRACKET    | 1    | PAVCCZ  |
|   |          | TMXX055      | AC CORD CLAMPER         | 2    |         |
|  |          | TMXX062      | AC CORD HOLDER          | 1    | PAVCCZ  |
|   | 20       | TMZX5162     | STAND BRACKET L         | 1    |         |
|   | 21       | TMZX5163     | STAND BRACKET R         | 1    |         |
|   | 22       | TMZX5167     | STAND BRACKET METAL L   | 1    |         |
|   | 23       | TMZX5168     | STAND BRACKET METAL R   | 1    |         |
|  | 24       | TPC0E53800   | CARTON BOX TOP          | 1    | PAVCCZ  |
|  | 25       | TPC0E53900   | CARTON BOX BOTTOM       | 1    | PAVCCZ  |

| Safety  | Ref. No. | Part No.   | Part Name & Description       | Q'ty | Remarks  |
|---|----------|------------|-------------------------------|------|----------|
|   | 26       | TPD0E1079  | TOP CUSHION                   | 1    | PAVCCZ   |
|   | 27       | TPD0E2063  | BOTTOM CUSHION                | 1    | PAVCCZ   |
|   | 28       | TPD0E2064  | PEDESTAL CUSHION              | 1    | PAVCCZ   |
|   | 29       | TPD0E9137  | ACCESSORIES PAD               | 1    | PAVCCZ   |
|   | 30       | TPD0E9159  | TOP PAD                       | 1    | PAVCCZ   |
|   | 31       | TPD169487  | JOINT                         | 4    |          |
|   | 32       | TPE0E4010  | PROTECT COVER                 | 1    | PAVCCZ   |
|   | 33       | TPE0E4041  | PROTECT SHEET                 | 2    | PAVCCZ   |
|   | 34       | TPE0E9002  | ACCESSORIES BAG               | 1    | PAVCCZ   |
|   | 35       | TPE0E9003  | BAG FOR AC CORD               | 1    | PAVCCZ   |
|   | 36       | TPEB336    | BAG (STAND POLE R)            | 1    |          |
|   | 37       | TPEB338    | BAG (STAND ACCESSORY)         | 1    | PAVCCZ   |
|   | 38       | TPEB368    | BAG (PEDESTAL STAND)          | 1    | PAVCCZ   |
|   |          | TPG0E9320  | PAPER CAP                     | 0.25 | PAVCCZ   |
|    | 39       | TQB0E0794A | INSTRUCTION BOOK (GERMAN)     | 1    | PAVCCZ Y |
|    | 39       | TQB0E0794B | INSTRUCTION BOOK (DUTCH)      | 1    | PAVCCZ Y |
|    | 39       | TQB0E0794C | INSTRUCTION BOOK (ITALIAN)    | 1    | PAVCCZ Y |
|    | 39       | TQB0E0794D | INSTRUCTION BOOK (FRENCH)     | 1    | PAVCCZ Y |
|    | 39       | TQB0E0794E | INSTRUCTION BOOK (SPANISH)    | 1    | PAVCCZ Y |
|    | 39       | TQB0E0794F | INSTRUCTION BOOK (SWEDISH)    | 1    | PAVCCZ Y |
|    | 39       | TQB0E0794G | INSTRUCTION BOOK (NORWEGIAN)  | 1    | PAVCCZ Y |
|   | 39       | TQB0E0794H | INSTRUCTION BOOK (FINNISH)    | 1    | PAVCCZ Y |
|  | 39       | TQB0E0794I | INSTRUCTION BOOK (LITHUANIAN) | 1    | PAVCCZ Y |
|  | 39       | TQB0E0794J | INSTRUCTION BOOK (PORTUGUESE) | 1    | PAVCCZ Y |
|  | 39       | TQB0E0794K | INSTRUCTION BOOK (DANISH)     | 1    | PAVCCZ Y |
|  | 39       | TQB0E0794M | INSTRUCTION BOOK (BULGARIAN)  | 1    | PAVCCZ Y |
|  | 39       | TQB0E0794N | INSTRUCTION BOOK (ROMANIAN)   | 1    | PAVCCZ Y |
|  | 39       | TQB0E0794O | INSTRUCTION BOOK (LATVIAN)    | 1    | PAVCCZ Y |
|  | 39       | TQB0E0794P | INSTRUCTION BOOK (POLISH)     | 1    | PAVCCZ Y |
|  | 39       | TQB0E0794Q | INSTRUCTION BOOK (HUNGARIAN)  | 1    | PAVCCZ Y |
|  | 39       | TQB0E0794R | INSTRUCTION BOOK (CZECH)      | 1    | PAVCCZ Y |
|  | 39       | TQB0E0794S | INSTRUCTION BOOK (GREEK)      | 1    | PAVCCZ Y |
|  | 39       | TQB0E0794T | INSTRUCTION BOOK (TURKISH)    | 1    | PAVCCZ Y |
|  | 39       | TQB0E0794U | INSTRUCTION BOOK (ENGLISH)    | 1    | PAVCCZ Y |
|  | 39       | TQB0E0794V | INSTRUCTION BOOK (CROATIAN)   | 1    | PAVCCZ Y |
|  | 39       | TQB0E0794W | INSTRUCTION BOOK (SLOVAKIAN)  | 1    | PAVCCZ Y |
|  | 39       | TQB0E0794X | INSTRUCTION BOOK (CD-ROM)     | 1    | PAVCCZ Y |
|  | 39       | TQB0E0794Z | INSTRUCTION BOOK (ESTONIAN)   | 1    | PAVCCZ Y |
|  | 39       | TQB0E0795D | INSTRUCTION BOOK (FRENCH)     | 1    | PAVCCZ F |
|  | 39       | TQB0E0795U | INSTRUCTION BOOK (ENGLISH)    | 1    | PAVCCZ F |
|   | 40       | TQZJ060    | SCREW USE HANDBILL            | 1    | PAVCCZ   |
|   |          | TSXL519    | CABLE (SU11-SD11)             | 1    |          |
|   |          | TSXL724    | CABLE (C22-C32)               | 1    |          |

| Safety  | Ref. No. | Part No.     | Part Name & Description  | Q'ty | Remarks  |
|---|----------|--------------|--------------------------|------|----------|
|   |          | TSXL734      | CABLE (A20-SC20)         | 1    | PAVCCZ   |
|   |          | TSXL737      | CABLE (C10-C20)          | 1    |          |
|   |          | TSXL758      | CABLE (C21-A31)          | 1    | PAVCCZ   |
|   |          | TSXL761      | CABLE (C31-A32)          | 1    | PAVCCZ   |
|  | 41       | TTU0E0486    | REAR COVER               | 1    | PAVCCZ F |
|  | 41       | TTU0E0500    | REAR COVER               | 1    | PAVCCZ Y |
|  | 42       | TXAJS01EPUE  | AC INLET ASSY            | 1    | PAVCCZ   |
|   |          | TXFBL01EQUE  | STAND ACCESSORY ASSY     | 1    | PAVCCZ   |
|   | 43       | TXFBX03EQUE  | CONTROL BUTTON ASSY      | 1    | PAVCCZ   |
|   | 44       | TXFEA01EQUE  | SPEAKER L ASSY           | 1    | PAVCCZ   |
|   | 45       | TXFEA02EQUE  | SPEAKER R ASSY           | 1    | PAVCCZ   |
|   | 46       | TXFKP01EQUE  | SIDE TERMINAL COVER ASSY | 1    | PAVCCZ   |
|  | 47       | TXFKY01EPUR  | CABINET ASSY             | 1    | PAVCCZ   |
|  | 48       | TXFMX01EQUE  | AC CORD COMPLETE         | 1    | PAVCCZ   |
|   | 49       | TXFPE01RLTB  | CLEANING CLOTH ASSY      | 1    | PAVCCZ   |
|   |          | TXJA11EPUE-1 | SPEAKER LEAD (A11-SPR)   | 1    | PAVCCZ   |
|   |          | TXJA12EQUE   | SPEAKER LEAD (A12-SPL)   | 1    | PAVCCZ   |
|   |          | XSB3+6FJ     | SCREW                    | 2    |          |
|   |          | XTB4+10JFJ   | SCREW (STAND BRACKET)    | 8    |          |
|   |          | XTB4+12GFJ   | SCREW                    | 25   |          |
|   |          | XTB4+12GFJK  | SCREW                    | 13   |          |
|   |          | XTB4+12GFN   | SCREW                    | 4    |          |
|   |          | XTW3+10TFJ   | SCREW                    | 1    |          |
|   |          | XTWT4+Z15DFJ | SCREW (SP BOX)           | 4    |          |
|   |          | XYN3+F8FJ    | SCREW                    | 1    |          |
|   |          | XYN3+J12FJ   | SCREW                    | 28   |          |
|   |          | XYN4+E8FJ    | SCREW                    | 1    |          |
|   |          | XYN4+F10FJ   | SCREW                    | 20   |          |
|   | 50       | XYN5+F18FN   | SCREW (STAND POLE)       | 4    |          |
|   | 51       | XZB9X18C05   | BAG (STAND POLE L)       | 1    |          |
|   | 52       | XZBT6506     | POLY BAG                 | 1    |          |







| Safety | Ref. No. | Part No.     | Part Name & Description | Pcs | Remarks |
|--------|----------|--------------|-------------------------|-----|---------|
|        | C2381    | FIH1H223A970 | C 0.22UF, K, 50V        | 1   |         |
|        | C2383    | FIG1H102A730 | C 1000UF, 50V           | 1   |         |
|        | C2385    | FIG1H102A730 | C 1000UF, 50V           | 1   |         |
|        | C2387    | FIG1H102A730 | C 1000UF, 50V           | 1   |         |
|        | C2389    | FIG1H102A730 | C 1000UF, 50V           | 1   |         |
|        | C2390    | FIJ1E105A171 | C 1 UF 25V              | 1   |         |
|        | C2407    | FIK1E106A136 | C 10UF, Z, 25V          | 1   |         |
|        | C2408    | FIJ1E105A171 | C 1 UF 25V              | 1   |         |
|        | C2409    | FIG1H102A730 | C 1000UF, 50V           | 1   |         |
|        | C2410    | FIJ1E105A171 | C 1 UF 25V              | 1   |         |
|        | C2411    | FIJ1E105A171 | C 1 UF 25V              | 1   |         |
|        | C2412    | FIJ1E105A171 | C 1 UF 25V              | 1   |         |
|        | C2511    | FIH1C104A143 | C 0.1UF, K, 16V         | 1   |         |
|        | C2512    | FIJ1A106A043 | C 0.010UF, K, 10V       | 1   |         |
|        | C2515    | FIH1H103A970 | C 0.001UF, K, 50V       | 1   |         |
|        | C2517    | FIH1H103A970 | C 0.001UF, K, 50V       | 1   |         |
|        | C2521    | FIH1H103A970 | C 0.001UF, K, 50V       | 1   |         |
|        | C2871    | FIK1E106A136 | C 10UF, Z, 25V          | 1   |         |
|        | C2872    | FIG1E103A123 | C 0.010UF, K, 25V       | 1   |         |
|        | C2873    | FIH1E104A129 | C 0.1UF, 25V            | 1   |         |
|        | C2874    | F2G1A101A019 | E 100UF, 10V            | 1   |         |
|        | C2875    | FIH1H223A970 | C 0.22UF, K, 50V        | 1   |         |
|        | C2878    | FIH1H472A970 | C 4700PF, K, 50V        | 1   |         |
|        | C2901    | F2G1A101A019 | E 100UF, 10V            | 1   |         |
|        | C2906    | FIH1C104A143 | C 0.1UF, K, 16V         | 1   |         |
|        | C2907    | FIH1C104A143 | C 0.1UF, K, 16V         | 1   |         |
|        | C2912    | F2G0J101A019 | E 100UF 6.3V            | 1   |         |
|        | C2914    | FIH1H104A970 | C 0.1UF, K, 50V         | 1   |         |
|        | C2916    | FIH1C104A143 | C 0.1UF, K, 16V         | 1   |         |
|        | C2920    | FIH1H103A970 | C 0.001UF, K, 50V       | 1   |         |
|        | C2922    | FIH1C104A143 | C 0.1UF, K, 16V         | 1   |         |
|        | C2923    | FIH1H104A970 | C 0.1UF, K, 50V         | 1   |         |
|        | C2925    | FIG1C104A116 | C 0.10UF, K, 16V        | 1   |         |
|        | C2927    | FIG1H101A731 | C 100PF, K, 50V         | 1   |         |
|        | C2928    | FIG1H101A731 | C 100PF, K, 50V         | 1   |         |
|        | C2940    | FIH1H104A970 | C 0.1UF, K, 50V         | 1   |         |
|        | C2960    | FIH0J1050012 | C 1UF, K, 16V           | 1   |         |
|        | C2961    | FIG1H471A731 | C 470UF, 50V            | 1   |         |
|        | C2962    | FIH0J1050012 | C 1UF, K, 16V           | 1   |         |
|        | C3002    | FIG1H561A730 | C 56UF, 50V             | 1   | PAVCCZ  |
|        | C3003    | FIG1H561A730 | C 56UF, 50V             | 1   | PAVCCZ  |
|        | C3004    | FIG1H561A730 | C 56UF, 50V             | 1   | PAVCCZ  |
|        | C3005    | FIG1H561A730 | C 56UF, 50V             | 1   | PAVCCZ  |
|        | C3007    | FIG1H561A730 | C 56UF, 50V             | 1   | PAVCCZ  |
|        | C3008    | FIG1H561A730 | C 56UF, 50V             | 1   | PAVCCZ  |
|        | C3009    | FIG1H561A730 | C 56UF, 50V             | 1   | PAVCCZ  |
|        | C3010    | FIG1H561A730 | C 56UF, 50V             | 1   | PAVCCZ  |
|        | C3011    | FIG1H561A730 | C 56UF, 50V             | 1   | PAVCCZ  |
|        | C3012    | FIG1H561A730 | C 56UF, 50V             | 1   | PAVCCZ  |
|        | C3013    | FIG1H561A730 | C 56UF, 50V             | 1   | PAVCCZ  |
|        | C3014    | FIG1H561A730 | C 56UF, 50V             | 1   | PAVCCZ  |
|        | C3018    | FIJ1A106A043 | C 0.010UF, K, 10V       | 1   |         |
|        | C3019    | FIJ1A106A043 | C 0.010UF, K, 10V       | 1   |         |
|        | C3020    | FIJ1A106A043 | C 0.010UF, K, 10V       | 1   |         |
|        | C3021    | FIJ1A106A043 | C 0.010UF, K, 10V       | 1   |         |
|        | C3022    | FIH1A1050032 | C 10UF, 50V             | 1   |         |
|        | C3023    | FIG1C104A116 | C 0.10UF, K, 16V        | 1   |         |
|        | C3024    | FIH1A1050032 | C 10UF, 50V             | 1   |         |
|        | C3025    | FIH1A1050032 | C 10UF, 50V             | 1   |         |
|        | C3026    | FIH1A1050032 | C 10UF, 50V             | 1   |         |
|        | C3027    | FIJ1A106A043 | C 0.010UF, K, 10V       | 1   |         |
|        | C3028    | FIJ1A106A043 | C 0.010UF, K, 10V       | 1   |         |
|        | C3029    | FIJ1A106A043 | C 0.010UF, K, 10V       | 1   |         |

| Safety | Ref. No. | Part No.     | Part Name & Description | Pcs | Remarks |
|--------|----------|--------------|-------------------------|-----|---------|
|        | C3030    | FIJ1A106A043 | C 0.010UF, K, 10V       | 1   |         |
|        | C3039    | FIH1A1050032 | C 10UF, 50V             | 1   |         |
|        | C3041    | FIH1A1050032 | C 10UF, 50V             | 1   |         |
|        | C3043    | FIH1A1050032 | C 10UF, 50V             | 1   |         |
|        | C3044    | FIH1A1050032 | C 10UF, 50V             | 1   |         |
|        | C3046    | FIH1A1050032 | C 10UF, 50V             | 1   |         |
|        | C3047    | FIH1A1050032 | C 10UF, 50V             | 1   |         |
|        | C3048    | FIH1A1050032 | C 10UF, 50V             | 1   |         |
|        | C3049    | FIH1A1050032 | C 10UF, 50V             | 1   |         |
|        | C3056    | FIG1E333A091 | C 0.033UF, K, 25V       | 1   | PAVCCZ  |
|        | C3057    | FIG1E333A091 | C 0.033UF, K, 25V       | 1   | PAVCCZ  |
|        | C3064    | FIG1H102A730 | C 1000UF, 50V           | 1   |         |
|        | C3065    | FIG1H102A730 | C 1000UF, 50V           | 1   |         |
|        | C3070    | FIJ1A106A043 | C 0.010UF, K, 10V       | 1   |         |
|        | C3071    | FIJ1A106A043 | C 0.010UF, K, 10V       | 1   |         |
|        | C3072    | FIG1C104A116 | C 0.10UF, K, 16V        | 1   |         |
|        | C3073    | FIJ1A106A043 | C 0.010UF, K, 10V       | 1   |         |
|        | C3074    | FIJ1A106A043 | C 0.010UF, K, 10V       | 1   |         |
|        | C3075    | FIH1A1050032 | C 10UF, 50V             | 1   |         |
|        | C3077    | FIG1C104A116 | C 0.10UF, K, 16V        | 1   |         |
|        | C3078    | FIJ1A106A043 | C 0.010UF, K, 10V       | 1   |         |
|        | C3083    | FIJ1A106A043 | C 0.010UF, K, 10V       | 1   |         |
|        | C3084    | FIJ1A106A043 | C 0.010UF, K, 10V       | 1   |         |
|        | C3085    | FIJ1A106A043 | C 0.010UF, K, 10V       | 1   |         |
|        | C3086    | FIJ1A106A043 | C 0.010UF, K, 10V       | 1   |         |
|        | C3087    | FIJ1A106A043 | C 0.010UF, K, 10V       | 1   |         |
|        | C3088    | FIJ1A106A043 | C 0.010UF, K, 10V       | 1   |         |
|        | C3089    | FIJ1A106A043 | C 0.010UF, K, 10V       | 1   |         |
|        | C3090    | FIJ1A106A043 | C 0.010UF, K, 10V       | 1   |         |
|        | C3091    | FIJ1A106A043 | C 0.010UF, K, 10V       | 1   |         |
|        | C3092    | FIJ1A106A043 | C 0.010UF, K, 10V       | 1   |         |
|        | C3095    | F2G1A101A019 | E 100UF, 10V            | 1   |         |
|        | C3097    | F2G1A101A019 | E 100UF, 10V            | 1   |         |
|        | C3099    | FIG1H561A730 | C 56UF, 50V             | 1   | PAVCCZ  |
|        | C3102    | F2G1A101A019 | E 100UF, 10V            | 1   |         |
|        | C3103    | F2G1A101A019 | E 100UF, 10V            | 1   |         |
|        | C3107    | FIJ1A106A043 | C 0.010UF, K, 10V       | 1   |         |
|        | C3108    | FIJ1A106A043 | C 0.010UF, K, 10V       | 1   |         |
|        | C3109    | FIJ1A106A043 | C 0.010UF, K, 10V       | 1   |         |
|        | C3114    | FIJ1A106A043 | C 0.010UF, K, 10V       | 1   |         |
|        | C3115    | FIJ1A106A043 | C 0.010UF, K, 10V       | 1   |         |
|        | C3116    | FIJ1A106A043 | C 0.010UF, K, 10V       | 1   |         |
|        | C3117    | FIJ1A106A043 | C 0.010UF, K, 10V       | 1   |         |
|        | C3118    | FIH1A1050032 | C 10UF, 50V             | 1   |         |
|        | C3119    | FIH1A1050032 | C 10UF, 50V             | 1   |         |
|        | C3139    | FIG1C104A116 | C 0.10UF, K, 16V        | 1   |         |
|        | C3140    | FIG1C104A116 | C 0.10UF, K, 16V        | 1   |         |
|        | C3141    | FIG1C104A116 | C 0.10UF, K, 16V        | 1   |         |
|        | C3143    | FIG1C104A116 | C 0.10UF, K, 16V        | 1   |         |
|        | C3144    | FIJ1A106A043 | C 0.010UF, K, 10V       | 1   |         |
|        | C3145    | FIG1C104A116 | C 0.10UF, K, 16V        | 1   |         |

| Safety | Ref. No. | Part No.     | Part Name & Description | Pcs | Remarks |
|--------|----------|--------------|-------------------------|-----|---------|
|        | C3146    | F1J1A106A043 | C 0.010UF, K, 10V       | 1   |         |
|        | C3147    | F1J1A106A043 | C 0.010UF, K, 10V       | 1   |         |
|        | C3257    | F1G1H561A730 | C 56UF, 50V             | 1   | PAVCCZ  |
|        | C3752    | F1J1H102A836 | C 1000UF, 50V           | 1   |         |
|        | C4500    | F1G1C104A116 | C 0.10UF, K, 16V        | 1   |         |
|        | C4501    | F1G1C104A116 | C 0.10UF, K, 16V        | 1   |         |
|        | C4502    | F1G1C104A116 | C 0.10UF, K, 16V        | 1   |         |
|        | C4503    | F1G1C104A116 | C 0.10UF, K, 16V        | 1   |         |
|        | C4533    | F1G1H680A731 | C 68UF, 50V             | 1   |         |
|        | C4534    | F1G1C104A116 | C 0.10UF, K, 16V        | 1   |         |
|        | C4535    | F1G1C104A116 | C 0.10UF, K, 16V        | 1   |         |
|        | C4537    | F1G1C104A116 | C 0.10UF, K, 16V        | 1   |         |
|        | C4547    | F1G1C104A116 | C 0.10UF, K, 16V        | 1   |         |
|        | C4548    | F1G1C104A116 | C 0.10UF, K, 16V        | 1   |         |
|        | C4549    | F1G1C104A116 | C 0.10UF, K, 16V        | 1   |         |
|        | C4550    | F1G1C104A116 | C 0.10UF, K, 16V        | 1   |         |
|        | C4551    | F1G1C104A116 | C 0.10UF, K, 16V        | 1   |         |
|        | C4552    | F1G1C104A116 | C 0.10UF, K, 16V        | 1   |         |
|        | C4553    | F1G1H102A730 | C 1000UF, 50V           | 1   |         |
|        | C4554    | F2G1C470A022 | E 47UF, 16V             | 1   |         |
|        | C4555    | F1J1A106A043 | C 0.010UF, K, 10V       | 1   |         |
|        | C4567    | F1G1C104A116 | C 0.10UF, K, 16V        | 1   |         |
|        | C4574    | F1G1C104A116 | C 0.10UF, K, 16V        | 1   |         |
|        | C4575    | F1G1C104A116 | C 0.10UF, K, 16V        | 1   |         |
|        | C4580    | F1G1C104A116 | C 0.10UF, K, 16V        | 1   |         |
|        | C4585    | F1G1C104A116 | C 0.10UF, K, 16V        | 1   |         |
|        | C4595    | F1G1C104A116 | C 0.10UF, K, 16V        | 1   |         |
|        | C4598    | F1J1A106A043 | C 0.010UF, K, 10V       | 1   |         |
|        | C4599    | F1J1A106A043 | C 0.010UF, K, 10V       | 1   |         |
|        | C4600    | F1G1C104A116 | C 0.10UF, K, 16V        | 1   |         |
|        | C4601    | F1J1A106A043 | C 0.010UF, K, 10V       | 1   |         |
|        | C4602    | F1G1C104A116 | C 0.10UF, K, 16V        | 1   |         |
|        | C4603    | F1J1A475A039 | C 4.7UF, K, 10V         | 1   |         |
|        | C4605    | F1J1A475A039 | C 4.7UF, K, 10V         | 1   |         |
|        | C4606    | F1J1A475A039 | C 4.7UF, K, 10V         | 1   |         |
|        | C4607    | F1J1A475A039 | C 4.7UF, K, 10V         | 1   |         |
|        | C4608    | F1G1C104A116 | C 0.10UF, K, 16V        | 1   |         |
|        | C4613    | F1H0J1050012 | C 1UF, K, 16V           | 1   |         |
|        | C4616    | F1J1A475A039 | C 4.7UF, K, 10V         | 1   |         |
|        | C4617    | F1J1A475A039 | C 4.7UF, K, 10V         | 1   |         |
|        | C4624    | F1G1C104A116 | C 0.10UF, K, 16V        | 1   |         |
|        | C4625    | F1G1C104A116 | C 0.10UF, K, 16V        | 1   |         |
|        | C4626    | F1G1C104A116 | C 0.10UF, K, 16V        | 1   |         |
|        | C4628    | F1G1C104A116 | C 0.10UF, K, 16V        | 1   |         |
|        | C4629    | F1G1C104A116 | C 0.10UF, K, 16V        | 1   |         |
|        | C4630    | F1G1C104A116 | C 0.10UF, K, 16V        | 1   |         |
|        | C4631    | F1J1A106A043 | C 0.010UF, K, 10V       | 1   |         |
|        | C4632    | F1G1C104A116 | C 0.10UF, K, 16V        | 1   |         |
|        | C4633    | F1J1A106A043 | C 0.010UF, K, 10V       | 1   |         |
|        | C4634    | F1G1C104A116 | C 0.10UF, K, 16V        | 1   |         |
|        | C4635    | F1J1A106A043 | C 0.010UF, K, 10V       | 1   |         |
|        | C4636    | F1G1C104A116 | C 0.10UF, K, 16V        | 1   |         |
|        | C4637    | F1G1C104A116 | C 0.10UF, K, 16V        | 1   |         |
|        | C4638    | F1G1C104A116 | C 0.10UF, K, 16V        | 1   |         |
|        | C4640    | F1G1C104A116 | C 0.10UF, K, 16V        | 1   |         |
|        | C4642    | F1G1C104A116 | C 0.10UF, K, 16V        | 1   |         |
|        | C4643    | F1G1C104A116 | C 0.10UF, K, 16V        | 1   |         |
|        | C4644    | F1G1C104A116 | C 0.10UF, K, 16V        | 1   |         |
|        | C4645    | F1G1C104A116 | C 0.10UF, K, 16V        | 1   |         |
|        | C4702    | F1G1C104A116 | C 0.10UF, K, 16V        | 1   |         |
|        | C4703    | F1G1C104A116 | C 0.10UF, K, 16V        | 1   |         |
|        | C5470    | F1G1C103A116 | C 0.010UF, K, 16V       | 1   |         |
|        | C5471    | F1G1A473A053 | C 0.47UF, 10V           | 1   |         |
|        | C5473    | F1G1E103A123 | C 0.010UF, K, 25V       | 1   |         |

| Safety | Ref. No. | Part No.     | Part Name & Description | Pcs | Remarks |
|--------|----------|--------------|-------------------------|-----|---------|
|        | C5482    | F2G1A221A149 | E 220UF, 10V            | 1   |         |
|        | C5483    | F1J1A106A043 | C 0.010UF, K, 10V       | 1   |         |
|        | C5484    | F2G0J470A019 | E 47UF 6.3V             | 1   |         |
|        | C5485    | F1G1C104A116 | C 0.10UF, K, 16V        | 1   |         |
|        | C5486    | F1G1E392A123 | C 3900UF, Z, 25V        | 1   | PAVCCZ  |
|        | C5487    | F1H0J1050012 | C 1UF, K, 16V           | 1   |         |
|        | C5488    | F1H0J1050012 | C 1UF, K, 16V           | 1   |         |
|        | C5490    | F1J1H474A757 | C 0.47UF, 50V           | 1   |         |
|        | C5491    | F1J1H474A757 | C 0.47UF, 50V           | 1   |         |
|        | C5494    | F1G1H820A731 | C 82UF, 50V             | 1   |         |
|        | C5495    | F2G1V220A020 | E 22UF, 35V             | 1   |         |
|        | C5496    | F1G1H102A730 | C 1000UF, 50V           | 1   |         |
|        | C5520    | F2G1C100A022 | C 10UF J 16V            | 1   |         |
|        | C5600    | F1G1C104A116 | C 0.10UF, K, 16V        | 1   |         |
|        | C5601    | F1G1H272A571 | C 2700UF, 50V           | 1   |         |
|        | C5602    | F2H0J1010009 | C 100UF, 6.3V           | 1   |         |
|        | C5603    | F1H1C105A145 | C 0.01UF, K, 16V        | 1   |         |
|        | C5604    | F1G1E103A123 | C 0.010UF, K, 25V       | 1   |         |
|        | C5605    | F1J1A475A039 | C 4.7UF, K, 10V         | 1   |         |
|        | C5606    | F1G1E6820007 | C 6800UF, Z, 25V        | 1   |         |
|        | C5607    | F1G1H152A571 | C 1500UF, 50V           | 1   |         |
|        | C5608    | F1G1C104A116 | C 0.10UF, K, 16V        | 1   |         |
|        | C5611    | F1K1E106A136 | C 10UF, Z, 25V          | 1   |         |
|        | C5612    | F1K1E106A136 | C 10UF, Z, 25V          | 1   |         |
|        | C5615    | F1K1E106A136 | C 10UF, Z, 25V          | 1   |         |
|        | C5616    | F1G1E103A123 | C 0.010UF, K, 25V       | 1   |         |
|        | C5620    | F1H1E104A129 | C 0.1UF, 25V            | 1   |         |
|        | C5621    | F1H1C105A145 | C 0.01UF, K, 16V        | 1   |         |
|        | C5622    | F1J1A475A039 | C 4.7UF, K, 10V         | 1   |         |
|        | C5623    | F1G1H272A571 | C 2700UF, 50V           | 1   |         |
|        | C5624    | F1G1H3320004 | C 3300UF. 50V           | 1   | PAVCCZ  |
|        | C5625    | F1G1C273A081 | C 0.027UF, K, 16V       | 1   |         |
|        | C5626    | F1G1C104A116 | C 0.10UF, K, 16V        | 1   |         |
|        | C5627    | F1G1C104A116 | C 0.10UF, K, 16V        | 1   |         |
|        | C5628    | ECGRLOE680ER | C 68UF, J, 2.5V         | 1   |         |
|        | C5629    | ECGRLOE680ER | C 68UF, J, 2.5V         | 1   |         |
|        | C5636    | F1G1C104A116 | C 0.10UF, K, 16V        | 1   |         |
|        | C5637    | F1G1C104A116 | C 0.10UF, K, 16V        | 1   |         |
|        | C5638    | F1G1C104A116 | C 0.10UF, K, 16V        | 1   |         |
|        | C5639    | F1G1C104A116 | C 0.10UF, K, 16V        | 1   |         |
|        | C5640    | F1G1C104A116 | C 0.10UF, K, 16V        | 1   |         |
|        | C5641    | F1G1C104A116 | C 0.10UF, K, 16V        | 1   |         |
|        | C5642    | F1K1E106A136 | C 10UF, Z, 25V          | 1   |         |
|        | C5643    | F1H1E104A129 | C 0.1UF, 25V            | 1   |         |
|        | C5645    | F1K1E106A136 | C 10UF, Z, 25V          | 1   |         |
|        | C5646    | F1K1E106A136 | C 10UF, Z, 25V          | 1   |         |
|        | C5648    | F2H0J1010009 | C 100UF, 6.3V           | 1   |         |
|        | C5649    | F1G1C104A116 | C 0.10UF, K, 16V        | 1   |         |
|        | C5657    | F1H1A225A051 | C 22UF, 50V             | 1   |         |
|        | C5658    | F1G1E103A123 | C 0.010UF, K, 25V       | 1   |         |
|        | C5696    | F2G1E470A021 | C 47PF, J, 25V          | 1   |         |
|        | C5697    | F1J1E105A171 | C 1 UF 25V              | 1   |         |
|        | C5699    | F1K1E106A136 | C 10UF, Z, 25V          | 1   |         |
|        | C5700    | F1K1E106A136 | C 10UF, Z, 25V          | 1   |         |
|        | C5722    | F1J1E105A171 | C 1 UF 25V              | 1   |         |
|        | C5723    | F1H1C105A145 | C 0.01UF, K, 16V        | 1   |         |
|        | C5727    | F1G1C104A116 | C 0.10UF, K, 16V        | 1   |         |
|        | C5728    | F1G1C104A116 | C 0.10UF, K, 16V        | 1   |         |
|        | C8003    | F1H0J1050012 | C 1UF, K, 16V           | 1   |         |
|        | C8005    | F1H0J1050012 | C 1UF, K, 16V           | 1   |         |
|        | C8006    | F1G1C104A116 | C 0.10UF, K, 16V        | 1   |         |
|        | C8007    | F1G1C104A116 | C 0.10UF, K, 16V        | 1   |         |
|        | C8008    | F1G1C104A116 | C 0.10UF, K, 16V        | 1   |         |
|        | C8009    | F1J1A106A043 | C 0.010UF, K, 10V       | 1   |         |
|        | C8010    | F1J1A106A043 | C 0.010UF, K, 10V       | 1   |         |
|        | C8011    | F1G1C104A116 | C 0.10UF, K, 16V        | 1   |         |
|        | C8012    | F1G1C104A116 | C 0.10UF, K, 16V        | 1   |         |

| Safety | Ref. No. | Part No.     | Part Name & Description | Pcs | Remarks |
|--------|----------|--------------|-------------------------|-----|---------|
|        | C8013    | FIG1C104A116 | C 0.10UF, K, 16V        | 1   |         |
|        | C8014    | FIG1C104A116 | C 0.10UF, K, 16V        | 1   |         |
|        | C8015    | FIH0J1050012 | C 1UF, K, 16V           | 1   |         |
|        | C8016    | FIH0J1050012 | C 1UF, K, 16V           | 1   |         |
|        | C8017    | FIJ1A106A043 | C 0.010UF, K, 10V       | 1   |         |
|        | C8018    | FIG1C104A116 | C 0.10UF, K, 16V        | 1   |         |
|        | C8019    | FIG1C104A116 | C 0.10UF, K, 16V        | 1   |         |
|        | C8020    | FIG1C104A116 | C 0.10UF, K, 16V        | 1   |         |
|        | C8021    | FIG1C104A116 | C 0.10UF, K, 16V        | 1   |         |
|        | C8022    | FIH0J1050012 | C 1UF, K, 16V           | 1   |         |
|        | C8023    | FIJ1A106A043 | C 0.010UF, K, 10V       | 1   |         |
|        | C8024    | FIJ1A106A043 | C 0.010UF, K, 10V       | 1   |         |
|        | C8025    | FIG1C104A116 | C 0.10UF, K, 16V        | 1   |         |
|        | C8026    | FIG1C104A116 | C 0.10UF, K, 16V        | 1   |         |
|        | C8027    | FIG1C104A116 | C 0.10UF, K, 16V        | 1   |         |
|        | C8028    | FIG1C104A116 | C 0.10UF, K, 16V        | 1   |         |
|        | C8029    | FIG1C104A116 | C 0.10UF, K, 16V        | 1   |         |
|        | C8030    | FIH0J1050012 | C 1UF, K, 16V           | 1   |         |
|        | C8031    | FIH0J1050012 | C 1UF, K, 16V           | 1   |         |
|        | C8032    | FIJ1A106A043 | C 0.010UF, K, 10V       | 1   |         |
|        | C8033    | FIG1C104A116 | C 0.10UF, K, 16V        | 1   |         |
|        | C8034    | FIG1C104A116 | C 0.10UF, K, 16V        | 1   |         |
|        | C8035    | FIJ1A106A043 | C 0.010UF, K, 10V       | 1   |         |
|        | C8036    | FIJ1A106A043 | C 0.010UF, K, 10V       | 1   |         |
|        | C8037    | FIG1C104A116 | C 0.10UF, K, 16V        | 1   |         |
|        | C8038    | FIG1C104A116 | C 0.10UF, K, 16V        | 1   |         |
|        | C8039    | FIG1C104A116 | C 0.10UF, K, 16V        | 1   |         |
|        | C8040    | FIG1C104A116 | C 0.10UF, K, 16V        | 1   |         |
|        | C8041    | FIG1C104A116 | C 0.10UF, K, 16V        | 1   |         |
|        | C8042    | ECGRLOG680ER | C 68UF, J, 4V           | 1   |         |
|        | C8043    | FIG1C104A116 | C 0.10UF, K, 16V        | 1   |         |
|        | C8044    | FIG1C104A116 | C 0.10UF, K, 16V        | 1   |         |
|        | C8045    | FIG1C104A116 | C 0.10UF, K, 16V        | 1   |         |
|        | C8046    | FIG1C104A116 | C 0.10UF, K, 16V        | 1   |         |
|        | C8047    | FIG1C104A116 | C 0.10UF, K, 16V        | 1   |         |
|        | C8048    | FIG1C104A116 | C 0.10UF, K, 16V        | 1   |         |
|        | C8049    | FIG1C104A116 | C 0.10UF, K, 16V        | 1   |         |
|        | C8050    | FIG1C104A116 | C 0.10UF, K, 16V        | 1   |         |
|        | C8051    | FIG1C104A116 | C 0.10UF, K, 16V        | 1   |         |
|        | C8052    | FIH0J1050012 | C 1UF, K, 16V           | 1   |         |
|        | C8053    | FIG1C103A116 | C 0.010UF, K, 16V       | 1   |         |
|        | C8054    | FIG1H150A731 | C 15UF, 50V             | 1   |         |
|        | C8055    | FIG1HR50A577 | C 0.50UF, 50V           | 1   |         |
|        | C8056    | FIG1C104A116 | C 0.10UF, K, 16V        | 1   |         |
|        | C8057    | FIG1C104A116 | C 0.10UF, K, 16V        | 1   |         |
|        | C8058    | FIJ1A106A043 | C 0.010UF, K, 10V       | 1   |         |
|        | C8063    | FIH0J1050012 | C 1UF, K, 16V           | 1   |         |
|        | C8064    | FIH0J1050012 | C 1UF, K, 16V           | 1   |         |
|        | C8065    | FIG1C104A116 | C 0.10UF, K, 16V        | 1   |         |
|        | C8067    | FIG1C104A116 | C 0.10UF, K, 16V        | 1   |         |
|        | C8069    | FIG1H102A730 | C 1000UF, 50V           | 1   |         |
|        | C8070    | FIG1C104A116 | C 0.10UF, K, 16V        | 1   |         |
|        | C8071    | FIG1C104A116 | C 0.10UF, K, 16V        | 1   |         |
|        | C8072    | FIG1C104A116 | C 0.10UF, K, 16V        | 1   |         |
|        | C8073    | FIG1C104A116 | C 0.10UF, K, 16V        | 1   |         |
|        | C8074    | FIG1C104A116 | C 0.10UF, K, 16V        | 1   |         |
|        | C8075    | FIJ1A106A043 | C 0.010UF, K, 10V       | 1   |         |
|        | C8076    | FIG1C104A116 | C 0.10UF, K, 16V        | 1   |         |
|        | C8077    | FIG1C104A116 | C 0.10UF, K, 16V        | 1   |         |
|        | C8078    | FIG1C104A116 | C 0.10UF, K, 16V        | 1   |         |
|        | C8079    | FIG1C104A116 | C 0.10UF, K, 16V        | 1   |         |
|        | C8080    | FIG1C104A116 | C 0.10UF, K, 16V        | 1   |         |
|        | C8081    | FIG1C104A116 | C 0.10UF, K, 16V        | 1   |         |
|        | C8082    | FIG1H102A730 | C 1000UF, 50V           | 1   |         |
|        | C8083    | FIG1C104A116 | C 0.10UF, K, 16V        | 1   |         |
|        | C8084    | FIG1H102A730 | C 1000UF, 50V           | 1   |         |

| Safety | Ref. No. | Part No.     | Part Name & Description | Pcs | Remarks |
|--------|----------|--------------|-------------------------|-----|---------|
|        | C8085    | FIG1C104A116 | C 0.10UF, K, 16V        | 1   |         |
|        | C8086    | FIG1C104A116 | C 0.10UF, K, 16V        | 1   |         |
|        | C8087    | FIG1C104A116 | C 0.10UF, K, 16V        | 1   |         |
|        | C8088    | FIG1C104A116 | C 0.10UF, K, 16V        | 1   |         |
|        | C8089    | FIG1C104A116 | C 0.10UF, K, 16V        | 1   |         |
|        | C8090    | FIG1C104A116 | C 0.10UF, K, 16V        | 1   |         |
|        | C8092    | FIG1C104A116 | C 0.10UF, K, 16V        | 1   |         |
|        | C8093    | FIG1C104A116 | C 0.10UF, K, 16V        | 1   |         |
|        | C8094    | FIG1C104A116 | C 0.10UF, K, 16V        | 1   |         |
|        | C8095    | FIG1C104A116 | C 0.10UF, K, 16V        | 1   |         |
|        | C8096    | FIG1C104A116 | C 0.10UF, K, 16V        | 1   |         |
|        | C8097    | FIG1C104A116 | C 0.10UF, K, 16V        | 1   |         |
|        | C8098    | FIG1C104A116 | C 0.10UF, K, 16V        | 1   |         |
|        | C8099    | FIG1C104A116 | C 0.10UF, K, 16V        | 1   |         |
|        | C8100    | FIG1C104A116 | C 0.10UF, K, 16V        | 1   |         |
|        | C8101    | FIG1C104A116 | C 0.10UF, K, 16V        | 1   |         |
|        | C8102    | FIG1C104A116 | C 0.10UF, K, 16V        | 1   |         |
|        | C8201    | FIG1C104A116 | C 0.10UF, K, 16V        | 1   |         |
|        | C8202    | FIG1C104A116 | C 0.10UF, K, 16V        | 1   |         |
|        | C8306    | FIG1A4740003 | C0.047UF, K, 10V        | 1   | PAVCCZ  |
|        | C8307    | FIG1C104A116 | C 0.10UF, K, 16V        | 1   |         |
|        | C8309    | FIG1C104A116 | C 0.10UF, K, 16V        | 1   |         |
|        | C8311    | FIG1H120A731 | C 12UF, 50V             | 1   |         |
|        | C8312    | FIG1H120A731 | C 12UF, 50V             | 1   |         |
|        | C8313    | FIG1C104A116 | C 0.10UF, K, 16V        | 1   |         |
|        | C8314    | FIG1C104A116 | C 0.10UF, K, 16V        | 1   |         |
|        | C8316    | FIG1C271A117 | C 270UF, K, 16V         | 1   |         |
|        | C8317    | FIG1C271A117 | C 270UF, K, 16V         | 1   |         |
|        | C8319    | FIG1C104A116 | C 0.10UF, K, 16V        | 1   |         |
|        | C8320    | FIG1C104A116 | C 0.10UF, K, 16V        | 1   |         |
|        | C8321    | FIG1C104A116 | C 0.10UF, K, 16V        | 1   |         |
|        | C8327    | FIH1A225A051 | C 22UF, 50V             | 1   |         |
|        | C8328    | FIH1A1050032 | C 10UF, 50V             | 1   |         |
|        | C8329    | FIG1C104A116 | C 0.10UF, K, 16V        | 1   |         |
|        | C8330    | FIG1C104A116 | C 0.10UF, K, 16V        | 1   |         |
|        | C8331    | FIG1C104A116 | C 0.10UF, K, 16V        | 1   |         |
|        | C8332    | FIG1C104A116 | C 0.10UF, K, 16V        | 1   |         |
|        | C8333    | FIG1C104A116 | C 0.10UF, K, 16V        | 1   |         |
|        | C8334    | FIG1C104A116 | C 0.10UF, K, 16V        | 1   |         |
|        | C8335    | FIG1C104A116 | C 0.10UF, K, 16V        | 1   |         |
|        | C8336    | FIG1C104A116 | C 0.10UF, K, 16V        | 1   |         |
|        | C8340    | FIG1C104A116 | C 0.10UF, K, 16V        | 1   |         |
|        | C8343    | FIG1C104A116 | C 0.10UF, K, 16V        | 1   |         |
|        | C8344    | FIG1C104A116 | C 0.10UF, K, 16V        | 1   |         |
|        | C8345    | FIG1C104A116 | C 0.10UF, K, 16V        | 1   |         |
|        | C8346    | FIG1C104A116 | C 0.10UF, K, 16V        | 1   |         |
|        | C8405    | FIG1C104A116 | C 0.10UF, K, 16V        | 1   |         |
|        | C8408    | FIG1C104A116 | C 0.10UF, K, 16V        | 1   |         |
|        | C8409    | FIG1C104A116 | C 0.10UF, K, 16V        | 1   |         |
|        | C8410    | FIG1C104A116 | C 0.10UF, K, 16V        | 1   |         |
|        | C8411    | F2G1A101A019 | E 100UF, 10V            | 1   |         |
|        | C8412    | FIG1C104A116 | C 0.10UF, K, 16V        | 1   |         |
|        | C8413    | FIG1C104A116 | C 0.10UF, K, 16V        | 1   |         |
|        | C8414    | FIG1C104A116 | C 0.10UF, K, 16V        | 1   |         |
|        | C8415    | FIG1C104A116 | C 0.10UF, K, 16V        | 1   |         |
|        | C8416    | FIG1E103A123 | C 0.010UF, K, 25V       | 1   |         |
|        | C8417    | FIG1E103A123 | C 0.010UF, K, 25V       | 1   |         |
|        | C8418    | FIG1C104A116 | C 0.10UF, K, 16V        | 1   |         |
|        | C8508    | FIG1C103A116 | C 0.010UF, K, 16V       | 1   |         |
|        | C8510    | FIJ1A106A043 | C 0.010UF, K, 10V       | 1   |         |
|        | C8532    | F2G1C470A022 | E 47UF, 16V             | 1   |         |
|        | C8533    | FIG1C104A116 | C 0.10UF, K, 16V        | 1   |         |
|        | C8535    | FIG1C103A116 | C 0.010UF, K, 16V       | 1   |         |
|        | C8544    | FIJ0G2260001 | C 0.001UF, 6.3V         | 1   |         |
|        | C8580    | FIG1C104A116 | C 0.10UF, K, 16V        | 1   |         |
|        | C8581    | FIG1C104A116 | C 0.10UF, K, 16V        | 1   |         |
|        | C9033    | FIG1C104A116 | C 0.10UF, K, 16V        | 1   |         |
|        | C9034    | FIG1C104A116 | C 0.10UF, K, 16V        | 1   |         |

| Safety | Ref. No. | Part No.     | Part Name & Description | Pcs | Remarks |
|--------|----------|--------------|-------------------------|-----|---------|
|        | C9035    | F1J1A106A043 | C 0.010UF, K, 10V       | 1   |         |
|        | C9036    | F1J1A106A043 | C 0.010UF, K, 10V       | 1   |         |
|        | C9037    | F1G1E103A123 | C 0.010UF, K, 25V       | 1   |         |
|        | C9040    | F1G1C104A116 | C 0.10UF, K, 16V        | 1   |         |
|        | C9044    | F1J1A475A039 | C 4.7UF, K, 10V         | 1   |         |
|        | C9045    | F1G1C104A116 | C 0.10UF, K, 16V        | 1   |         |
|        | C9046    | F1G1C104A116 | C 0.10UF, K, 16V        | 1   |         |
|        | C9047    | F1G1C104A116 | C 0.10UF, K, 16V        | 1   |         |
|        | C9048    | F1G1C104A116 | C 0.10UF, K, 16V        | 1   |         |
|        | C9049    | F1G1C104A116 | C 0.10UF, K, 16V        | 1   |         |
|        | C9052    | F1G1C104A116 | C 0.10UF, K, 16V        | 1   |         |
|        | C9053    | F1G1C104A116 | C 0.10UF, K, 16V        | 1   |         |
|        | C9055    | F1G1C104A116 | C 0.10UF, K, 16V        | 1   |         |
|        | C9057    | F1G1C104A116 | C 0.10UF, K, 16V        | 1   |         |
|        | C9061    | F1G1C104A116 | C 0.10UF, K, 16V        | 1   |         |
|        | C9062    | F1J1A475A039 | C 4.7UF, K, 10V         | 1   |         |
|        | C9063    | F1G1C104A116 | C 0.10UF, K, 16V        | 1   |         |
|        | C9064    | F1G1C104A116 | C 0.10UF, K, 16V        | 1   |         |
|        | C9065    | F1G1C104A116 | C 0.10UF, K, 16V        | 1   |         |
|        | C9066    | F1H1E104A129 | C 0.1UF, 25V            | 1   |         |
|        | C9067    | F1K0J226A008 | C 22UF, K, 6.3V         | 1   |         |
|        | C9068    | F1K0J226A008 | C 22UF, K, 6.3V         | 1   |         |
|        | C9069    | F1G1H222A730 | C 2200UF, 50V           | 1   |         |
|        | C9071    | F1H1E104A129 | C 0.1UF, 25V            | 1   |         |
|        | C9072    | F1K0J226A008 | C 22UF, K, 6.3V         | 1   |         |
|        | C9073    | F1K0J226A008 | C 22UF, K, 6.3V         | 1   |         |
|        | C9074    | F1G1H222A730 | C 2200UF, 50V           | 1   |         |
|        | C9076    | F1G1C223A116 | C 0.022UF, K, 16V       | 1   |         |
|        | C9077    | F1K1E106A136 | C 10UF, Z, 25V          | 1   |         |
|        | C9078    | F1K1E106A136 | C 10UF, Z, 25V          | 1   |         |
|        | C9079    | F1G1H220A731 | C 22UF, 50V             | 1   |         |
|        | C9080    | F1G1H201A731 | C 200 UF, K, 50V        | 1   |         |
|        | C9468    | F1G1E103A123 | C 0.010UF, K, 25V       | 1   |         |
|        | C9469    | F1G1C104A116 | C 0.10UF, K, 16V        | 1   |         |
|        | C9535    | F1G1C104A116 | C 0.10UF, K, 16V        | 1   |         |
|        | C9536    | F1G1C104A116 | C 0.10UF, K, 16V        | 1   |         |
|        | C9537    | F1G1C104A116 | C 0.10UF, K, 16V        | 1   |         |
|        | C9538    | F1G1C104A116 | C 0.10UF, K, 16V        | 1   |         |
|        | C9539    | F1G1C104A116 | C 0.10UF, K, 16V        | 1   |         |
|        | C9540    | F1G1C104A116 | C 0.10UF, K, 16V        | 1   |         |
|        | C9541    | F1G1C104A116 | C 0.10UF, K, 16V        | 1   |         |
|        | C9542    | F1G1C104A116 | C 0.10UF, K, 16V        | 1   |         |
|        | C9543    | F1G1C104A116 | C 0.10UF, K, 16V        | 1   |         |
|        | C9544    | F1G1C104A116 | C 0.10UF, K, 16V        | 1   |         |
|        | C9545    | F1G1C104A116 | C 0.10UF, K, 16V        | 1   |         |
|        | C9546    | F1G1C104A116 | C 0.10UF, K, 16V        | 1   |         |
|        | C9547    | F1G1C104A116 | C 0.10UF, K, 16V        | 1   |         |
|        | C9548    | F1G1C104A116 | C 0.10UF, K, 16V        | 1   |         |
|        | C9549    | F1G1C104A116 | C 0.10UF, K, 16V        | 1   |         |
|        | C9550    | F1G1C104A116 | C 0.10UF, K, 16V        | 1   |         |
|        | C9823    | F1K1E106A136 | C 10UF, Z, 25V          | 1   |         |
|        | C9825    | F1G1H101A731 | C 100PF, K, 50V         | 1   |         |
|        | C9832    | F1J1A106A043 | C 0.010UF, K, 10V       | 1   |         |
|        | C9837    | F1J1A106A043 | C 0.010UF, K, 10V       | 1   |         |
|        | C9840    | F1G1E103A123 | C 0.010UF, K, 25V       | 1   |         |
|        | C9844    | F1G1E103A123 | C 0.010UF, K, 25V       | 1   |         |
|        | C9845    | F1G1C104A116 | C 0.10UF, K, 16V        | 1   |         |
|        | C9846    | F1G1C104A116 | C 0.10UF, K, 16V        | 1   |         |
|        | C9858    | F1K1E106A136 | C 10UF, Z, 25V          | 1   |         |
|        | C9859    | F1G1E103A123 | C 0.010UF, K, 25V       | 1   |         |
|        | C9863    | F1G1E472A123 | C 4200UF, Z, 25V        | 1   |         |
|        | C9869    | F1K1E106A136 | C 10UF, Z, 25V          | 1   |         |
|        | C9872    | F1K1E106A136 | C 10UF, Z, 25V          | 1   |         |
|        | C9874    | F1G1H101A731 | C 100PF, K, 50V         | 1   |         |
|        | C9882    | F1G1H201A731 | C 200 UF, K, 50V        | 1   |         |

| Safety | Ref. No. | Part No.     | Part Name & Description | Pcs | Remarks |
|--------|----------|--------------|-------------------------|-----|---------|
|        | C9889    | F1J1A106A043 | C 0.010UF, K, 10V       | 1   |         |
|        | C9892    | F1J1A106A043 | C 0.010UF, K, 10V       | 1   |         |
|        | C9897    | F1J1A106A043 | C 0.010UF, K, 10V       | 1   |         |
|        | C9899    | F1J1A106A043 | C 0.010UF, K, 10V       | 1   |         |
|        | C9900    | F1G1C104A116 | C 0.10UF, K, 16V        | 1   |         |
|        | C9901    | F1G1C104A116 | C 0.10UF, K, 16V        | 1   |         |
|        | C9902    | F1G1C104A116 | C 0.10UF, K, 16V        | 1   |         |
|        | C9903    | F1G1C104A116 | C 0.10UF, K, 16V        | 1   |         |
|        | C9904    | F1G1C104A116 | C 0.10UF, K, 16V        | 1   |         |
|        | C9905    | F1G1C104A116 | C 0.10UF, K, 16V        | 1   |         |
|        | C9906    | F1G1C104A116 | C 0.10UF, K, 16V        | 1   |         |
|        | C9907    | F1G1C104A116 | C 0.10UF, K, 16V        | 1   |         |
|        | C9908    | F1G1C104A116 | C 0.10UF, K, 16V        | 1   |         |
|        | C9909    | F1G1C104A116 | C 0.10UF, K, 16V        | 1   |         |
|        | C9910    | F1G1C104A116 | C 0.10UF, K, 16V        | 1   |         |
|        | C9911    | F1G1C104A116 | C 0.10UF, K, 16V        | 1   |         |
|        | C9912    | F1G1C104A116 | C 0.10UF, K, 16V        | 1   |         |
|        | C9913    | F1G1C104A116 | C 0.10UF, K, 16V        | 1   |         |
|        | C9914    | F1G1C104A116 | C 0.10UF, K, 16V        | 1   |         |
|        | C9915    | F1G1C104A116 | C 0.10UF, K, 16V        | 1   |         |
|        | C9916    | F1G1C104A116 | C 0.10UF, K, 16V        | 1   |         |
|        | C9917    | F1G1C104A116 | C 0.10UF, K, 16V        | 1   |         |
|        | C9918    | F1G1C104A116 | C 0.10UF, K, 16V        | 1   |         |
|        | C9919    | F1G1C104A116 | C 0.10UF, K, 16V        | 1   |         |
|        | C9920    | F1G1C104A116 | C 0.10UF, K, 16V        | 1   |         |
|        | C9921    | F1G1C104A116 | C 0.10UF, K, 16V        | 1   |         |
|        | C9922    | F1G1C104A116 | C 0.10UF, K, 16V        | 1   |         |
|        | C9923    | F1G1C104A116 | C 0.10UF, K, 16V        | 1   |         |
|        | C9924    | F1G1C104A116 | C 0.10UF, K, 16V        | 1   |         |
|        | C9925    | F1G1C104A116 | C 0.10UF, K, 16V        | 1   |         |
|        | C9926    | F1J1A106A043 | C 0.010UF, K, 10V       | 1   |         |
|        | C9927    | F1G1C104A116 | C 0.10UF, K, 16V        | 1   |         |
|        | C9928    | F1G1C104A116 | C 0.10UF, K, 16V        | 1   |         |
|        | C9929    | F1G1C104A116 | C 0.10UF, K, 16V        | 1   |         |
|        | C9930    | F1G1C104A116 | C 0.10UF, K, 16V        | 1   |         |
|        | C9931    | F1G1C104A116 | C 0.10UF, K, 16V        | 1   |         |
|        | C9932    | F1G1C104A116 | C 0.10UF, K, 16V        | 1   |         |
|        | C9933    | F1G1C104A116 | C 0.10UF, K, 16V        | 1   |         |
|        | C9934    | F1G1C104A116 | C 0.10UF, K, 16V        | 1   |         |
|        | C9935    | F1G1C104A116 | C 0.10UF, K, 16V        | 1   |         |
|        | C9936    | F1G1C104A116 | C 0.10UF, K, 16V        | 1   |         |
|        | C9937    | F1G1C104A116 | C 0.10UF, K, 16V        | 1   |         |
|        | C9938    | F1G1C104A116 | C 0.10UF, K, 16V        | 1   |         |
|        | C9939    | F1G1C104A116 | C 0.10UF, K, 16V        | 1   |         |
|        | C9940    | F1G1C104A116 | C 0.10UF, K, 16V        | 1   |         |
|        | C9941    | F1G1C104A116 | C 0.10UF, K, 16V        | 1   |         |
|        | C9942    | F1G1C104A116 | C 0.10UF, K, 16V        | 1   |         |
|        | C9943    | F1G1C104A116 | C 0.10UF, K, 16V        | 1   |         |
|        | C9944    | F1G1C104A116 | C 0.10UF, K, 16V        | 1   |         |
|        | C9945    | F1G1C104A116 | C 0.10UF, K, 16V        | 1   |         |
|        | C9946    | F1G1C104A116 | C 0.10UF, K, 16V        | 1   |         |
|        | C9947    | F1G1C104A116 | C 0.10UF, K, 16V        | 1   |         |
|        | C9948    | F1G1C104A116 | C 0.10UF, K, 16V        | 1   |         |
|        | C9949    | F1G1C104A116 | C 0.10UF, K, 16V        | 1   |         |
|        | C9950    | F1G1C104A116 | C 0.10UF, K, 16V        | 1   |         |
|        | C9951    | F1G1C104A116 | C 0.10UF, K, 16V        | 1   |         |
|        | C9952    | F1G1C104A116 | C 0.10UF, K, 16V        | 1   |         |
|        | C9953    | F1G1C104A116 | C 0.10UF, K, 16V        | 1   |         |
|        | C9954    | F1G1C104A116 | C 0.10UF, K, 16V        | 1   |         |
|        | C9955    | F1G1C104A116 | C 0.10UF, K, 16V        | 1   |         |
|        | C9956    | F1G1C104A116 | C 0.10UF, K, 16V        | 1   |         |
|        | C9957    | F1G1C104A116 | C 0.10UF, K, 16V        | 1   |         |
|        | C9958    | F1G1C104A116 | C 0.10UF, K, 16V        | 1   |         |
|        | C9959    | F1G1C104A116 | C 0.10UF, K, 16V        | 1   |         |
|        | C9961    | F1J1A106A043 | C 0.010UF, K, 10V       | 1   |         |
|        | C9962    | F1J1A106A043 | C 0.010UF, K, 10V       | 1   |         |
|        | C9965    | F1G1C104A116 | C 0.10UF, K, 16V        | 1   |         |



| Safety | Ref. No. | Part No.     | Part Name & Description | Pcs | Remarks |
|--------|----------|--------------|-------------------------|-----|---------|
|        | C9966    | FLJ1A106A043 | C 0.010UF, K, 10V       | 1   |         |
|        | C9967    | FLG1C104A116 | C 0.10UF, K, 16V        | 1   |         |
|        | C9968    | FLG1C104A116 | C 0.10UF, K, 16V        | 1   |         |
|        | C9970    | FLG1C104A116 | C 0.10UF, K, 16V        | 1   |         |
|        | C9971    | FLG1H180A731 | C 18UF, 50V             | 1   |         |
|        | C9972    | FLG1H180A731 | C 18UF, 50V             | 1   |         |
|        | C9973    | FLG1C104A116 | C 0.10UF, K, 16V        | 1   |         |
|        | C9974    | FLG1C104A116 | C 0.10UF, K, 16V        | 1   |         |
|        | C9975    | FLG1C104A116 | C 0.10UF, K, 16V        | 1   |         |
|        | C9976    | FLG1C104A116 | C 0.10UF, K, 16V        | 1   |         |
|        | C9977    | FLG1C104A116 | C 0.10UF, K, 16V        | 1   |         |
|        | C9978    | FLG1C104A116 | C 0.10UF, K, 16V        | 1   |         |
|        | C9979    | FLG1C104A116 | C 0.10UF, K, 16V        | 1   |         |
|        | C9980    | FLG1C104A116 | C 0.10UF, K, 16V        | 1   |         |
|        | C16002   | FIL2J562A022 | C 5600UF, K,6.3V        | 1   |         |
|        | C16011   | F2A2T251A004 | E 250UF, 220V           | 1   |         |
|        | C16012   | F2A2T251A004 | E 250UF, 220V           | 1   |         |
|        | C16013   | F2A2T251A004 | E 250UF, 220V           | 1   |         |
|        | C16018   | FOC2E155A252 | E 0.015UF, 250V         | 1   |         |
|        | C16022   | FIL2J562A022 | C 5600UF, K,6.3V        | 1   |         |
|        | C16103   | FIH1E470A130 | C 47UF, K, 25V          | 1   | PAVCCZ  |
|        | C16104   | FIH1E470A130 | C 47UF, K, 25V          | 1   | PAVCCZ  |
|        | C16131   | FIL1E4750004 | C 4.7UF, 25V            | 1   |         |
|        | C16133   | FIL1E4750004 | C 4.7UF, 25V            | 1   |         |
|        | C16135   | FK1E105A029  | C 1UF, Z, 25V           | 1   |         |
|        | C16191   | FIL1E4750004 | C 4.7UF, 25V            | 1   |         |
|        | C16192   | FIH1E104A129 | C 0.1UF, 25V            | 1   |         |
|        | C16193   | EEUFC1E470   | E 47UF, 25V             | 1   |         |
|        | C16195   | FIL1E4750004 | C 4.7UF, 25V            | 1   |         |
|        | C16198   | FK2J102A014  | C 1000UF, K,6.3V        | 1   |         |
|        | C16241   | F2A1A101A106 | E 100UF, 10V            | 1   |         |
|        | C16242   | FIH1C105A008 | C 1UF, K, 16V           | 1   |         |
|        | C16243   | FIH1H103A970 | C 0.001UF, K, 50V       | 1   |         |
|        | C16272   | F2A1E471A102 | E 470UF, 25V            | 1   |         |
|        | C16280   | FK1E105A029  | C 1UF, Z, 25V           | 1   |         |
|        | C16285   | FIH1H104A970 | C 0.1UF, K, 50V         | 1   |         |
|        | C16286   | FIH1H104A970 | C 0.1UF, K, 50V         | 1   |         |
|        | C16287   | FIH1H104A970 | C 0.1UF, K, 50V         | 1   |         |
|        | C16310   | F2A2T251A004 | E 250UF, 220V           | 1   |         |
|        | C16315   | FIH1A1050032 | C 10UF, 50V             | 1   |         |
|        | C16316   | FIH1C104A143 | C 0.1UF, K, 16V         | 1   |         |
|        | C16317   | FIH1A1050032 | C 10UF, 50V             | 1   |         |
|        | C16318   | FLJ1H104A835 | C 0.10UF, 50V           | 1   |         |
|        | C16319   | FLJ1H104A835 | C 0.10UF, 50V           | 1   |         |
|        | C16328   | F2A2D201A226 | E 220UF, 200V           | 1   |         |
|        | C16401   | FIL2J562A022 | C 5600UF, K,6.3V        | 1   |         |
|        | C16411   | F2A2T251A004 | E 250UF, 220V           | 1   |         |
|        | C16412   | F2A2T251A004 | E 250UF, 220V           | 1   |         |
|        | C16413   | F2A2T251A004 | E 250UF, 220V           | 1   |         |
|        | C16414   | F2A2T251A004 | E 250UF, 220V           | 1   |         |
|        | C16419   | FOC2E155A252 | E 0.015UF, 250V         | 1   |         |
|        | C16421   | FIL2J562A022 | C 5600UF, K,6.3V        | 1   |         |
|        | C16451   | FIH1H392A970 | C 3900PF, K, 50V        | 1   |         |
|        | C16460   | FIE2J222A002 | C 2200PF, 600V          | 1   |         |
|        | C16462   | FIE2J222A002 | C 2200PF, 600V          | 1   |         |
|        | C16471   | FIL2J1020001 | C 1000UF, K,6.3V        | 1   |         |
|        | C16472   | FK1E105A029  | C 1UF, Z, 25V           | 1   |         |
|        | C16490   | FIH1C105A008 | C 1UF, K, 16V           | 1   |         |
|        | C16491   | FIL2J1020001 | C 1000UF, K,6.3V        | 1   |         |
|        | C16501   | FK1E105A029  | C 1UF, Z, 25V           | 1   |         |
|        | C16502   | FIL1E4750004 | C 4.7UF, 25V            | 1   |         |
|        | C16503   | F2A1E471A102 | E 470UF, 25V            | 1   |         |
|        | C16504   | FIL1E4750004 | C 4.7UF, 25V            | 1   |         |
|        | C16505   | FK1E105A029  | C 1UF, Z, 25V           | 1   |         |
|        | C16521   | FK1E105A029  | C 1UF, Z, 25V           | 1   |         |
|        | C16522   | FIL1E4750004 | C 4.7UF, 25V            | 1   |         |
|        | C16523   | F2A1E471A102 | E 470UF, 25V            | 1   |         |
|        | C16524   | FIL1E4750004 | C 4.7UF, 25V            | 1   |         |
|        | C16525   | FIL1E4750004 | C 4.7UF, 25V            | 1   |         |
|        | C16527   | FIL1E4750004 | C 4.7UF, 25V            | 1   |         |
|        | C16533   | FIH1H104A970 | C 0.1UF, K, 50V         | 1   |         |
|        | C16535   | FIH1H104A970 | C 0.1UF, K, 50V         | 1   |         |

| Safety | Ref. No. | Part No.     | Part Name & Description | Pcs | Remarks |
|--------|----------|--------------|-------------------------|-----|---------|
|        | C16536   | FIH1H104A970 | C 0.1UF, K, 50V         | 1   |         |
|        | C16562   | FIH1C105A008 | C 1UF, K, 16V           | 1   |         |
|        | C16563   | F2A1A101A106 | E 100UF, 10V            | 1   |         |
|        | C16564   | FIH1C105A008 | C 1UF, K, 16V           | 1   |         |
|        | C16565   | FIH1H103A970 | C 0.001UF, K, 50V       | 1   |         |
|        | C16566   | FIH1H103A970 | C 0.001UF, K, 50V       | 1   |         |
|        | C16581   | FK1E105A029  | C 1UF, Z, 25V           | 1   |         |
|        | C16582   | FIL1E4750004 | C 4.7UF, 25V            | 1   |         |
|        | C16593   | FIH1H102A971 | C 1000PF, K, 50V        | 1   |         |
|        | C16602   | FIH1H220A971 | C 22PF, K, 50V          | 1   |         |
|        | C16603   | FK2J102A014  | C 1000UF, K,6.3V        | 1   |         |
|        | C16604   | FK2J102A014  | C 1000UF, K,6.3V        | 1   |         |
|        | C16608   | FIH1H221A971 | C 220UF, K, 50V         | 1   |         |
|        | C16641   | FIE2J332A002 | C 3300PF, 600V          | 1   |         |
|        | C16642   | FIE2J332A002 | C 3300PF, 600V          | 1   |         |
|        | C16661   | FK2J102A014  | C 1000UF, K,6.3V        | 1   |         |
|        | C16662   | FK2J102A014  | C 1000UF, K,6.3V        | 1   |         |
|        | C16664   | FIH1H680A971 | C 68PF, K, 50V          | 1   |         |
|        | C16665   | FIH1H680A971 | C 68PF, K, 50V          | 1   |         |
|        | C16666   | FIH1H680A971 | C 68PF, K, 50V          | 1   |         |
|        | C16675   | FIH1H391A971 | C 391UF, 50V            | 1   |         |
|        | C16684   | FIH1H104A970 | C 0.1UF, K, 50V         | 1   |         |
|        | C16685   | FIH1H104A970 | C 0.1UF, K, 50V         | 1   |         |
|        | C16691   | F2A2C101A169 | E 1000UF, 160V          | 1   |         |
|        | C16707   | FIH1H220A971 | C 22PF, K, 50V          | 1   |         |
|        | C16708   | FIH1H104A970 | C 0.1UF, K, 50V         | 1   |         |
|        | C16721   | F2A1H101A128 | E 100UF, 50V            | 1   |         |
|        | C16723   | FIL1E4750004 | C 4.7UF, 25V            | 1   |         |
|        | C16724   | FIL1E4750004 | C 4.7UF, 25V            | 1   |         |
|        | C16725   | FIL1E4750004 | C 4.7UF, 25V            | 1   |         |
|        | C16753   | FIL1E4750004 | C 4.7UF, 25V            | 1   |         |
|        | C16754   | FIL1E4750004 | C 4.7UF, 25V            | 1   |         |
|        | C16755   | FIL1E4750004 | C 4.7UF, 25V            | 1   |         |
|        | C16756   | FIL1E4750004 | C 4.7UF, 25V            | 1   |         |
|        | C16771   | FIH1C105A008 | C 1UF, K, 16V           | 1   |         |
|        | C16772   | FIL1E4750004 | C 4.7UF, 25V            | 1   |         |
|        | C16773   | FIL1E4750004 | C 4.7UF, 25V            | 1   |         |
|        | C16791   | EEUFC1E221   | E 220UF, 25V            | 1   |         |
|        | C16795   | F2A1E471A102 | E 470UF, 25V            | 1   |         |
|        | C16796   | F2A1E471A102 | E 470UF, 25V            | 1   |         |
|        | C16812   | FIL1E4750004 | C 4.7UF, 25V            | 1   |         |
|        | C16813   | F2A2T221A009 | E 220UF, 220V           | 1   |         |
|        | C16821   | FLJ1H104A835 | C 0.10UF, 50V           | 1   |         |
|        | C16822   | F2A2G470A187 | E 470UF, 400V           | 1   |         |
|        | C16823   | FIL2J562A022 | C 5600UF, K,6.3V        | 1   |         |
|        | C16842   | F2A2C101A169 | E 1000UF, 160V          | 1   |         |
|        | C16843   | FLJ1H104A835 | C 0.10UF, 50V           | 1   |         |
|        | C16844   | FLJ1H104A835 | C 0.10UF, 50V           | 1   |         |
|        | C16856   | FIH1A1050032 | C 10UF, 50V             | 1   |         |
|        | C16857   | FIH1H472A970 | C 4700PF, K, 50V        | 1   |         |
|        | C16858   | FIH1C104A143 | C 0.1UF, K, 16V         | 1   |         |
|        | C16860   | FIH1A1050032 | C 10UF, 50V             | 1   |         |
|        | C16861   | FIH1C104A143 | C 0.1UF, K, 16V         | 1   |         |
|        | C16862   | FIH1A1050032 | C 10UF, 50V             | 1   |         |
|        | C16863   | FLJ1H104A835 | C 0.10UF, 50V           | 1   |         |
|        | C16864   | FLJ1H104A835 | C 0.10UF, 50V           | 1   |         |
|        | C16866   | FIH1A1050032 | C 10UF, 50V             | 1   |         |
|        | C16867   | FIH1A1050032 | C 10UF, 50V             | 1   |         |
|        | C16868   | FIH1A1050032 | C 10UF, 50V             | 1   |         |
|        | C16869   | FLJ1H104A835 | C 0.10UF, 50V           | 1   |         |
|        | C16891   | FK1E105A029  | C 1UF, Z, 25V           | 1   |         |
|        | C17111   | FIH1A1050032 | C 10UF, 50V             | 1   |         |
|        | C17113   | FIL2E154A028 | E 1500UF, 25V           | 1   |         |
|        | C17114   | FIL2E154A028 | E 1500UF, 25V           | 1   |         |
|        | C17121   | FIH1A1050032 | C 10UF, 50V             | 1   |         |
|        | C17123   | FIL2E154A028 | E 1500UF, 25V           | 1   |         |
|        | C17124   | FIL2E154A028 | E 1500UF, 25V           | 1   |         |
|        | C17131   | FIH1A1050032 | C 10UF, 50V             | 1   |         |
|        | C17133   | FIL2E154A028 | E 1500UF, 25V           | 1   |         |
|        | C17134   | FIL2E154A028 | E 1500UF, 25V           | 1   |         |
|        | C17165   | FIH1C104A143 | C 0.1UF, K, 16V         | 1   |         |
|        | C17211   | FIH1A1050032 | C 10UF, 50V             | 1   |         |

| Safety | Ref. No. | Part No.     | Part Name & Description | Pcs | Remarks |
|--------|----------|--------------|-------------------------|-----|---------|
|        | C17213   | F1L2E154A028 | E 1500UF, 25V           | 1   |         |
|        | C17214   | F1L2E154A028 | E 1500UF, 25V           | 1   |         |
|        | C17221   | F1H1A1050032 | C 10UF, 50V             | 1   |         |
|        | C17223   | F1L2E154A028 | E 1500UF, 25V           | 1   |         |
|        | C17224   | F1L2E154A028 | E 1500UF, 25V           | 1   |         |
|        | C17231   | F1H1A1050032 | C 10UF, 50V             | 1   |         |
|        | C17233   | F1L2E154A028 | E 1500UF, 25V           | 1   |         |
|        | C17234   | F1L2E154A028 | E 1500UF, 25V           | 1   |         |
|        | C17241   | F1H1A1050032 | C 10UF, 50V             | 1   |         |
|        | C17243   | F1L2E154A028 | E 1500UF, 25V           | 1   |         |
|        | C17244   | F1L2E154A028 | E 1500UF, 25V           | 1   |         |
|        | C17261   | F1H1A1050032 | C 10UF, 50V             | 1   |         |
|        | C17268   | F1H1A1050032 | C 10UF, 50V             | 1   |         |
|        | C17271   | F1H1C104A143 | C 0.1UF, K, 16V         | 1   |         |
|        | C17272   | F1H1C104A143 | C 0.1UF, K, 16V         | 1   |         |
|        | C17273   | F1H1C104A143 | C 0.1UF, K, 16V         | 1   |         |
|        | C17274   | F1H1C104A143 | C 0.1UF, K, 16V         | 1   |         |
|        | C17275   | F1H1C104A143 | C 0.1UF, K, 16V         | 1   |         |
|        | C17276   | F1H1C104A143 | C 0.1UF, K, 16V         | 1   |         |
|        | C17277   | F1H1C104A143 | C 0.1UF, K, 16V         | 1   |         |
|        | C17278   | F1H1C104A143 | C 0.1UF, K, 16V         | 1   |         |
|        | C17311   | F1H1A1050032 | C 10UF, 50V             | 1   |         |
|        | C17312   | F1H1C104A143 | C 0.1UF, K, 16V         | 1   |         |
|        | C17313   | F1L2E154A028 | E 1500UF, 25V           | 1   |         |
|        | C17314   | F1L2E154A028 | E 1500UF, 25V           | 1   |         |
|        | C17321   | F1H1A1050032 | C 10UF, 50V             | 1   |         |
|        | C17322   | F1H1C104A143 | C 0.1UF, K, 16V         | 1   |         |
|        | C17323   | F1L2E154A028 | E 1500UF, 25V           | 1   |         |
|        | C17324   | F1L2E154A028 | E 1500UF, 25V           | 1   |         |
|        | C17331   | F1H1A1050032 | C 10UF, 50V             | 1   |         |
|        | C17332   | F1H1C104A143 | C 0.1UF, K, 16V         | 1   |         |
|        | C17333   | F1L2E154A028 | E 1500UF, 25V           | 1   |         |
|        | C17334   | F1L2E154A028 | E 1500UF, 25V           | 1   |         |
|        | C17341   | F1H1A1050032 | C 10UF, 50V             | 1   |         |
|        | C17342   | F1H1C104A143 | C 0.1UF, K, 16V         | 1   |         |
|        | C17343   | F1L2E154A028 | E 1500UF, 25V           | 1   |         |
|        | C17344   | F1L2E154A028 | E 1500UF, 25V           | 1   |         |
|        | C17352   | F1H1C104A143 | C 0.1UF, K, 16V         | 1   |         |
|        | C17362   | F1H1C104A143 | C 0.1UF, K, 16V         | 1   |         |
|        | C17390   | F1K2A105A006 | C 1UF, 100V             | 1   |         |
|        | C17396   | F1H1A1050032 | C 10UF, 50V             | 1   |         |
|        | C17397   | F1H1C104A143 | C 0.1UF, K, 16V         | 1   |         |
|        |          |              |                         |     |         |
|        | CB1      | K1MY55B00001 | 55P CONNECTOR           | 1   | PAVCCZ  |
|        | CB2      | K1MY55B00001 | 55P CONNECTOR           | 1   | PAVCCZ  |
|        | CB3      | K1MY55B00001 | 55P CONNECTOR           | 1   | PAVCCZ  |
|        | CB4      | K1MY55B00001 | 55P CONNECTOR           | 1   | PAVCCZ  |
|        | CB5      | K1MY55B00001 | 55P CONNECTOR           | 1   | PAVCCZ  |
|        | CB6      | K1MY55B00001 | 55P CONNECTOR           | 1   | PAVCCZ  |
|        | CB7      | K1MY55B00001 | 55P CONNECTOR           | 1   | PAVCCZ  |
|        | CB8      | K1MY55B00001 | 55P CONNECTOR           | 1   | PAVCCZ  |
|        | CB9      | K1MY55B00001 | 55P CONNECTOR           | 1   | PAVCCZ  |
|        | CB10     | K1MY55B00001 | 55P CONNECTOR           | 1   | PAVCCZ  |
|        | CB11     | K1MY55B00001 | 55P CONNECTOR           | 1   | PAVCCZ  |
|        |          |              |                         |     |         |
|        | CN0100   | K1KA11AA0715 | 11P CONNECTOR           | 1   |         |
|        | CN0101   | K1KA20AA0009 | 20P CONNECTOR           | 1   |         |
|        | CN0102   | K1KA04AA0104 | 4P CONNECTOR            | 1   |         |
|        |          |              |                         |     |         |
|        | D1107    | MA3X704A0L   | ZENER DIODE             | 1   |         |
|        | D1112    | MA2J72800L   | ZENER DIODE             | 1   |         |
|        | D2014    | MA2J11100L   | DIODE                   | 1   |         |
|        | D2017    | MA2J11100L   | DIODE                   | 1   |         |
|        | D2512    | MAZ80560ML   | ZENER DIODE             | 1   |         |
|        | D2520    | B3AGB0000057 | LED                     | 1   | PAVCCZ  |
|        | D2524    | MAZ80560ML   | ZENER DIODE             | 1   |         |
|        | D2525    | B3ACB0000225 | LED                     | 1   | PAVCCZ  |
|        | D2526    | MAZ80560ML   | ZENER DIODE             | 1   |         |
|        | D2530    | MAZ80560ML   | ZENER DIODE             | 1   |         |
|        | D2870    | B0JCME000037 | DIODE                   | 1   |         |
|        | D2871    | MA8120M      | ZENER DIODE             | 1   |         |
|        | D3013    | MAZ81400ML   | ZENER DIODE             | 1   |         |
|        | D3014    | MAZ81400ML   | ZENER DIODE             | 1   |         |

| Safety | Ref. No. | Part No.     | Part Name & Description | Pcs | Remarks |
|--------|----------|--------------|-------------------------|-----|---------|
|        | D3015    | K7AAAY000003 | PHOTO LINK              | 1   |         |
|        | D3048    | MA3X704A0L   | ZENER DIODE             | 1   |         |
|        | D3054    | EZJP0V080GA  | VARISTOR                | 1   |         |
|        | D3201    | EZJP0V080GA  | VARISTOR                | 1   |         |
|        | D3339    | MA3X704A0L   | ZENER DIODE             | 1   |         |
|        | D4503    | EZAEG2A50AX  | DIODE                   | 1   |         |
|        | D4505    | EZAEG2A50AX  | DIODE                   | 1   |         |
|        | D4507    | EZAEG2A50AX  | DIODE                   | 1   |         |
|        | D4509    | EZAEG2A50AX  | DIODE                   | 1   |         |
|        | D4511    | EZAEG2A50AX  | DIODE                   | 1   |         |
|        | D4512    | EZAEG2A50AX  | DIODE                   | 1   |         |
|        | D4513    | B0BC5R6A0275 | DIODE                   | 1   |         |
|        | D4516    | EZAEG2A50AX  | DIODE                   | 1   |         |
|        | D4517    | EZAEG2A50AX  | DIODE                   | 1   |         |
|        | D4518    | EZAEG2A50AX  | DIODE                   | 1   |         |
|        | D4520    | EZAEG2A50AX  | DIODE                   | 1   |         |
|        | D4521    | EZAEG2A50AX  | DIODE                   | 1   |         |
|        | D4523    | EZAEG2A50AX  | DIODE                   | 1   |         |
|        | D4525    | MA2J11100L   | DIODE                   | 1   |         |
|        | D4526    | MA2J11100L   | DIODE                   | 1   |         |
|        | D4541    | MA2J11100L   | DIODE                   | 1   |         |
|        | D4542    | MA2J11100L   | DIODE                   | 1   |         |
|        | D4573    | EZAEG2A50AX  | DIODE                   | 1   |         |
|        | D4574    | EZAEG2A50AX  | DIODE                   | 1   |         |
|        | D4575    | MA2J11100L   | DIODE                   | 1   |         |
|        | D4576    | B0HCMM000014 | DIODE                   | 1   |         |
|        | D4577    | B0HCMM000014 | DIODE                   | 1   |         |
|        | D4583    | B0HCMM000014 | DIODE                   | 1   |         |
|        | D4587    | EZAEG2A50AX  | DIODE                   | 1   |         |
|        | D4588    | EZAEG2A50AX  | DIODE                   | 1   |         |
|        | D4589    | EZAEG2A50AX  | DIODE                   | 1   |         |
|        | D4590    | EZAEG2A50AX  | DIODE                   | 1   |         |
|        | D4591    | EZAEG2A50AX  | DIODE                   | 1   |         |
|        | D4592    | EZAEG2A50AX  | DIODE                   | 1   |         |
|        | D4593    | EZAEG2A50AX  | DIODE                   | 1   |         |
|        | D4594    | EZAEG2A50AX  | DIODE                   | 1   |         |
|        | D4595    | EZAEG2A50AX  | DIODE                   | 1   |         |
|        | D4596    | EZAEG2A50AX  | DIODE                   | 1   |         |
|        | D4597    | EZAEG2A50AX  | DIODE                   | 1   |         |
|        | D4598    | EZAEG2A50AX  | DIODE                   | 1   |         |
|        | D4599    | EZAEG2A50AX  | DIODE                   | 1   |         |
|        | D4600    | EZAEG2A50AX  | DIODE                   | 1   |         |
|        | D4601    | EZAEG2A50AX  | DIODE                   | 1   |         |
|        | D4602    | EZAEG2A50AX  | DIODE                   | 1   |         |
|        | D4611    | B0BC5R6A0275 | DIODE                   | 1   |         |
|        | D4615    | MA2J11100L   | DIODE                   | 1   |         |
|        | D4617    | B0BC5R6A0275 | DIODE                   | 1   |         |
|        | D5481    | B0HCMM000014 | DIODE                   | 1   |         |
|        | D5482    | B0HCMM000014 | DIODE                   | 1   |         |
|        | D5483    | MA3X78900L   | ZENER DIODE             | 1   |         |
|        | D5485    | B0BC03900015 | ZENER DIODE             | 1   |         |
|        | D5600    | B0BC4R700007 | ZENER DIODE             | 1   |         |
|        | D5603    | B0BC6R600005 | ZENER DIODE             | 1   |         |
|        | D5607    | B0BC4R700007 | ZENER DIODE             | 1   |         |
|        | D5608    | B0BC4R700007 | ZENER DIODE             | 1   |         |
|        | D5612    | MAZ80560LL   | ZENER DIODE             | 1   |         |
|        | D5620    | B0BC01100001 | ZENER DIODE             | 1   |         |
|        | D5621    | MA3X152D0L   | DIODE                   | 1   |         |
|        | D5622    | MA3X152D0L   | DIODE                   | 1   |         |
|        | D9000    | B0JCCE000008 | DIODE                   | 1   |         |
|        | D9110    | B0JCGD000002 | DIODE                   | 1   |         |
|        | D16001   | B0FBCN000005 | DIODE                   | 1   |         |
|        | D16021   | B0FBCN000008 | DIODE                   | 1   |         |
|        | D16101   | MA22D3900L   | DIODE                   | 1   |         |
|        | D16131   | B0ECKP000047 | DIODE                   | 1   |         |
|        | D16191   | B0ECKP000047 | DIODE                   | 1   |         |
|        | D16192   | MA2J11100L   | DIODE                   | 1   |         |
|        | D16193   | B0ECKP000047 | DIODE                   | 1   |         |
|        | D16194   | B0ECKP000047 | DIODE                   | 1   |         |
|        | D16195   | B0ECKP000047 | DIODE                   | 1   |         |
|        | D16280   | MA2J11100L   | DIODE                   | 1   |         |
|        | D16281   | MAZ80510LL   | ZENER DIODE             | 1   |         |
|        | D16282   | MAZ80680ML   | ZENER DIODE             | 1   |         |

| Safety | Ref. No. | Part No.     | Part Name & Description | Pcs | Remarks |
|--------|----------|--------------|-------------------------|-----|---------|
|        | D16285   | MA3X152D0L   | DIODE                   | 1   |         |
|        | D16286   | MA2J11100L   | DIODE                   | 1   |         |
|        | D16315   | MAZ81500ML   | ZENER DIODE             | 1   |         |
|        | D16316   | BOECKP000047 | DIODE                   | 1   |         |
|        | D16317   | BOECKP000047 | DIODE                   | 1   |         |
|        | D16401   | BOFACQ000001 | DIODE                   | 1   |         |
|        | D16407   | MA22D3900L   | DIODE                   | 1   |         |
|        | D16411   | MA2J11100L   | DIODE                   | 1   |         |
|        | D16421   | MA3DF40000LW | ZENER DIODE             | 1   |         |
|        | D16441   | BOECHR000001 | DIODE                   | 1   |         |
|        | D16451   | BOECKP000047 | DIODE                   | 1   |         |
|        | D16461   | MA3DF46000LW | ZENER DIODE             | 1   |         |
|        | D16462   | MA3DF46000LW | ZENER DIODE             | 1   |         |
|        | D16473   | MA3X152D0L   | DIODE                   | 1   |         |
|        | D16474   | MA2J11100L   | DIODE                   | 1   |         |
|        | D16475   | MAZ80510LL   | ZENER DIODE             | 1   |         |
|        | D16476   | MA2J11100L   | DIODE                   | 1   |         |
|        | D16478   | BOHCKS000002 | DIODE                   | 1   |         |
|        | D16480   | MA2J11100L   | DIODE                   | 1   |         |
|        | D16481   | BOFACQ000002 | DIODE                   | 1   |         |
|        | D16482   | BOFACQ000002 | DIODE                   | 1   |         |
|        | D16490   | BOECKP000047 | DIODE                   | 1   |         |
|        | D16491   | MA2J11100L   | DIODE                   | 1   |         |
|        | D16492   | MAZ80470ML   | ZENER DIODE             | 1   |         |
|        | D16493   | MA3X152E0L   | ZENER DIODE             | 1   |         |
|        | D16503   | BOHCKS000002 | DIODE                   | 1   |         |
|        | D16522   | BOECKP000047 | DIODE                   | 1   |         |
|        | D16524   | BOECKP000047 | DIODE                   | 1   |         |
|        | D16534   | BOECKP000047 | DIODE                   | 1   |         |
|        | D16536   | BOHCKS000002 | DIODE                   | 1   |         |
|        | D16583   | B3ABB0000210 | LED                     | 1   |         |
|        | D16602   | MAZ81500ML   | ZENER DIODE             | 1   |         |
|        | D16604   | MA3X152E0L   | ZENER DIODE             | 1   |         |
|        | D16605   | MAZ80510LL   | ZENER DIODE             | 1   |         |
|        | D16606   | BOECKM000038 | DIODE                   | 1   |         |
|        | D16607   | MA2J11100L   | DIODE                   | 1   |         |
|        | D16608   | MA8120M      | ZENER DIODE             | 1   |         |
|        | D16610   | MA2J11100L   | DIODE                   | 1   |         |
|        | D16615   | MA2J11100L   | DIODE                   | 1   |         |
|        | D16616   | MA3X152E0L   | ZENER DIODE             | 1   |         |
|        | D16618   | BOECKP000047 | DIODE                   | 1   |         |
|        | D16619   | BOECKP000047 | DIODE                   | 1   |         |
|        | D16620   | BOECKP000047 | DIODE                   | 1   |         |
|        | D16621   | MA3DF25000RP | ZENER DIODE             | 1   |         |
|        | D16622   | MA3DF25000RP | ZENER DIODE             | 1   |         |
|        | D16624   | BOECKP000047 | DIODE                   | 1   |         |
|        | D16625   | MAZ82000ML   | ZENER DIODE             | 1   |         |
|        | D16641   | BOFBCN000006 | DIODE                   | 1   |         |
|        | D16642   | BOFBCN000006 | DIODE                   | 1   |         |
|        | D16662   | MAZ83300ML   | ZENER DIODE             | 1   |         |
|        | D16663   | MAZ83300ML   | ZENER DIODE             | 1   |         |
|        | D16664   | MAZ83300ML   | ZENER DIODE             | 1   |         |
|        | D16670   | BOECHR000001 | DIODE                   | 1   |         |
|        | D16671   | MA2J11100L   | DIODE                   | 1   |         |
|        | D16672   | BOECHR000001 | DIODE                   | 1   |         |
|        | D16678   | MAZ81500ML   | ZENER DIODE             | 1   |         |
|        | D16679   | BOECKP000047 | DIODE                   | 1   |         |
|        | D16702   | MA2J11100L   | DIODE                   | 1   |         |
|        | D16710   | MAZ815000L   | ZENER DIODE             | 1   |         |
|        | D16711   | BOECHR000001 | DIODE                   | 1   |         |
|        | D16712   | MAZ815000L   | ZENER DIODE             | 1   |         |
|        | D16713   | BOECHR000001 | DIODE                   | 1   |         |
|        | D16714   | MAZ815000L   | ZENER DIODE             | 1   |         |
|        | D16715   | BOECHR000001 | DIODE                   | 1   |         |
|        | D16717   | MAZ83300ML   | ZENER DIODE             | 1   |         |
|        | D16719   | BOECKP000047 | DIODE                   | 1   |         |
|        | D16720   | BOECKP000047 | DIODE                   | 1   |         |
|        | D16721   | BOHCKS000002 | DIODE                   | 1   |         |
|        | D16722   | MA3DF30000LW | ZENER DIODE             | 1   |         |
|        | D16724   | BOFBCN000005 | DIODE                   | 1   |         |
|        | D16725   | MA2J11100L   | DIODE                   | 1   |         |
|        | D16765   | BOHCKS000002 | DIODE                   | 1   |         |
|        | D16791   | MAZ82000ML   | ZENER DIODE             | 1   |         |

| Safety | Ref. No. | Part No.     | Part Name & Description | Pcs | Remarks |
|--------|----------|--------------|-------------------------|-----|---------|
|        | D16816   | MA8120M      | ZENER DIODE             | 1   |         |
|        | D16817   | MA8120M      | ZENER DIODE             | 1   |         |
|        | D16820   | MA3X152E0L   | ZENER DIODE             | 1   |         |
|        | D16821   | MAZ83600ML   | ZENER DIODE             | 1   |         |
|        | D16824   | MAZ83300ML   | ZENER DIODE             | 1   |         |
|        | D16825   | MAZ83300ML   | ZENER DIODE             | 1   |         |
|        | D16859   | BOHCKS000002 | DIODE                   | 1   |         |
|        | D16860   | BOHCKS000002 | DIODE                   | 1   |         |
|        | D16865   | BOECKP000047 | DIODE                   | 1   |         |
|        | D16871   | MAZ82000ML   | ZENER DIODE             | 1   |         |
|        | D16874   | MAZ80510LL   | ZENER DIODE             | 1   |         |
|        | D16875   | MA2J11100L   | DIODE                   | 1   |         |
|        | D16901   | MA3X152E0L   | ZENER DIODE             | 1   |         |
|        | D16920   | MA3X152E0L   | ZENER DIODE             | 1   |         |
|        | FL3001   | JOHABB000003 | LC FILTER               | 1   |         |
|        | FL3002   | JOHABB000003 | LC FILTER               | 1   |         |
|        | FL3003   | JOHABB000004 | LC FILTER               | 1   |         |
|        | FL3004   | JOHABB000004 | LC FILTER               | 1   |         |
|        | FL3005   | JOHABB000004 | LC FILTER               | 1   |         |
|        | FL9803   | FIJ1E104A148 | C 0.10UF, Z, 25V        | 1   |         |
|        | FL9805   | FIJ1E104A148 | C 0.10UF, Z, 25V        | 1   |         |
|        | FL9806   | FIJ1E104A148 | C 0.10UF, Z, 25V        | 1   |         |
|        | GK1      | K1KA02BA0061 | 2P CONNECTOR            | 1   |         |
|        | IC1000   | C1ZBZ0003775 | IC                      | 1   |         |
|        | IC1100   | MNZSFH9GP83  | IC                      | 1   | PAVCCZ  |
|        | IC1101   | TVRQ387      | IC                      | 1   | PAVCCZ  |
|        | IC2008   | C0DBGYY00578 | IC                      | 1   |         |
|        | IC2301   | C1AB00002875 | IC                      | 1   |         |
|        | IC2801   | C0DBAYY00462 | IC                      | 1   | PAVCCZ  |
|        | IC2960   | C0DBGHF00001 | IC                      | 1   |         |
|        | IC3001   | C1AB00002855 | IC                      | 1   |         |
|        | IC3003   | C0DBGYY00281 | IC                      | 1   |         |
|        | IC4510   | C1AB00003045 | IC                      | 1   | PAVCCZ  |
|        | IC4511   | C0DBGYY00578 | IC                      | 1   |         |
|        | IC4512   | C0CBCAG00039 | IC                      | 1   |         |
|        | IC4513   | C0DBGYY00618 | IC                      | 1   |         |
|        | IC5401   | C0CBZZE00001 | IC                      | 1   |         |
|        | IC5470   | C0EBM0000026 | IC                      | 1   |         |
|        | IC5480   | C1ZBZ0003972 | IC                      | 1   |         |
|        | IC5600   | C0DBAYY00480 | IC                      | 1   |         |
|        | IC5601   | C0DBAYY00480 | IC                      | 1   |         |
|        | IC8001   | MN2WS0059    | IC                      | 1   | PAVCCZ  |
|        | IC8002   | C3ABSY000036 | IC                      | 1   |         |
|        | IC8003   | C3ABSY000036 | IC                      | 1   |         |
|        | IC8004   | C0ZBZ0001567 | IC                      | 1   |         |
|        | IC8301   | C1AB00003049 | IC                      | 1   | PAVCCZ  |
|        | IC8302   | C0DBFY000028 | IC                      | 1   | PAVCCZ  |
|        | IC8401   | C1AB00002913 | IC                      | 1   | PAVCCZ  |
|        | IC8403   | C0ZBZ0001584 | IC                      | 1   | PAVCCZ  |
|        | IC8404   | C0JBAZ001120 | IC                      | 1   |         |
|        | IC8405   | C0JBAZ001120 | IC                      | 1   |         |
|        | IC8408   | C0JBAU000025 | IC                      | 1   | PAVCCZ  |
|        | IC8409   | C0JBAZ002811 | IC                      | 1   |         |
|        | IC8410   | C0JBAU000025 | IC                      | 1   | PAVCCZ  |
|        | IC8411   | C0JBAU000025 | IC                      | 1   | PAVCCZ  |
|        | IC8502   | TVRQ399      | IC                      | 1   | PAVCCZ  |
|        | IC8580   | TVRQ370      | IC                      | 1   | PAVCCZ  |
|        | IC9001   | TVRQ455      | IC                      | 1   | PAVCCZ  |
|        | IC9003   | MNZSFH8KPH2  | IC                      | 1   |         |
|        | IC9004   | C1ZBZ0003983 | IC                      | 1   |         |
|        | IC9303   | TVRQ382      | IC                      | 1   | PAVCCZ  |
|        | IC9500   | C1ZBZ0003760 | IC                      | 1   |         |
|        | IC9805   | C0DBAYY00477 | IC                      | 1   |         |
|        | IC9806   | C0DBAYY00477 | IC                      | 1   |         |
|        | IC9807   | C0DBEHG00006 | IC                      | 1   |         |
|        | IC9808   | C0CBCAC00365 | IC                      | 1   |         |
|        | IC9900   | MN84526      | IC                      | 1   |         |
|        | IC9901   | C3ABQY000032 | IC                      | 1   |         |
|        | IC16131  | C0ZBZ0000895 | IC                      | 1   |         |
|        | IC16241  | C0JBAZ002811 | IC                      | 1   |         |



| Safety | Ref. No. | Part No.     | Part Name & Description | Pcs | Remarks |
|--------|----------|--------------|-------------------------|-----|---------|
|        | IC16304  | MIP3900MSSCF | IC                      | 1   |         |
|        | IC16312  | C0DBZMC00006 | IC                      | 1   |         |
|        | IC16464  | C0JBAB000715 | IC                      | 1   |         |
|        | IC16465  | C0JBAB000715 | IC                      | 1   |         |
|        | IC16471  | C0DBEKA00003 | IC                      | 1   |         |
|        | IC16490  | C0DBZMC00006 | IC                      | 1   |         |
|        | IC16491  | NJM2406F     | LINEAR IC               | 1   |         |
|        | IC16501  | C0ZBZ0001324 | IC                      | 1   |         |
|        | IC16521  | C0ZBZ0001324 | IC                      | 1   |         |
|        | IC16561  | C0JBAZ001120 | IC                      | 1   |         |
|        | IC16562  | C0JBAZ001120 | IC                      | 1   |         |
|        | IC16563  | C0JBAC000363 | IC                      | 1   |         |
|        | IC16581  | C0BBBA000024 | IC                      | 1   |         |
|        | IC16661  | C0BBBA000024 | IC                      | 1   |         |
|        | IC16692  | C0DBZMC00006 | IC                      | 1   |         |
|        | IC16724  | C0CBADC00072 | IC                      | 1   |         |
|        | IC16725  | C0CBADC00072 | IC                      | 1   |         |
|        | IC16771  | C0CBADC00072 | IC                      | 1   |         |
|        | IC16773  | C0JBAB000715 | IC                      | 1   |         |
|        | IC16784  | MIP9L02MBS   | IC                      | 1   |         |
|        | IC16786  | MIP3900MSSCF | IC                      | 1   |         |
|        | IC16787  | C0DBZMC00006 | IC                      | 1   |         |
|        | IC16788  | MIP3900MSSCF | IC                      | 1   |         |
|        | IC16789  | C0DBZMC00006 | IC                      | 1   |         |
|        | IC16791  | EHMDD9920    | LINEAR IC               | 1   |         |
|        | IC17101  | C0JBAZ001120 | IC                      | 1   |         |
|        | IC17201  | C0JBAZ001120 | IC                      | 1   |         |
|        | IC17202  | C0JBAZ001120 | IC                      | 1   |         |
|        | IC17203  | C0JBAZ001120 | IC                      | 1   |         |
|        | IC17204  | C0JBAZ001120 | IC                      | 1   |         |
|        | IC17205  | C0JBAZ001120 | IC                      | 1   |         |
|        | IC17206  | C0JBAZ001120 | IC                      | 1   |         |
|        | IC17207  | C0JBAZ001120 | IC                      | 1   |         |
|        | IC17208  | C0JBAZ001120 | IC                      | 1   |         |
|        | IC17301  | C0JBAZ001120 | IC                      | 1   |         |
|        | IC17302  | C0JBAZ001120 | IC                      | 1   |         |
|        | IC17303  | C0JBAZ001120 | IC                      | 1   |         |
|        | IC17304  | C0JBAZ001120 | IC                      | 1   |         |
|        | IC17305  | C0JBAZ001120 | IC                      | 1   |         |
|        | IC17306  | C0JBAZ001120 | IC                      | 1   |         |
|        | IC17307  | C0JBAZ001120 | IC                      | 1   |         |
|        |          |              |                         |     |         |
|        | JK3001   | K1FY115B0021 | CONNECTOR               | 1   | PAVCCZ  |
|        | JK3002A  | K1FY121A0008 | CONNECTOR               | 1   | PAVCCZ  |
|        | JK3003A  | K1FY121A0008 | CONNECTOR               | 1   | PAVCCZ  |
|        | JK3100A  | K2HA7YYA0004 | TERMINAL                | 1   | PAVCCZ  |
|        | JK3107A  | K4AK17B00004 | TERMINAL                | 1   | PAVCCZ  |
|        | JK4500   | K1FY119D0006 | CONNECTOR               | 1   |         |
|        | JK4501   | K1FY119D0006 | CONNECTOR               | 1   |         |
|        | JK4502   | K1FY119E0005 | CONNECTOR               | 1   |         |
|        | JK8302   | K1NA09E00080 | 9P CONNECTOR            | 1   |         |
|        | JK8401   | K1NA68B00051 | 68P CONNECTOR           | 1   | PAVCCZ  |
|        |          |              |                         |     |         |
|        | K1       | K1KA11B00092 | 11P CONNECTOR           | 1   |         |
|        |          |              |                         |     |         |
|        | L1100    | J0JYC0000068 | CHIP INDUCTOR           | 1   |         |
|        | L2001    | G1C150KA0038 | INDUCTION COIL          | 1   |         |
|        | L2010    | G1C220MA0291 | INDUCTION COIL          | 1   |         |
|        | L2012    | G1C220MA0291 | INDUCTION COIL          | 1   |         |
|        | L2014    | G1C220MA0291 | INDUCTION COIL          | 1   |         |
|        | L2016    | G1C220MA0291 | INDUCTION COIL          | 1   |         |
|        | L2018    | J0JHC0000042 | CHIP INDUCTOR           | 1   |         |
|        | L2023    | G1C3R0ZA0156 | INDUCTION COIL          | 1   |         |
|        | L2032    | J0JYC0000068 | CHIP INDUCTOR           | 1   |         |
|        | L2870    | G1C101M00029 | INDUCTION COIL          | 1   |         |
|        | L2901    | J0JCC0000278 | CHIP INDUCTOR           | 1   |         |
|        | L2902    | J0JCC0000269 | CHIP INDUCTOR           | 1   |         |
|        | L2904    | J0JCC0000269 | CHIP INDUCTOR           | 1   |         |
|        | L3002    | J0JCC0000287 | CHIP INDUCTOR           | 1   | PAVCCZ  |
|        | L3003    | J0JCC0000287 | CHIP INDUCTOR           | 1   | PAVCCZ  |
|        | L3004    | J0JCC0000287 | CHIP INDUCTOR           | 1   | PAVCCZ  |
|        | L3005    | J0JCC0000287 | CHIP INDUCTOR           | 1   | PAVCCZ  |
|        | L3006    | J0JCC0000287 | CHIP INDUCTOR           | 1   | PAVCCZ  |

| Safety | Ref. No. | Part No.     | Part Name & Description | Pcs | Remarks |
|--------|----------|--------------|-------------------------|-----|---------|
|        | L3007    | J0JCC0000287 | CHIP INDUCTOR           | 1   | PAVCCZ  |
|        | L3008    | J0JCC0000287 | CHIP INDUCTOR           | 1   | PAVCCZ  |
|        | L3009    | J0JCC0000287 | CHIP INDUCTOR           | 1   | PAVCCZ  |
|        | L3010    | J0JCC0000287 | CHIP INDUCTOR           | 1   | PAVCCZ  |
|        | L3011    | J0JCC0000287 | CHIP INDUCTOR           | 1   | PAVCCZ  |
|        | L3014    | J0JCC0000287 | CHIP INDUCTOR           | 1   | PAVCCZ  |
|        | L3015    | J0JCC0000287 | CHIP INDUCTOR           | 1   | PAVCCZ  |
|        | L3017    | J0JCC0000287 | CHIP INDUCTOR           | 1   | PAVCCZ  |
|        | L3018    | J0JCC0000287 | CHIP INDUCTOR           | 1   | PAVCCZ  |
|        | L3026    | J0JCC0000287 | CHIP INDUCTOR           | 1   | PAVCCZ  |
|        | L3027    | J0JCC0000287 | CHIP INDUCTOR           | 1   | PAVCCZ  |
|        | L3028    | J0JCC0000287 | CHIP INDUCTOR           | 1   | PAVCCZ  |
|        | L3029    | J0JCC0000287 | CHIP INDUCTOR           | 1   | PAVCCZ  |
|        | L3030    | J0JCC0000287 | CHIP INDUCTOR           | 1   | PAVCCZ  |
|        | L3034    | J0JCC0000364 | CHIP INDUCTOR           | 1   |         |
|        | L3035    | J0JCC0000364 | CHIP INDUCTOR           | 1   |         |
|        | L4502    | J0JYC0000068 | CHIP INDUCTOR           | 1   |         |
|        | L4503    | J0JYC0000068 | CHIP INDUCTOR           | 1   |         |
|        | L4504    | J0JYC0000068 | CHIP INDUCTOR           | 1   |         |
|        | L4505    | J0JYC0000068 | CHIP INDUCTOR           | 1   |         |
|        | L4506    | J0JYC0000068 | CHIP INDUCTOR           | 1   |         |
|        | L4507    | J0JYC0000068 | CHIP INDUCTOR           | 1   |         |
|        | L4511    | J0JYC0000068 | CHIP INDUCTOR           | 1   |         |
|        | L4512    | J0JCC0000059 | CHIP INDUCTOR           | 1   |         |
|        | L4513    | J0JCC0000059 | CHIP INDUCTOR           | 1   |         |
|        | L4514    | J0JYC0000068 | CHIP INDUCTOR           | 1   |         |
|        | L4515    | J0JYC0000068 | CHIP INDUCTOR           | 1   |         |
|        | L4516    | J0JYC0000068 | CHIP INDUCTOR           | 1   |         |
|        | L4517    | J0JYC0000068 | CHIP INDUCTOR           | 1   |         |
|        | L4518    | J0JYC0000068 | CHIP INDUCTOR           | 1   |         |
|        | L4519    | J0JYC0000068 | CHIP INDUCTOR           | 1   |         |
|        | L4521    | J0JYC0000068 | CHIP INDUCTOR           | 1   |         |
|        | L4522    | J0JYC0000068 | CHIP INDUCTOR           | 1   |         |
|        | L4523    | J0JYC0000068 | CHIP INDUCTOR           | 1   |         |
|        | L5480    | J0JYC0000068 | CHIP INDUCTOR           | 1   |         |
|        | L5481    | G1C100MA0072 | INDUCTION COIL          | 1   |         |
|        | L5544    | G1C470MA0291 | INDUCTION COIL          | 1   |         |
|        | L5600    | G1C2R2Z00007 | INDUCTION COIL          | 1   |         |
|        | L5601    | G1C3R3Z00004 | INDUCTION COIL          | 1   |         |
|        | L5602    | G1C4R7Z00014 | INDUCTION COIL          | 1   |         |
|        | L5603    | G1C6R8Z00008 | INDUCTION COIL          | 1   |         |
|        | L5604    | G1C100MA0203 | INDUCTION COIL          | 1   |         |
|        | L5605    | J0JHC0000075 | CHIP INDUCTOR           | 1   |         |
|        | L5606    | G1C100MA0203 | INDUCTION COIL          | 1   |         |
|        | L8001    | J0JHC0000045 | CHIP INDUCTOR           | 1   |         |
|        | L8002    | J0JHC0000045 | CHIP INDUCTOR           | 1   |         |
|        | L8003    | J0JHC0000045 | CHIP INDUCTOR           | 1   |         |
|        | L8004    | J0JHC0000045 | CHIP INDUCTOR           | 1   |         |
|        | L8005    | J0JHC0000045 | CHIP INDUCTOR           | 1   |         |
|        | L8007    | J0JHC0000045 | CHIP INDUCTOR           | 1   |         |
|        | L8008    | J0JHC0000045 | CHIP INDUCTOR           | 1   |         |
|        | L8009    | J0JHC0000045 | CHIP INDUCTOR           | 1   |         |
|        | L8010    | J0JHC0000045 | CHIP INDUCTOR           | 1   |         |
|        | L8011    | J0JHC0000045 | CHIP INDUCTOR           | 1   |         |
|        | L8012    | J0JHC0000045 | CHIP INDUCTOR           | 1   |         |
|        | L8013    | J0JHC0000045 | CHIP INDUCTOR           | 1   |         |
|        | L8301    | J0JHC0000045 | CHIP INDUCTOR           | 1   |         |
|        | L8303    | G1CR15JA0020 | INDUCTION COIL          | 1   | PAVCCZ  |
|        | L8304    | J0JHC0000045 | CHIP INDUCTOR           | 1   |         |
|        | L8501    | J0JHC0000045 | CHIP INDUCTOR           | 1   |         |
|        | L8580    | J0JHC0000075 | CHIP INDUCTOR           | 1   |         |
|        | L9001    | G1C3R3Z00004 | INDUCTION COIL          | 1   |         |
|        | L9802    | G1C6R8Z00008 | INDUCTION COIL          | 1   |         |
|        | L9900    | J0JHC0000117 | CHIP INDUCTOR           | 1   |         |
|        | L9901    | J0JHC0000117 | CHIP INDUCTOR           | 1   |         |
|        | L9903    | J0JHC0000117 | CHIP INDUCTOR           | 1   |         |
|        | L16011   | G0C1R6KA0206 | PEAKING COIL            | 1   | PAVCCZ  |
|        | L16012   | G0C1R6KA0206 | PEAKING COIL            | 1   | PAVCCZ  |
|        | L16013   | G0C1R6KA0206 | PEAKING COIL            | 1   | PAVCCZ  |
|        | L16014   | G0C1R6KA0206 | PEAKING COIL            | 1   | PAVCCZ  |
|        | L16103   | G0ZZ00002183 | PEAKING COIL            | 1   |         |
|        | L16222   | G0ZZ00002183 | PEAKING COIL            | 1   |         |
|        | L16271   | G0ZZ00002183 | PEAKING COIL            | 1   |         |

| Safety | Ref. No. | Part No.     | Part Name & Description | Pcs | Remarks |
|--------|----------|--------------|-------------------------|-----|---------|
|        | L16303   | G0C471KA0167 | PEAKING COIL            | 1   |         |
|        | L16401   | ELC13P1R9    | CHOKE COIL              | 1   |         |
|        | L16402   | ELC13P1R9    | CHOKE COIL              | 1   |         |
|        | L16403   | ELC13P1R9    | CHOKE COIL              | 1   |         |
|        | L16404   | ELC13P1R9    | CHOKE COIL              | 1   |         |
|        | L16411   | ELC13P1R9    | CHOKE COIL              | 1   |         |
|        | L16412   | ELC13P1R9    | CHOKE COIL              | 1   |         |
|        | L16413   | ELC13P1R9    | CHOKE COIL              | 1   |         |
|        | L16414   | ELC13P1R9    | CHOKE COIL              | 1   |         |
|        | L16472   | G0ZZ00002183 | PEAKING COIL            | 1   |         |
|        | L16697   | G0C102KA0187 | PEAKING COIL            | 1   |         |
|        | L16698   | G0C681MA0065 | PEAKING COIL            | 1   |         |
|        | L16699   | G0C471KA0167 | PEAKING COIL            | 1   |         |
|        | L16851   | G0ZZ00002183 | PEAKING COIL            | 1   |         |
|        |          |              |                         |     |         |
|        | PA5600   | K5H5022A0031 | FUSE                    | 1   |         |
|        |          |              |                         |     |         |
|        | PC2511   | B3JB00000046 | IC                      | 1   |         |
|        | PC16191  | B3PBA0000496 | IC                      | 1   |         |
|        | PC16192  | B3PBA0000223 | IC                      | 1   |         |
|        | PC16461  | B3PBA0000457 | IC                      | 1   |         |
|        | PC16480  | B3PBA0000223 | IC                      | 1   |         |
|        | PC16601  | B3PBA0000223 | IC                      | 1   |         |
|        | PC16603  | B3PBA0000223 | IC                      | 1   |         |
|        | PC16684  | B3PBA0000496 | IC                      | 1   |         |
|        | PC16685  | B3PBA0000496 | IC                      | 1   |         |
|        | PC16722  | B3PBA0000223 | IC                      | 1   |         |
|        | PC16723  | B3PBA0000223 | IC                      | 1   |         |
|        | PC16896  | B3PBA0000223 | IC                      | 1   |         |
|        |          |              |                         |     |         |
|        | Q2001    | B1ABCF000231 | TRANSISTOR              | 1   |         |
|        | Q2022    | B1ADCE000022 | TRANSISTOR              | 1   |         |
|        | Q2063    | 2SD0601ASL   | TRANSISTOR              | 1   |         |
|        | Q2064    | 2SD0601ASL   | TRANSISTOR              | 1   |         |
|        | Q2065    | 2SB0709ASL   | TRANSISTOR              | 1   |         |
|        | Q2510    | 2SD0601ARL   | TRANSISTOR              | 1   |         |
|        | Q2511    | 2SD0601ARL   | TRANSISTOR              | 1   |         |
|        | Q2513    | 2SD0601ARL   | TRANSISTOR              | 1   |         |
|        | Q2519    | 2SD0601ARL   | TRANSISTOR              | 1   |         |
|        | Q3000    | B1ABCF000231 | TRANSISTOR              | 1   |         |
|        | Q3001    | B1ABCF000231 | TRANSISTOR              | 1   |         |
|        | Q3002    | B1ABCF000231 | TRANSISTOR              | 1   |         |
|        | Q3003    | B1ABCF000231 | TRANSISTOR              | 1   |         |
|        | Q3004    | B1ABCF000231 | TRANSISTOR              | 1   |         |
|        | Q3005    | B1ABCF000231 | TRANSISTOR              | 1   |         |
|        | Q4500    | B1ABCF000231 | TRANSISTOR              | 1   |         |
|        | Q4501    | B1ABCF000231 | TRANSISTOR              | 1   |         |
|        | Q4514    | 2SB0709ASL   | TRANSISTOR              | 1   |         |
|        | Q4515    | 2SB0709ASL   | TRANSISTOR              | 1   |         |
|        | Q4516    | 2SB0709ASL   | TRANSISTOR              | 1   |         |
|        | Q4517    | 2SB0709ASL   | TRANSISTOR              | 1   |         |
|        | Q4519    | 2SB0709ASL   | TRANSISTOR              | 1   |         |
|        | Q4520    | B1ABCF000231 | TRANSISTOR              | 1   |         |
|        | Q4533    | B1ABCF000231 | TRANSISTOR              | 1   |         |
|        | Q4534    | B1ABCF000231 | TRANSISTOR              | 1   |         |
|        | Q4535    | B1ABCF000231 | TRANSISTOR              | 1   |         |
|        | Q5480    | B1ADCE000022 | TRANSISTOR              | 1   |         |
|        | Q5600    | B1MBDDA00003 | FET                     | 1   |         |
|        | Q5601    | B1MBDDA00003 | FET                     | 1   |         |
|        | Q5602    | B1MBDDA00003 | FET                     | 1   |         |
|        | Q5603    | B1MBDDA00003 | FET                     | 1   |         |
|        | Q5606    | 2SD0601ARL   | TRANSISTOR              | 1   |         |
|        | Q5607    | 2SD0601ARL   | TRANSISTOR              | 1   |         |
|        | Q5608    | 2SB0709ARL   | TRANSISTOR              | 1   |         |
|        | Q8200    | 2SD0601ARL   | TRANSISTOR              | 1   |         |
|        | Q8401    | 2SD0601ARL   | TRANSISTOR              | 1   |         |
|        | Q8402    | 2SD0601ARL   | TRANSISTOR              | 1   |         |
|        | Q9000    | B1ABCF000231 | TRANSISTOR              | 1   |         |
|        | Q9001    | B1ABCF000231 | TRANSISTOR              | 1   |         |
|        | Q9002    | B1ABCF000231 | TRANSISTOR              | 1   |         |
|        | Q9003    | B1ABCF000231 | TRANSISTOR              | 1   |         |
|        | Q9004    | B1ABCF000231 | TRANSISTOR              | 1   |         |
|        | Q9301    | 2SD0601ARL   | TRANSISTOR              | 1   |         |

| Safety | Ref. No. | Part No.     | Part Name & Description | Pcs | Remarks |
|--------|----------|--------------|-------------------------|-----|---------|
|        | Q9302    | 2SD0601ARL   | TRANSISTOR              | 1   |         |
|        | Q9807    | 2SD0601ARL   | TRANSISTOR              | 1   |         |
|        | Q16001   | B1JAEN000005 | TRANSISTOR              | 1   | PAVCCZ  |
|        | Q16002   | B1JAEN000005 | TRANSISTOR              | 1   | PAVCCZ  |
|        | Q16021   | B1JAEN000004 | TRANSISTOR              | 1   |         |
|        | Q16022   | B1JAEN000004 | TRANSISTOR              | 1   |         |
|        | Q16101   | 2SK417300L   | FET                     | 1   |         |
|        | Q16102   | 2SK399500L   | FET                     | 1   |         |
|        | Q16141   | B1HFFFA00001 | TRANSISTOR              | 1   |         |
|        | Q16161   | B1HFFFA00001 | TRANSISTOR              | 1   |         |
|        | Q16191   | B1HFFFA00001 | TRANSISTOR              | 1   |         |
|        | Q16280   | 2SD0601ARL   | TRANSISTOR              | 1   |         |
|        | Q16401   | 2PG0090000RP | TRANSISTOR              | 1   |         |
|        | Q16402   | 2PG0090000RP | TRANSISTOR              | 1   |         |
|        | Q16421   | B1JAEP000004 | TRANSISTOR              | 1   |         |
|        | Q16422   | B1JAEP000004 | TRANSISTOR              | 1   |         |
|        | Q16441   | B1JAEP000006 | TRANSISTOR              | 1   |         |
|        | Q16451   | B1JAEP000006 | TRANSISTOR              | 1   |         |
|        | Q16471   | B1ABCF000231 | TRANSISTOR              | 1   |         |
|        | Q16490   | B1CBGD000001 | FET                     | 1   |         |
|        | Q16501   | B1HFFFA00001 | TRANSISTOR              | 1   |         |
|        | Q16521   | B1HFFFA00001 | TRANSISTOR              | 1   |         |
|        | Q16531   | B1HFFFA00001 | TRANSISTOR              | 1   |         |
|        | Q16551   | B1HFFFA00001 | TRANSISTOR              | 1   |         |
|        | Q16581   | B1ABCF000231 | TRANSISTOR              | 1   |         |
|        | Q16601   | B1CERR000025 | FET                     | 1   |         |
|        | Q16602   | 2SD0601AQL   | TRANSISTOR              | 1   |         |
|        | Q16603   | 2SB0709ASL   | TRANSISTOR              | 1   |         |
|        | Q16604   | B1CHPM000001 | FET                     | 1   |         |
|        | Q16606   | 2SD0601AQL   | TRANSISTOR              | 1   |         |
|        | Q16607   | B1CBGD000001 | FET                     | 1   |         |
|        | Q16621   | B1JADN000004 | TRANSISTOR              | 1   |         |
|        | Q16622   | B1JADN000004 | TRANSISTOR              | 1   |         |
|        | Q16624   | 2SB0709ASL   | TRANSISTOR              | 1   |         |
|        | Q16661   | B1JAER000003 | TRANSISTOR              | 1   |         |
|        | Q16662   | 2SD0601AQL   | TRANSISTOR              | 1   |         |
|        | Q16663   | 2SB0709ASL   | TRANSISTOR              | 1   |         |
|        | Q16667   | 2SB0709ARL   | TRANSISTOR              | 1   |         |
|        | Q16670   | B1ADCN000007 | TRANSISTOR              | 1   |         |
|        | Q16671   | B1ABCF000231 | TRANSISTOR              | 1   |         |
|        | Q16672   | B1CBGD000001 | FET                     | 1   |         |
|        | Q16673   | B1CBGD000001 | FET                     | 1   |         |
|        | Q16674   | B1CBGD000001 | FET                     | 1   |         |
|        | Q16675   | B1ADCN000007 | TRANSISTOR              | 1   |         |
|        | Q16676   | B1ABCF000231 | TRANSISTOR              | 1   |         |
|        | Q16701   | B1ADCN000007 | TRANSISTOR              | 1   |         |
|        | Q16702   | B1ABCF000231 | TRANSISTOR              | 1   |         |
|        | Q16762   | B1HFFFA00001 | TRANSISTOR              | 1   |         |
|        | Q16815   | B1ABCN000007 | TRANSISTOR              | 1   |         |
|        | Q16816   | 2SD0601AQL   | TRANSISTOR              | 1   |         |
|        | Q16817   | B1CBGD000001 | FET                     | 1   |         |
|        | Q16818   | B1CBGD000001 | FET                     | 1   |         |
|        | Q16874   | B1CBGD000001 | FET                     | 1   |         |
|        | Q16875   | B1ABCF000231 | TRANSISTOR              | 1   |         |
|        | Q16876   | B1ABCF000231 | TRANSISTOR              | 1   |         |
|        | Q16882   | B1ABCF000231 | TRANSISTOR              | 1   |         |
|        | Q16884   | 2SD0601ARL   | TRANSISTOR              | 1   |         |
|        | Q16920   | B1ABCN000007 | TRANSISTOR              | 1   |         |
|        |          |              |                         |     |         |
|        | R0180    | ERJ2GEJ101   | M 100 OHM,<br>J, 0.063W | 1   |         |
|        | R0605    | ERJ2GEJ473   | M 47KOHM,<br>J, 0.063W  | 1   |         |
|        | R606     | ERJ2GEJ223   | M 22KOHM,<br>J, 0.063W  | 1   |         |
|        | R607     | ERJ2GEJ473   | M 47KOHM,<br>J, 0.063W  | 1   |         |
|        | R0900    | ERJ2GEJ680   | M 68 OHM,<br>J, 0.063W  | 1   |         |
|        | R0901    | EXB28V680JX  | RESISTOR ARRAY          | 1   |         |
|        | R0902    | ERJ2GEJ102X  | M 1K OHM J 1/4W         | 1   |         |
|        | R0905    | ERJ2GEJ103   | M 10KOHM,<br>J, 0.063W  | 1   |         |

| Safety | Ref. No. | Part No.     | Part Name & Description | Pcs | Remarks |
|--------|----------|--------------|-------------------------|-----|---------|
|        | R0906    | ERJ2GEJ103   | M 10KOHM, J,0.063W      | 1   |         |
|        | R0907    | ERJ2GEJ103   | M 10KOHM, J,0.063W      | 1   |         |
|        | R0909    | ERJ2GEJ220   | M 22 OHM, J,0.063W      | 1   |         |
|        | R0910    | ERJ2GEJ220   | M 22 OHM, J,0.063W      | 1   |         |
|        | R0911    | ERJ2GEJ220   | M 22 OHM, J,0.063W      | 1   |         |
|        | R0912    | ERJ2GEJ220   | M 22 OHM, J,0.063W      | 1   |         |
|        | R0913    | ERJ2GEJ220   | M 22 OHM, J,0.063W      | 1   |         |
|        | R0914    | ERJ2GEJ220   | M 22 OHM, J,0.063W      | 1   |         |
|        | R0915    | ERJ2GEJ472   | M 4.7KOHM, J,0.063W     | 1   |         |
|        | R0916    | ERJ2GEJ472   | M 4.7KOHM, J,0.063W     | 1   |         |
|        | R0917    | ERJ2GEJ220   | M 22 OHM, J,0.063W      | 1   |         |
|        | R0918    | ERJ2GEJ220   | M 22 OHM, J,0.063W      | 1   |         |
|        | R0919    | ERJ2GEJ220   | M 22 OHM, J,0.063W      | 1   |         |
|        | R0920    | ERJ2GEJ220   | M 22 OHM, J,0.063W      | 1   |         |
|        | R0927    | ERJ2GEJ220   | M 22 OHM, J,0.063W      | 1   |         |
|        | R0928    | ERJ2GEJ220   | M 22 OHM, J,0.063W      | 1   |         |
|        | R0929    | ERJ2GEJ220   | M 22 OHM, J,0.063W      | 1   |         |
|        | R0930    | ERJ2GEJ220   | M 22 OHM, J,0.063W      | 1   |         |
|        | R0933    | DOYAR0000007 | M 0 OHM 1/4W            | 1   |         |
|        | R0934    | DOYAR0000007 | M 0 OHM 1/4W            | 1   |         |
|        | R0937    | ERJ2GEJ472   | M 4.7KOHM, J,0.063W     | 1   |         |
|        | R0938    | ERJ2GEJ472   | M 4.7KOHM, J,0.063W     | 1   |         |
|        | R0939    | ERJ2GEJ220   | M 22 OHM, J,0.063W      | 1   |         |
|        | R0940    | ERJ2GEJ220   | M 22 OHM, J,0.063W      | 1   |         |
|        | R0941    | DOYAR0000007 | M 0 OHM 1/4W            | 1   |         |
|        | R0942    | DOYAR0000007 | M 0 OHM 1/4W            | 1   |         |
|        | R0945    | ERJ2GEJ220   | M 22 OHM, J,0.063W      | 1   |         |
|        | R0946    | ERJ2GEJ220   | M 22 OHM, J,0.063W      | 1   |         |
|        | R0947    | ERJ2GEJ680   | M 68 OHM, J,0.063W      | 1   |         |
|        | R0948    | ERJ2GEJ680   | M 68 OHM, J,0.063W      | 1   |         |
|        | R0949    | ERJ2GEJ680   | M 68 OHM, J,0.063W      | 1   |         |
|        | R0950    | ERJ2GEJ680   | M 68 OHM, J,0.063W      | 1   |         |
|        | R0951    | ERJ2GEJ680   | M 68 OHM, J,0.063W      | 1   |         |
|        | R0952    | ERJ2GEJ680   | M 68 OHM, J,0.063W      | 1   |         |
|        | R0953    | ERJ2GEJ680   | M 68 OHM, J,0.063W      | 1   |         |
|        | R0954    | ERJ2GEJ680   | M 68 OHM, J,0.063W      | 1   |         |
|        | R0955    | ERJ2GEJ472   | M 4.7KOHM, J,0.063W     | 1   |         |
|        | R0956    | ERJ2GEJ472   | M 4.7KOHM, J,0.063W     | 1   |         |
|        | R0957    | ERJ2GEJ472   | M 4.7KOHM, J,0.063W     | 1   |         |
|        | R0958    | ERJ2GEJ472   | M 4.7KOHM, J,0.063W     | 1   |         |
|        | R0959    | ERJ2GEJ472   | M 4.7KOHM, J,0.063W     | 1   |         |
|        | R0960    | ERJ2GEJ472   | M 4.7KOHM, J,0.063W     | 1   |         |

| Safety | Ref. No. | Part No.     | Part Name & Description | Pcs | Remarks |
|--------|----------|--------------|-------------------------|-----|---------|
|        | R0961    | ERJ2GEJ472   | M 4.7KOHM, J,0.063W     | 1   |         |
|        | R0962    | ERJ2GEJ472   | M 4.7KOHM, J,0.063W     | 1   |         |
|        | R1010    | DOGB103JA041 | M 10K OHM J 1/16W       | 1   |         |
|        | R1146    | DOYAR0000007 | M 0 OHM 1/4W            | 1   |         |
|        | R1153    | ERJ2GEJ681   | M 680 OHM, J,0.063W     | 1   |         |
|        | R1163    | ERJ2GEJ105   | M 1MOHM, J,0.063W       | 1   |         |
|        | R1173    | ERJ2GEJ331   | M 330 OHM, J,0.063W     | 1   |         |
|        | R1179    | DOYAR0000007 | M 0 OHM 1/4W            | 1   |         |
|        | R1181    | DOYAR0000007 | M 0 OHM 1/4W            | 1   |         |
|        | R1182    | ERJ2GED273X  | M 27KOHM, J,0.063W      | 1   |         |
|        | R1203    | ERJ2GEJ473   | M 47KOHM, J,0.063W      | 1   |         |
|        | R1209    | ERJ2GEJ472   | M 4.7KOHM, J,0.063W     | 1   |         |
|        | R1221    | D1BB7151A055 | M7.15KOHM, 1/10W        | 1   |         |
|        | R1224    | ERJ2GEJ103   | M 10KOHM, J,0.063W      | 1   |         |
|        | R1225    | ERJ2GEJ103   | M 10KOHM, J,0.063W      | 1   |         |
|        | R1236    | ERJ2GEJ473   | M 47KOHM, J,0.063W      | 1   |         |
|        | R1237    | ERJ2GEJ102X  | M 1K OHM J 1/4W         | 1   |         |
|        | R1243    | ERJ2GEJ473   | M 47KOHM, J,0.063W      | 1   |         |
|        | R1255    | ERJ2GEJ102X  | M 1K OHM J 1/4W         | 1   |         |
|        | R1400    | ERJ2GEJ103   | M 10KOHM, J,0.063W      | 1   |         |
|        | R1401    | ERJ2GEJ104   | M 100KOHM, J,0.063W     | 1   |         |
|        | R1402    | ERJ2GEJ683   | M 68KOHM, J,0.063W      | 1   |         |
|        | R1403    | ERJ2GEJ333   | M 33KOHM, J,0.063W      | 1   |         |
|        | R1404    | ERJ2GEJ683   | M 68KOHM, J,0.063W      | 1   |         |
|        | R1405    | ERJ2GEJ333   | M 33KOHM, J,0.063W      | 1   |         |
|        | R1406    | ERJ2GEJ683   | M 68KOHM, J,0.063W      | 1   |         |
|        | R1407    | ERJ2GEJ473   | M 47KOHM, J,0.063W      | 1   |         |
|        | R1410    | ERJ2GEJ103   | M 10KOHM, J,0.063W      | 1   |         |
|        | R1411    | ERJ2GEJ104   | M 100KOHM, J,0.063W     | 1   |         |
|        | R1413    | ERJ2GEJ473   | M 47KOHM, J,0.063W      | 1   |         |
|        | R2002    | ERJ2GEJ471   | M 470 OHM, J,0.063W     | 1   |         |
|        | R2003    | ERJ2GEJ105   | M 1MOHM, J,0.063W       | 1   |         |
|        | R2006    | ERJ2GEJ471   | M 470 OHM, J,0.063W     | 1   |         |
|        | R2007    | ERJ2GEJ221   | M 220 OHM, J,0.063W     | 1   |         |
|        | R2008    | ERJ2GEJ471   | M 470 OHM, J,0.063W     | 1   |         |
|        | R2015    | ERJ2GEJ103   | M 10KOHM, J,0.063W      | 1   |         |
|        | R2016    | ERJ2GEJ103   | M 10KOHM, J,0.063W      | 1   |         |
|        | R2017    | ERJ2GEJ103   | M 10KOHM, J,0.063W      | 1   |         |
|        | R2018    | ERJ2GEJ103   | M 10KOHM, J,0.063W      | 1   |         |
|        | R2019    | D1BB2002A055 | M 20KOHM, 1/10W         | 1   |         |
|        | R2020    | D1BB2001A055 | M 2KOHM, 1/10W          | 1   |         |
|        | R2023    | ERJ2GEJ103   | M 10KOHM, J,0.063W      | 1   |         |
|        | R2032    | ERJ2GEJ561   | M 60 OHM, J,0.063W      | 1   |         |
|        | R2047    | D1BB2802A055 | M 28KOHM, 1/10W         | 1   |         |
|        | R2048    | D1BB2802A055 | M 28KOHM, 1/10W         | 1   |         |

| Safety | Ref. No. | Part No.     | Part Name & Description | Pcs | Remarks |
|--------|----------|--------------|-------------------------|-----|---------|
|        | R2050    | D1BB2802A055 | M 28KOHM, 1/10W         | 1   |         |
|        | R2051    | D1BB2802A055 | M 28KOHM, 1/10W         | 1   |         |
|        | R2063    | J0JCC0000287 | CHIP INDUCTOR           | 1   | PAVCCZ  |
|        | R2064    | J0JCC0000287 | CHIP INDUCTOR           | 1   | PAVCCZ  |
|        | R2092    | ERJ2GEJ103   | M 10KOHM, J,0.063W      | 1   |         |
|        | R2093    | ERJ2GEJ103   | M 10KOHM, J,0.063W      | 1   |         |
|        | R2110    | ERJ2GEJ101   | M 100 OHM, J,0.063W     | 1   |         |
|        | R2111    | ERJ2GEJ101   | M 100 OHM, J,0.063W     | 1   |         |
|        | R2114    | ERJ2GEJ222   | M 2.2KOHM, J,0.063W     | 1   |         |
|        | R2115    | ERJ2GEJ222   | M 2.2KOHM, J,0.063W     | 1   |         |
|        | R2118    | ERJ2GEJ471   | M 470 OHM, J,0.063W     | 1   |         |
|        | R2119    | ERJ2GEJ105   | M 1MOHM, J,0.063W       | 1   |         |
|        | R2120    | ERJ2GEJ473   | M 47KOHM, J,0.063W      | 1   |         |
|        | R2121    | ERJ8GEYJ3R3V | M 3.3 OHM, J,1/8W       | 1   |         |
|        | R2122    | ERJ2GEJ101   | M 100 OHM, J,0.063W     | 1   |         |
|        | R2123    | ERJ8GEYJ3R3V | M 3.3 OHM, J,1/8W       | 1   |         |
|        | R2124    | ERJ2GEJ103   | M 10KOHM, J,0.063W      | 1   |         |
|        | R2125    | ERJ8GEYJ3R3V | M 3.3 OHM, J,1/8W       | 1   |         |
|        | R2127    | ERJ8GEYJ3R3V | M 3.3 OHM, J,1/8W       | 1   |         |
|        | R2129    | ERJ2GEJ100   | M 10 OHM, J,0.063W      | 1   |         |
|        | R2132    | ERJ2GEJ471   | M 470 OHM, J,0.063W     | 1   |         |
|        | R2137    | ERJ2GEJ100   | M 10 OHM, J,0.063W      | 1   |         |
|        | R2141    | ERJ2GEJ102X  | M 1K OHM J 1/4W         | 1   |         |
|        | R2142    | ERJ2GEJ222   | M 2.2KOHM, J,0.063W     | 1   |         |
|        | R2172    | ERJ2GEJ680   | M 68 OHM, J,0.063W      | 1   |         |
|        | R2190    | ERJ2GEJ472   | M 4.7KOHM, J,0.063W     | 1   |         |
|        | R2316    | EXB28V220J   | RESISTOR ARRAY          | 1   |         |
|        | R2325    | DOYAR0000007 | M 0 OHM 1/4W            | 1   |         |
|        | R2516    | ERJ3GEYJ223  | M 22KOHM, J,1/16W       | 1   |         |
|        | R2517    | ERJ3GEYJ470  | M 47 OHM, J,1/16W       | 1   |         |
|        | R2520    | ERJ3GEYJ224  | M 220KOHM, J,1/16W      | 1   |         |
|        | R2524    | ERJ3GEYJ223  | M 22KOHM, J,1/16W       | 1   |         |
|        | R2525    | D1BB7500A055 | M 750 OHM, 1/10W        | 1   |         |
|        | R2530    | D0GB473JA057 | M 47KOHM, J,1/16W       | 1   |         |
|        | R2531    | D1BB2700A055 | M 270 OHM, 1/10W        | 1   |         |
|        | R2542    | D0GB473JA057 | M 47KOHM, J,1/16W       | 1   |         |
|        | R2556    | D0GB103JA041 | M 10K OHM J 1/16W       | 1   |         |
|        | R2557    | ERJ3GEYJ223  | M 22KOHM, J,1/16W       | 1   |         |
|        | R2561    | ERJ3GEYJ223  | M 22KOHM, J,1/16W       | 1   |         |
|        | R2562    | D0GB473JA057 | M 47KOHM, J,1/16W       | 1   |         |
|        | R2565    | D1BB1001A055 | M 1KOHM, 1/16W          | 1   |         |
|        | R2581    | DOGDR00Z0002 | M 0 OHM, 1/10W          | 1   |         |
|        | R2756    | ERJ2GEJ101   | M 100 OHM, J,0.063W     | 1   |         |
|        | R2757    | ERJ2GEJ101   | M 100 OHM, J,0.063W     | 1   |         |
|        | R2870    | ERJ2GEJ390   | M 39 OHM, J,0.063W      | 1   |         |
|        | R2871    | ERJ2GEJ103   | M 10KOHM, J,0.063W      | 1   |         |
|        | R2872    | ERJ2GEJ683   | M 68KOHM, J,0.063W      | 1   |         |
|        | R2873    | DOYAR0000007 | M 0 OHM 1/4W            | 1   |         |
|        | R2874    | ERJ2GEJ103   | M 10KOHM, J,0.063W      | 1   |         |

| Safety | Ref. No. | Part No.     | Part Name & Description | Pcs | Remarks |
|--------|----------|--------------|-------------------------|-----|---------|
|        | R2875    | ERJ2GEJ203X  | M 20KOHM, J,0.063W      | 1   |         |
|        | R2905    | DOYAR0000007 | M 0 OHM 1/4W            | 1   |         |
|        | R2909    | DOYAR0000007 | M 0 OHM 1/4W            | 1   |         |
|        | R2915    | ERJ2GEJ221   | M 220 OHM, J,0.063W     | 1   |         |
|        | R2916    | ERJ3GEYOR00  | M 0 OHM, 1/16W          | 1   |         |
|        | R2930    | ERJ2GEJ153   | M 15KOHM, J,0.063W      | 1   |         |
|        | R2941    | DOYAR0000007 | M 0 OHM 1/4W            | 1   |         |
|        | R2942    | DOYAR0000007 | M 0 OHM 1/4W            | 1   |         |
|        | R2960    | ERJ2GEJ103   | M 10KOHM, J,0.063W      | 1   |         |
|        | R3000    | ERJ2GEJ223   | M 22KOHM, J,0.063W      | 1   |         |
|        | R3001    | ERJ2GEJ223   | M 22KOHM, J,0.063W      | 1   |         |
|        | R3002    | ERJ2GEJ223   | M 22KOHM, J,0.063W      | 1   |         |
|        | R3003    | ERJ2GEJ223   | M 22KOHM, J,0.063W      | 1   |         |
|        | R3004    | ERJ2GEJ223   | M 22KOHM, J,0.063W      | 1   |         |
|        | R3005    | ERJ2GEJ223   | M 22KOHM, J,0.063W      | 1   |         |
|        | R3006    | ERJ2GEJ104   | M 100KOHM, J,0.063W     | 1   |         |
|        | R3007    | ERJ2GEJ104   | M 100KOHM, J,0.063W     | 1   |         |
|        | R3008    | ERJ2GEJ222   | M 2.2KOHM, J,0.063W     | 1   |         |
|        | R3009    | ERJ2GEJ222   | M 2.2KOHM, J,0.063W     | 1   |         |
|        | R3010    | ERJ2GEJ104   | M 100KOHM, J,0.063W     | 1   |         |
|        | R3011    | ERJ2GEJ104   | M 100KOHM, J,0.063W     | 1   |         |
|        | R3012    | ERJ2GEJ222   | M 2.2KOHM, J,0.063W     | 1   |         |
|        | R3013    | ERJ2GEJ222   | M 2.2KOHM, J,0.063W     | 1   |         |
|        | R3014    | ERJ2GEJ103   | M 10KOHM, J,0.063W      | 1   |         |
|        | R3019    | ERJ2GEJ222   | M 2.2KOHM, J,0.063W     | 1   |         |
|        | R3021    | ERJ2GEJ222   | M 2.2KOHM, J,0.063W     | 1   |         |
|        | R3024    | ERJ2GEJ104   | M 100KOHM, J,0.063W     | 1   |         |
|        | R3025    | ERJ2GEJ104   | M 100KOHM, J,0.063W     | 1   |         |
|        | R3028    | ERJ2GEJ331   | M 330 OHM, J,0.063W     | 1   |         |
|        | R3029    | ERJ2GEJ331   | M 330 OHM, J,0.063W     | 1   |         |
|        | R3030    | J0JCC0000287 | CHIP INDUCTOR           | 1   | PAVCCZ  |
|        | R3033    | ERJ2GEJ221   | M 220 OHM, J,0.063W     | 1   |         |
|        | R3034    | ERJ2GEJ221   | M 220 OHM, J,0.063W     | 1   |         |
|        | R3037    | ERJ2GEJ221   | M 220 OHM, J,0.063W     | 1   |         |
|        | R3038    | ERJ2GEJ221   | M 220 OHM, J,0.063W     | 1   |         |
|        | R3041    | ERJ2GEJ331   | M 330 OHM, J,0.063W     | 1   |         |
|        | R3042    | ERJ2GEJ331   | M 330 OHM, J,0.063W     | 1   |         |
|        | R3043    | ERJ2GEJ221   | M 220 OHM, J,0.063W     | 1   |         |
|        | R3045    | ERJ2GEJ221   | M 220 OHM, J,0.063W     | 1   |         |
|        | R3047    | ERJ2GEJ221   | M 220 OHM, J,0.063W     | 1   |         |
|        | R3048    | ERJ2GEJ221   | M 220 OHM, J,0.063W     | 1   |         |
|        | R3049    | ERJ2GEJ221   | M 220 OHM, J,0.063W     | 1   |         |
|        | R3050    | ERJ2GEJ221   | M 220 OHM, J,0.063W     | 1   |         |

| Safety | Ref. No. | Part No.     | Part Name & Description | Pcs | Remarks |
|--------|----------|--------------|-------------------------|-----|---------|
|        | R3051    | ERJ2GEJ221   | M 220 OHM, J, 0.063W    | 1   |         |
|        | R3052    | ERJ2GEJ221   | M 220 OHM, J, 0.063W    | 1   |         |
|        | R3072    | D1BD1500A044 | M 150 OHM, 1/10W        | 1   |         |
|        | R3073    | D1BD1500A044 | M 150 OHM, 1/10W        | 1   |         |
|        | R3074    | D1BD1500A044 | M 150 OHM, 1/10W        | 1   |         |
|        | R3075    | D1BD1500A044 | M 150 OHM, 1/10W        | 1   |         |
|        | R3076    | D1BD1500A044 | M 150 OHM, 1/10W        | 1   |         |
|        | R3077    | D1BD1500A044 | M 150 OHM, 1/10W        | 1   |         |
|        | R3079    | D1BD1500A044 | M 150 OHM, 1/10W        | 1   |         |
|        | R3081    | D1BD1500A044 | M 150 OHM, 1/10W        | 1   |         |
|        | R3082    | D1BD1500A044 | M 150 OHM, 1/10W        | 1   |         |
|        | R3083    | D1BD1500A044 | M 150 OHM, 1/10W        | 1   |         |
|        | R3084    | ERJ6RED750   | M 75 OHM, 1/10W         | 1   |         |
|        | R3085    | ERJ6RED750   | M 75 OHM, 1/10W         | 1   |         |
|        | R3086    | ERJ6RED750   | M 75 OHM, 1/10W         | 1   |         |
|        | R3087    | D1BD1500A044 | M 150 OHM, 1/10W        | 1   |         |
|        | R3089    | ERJ2GEJ680   | M 68 OHM, J, 0.063W     | 1   |         |
|        | R3091    | ERJ2RKF2152  | M 21.5K OHM, J, 2W      | 1   | PAVCCZ  |
|        | R3092    | ERJ2RKF2152  | M 21.5K OHM, J, 2W      | 1   | PAVCCZ  |
|        | R3094    | ERJ2RKF1302  | M 13K OHM, J, 2W        | 1   |         |
|        | R3097    | D1BD1500A044 | M 150 OHM, 1/10W        | 1   |         |
|        | R3098    | D1BD1500A044 | M 150 OHM, 1/10W        | 1   |         |
|        | R3100    | ERJ2GEJ104   | M 100KOHM, J, 0.063W    | 1   |         |
|        | R3102    | D1BD1500A044 | M 150 OHM, 1/10W        | 1   |         |
|        | R3104    | D1BD1500A044 | M 150 OHM, 1/10W        | 1   |         |
|        | R3106    | ERJ2GED273X  | M 27KOHM, J, 0.063W     | 1   |         |
|        | R3108    | ERJ2GED273X  | M 27KOHM, J, 0.063W     | 1   |         |
|        | R3112    | D0YAR0000007 | M 0 OHM 1/4W            | 1   |         |
|        | R3113    | D0YAR0000007 | M 0 OHM 1/4W            | 1   |         |
|        | R3115    | ERJ2GEJ221   | M 220 OHM, J, 0.063W    | 1   |         |
|        | R3116    | ERJ2GEJ221   | M 220 OHM, J, 0.063W    | 1   |         |
|        | R3117    | ERJ2GEJ221   | M 220 OHM, J, 0.063W    | 1   |         |
|        | R3118    | ERJ2GEJ221   | M 220 OHM, J, 0.063W    | 1   |         |
|        | R3119    | ERJ2GEJ221   | M 220 OHM, J, 0.063W    | 1   |         |
|        | R3120    | ERJ2GEJ331   | M 330 OHM, J, 0.063W    | 1   |         |
|        | R3121    | ERJ6RED750   | M 75 OHM, 1/10W         | 1   |         |
|        | R3123    | ERJ2GEJ221   | M 220 OHM, J, 0.063W    | 1   |         |
|        | R3128    | ERJ2GEJ221   | M 220 OHM, J, 0.063W    | 1   |         |
|        | R3132    | ERJ2GEJ820   | M 82 OHM, J, 0.063W     | 1   |         |
|        | R3133    | ERJ2GEJ820   | M 82 OHM, J, 0.063W     | 1   |         |
|        | R3134    | ERJ2GEJ820   | M 82 OHM, J, 0.063W     | 1   |         |
|        | R3135    | ERJ2GEJ221   | M 220 OHM, J, 0.063W    | 1   |         |
|        | R3136    | ERJ2GEJ221   | M 220 OHM, J, 0.063W    | 1   |         |
|        | R3137    | ERJ2GEJ221   | M 220 OHM, J, 0.063W    | 1   |         |
|        | R3138    | ERJ2GEJ221   | M 220 OHM, J, 0.063W    | 1   |         |
|        | R3139    | ERJ2GEJ221   | M 220 OHM, J, 0.063W    | 1   |         |
|        | R3140    | ERJ2GEJ221   | M 220 OHM, J, 0.063W    | 1   |         |
|        | R3143    | ERJ2GEJ680   | M 68 OHM, J, 0.063W     | 1   |         |
|        | R3146    | ERJ2GEJ331   | M 330 OHM, J, 0.063W    | 1   |         |
|        | R3150    | ERJ2GEJ680   | M 68 OHM, J, 0.063W     | 1   |         |

| Safety | Ref. No. | Part No.     | Part Name & Description | Pcs | Remarks |
|--------|----------|--------------|-------------------------|-----|---------|
|        | R3153    | ERJ2GEJ680   | M 68 OHM, J, 0.063W     | 1   |         |
|        | R3167    | ERJ6RED750   | M 75 OHM, 1/10W         | 1   |         |
|        | R3169    | ERJ2GEJ104   | M 100KOHM, J, 0.063W    | 1   |         |
|        | R3172    | ERJ6RED750   | M 75 OHM, 1/10W         | 1   |         |
|        | R3174    | ERJ2GEJ104   | M 100KOHM, J, 0.063W    | 1   |         |
|        | R3182    | ERJ2RKF1302  | M 13K OHM, J, 2W        | 1   |         |
|        | R3186    | D1BD1500A044 | M 150 OHM, 1/10W        | 1   |         |
|        | R3187    | D1BD1500A044 | M 150 OHM, 1/10W        | 1   |         |
|        | R3188    | D1BD1500A044 | M 150 OHM, 1/10W        | 1   |         |
|        | R3189    | ERJ2GEJ680   | M 68 OHM, J, 0.063W     | 1   |         |
|        | R3190    | ERJ2GEJ680   | M 68 OHM, J, 0.063W     | 1   |         |
|        | R3191    | ERJ2GEJ680   | M 68 OHM, J, 0.063W     | 1   |         |
|        | R3193    | D1BD1500A044 | M 150 OHM, 1/10W        | 1   |         |
|        | R3198    | D1BD1500A044 | M 150 OHM, 1/10W        | 1   |         |
|        | R3204    | D1BD1500A044 | M 150 OHM, 1/10W        | 1   |         |
|        | R3205    | D1BD1500A044 | M 150 OHM, 1/10W        | 1   |         |
|        | R3206    | ERJ2GEJ220   | M 22 OHM, J, 0.063W     | 1   |         |
|        | R3207    | ERJ2GEJ220   | M 22 OHM, J, 0.063W     | 1   |         |
|        | R3212    | D1BD1500A044 | M 150 OHM, 1/10W        | 1   |         |
|        | R3213    | D1BD1500A044 | M 150 OHM, 1/10W        | 1   |         |
|        | R3223    | ERJ2GEJ680   | M 68 OHM, J, 0.063W     | 1   |         |
|        | R3225    | ERJ2GEJ680   | M 68 OHM, J, 0.063W     | 1   |         |
|        | R3226    | ERJ2GEJ472   | M 4.7KOHM, J, 0.063W    | 1   |         |
|        | R3227    | ERJ2GEJ472   | M 4.7KOHM, J, 0.063W    | 1   |         |
|        | R3230    | ERJ6RED750   | M 75 OHM, 1/10W         | 1   |         |
|        | R3232    | ERJ6RED750   | M 75 OHM, 1/10W         | 1   |         |
|        | R3234    | ERJ6RED750   | M 75 OHM, 1/10W         | 1   |         |
|        | R3236    | ERJ2GEJ680   | M 68 OHM, J, 0.063W     | 1   |         |
|        | R3237    | ERJ2GEJ680   | M 68 OHM, J, 0.063W     | 1   |         |
|        | R3240    | ERJ2GEJ221   | M 220 OHM, J, 0.063W    | 1   |         |
|        | R3245    | ERJ2GEJ221   | M 220 OHM, J, 0.063W    | 1   |         |
|        | R3256    | D0GDR00Z0002 | M 0 OHM, 1/10W          | 1   |         |
|        | R3308    | ERJ2GEJ223   | M 22KOHM, J, 0.063W     | 1   |         |
|        | R3309    | ERJ2GEJ223   | M 22KOHM, J, 0.063W     | 1   |         |
|        | R3770    | D1BD1432A044 | M14.3KOHM, 1/10W        | 1   | PAVCCZ  |
|        | R3771    | D1BD6651A044 | M6.65KOHM, 1/10W        | 1   |         |
|        | R3772    | D1BD1741A044 | M1.74KOHM, 1/10W        | 1   |         |
|        | R3775    | ERJ6ENF7151  | M7.15KOHM, 1/10W        | 1   |         |
|        | R4277    | ERJ2GEJ103   | M 10KOHM, J, 0.063W     | 1   |         |
|        | R4284    | ERJ2GEJ103   | M 10KOHM, J, 0.063W     | 1   |         |
|        | R4285    | ERJ2GEJ103   | M 10KOHM, J, 0.063W     | 1   |         |
|        | R4286    | ERJ2GEJ103   | M 10KOHM, J, 0.063W     | 1   |         |
|        | R4294    | ERJ2GEJ103   | M 10KOHM, J, 0.063W     | 1   |         |
|        | R4300    | ERJ2GEJ103   | M 10KOHM, J, 0.063W     | 1   |         |
|        | R4305    | ERJ2GEJ473   | M 47KOHM, J, 0.063W     | 1   |         |
|        | R4306    | ERJ2GEJ473   | M 47KOHM, J, 0.063W     | 1   |         |
|        | R4500    | ERJ2GEJ103   | M 10KOHM, J, 0.063W     | 1   |         |
|        | R4501    | ERJ2GEJ103   | M 10KOHM, J, 0.063W     | 1   |         |
|        | R4502    | ERJ2RKD330   | M 33 OHM, J, 2W         | 1   |         |
|        | R4503    | ERJ2RKD330   | M 33 OHM, J, 2W         | 1   |         |



| Safety | Ref. No. | Part No.     | Part Name & Description | Pcs | Remarks |
|--------|----------|--------------|-------------------------|-----|---------|
|        | R4504    | ERJ2GEJ102X  | M 1K OHM J 1/4W         | 1   |         |
|        | R4505    | ERJ2GEJ102X  | M 1K OHM J 1/4W         | 1   |         |
|        | R4506    | ERJ2GEJ473   | M 47KOHM, J,0.063W      | 1   |         |
|        | R4507    | ERJ2GEJ473   | M 47KOHM, J,0.063W      | 1   |         |
|        | R4524    | ERJ2GEJ103   | M 10KOHM, J,0.063W      | 1   |         |
|        | R4525    | ERJ2GEJ103   | M 10KOHM, J,0.063W      | 1   |         |
|        | R4528    | ERJ2GEJ103   | M 10KOHM, J,0.063W      | 1   |         |
|        | R4529    | ERJ2GEJ103   | M 10KOHM, J,0.063W      | 1   |         |
|        | R4530    | ERJ2GEJ103   | M 10KOHM, J,0.063W      | 1   |         |
|        | R4531    | ERJ2GEJ103   | M 10KOHM, J,0.063W      | 1   |         |
|        | R4532    | ERJ2GEJ473   | M 47KOHM, J,0.063W      | 1   |         |
|        | R4533    | ERJ2GEJ473   | M 47KOHM, J,0.063W      | 1   |         |
|        | R4534    | ERJ2GEJ473   | M 47KOHM, J,0.063W      | 1   |         |
|        | R4538    | ERJ2GEJ473   | M 47KOHM, J,0.063W      | 1   |         |
|        | R4539    | DOYAR0000007 | M 0 OHM 1/4W            | 1   |         |
|        | R4540    | ERJ2GEJ473   | M 47KOHM, J,0.063W      | 1   |         |
|        | R4541    | DOYAR0000007 | M 0 OHM 1/4W            | 1   |         |
|        | R4542    | DOYAR0000007 | M 0 OHM 1/4W            | 1   |         |
|        | R4543    | DOYAR0000007 | M 0 OHM 1/4W            | 1   |         |
|        | R4552    | ERJ2GEJ220   | M 22 OHM, J,0.063W      | 1   |         |
|        | R4587    | D1BB60400001 | M 604 OHM, 1/10W        | 1   |         |
|        | R4588    | D1BB8060A055 | M 806 OHM, 1/10W        | 1   |         |
|        | R4589    | D1BB8060A055 | M 806 OHM, 1/10W        | 1   |         |
|        | R4592    | D1BB8060A055 | M 806 OHM, 1/10W        | 1   |         |
|        | R4593    | D1BB2201A055 | M 2.2KOHM, 1/10W        | 1   |         |
|        | R4596    | ERJ6GEYJ102V | M 1K OHM J 1/10W        | 1   |         |
|        | R4597    | ERJ6GEYJ102V | M 1K OHM J 1/10W        | 1   |         |
|        | R4598    | ERJ6GEYJ102V | M 1K OHM J 1/10W        | 1   |         |
|        | R4601    | ERJ6GEYJ102V | M 1K OHM J 1/10W        | 1   |         |
|        | R4604    | DOYAR0000007 | M 0 OHM 1/4W            | 1   |         |
|        | R4605    | D1BB2201A055 | M 2.2KOHM, 1/10W        | 1   |         |
|        | R4607    | DOYAR0000007 | M 0 OHM 1/4W            | 1   |         |
|        | R4608    | ERJ6GEYJ102V | M 1K OHM J 1/10W        | 1   |         |
|        | R4609    | ERJ2GEJ122   | M 1.2KOHM, J,0.063W     | 1   |         |
|        | R4613    | DOYAR0000007 | M 0 OHM 1/4W            | 1   |         |
|        | R4614    | DOYAR0000007 | M 0 OHM 1/4W            | 1   |         |
|        | R4615    | DOYAR0000007 | M 0 OHM 1/4W            | 1   |         |
|        | R4616    | DOYAR0000007 | M 0 OHM 1/4W            | 1   |         |
|        | R4620    | ERJ2GEJ473   | M 47KOHM, J,0.063W      | 1   |         |
|        | R4622    | ERJ2GEJ102X  | M 1K OHM J 1/4W         | 1   |         |
|        | R4623    | DOYAR0000007 | M 0 OHM 1/4W            | 1   |         |
|        | R4624    | ERJ2GEJ103   | M 10KOHM, J,0.063W      | 1   |         |
|        | R4626    | D1BB2200A055 | M 220 OHM, 1/10W        | 1   |         |
|        | R4627    | D1BB2200A055 | M 220 OHM, 1/10W        | 1   |         |
|        | R4631    | D1BB4990A055 | M 499 OHM, 1/10W        | 1   |         |
|        | R4634    | D1BB2200A055 | M 220 OHM, 1/10W        | 1   |         |
|        | R4635    | EXB28V680JX  | RESISTOR ARRAY          | 1   |         |
|        | R4636    | ERJ2GEJ680   | M 68 OHM, J,0.063W      | 1   |         |
|        | R4637    | ERJ2GEJ473   | M 47KOHM, J,0.063W      | 1   |         |
|        | R4638    | ERJ2GEJ680   | M 68 OHM, J,0.063W      | 1   |         |
|        | R4639    | EXB28V680JX  | RESISTOR ARRAY          | 1   |         |
|        | R4640    | EXB28V680JX  | RESISTOR ARRAY          | 1   |         |
|        | R4641    | ERJ2GEJ473   | M 47KOHM, J,0.063W      | 1   |         |
|        | R4642    | ERJ2GEJ473   | M 47KOHM, J,0.063W      | 1   |         |

| Safety | Ref. No. | Part No.     | Part Name & Description | Pcs | Remarks |
|--------|----------|--------------|-------------------------|-----|---------|
|        | R4645    | ERJ2GEJ680   | M 68 OHM, J,0.063W      | 1   |         |
|        | R4646    | ERJ2GEJ680   | M 68 OHM, J,0.063W      | 1   |         |
|        | R4648    | EXB28V330J   | RESISTOR ARRAY          | 1   |         |
|        | R4649    | EXB28V680JX  | RESISTOR ARRAY          | 1   |         |
|        | R4650    | ERJ2GEJ680   | M 68 OHM, J,0.063W      | 1   |         |
|        | R4651    | ERJ2GEJ680   | M 68 OHM, J,0.063W      | 1   |         |
|        | R4652    | ERJ2GEJ473   | M 47KOHM, J,0.063W      | 1   |         |
|        | R4656    | ERJ2GEJ222   | M 2.2KOHM, J,0.063W     | 1   |         |
|        | R4664    | D1BB60400001 | M 604 OHM, 1/10W        | 1   |         |
|        | R4665    | ERJ2GEJ473   | M 47KOHM, J,0.063W      | 1   |         |
|        | R4666    | ERJ2GEJ473   | M 47KOHM, J,0.063W      | 1   |         |
|        | R4672    | ERJ2GEJ473   | M 47KOHM, J,0.063W      | 1   |         |
|        | R4674    | ERJ2GEJ103   | M 10KOHM, J,0.063W      | 1   |         |
|        | R4677    | ERJ2GEJ103   | M 10KOHM, J,0.063W      | 1   |         |
|        | R4678    | EXB28V680JX  | RESISTOR ARRAY          | 1   |         |
|        | R4679    | EXB28V680JX  | RESISTOR ARRAY          | 1   |         |
|        | R4698    | ERJ2GEJ104   | M 100KOHM, J,0.063W     | 1   |         |
|        | R4699    | ERJ2GEJ104   | M 100KOHM, J,0.063W     | 1   |         |
|        | R4700    | ERJ2GEJ473   | M 47KOHM, J,0.063W      | 1   |         |
|        | R4707    | ERJ2GEJ473   | M 47KOHM, J,0.063W      | 1   |         |
|        | R4728    | ERJ2GEJ103   | M 10KOHM, J,0.063W      | 1   |         |
|        | R4729    | ERJ2RKD330   | M 33 OHM, J, 2W         | 1   |         |
|        | R4732    | ERJ2GEJ473   | M 47KOHM, J,0.063W      | 1   |         |
|        | R4733    | ERJ2GEJ103   | M 10KOHM, J,0.063W      | 1   |         |
|        | R4734    | ERJ2GEJ102X  | M 1K OHM J 1/4W         | 1   |         |
|        | R4735    | ERJ2GEJ103   | M 10KOHM, J,0.063W      | 1   |         |
|        | R4736    | ERJ2GEJ473   | M 47KOHM, J,0.063W      | 1   |         |
|        | R4738    | ERJ2GEJ473   | M 47KOHM, J,0.063W      | 1   |         |
|        | R4739    | ERJ2GEJ103   | M 10KOHM, J,0.063W      | 1   |         |
|        | R4740    | ERJ2GEJ473   | M 47KOHM, J,0.063W      | 1   |         |
|        | R4742    | DOYAR0000007 | M 0 OHM 1/4W            | 1   |         |
|        | R4743    | DOYAR0000007 | M 0 OHM 1/4W            | 1   |         |
|        | R4799    | EXB28V680JX  | RESISTOR ARRAY          | 1   |         |
|        | R5470    | ERJ2GEJ222   | M 2.2KOHM, J,0.063W     | 1   |         |
|        | R5471    | ERJ2GEJ101   | M 100 OHM, J,0.063W     | 1   |         |
|        | R5472    | ERJ2GEJ470   | M 47 OHM, J,0.063W      | 1   |         |
|        | R5473    | ERJ2GEJ473   | M 47KOHM, J,0.063W      | 1   |         |
|        | R5474    | ERJ2GEJ103   | M 10KOHM, J,0.063W      | 1   |         |
|        | R5475    | ERJ2GEJ123   | M 12KOHM, J,0.063W      | 1   |         |
|        | R5482    | ERJ6GEYJ150V | M 15 OHM, J,1/10W       | 1   |         |
|        | R5484    | D1BB3902A055 | M 39KOHM, 1/10W         | 1   | PAVCCZ  |
|        | R5485    | ERJ2GEJ101   | M 100 OHM, J,0.063W     | 1   |         |
|        | R5486    | ERJ2GEJ103   | M 10KOHM, J,0.063W      | 1   |         |
|        | R5488    | DOYAR0000007 | M 0 OHM 1/4W            | 1   |         |
|        | R5489    | ERJ2RKD330   | M 33 OHM, J, 2W         | 1   |         |
|        | R5490    | ERJ2GEJ473   | M 47KOHM, J,0.063W      | 1   |         |

| Safety | Ref. No. | Part No.     | Part Name & Description | Pcs | Remarks |
|--------|----------|--------------|-------------------------|-----|---------|
|        | R5491    | ERJ2GEJ473   | M 47KOHM, J,0.063W      | 1   |         |
|        | R5492    | ERJ2GEJ105   | M 1MOHM, J,0.063W       | 1   |         |
|        | R5493    | ERJ2GEJ203X  | M 20KOHM, J,0.063W      | 1   |         |
|        | R5494    | ERJ2GEJ103   | M 10KOHM, J,0.063W      | 1   |         |
|        | R5496    | ERJ2GEJ680   | M 68 OHM, J,0.063W      | 1   |         |
|        | R5541    | D1BB1003A055 | M 100KOHM, 1/10W        | 1   |         |
|        | R5542    | D1BB3401A055 | M 3.4KOHM, 1/10W        | 1   |         |
|        | R5543    | ERJ6GEYJ153V | M 15KOHM, J,1/10W       | 1   |         |
|        | R5581    | ERJ2GEJ473   | M 47KOHM, J,0.063W      | 1   |         |
|        | R5582    | ERJ2GEJ473   | M 47KOHM, J,0.063W      | 1   |         |
|        | R5600    | D1BB3901A055 | M47.5KOHM, 1/10W        | 1   |         |
|        | R5604    | D1BB2402A055 | M 24KOHM, 1/10W         | 1   |         |
|        | R5605    | D1BB3901A055 | M 8.2KOHM, 1/10W        | 1   |         |
|        | R5610    | D1BB2201A055 | M 2.2KOHM, 1/10W        | 1   |         |
|        | R5611    | D1BB1202A055 | M 12KOHM, 1/10W         | 1   |         |
|        | R5612    | D1BB2002A055 | M 20KOHM, 1/10W         | 1   |         |
|        | R5613    | ERJ2GEJ5R6X  | M 5.6 OHM, J,0.063W     | 1   |         |
|        | R5622    | ERJ2GEJ5R6X  | M 5.6 OHM, J,0.063W     | 1   |         |
|        | R5629    | D1BB2101A055 | M 2.1KOHM, 1/10W        | 1   |         |
|        | R5630    | D1BB3301A055 | M 3.3KOHM, 1/10W        | 1   |         |
|        | R5631    | D1BB3901A055 | M 3.9KOHM, 1/10W        | 1   |         |
|        | R5632    | D1BB4021A055 | M4.02KOHM, 1/10W        | 1   |         |
|        | R5633    | D1BB1202A055 | M 12KOHM, 1/10W         | 1   |         |
|        | R5634    | D1BB1602A055 | M 16KOHM, 1/10W         | 1   |         |
|        | R5635    | ERJ2GEJ223   | M 22KOHM, J,0.063W      | 1   |         |
|        | R5636    | ERJ2GEJ683   | M 68KOHM, J,0.063W      | 1   |         |
|        | R5646    | ERJ2GEJ103   | M 10KOHM, J,0.063W      | 1   |         |
|        | R5647    | ERJ2GEJ473   | M 47KOHM, J,0.063W      | 1   |         |
|        | R5657    | ERJ2GEJ222   | M 2.2KOHM, J,0.063W     | 1   |         |
|        | R5658    | ERJ2GEJ473   | M 47KOHM, J,0.063W      | 1   |         |
|        | R5659    | ERJ2GEJ103   | M 10KOHM, J,0.063W      | 1   |         |
|        | R5668    | ERJ2GEJ222   | M 2.2KOHM, J,0.063W     | 1   |         |
|        | R5669    | ERJ2GEJ332   | M 3.3KOHM, J,0.063W     | 1   |         |
|        | R5670    | ERJ2GEJ102X  | M 1K OHM J 1/4W         | 1   |         |
|        | R5671    | ERJ2GEJ103   | M 10KOHM, J,0.063W      | 1   |         |
|        | R5672    | ERJ6GEYJ221V | M 220 OHM, J,1/10W      | 1   |         |
|        | R5674    | ERJ6GEYJ471  | M 470 OHM, J,1/10W      | 1   |         |
|        | R5676    | ERJ2GEJ221   | M 220 OHM, J,0.063W     | 1   |         |
|        | R5678    | ERJ2GEJ471   | M 470 OHM, J,0.063W     | 1   |         |
|        | R8004    | D1BB2402A055 | M 24KOHM, 1/10W         | 1   |         |
|        | R8005    | D1BB1002A055 | M 10KOHM, 1/10W         | 1   |         |
|        | R8006    | D1BB2402A055 | M 24KOHM, 1/10W         | 1   |         |
|        | R8007    | DOGBR00Z0002 | M 0 OHM J 1/16W         | 1   |         |
|        | R8026    | DOYAR0000007 | M 0 OHM 1/4W            | 1   |         |
|        | R8027    | DOYAR0000007 | M 0 OHM 1/4W            | 1   |         |
|        | R8030    | ERJ2GEJ101   | M 100 OHM, J,0.063W     | 1   |         |
|        | R8031    | ERJ2RKF1001  | M 1KOHM, 0.063W         | 1   |         |
|        | R8032    | ERJ2RKF1001  | M 1KOHM, 0.063W         | 1   |         |
|        | R8056    | ERJ2GEJ470   | M 47 OHM, J,0.063W      | 1   |         |
|        | R8057    | ERJ2GEJ470   | M 47 OHM, J,0.063W      | 1   |         |
|        | R8058    | ERJ2GEJ470   | M 47 OHM, J,0.063W      | 1   |         |

| Safety | Ref. No. | Part No.    | Part Name & Description | Pcs | Remarks |
|--------|----------|-------------|-------------------------|-----|---------|
|        | R8059    | ERJ2GEJ470  | M 47 OHM, J,0.063W      | 1   |         |
|        | R8060    | ERJ2GEJ470  | M 47 OHM, J,0.063W      | 1   |         |
|        | R8061    | ERJ2GEJ470  | M 47 OHM, J,0.063W      | 1   |         |
|        | R8062    | ERJ2GEJ470  | M 47 OHM, J,0.063W      | 1   |         |
|        | R8063    | ERJ2GEJ470  | M 47 OHM, J,0.063W      | 1   |         |
|        | R8064    | ERJ2GEJ470  | M 47 OHM, J,0.063W      | 1   |         |
|        | R8065    | ERJ2GEJ470  | M 47 OHM, J,0.063W      | 1   |         |
|        | R8066    | ERJ2GEJ470  | M 47 OHM, J,0.063W      | 1   |         |
|        | R8067    | ERJ2GEJ470  | M 47 OHM, J,0.063W      | 1   |         |
|        | R8068    | ERJ2GEJ470  | M 47 OHM, J,0.063W      | 1   |         |
|        | R8069    | ERJ2GEJ470  | M 47 OHM, J,0.063W      | 1   |         |
|        | R8070    | ERJ2GEJ470  | M 47 OHM, J,0.063W      | 1   |         |
|        | R8071    | ERJ2GEJ470  | M 47 OHM, J,0.063W      | 1   |         |
|        | R8072    | ERJ2GEJ470  | M 47 OHM, J,0.063W      | 1   |         |
|        | R8073    | ERJ2GEJ470  | M 47 OHM, J,0.063W      | 1   |         |
|        | R8074    | ERJ2GEJ221  | M 220 OHM, J,0.063W     | 1   |         |
|        | R8075    | ERJ2GEJ470  | M 47 OHM, J,0.063W      | 1   |         |
|        | R8076    | ERJ2GEJ470  | M 47 OHM, J,0.063W      | 1   |         |
|        | R8077    | ERJ2GEJ470  | M 47 OHM, J,0.063W      | 1   |         |
|        | R8078    | ERJ2GEJ470  | M 47 OHM, J,0.063W      | 1   |         |
|        | R8081    | ERJ2GEJ103  | M 10KOHM, J,0.063W      | 1   |         |
|        | R8082    | ERJ2RKF75R0 | M 75 OHM, , 0.063W      | 1   |         |
|        | R8083    | ERJ2GEJ301  | M 300 OHM, J,0.063W     | 1   |         |
|        | R8086    | ERJ2GEJ104  | M 100KOHM, J,0.063W     | 1   |         |
|        | R8088    | ERJ2GEJ103  | M 10KOHM, J,0.063W      | 1   |         |
|        | R8090    | ERJ2GEJ103  | M 10KOHM, J,0.063W      | 1   |         |
|        | R8091    | ERJ2GEJ470  | M 47 OHM, J,0.063W      | 1   |         |
|        | R8093    | ERJ2GEJ470  | M 47 OHM, J,0.063W      | 1   |         |
|        | R8095    | ERJ2GEJ103  | M 10KOHM, J,0.063W      | 1   |         |
|        | R8096    | ERJ2GEJ820  | M 82 OHM, J,0.063W      | 1   |         |
|        | R8097    | ERJ2GEJ221  | M 220 OHM, J,0.063W     | 1   |         |
|        | R8100    | ERJ2GEJ470  | M 47 OHM, J,0.063W      | 1   |         |
|        | R8101    | ERJ2GEJ103  | M 10KOHM, J,0.063W      | 1   |         |
|        | R8244    | ERJ2GEJ103  | M 10KOHM, J,0.063W      | 1   |         |
|        | R8245    | ERJ2GEJ103  | M 10KOHM, J,0.063W      | 1   |         |
|        | R8260    | ERJ2GEJ102X | M 1K OHM J 1/4W         | 1   |         |
|        | R8272    | ERJ2GEJ103  | M 10KOHM, J,0.063W      | 1   |         |
|        | R8301    | EXB2HV680J  | RESISTOR ARRAY          | 1   |         |
|        | R8305    | ERJ2GEJ102X | M 1K OHM J 1/4W         | 1   |         |
|        | R8308    | ERJ2GEJ680  | M 68 OHM, J,0.063W      | 1   |         |
|        | R8312    | ERJ2GEJ102X | M 1K OHM J 1/4W         | 1   |         |
|        | R8313    | ERJ2GEJ225  | M 1MOHM, J,0.063W       | 1   |         |

| Safety | Ref. No. | Part No.     | Part Name & Description | Pcs | Remarks |
|--------|----------|--------------|-------------------------|-----|---------|
|        | R8321    | ERJ2GEJ103   | M 10KOHM,<br>J,0.063W   | 1   |         |
|        | R8322    | ERJ2GEJ222   | M 2.2KOHM,<br>J,0.063W  | 1   |         |
|        | R8323    | ERJ2GEJ222   | M 2.2KOHM,<br>J,0.063W  | 1   |         |
|        | R8324    | ERJ2GEJ222   | M 2.2KOHM,<br>J,0.063W  | 1   |         |
|        | R8325    | ERJ2GEJ680   | M 68 OHM,<br>J,0.063W   | 1   |         |
|        | R8326    | ERJ2GEJ680   | M 68 OHM,<br>J,0.063W   | 1   |         |
|        | R8327    | ERJ2GEJ680   | M 68 OHM,<br>J,0.063W   | 1   |         |
|        | R8328    | ERJ2GEJ103   | M 10KOHM,<br>J,0.063W   | 1   |         |
|        | R8332    | EXB2HV101J   | RESISTOR ARRAY          | 1   |         |
|        | R8333    | EXB2HV101J   | RESISTOR ARRAY          | 1   |         |
|        | R8335    | EXB2HV680J   | RESISTOR ARRAY          | 1   |         |
|        | R8336    | EXB2HV680J   | RESISTOR ARRAY          | 1   |         |
|        | R8337    | EXB28V680JX  | RESISTOR ARRAY          | 1   |         |
|        | R8338    | ERJ2GEJ680   | M 68 OHM,<br>J,0.063W   | 1   |         |
|        | R8339    | ERJ2GEJ680   | M 68 OHM,<br>J,0.063W   | 1   |         |
|        | R8340    | DOYAR0000007 | M 0 OHM 1/4W            | 1   |         |
|        | R8345    | ERJ2GEJ103   | M 10KOHM,<br>J,0.063W   | 1   |         |
|        | R8347    | DOYAR0000007 | M 0 OHM 1/4W            | 1   |         |
|        | R8353    | ERJ2GEJ680   | M 68 OHM,<br>J,0.063W   | 1   |         |
|        | R8354    | ERJ2GEJ680   | M 68 OHM,<br>J,0.063W   | 1   |         |
|        | R8356    | DOYAR0000007 | M 0 OHM 1/4W            | 1   |         |
|        | R8395    | ERJ2GEJ103   | M 10KOHM,<br>J,0.063W   | 1   |         |
|        | R8404    | ERJ2GEJ103   | M 10KOHM,<br>J,0.063W   | 1   |         |
|        | R8405    | ERJ2GEJ103   | M 10KOHM,<br>J,0.063W   | 1   |         |
|        | R8406    | DOGFR10JA020 | M 1 OHM,J,0.33W         | 1   | PAVCCZ  |
|        | R8407    | ERJ2GEJ473   | M 47KOHM,<br>J,0.063W   | 1   |         |
|        | R8410    | ERJ2GEJ223   | M 22KOHM,<br>J,0.063W   | 1   |         |
|        | R8411    | ERJ2GEJ223   | M 22KOHM,<br>J,0.063W   | 1   |         |
|        | R8412    | ERJ2GEJ103   | M 10KOHM,<br>J,0.063W   | 1   |         |
|        | R8413    | ERJ2GEJ103   | M 10KOHM,<br>J,0.063W   | 1   |         |
|        | R8415    | ERJ2GEJ222   | M 2.2KOHM,<br>J,0.063W  | 1   |         |
|        | R8416    | ERJ2GEJ223   | M 22KOHM,<br>J,0.063W   | 1   |         |
|        | R8417    | ERJ2GEJ104   | M 100KOHM,<br>J,0.063W  | 1   |         |
|        | R8418    | ERJ2GEJ681   | M 680 OHM,<br>J,0.063W  | 1   |         |
|        | R8421    | ERJ2GEJ680   | M 68 OHM,<br>J,0.063W   | 1   |         |
|        | R8422    | ERJ2GEJ680   | M 68 OHM,<br>J,0.063W   | 1   |         |
|        | R8423    | ERJ2GEJ680   | M 68 OHM,<br>J,0.063W   | 1   |         |
|        | R8424    | ERJ2GEJ680   | M 68 OHM,<br>J,0.063W   | 1   |         |
|        | R8425    | ERJ2GEJ680   | M 68 OHM,<br>J,0.063W   | 1   |         |
|        | R8426    | EXB2HV680J   | RESISTOR ARRAY          | 1   |         |
|        | R8428    | EXB2HV680J   | RESISTOR ARRAY          | 1   |         |
|        | R8430    | ERJ2GEJ101   | M 100 OHM,<br>J,0.063W  | 1   |         |
|        | R8431    | ERJ2GEJ151   | M 150 OHM,<br>J,0.063W  | 1   |         |
|        | R8432    | ERJ2GEJ151   | M 150 OHM,<br>J,0.063W  | 1   |         |
|        | R8433    | ERJ2GEJ223   | M 22KOHM,<br>J,0.063W   | 1   |         |

| Safety | Ref. No. | Part No.    | Part Name & Description | Pcs | Remarks |
|--------|----------|-------------|-------------------------|-----|---------|
|        | R8434    | ERJ2GEJ473  | M 47KOHM,<br>J,0.063W   | 1   |         |
|        | R8435    | ERJ2GEJ103  | M 10KOHM,<br>J,0.063W   | 1   |         |
|        | R8436    | ERJ2GEJ103  | M 10KOHM,<br>J,0.063W   | 1   |         |
|        | R8437    | EXB2HV104JV | RESISTOR ARRAY          | 1   |         |
|        | R8438    | ERJ2GEJ104  | M 100KOHM,<br>J,0.063W  | 1   |         |
|        | R8439    | ERJ2GEJ680  | M 68 OHM,<br>J,0.063W   | 1   |         |
|        | R8440    | ERJ2GEJ104  | M 100KOHM,<br>J,0.063W  | 1   |         |
|        | R8441    | EXB2HV680J  | RESISTOR ARRAY          | 1   |         |
|        | R8442    | ERJ2GEJ680  | M 68 OHM,<br>J,0.063W   | 1   |         |
|        | R8445    | ERJ2GEJ104  | M 100KOHM,<br>J,0.063W  | 1   |         |
|        | R8446    | ERJ2GEJ680  | M 68 OHM,<br>J,0.063W   | 1   |         |
|        | R8449    | ERJ2GEJ680  | M 68 OHM,<br>J,0.063W   | 1   |         |
|        | R8450    | ERJ2GEJ103  | M 10KOHM,<br>J,0.063W   | 1   |         |
|        | R8453    | EXB2HV680J  | RESISTOR ARRAY          | 1   |         |
|        | R8454    | EXB28V151J  | RESISTOR ARRAY          | 1   |         |
|        | R8455    | EXB2HV680J  | RESISTOR ARRAY          | 1   |         |
|        | R8456    | ERJ2GEJ680  | M 68 OHM,<br>J,0.063W   | 1   |         |
|        | R8457    | ERJ2GEJ680  | M 68 OHM,<br>J,0.063W   | 1   |         |
|        | R8458    | ERJ2GEJ680  | M 68 OHM,<br>J,0.063W   | 1   |         |
|        | R8459    | ERJ2GEJ680  | M 68 OHM,<br>J,0.063W   | 1   |         |
|        | R8460    | ERJ2GEJ680  | M 68 OHM,<br>J,0.063W   | 1   |         |
|        | R8461    | ERJ2GEJ680  | M 68 OHM,<br>J,0.063W   | 1   |         |
|        | R8463    | EXB28V151J  | RESISTOR ARRAY          | 1   |         |
|        | R8464    | ERJ2GEJ680  | M 68 OHM,<br>J,0.063W   | 1   |         |
|        | R8465    | ERJ2GEJ103  | M 10KOHM,<br>J,0.063W   | 1   |         |
|        | R8466    | ERJ2GEJ103  | M 10KOHM,<br>J,0.063W   | 1   |         |
|        | R8467    | EXB28V151J  | RESISTOR ARRAY          | 1   |         |
|        | R8468    | ERJ2GEJ680  | M 68 OHM,<br>J,0.063W   | 1   |         |
|        | R8469    | ERJ2GEJ680  | M 68 OHM,<br>J,0.063W   | 1   |         |
|        | R8470    | EXB28V151J  | RESISTOR ARRAY          | 1   |         |
|        | R8471    | ERJ2GEJ103  | M 10KOHM,<br>J,0.063W   | 1   |         |
|        | R8476    | ERJ2GEJ103  | M 10KOHM,<br>J,0.063W   | 1   |         |
|        | R8477    | ERJ2GEJ103  | M 10KOHM,<br>J,0.063W   | 1   |         |
|        | R8479    | ERJ2GEJ103  | M 10KOHM,<br>J,0.063W   | 1   |         |
|        | R8487    | EXB28V680JX | RESISTOR ARRAY          | 1   |         |
|        | R8488    | EXB28V680JX | RESISTOR ARRAY          | 1   |         |
|        | R8489    | ERJ2GEJ680  | M 68 OHM,<br>J,0.063W   | 1   |         |
|        | R8491    | ERJ2GEJ223  | M 22KOHM,<br>J,0.063W   | 1   |         |
|        | R8494    | ERJ2GEJ222  | M 2.2KOHM,<br>J,0.063W  | 1   |         |
|        | R8496    | ERJ2GEJ222  | M 2.2KOHM,<br>J,0.063W  | 1   |         |
|        | R8501    | ERJ2GEJ101  | M 100 OHM,<br>J,0.063W  | 1   |         |
|        | R8502    | ERJ2GEJ331  | M 330 OHM,<br>J,0.063W  | 1   |         |
|        | R8503    | ERJ2GEJ331  | M 330 OHM,<br>J,0.063W  | 1   |         |
|        | R8504    | ERJ2GEJ331  | M 330 OHM,<br>J,0.063W  | 1   |         |
|        | R8506    | ERJ2GEJ331  | M 330 OHM,<br>J,0.063W  | 1   |         |



| Safety | Ref. No. | Part No.     | Part Name & Description | Pcs | Remarks |
|--------|----------|--------------|-------------------------|-----|---------|
|        | R8508    | ERJ2GEJ680   | M 68 OHM,<br>J,0.063W   | 1   |         |
|        | R8509    | D1BB1600A055 | M 160 OHM, 1/10W        | 1   | PAVCCZ  |
|        | R8510    | D1BB1600A055 | M 160 OHM, 1/10W        | 1   | PAVCCZ  |
|        | R8511    | ERJ2GEJ472   | M 4.7KOHM,<br>J,0.063W  | 1   |         |
|        | R8512    | ERJ2GEJ222   | M 2.2KOHM,<br>J,0.063W  | 1   |         |
|        | R8514    | ERJ2GEJ680   | M 68 OHM,<br>J,0.063W   | 1   |         |
|        | R8515    | ERJ2GEJ222   | M 2.2KOHM,<br>J,0.063W  | 1   |         |
|        | R8516    | ERJ2GEJ222   | M 2.2KOHM,<br>J,0.063W  | 1   |         |
|        | R8517    | ERJ2GEJ103   | M 10KOHM,<br>J,0.063W   | 1   |         |
|        | R8520    | ERJ2GEJ103   | M 10KOHM,<br>J,0.063W   | 1   |         |
|        | R8558    | ERJ2GEJ680   | M 68 OHM,<br>J,0.063W   | 1   |         |
|        | R8575    | ERJ2GEJ680   | M 68 OHM,<br>J,0.063W   | 1   |         |
|        | R8576    | ERJ2GEJ680   | M 68 OHM,<br>J,0.063W   | 1   |         |
|        | R8577    | ERJ2GEJ680   | M 68 OHM,<br>J,0.063W   | 1   |         |
|        | R8578    | ERJ2GEJ680   | M 68 OHM,<br>J,0.063W   | 1   |         |
|        | R8579    | ERJ2GEJ680   | M 68 OHM,<br>J,0.063W   | 1   |         |
|        | R8580    | ERJ2GEJ680   | M 68 OHM,<br>J,0.063W   | 1   |         |
|        | R8581    | ERJ2GEJ103   | M 10KOHM,<br>J,0.063W   | 1   |         |
|        | R8582    | ERJ2GEJ680   | M 68 OHM,<br>J,0.063W   | 1   |         |
|        | R8585    | ERJ2GEJ680   | M 68 OHM,<br>J,0.063W   | 1   |         |
|        | R8608    | ERJ2GEJ680   | M 68 OHM,<br>J,0.063W   | 1   |         |
|        | R8609    | ERJ2GEJ103   | M 10KOHM,<br>J,0.063W   | 1   |         |
|        | R8610    | ERJ2GEJ680   | M 68 OHM,<br>J,0.063W   | 1   |         |
|        | R8611    | ERJ2GEJ680   | M 68 OHM,<br>J,0.063W   | 1   |         |
|        | R8612    | ERJ2GEJ680   | M 68 OHM,<br>J,0.063W   | 1   |         |
|        | R8613    | ERJ2GEJ680   | M 68 OHM,<br>J,0.063W   | 1   |         |
|        | R8614    | ERJ2GEJ680   | M 68 OHM,<br>J,0.063W   | 1   |         |
|        | R8615    | ERJ2GEJ680   | M 68 OHM,<br>J,0.063W   | 1   |         |
|        | R8616    | ERJ2GEJ680   | M 68 OHM,<br>J,0.063W   | 1   |         |
|        | R8617    | ERJ2GEJ680   | M 68 OHM,<br>J,0.063W   | 1   |         |
|        | R8618    | ERJ2GEJ103   | M 10KOHM,<br>J,0.063W   | 1   |         |
|        | R8619    | ERJ2GEJ103   | M 10KOHM,<br>J,0.063W   | 1   |         |
|        | R8620    | ERJ2GEJ103   | M 10KOHM,<br>J,0.063W   | 1   |         |
|        | R8626    | ERJ2GEJ103   | M 10KOHM,<br>J,0.063W   | 1   |         |
|        | R8627    | ERJ2GEJ103   | M 10KOHM,<br>J,0.063W   | 1   |         |
|        | R8628    | ERJ2GEJ103   | M 10KOHM,<br>J,0.063W   | 1   |         |
|        | R8629    | ERJ2GEJ103   | M 10KOHM,<br>J,0.063W   | 1   |         |
|        | R8630    | ERJ2GEJ103   | M 10KOHM,<br>J,0.063W   | 1   |         |
|        | R8637    | ERJ2GEJ680   | M 68 OHM,<br>J,0.063W   | 1   |         |
|        | R8638    | ERJ2GEJ680   | M 68 OHM,<br>J,0.063W   | 1   |         |
|        | R8639    | ERJ2GEJ680   | M 68 OHM,<br>J,0.063W   | 1   |         |

| Safety | Ref. No. | Part No.     | Part Name & Description | Pcs | Remarks |
|--------|----------|--------------|-------------------------|-----|---------|
|        | R8640    | ERJ2GEJ103   | M 10KOHM,<br>J,0.063W   | 1   |         |
|        | R8641    | ERJ2GEJ103   | M 10KOHM,<br>J,0.063W   | 1   |         |
|        | R8642    | ERJ2GEJ103   | M 10KOHM,<br>J,0.063W   | 1   |         |
|        | R8644    | DOYAR0000007 | M 0 OHM 1/4W            | 1   |         |
|        | R8645    | ERJ2GEJ680   | M 68 OHM,<br>J,0.063W   | 1   |         |
|        | R8646    | ERJ2GEJ680   | M 68 OHM,<br>J,0.063W   | 1   |         |
|        | R8647    | ERJ2GEJ680   | M 68 OHM,<br>J,0.063W   | 1   |         |
|        | R8651    | ERJ2GEJ680   | M 68 OHM,<br>J,0.063W   | 1   |         |
|        | R8653    | ERJ2GEJ680   | M 68 OHM,<br>J,0.063W   | 1   |         |
|        | R8654    | ERJ2GEJ103   | M 10KOHM,<br>J,0.063W   | 1   |         |
|        | R8660    | DOYAR0000007 | M 0 OHM 1/4W            | 1   |         |
|        | R8661    | ERJ2GEJ103   | M 10KOHM,<br>J,0.063W   | 1   |         |
|        | R8663    | ERJ2GEJ103   | M 10KOHM,<br>J,0.063W   | 1   |         |
|        | R8665    | ERJ2GEJ222   | M 2.2KOHM,<br>J,0.063W  | 1   |         |
|        | R8667    | ERJ2GEJ680   | M 68 OHM,<br>J,0.063W   | 1   |         |
|        | R8670    | ERJ2GEJ222   | M 2.2KOHM,<br>J,0.063W  | 1   |         |
|        | R8671    | ERJ2GEJ222   | M 2.2KOHM,<br>J,0.063W  | 1   |         |
|        | R8672    | EXB2HV680J   | RESISTOR ARRAY          | 1   |         |
|        | R8673    | EXB2HV680J   | RESISTOR ARRAY          | 1   |         |
|        | R8674    | EXB2HV103JV  | RESISTOR ARRAY          | 1   |         |
|        | R8675    | ERJ2GEJ222   | M 2.2KOHM,<br>J,0.063W  | 1   |         |
|        | R8677    | ERJ2GEJ103   | M 10KOHM,<br>J,0.063W   | 1   |         |
|        | R8678    | ERJ2GEJ222   | M 2.2KOHM,<br>J,0.063W  | 1   |         |
|        | R8679    | ERJ2GEJ222   | M 2.2KOHM,<br>J,0.063W  | 1   |         |
|        | R8680    | ERJ2GEJ222   | M 2.2KOHM,<br>J,0.063W  | 1   |         |
|        | R8681    | ERJ2GEJ222   | M 2.2KOHM,<br>J,0.063W  | 1   |         |
|        | R8683    | ERJ2GEJ680   | M 68 OHM,<br>J,0.063W   | 1   |         |
|        | R8688    | EXB2HV680J   | RESISTOR ARRAY          | 1   |         |
|        | R8689    | EXB2HV680J   | RESISTOR ARRAY          | 1   |         |
|        | R8690    | EXB2HV680J   | RESISTOR ARRAY          | 1   |         |
|        | R8691    | ERJ2GEJ103   | M 10KOHM,<br>J,0.063W   | 1   |         |
|        | R8692    | ERJ2GEJ680   | M 68 OHM,<br>J,0.063W   | 1   |         |
|        | R8697    | ERJ2GEJ222   | M 2.2KOHM,<br>J,0.063W  | 1   |         |
|        | R8703    | ERJ2GEJ680   | M 68 OHM,<br>J,0.063W   | 1   |         |
|        | R8715    | ERJ2GEJ103   | M 10KOHM,<br>J,0.063W   | 1   |         |
|        | R8716    | ERJ2GEJ103   | M 10KOHM,<br>J,0.063W   | 1   |         |
|        | R8718    | ERJ2GEJ103   | M 10KOHM,<br>J,0.063W   | 1   |         |
|        | R8719    | EXB28V103JX  | RESISTOR ARRAY          | 1   |         |
|        | R8722    | EXB28V103JX  | RESISTOR ARRAY          | 1   |         |
|        | R8723    | ERJ2GEJ103   | M 10KOHM,<br>J,0.063W   | 1   |         |
|        | R8746    | ERJ2GEJ103   | M 10KOHM,<br>J,0.063W   | 1   |         |
|        | R8747    | ERJ2GEJ103   | M 10KOHM,<br>J,0.063W   | 1   |         |
|        | R8750    | ERJ2GEJ103   | M 10KOHM,<br>J,0.063W   | 1   |         |
|        | R8751    | ERJ2GEJ103   | M 10KOHM,<br>J,0.063W   | 1   |         |
|        | R8765    | ERJ2GEJ103   | M 10KOHM,<br>J,0.063W   | 1   |         |

| Safety | Ref. No. | Part No.     | Part Name & Description | Pcs | Remarks |
|--------|----------|--------------|-------------------------|-----|---------|
|        | R8767    | ERJ2GEJ103   | M 10KOHM, J, 0.063W     | 1   |         |
|        | R8768    | ERJ2GEJ103   | M 10KOHM, J, 0.063W     | 1   |         |
|        | R8802    | ERJ2GEJ680   | M 68 OHM, J, 0.063W     | 1   |         |
|        | R8803    | ERJ2GEJ680   | M 68 OHM, J, 0.063W     | 1   |         |
|        | R8804    | ERJ2GEJ680   | M 68 OHM, J, 0.063W     | 1   |         |
|        | R8805    | ERJ2GEJ680   | M 68 OHM, J, 0.063W     | 1   |         |
|        | R8806    | ERJ2GEJ680   | M 68 OHM, J, 0.063W     | 1   |         |
|        | R8807    | ERJ2GEJ680   | M 68 OHM, J, 0.063W     | 1   |         |
|        | R8808    | ERJ2GEJ680   | M 68 OHM, J, 0.063W     | 1   |         |
|        | R8855    | ERJ2GEJ103   | M 10KOHM, J, 0.063W     | 1   |         |
|        | R8856    | ERJ2GEJ680   | M 68 OHM, J, 0.063W     | 1   |         |
|        | R8857    | ERJ2GEJ680   | M 68 OHM, J, 0.063W     | 1   |         |
|        | R8858    | ERJ2GEJ680   | M 68 OHM, J, 0.063W     | 1   |         |
|        | R8859    | ERJ2GEJ680   | M 68 OHM, J, 0.063W     | 1   |         |
|        | R8860    | ERJ2GEJ680   | M 68 OHM, J, 0.063W     | 1   |         |
|        | R8862    | ERJ2GEJ680   | M 68 OHM, J, 0.063W     | 1   |         |
|        | R8864    | ERJ2GEJ680   | M 68 OHM, J, 0.063W     | 1   |         |
|        | R8898    | ERJ2GEJ103   | M 10KOHM, J, 0.063W     | 1   |         |
|        | R8899    | ERJ2GEJ680   | M 68 OHM, J, 0.063W     | 1   |         |
|        | R8954    | ERJ2GEJ680   | M 68 OHM, J, 0.063W     | 1   |         |
|        | R8959    | ERJ2GEJ680   | M 68 OHM, J, 0.063W     | 1   |         |
|        | R8960    | ERJ2GEJ680   | M 68 OHM, J, 0.063W     | 1   |         |
|        | R8963    | ERJ2GEJ103   | M 10KOHM, J, 0.063W     | 1   |         |
|        | R9062    | ERJ2GEJ101   | M 100 OHM, J, 0.063W    | 1   |         |
|        | R9063    | ERJ2GEJ101   | M 100 OHM, J, 0.063W    | 1   |         |
|        | R9064    | ERJ2GEJ101   | M 100 OHM, J, 0.063W    | 1   |         |
|        | R9065    | ERJ2GEJ101   | M 100 OHM, J, 0.063W    | 1   |         |
|        | R9066    | ERJ2GEJ101   | M 100 OHM, J, 0.063W    | 1   |         |
|        | R9067    | ERJ2GEJ101   | M 100 OHM, J, 0.063W    | 1   |         |
|        | R9068    | ERJ2GEJ103   | M 10KOHM, J, 0.063W     | 1   |         |
|        | R9070    | ERJ2GEJ103   | M 10KOHM, J, 0.063W     | 1   |         |
|        | R9071    | ERJ2GEJ223   | M 22KOHM, J, 0.063W     | 1   |         |
|        | R9072    | ERJ2GEJ102X  | M 1K OHM J 1/4W         | 1   |         |
|        | R9073    | ERJ2GEJ472   | M 4.7KOHM, J, 0.063W    | 1   |         |
|        | R9077    | D1BB1302A055 | M 13KOHM, 1/10W         | 1   |         |
|        | R9078    | D1BB4302A055 | M 43KOHM, 1/10W         | 1   |         |
|        | R9079    | D1BB2702A055 | M 27KOHM, 1/10W         | 1   |         |
|        | R9080    | D1BB1502A055 | M 15KOHM, 1/10W         | 1   |         |
|        | R9081    | D1BB4702A055 | M 47KOHM, 1/10W         | 1   |         |
|        | R9098    | ERJ2GEJ472   | M 4.7KOHM, J, 0.063W    | 1   |         |
|        | R9099    | ERJ2GEJ101   | M 100 OHM, J, 0.063W    | 1   |         |
|        | R9100    | ERJ2GEJ473   | M 47KOHM, J, 0.063W     | 1   |         |
|        | R9101    | ERJ2GEJ333   | M 33KOHM, J, 0.063W     | 1   |         |

| Safety | Ref. No. | Part No.    | Part Name & Description | Pcs | Remarks |
|--------|----------|-------------|-------------------------|-----|---------|
|        | R9102    | ERJ2GEJ101  | M 100 OHM, J, 0.063W    | 1   |         |
|        | R9104    | ERJ2GEJ472  | M 4.7KOHM, J, 0.063W    | 1   |         |
|        | R9105    | ERJ2GEJ103  | M 10KOHM, J, 0.063W     | 1   |         |
|        | R9106    | ERJ2GEJ104  | M 100KOHM, J, 0.063W    | 1   |         |
|        | R9107    | ERJ2GEJ332  | M 3.3KOHM, J, 0.063W    | 1   |         |
|        | R9108    | ERJ2GEJ103  | M 10KOHM, J, 0.063W     | 1   |         |
|        | R9109    | ERJ2GEJ103  | M 10KOHM, J, 0.063W     | 1   |         |
|        | R9110    | ERJ2GEJ101  | M 100 OHM, J, 0.063W    | 1   |         |
|        | R9112    | ERJ2GEJ103  | M 10KOHM, J, 0.063W     | 1   |         |
|        | R9113    | ERJ2GEJ104  | M 100KOHM, J, 0.063W    | 1   |         |
|        | R9114    | ERJ2GEJ472  | M 4.7KOHM, J, 0.063W    | 1   |         |
|        | R9115    | ERJ2GEJ101  | M 100 OHM, J, 0.063W    | 1   |         |
|        | R9116    | ERJ2GEJ101  | M 100 OHM, J, 0.063W    | 1   |         |
|        | R9117    | ERJ2GEJ103  | M 10KOHM, J, 0.063W     | 1   |         |
|        | R9118    | ERJ2GEJ103  | M 10KOHM, J, 0.063W     | 1   |         |
|        | R9119    | EXB38V470J  | RESISTOR ARRAY          | 1   |         |
|        | R9120    | ERJ2GEJ101  | M 100 OHM, J, 0.063W    | 1   |         |
|        | R9121    | ERJ2GEJ104  | M 100KOHM, J, 0.063W    | 1   |         |
|        | R9122    | ERJ2GEJ472  | M 4.7KOHM, J, 0.063W    | 1   |         |
|        | R9123    | ERJ2GEJ472  | M 4.7KOHM, J, 0.063W    | 1   |         |
|        | R9124    | ERJ2GEJ470  | M 47 OHM, J, 0.063W     | 1   |         |
|        | R9129    | ERJ2GEJ683  | M 68KOHM, J, 0.063W     | 1   |         |
|        | R9130    | ERJ2GEJ470  | M 47 OHM, J, 0.063W     | 1   |         |
|        | R9142    | ERJ2GEJ101  | M 100 OHM, J, 0.063W    | 1   |         |
|        | R9145    | ERJ2GEJ101  | M 100 OHM, J, 0.063W    | 1   |         |
|        | R9149    | ERJ2GEJ472  | M 4.7KOHM, J, 0.063W    | 1   |         |
|        | R9154    | ERJ2RHD272  | M 2.7KOHM, J, 2W        | 1   |         |
|        | R9155    | ERJ2RHD272  | M 2.7KOHM, J, 2W        | 1   |         |
|        | R9164    | ERJ2GEJ103  | M 10KOHM, J, 0.063W     | 1   |         |
|        | R9166    | ERJ2GEJ103  | M 10KOHM, J, 0.063W     | 1   |         |
|        | R9187    | ERJ2RHD272  | M 2.7KOHM, J, 2W        | 1   |         |
|        | R9188    | ERJ2RHD272  | M 2.7KOHM, J, 2W        | 1   |         |
|        | R9189    | ERJ2GEJ103  | M 10KOHM, J, 0.063W     | 1   |         |
|        | R9202    | ERJ2GEJ101  | M 100 OHM, J, 0.063W    | 1   |         |
|        | R9203    | ERJ2GEJ223  | M 22KOHM, J, 0.063W     | 1   |         |
|        | R9205    | ERJ2GEJ333  | M 33KOHM, J, 0.063W     | 1   |         |
|        | R9206    | ERJ2GED563X | M 56KOHM, J, 0.063W     | 1   |         |
|        | R9207    | ERJ2GEJ243  | M 24KOHM, J, 0.063W     | 1   |         |
|        | R9210    | ERJ2GEJ473  | M 47KOHM, J, 0.063W     | 1   |         |
|        | R9211    | ERJ2RHD272  | M 2.7KOHM, J, 2W        | 1   |         |
|        | R9214    | ERJ2RHD272  | M 2.7KOHM, J, 2W        | 1   |         |
|        | R9215    | ERJ2GEJ104  | M 100KOHM, J, 0.063W    | 1   |         |
|        | R9223    | ERJ2RHD272  | M 2.7KOHM, J, 2W        | 1   |         |
|        | R9225    | ERJ2RHD272  | M 2.7KOHM, J, 2W        | 1   |         |
|        | R9317    | ERJ2GEJ102X | M 1K OHM J 1/4W         | 1   |         |

| Safety | Ref. No. | Part No.     | Part Name & Description | Pcs | Remarks |
|--------|----------|--------------|-------------------------|-----|---------|
|        | R9347    | EXB2HV220JV  | RESISTOR ARRAY          | 1   |         |
|        | R9348    | EXB2HV220JV  | RESISTOR ARRAY          | 1   |         |
|        | R9350    | ERJ2GEJ470   | M 47 OHM,<br>J, 0.063W  | 1   |         |
|        | R9351    | ERJ2GEJ470   | M 47 OHM,<br>J, 0.063W  | 1   |         |
|        | R9352    | EXB2HV220JV  | RESISTOR ARRAY          | 1   |         |
|        | R9353    | EXB2HV220JV  | RESISTOR ARRAY          | 1   |         |
|        | R9354    | EXB2HV220JV  | RESISTOR ARRAY          | 1   |         |
|        | R9355    | EXB2HV220JV  | RESISTOR ARRAY          | 1   |         |
|        | R9356    | EXB2HV220JV  | RESISTOR ARRAY          | 1   |         |
|        | R9357    | EXB2HV220JV  | RESISTOR ARRAY          | 1   |         |
|        | R9358    | EXB2HV330JV  | RESISTOR ARRAY          | 1   |         |
|        | R9359    | EXB2HV330JV  | RESISTOR ARRAY          | 1   |         |
|        | R9360    | ERJ2GEJ332   | M 3.3KOHM,<br>J, 0.063W | 1   |         |
|        | R9361    | ERJ2GEJ470   | M 47 OHM,<br>J, 0.063W  | 1   |         |
|        | R9362    | ERJ2GEJ470   | M 47 OHM,<br>J, 0.063W  | 1   |         |
|        | R9363    | ERJ2GEJ103   | M 10KOHM,<br>J, 0.063W  | 1   |         |
|        | R9369    | ERJ2GEJ472   | M 4.7KOHM,<br>J, 0.063W | 1   |         |
|        | R9370    | ERJ2GEJ103   | M 10KOHM,<br>J, 0.063W  | 1   |         |
|        | R9371    | ERJ2GEJ104   | M 100KOHM,<br>J, 0.063W | 1   |         |
|        | R9385    | ERJ2GEJ472   | M 4.7KOHM,<br>J, 0.063W | 1   |         |
|        | R9391    | ERJ2GEJ104   | M 100KOHM,<br>J, 0.063W | 1   |         |
|        | R9396    | ERJ2GEJ470   | M 47 OHM,<br>J, 0.063W  | 1   |         |
|        | R9397    | ERJ2GEJ470   | M 47 OHM,<br>J, 0.063W  | 1   |         |
|        | R9398    | ERJ2GEJ470   | M 47 OHM,<br>J, 0.063W  | 1   |         |
|        | R9399    | ERJ2GEJ470   | M 47 OHM,<br>J, 0.063W  | 1   |         |
|        | R9401    | ERJ2GEJ102X  | M 1K OHM J 1/4W         | 1   |         |
|        | R9402    | ERJ2GEJ470   | M 47 OHM,<br>J, 0.063W  | 1   |         |
|        | R9403    | EXB2HV103JV  | RESISTOR ARRAY          | 1   |         |
|        | R9404    | EXB2HV103JV  | RESISTOR ARRAY          | 1   |         |
|        | R9405    | EXB2HV103JV  | RESISTOR ARRAY          | 1   |         |
|        | R9406    | EXB2HV103JV  | RESISTOR ARRAY          | 1   |         |
|        | R9407    | D0GDR00Z0002 | M 0 OHM, 1/10W          | 1   |         |
|        | R9408    | D0GDR00Z0002 | M 0 OHM, 1/10W          | 1   |         |
|        | R9578    | ERJ2GEJ472   | M 4.7KOHM,<br>J, 0.063W | 1   |         |
|        | R9586    | ERJ2GEJ470   | M 47 OHM,<br>J, 0.063W  | 1   |         |
|        | R9587    | ERJ2GEJ470   | M 47 OHM,<br>J, 0.063W  | 1   |         |
|        | R9592    | D0GA103JA015 | M 10KOHM, J, 1/16W      | 1   |         |
|        | R9594    | ERJ2GEJ103   | M 10KOHM,<br>J, 0.063W  | 1   |         |
|        | R9598    | ERJ2GEJ470   | M 47 OHM,<br>J, 0.063W  | 1   |         |
|        | R9604    | ERJ2GEJ103   | M 10KOHM,<br>J, 0.063W  | 1   |         |
|        | R9608    | EXB2HV470JV  | RESISTOR ARRAY          | 1   |         |
|        | R9609    | EXB28V470JX  | RESISTOR ARRAY          | 1   |         |
|        | R9610    | EXB2HV470JV  | RESISTOR ARRAY          | 1   |         |
|        | R9611    | ERJ2GEJ680   | M 68 OHM,<br>J, 0.063W  | 1   |         |
|        | R9616    | ERJ2GEJ470   | M 47 OHM,<br>J, 0.063W  | 1   |         |
|        | R9618    | ERJ2GEJ331   | M 330 OHM,<br>J, 0.063W | 1   |         |
|        | R9839    | EXB38V101JV  | RESISTOR ARRAY          | 1   |         |
|        | R9848    | EXB2HV470JV  | RESISTOR ARRAY          | 1   |         |
|        | R9849    | EXB2HV470JV  | RESISTOR ARRAY          | 1   |         |
|        | R9868    | ERJ2GEJ104   | M 100KOHM,<br>J, 0.063W | 1   |         |
|        | R9871    | ERJ2GEJ103   | M 10KOHM,<br>J, 0.063W  | 1   |         |

| Safety | Ref. No. | Part No.     | Part Name & Description | Pcs | Remarks |
|--------|----------|--------------|-------------------------|-----|---------|
|        | R9872    | D1BB1002A055 | M 10KOHM, 1/10W         | 1   |         |
|        | R9873    | ERJ14YJ120   | M 12 OHM, J, 1/4W       | 1   |         |
|        | R9893    | D1BB2702A055 | M 27KOHM, 1/10W         | 1   |         |
|        | R9894    | D1BB2002A055 | M 20KOHM, 1/10W         | 1   |         |
|        | R9895    | D1BB11030002 | M 110KOHM, 1/10W        | 1   |         |
|        | R9896    | D1BB4702A055 | M 47KOHM, 1/10W         | 1   |         |
|        | R9897    | ERJ2GEJ103   | M 10KOHM,<br>J, 0.063W  | 1   |         |
|        | R9898    | ERJ2GEJ103   | M 10KOHM,<br>J, 0.063W  | 1   |         |
|        | R9899    | ERJ2GEJ103   | M 10KOHM,<br>J, 0.063W  | 1   |         |
|        | R9900    | ERJ14YJ120   | M 12 OHM, J, 1/4W       | 1   |         |
|        | R9902    | D0GBR00Z0002 | M 0 OHM J 1/16W         | 1   |         |
|        | R9903    | EXB2HV470JV  | RESISTOR ARRAY          | 1   |         |
|        | R9905    | ERJ2RKD330   | M 33 OHM, J, 2W         | 1   |         |
|        | R9906    | EXB38V470J   | RESISTOR ARRAY          | 1   |         |
|        | R9907    | ERJ2GEJ151   | M 150 OHM,<br>J, 0.063W | 1   |         |
|        | R9936    | D1BB1001A055 | M 1KOHM, 1/16W          | 1   |         |
|        | R9937    | D1BB1001A055 | M 1KOHM, 1/16W          | 1   |         |
|        | R9938    | D1BB1001A055 | M 1KOHM, 1/16W          | 1   |         |
|        | R9939    | D1BB1001A055 | M 1KOHM, 1/16W          | 1   |         |
|        | R9940    | ERJ2RKD330   | M 33 OHM, J, 2W         | 1   |         |
|        | R9943    | EXB2HV470JV  | RESISTOR ARRAY          | 1   |         |
|        | R9944    | EXB38V470J   | RESISTOR ARRAY          | 1   |         |
|        | R9945    | EXB38V470J   | RESISTOR ARRAY          | 1   |         |
|        | R9946    | EXB38V470J   | RESISTOR ARRAY          | 1   |         |
|        | R9947    | EXB38V470J   | RESISTOR ARRAY          | 1   |         |
|        | R9948    | EXB38V470J   | RESISTOR ARRAY          | 1   |         |
|        | R9949    | EXB38V470J   | RESISTOR ARRAY          | 1   |         |
|        | R9950    | EXB38V470J   | RESISTOR ARRAY          | 1   |         |
|        | R9951    | EXB38V470J   | RESISTOR ARRAY          | 1   |         |
|        | R9952    | ERJ2GEJ470   | M 47 OHM,<br>J, 0.063W  | 1   |         |
|        | R9953    | ERJ2GEJ470   | M 47 OHM,<br>J, 0.063W  | 1   |         |
|        | R9954    | ERJ2GEJ470   | M 47 OHM,<br>J, 0.063W  | 1   |         |
|        | R9955    | ERJ2GEJ470   | M 47 OHM,<br>J, 0.063W  | 1   |         |
|        | R9966    | ERJ2GEJ471   | M 470 OHM,<br>J, 0.063W | 1   |         |
|        | R9967    | ERJ2GEJ470   | M 47 OHM,<br>J, 0.063W  | 1   |         |
|        | R9968    | ERJ2GEJ470   | M 47 OHM,<br>J, 0.063W  | 1   |         |
|        | R9969    | ERJ2GEJ470   | M 47 OHM,<br>J, 0.063W  | 1   |         |
|        | R9970    | ERJ2GEJ470   | M 47 OHM,<br>J, 0.063W  | 1   |         |
|        | R9972    | ERJ2GEJ103   | M 10KOHM,<br>J, 0.063W  | 1   |         |
|        | R9975    | ERJ2GEJ470   | M 47 OHM,<br>J, 0.063W  | 1   |         |
|        | R9977    | ERJ2GEJ470   | M 47 OHM,<br>J, 0.063W  | 1   |         |
|        | R9983    | ERJ2GEJ470   | M 47 OHM,<br>J, 0.063W  | 1   |         |
|        | R9987    | ERJ2GEJ470   | M 47 OHM,<br>J, 0.063W  | 1   |         |
|        | R9988    | ERJ2GEJ470   | M 47 OHM,<br>J, 0.063W  | 1   |         |
|        | R9989    | ERJ2GEJ470   | M 47 OHM,<br>J, 0.063W  | 1   |         |
|        | R9990    | ERJ2GEJ101   | M 100 OHM,<br>J, 0.063W | 1   |         |
|        | R16001   | D0GF7R5JA047 | M 7.5 OHM, J,<br>0.33W  | 1   |         |
|        | R16002   | D0GF7R5JA047 | M 7.5 OHM, J,<br>0.33W  | 1   |         |
|        | R16021   | D0GF7R5JA047 | M 7.5 OHM, J,<br>0.33W  | 1   |         |
|        | R16022   | D0GF7R5JA047 | M 7.5 OHM, J,<br>0.33W  | 1   |         |
|        | R16101   | D0GD221JA059 | M 220 OHM, J, 1/<br>10W | 1   |         |

| Safety | Ref. No. | Part No.     | Part Name & Description | Pcs | Remarks |
|--------|----------|--------------|-------------------------|-----|---------|
|        | R16102   | D0GD221JA059 | M 220 OHM,J,1/10W       | 1   |         |
|        | R16103   | D0GD100JA059 | M 10 OHM,J,0.25W        | 1   |         |
|        | R16104   | D0GD100JA059 | M 10 OHM,J,0.25W        | 1   |         |
|        | R16105   | ERJ8GEYJ474  | M 470KOHM, J,1/8W       | 1   |         |
|        | R16109   | D0GD100JA059 | M 10 OHM,J,0.25W        | 1   |         |
|        | R16110   | ERJ6GEYF473  | M 47KOHM,J,1/10W        | 1   |         |
|        | R16116   | ERJ6GEYF473  | M 47KOHM,J,1/10W        | 1   |         |
|        | R16131   | D0GD101JA036 | M 100 OHM,J,0.25W       | 1   |         |
|        | R16132   | D0GD101JA036 | M 100 OHM,J,0.25W       | 1   |         |
|        | R16134   | D0GD750JA059 | M 75 OHM,J,0.25W        | 1   |         |
|        | R16137   | D0GF1R0JA047 | M 1.0 OHM,J,0.33W       | 1   |         |
|        | R16141   | D0GD100JA059 | M 10 OHM,J,0.25W        | 1   |         |
|        | R16142   | ERJ6GEYF473  | M 47KOHM,J,1/10W        | 1   |         |
|        | R16143   | ERJ6GEYF473  | M 47KOHM,J,1/10W        | 1   |         |
|        | R16161   | D0GD100JA059 | M 10 OHM,J,0.25W        | 1   |         |
|        | R16162   | ERJ6GEYF473  | M 47KOHM,J,1/10W        | 1   |         |
|        | R16163   | ERJ6GEYF473  | M 47KOHM,J,1/10W        | 1   |         |
|        | R16191   | ERJ6GEYJ151V | M 150 OHM,J,1/10W       | 1   |         |
|        | R16192   | ERJ6GEYJ103V | M 10K OHM J 1/10W       | 1   |         |
|        | R16193   | ERJ6GEYJ750  | M 75 OHM,J,1/10W        | 1   |         |
|        | R16194   | D0GF7R5JA047 | M 7.5 OHM,J,0.33W       | 1   |         |
|        | R16195   | D0GF1R0JA047 | M 1.0 OHM,J,0.33W       | 1   |         |
|        | R16196   | D0GF7R5JA047 | M 7.5 OHM,J,0.33W       | 1   |         |
|        | R16241   | EXB38V470J   | RESISTOR ARRAY          | 1   |         |
|        | R16242   | EXB38V472JV  | RESISTOR ARRAY          | 1   |         |
|        | R16280   | ERJ6GEYJ222V | M 2.2K OHM J 1/10W      | 1   |         |
|        | R16281   | D0GD103JA036 | M 10KOHM,J,0.25W        | 1   |         |
|        | R16282   | ERJ6GEYJ221V | M 220 OHM,J,1/10W       | 1   |         |
|        | R16283   | ERJ6GEYF473  | M 47KOHM,J,1/10W        | 1   |         |
|        | R16284   | ERJ6GEYJ224  | M 220KOHM,J,1/10W       | 1   |         |
|        | R16285   | EXB38V623J   | RESISTOR ARRAY          | 1   |         |
|        | R16288   | D0GF334JA047 | M 330KOHM,F,0.33W       | 1   | PAVCCZ  |
|        | R16289   | D0GF334JA047 | M 330KOHM,F,0.33W       | 1   | PAVCCZ  |
|        | R16290   | D0GF334JA047 | M 330KOHM,F,0.33W       | 1   | PAVCCZ  |
|        | R16302   | ERJ8GEYJ333  | M 33KOHM, J,1/8W        | 1   |         |
|        | R16307   | ERJ6RBD513   | M 5.1KOHM,J,1/10W       | 1   | PAVCCZ  |
|        | R16309   | ERJ8GEYJ333  | M 33KOHM, J,1/8W        | 1   |         |
|        | R16310   | ERJ8GEYJ333  | M 33KOHM, J,1/8W        | 1   |         |
|        | R16311   | ERJ8GEYJ333  | M 33KOHM, J,1/8W        | 1   |         |
|        | R16317   | ERJ6RBD243   | M 2.4KOHM,J,1/10W       | 1   |         |
|        | R16318   | ERJ6RBD433   | M 4.3KOHM,J,1/10W       | 1   | PAVCCZ  |
|        | R16319   | ERJ6RBD242   | M 2.4KOHM,J,1/10W       | 1   |         |
|        | R16320   | ERJ14YJ683   | M 68KOHM, 1/2W          | 1   | PAVCCZ  |
|        | R16330   | ERJ6GEYJ102V | M 1K OHM J 1/10W        | 1   |         |
|        | R16332   | ERJ6GEYJ474  | M 470KOHM,J,1/10W       | 1   |         |
|        | R16334   | ERJ6GEYJ472V | M 4.7K OHM J 1/10W      | 1   |         |
|        | R16335   | ERJ6GEYJ102V | M 1K OHM J 1/10W        | 1   |         |
|        | R16401   | ERJT08J7R5V  | M 7.5OHM,J,0.33W        | 1   |         |
|        | R16402   | ERJT08J7R5V  | M 7.5OHM,J,0.33W        | 1   |         |
|        | R16410   | ERJ6GEYG391  | M 390 OHM,F,1/10W       | 1   |         |
|        | R16411   | D1BD2700A044 | M 270 OHM, 1/10W        | 1   |         |
|        | R16414   | ERJ6GEYJ331V | M 330 OHM J 1/10W       | 1   |         |

| Safety | Ref. No. | Part No.     | Part Name & Description | Pcs | Remarks |
|--------|----------|--------------|-------------------------|-----|---------|
|        | R16415   | ERJ6GEYJ331V | M 330 OHM J 1/10W       | 1   |         |
|        | R16416   | D0GD103JA036 | M 10KOHM,J,0.25W        | 1   |         |
|        | R16421   | ERJT08J7R5V  | M 7.5OHM,J,0.33W        | 1   |         |
|        | R16422   | ERJT08J7R5V  | M 7.5OHM,J,0.33W        | 1   |         |
|        | R16441   | ERJT08J5R6V  | M 5.6 OHM,F,0.33W       | 1   |         |
|        | R16451   | ERJT08J5R6V  | M 5.6 OHM,F,0.33W       | 1   |         |
|        | R16471   | ERJ6GEYG392  | M 3.9KOHM,J,1/10W       | 1   |         |
|        | R16472   | ERJ6GEYJ222V | M 2.2K OHM J 1/10W      | 1   |         |
|        | R16473   | ERJ6GEYF561  | M 560 OHM,F,1/10W       | 1   |         |
|        | R16474   | ERJ6GEYJ102V | M 1K OHM J 1/10W        | 1   |         |
|        | R16475   | ERJ6GEYJ472V | M 4.7K OHM J 1/10W      | 1   |         |
|        | R16476   | ERJ6GEYJ472V | M 4.7K OHM J 1/10W      | 1   |         |
|        | R16478   | ERJ6GEYJ562V | M 5.6KOHM,J,1/10W       | 1   |         |
|        | R16479   | D0GD103JA036 | M 10KOHM,J,0.25W        | 1   |         |
|        | R16480   | ERJ6GEYJ472V | M 4.7K OHM J 1/10W      | 1   |         |
|        | R16490   | ERJ6RBD104   | M 100KOHM, 1/10W        | 1   |         |
|        | R16491   | ERJ6RED114   | M 110KOHM, 1/10W        | 1   |         |
|        | R16492   | ERJ6RED124   | M 120KOHM, 1/10W        | 1   |         |
|        | R16493   | ERJ6RBD4221  | M 4.22KOHM, 1/10W       | 1   |         |
|        | R16494   | D1BD2001A044 | M 2KOHM, 1/10W          | 1   |         |
|        | R16495   | D1BD3900A044 | M 390 OHM, 1/10W        | 1   |         |
|        | R16496   | ERJ6GEYJ470V | M 47 OHM,J,1/10W        | 1   |         |
|        | R16497   | ERJ6GEYF473  | M 47KOHM,J,1/10W        | 1   |         |
|        | R16498   | ERJ6GEYJ103V | M 10K OHM J 1/10W       | 1   |         |
|        | R16501   | D0GD101JA036 | M 100 OHM,J,0.25W       | 1   |         |
|        | R16502   | D0GD101JA036 | M 100 OHM,J,0.25W       | 1   |         |
|        | R16503   | ERJT06J100V  | M 10 OHM,F,0.25W        | 1   |         |
|        | R16504   | ERJT06J750V  | M 75 OHM,F,0.25W        | 1   |         |
|        | R16506   | ERJT06J100V  | M 10 OHM,F,0.25W        | 1   |         |
|        | R16510   | ERJT14J1R0V  | M 1.0 OHM, J,1/4W       | 1   |         |
|        | R16511   | ERJ6GEYF473  | M 47KOHM,J,1/10W        | 1   |         |
|        | R16512   | ERJ6GEYF473  | M 47KOHM,J,1/10W        | 1   |         |
|        | R16516   | ERJ6GEYF473  | M 47KOHM,J,1/10W        | 1   |         |
|        | R16517   | ERJ6GEYF473  | M 47KOHM,J,1/10W        | 1   |         |
|        | R16521   | D0GD101JA036 | M 100 OHM,J,0.25W       | 1   |         |
|        | R16522   | D0GD101JA036 | M 100 OHM,J,0.25W       | 1   |         |
|        | R16523   | ERJT06J750V  | M 75 OHM,F,0.25W        | 1   |         |
|        | R16524   | ERJT06J750V  | M 75 OHM,F,0.25W        | 1   |         |
|        | R16531   | ERJT06J100V  | M 10 OHM,F,0.25W        | 1   |         |
|        | R16532   | ERJ6GEYF473  | M 47KOHM,J,1/10W        | 1   |         |
|        | R16533   | ERJ6GEYF473  | M 47KOHM,J,1/10W        | 1   |         |
|        | R16534   | ERJT08J1R0V  | M 1.8OHM,J,0.33W        | 1   |         |
|        | R16536   | ERJT08J1R0V  | M 1.8OHM,J,0.33W        | 1   |         |
|        | R16551   | ERJT06J100V  | M 10 OHM,F,0.25W        | 1   |         |
|        | R16552   | ERJ6GEYF473  | M 47KOHM,J,1/10W        | 1   |         |
|        | R16553   | ERJ6GEYF473  | M 47KOHM,J,1/10W        | 1   |         |
|        | R16561   | EXB38V470J   | RESISTOR ARRAY          | 1   |         |
|        | R16562   | EXB38V470J   | RESISTOR ARRAY          | 1   |         |
|        | R16563   | EXB38V470J   | RESISTOR ARRAY          | 1   |         |
|        | R16564   | EXB38V470J   | RESISTOR ARRAY          | 1   |         |
|        | R16565   | EXB38V472JV  | RESISTOR ARRAY          | 1   |         |
|        | R16566   | EXB38V472JV  | RESISTOR ARRAY          | 1   |         |
|        | R16567   | EXB38V472JV  | RESISTOR ARRAY          | 1   |         |
|        | R16568   | EXB38V472JV  | RESISTOR ARRAY          | 1   |         |
|        | R16570   | ERJ6GEYJ472V | M 4.7K OHM J 1/10W      | 1   |         |
|        | R16579   | ERJ6GEYJ470V | M 47 OHM,J,1/10W        | 1   |         |

| Safety | Ref. No. | Part No.     | Part Name & Description | Pcs | Remarks |
|--------|----------|--------------|-------------------------|-----|---------|
|        | R16580   | ERJ6GEYJ222V | M 2.2K OHM J 1/10W      | 1   |         |
|        | R16582   | ERJT08J393V  | M 39 KOHM,J, 0.33W      | 1   | PAVCCZ  |
|        | R16583   | ERJT08J393V  | M 39 KOHM,J, 0.33W      | 1   | PAVCCZ  |
|        | R16584   | D1BD6811A044 | M6.81KOHM, 1/10W        | 1   |         |
|        | R16585   | D1BD1001A044 | M 1KOHM, 1/10W          | 1   |         |
|        | R16586   | D1BD1691A044 | M1.69KOHM, 1/10W        | 1   |         |
|        | R16587   | ERJ6GEYJ222V | M 2.2K OHM J 1/10W      | 1   |         |
|        | R16588   | D0GD103JA036 | M 10KOHM,J,0.25W        | 1   |         |
|        | R16589   | D0GD103JA036 | M 10KOHM,J,0.25W        | 1   |         |
|        | R16590   | ERJ6GEYJ221V | M 220 OHM,J,1/10W       | 1   |         |
|        | R16591   | EXB38V472JV  | RESISTOR ARRAY          | 1   |         |
|        | R16592   | ERJ6GEYJ472V | M 4.7K OHM J 1/10W      | 1   |         |
|        | R16593   | D1BD1331A044 | M 1.33K OHM 1/10W       | 1   |         |
|        | R16602   | ERJ6GEYJ102V | M 1K OHM J 1/10W        | 1   |         |
|        | R16604   | ERJ6GEYJ331V | M 330 OHM J 1/10W       | 1   |         |
|        | R16605   | ERJ6GEYJ182  | M 1.8KOHM,J,1/10W       | 1   |         |
|        | R16606   | D0GD103JA036 | M 10KOHM,J,0.25W        | 1   |         |
|        | R16607   | D1BD6651A044 | M6.65KOHM, 1/10W        | 1   |         |
|        | R16608   | ERJT08J102V  | M 1KOHM,J, 0.33W        | 1   |         |
|        | R16609   | ERJT08J102V  | M 1KOHM,J, 0.33W        | 1   |         |
|        | R16610   | ERJ6GEYJ104V | M 100KOHM,J,1/10W       | 1   |         |
|        | R16611   | ERJ8GEYJ683  | M 68KOHM, J,1/8W        | 1   |         |
|        | R16612   | ERJT06J470V  | M 47 OHM,F,0.25W        | 1   |         |
|        | R16613   | ERJ8GEYJ473  | M 47KOHM, J,1/8W        | 1   |         |
|        | R16614   | ERJ8GEYJ683  | M 68KOHM, J,1/8W        | 1   |         |
|        | R16615   | D1BD1131A044 | M1.13KOHM, 1/10W        | 1   |         |
|        | R16617   | ERJ6GEYJ222V | M 2.2K OHM J 1/10W      | 1   |         |
|        | R16619   | ERJT08J1ROV  | M 1.8OHM,J, 0.33W       | 1   |         |
|        | R16621   | ERJT06J221V  | M 220 OHM,F,0.25W       | 1   |         |
|        | R16622   | ERJT06J221V  | M 220 OHM,F,0.25W       | 1   |         |
|        | R16627   | ERJ6GEYJ220  | M 22 OHM,J,1/10W        | 1   |         |
|        | R16628   | ERJ6GEYF473  | M 47KOHM,J,1/10W        | 1   |         |
|        | R16631   | D0GD103JA036 | M 10KOHM,J,0.25W        | 1   |         |
|        | R16633   | ERJ6GEYJ223  | M 22KOHM,J,1/10W        | 1   |         |
|        | R16634   | ERJ6GEYJ471  | M 470 OHM,J,1/10W       | 1   |         |
|        | R16658   | D1BD8661A044 | M86.6KOHM, 1/10W        | 1   |         |
|        | R16661   | ERJ6GEYJ122V | M 1.2KOHM,J,1/10W       | 1   |         |
|        | R16663   | D1BD5231A044 | M5.23KOHM, 1/10W        | 1   |         |
|        | R16664   | ERJT08J102V  | M 1KOHM,J, 0.33W        | 1   |         |
|        | R16665   | ERJT06J330V  | M 33 OHM,F,0.25W        | 1   |         |
|        | R16666   | D0GD103JA036 | M 10KOHM,J,0.25W        | 1   |         |
|        | R16673   | ERJ6GEYJ472V | M 4.7K OHM J 1/10W      | 1   |         |
|        | R16674   | ERJT08J102V  | M 1KOHM,J, 0.33W        | 1   |         |
|        | R16675   | ERJ6GEYJ472V | M 4.7K OHM J 1/10W      | 1   |         |
|        | R16679   | D1BD1002A044 | M10.0KOHM, 1/10W        | 1   |         |
|        | R16680   | D1BD7501A044 | M 7.5KOHM, 1/10W        | 1   |         |
|        | R16681   | ERJT06J100V  | M 10 OHM,F,0.25W        | 1   |         |
|        | R16682   | ERJT06J100V  | M 10 OHM,F,0.25W        | 1   |         |
|        | R16684   | ERJ6GEYJ221V | M 220 OHM,J,1/10W       | 1   |         |
|        | R16685   | ERJ6GEYJ221V | M 220 OHM,J,1/10W       | 1   |         |
|        | R16686   | D0GD103JA036 | M 10KOHM,J,0.25W        | 1   |         |
|        | R16691   | ERJ8GEYJ563  | M 56KOHM, J,1/8W        | 1   |         |
|        | R16692   | ERJ6RBD152   | M 1.5KOHM,J,1/10W       | 1   |         |
|        | R16694   | ERJ8GEYJ563  | M 56KOHM, J,1/8W        | 1   |         |
|        | R16695   | ERJ6RBD152   | M 1.5KOHM,J,1/10W       | 1   |         |

| Safety | Ref. No. | Part No.     | Part Name & Description | Pcs | Remarks |
|--------|----------|--------------|-------------------------|-----|---------|
|        | R16696   | ERF5TK2R2    | W 2.2 OHM, K, 5W        | 1   |         |
|        | R16699   | D0GD103JA036 | M 10KOHM,J,0.25W        | 1   |         |
|        | R16707   | ERJ6GEYJ392  | M 3.9KOHM,J,1/10W       | 1   |         |
|        | R16711   | ERJ6GEYJ472V | M 4.7K OHM J 1/10W      | 1   |         |
|        | R16712   | ERJ6GEYJ102V | M 1K OHM J 1/10W        | 1   |         |
|        | R16713   | ERG1FJS104D  | M 100KOHM, J, 1W        | 1   |         |
|        | R16714   | ERJ6GEYF473  | M 47KOHM,J,1/10W        | 1   |         |
|        | R16715   | ERJ6GEYJ103V | M 10K OHM J 1/10W       | 1   |         |
|        | R16717   | ERJ6GEYJ102V | M 1K OHM J 1/10W        | 1   |         |
|        | R16720   | ERJ3GEYJ220  | M 22 OHM,J,1/16W        | 1   |         |
|        | R16721   | ERJ3GEYJ220  | M 22 OHM,J,1/16W        | 1   |         |
|        | R16722   | ERJ3GEYJ220  | M 22 OHM,J,1/16W        | 1   |         |
|        | R16723   | ERJ3GEYJ220  | M 22 OHM,J,1/16W        | 1   |         |
|        | R16731   | ERG2FJS104D  | M 100KOHM, J, 2W        | 1   |         |
|        | R16733   | ERJ6GEYJ474  | M 470KOHM,J,1/10W       | 1   |         |
|        | R16734   | D1BD4991A044 | M4.99KOHM, 1/10W        | 1   |         |
|        | R16735   | D1BD1873A044 | M 187KOHM, 1/10W        | 1   |         |
|        | R16736   | D1BD1873A044 | M 187KOHM, 1/10W        | 1   |         |
|        | R16737   | D1BD2053A044 | M 205KOHM, 1/10W        | 1   |         |
|        | R16744   | D1BD1273A044 | M 127KOHM, 1/10W        | 1   |         |
|        | R16749   | D0GD103JA036 | M 10KOHM,J,0.25W        | 1   |         |
|        | R16750   | ERJT06J123   | D0GD123JA059            | 1   |         |
|        | R16751   | ERJT06J154V  | M 150KOHM,F,0.25W       | 1   |         |
|        | R16752   | ERJ6GEYJ472V | M 4.7K OHM J 1/10W      | 1   |         |
|        | R16753   | ERJ6GEYJ224  | M 220KOHM,J,1/10W       | 1   |         |
|        | R16755   | ERJT06J123   | D0GD123JA059            | 1   |         |
|        | R16756   | ERJT06J123   | D0GD123JA059            | 1   |         |
|        | R16761   | ERJT06J100V  | M 10 OHM,F,0.25W        | 1   |         |
|        | R16762   | ERJ6GEYF473  | M 47KOHM,J,1/10W        | 1   |         |
|        | R16763   | ERJ6GEYF473  | M 47KOHM,J,1/10W        | 1   |         |
|        | R16765   | ERJT08J1ROV  | M 1.8OHM,J, 0.33W       | 1   |         |
|        | R16766   | D0GDR00Z0002 | M 0 OHM, 1/10W          | 1   |         |
|        | R16769   | ERJT06J750V  | M 75 OHM,F,0.25W        | 1   |         |
|        | R16772   | ERJ6GEYJ472V | M 4.7K OHM J 1/10W      | 1   |         |
|        | R16773   | ERJ6GEYJ102V | M 1K OHM J 1/10W        | 1   |         |
|        | R16774   | ERG1SJ273    | M 27KOHM, J, 1W         | 1   |         |
|        | R16775   | ERJ6GEYJ472V | M 4.7K OHM J 1/10W      | 1   |         |
|        | R16776   | ERJ6GEYJ470V | M 47 OHM,J,1/10W        | 1   |         |
|        | R16777   | ERJ6GEYJ103V | M 10K OHM J 1/10W       | 1   |         |
|        | R16783   | ERJT06J154V  | M 150KOHM,F,0.25W       | 1   |         |
|        | R16785   | D1BD1003A044 | M 100KOHM, 1/10W        | 1   |         |
|        | R16786   | D1BD1003A044 | M 100KOHM, 1/10W        | 1   |         |
|        | R16787   | D1BD3302A044 | M 33KOHM, 1/10W         | 1   |         |
|        | R16789   | D0GD103JA036 | M 10KOHM,J,0.25W        | 1   |         |
|        | R16791   | ERJ6GEYJ102V | M 1K OHM J 1/10W        | 1   |         |
|        | R16794   | D1BD2003A044 | M 200KOHM, 1/10W        | 1   |         |
|        | R16795   | D1BD2003A044 | M 200KOHM, 1/10W        | 1   |         |
|        | R16796   | D1BD5602A044 | M 56KOHM, 1/10W         | 1   |         |
|        | R16806   | ERJ6GEYJ102V | M 1K OHM J 1/10W        | 1   |         |
|        | R16811   | ERJ6RBD152   | M 1.5KOHM,J,1/10W       | 1   |         |
|        | R16822   | ERJ6ENF8202  | M 82KOHM, 1/10W         | 1   |         |
|        | R16823   | ERJ6ENF8202  | M 82KOHM, 1/10W         | 1   |         |
|        | R16824   | D1BD3302A044 | M 33KOHM, 1/10W         | 1   |         |
|        | R16825   | ERJT06J154V  | M 150KOHM,F,0.25W       | 1   |         |
|        | R16826   | D0GD103JA036 | M 10KOHM,J,0.25W        | 1   |         |
|        | R16829   | ERJ6GEYJ102V | M 1K OHM J 1/10W        | 1   |         |
|        | R16831   | D1BD7152A044 | M71.5KOHM, 1/10W        | 1   |         |
|        | R16832   | D1BD7152A044 | M71.5KOHM, 1/10W        | 1   |         |
|        | R16833   | D0GD103JA036 | M 10KOHM,J,0.25W        | 1   |         |
|        | R16838   | ERJ14YJ563U  | M 56KOHM, 1/2W          | 1   |         |
|        | R16841   | ERJ14YJ563U  | M 56KOHM, 1/2W          | 1   |         |
|        | R16844   | D1BD1241A044 | M1.24KOHM, 1/10W        | 1   |         |



| Safety | Ref. No. | Part No.     | Part Name & Description | Pcs | Remarks |
|--------|----------|--------------|-------------------------|-----|---------|
|        | R16845   | D1BD7152A044 | M71.5KOHM, 1/10W        | 1   |         |
|        | R16846   | ERJ6ENF8202  | M 82KOHM, 1/10W         | 1   |         |
|        | R16847   | ERJ6GEYJ472V | M 4.7K OHM J 1/10W      | 1   |         |
|        | R16848   | ERJ6GEYJ472V | M 4.7K OHM J 1/10W      | 1   |         |
|        | R16851   | ERJ6GEYJ474  | M 470KOHM,J,1/10W       | 1   |         |
|        | R16860   | D0D28R2JA021 | M 8.2 OHM,J,2W          | 1   |         |
|        | R16869   | ERJ8GEYJ473  | M 47KOHM, J,1/8W        | 1   |         |
|        | R16870   | ERJ14YJ683   | M 68KOHM, 1/2W          | 1   |         |
|        | R16873   | D1BD2491A044 | M2.49KOHM, 1/10W        | 1   |         |
|        | R16877   | ERJ6GEYG681  | M 680 OHM,J,1/10W       | 1   |         |
|        | R16886   | ERJ6GEYJ224  | M 220KOHM,J,1/10W       | 1   |         |
|        | R16887   | ERJ6GEYJ224  | M 220KOHM,J,1/10W       | 1   |         |
|        | R16888   | ERJ6GEYJ224  | M 220KOHM,J,1/10W       | 1   |         |
|        | R16891   | D1BD4702A044 | M 47KOHM, 1/10W         | 1   |         |
|        | R16892   | D1BD4702A044 | M 47KOHM, 1/10W         | 1   |         |
|        | R16893   | D1BD4702A044 | M 47KOHM, 1/10W         | 1   |         |
|        | R16894   | D1BD4702A044 | M 47KOHM, 1/10W         | 1   |         |
|        | R16895   | D1BD4702A044 | M 47KOHM, 1/10W         | 1   |         |
|        | R16896   | D1BD3302A044 | M 33KOHM, 1/10W         | 1   |         |
|        | R16897   | D1BD2741A044 | M2.74KOHM, 1/10W        | 1   |         |
|        | R16899   | D1BD1471A044 | M1.47KOHM, 1/10W        | 1   |         |
|        | R16904   | ERJ6GEYJ223  | M 22KOHM,J,1/10W        | 1   |         |
|        | R16920   | D0GD103JA036 | M 10KOHM,J,0.25W        | 1   |         |
|        | R16921   | D1BD1741A044 | M1.74KOHM, 1/10W        | 1   |         |
|        | R16922   | D1BD3001A044 | M 3KOHM, 1/10W          | 1   |         |
|        | R16923   | D0GD103JA036 | M 10KOHM,J,0.25W        | 1   |         |
|        | R16926   | ERJ6GEYJ222V | M 2.2K OHM J 1/10W      | 1   |         |
|        | R16927   | ERJ6GEYJ223  | M 22KOHM,J,1/10W        | 1   |         |
|        | R17115   | ERJ3GEY0R00  | M 0 OHM, 1/16W          | 1   |         |
|        | R17116   | D0GZ6R8JA020 | M 6.8 OHM,J,0.5W        | 1   |         |
|        | R17117   | D0GZ6R8JA020 | M 6.8 OHM,J,0.5W        | 1   |         |
|        | R17125   | ERJ3GEY0R00  | M 0 OHM, 1/16W          | 1   |         |
|        | R17126   | D0GZ6R8JA020 | M 6.8 OHM,J,0.5W        | 1   |         |
|        | R17127   | D0GZ6R8JA020 | M 6.8 OHM,J,0.5W        | 1   |         |
|        | R17135   | ERJ3GEY0R00  | M 0 OHM, 1/16W          | 1   |         |
|        | R17136   | D0GZ6R8JA020 | M 6.8 OHM,J,0.5W        | 1   |         |
|        | R17137   | D0GZ6R8JA020 | M 6.8 OHM,J,0.5W        | 1   |         |
|        | R17161   | D0GDR00Z0002 | M 0 OHM, 1/10W          | 1   |         |
|        | R17165   | EXB38V470J   | RESISTOR ARRAY          | 1   |         |
|        | R17166   | D0GB102JA041 | M 1KOHM,J,1/16W         | 1   |         |
|        | R17167   | D0GB102JA041 | M 1KOHM,J,1/16W         | 1   |         |
|        | R17191   | D0GF472JA047 | M 4.7KOHM,J,0.33W       | 1   |         |
|        | R17194   | ERJ3GEY0R00  | M 0 OHM, 1/16W          | 1   |         |
|        | R17195   | ERJ3GEY0R00  | M 0 OHM, 1/16W          | 1   |         |
|        | R17198   | ERJ6GEYJ102V | M 1K OHM J 1/10W        | 1   |         |
|        | R17215   | ERJ3GEY0R00  | M 0 OHM, 1/16W          | 1   |         |
|        | R17216   | D0GZ6R8JA020 | M 6.8 OHM,J,0.5W        | 1   |         |
|        | R17217   | D0GZ6R8JA020 | M 6.8 OHM,J,0.5W        | 1   |         |
|        | R17225   | ERJ3GEY0R00  | M 0 OHM, 1/16W          | 1   |         |
|        | R17226   | D0GZ6R8JA020 | M 6.8 OHM,J,0.5W        | 1   |         |
|        | R17227   | D0GZ6R8JA020 | M 6.8 OHM,J,0.5W        | 1   |         |
|        | R17235   | ERJ3GEY0R00  | M 0 OHM, 1/16W          | 1   |         |
|        | R17236   | D0GZ6R8JA020 | M 6.8 OHM,J,0.5W        | 1   |         |
|        | R17237   | D0GZ6R8JA020 | M 6.8 OHM,J,0.5W        | 1   |         |
|        | R17245   | ERJ3GEY0R00  | M 0 OHM, 1/16W          | 1   |         |

| Safety | Ref. No. | Part No.     | Part Name & Description | Pcs | Remarks |
|--------|----------|--------------|-------------------------|-----|---------|
|        | R17246   | D0GZ6R8JA020 | M 6.8 OHM,J,0.5W        | 1   |         |
|        | R17247   | D0GZ6R8JA020 | M 6.8 OHM,J,0.5W        | 1   |         |
|        | R17251   | EXB38V470J   | RESISTOR ARRAY          | 1   |         |
|        | R17252   | EXB38V470J   | RESISTOR ARRAY          | 1   |         |
|        | R17253   | D0GB102JA041 | M 1KOHM,J,1/16W         | 1   |         |
|        | R17254   | D0GB102JA041 | M 1KOHM,J,1/16W         | 1   |         |
|        | R17255   | EXB38V470J   | RESISTOR ARRAY          | 1   |         |
|        | R17256   | ERJ3GEYJ470  | M 47 OHM,J,1/16W        | 1   |         |
|        | R17257   | D0GB102JA041 | M 1KOHM,J,1/16W         | 1   |         |
|        | R17258   | EXB38V102J   | RESISTOR ARRAY          | 1   |         |
|        | R17259   | ERJ3GEYJ220  | M 22 OHM,J,1/16W        | 1   |         |
|        | R17260   | ERJ3GEYJ220  | M 22 OHM,J,1/16W        | 1   |         |
|        | R17261   | EXB38V220JV  | RESISTOR ARRAY          | 1   |         |
|        | R17262   | ERJ3GEYJ471  | M 470 OHM,J,1/16W       | 1   |         |
|        | R17263   | ERJ3GEYJ471  | M 470 OHM,J,1/16W       | 1   |         |
|        | R17264   | EXB38V471J   | RESISTOR ARRAY          | 1   |         |
|        | R17265   | EXB38V220JV  | RESISTOR ARRAY          | 1   |         |
|        | R17266   | EXB38V220JV  | RESISTOR ARRAY          | 1   |         |
|        | R17267   | EXB38V471J   | RESISTOR ARRAY          | 1   |         |
|        | R17268   | EXB38V471J   | RESISTOR ARRAY          | 1   |         |
|        | R17269   | EXB38V220JV  | RESISTOR ARRAY          | 1   |         |
|        | R17270   | EXB38V220JV  | RESISTOR ARRAY          | 1   |         |
|        | R17271   | EXB38V471J   | RESISTOR ARRAY          | 1   |         |
|        | R17272   | EXB38V471J   | RESISTOR ARRAY          | 1   |         |
|        | R17273   | EXB38V330J   | RESISTOR ARRAY          | 1   |         |
|        | R17274   | EXB38V470J   | RESISTOR ARRAY          | 1   |         |
|        | R17275   | EXB38V471J   | RESISTOR ARRAY          | 1   |         |
|        | R17276   | EXB38V471J   | RESISTOR ARRAY          | 1   |         |
|        | R17277   | ERJ3GEYJ470  | M 47 OHM,J,1/16W        | 1   |         |
|        | R17278   | ERJ3GEYJ470  | M 47 OHM,J,1/16W        | 1   |         |
|        | R17279   | EXB38V470J   | RESISTOR ARRAY          | 1   |         |
|        | R17280   | ERJ3GEYJ471  | M 470 OHM,J,1/16W       | 1   |         |
|        | R17281   | ERJ3GEYJ471  | M 470 OHM,J,1/16W       | 1   |         |
|        | R17282   | EXB38V471J   | RESISTOR ARRAY          | 1   |         |
|        | R17283   | ERJ3GEYJ470  | M 47 OHM,J,1/16W        | 1   |         |
|        | R17284   | ERJ3GEYJ470  | M 47 OHM,J,1/16W        | 1   |         |
|        | R17285   | EXB38V470J   | RESISTOR ARRAY          | 1   |         |
|        | R17286   | ERJ3GEYJ471  | M 470 OHM,J,1/16W       | 1   |         |
|        | R17287   | ERJ3GEYJ471  | M 470 OHM,J,1/16W       | 1   |         |
|        | R17288   | EXB38V471J   | RESISTOR ARRAY          | 1   |         |
|        | R17290   | D0GDR00Z0002 | M 0 OHM, 1/10W          | 1   |         |
|        | R17291   | D0GDR00Z0002 | M 0 OHM, 1/10W          | 1   |         |
|        | R17315   | ERJ3GEY0R00  | M 0 OHM, 1/16W          | 1   |         |
|        | R17316   | D0GZ6R8JA020 | M 6.8 OHM,J,0.5W        | 1   |         |
|        | R17317   | D0GZ6R8JA020 | M 6.8 OHM,J,0.5W        | 1   |         |
|        | R17325   | ERJ3GEY0R00  | M 0 OHM, 1/16W          | 1   |         |
|        | R17326   | D0GZ6R8JA020 | M 6.8 OHM,J,0.5W        | 1   |         |
|        | R17327   | D0GZ6R8JA020 | M 6.8 OHM,J,0.5W        | 1   |         |
|        | R17335   | ERJ3GEY0R00  | M 0 OHM, 1/16W          | 1   |         |
|        | R17336   | D0GZ6R8JA020 | M 6.8 OHM,J,0.5W        | 1   |         |
|        | R17337   | D0GZ6R8JA020 | M 6.8 OHM,J,0.5W        | 1   |         |
|        | R17345   | ERJ3GEY0R00  | M 0 OHM, 1/16W          | 1   |         |
|        | R17346   | D0GZ6R8JA020 | M 6.8 OHM,J,0.5W        | 1   |         |
|        | R17347   | D0GZ6R8JA020 | M 6.8 OHM,J,0.5W        | 1   |         |
|        | R17348   | ERJ6GEYJ224  | M 220KOHM,J,1/10W       | 1   |         |
|        | R17349   | D0GF472JA047 | M 4.7KOHM,J,0.33W       | 1   |         |
|        | R17350   | D0GDR00Z0002 | M 0 OHM, 1/10W          | 1   |         |
|        | R17351   | D0GB102JA041 | M 1KOHM,J,1/16W         | 1   |         |

| Safety | Ref. No. | Part No.     | Part Name & Description | Pcs | Remarks         |
|--------|----------|--------------|-------------------------|-----|-----------------|
|        | R17352   | D0GB102JA041 | M 1KOHM,J,1/16W         | 1   |                 |
|        | R17353   | ERJ3GEYJ470  | M 47 OHM,J,1/16W        | 1   |                 |
|        | R17354   | ERJ3GEYJ470  | M 47 OHM,J,1/16W        | 1   |                 |
|        | R17355   | EXB38V470J   | RESISTOR ARRAY          | 1   |                 |
|        | R17356   | ERJ3GEYJ470  | M 47 OHM,J,1/16W        | 1   |                 |
|        | R17357   | ERJ3GEYJ470  | M 47 OHM,J,1/16W        | 1   |                 |
|        | R17358   | ERJ3GEYJ471  | M 470 OHM,J,1/16W       | 1   |                 |
|        | R17359   | ERJ3GEYJ471  | M 470 OHM,J,1/16W       | 1   |                 |
|        | R17360   | ERJ3GEYJ470  | M 47 OHM,J,1/16W        | 1   |                 |
|        | R17361   | ERJ3GEYJ470  | M 47 OHM,J,1/16W        | 1   |                 |
|        | R17368   | ERJ3GEYJ222  | M 2.2KOHM,J,1/16W       | 1   |                 |
|        | R17371   | EXB38V471J   | RESISTOR ARRAY          | 1   |                 |
|        | R17372   | ERJ3GEYJ471  | M 470 OHM,J,1/16W       | 1   |                 |
|        | R17373   | ERJ3GEYJ471  | M 470 OHM,J,1/16W       | 1   |                 |
|        | R17374   | EXB38V470J   | RESISTOR ARRAY          | 1   |                 |
|        | R17375   | ERJ3GEYJ222  | M 2.2KOHM,J,1/16W       | 1   |                 |
|        | R17376   | EXB38V222J   | RESISTOR ARRAY          | 1   |                 |
|        | R17377   | EXB38V470J   | RESISTOR ARRAY          | 1   |                 |
|        | R17378   | EXB38V470J   | RESISTOR ARRAY          | 1   |                 |
|        | R17379   | EXB38V471J   | RESISTOR ARRAY          | 1   |                 |
|        | R17381   | EXB38V470J   | RESISTOR ARRAY          | 1   |                 |
|        | R17383   | D0GB102JA041 | M 1KOHM,J,1/16W         | 1   |                 |
|        | R17384   | D0GB102JA041 | M 1KOHM,J,1/16W         | 1   |                 |
|        | R17385   | EXB38V470J   | RESISTOR ARRAY          | 1   |                 |
|        | R17386   | EXB38V470J   | RESISTOR ARRAY          | 1   |                 |
|        | R17387   | EXB38V471J   | RESISTOR ARRAY          | 1   |                 |
|        | R17388   | EXB38V471J   | RESISTOR ARRAY          | 1   |                 |
|        | R17389   | EXB38V470J   | RESISTOR ARRAY          | 1   |                 |
|        | R17390   | EXB38V470J   | RESISTOR ARRAY          | 1   |                 |
|        | R17391   | EXB38V471J   | RESISTOR ARRAY          | 1   |                 |
|        | R17392   | ERJ3GEYJ471  | M 470 OHM,J,1/16W       | 1   |                 |
|        | R17393   | ERJ3GEYJ471  | M 470 OHM,J,1/16W       | 1   |                 |
|        | R17394   | ERJ3GEYJ222  | M 2.2KOHM,J,1/16W       | 1   |                 |
|        | R17395   | ERJ3GEYJ222  | M 2.2KOHM,J,1/16W       | 1   |                 |
|        | R17396   | EXB38V470J   | RESISTOR ARRAY          | 1   |                 |
|        | R17397   | EXB38V470J   | RESISTOR ARRAY          | 1   |                 |
|        | RM2501   | B3RAD0000160 | REMOTE SENSOR           | 1   |                 |
| △      | PCB      | TXNGK1EQE    | CIRCUIT BOARD GK        | 1   | (RTL) PA VCCZ   |
| △      | PCB      | A-PF50X10    | CIRCUIT BOARD A         | 1   | (RTL) PA VCCZ F |
| △      | PCB      | A-P50X10Y    | CIRCUIT BOARD A         | 1   | (RTL) PA VCCZ Y |
| △      | PCB      | LSEP1279EEHB | CIRCUIT BOARD P         | 1   | (RTL) PA VCCZ   |
| △      | PCB      | TXNC11EPUE   | CIRCUIT BOARD C1        | 1   | (RTL) PA VCCZ   |
| △      | PCB      | TXNC21EPUE   | CIRCUIT BOARD C2        | 1   | (RTL) PA VCCZ   |
| △      | PCB      | TXNC31EPUE   | CIRCUIT BOARD C3        | 1   | (RTL) PA VCCZ   |
| △      | PCB      | TXNSC1EPUE   | CIRCUIT BOARD SC        | 1   | (RTL) PA VCCZ   |
| △      | PCB      | TXNSD1EPUE   | CIRCUIT BOARD SD        | 1   | PAVCCZ          |
| △      | PCB      | TXNSS1EPUE   | CIRCUIT BOARD SS        | 1   | (RTL) PA VCCZ   |
| △      | PCB      | TXNSS21EPUE  | CIRCUIT BOARD SS2       | 1   | (RTL) PA VCCZ   |
| △      | PCB      | TXNSU1EPUE   | CIRCUIT BOARD SU        | 1   | PAVCCZ          |
| △      | PCB      | TXN/S1EQE    | CIRCUIT BOARD S         | 1   | (RTL) PA VCCZ   |
| △      | PCB      | TXN/K1EQE    | CIRCUIT BOARD K         | 1   | (RTL) PA VCCZ   |
|        | S1B      | K1KA03BA0237 | 3P CONNECTOR            | 1   | PAVCCZ          |

| Safety | Ref. No. | Part No.     | Part Name & Description | Pcs                  | Remarks  |
|--------|----------|--------------|-------------------------|----------------------|----------|
|        |          |              |                         |                      |          |
|        |          | SC2          | K1KA02A00676            | 2P CONNECTOR         | 1        |
|        |          | SC3          | K1KA03A00596            | 3P CONNECTOR         | 1        |
|        |          | SC20         | K1MN30BA0255            | 30P CONNECTOR        | 1        |
|        |          | SC41         | K1KA09A00239            | 9P CONNECTOR         | 1        |
|        |          | SC42         | K1KA09A00239            | 9P CONNECTOR         | 1        |
|        |          | SC46         | K1KA09A00239            | 9P CONNECTOR         | 1        |
|        |          | SC50         | K1KA02AA0193            | 2P CONNECTOR         | 1        |
|        |          |              |                         |                      |          |
|        |          | SS3          | K1KY03BA0236            | 3P CONNECTOR         | 1 PAVCCZ |
|        |          | SS11         | K1KA03A00608            | 3P CONNECTOR         | 1        |
|        |          | SS22         | K1KY15AA0606            | 15P CONNECTOR        | 1        |
|        |          | SS23         | K1KA06B00220            | 6P CONNECTOR         | 1 PAVCCZ |
|        |          | SS24         | K1KB15AA0032            | 15P CONNECTOR        | 1        |
|        |          | SS52         | K1MN13B00091            | 13P CONNECTOR        | 1        |
|        |          | SS55         | K1MN13B00091            | 13P CONNECTOR        | 1        |
|        |          | SS58         | K1MN13B00091            | 13P CONNECTOR        | 1        |
|        |          |              |                         |                      |          |
| △      | SW2500   | K0F162B00002 | SWITCH                  | 1                    |          |
|        |          | SW3759       | EVQ11G05R               | SWITCH               | 1        |
|        |          | SW3760       | EVQ11G05R               | SWITCH               | 1        |
|        |          | SW3761       | EVQ11G05R               | SWITCH               | 1        |
|        |          | SW3762       | EVQ11G05R               | SWITCH               | 1        |
|        |          | SW3763       | EVQ11G05R               | SWITCH               | 1        |
|        |          |              |                         |                      |          |
| △      | TU2901   | ENG37E18KF   | TUNER                   | 1                    | PAVCCZ   |
|        |          |              |                         |                      |          |
|        |          | VR16600      | EVMEASA00B54            | CONTROL 50KOHMB 0.3W | 1        |
|        |          | VR16601      | EVMEASA00B53            | CONTROL 50KOHMB 0.3W | 1        |
|        |          |              |                         |                      |          |
|        |          | X1100        | H0J100500035            | CRYSTAL              | 1        |
|        |          | X2010        | H0J245500089            | CRYSTAL              | 1        |
|        |          | X8001        | H0J270500120            | CRYSTAL              | 1        |
|        |          | X8301        | H0J300500027            | CRYSTAL              | 1 PAVCCZ |
|        |          | X9900        | H0J200500076            | CRYSTAL              | 1        |
|        |          |              |                         |                      |          |
|        |          | ZA001        | K4AZ01D00004            | TERMINAL             | 1        |
|        |          | ZA002        | K4CD01000011            | AV TERMINAL          | 1        |
|        |          | ZA16401      | K4CD01000011            | AV TERMINAL          | 1        |
|        |          | ZA16402      | K4CD01000011            | AV TERMINAL          | 1        |
|        |          | ZA16403      | K4CD01000011            | AV TERMINAL          | 1        |
|        |          | ZA17101      | K4CD01000013            | AV TERMINAL          | 1        |
|        |          | ZA17102      | K4CD01000013            | AV TERMINAL          | 1        |
|        |          | ZA17103      | K4CD01000013            | AV TERMINAL          | 1        |
|        |          | ZA17201      | K4CD01000013            | AV TERMINAL          | 1        |
|        |          | ZA17202      | K4CD01000013            | AV TERMINAL          | 1        |
|        |          | ZA17203      | K4CD01000013            | AV TERMINAL          | 1        |
|        |          | ZA17204      | K4CD01000013            | AV TERMINAL          | 1        |
|        |          | ZA17301      | K4CD01000013            | AV TERMINAL          | 1        |
|        |          | ZA17302      | K4CD01000013            | AV TERMINAL          | 1        |
|        |          | ZA17303      | K4CD01000013            | AV TERMINAL          | 1        |
|        |          | ZA17304      | K4CD01000013            | AV TERMINAL          | 1        |
|        |          |              |                         |                      |          |
| △      | C101     | F0CAF334A021 | C 0.33UF, 250V          | 1                    |          |
| △      | C102     | F1BAF221A107 | C 220UF, 250V           | 1                    |          |
| △      | C103     | F1BAF221A107 | C 220UF, 250V           | 1                    |          |
| △      | C104     | F0CAF334A021 | C 0.33UF, 250V          | 1                    |          |
|        |          | C105         | F1J1H334A679            | C 0.33UF, 50V        | 1        |
| △      | C106     | F1BAF221A107 | C 220UF, 250V           | 1                    |          |
| △      | C107     | F1BAF221A107 | C 220UF, 250V           | 1                    |          |
| △      | C109     | ECQE2W225L0  | C 22UF, 450V            | 1                    |          |
| △      | C110     | ECQE2W225L0  | C 22UF, 450V            | 1                    |          |
|        |          | C111         | ECJ1VB1H103K            | C 0.001UF, K, 50V    | 1        |
|        |          | C112         | ECJ1VB1H102K            | C 1000PF, K, 50V     | 1        |
|        |          | C113         | F1J1E225A209            | C 2.2 UF 25V         | 1        |
|        |          | C114         | F1H1C224A065            | C 0.22UF, K, 50V     | 1        |
|        |          | C115         | ECJ1VB1H103K            | C 0.001UF, K, 50V    | 1        |
|        |          | C116         | ECJ1VB1H472K            | C 4700PF, K, 50V     | 1        |
|        |          | C117         | ECJ1VB1E104K            | C 0.10UF, K, 25V     | 1        |

| Safety | Ref. No. | Part No.     | Part Name & Description | Pcs | Remarks |
|--------|----------|--------------|-------------------------|-----|---------|
|        | C118     | F1H1H221A832 | C 220UF, K, 50V         | 1   |         |
|        | C119     | ECJ2XB1H104K | C 0.1UF, K, 50V         | 1   |         |
|        | C120     | F1E2J4730001 | C 0.047PF, , 600V       | 1   |         |
|        | C121     | F1H1C105A071 | C 1UF, K, 16V           | 1   |         |
|        | C122     | ECKD3A102KBP | C 1000PF, K, 1KV        | 1   |         |
|        | C123     | ECKD3A102KBP | C 1000PF, K, 1KV        | 1   |         |
|        | C124     | F1H1C105A071 | C 1UF, K, 16V           | 1   |         |
| △      | C125     | F2B2W3910010 | C 390UF, 450V           | 1   |         |
|        | C126     | ECJ1VB1H102K | C 1000PF, K, 50V        | 1   |         |
|        | C127     | F1H1C105A071 | C 1UF, K, 16V           | 1   |         |
|        | C130     | F1H1H221A832 | C 220UF, K, 50V         | 1   |         |
|        | C132     | ECJ1VB1E104K | C 0.10UF, K, 25V        | 1   |         |
|        | C200     | ECJ1VB1H102K | C 1000PF, K, 50V        | 1   |         |
| △      | C201     | F2A2W220A165 | E 22UF 160V             | 1   |         |
|        | C202     | F1E2J4730001 | C 0.047PF, , 600V       | 1   |         |
|        | C204     | F1H1C105A148 | C 1UF, K, 16V           | 1   |         |
|        | C205     | F2A1H4700057 | E 47UF, 50V             | 1   |         |
|        | C206     | ECJ1VB1E104K | C 0.10UF, K, 25V        | 1   |         |
|        | C207     | F2A1H1000083 | E 10UF, 50V             | 1   |         |
|        | C208     | FLJ1E105A231 | C 1 UF 25V              | 1   |         |
|        | C209     | ECJ1VB1E104K | C 0.10UF, K, 25V        | 1   |         |
|        | C210     | F2A1H4700057 | E 47UF, 50V             | 1   |         |
|        | C213     | FLJ1E105A231 | C 1 UF 25V              | 1   |         |
|        | C300     | ECJ1VB1H103K | C 0.001UF, K, 50V       | 1   |         |
|        | C301     | ECJ2XB1H104K | C 0.1UF, K, 50V         | 1   |         |
|        | C303     | ECJ2FB1E474K | C 47UF, K, 25V          | 1   |         |
|        | C304     | ECCD3D470JGE | C 47PF, K, 2KV          | 1   |         |
|        | C305     | ECJ2XB1H104K | C 0.1UF, K, 50V         | 1   |         |
|        | C306     | ECJ2FB1E474K | C 47UF, K, 25V          | 1   |         |
|        | C307     | ECJ2VB1H103K | C 0.01UF, K, 50V        | 1   |         |
|        | C308     | ECJ2FB1E224K | C 22UF, K, 25V          | 1   |         |
|        | C309     | ECKD3D122KBP | C 1200PF, K, 2KV        | 1   |         |
|        | C310     | ECJ2VB1H222K | C 2200P 50V             | 1   |         |
|        | C311     | ECJ2VC1H470J | C 47PF. K. 50V          | 1   |         |
|        | C312     | ECJ1VB1E104K | C 0.10UF, K, 25V        | 1   |         |
| △      | C313     | ECWH8104RHV  | P 0.10PF, J, 8KV        | 1   |         |
| △      | C314     | ECWH8104RHV  | P 0.10PF, J, 8KV        | 1   |         |
| △      | C315     | ECWH8333RHV  | P 0.033PF, J, 8KV       | 1   |         |
|        | C316     | F1A3D1000002 | C 10PF. 2KV             | 1   |         |
|        | C317     | F1A3D221A010 | C 220PF. 2KV            | 1   |         |
| △      | C319     | F1BAF3310003 | C 330UF, 250V           | 1   |         |
|        | C321     | ECJ1VB1H103K | C 0.001UF, K, 50V       | 1   |         |
|        | C322     | ECJ2VB1H103K | C 0.01UF, K, 50V        | 1   |         |
| △      | C323     | ECQE2W225L0  | C 22UF, 450V            | 1   |         |
|        | C500     | ECJ2FB1C334K | C 33UF, K, 25V          | 1   |         |
|        | C502     | ECJ1XC1H681J | C 680PF, J, 50V         | 1   |         |
|        | C503     | ECJ1XC1H681J | C 680PF, J, 50V         | 1   |         |
|        | C504     | ECJ1XC1H102J | C 1000PF, J, 50V        | 1   |         |
|        | C505     | F2A1A1820009 | C 1800UF. 10V           | 1   |         |
|        | C506     | ECJ1XC1H681J | C 680PF, J, 50V         | 1   |         |
|        | C507     | F2A1V1820026 | E 1800UF 35V            | 1   |         |
|        | C510     | ECJ1XC1H102J | C 1000PF, J, 50V        | 1   |         |
|        | C511     | FLJ1E105A231 | C 1 UF 25V              | 1   |         |
|        | C513     | F2A1E1010106 | E 100UF, 25V            | 1   |         |
|        | C515     | ECJ2XB1H104K | C 0.1UF, K, 50V         | 1   |         |
|        | C518     | ECJ1VB1H103K | C 0.001UF, K, 50V       | 1   |         |
|        | C519     | ECJ1VB1H102K | C 1000PF, K, 50V        | 1   |         |
|        | C520     | ECJ1VB1H102K | C 1000PF, K, 50V        | 1   |         |
|        | C521     | ECJ1VB1H102K | C 1000PF, K, 50V        | 1   |         |
|        | C522     | FLJ1E105A231 | C 1 UF 25V              | 1   |         |
|        | C600     | ECJ1VB1H103K | C 0.001UF, K, 50V       | 1   |         |
|        | C601     | ECJ1VB1H103K | C 0.001UF, K, 50V       | 1   |         |
|        | C603     | ECJ1VB1H103K | C 0.001UF, K, 50V       | 1   |         |
|        | C606     | ECJ2VB1H223K | C 0.022UF, K, 50V       | 1   |         |

| Safety | Ref. No. | Part No.     | Part Name & Description | Pcs | Remarks |
|--------|----------|--------------|-------------------------|-----|---------|
|        | C607     | ECJ1VB1H103K | C 0.001UF, K, 50V       | 1   |         |
|        | C608     | ECJ2VB1H223K | C 0.022UF, K, 50V       | 1   |         |
|        | C610     | ECJ2VB1H103K | C 0.01UF, K, 50V        | 1   |         |
|        | C611     | ECJ2VB1H103K | C 0.01UF, K, 50V        | 1   |         |
|        | C613     | ECJ2VB1H103K | C 0.01UF, K, 50V        | 1   |         |
|        | C623     | FLJ0J4750018 | C 4.7UF, K, 16V         | 1   |         |
|        | C625     | ECJ2VB1H102K | C 1000PF, J, 50V        | 1   |         |
|        | C627     | ECJ2VB1H103K | C 0.01UF, K, 50V        | 1   |         |
|        | C628     | ECJ2VB1H103K | C 0.01UF, K, 50V        | 1   |         |
|        | C630     | ECJ1VB1H102K | C 1000PF, K, 50V        | 1   |         |
|        | C700     | F2A1H1000083 | E 10UF, 50V             | 1   |         |
|        | C701     | ECJ1VB1E104K | C 0.10UF, K, 25V        | 1   |         |
|        | C702     | ECJ2VB1E104K | C 0.1UF, K, 25V         | 1   |         |
|        | C704     | F1B3D1020012 | C 1000PF. 2KV           | 1   |         |
|        | C706     | ECJ2XB1H104K | C 0.1UF, K, 50V         | 1   |         |
| △      | C709     | F2AZZ821A019 | E 820UF, 80V            | 1   |         |
| △      | C711     | F2B2T6810001 | E 680UF, 220V           | 1   |         |
|        | C713     | ECJ2VB1C224K | C 0.22UF, K, 16V        | 1   |         |
|        | C714     | ECJ2VC1H471J | C 470PF, K, 50V         | 1   |         |
|        | C715     | ECJ2VC1H471J | C 470PF, K, 50V         | 1   |         |
|        | C716     | ECJ2VB1C224K | C 0.22UF, K, 16V        | 1   |         |
|        | C717     | F2A1E3320041 | E 3300PF, 25V           | 1   |         |
|        | C718     | ECJ2XB1H104K | C 0.1UF, K, 50V         | 1   |         |
|        | C720     | FOC2E224A256 | E 0.22UF, 250V          | 1   |         |
|        | C721     | FOC2E223A256 | E 0.022UF, 250V         | 1   |         |
|        | C722     | FOC2E473A256 | E 0.047UF, 250V         | 1   |         |
|        | C723     | FLJ1E105A231 | C 1 UF 25V              | 1   |         |
|        | C724     | FLJ1E105A231 | C 1 UF 25V              | 1   |         |
|        | C726     | F2A1E4710105 | E 470UF, 25V            | 1   |         |
|        | C727     | ECJ1VB1E104K | C 0.10UF, K, 25V        | 1   |         |
|        | C728     | ECJ1VB1H102K | C 1000PF, K, 50V        | 1   |         |
|        | C729     | ECJ1VB1E104K | C 0.10UF, K, 25V        | 1   |         |
|        | C731     | ECJ1VB1E104K | C 0.10UF, K, 25V        | 1   |         |
|        | C732     | FOC2E104A256 | E 0.10UF, 250V          | 1   |         |
|        | C735     | ECJ1VB1H102K | C 1000PF, K, 50V        | 1   |         |
|        |          |              |                         |     |         |
| △      | D100     | BOFBTT000008 | DIODE                   | 1   |         |
|        | D101     | BOACDJ000010 | DIODE                   | 1   |         |
|        | D102     | BOJCD0000002 | DIODE                   | 1   |         |
|        | D103     | BOBC01400033 | ZENER DIODE             | 1   |         |
|        | D104     | BOJAME000099 | DIODE                   | 1   |         |
|        | D105     | BOACDJ000010 | DIODE                   | 1   |         |
|        | D106     | BOEAKT000048 | DIODE                   | 1   |         |
|        | D108     | BOHAPR000016 | DIODE                   | 1   |         |
|        | D109     | BOHAPR000016 | DIODE                   | 1   |         |
|        | D110     | BOBC8R100015 | ZENER DIODE             | 1   |         |
|        | D111     | BOACDJ000010 | DIODE                   | 1   |         |
|        | D114     | BOACDJ000010 | DIODE                   | 1   |         |
| △      | D200     | BOEBKT000007 | DIODE                   | 1   |         |
|        | D202     | BOEAKT000048 | DIODE                   | 1   |         |
|        | D203     | BOEAKT000048 | DIODE                   | 1   |         |
|        | D204     | BOHAMP000067 | DIODE                   | 1   |         |
|        | D205     | MTZJ10B      | ZENER DIODE             | 1   |         |
|        | D206     | BOACDJ000010 | DIODE                   | 1   |         |
|        | D207     | BOBB17000003 | ZENER DIODE             | 1   |         |
|        | D208     | BOHAMM000122 | DIODE                   | 1   |         |
|        | D209     | BOHALP000007 | DIODE                   | 1   |         |
|        | D210     | BOEAD000001  | DIODE                   | 1   |         |
|        | D211     | BOBC02000014 | ZENER DIODE             | 1   |         |
|        | D212     | BOEAKT000048 | DIODE                   | 1   |         |
|        | D213     | BOJCM000029  | DIODE                   | 1   |         |
|        | D300     | BOBC8R100015 | ZENER DIODE             | 1   |         |
|        | D301     | BOHAGR000010 | DIODE                   | 1   |         |
|        | D302     | BOEAD000001  | DIODE                   | 1   |         |
|        | D303     | BOEAD000001  | DIODE                   | 1   |         |
|        | D304     | BOHAGR000010 | DIODE                   | 1   |         |
|        | D305     | BOHAJP000004 | DIODE                   | 1   |         |
|        | D306     | BOJCM000029  | DIODE                   | 1   |         |
|        | D307     | BOJCM000029  | DIODE                   | 1   |         |
|        | D308     | BOACDJ000010 | DIODE                   | 1   |         |
|        | D309     | BOJCM000029  | DIODE                   | 1   |         |



| Safety | Ref. No. | Part No.     | Part Name & Description | Pcs | Remarks |
|--------|----------|--------------|-------------------------|-----|---------|
|        | D310     | BOEAKT000048 | DIODE                   | 1   |         |
|        | D311     | B0JCMC000029 | DIODE                   | 1   |         |
|        | D500     | B0BC01300033 | ZENER DIODE             | 1   |         |
|        | D501     | B0JANG000018 | DIODE                   | 1   |         |
|        | D502     | B0HBSM000043 | DIODE                   | 1   |         |
|        | D506     | B0JANG000018 | DIODE                   | 1   |         |
|        | D510     | B0JANG000018 | DIODE                   | 1   |         |
|        | D511     | B0ACD000010  | DIODE                   | 1   |         |
|        | D600     | B0ACD000010  | DIODE                   | 1   |         |
|        | D603     | B0BC5R100039 | ZENER DIODE             | 1   |         |
|        | D604     | B0EAD000001  | DIODE                   | 1   |         |
|        | D605     | B0EAD000001  | DIODE                   | 1   |         |
|        | D700     | B0HBSN000013 | DIODE                   | 1   |         |
|        | D703     | B0EAKT000031 | DIODE                   | 1   |         |
|        | D704     | B0EAKT000031 | DIODE                   | 1   |         |
|        | D705     | B0JBSL000013 | DIODE                   | 1   |         |
|        | D706     | B0FAAT000002 | DIODE                   | 1   |         |
|        | D708     | B0BC01300033 | ZENER DIODE             | 1   |         |
|        | D710     | B0JCPE000038 | DIODE                   | 1   |         |
|        | D711     | DAN202U      | DIODE                   | 1   |         |
|        | D712     | B0BC8R100015 | ZENER DIODE             | 1   |         |
|        | D713     | B0ACD000010  | DIODE                   | 1   |         |
|        | D715     | B0BC01200047 | ZENER DIODE             | 1   |         |
|        | D716     | B0ADC000025  | DIODE                   | 1   |         |
|        | D718     | B0JCPE000038 | DIODE                   | 1   |         |
|        | D719     | B0ACD000010  | DIODE                   | 1   |         |
|        | D720     | B0ACD000010  | DIODE                   | 1   |         |
|        | D721     | B0ACD000010  | DIODE                   | 1   |         |
|        | D722     | B0ACD000010  | DIODE                   | 1   |         |
|        |          |              |                         |     |         |
| △      | F100     | K5E802BZ0002 | FUSE                    | 1   |         |
| △      | F101     | K5E802BZ0002 | FUSE                    | 1   |         |
| △      | F200     | K5G631B00008 | FUSE                    | 1   |         |
| △      | F201     | K5G631B00008 | FUSE                    | 1   |         |
|        |          |              |                         |     |         |
|        | IC100    | C0DBZZZ00084 | IC                      | 1   |         |
|        | IC101    | C0DAGKC00001 | IC                      | 1   |         |
|        | IC102    | C0DAGKC00002 | IC                      | 1   |         |
|        | IC200    | C0DBZMC00006 | IC                      | 1   |         |
| △      | IC201    | MIP3E40MY    | IC                      | 1   |         |
| △      | IC202    | B3PBA0000508 | IC                      | 1   |         |
|        | IC300    | C0ABBA000168 | IC                      | 1   |         |
|        | IC301    | C0DABYY00019 | IC                      | 1   |         |
| △      | IC302    | B3PBA0000508 | IC                      | 1   |         |
| △      | IC303    | B3PBA0000508 | IC                      | 1   |         |
| △      | IC304    | B3PBA0000508 | IC                      | 1   |         |
|        | IC500    | C0DBZMC00006 | IC                      | 1   |         |
|        | IC502    | C0CAAJG00015 | IC                      | 1   |         |
| △      | IC600    | CNC1S171R    | IC                      | 1   |         |
| △      | IC601    | CNC1S171R    | IC                      | 1   |         |
|        | IC602    | C0EBH0000447 | IC                      | 1   |         |
|        | IC603    | C2ABDB000122 | IC                      | 1   |         |
|        | IC700    | C0DBZMC00006 | IC                      | 1   |         |
|        | IC701    | C0DBZMC00006 | IC                      | 1   |         |
|        | IC702    | C0DAAZH00027 | IC                      | 1   |         |
|        |          |              |                         |     |         |
|        | J501     | ERJ6GEY0R00V | M 0 OHM J 1/10W         | 1   |         |
|        |          |              |                         |     |         |
| △      | L100     | G0B163J00001 | CHOKE COIL              | 1   |         |
| △      | L101     | G0B163J00001 | CHOKE COIL              | 1   |         |
|        | L102     | EXCELDR35V   | CORE                    | 1   |         |
|        | L103     | EXCELDR35V   | CORE                    | 1   |         |
|        | L104     | EXCELDR35V   | CORE                    | 1   |         |
|        | L700     | G0C680KA0207 | CHOKE COIL              | 1   |         |
|        |          |              |                         |     |         |
|        | P2       | K1KA02A00676 | 2P CONNECTOR            | 1   |         |
|        | P6       | K1KA12AA0191 | 12P CONNECTOR           | 1   |         |
|        | P7       | K1KA11AA0191 | 11P CONNECTOR           | 1   |         |
|        | P9       | K1KA02B00295 | 2P CONNECTOR            | 1   |         |
|        | P11      | K1KA03A00608 | 3P CONNECTOR            | 1   |         |
|        | P25      | K1KA13AA0082 | 13P CONNECTOR           | 1   |         |
|        | P34      | K1KA03AA0193 | 3P CONNECTOR            | 1   |         |

| Safety | Ref. No. | Part No.      | Part Name & Description | Pcs | Remarks |
|--------|----------|---------------|-------------------------|-----|---------|
|        | P35      | K1KA03A00647  | 3P CONNECTOR            | 1   |         |
|        |          |               |                         |     |         |
| △      | PR101    | K5Y502BA0001  | FUSE                    | 1   |         |
| △      | PR600    | ERBSE0R50U    | FUSE                    | 1   |         |
| △      | PR700    | K5G502B00015  | FUSE                    | 1   |         |
| △      | PR702    | ERBSE0R50U    | FUSE                    | 1   |         |
|        |          |               |                         |     |         |
|        | Q100     | B1CHMG000004  | FET                     | 1   |         |
|        | Q101     | B1CFHG000013  | FET                     | 1   |         |
|        | Q103     | B1BCCF000022  | TRANSISTOR              | 1   |         |
| △      | Q104     | B1CERR000027  | FET                     | 1   |         |
|        | Q106     | B1HFCFA000021 | TRANSISTOR              | 1   |         |
|        | Q201     | B1HFCFA000021 | TRANSISTOR              | 1   |         |
|        | Q300     | B1CBGD000001  | FET                     | 1   |         |
|        | Q301     | B1CHND000004  | FET                     | 1   |         |
|        | Q302     | B1HFPFA00001  | TRANSISTOR              | 1   |         |
|        | Q303     | B1HFPFA00001  | TRANSISTOR              | 1   |         |
| △      | Q304     | B1CERR000028  | FET                     | 1   |         |
| △      | Q305     | B1CERR000028  | FET                     | 1   |         |
| △      | Q306     | B1CERR000028  | FET                     | 1   |         |
| △      | Q307     | B1CERR000028  | FET                     | 1   |         |
|        | Q500     | B1CHND000004  | FET                     | 1   |         |
|        | Q503     | B1CHND000004  | FET                     | 1   |         |
|        | Q504     | B1CFQC000002  | FET                     | 1   |         |
|        | Q505     | B1CHND000004  | FET                     | 1   |         |
|        | Q506     | 2SD1819ARL    | TRANSISTOR              | 1   |         |
|        | Q600     | 2SD1819ARL    | TRANSISTOR              | 1   |         |
|        | Q602     | 2SD1819ARL    | TRANSISTOR              | 1   |         |
|        | Q610     | B1CBGD000001  | FET                     | 1   |         |
|        | Q700     | 2SB1218ARL    | TRANSISTOR              | 1   |         |
|        | Q701     | B1ADCF000111  | TRANSISTOR              | 1   |         |
|        | Q702     | 2SD1819ARL    | TRANSISTOR              | 1   |         |
|        | Q703     | B1HBCFA000033 | TRANSISTOR              | 1   |         |
|        | Q704     | B1HFCFA000021 | TRANSISTOR              | 1   |         |
|        | Q705     | B1HBCFA000033 | TRANSISTOR              | 1   |         |
|        |          |               |                         |     |         |
| △      | R101     | D0B1825JA033  | M1.22MOHM, J, 0.05W     | 1   |         |
| △      | R102     | ERF5TJ100     | W 10 OHM, J, 5W         | 1   |         |
|        | R103     | ERJ6GEYJ333V  | M 33KOHM, J, 1/10W      | 1   |         |
|        | R104     | ERJ6GEYJ624   | M 620KOHM, J, 1/10W     | 1   |         |
|        | R105     | D1AB4303A023  | CHIP RESISTOR           | 1   |         |
|        | R106     | ERJ3GEYJ434   | M 430KOHM, J, 1/16W     | 1   |         |
|        | R107     | D1AB4303A023  | CHIP RESISTOR           | 1   |         |
|        | R108     | ERJ3GEYJ223   | M 22KOHM, J, 1/16W      | 1   |         |
|        | R109     | ERJ6GEYJ821   | M 820 OHM, J, 1/10W     | 1   |         |
|        | R110     | D1AB4303A023  | CHIP RESISTOR           | 1   |         |
|        | R112     | ERJ6GEYJ472V  | M 4.7K OHM J 1/10W      | 1   |         |
|        | R113     | ERJ3EKF1002   | M 10KOHM, 1/16W         | 1   |         |
|        | R114     | D0BF6R8JA035  | M 6.8OHM, J, 0.05W      | 1   |         |
|        | R115     | D0BF6R8JA035  | M 6.8OHM, J, 0.05W      | 1   |         |
|        | R116     | ERJ8GEYJ153   | M 15KOHM, J, 1/8W       | 1   |         |
|        | R117     | ERJ8GEYJ153   | M 15KOHM, J, 1/8W       | 1   |         |
|        | R118     | D0GB183JA057  | M 18K OHM J 1/16W       | 1   |         |
|        | R119     | D0GB103JA057  | M 10K OHM J 1/16W       | 1   |         |
|        | R120     | ERG12SJ181    | M 180 OHM, J, 1/2W      | 1   |         |
|        | R121     | ERJ3GEYJ333   | M 33KOHM, J, 1/16W      | 1   |         |
|        | R122     | ERX12SJ4R7    | M 4.7 OHM, J, 1/2W      | 1   |         |
|        | R123     | D0GB103JA057  | M 10K OHM J 1/16W       | 1   |         |
|        | R125     | DOXGR08J0001  | M 0.08OHM, J, 5W        | 1   |         |
|        | R126     | DOXGR08J0001  | M 0.08OHM, J, 5W        | 1   |         |
|        | R127     | ERJ6GEYJ331V  | M 330 OHM J 1/10W       | 1   |         |

| Safety | Ref. No. | Part No.     | Part Name & Description | Pcs | Remarks |
|--------|----------|--------------|-------------------------|-----|---------|
|        | R128     | ERJ6GEYJ103V | M 10K OHM J 1/10W       | 1   |         |
|        | R129     | D0GD4R7JA059 | M 4.7 OHM,J,0.25W       | 1   |         |
|        | R130     | ERJ6GEYJ104V | M 100KOHM,J,1/10W       | 1   |         |
|        | R131     | ERJ6GEYJ331V | M 330 OHM J 1/10W       | 1   |         |
|        | R132     | D0GD2R2JA059 | M 2.2 OHM,J,0.25W       | 1   |         |
|        | R133     | D1AB6803A023 | CHIP RESISTOR           | 1   |         |
|        | R134     | D1AB6803A023 | CHIP RESISTOR           | 1   |         |
|        | R135     | D1AB6803A023 | CHIP RESISTOR           | 1   |         |
|        | R136     | ERJ6GEYJ104V | M 100KOHM,J,1/10W       | 1   |         |
|        | R137     | ERJ8GEYJ474  | M 470KOHM, J,1/8W       | 1   |         |
|        | R138     | ERJ6GEYJ123V | M 12KOHM,J,1/10W        | 1   |         |
|        | R139     | ERJ6ENF1272  | M12.7KOHM, 1/10W        | 1   |         |
|        | R140     | ERJ6GEYJ821  | M 820 OHM,J,1/10W       | 1   |         |
|        | R141     | EVMAASA00B23 | CONTROL 2KOHMB          | 1   |         |
|        | R142     | D0GB103JA057 | M 10K OHM J 1/16W       | 1   |         |
|        | R143     | ERJ3GEYJ333  | M 33KOHM,J,1/16W        | 1   |         |
|        | R144     | D0GB103JA057 | M 10K OHM J 1/16W       | 1   |         |
|        | R145     | ERJ3GEYJ333  | M 33KOHM,J,1/16W        | 1   |         |
|        | R146     | ERJ3GEYJ472  | M 4.7KOHM,J,1/16W       | 1   |         |
|        | R147     | D1AB5603A023 | CHIP RESISTOR           | 1   |         |
|        | R148     | D1AB5603A023 | CHIP RESISTOR           | 1   |         |
|        | R149     | D1AB5103A023 | CHIP RESISTOR           | 1   |         |
|        | R150     | ERJ6ENF3302  | M 33KOHM, 1/10W         | 1   |         |
|        | R151     | ERJ6ENF2002  | M 20KOHM, 1/10W         | 1   |         |
|        | R200     | D1AB2203A023 | CHIP RESISTOR           | 1   |         |
|        | R201     | D1AB2203A023 | CHIP RESISTOR           | 1   |         |
|        | R202     | D1AB2203A023 | CHIP RESISTOR           | 1   |         |
|        | R203     | D1AB2203A023 | CHIP RESISTOR           | 1   |         |
|        | R204     | D1AB2203A023 | CHIP RESISTOR           | 1   |         |
|        | R205     | D1AB2203A023 | CHIP RESISTOR           | 1   |         |
|        | R206     | ERJ6ENF3302  | M 33KOHM, 1/10W         | 1   |         |
|        | R207     | ERJ6ENF4702  | M 47KOHM, 1/10W         | 1   |         |
|        | R208     | ERJ6GEYJ222V | M 2.2K OHM J 1/10W      | 1   |         |
|        | R209     | D0GB102JA057 | M 1KOHM,J,1/16W         | 1   |         |
| △      | R210     | ERF5TJ100    | W 10 OHM, J, 5W         | 1   |         |
|        | R211     | ERJ6GEYJ6R8V | M 6.8 OHM,J,1/10W       | 1   |         |
|        | R212     | ERJ6GEYJ472V | M 4.7K OHM J 1/10W      | 1   |         |
|        | R213     | ERJ6GEYJ153V | M 15KOHM,J,1/10W        | 1   |         |
|        | R214     | ERJ6GEYJ221V | M 220 OHM,J,1/10W       | 1   |         |
|        | R216     | D0GD4R7JA059 | M 4.7 OHM,J,0.25W       | 1   |         |
|        | R217     | D0GD4R7JA059 | M 4.7 OHM,J,0.25W       | 1   |         |
|        | R218     | ERJ3GEY0R00  | M 0 OHM, 1/16W          | 1   |         |
|        | R219     | ERJ6GEYF473  | M 47KOHM,J,1/10W        | 1   |         |
|        | R301     | ERJ6GEYJ472V | M 4.7K OHM J 1/10W      | 1   |         |
|        | R303     | ERJ6GEYJ332V | M 3.3K OHM J 1/10W      | 1   |         |
|        | R304     | ERJ6GEYJ104V | M 100KOHM,J,1/10W       | 1   |         |
|        | R305     | D0GD180JA036 | M 18 OHM,J,0.25W        | 1   |         |
|        | R308     | D0GB105JA057 | M 1M OHM F 1/16W        | 1   |         |
|        | R309     | ERJ6GEYJ222V | M 2.2K OHM J 1/10W      | 1   |         |
|        | R310     | ERJ6GEYJ103V | M 10K OHM J 1/10W       | 1   |         |
|        | R311     | ERJ6GEYJ153V | M 15KOHM,J,1/10W        | 1   |         |
|        | R312     | ERJ6GEYJ333V | M 33KOHM,J,1/10W        | 1   |         |
|        | R313     | ERJ6GEYF473  | M 47KOHM,J,1/10W        | 1   |         |
|        | R314     | ERJ6GEYJ100V | M 10 OHM,J,1/10W        | 1   |         |

| Safety | Ref. No. | Part No.     | Part Name & Description | Pcs | Remarks |
|--------|----------|--------------|-------------------------|-----|---------|
|        | R315     | ERJ6GEYJ222V | M 2.2K OHM J 1/10W      | 1   |         |
|        | R316     | ERJ6GEYJ223  | M 22KOHM,J,1/10W        | 1   |         |
|        | R317     | ERJ6GEYJ682  | M 6.8KOHM,J,1/10W       | 1   |         |
|        | R318     | ERJ6GEYJ472V | M 4.7K OHM J 1/10W      | 1   |         |
|        | R319     | ERJ6GEYJ223  | M 22KOHM,J,1/10W        | 1   |         |
|        | R320     | ERJ6GEYJ1R0  | M 1 OHM,J,1/10W         | 1   |         |
|        | R321     | ERJ6GEYJ223  | M 22KOHM,J,1/10W        | 1   |         |
|        | R322     | ERJ12YJ100   | M 10 OHM,J, 1/2W        | 1   |         |
|        | R323     | ERJ12YJ101   | M 100 OHM,J, 1/2W       | 1   |         |
|        | R324     | ERJ12YJ100   | M 10 OHM,J, 1/2W        | 1   |         |
|        | R325     | ERJ12YJ101   | M 100 OHM,J, 1/2W       | 1   |         |
|        | R326     | ERJ6GEYJ223  | M 22KOHM,J,1/10W        | 1   |         |
|        | R327     | ERJ6GEYJ102V | M 1K OHM J 1/10W        | 1   |         |
|        | R328     | ERJ6GEYJ104V | M 100KOHM,J,1/10W       | 1   |         |
|        | R329     | ERJ6GEYJ100V | M 10 OHM,J,1/10W        | 1   |         |
|        | R330     | ERJ6GEYJ100V | M 10 OHM,J,1/10W        | 1   |         |
|        | R331     | ERJ6GEYJ221V | M 220 OHM,J,1/10W       | 1   |         |
|        | R332     | ERJ6GEYJ100V | M 10 OHM,J,1/10W        | 1   |         |
|        | R333     | ERJ6GEYJ221V | M 220 OHM,J,1/10W       | 1   |         |
|        | R334     | ERJ6GEYJ104V | M 100KOHM,J,1/10W       | 1   |         |
|        | R335     | ERJ6GEYJ100V | M 10 OHM,J,1/10W        | 1   |         |
|        | R336     | ERJ6GEYJ221V | M 220 OHM,J,1/10W       | 1   |         |
|        | R337     | ERJ6GEYJ221V | M 220 OHM,J,1/10W       | 1   |         |
|        | R338     | ERJ6GEYJ104V | M 100KOHM,J,1/10W       | 1   |         |
|        | R339     | ERJ6GEYJ104V | M 100KOHM,J,1/10W       | 1   |         |
|        | R340     | ERJ6GEYJ104V | M 100KOHM,J,1/10W       | 1   |         |
|        | R341     | D0XB105JA007 | RESISTOR ARRAY          | 1   |         |
|        | R342     | ERJ6GEYJ102V | M 1K OHM J 1/10W        | 1   |         |
|        | R343     | ERJ6ENF1000  | M 100 OHM, 1/10W        | 1   |         |
|        | R346     | ERJ6GEYJ221V | M 220 OHM,J,1/10W       | 1   |         |
|        | R500     | ERJ6GEYJ221V | M 220 OHM,J,1/10W       | 1   |         |
|        | R502     | D0GB102JA057 | M 1KOHM,J,1/16W         | 1   |         |
|        | R503     | ERJ3GEYJ104  | M 100KOHM,J,1/16W       | 1   |         |
|        | R504     | D0GF1R5JA047 | M 1.5 OHM,J, 0.33W      | 1   |         |
|        | R505     | ERJ8GEYJ100  | M 10 OHM, J,1/8W        | 1   |         |
|        | R506     | ERJ3GEYJ104  | M 100KOHM,J,1/16W       | 1   |         |
|        | R507     | ERJ6RBD333   | M 33KOHM,J,1/10W        | 1   |         |
|        | R508     | ERJ3RBD333   | M 33KOHM, 1/16W         | 1   |         |
|        | R511     | D0GB102JA057 | M 1KOHM,J,1/16W         | 1   |         |
|        | R512     | ERJ3GEY0R00  | M 0 OHM, 1/16W          | 1   |         |
|        | R515     | ERJ3EKF2702V | M27.0KOHM, 1/16W        | 1   |         |
|        | R516     | ERJ3EKF2401  | M 2.4KOHM, 1/16W        | 1   |         |
|        | R517     | D0GB103JA057 | M 10K OHM J 1/16W       | 1   |         |
|        | R518     | ERJ3GEYJ104  | M 100KOHM,J,1/16W       | 1   |         |
|        | R521     | ERJ3GEYJ104  | M 100KOHM,J,1/16W       | 1   |         |
|        | R524     | ERJ6GEYJ683V | M 68K OHM J 1/10W       | 1   |         |
|        | R525     | ERJ6GEYJ104V | M 100KOHM,J,1/10W       | 1   |         |
|        | R526     | ERJ6GEYJ393V | M 39KOHM,J,1/10W        | 1   |         |
|        | R527     | ERJ6GEYJ101V | M 100 OHM,J,1/10W       | 1   |         |
|        | R528     | D0GB103JA057 | M 10K OHM J 1/16W       | 1   |         |
|        | R529     | ERJ3GEYJ104  | M 100KOHM,J,1/16W       | 1   |         |

| Safety | Ref. No. | Part No.     | Part Name & Description | Pcs | Remarks |
|--------|----------|--------------|-------------------------|-----|---------|
|        | R530     | ERJ6GEYJ104V | M 100KOHM, J, 1/10W     | 1   |         |
|        | R531     | ERJ6GEYJ102V | M 1K OHM J 1/10W        | 1   |         |
|        | R600     | ERJ3GEY0R00  | M 0 OHM, 1/16W          | 1   |         |
|        | R601     | ERJ6GEYJ102V | M 1K OHM J 1/10W        | 1   |         |
|        | R602     | ERJ3GEYJ224  | M 220KOHM, J, 1/16W     | 1   |         |
|        | R603     | ERJ3GEYJ101  | M 100 OHM, J, 1/16W     | 1   |         |
|        | R604     | ERJ6GEYJ104V | M 100KOHM, J, 1/10W     | 1   |         |
|        | R605     | ERJ3GEYJ224  | M 220KOHM, J, 1/16W     | 1   |         |
|        | R606     | ERJ3GEYJ101  | M 100 OHM, J, 1/16W     | 1   |         |
|        | R608     | ERJ6GEYJ102V | M 1K OHM J 1/10W        | 1   |         |
|        | R609     | ERJ6GEYJ104V | M 100KOHM, J, 1/10W     | 1   |         |
|        | R610     | ERJ6GEYJ101V | M 100 OHM, J, 1/10W     | 1   |         |
|        | R611     | ERJ6GEYJ101V | M 100 OHM, J, 1/10W     | 1   |         |
|        | R612     | ERJ3GEY0R00  | M 0 OHM, 1/16W          | 1   |         |
|        | R613     | D0GB154JA057 | M 150KOHM J 1/16W       | 1   |         |
|        | R615     | D0GB182JA057 | M 1.8KOHM J 1/16W       | 1   |         |
|        | R619     | ERJ6GEYJ101V | M 100 OHM, J, 1/10W     | 1   |         |
|        | R620     | ERJ6GEYJ102V | M 1K OHM J 1/10W        | 1   |         |
|        | R621     | ERJ3GEYJ104  | M 100KOHM, J, 1/16W     | 1   |         |
|        | R622     | ERJ6GEYJ102V | M 1K OHM J 1/10W        | 1   |         |
|        | R623     | ERJ6GEYJ104V | M 100KOHM, J, 1/10W     | 1   |         |
|        | R633     | ERJ3GEYJ222  | M 2.2KOHM, J, 1/16W     | 1   |         |
|        | R634     | D0GB102JA057 | M 1KOHM, J, 1/16W       | 1   |         |
|        | R635     | ERJ6GEYJ102V | M 1K OHM J 1/10W        | 1   |         |
|        | R636     | ERJ6GEYJ102V | M 1K OHM J 1/10W        | 1   |         |
|        | R637     | D0GB152JA057 | M 1.5KOHM J 1/16W       | 1   |         |
|        | R638     | ERJ3GEYJ101  | M 100 OHM, J, 1/16W     | 1   |         |
|        | R639     | D0GB152JA057 | M 1.5KOHM J 1/16W       | 1   |         |
|        | R640     | D0GB102JA057 | M 1KOHM, J, 1/16W       | 1   |         |
|        | R641     | ERJ6RBD152   | M 1.5KOHM, J, 1/10W     | 1   |         |
|        | R642     | D0GB102JA057 | M 1KOHM, J, 1/16W       | 1   |         |
|        | R643     | ERJ6GEYJ332V | M 3.3K OHM J 1/10W      | 1   |         |
|        | R644     | ERJ8GEYJ330  | M 33 OHM, J, 1/8W       | 1   |         |
|        | R645     | ERJ3GEYJ104  | M 100KOHM, J, 1/16W     | 1   |         |
|        | R646     | ERJ6GEYF473  | M 47KOHM, J, 1/10W      | 1   |         |
|        | R647     | ERJ6GEYJ102V | M 1K OHM J 1/10W        | 1   |         |
|        | R648     | ERJ6GEYJ393V | M 39KOHM, J, 1/10W      | 1   |         |
|        | R652     | ERJ6GEYJ392  | M 3.9KOHM, J, 1/10W     | 1   |         |
|        | R653     | ERJ6GEYJ392  | M 3.9KOHM, J, 1/10W     | 1   |         |
|        | R701     | ERJ3GEYJ104  | M 100KOHM, J, 1/16W     | 1   |         |
|        | R702     | ERJ3GEYJ683  | M 68KOHM, J, 1/16W      | 1   |         |
|        | R703     | ERJ6GEYJ222V | M 2.2K OHM J 1/10W      | 1   |         |
|        | R704     | ERJ6GEYJ102V | M 1K OHM J 1/10W        | 1   |         |
|        | R705     | ERJ6GEYJ222V | M 2.2K OHM J 1/10W      | 1   |         |
|        | R706     | ERJ3GEYJ104  | M 100KOHM, J, 1/16W     | 1   |         |
|        | R707     | ERJ1S1JW123  | M 12KOHM, J, 1W         | 1   |         |
|        | R708     | ERJ3GEY0R00  | M 0 OHM, 1/16W          | 1   |         |
|        | R709     | ERJ8GEYJ154  | M 150KOHM, J, 1/8W      | 1   |         |
|        | R710     | ERJ8GEYJ154  | M 150KOHM, J, 1/8W      | 1   |         |

| Safety | Ref. No. | Part No.     | Part Name & Description | Pcs    | Remarks |
|--------|----------|--------------|-------------------------|--------|---------|
|        | R711     | ERJ8GEYJ154  | M 150KOHM, J, 1/8W      | 1      |         |
|        | R712     | ERJ14YJ2R7U  | M 2.7OHM, 1/4W          | 1      |         |
|        | R713     | ERJ14YJ2R7U  | M 2.7OHM, 1/4W          | 1      |         |
|        | R714     | ERJ14YJ2R7U  | M 2.7OHM, 1/4W          | 1      |         |
|        | R715     | ERJ14YJ2R7U  | M 2.7OHM, 1/4W          | 1      |         |
|        | R716     | ERJ6GEYJ102V | M 1K OHM J 1/10W        | 1      |         |
|        | R717     | ERJ6GEYJ102V | M 1K OHM J 1/10W        | 1      |         |
|        | R718     | ERJ6GEYJ681  | M 680 OHM, J, 1/10W     | 1      |         |
|        | R720     | ERJ6GEYJ103V | M 10K OHM J 1/10W       | 1      |         |
|        | R721     | ERJ6GEYJ101V | M 100 OHM, J, 1/10W     | 1      |         |
|        | R722     | ERJ6GEYJ102V | M 1K OHM J 1/10W        | 1      |         |
|        | R723     | ERJ6GEYJ122V | M 1.2KOHM, J, 1/10W     | 1      |         |
|        | R724     | ERJ6GEYJ102V | M 1K OHM J 1/10W        | 1      |         |
|        | R725     | ERJ8ENF1603  | M 16KOHM, 1/8W          | 1      |         |
|        | R726     | ERJ8ENF1503  | M 15KOHM, 1/8W          | 1      |         |
|        | R727     | ERJ8ENF1303  | M 13KOHM, 1/8W          | 1      |         |
|        | R728     | ERJ8ENF1303  | M 13KOHM, 1/8W          | 1      |         |
|        | R730     | ERJ6ENF6801  | M 6.8KOHM, 1/10W        | 1      |         |
|        | R731     | ERJ6GEYJ222V | M 2.2K OHM J 1/10W      | 1      |         |
|        | R732     | ERJ8ENF5102  | M 51K OHM, 1/8W         | 1      |         |
|        | R733     | ERJ8ENF4702  | M 47K OHM, 1/8W         | 1      |         |
|        | R735     | EVMAASA00B23 | CONTROL 2KOHMB          | 1      |         |
|        | R736     | ERJ6ENF3301  | M 3.3KOHM, 1/10W        | 1      |         |
|        | R737     | EVMAASA00B23 | CONTROL 2KOHMB          | 1      |         |
|        | R738     | ERJ6ENF1303  | M 13KOHM, 1/10W         | 1      |         |
|        | R739     | ERJ6ENF1303  | M 13KOHM, 1/10W         | 1      |         |
|        | R740     | ERJ6ENF3302  | M 33KOHM, 1/10W         | 1      |         |
|        | R741     | ERJ6ENF1803  | M 180KOHM, 1/10W        | 1      |         |
|        | R742     | ERJ6ENF1803  | M 180KOHM, 1/10W        | 1      |         |
|        | R743     | ERJ6ENF1803  | M 180KOHM, 1/10W        | 1      |         |
|        | R744     | ERJ6ENF1803  | M 180KOHM, 1/10W        | 1      |         |
|        | R745     | ERJ6ENF3302  | M 33KOHM, 1/10W         | 1      |         |
|        | R748     | ERJ8ENF5600  | M 560 OHM, 1/8W         | 1      |         |
|        | R749     | ERJ3GEYJ472  | M 4.7KOHM, J, 1/16W     | 1      |         |
|        | R750     | ERJ3GEYJ333  | M 33KOHM, J, 1/16W      | 1      |         |
|        | R751     | ERJ6ENF1302  | M 13KOHM, 1/10W         | 1      |         |
|        | R752     | ERJ6ENF1101  | M 1.1KOHM, 1/10W        | 1      |         |
|        | R753     | ERJ6GEYJ101V | M 100 OHM, J, 1/10W     | 1      |         |
|        | R754     | ERJ3EKF2002  | M 20KOHM, 1/16W         | 1      |         |
|        | R755     | ERJ3EKF3302  | M 33KOHM, 1/16W         | 1      |         |
|        | R757     | D0MA30MJ0001 | M 30 OHM, J, 2W         | 1      |         |
|        | R764     | D0GB103JA057 | M 10K OHM J 1/16W       | 1      |         |
|        | R765     | D0GB103JA057 | M 10K OHM J 1/16W       | 1      |         |
|        | R766     | ERJ6GEYJ101V | M 100 OHM, J, 1/10W     | 1      |         |
|        | R768     | ERJ8ENF5600  | M 560 OHM, 1/8W         | 1      |         |
|        | R769     | ERJ6GEYJ102V | M 1K OHM J 1/10W        | 1      |         |
|        | R770     | D0GB103JA057 | M 10K OHM J 1/16W       | 1      |         |
|        | R777     | D0MA30MJ0001 | M 30 OHM, J, 2W         | 1      |         |
|        | R784     | ERJ6GEYJ102V | M 1K OHM J 1/10W        | 1      |         |
|        | R785     | ERJ3GEYJ222  | M 2.2KOHM, J, 1/16W     | 1      |         |
|        | R788     | ERJ6GEY0R00V | M 0 OHM J 1/10W         | 1      |         |
|        | R792     | ERJ3EKF2002  | M 20KOHM, 1/16W         | 1      |         |
|        | R793     | ERJ3EKF3302  | M 33KOHM, 1/16W         | 1      |         |
|        | R795     | ERJ3GEY0R00  | M 0 OHM, 1/16W          | 1      |         |
|        | R797     | ERJ6GEYF561  | M 560 OHM, F, 1/10W     | 1      |         |
|        |          |              |                         |        |         |
|        | △        | RL101        | K6B1AYY00047            | REALY  | 1       |
|        | △        | RL102        | K6B1AYY00047            | REALY  | 1       |
|        |          |              |                         |        |         |
|        | △        | S100         | JOLT00000009            | SWITCH | 1       |
|        | △        | S101         | JOLT00000009            | SWITCH | 1       |

| Safety | Ref. No. | Part No.     | Part Name & Description | Pcs | Remarks |
|--------|----------|--------------|-------------------------|-----|---------|
|        | T100     | G4D4A0000123 | SWITCHING TRANS         | 1   |         |
| △      | T200     | ETS29AZ2U6AH | TRANSFORMER             | 1   |         |
| △      | T300     | G4D3A0000214 | SWITCHING TRANS         | 1   |         |
| △      | T301     | G4D3A0000212 | SWITCHING TRANS         | 1   |         |
|        |          |              |                         |     |         |
|        | X801     | H2B400400021 | CRYSTAL                 | 1   |         |
|        |          |              |                         |     |         |
|        | Z1       | K4ZZ01000206 | TERMINAL                | 1   |         |
|        | Z2       | K4ZZ01000206 | TERMINAL                | 1   |         |
|        | Z3       | K4ZZ01000206 | TERMINAL                | 1   |         |
|        |          |              |                         |     |         |
| △      | ZN100    | ERZVRED621   | VARISTOR                | 1   |         |
| △      | ZN101    | ERZVGAD681T2 | VARISTOR                | 1   |         |
| △      | ZN102    | ERZVRED621   | VARISTOR                | 1   |         |
| △      | ZN200    | ERZVA7D511   | VARISTOR                | 1   |         |
| △      | ZN201    | ERZVA7D511   | VARISTOR                | 1   |         |
|        |          |              |                         |     |         |