

13 Exploded View and Replacement Parts List

13.1. Exploded View and Mechanical Replacement Parts List

13.1.1. Exploded View

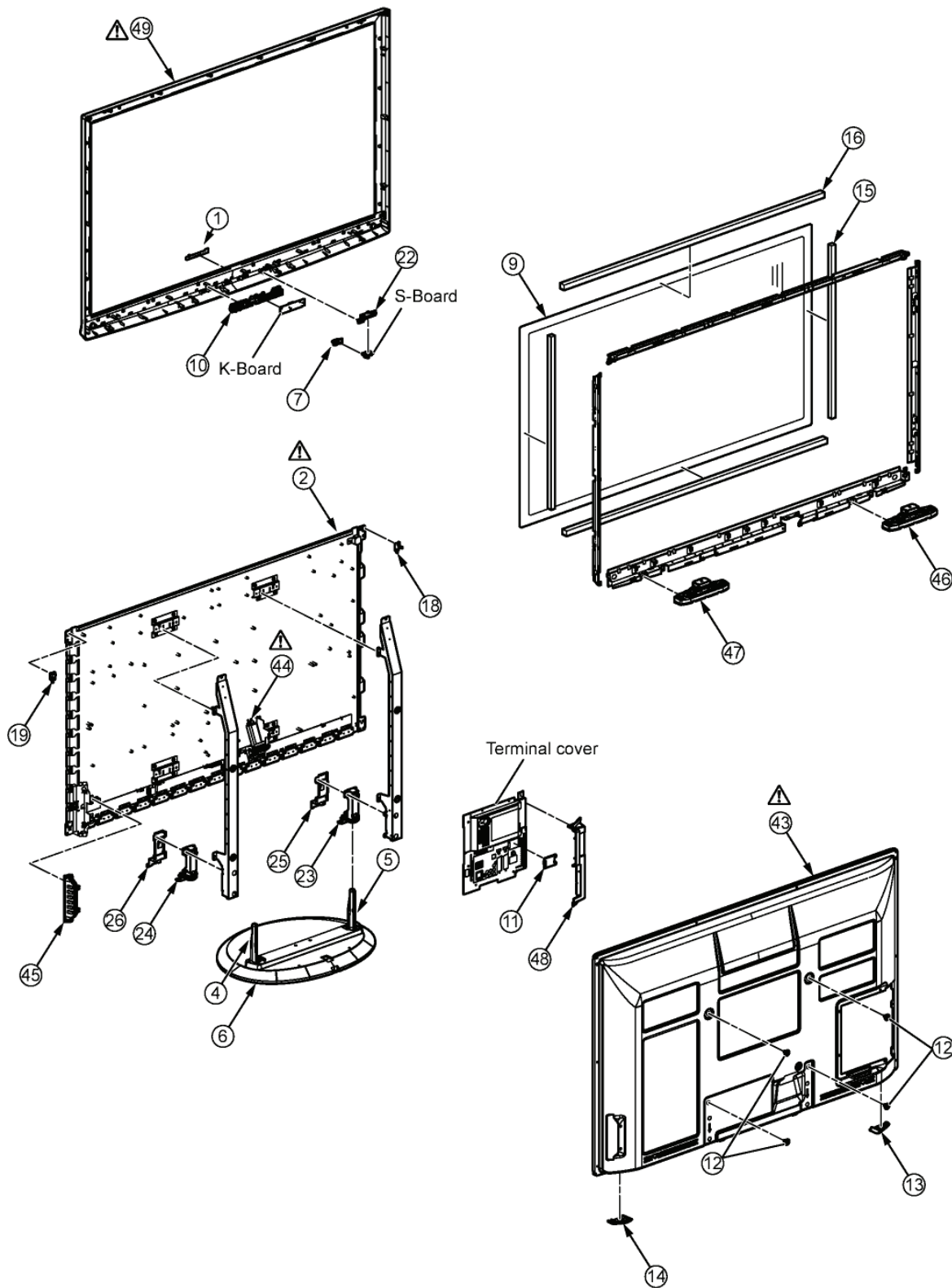

13.1.2. Packing 1

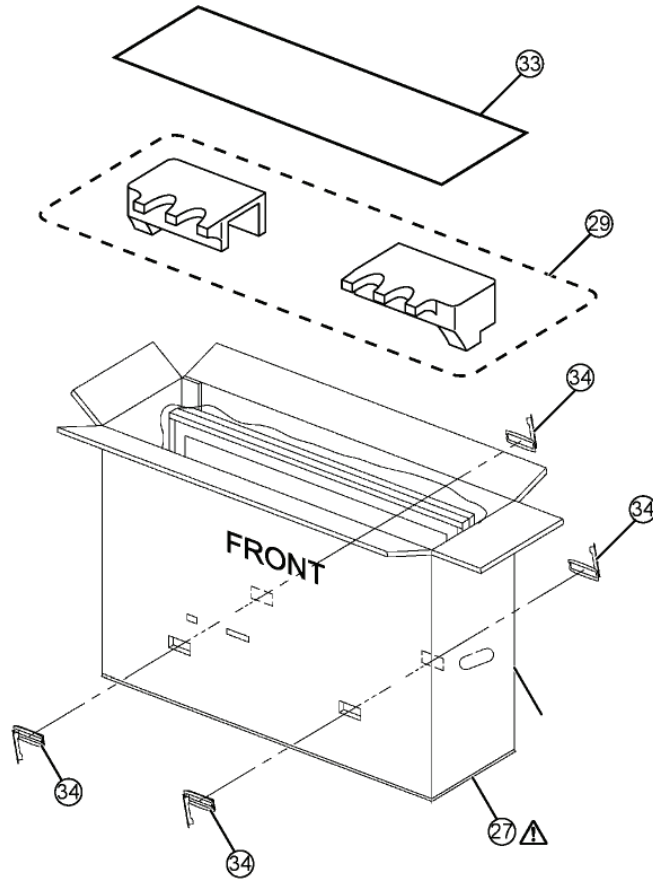



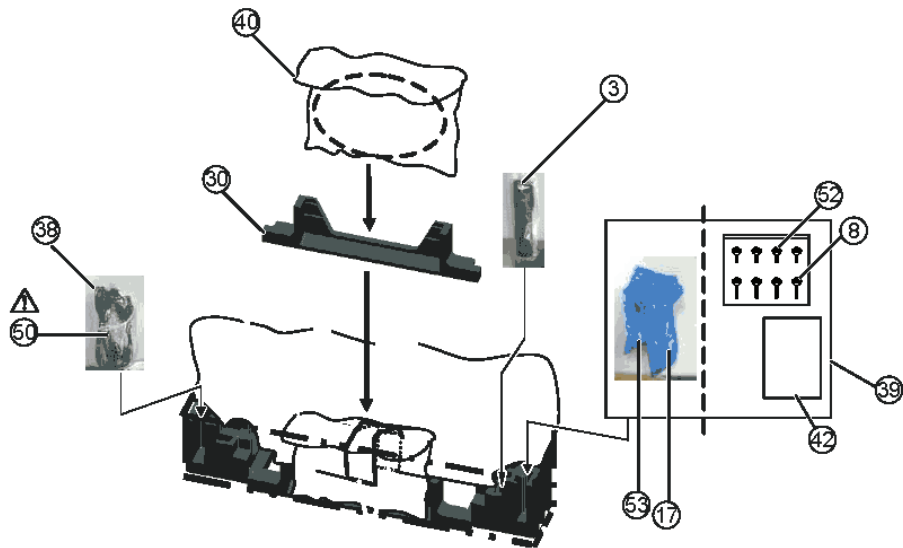
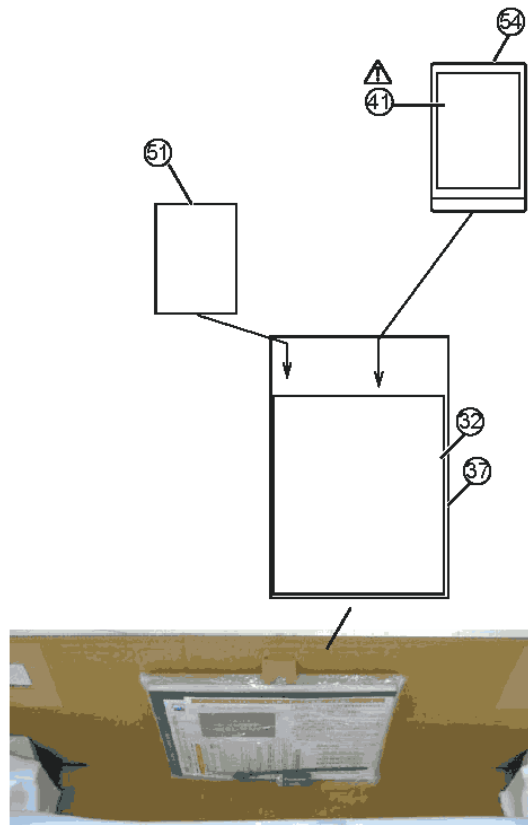
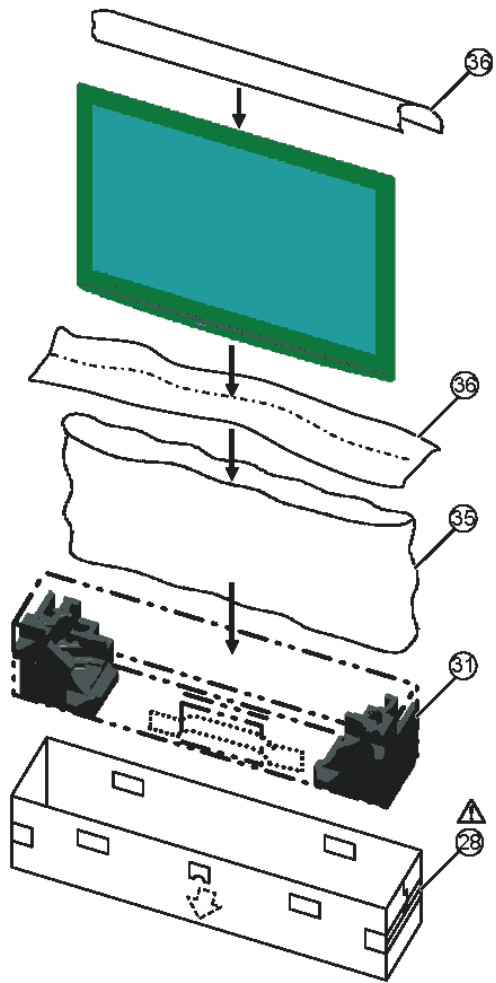

















13.1.3. Packing 2









13.1.4. Mechanical Replacement Parts List

Note: All parts except parts mentioned [PAVCCZ] in the Remarks column are supplied by AVC-CSPC.
Parts mentioned [PAVCCZ] are supplied by PAVCCZ.

Safety	Ref. No.	Part No.	Part Name & Description	Q'ty	Remarks
	50	K2CN3YY00004	AC CORD	1	E/F PAVCCZ
	50	K2CT3YY00016	AC CORD	1	B/L PAVCCZ
	2	MD42F12A1J	PLASMA DISPLAY PANEL	1	
	3	N2QAYB000328	REMOTE CONTROL	1	PAVCCZ
	4	TBLA3685	STAND POLE R	1	PAVCCZ
	5	TBLA3686	STAND POLE L	1	PAVCCZ
	6	TBLX0093	PEDESTAL STAND	1	PAVCCZ
	1	TBMA282	PANASONIC BADGE	1	
	7	TBX3EA00101	POWER BUTTON	1	PAVCCZ
		THEJ016J	SCREW (AC INRET:2)	2	
		THEL0429	SCREW	11	
		THEL052Z	SCREW (BC TOP:4)	2	
	8	THEL061N	SCREW (STAND-TV)	4	
		THTD020J	SCREW (A-PRINT:4)	4	
		THTF011N	SCREW	75	
		THTF013J	SCREW	2	
	9	TKGA5530	FRONT GLASS	1	PAVCCZ
	10	TKK3EC5001	LED PANEL	1	PAVCCZ
	11	TKK3EL5001-1	ADJUSTMENT COVER	1	PAVCCZ
	12	TKKL5472	M8 CAP	4	
	13	TKROE1901	REAR COVER HANDLE L	1	PAVCCZ
	14	TKROE2001	REAR COVER HANDLE R	1	PAVCCZ
	15	TMK0EG010	SPONGE (LEFT/RIGHT)	2	PAVCCZ
	16	TMK0EG011	SPONGE (UPPER/BOTTOM)	2	PAVCCZ
		TMM23417	CLAMPER	2	
	18	TMMD014-1	REAR COVER HOOK L	1	
	19	TMMD015-1	REAR COVER HOOK R	1	
		TMME224	CLAMPER	5	
		TMME287	CLAMPER	3	
		TMME292	CLAMPER	2	
		TMME331	CLAMPER	2	
		TMME332	CLAMPER	3	
		TMME332	CLAMPER(SS:1)	1	
		TMME332	CLAMPER(GLASS HOLDER REAR BOTTOM)	2	
	22	TMW3EC001	POWER BUTTON BRACKET	1	PAVCCZ
		TMXX055	AC CORD CLAMPER	2	
		TMXX062	AC CODE HOLDER	1	
	23	TMZ0E9911	STAND BRACKET L	1	PAVCCZ
	24	TMZ0E9912	STAND BRACKET R	1	PAVCCZ
	25	TMZX5167	STAND BRACKET METAL L	1	
	26	TMZX5168	STAND BRACKET METAL R	1	
	27	TPC0E53403	CARTON BOX TOP	1	PAVCCZ
	28	TPC0E53500	CARTON BOX BOTTOM	1	PAVCCZ

Safety	Ref. No.	Part No.	Part Name & Description	Q'ty	Remarks
	29	TPD0E1078	TOP CUSHION	1	PAVCCZ
	31	TPD0E2059	BOTTOM CUSHION	1	PAVCCZ
	30	TPD0E2060	PEDESTAL CUSHION	1	PAVCCZ
	32	TPD0E9137	ACCESSORIES PAD	1	PAVCCZ
	33	TPD0E9157	TOP PAD	1	PAVCCZ
	34	TPD169487	JOINT	4	
	35	TPE0E4010	PROTECT COVER	1	PAVCCZ
	36	TPE0E4041	PROTECT SHEET	2	PAVCCZ
	37	TPE0E9002	ACCESSORIES BAG	1	PAVCCZ
	38	TPE0E9003	BAG FOR AC CORD	1	PAVCCZ
	17	TPEB336	BAG (STAND POLE R)	1	
	39	TPEB338	BAG (STAND ACCESSORY)	1	PAVCCZ
	40	TPEB368	BAG (PEDESTAL STAND)	1	PAVCCZ
		TPG0E9310	PAPER CAP	0.25	PAVCCZ
	41	TQB0E0829	INSTRUCTION BOOK (ENGLISH)	1	B PAVCCZ
	41	TQB0E0830A	INSTRUCTION BOOK (GERMAN)	1	E PAVCCZ
	41	TQB0E0830B	INSTRUCTION BOOK (DUTCH)	1	E PAVCCZ
	41	TQB0E0830C	INSTRUCTION BOOK (ITALIAN)	1	E PAVCCZ
	41	TQB0E0830D	INSTRUCTION BOOK (FRENCH)	1	E PAVCCZ
	41	TQB0E0830E	INSTRUCTION BOOK (SPANISH)	1	E PAVCCZ
	41	TQB0E0830F	INSTRUCTION BOOK (SWEDISH)	1	E PAVCCZ
	41	TQB0E0830G	INSTRUCTION BOOK (NORWEGIAN)	1	E PAVCCZ
	41	TQB0E0830H	INSTRUCTION BOOK (FINNISH)	1	E PAVCCZ
	41	TQB0E0830I	INSTRUCTION BOOK (LITHUANIAN)	1	E PAVCCZ
	41	TQB0E0830J	INSTRUCTION BOOK (PORTUGUESE)	1	E PAVCCZ
	41	TQB0E0830K	INSTRUCTION BOOK (DANISH)	1	E PAVCCZ
	41	TQB0E0830M	INSTRUCTION BOOK (BULGARIAN)	1	E PAVCCZ
	41	TQB0E0830N	INSTRUCTION BOOK (ROMANIAN)	1	E PAVCCZ
	41	TQB0E0830O	INSTRUCTION BOOK (LATVIAN)	1	E PAVCCZ
	41	TQB0E0830P	INSTRUCTION BOOK (POLISH)	1	E PAVCCZ
	41	TQB0E0830Q	INSTRUCTION BOOK (HUNGARIAN)	1	E PAVCCZ
	41	TQB0E0830R	INSTRUCTION BOOK (CZECH)	1	E PAVCCZ
	41	TQB0E0830S	INSTRUCTION BOOK (GREEK)	1	E PAVCCZ
	41	TQB0E0830T	INSTRUCTION BOOK (TURKISH)	1	E PAVCCZ
	41	TQB0E0830U	INSTRUCTION BOOK (ENGLISH)	1	E PAVCCZ
	41	TQB0E0830W	INSTRUCTION BOOK (SLOVAKIAN)	1	E PAVCCZ
	41	TQB0E0830X	INSTRUCTION BOOK (CD-ROM)	1	E PAVCCZ
	41	TQB0E0830Z	INSTRUCTION BOOK (ESTONIAN)	1	E PAVCCZ
	41	TQB0E0831	INSTRUCTION BOOK (ENGLISH)	1	L PAVCCZ
	41	TQB0E0833D	INSTRUCTION BOOK (FRENCH)	1	F PAVCCZ
	41	TQB0E0833U	INSTRUCTION BOOK (ENGLISH)	1	F PAVCCZ
	42	TQZJ060	SCREW USE HANDBILL	1	PAVCCZ
		TSXL519	CABLE (C10-C20/SU11-SD11)	2	

Safety	Ref. No.	Part No.	Part Name & Description	Q'ty	Remarks
		TSXL814	CABLE (A20-SC20)	1	PAVCCZ
		TSXL817	CABLE (C11-A31)	1	PAVCCZ
		TSXL820	CABLE (C21-A32)	1	PAVCCZ
	43	TTU0E0473	REAR COVER	1	E PAVCCZ
	43	TTU0E0506	REAR COVER	1	B PAVCCZ
	43	TTU0E0509	REAR COVER	1	L PAVCCZ
	43	TTU0E0514	REAR COVER	1	F PAVCCZ
		TW-4BS-2L	LUG TERMINAL	1	
	44	TXAJS01EBUE	AC INLET ASSY	1	PAVCCZ
	45	TXFBX03EQUE	CONTROL BUTTON ASSY	1	PAVCCZ
	46	TXFEA01EFUE	SPEAKER L ASSY	1	PAVCCZ
	47	TXFEA02EFUE	SPEAKER R ASSY	1	PAVCCZ
	48	TXFKP01EQUE	SIDE TERMINAL COVER ASSY	1	PAVCCZ
	49	TXFKY01EFUR	CABINET ASSY	1	PAVCCZ
	51	TXFPE01RLTB	CLEANING CLOTH ASSY	1	PAVCCZ
		TXJA11EFUE	SPEAKER LEAD (A11-SPR)	1	PAVCCZ
		TXJA12ERUE	SPEAKER LEAD (A12-SPL)	1	PAVCCZ
		XSB3+6FJ	SCREW	3	
		XSB4+6FN	SCREW	2	PAVCCZ
		XTB4+10JFJ	SCREW (STAND BRACKET)	8	
		XTB4+12GFJ	SCREW	21	
		XTB4+12GFJK	SCREW	11	
		XTB4+12GFN	SCREW	4	
		XTV3+10JFJK	SCREW	4	
		XTW3+10TFJ	SCREW	1	
		XTWT4+Z15DFJ	SCREW (SP BOX)	4	
		XYN3+J12FJ	SCREW	32	
		XYN4+E8FJ	SCREW	1	
		XYN4+F10FJ	SCREW	12	
		XYN4+F10FJ	SCREW	18	
	52	XYN5+F18FN	SCREW (STAND POLE)	4	
	53	XZB9X18C05	BAG (STAND POLE L)	1	
	54	XZBT6506	POLY BAG (INSTRUCTION BOOK)	1	

13.2. Electrical Replacement Parts List

13.2.1. Replacement Parts List Notes

RTL (Retention Time Limited)

Note: The marking (RTL) indicates that the Retention Time is Limited for this item.

After the discontinuation of this assembly in production, the item will continue to be available for a specific period of time. The retention period of availability is dependant on the type of assembly, and in accordance with the laws governing part and product retention. After the end of this period, the assembly will no longer be available.

Abbreviation of part name and description

1. Resistor

2. Capacitor

Example:

Example:

ERD25TJ104 C 100KOHM, J, 1/4W
 Type Allowance

ECKF1H103ZF C 0.01UF, Z, 50V
 Type Allowance

Type	Allowance
C : Carbon	F : ±1%
F : Fuse	G : ±2%
M : Metal Oxide Metal Film	J : ±5%
S : Solid	K : ±10%
W : Wire Wound	M : ±20%

Type	Allowance
C : Ceramic	C : ±0.25pF
E : Electrolytic	D : ±0.5pF
P : Polyester	F : ±1pF
Polypropylene	G : ±3pF
J : ±5pF	
T : Tantalum	K : ±10pF
	L : ±15pF
	M : ±20pF
	P : +100%, -0%
	Z : +80%, -20%

13.2.2. Electrical Replacement Parts List

Note: All parts except parts mentioned [PAVCCZ] in the Remarks column are supplied by AVC-CSPC. Parts mentioned [PAVCCZ] are supplied by PAVCCZ.

Safety	Ref. No.	Part No.	Part Name & Description	Pcs	Remarks
	A1	K1KA14A00248	14P CONNECTOR	1	
	A7	K1KY22A00003	22P CONNECTOR	1	
	A11	K1KA03AA0728	3P CONNECTOR	1	
	A12	K1KA02AA0728	2P CONNECTOR	1	
	A20	K1MY35BA0345	35P CONNECTOR	1	
	A25	K1KA13A00152	13P CONNECTOR	1	
	A31	K1MY68BA0345	68P CONNECTOR	1	
	A32	K1MY68BA0345	68P CONNECTOR	1	
	C608	F1G1E103A123	C 0.010UF, K, 25V	1	
	C609	F2G0J470A019	E 47UF 6.3V	1	
	C1009	F1H1C104A143	C 0.1UF, K, 16V	1	
	C1010	F1J1E105A171	C 1 UF 25V	1	
	C1102	F1J1A106A043	C 0.010UF, K, 10V	1	
	C1103	F1G1C104A116	C 0.10UF, K, 16V	1	
	C1104	F1G1C104A116	C 0.10UF, K, 16V	1	
	C1105	F1H1H103A970	C 0.001UF, K, 50V	1	
	C1106	F1H1H270A971	C 27UF, 50V	1	
	C1107	F1G1H180A731	C 18UF, 50V	1	
	C1108	F1G1C104A116	C 0.10UF, K, 16V	1	
	C1109	F1H1A1050032	C 10UF, 50V	1	
	C1111	F1H1A1050032	C 10UF, 50V	1	
	C1112	F1G1C104A116	C 0.10UF, K, 16V	1	
	C1114	F1G1C104A116	C 0.10UF, K, 16V	1	
	C1117	F1G1C104A116	C 0.10UF, K, 16V	1	
	C1122	F1G1E103A123	C 0.010UF, K, 25V	1	
	C1123	F1H1A1050032	C 10UF, 50V	1	
	C2023	F1G1C104A116	C 0.10UF, K, 16V	1	
	C2049	F1G1C104A116	C 0.10UF, K, 16V	1	
	C2050	F1G1C104A116	C 0.10UF, K, 16V	1	
	C2055	F1G1H150A731	C 15UF, 50V	1	
	C2056	F1G1H150A731	C 15UF, 50V	1	
	C2058	F1G1C104A116	C 0.10UF, K, 16V	1	
	C2059	F1J1A106A043	C 0.010UF, K, 10V	1	
	C2091	F1G1H100A731	C 10PF, K, 50V	1	
	C2092	F1G1H220A731	C 22UF, 50V	1	
	C2094	F1G1E333A091	C 0.033UF, K, 25V	1	
	C2095	F1G1E333A091	C 0.033UF, K, 25V	1	
	C2096	F1G1C104A116	C 0.10UF, K, 16V	1	
	C2098	EEEHB0J221UP	C 220PF, J, 6.3V	1	
	C2099	EEEHB0J221UP	C 220PF, J, 6.3V	1	
	C2102	F1G1C104A116	C 0.10UF, K, 16V	1	
	C2105	F1G1C104A116	C 0.10UF, K, 16V	1	
	C2106	F1G1C104A116	C 0.10UF, K, 16V	1	
	C2107	F1J1A106A043	C 0.010UF, K, 10V	1	
	C2108	F1J1A106A043	C 0.010UF, K, 10V	1	
	C2109	F1G1C104A116	C 0.10UF, K, 16V	1	
	C2110	F1G1C104A116	C 0.10UF, K, 16V	1	
	C2111	F1J1A475A039	C 4.7UF, K, 10V	1	
	C2112	F1J1A106A043	C 0.010UF, K, 10V	1	
	C2113	F1J1A106A043	C 0.010UF, K, 10V	1	
	C2114	F1G1C104A116	C 0.10UF, K, 16V	1	
	C2115	F1G1C104A116	C 0.10UF, K, 16V	1	
	C2117	F1G1C104A116	C 0.10UF, K, 16V	1	
	C2118	F1J1A475A039	C 4.7UF, K, 10V	1	
	C2120	F1G1H560A731	C 56UF, 50V	1	
	C2121	F1G1H560A731	C 56UF, 50V	1	
	C2122	F1G1C103A116	C 0.010UF, K, 16V	1	
	C2123	F1G1C103A116	C 0.010UF, K, 16V	1	
	C2124	F1G1C104A116	C 0.10UF, K, 16V	1	
	C2125	F1G1C103A116	C 0.010UF, K, 16V	1	
	C2127	F1G1C103A116	C 0.010UF, K, 16V	1	
	C2128	F1G1C103A116	C 0.010UF, K, 16V	1	
	C2129	F1G1C103A116	C 0.010UF, K, 16V	1	
	C2135	F1G1C103A116	C 0.010UF, K, 16V	1	
	C2136	F1G1C103A116	C 0.010UF, K, 16V	1	
	C2137	F1J1A106A043	C 0.010UF, K, 10V	1	
	C2192	F1J1A106A043	C 0.010UF, K, 10V	1	
	C2216	F1G1C104A116	C 0.10UF, K, 16V	1	
	C2244	F1G1C104A116	C 0.10UF, K, 16V	1	
	C2245	F1G1H102A730	C 1000UF, 50V	1	
	C2251	F1J1A106A043	C 0.010UF, K, 10V	1	
	C2261	F1J1A106A043	C 0.010UF, K, 10V	1	
	C2262	F1J1A106A043	C 0.010UF, K, 10V	1	
	C2263	F1J1A106A043	C 0.010UF, K, 10V	1	
	C2264	F1J1A106A043	C 0.010UF, K, 10V	1	
	C2301	F1G1C104A116	C 0.10UF, K, 16V	1	
	C2302	F1G1C104A116	C 0.10UF, K, 16V	1	
	C2303	F1J1E105A171	C 1 UF 25V	1	
	C2305	F1J1E105A171	C 1 UF 25V	1	
	C2309	F1J1E105A171	C 1 UF 25V	1	
	C2313	F1H1A1050032	C 10UF, 50V	1	
	C2317	F1H1H104A970	C 0.1UF, K, 50V	1	
	C2319	F1H1H104A970	C 0.1UF, K, 50V	1	
	C2321	F1H1H104A970	C 0.1UF, K, 50V	1	
	C2323	F1H1H104A970	C 0.1UF, K, 50V	1	
	C2325	F1J1H474A757	C 0.47UF, 50V	1	
	C2331	F1J1H474A757	C 0.47UF, 50V	1	
	C2333	F1H1E104A129	C 0.1UF, 25V	1	
	C2335	F1H1E104A129	C 0.1UF, 25V	1	
	C2337	F1H1H223A970	C 0.22UF, K, 50V	1	
	C2339	F1H1H223A970	C 0.22UF, K, 50V	1	
	C2341	F1H1E104A129	C 0.1UF, 25V	1	
	C2343	F1H1E104A129	C 0.1UF, 25V	1	
	C2345	F1H1H223A970	C 0.22UF, K, 50V	1	
	C2347	F1H1H223A970	C 0.22UF, K, 50V	1	
	C2353	F1G1H102A730	C 1000UF, 50V	1	
	C2359	F1G1H102A730	C 1000UF, 50V	1	
	C2361	F2G1E4710007	E 470UF, 25V	1	
	C2375	F1H1H223A970	C 0.22UF, K, 50V	1	
	C2377	F1H1H223A970	C 0.22UF, K, 50V	1	
	C2379	F1H1H223A970	C 0.22UF, K, 50V	1	
	C2381	F1H1H223A970	C 0.22UF, K, 50V	1	
	C2383	F1G1H102A730	C 1000UF, 50V	1	
	C2385	F1G1H102A730	C 1000UF, 50V	1	
	C2387	F1G1H102A730	C 1000UF, 50V	1	

Safety	Ref. No.	Part No.	Part Name & Description	Pcs	Remarks
	C2389	FIG1H102A730	C 1000UF, 50V	1	
	C2390	FIJ1E105A171	C 1 UF 25V	1	
	C2407	FIK1E106A136	C 10UF, Z, 25V	1	
	C2408	FIJ1E105A171	C 1 UF 25V	1	
	C2409	FIG1H102A730	C 1000UF, 50V	1	
	C2410	FIJ1E105A171	C 1 UF 25V	1	
	C2411	FIJ1E105A171	C 1 UF 25V	1	
	C2412	FIJ1E105A171	C 1 UF 25V	1	
	C2511	FIH1C104A143	C 0.1UF, K, 16V	1	
	C2512	FIJ1A106A043	C 0.010UF, K, 10V	1	
	C2515	FIH1H103A970	C 0.001UF, K, 50V	1	
	C2517	FIH1H103A970	C 0.001UF, K, 50V	1	
	C2521	FIH1H103A970	C 0.001UF, K, 50V	1	
	C2871	FIK1E106A136	C 10UF, Z, 25V	1	
	C2872	FIG1E103A123	C 0.010UF, K, 25V	1	
	C2873	FIH1E104A129	C 0.1UF, 25V	1	
	C2874	F2G1A101A019	E 100UF, 10V	1	
	C2875	FIH1H223A970	C 0.22UF, K, 50V	1	
	C2878	FIH1H472A970	C 4700PF, K, 50V	1	
	C2901	F2G1A101A019	E 100UF, 10V	1	
	C2906	FIH1C104A143	C 0.1UF, K, 16V	1	
	C2907	FIH1C104A143	C 0.1UF, K, 16V	1	
	C2912	F2G0J101A019	E 100UF 6.3V	1	
	C2914	FIH1H104A970	C 0.1UF, K, 50V	1	
	C2916	FIH1C104A143	C 0.1UF, K, 16V	1	
	C2920	FIH1H103A970	C 0.001UF, K, 50V	1	
	C2922	FIH1C104A143	C 0.1UF, K, 16V	1	
	C2923	FIH1C104A143	C 0.1UF, K, 16V	1	
	C2925	FIG1C104A116	C 0.10UF, K, 16V	1	
	C2927	FIG1H101A731	C 100PF, K, 50V	1	
	C2928	FIG1H101A731	C 100PF, K, 50V	1	
	C2940	FIH1H104A970	C 0.1UF, K, 50V	1	
	C2960	FIH0J1050012	C 1UF, K, 16V	1	
	C2961	FIG1H471A731	C 470UF, 50V	1	
	C2962	FIH0J1050012	C 1UF, K, 16V	1	
	C3002	FIG1H561A730	C 56UF, 50V	1	
	C3003	FIG1H561A730	C 56UF, 50V	1	
	C3004	FIG1H561A730	C 56UF, 50V	1	
	C3005	FIG1H561A730	C 56UF, 50V	1	
	C3007	FIG1H561A730	C 56UF, 50V	1	
	C3008	FIG1H561A730	C 56UF, 50V	1	
	C3009	FIG1H561A730	C 56UF, 50V	1	
	C3010	FIG1H561A730	C 56UF, 50V	1	
	C3011	FIG1H561A730	C 56UF, 50V	1	
	C3012	FIG1H561A730	C 56UF, 50V	1	
	C3013	FIG1H561A730	C 56UF, 50V	1	
	C3014	FIG1H561A730	C 56UF, 50V	1	
	C3018	FIJ1A106A043	C 0.010UF, K, 10V	1	
	C3019	FIJ1A106A043	C 0.010UF, K, 10V	1	
	C3020	FIJ1A106A043	C 0.010UF, K, 10V	1	
	C3021	FIJ1A106A043	C 0.010UF, K, 10V	1	
	C3022	FIH1A1050032	C 10UF, 50V	1	
	C3024	FIH1A1050032	C 10UF, 50V	1	
	C3025	FIH1A1050032	C 10UF, 50V	1	
	C3026	FIH1A1050032	C 10UF, 50V	1	
	C3027	FIJ1A106A043	C 0.010UF, K, 10V	1	
	C3028	FIJ1A106A043	C 0.010UF, K, 10V	1	
	C3029	FIJ1A106A043	C 0.010UF, K, 10V	1	
	C3030	FIJ1A106A043	C 0.010UF, K, 10V	1	
	C3039	FIH1A1050032	C 10UF, 50V	1	
	C3041	FIH1A1050032	C 10UF, 50V	1	
	C3043	FIH1A1050032	C 10UF, 50V	1	

Safety	Ref. No.	Part No.	Part Name & Description	Pcs	Remarks
	C3044	FIH1A1050032	C 10UF, 50V	1	
	C3046	FIH1A1050032	C 10UF, 50V	1	
	C3047	FIH1A1050032	C 10UF, 50V	1	
	C3048	FIH1A1050032	C 10UF, 50V	1	
	C3049	FIH1A1050032	C 10UF, 50V	1	
	C3064	FIG1H102A730	C 1000UF, 50V	1	
	C3065	FIG1H102A730	C 1000UF, 50V	1	
	C3070	FIJ1A106A043	C 0.010UF, K, 10V	1	
	C3071	FIJ1A106A043	C 0.010UF, K, 10V	1	
	C3072	FIG1C104A116	C 0.10UF, K, 16V	1	
	C3073	FIJ1A106A043	C 0.010UF, K, 10V	1	
	C3074	FIJ1A106A043	C 0.010UF, K, 10V	1	
	C3075	FIH1A1050032	C 10UF, 50V	1	
	C3077	FIG1C104A116	C 0.10UF, K, 16V	1	
	C3078	FIJ1A106A043	C 0.010UF, K, 10V	1	
	C3083	FIJ1A106A043	C 0.010UF, K, 10V	1	
	C3084	FIJ1A106A043	C 0.010UF, K, 10V	1	
	C3085	FIJ1A106A043	C 0.010UF, K, 10V	1	
	C3086	FIJ1A106A043	C 0.010UF, K, 10V	1	
	C3087	FIJ1A106A043	C 0.010UF, K, 10V	1	
	C3088	FIJ1A106A043	C 0.010UF, K, 10V	1	
	C3089	FIJ1A106A043	C 0.010UF, K, 10V	1	
	C3090	FIJ1A106A043	C 0.010UF, K, 10V	1	
	C3091	FIJ1A106A043	C 0.010UF, K, 10V	1	
	C3092	FIJ1A106A043	C 0.010UF, K, 10V	1	
	C3095	F2G1A101A019	E 100UF, 10V	1	
	C3097	F2G1A101A019	E 100UF, 10V	1	
	C3099	FIG1H561A730	C 56UF, 50V	1	
	C3102	F2G1A101A019	E 100UF, 10V	1	
	C3103	F2G1A101A019	E 100UF, 10V	1	
	C3107	FIJ1A106A043	C 0.010UF, K, 10V	1	
	C3108	FIJ1A106A043	C 0.010UF, K, 10V	1	
	C3109	FIJ1A106A043	C 0.010UF, K, 10V	1	
	C3114	FIJ1A106A043	C 0.010UF, K, 10V	1	
	C3115	FIJ1A106A043	C 0.010UF, K, 10V	1	
	C3116	FIJ1A106A043	C 0.010UF, K, 10V	1	
	C3117	FIJ1A106A043	C 0.010UF, K, 10V	1	
	C3118	FIH1A1050032	C 10UF, 50V	1	
	C3119	FIH1A1050032	C 10UF, 50V	1	
	C3139	FIG1C104A116	C 0.10UF, K, 16V	1	
	C3140	FIG1C104A116	C 0.10UF, K, 16V	1	
	C3141	FIG1C104A116	C 0.10UF, K, 16V	1	
	C3143	FIG1C104A116	C 0.10UF, K, 16V	1	
	C3144	FIJ1A106A043	C 0.010UF, K, 10V	1	
	C3145	FIG1C104A116	C 0.10UF, K, 16V	1	
	C3146	FIJ1A106A043	C 0.010UF, K, 10V	1	
	C3147	FIJ1A106A043	C 0.010UF, K, 10V	1	
	C3257	FIG1H561A730	C 56UF, 50V	1	
	C3752	FIJ1H102A836	C 1000UF, 50V	1	
	C4500	FIG1C104A116	C 0.10UF, K, 16V	1	
	C4501	FIG1C104A116	C 0.10UF, K, 16V	1	
	C4502	FIG1C104A116	C 0.10UF, K, 16V	1	
	C4503	FIG1C104A116	C 0.10UF, K, 16V	1	

Safety	Ref. No.	Part No.	Part Name & Description	Pcs	Remarks
	C4533	F1GH680A731	C 68UF, 50V	1	
	C4534	F1G1C104A116	C 0.10UF, K, 16V	1	
	C4535	F1G1C104A116	C 0.10UF, K, 16V	1	
	C4537	F1G1C104A116	C 0.10UF, K, 16V	1	
	C4547	F1G1C104A116	C 0.10UF, K, 16V	1	
	C4548	F1G1C104A116	C 0.10UF, K, 16V	1	
	C4549	F1G1C104A116	C 0.10UF, K, 16V	1	
	C4550	F1G1C104A116	C 0.10UF, K, 16V	1	
	C4551	F1G1C104A116	C 0.10UF, K, 16V	1	
	C4552	F1G1C104A116	C 0.10UF, K, 16V	1	
	C4553	F1GH102A730	C 1000UF, 50V	1	
	C4554	F2G1C470A022	E 47UF, 16V	1	
	C4555	F1J1A106A043	C 0.010UF, K, 10V	1	
	C4567	F1G1C104A116	C 0.10UF, K, 16V	1	
	C4574	F1G1C104A116	C 0.10UF, K, 16V	1	
	C4575	F1G1C104A116	C 0.10UF, K, 16V	1	
	C4580	F1G1C104A116	C 0.10UF, K, 16V	1	
	C4585	F1G1C104A116	C 0.10UF, K, 16V	1	
	C4595	F1G1C104A116	C 0.10UF, K, 16V	1	
	C4596	F1G1A105A047	C 1UF, K, 10V	1	
	C4598	F1J1A106A043	C 0.010UF, K, 10V	1	
	C4599	F1J1A106A043	C 0.010UF, K, 10V	1	
	C4600	F1G1C104A116	C 0.10UF, K, 16V	1	
	C4601	F1J1A106A043	C 0.010UF, K, 10V	1	
	C4602	F1G1C104A116	C 0.10UF, K, 16V	1	
	C4603	F1J1A475A039	C 4.7UF, K, 10V	1	
	C4605	F1J1A475A039	C 4.7UF, K, 10V	1	
	C4606	F1J1A475A039	C 4.7UF, K, 10V	1	
	C4607	F1J1A475A039	C 4.7UF, K, 10V	1	
	C4608	F1G1C104A116	C 0.10UF, K, 16V	1	
	C4613	F1H0J1050012	C 1UF, K, 16V	1	
	C4614	F1G1A105A047	C 1UF, K, 10V	1	
	C4616	F1J1A475A039	C 4.7UF, K, 10V	1	
	C4617	F1J1A475A039	C 4.7UF, K, 10V	1	
	C4619	F1G1A105A047	C 1UF, K, 10V	1	
	C4624	F1G1C104A116	C 0.10UF, K, 16V	1	
	C4625	F1G1C104A116	C 0.10UF, K, 16V	1	
	C4626	F1G1C104A116	C 0.10UF, K, 16V	1	
	C4628	F1G1C104A116	C 0.10UF, K, 16V	1	
	C4629	F1G1C104A116	C 0.10UF, K, 16V	1	
	C4630	F1G1C104A116	C 0.10UF, K, 16V	1	
	C4631	F1J1A106A043	C 0.010UF, K, 10V	1	
	C4632	F1G1C104A116	C 0.10UF, K, 16V	1	
	C4633	F1J1A106A043	C 0.010UF, K, 10V	1	
	C4634	F1G1C104A116	C 0.10UF, K, 16V	1	
	C4635	F1J1A106A043	C 0.010UF, K, 10V	1	
	C4636	F1G1C104A116	C 0.10UF, K, 16V	1	
	C4637	F1G1C104A116	C 0.10UF, K, 16V	1	
	C4638	F1G1C104A116	C 0.10UF, K, 16V	1	
	C4640	F1G1C104A116	C 0.10UF, K, 16V	1	
	C4642	F1G1C104A116	C 0.10UF, K, 16V	1	
	C4643	F1G1C104A116	C 0.10UF, K, 16V	1	
	C4644	F1G1C104A116	C 0.10UF, K, 16V	1	
	C4645	F1G1C104A116	C 0.10UF, K, 16V	1	
	C4702	F1G1C104A116	C 0.10UF, K, 16V	1	
	C4703	F1G1C104A116	C 0.10UF, K, 16V	1	
	C5470	F1G1C103A116	C 0.010UF, K, 16V	1	
	C5471	F1G1A473A053	C 0.47UF, 10V	1	
	C5473	F1G1E103A123	C 0.010UF, K, 25V	1	
	C5482	F2G1A221A149	E 220UF, 10V	1	
	C5483	F1J1A106A043	C 0.010UF, K, 10V	1	
	C5484	F2G0J470A019	E 47UF 6.3V	1	
	C5485	F1G1C104A116	C 0.10UF, K, 16V	1	
	C5486	F1G1E392A123	C 3900UF, Z, 25V	1	
	C5487	F1H0J1050012	C 1UF, K, 16V	1	

Safety	Ref. No.	Part No.	Part Name & Description	Pcs	Remarks
	C5488	F1H0J1050012	C 1UF, K, 16V	1	
	C5490	F1J1H474A757	C 0.47UF, 50V	1	
	C5491	F1J1H474A757	C 0.47UF, 50V	1	
	C5494	F1G1H820A731	C 82UF, 50V	1	
	C5495	F2G1V220A020	E 22UF, 35V	1	
	C5496	F1G1H102A730	C 1000UF, 50V	1	
	C5520	F2G1C100A022	C 10UF J 16V	1	
	C5600	F1G1C104A116	C 0.10UF, K, 16V	1	
	C5601	F1G1H272A571	C 2700UF, 50V	1	
	C5602	F2H0J1010009	C 100UF, 6.3V	1	
	C5603	F1H1C105A145	C 0.01UF, K, 16V	1	
	C5604	F1G1E103A123	C 0.010UF, K, 25V	1	
	C5605	F1J1A475A039	C 4.7UF, K, 10V	1	
	C5606	F1G1E6820007	C 6800UF, Z, 25V	1	
	C5607	F1G1H152A571	C 1500UF, 50V	1	
	C5608	F1G1C104A116	C 0.10UF, K, 16V	1	
	C5611	F1K1E106A136	C 10UF, Z, 25V	1	
	C5612	F1K1E106A136	C 10UF, Z, 25V	1	
	C5615	F1K1E106A136	C 10UF, Z, 25V	1	
	C5616	F1G1E103A123	C 0.010UF, K, 25V	1	
	C5620	F1H1E104A129	C 0.1UF, 25V	1	
	C5621	F1H1C105A145	C 0.01UF, K, 16V	1	
	C5622	F1J1A475A039	C 4.7UF, K, 10V	1	
	C5623	F1G1H272A571	C 2700UF, 50V	1	
	C5624	F1G1H3320004	C 3300UF, 50V	1	
	C5625	F1G1C273A081	C 0.027UF, K, 16V	1	
	C5626	F1G1C104A116	C 0.10UF, K, 16V	1	
	C5627	F1G1C104A116	C 0.10UF, K, 16V	1	
	C5628	ECGRLOE680ER	C 68UF, J, 2.5V	1	
	C5629	ECGRLOE680ER	C 68UF, J, 2.5V	1	
	C5636	F1G1C104A116	C 0.10UF, K, 16V	1	
	C5637	F1G1C104A116	C 0.10UF, K, 16V	1	
	C5638	F1G1C104A116	C 0.10UF, K, 16V	1	
	C5639	F1G1C104A116	C 0.10UF, K, 16V	1	
	C5640	F1G1C104A116	C 0.10UF, K, 16V	1	
	C5641	F1G1C104A116	C 0.10UF, K, 16V	1	
	C5642	F1K1E106A136	C 10UF, Z, 25V	1	
	C5643	F1H1E104A129	C 0.1UF, 25V	1	
	C5645	F1K1E106A136	C 10UF, Z, 25V	1	
	C5646	F1K1E106A136	C 10UF, Z, 25V	1	
	C5648	F2H0J1010009	C 100UF, 6.3V	1	
	C5649	F1G1C104A116	C 0.10UF, K, 16V	1	
	C5657	F1H1A225A051	C 22UF, 50V	1	
	C5658	F1G1E103A123	C 0.010UF, K, 25V	1	
	C5696	F2G1E470A021	C 47PF, J, 25V	1	
	C5697	F1J1E105A171	C 1 UF 25V	1	
	C5699	F1K1E106A136	C 10UF, Z, 25V	1	
	C5700	F1K1E106A136	C 10UF, Z, 25V	1	
	C5722	F1J1E105A171	C 1 UF 25V	1	
	C5723	F1H1C105A145	C 0.01UF, K, 16V	1	
	C5727	F1G1C104A116	C 0.10UF, K, 16V	1	
	C5728	F1G1C104A116	C 0.10UF, K, 16V	1	
	C8003	F1H0J1050012	C 1UF, K, 16V	1	
	C8005	F1H0J1050012	C 1UF, K, 16V	1	
	C8006	F1G1C104A116	C 0.10UF, K, 16V	1	
	C8007	F1G1C104A116	C 0.10UF, K, 16V	1	
	C8008	F1G1C104A116	C 0.10UF, K, 16V	1	
	C8009	F1J1A106A043	C 0.010UF, K, 10V	1	
	C8010	F1J1A106A043	C 0.010UF, K, 10V	1	
	C8011	F1G1C104A116	C 0.10UF, K, 16V	1	
	C8012	F1G1C104A116	C 0.10UF, K, 16V	1	
	C8013	F1G1C104A116	C 0.10UF, K, 16V	1	
	C8014	F1G1C104A116	C 0.10UF, K, 16V	1	
	C8015	F1H0J1050012	C 1UF, K, 16V	1	
	C8016	F1H0J1050012	C 1UF, K, 16V	1	
	C8017	F1J1A106A043	C 0.010UF, K, 10V	1	
	C8018	F1G1C104A116	C 0.10UF, K, 16V	1	

Safety	Ref. No.	Part No.	Part Name & Description	Pcs	Remarks
	C8019	FIG1C104A116	C 0.10UF, K, 16V	1	
	C8020	FIG1C104A116	C 0.10UF, K, 16V	1	
	C8021	FIG1C104A116	C 0.10UF, K, 16V	1	
	C8022	FIH0J1050012	C 1UF, K, 16V	1	
	C8023	FIJ1A106A043	C 0.010UF, K, 10V	1	
	C8024	FIJ1A106A043	C 0.010UF, K, 10V	1	
	C8025	FIG1C104A116	C 0.10UF, K, 16V	1	
	C8026	FIG1C104A116	C 0.10UF, K, 16V	1	
	C8027	FIG1C104A116	C 0.10UF, K, 16V	1	
	C8028	FIG1C104A116	C 0.10UF, K, 16V	1	
	C8029	FIG1C104A116	C 0.10UF, K, 16V	1	
	C8030	FIH0J1050012	C 1UF, K, 16V	1	
	C8031	FIH0J1050012	C 1UF, K, 16V	1	
	C8032	FIJ1A106A043	C 0.010UF, K, 10V	1	
	C8033	FIG1C104A116	C 0.10UF, K, 16V	1	
	C8034	FIG1C104A116	C 0.10UF, K, 16V	1	
	C8035	FIJ1A106A043	C 0.010UF, K, 10V	1	
	C8036	FIJ1A106A043	C 0.010UF, K, 10V	1	
	C8037	FIG1C104A116	C 0.10UF, K, 16V	1	
	C8038	FIG1C104A116	C 0.10UF, K, 16V	1	
	C8039	FIG1C104A116	C 0.10UF, K, 16V	1	
	C8040	FIG1C104A116	C 0.10UF, K, 16V	1	
	C8041	FIG1C104A116	C 0.10UF, K, 16V	1	
	C8042	ECGRLOG680ER	C 68UF, J, 4V	1	
	C8043	FIG1C104A116	C 0.10UF, K, 16V	1	
	C8044	FIG1C104A116	C 0.10UF, K, 16V	1	
	C8045	FIG1C104A116	C 0.10UF, K, 16V	1	
	C8046	FIG1C104A116	C 0.10UF, K, 16V	1	
	C8047	FIG1C104A116	C 0.10UF, K, 16V	1	
	C8048	FIG1C104A116	C 0.10UF, K, 16V	1	
	C8049	FIG1C104A116	C 0.10UF, K, 16V	1	
	C8050	FIG1C104A116	C 0.10UF, K, 16V	1	
	C8051	FIG1C104A116	C 0.10UF, K, 16V	1	
	C8052	FIH0J1050012	C 1UF, K, 16V	1	
	C8053	FIG1C103A116	C 0.010UF, K, 16V	1	
	C8054	FIG1H150A731	C 15UF, 50V	1	
	C8055	FIG1HR50A577	C 0.50UF, 50V	1	
	C8056	FIG1C104A116	C 0.10UF, K, 16V	1	
	C8057	FIG1C104A116	C 0.10UF, K, 16V	1	
	C8058	FIJ1A106A043	C 0.010UF, K, 10V	1	
	C8063	FIH0J1050012	C 1UF, K, 16V	1	
	C8064	FIH0J1050012	C 1UF, K, 16V	1	
	C8065	FIG1C104A116	C 0.10UF, K, 16V	1	
	C8067	FIG1C104A116	C 0.10UF, K, 16V	1	
	C8069	FIG1H102A730	C 1000UF, 50V	1	
	C8070	FIG1C104A116	C 0.10UF, K, 16V	1	
	C8071	FIG1C104A116	C 0.10UF, K, 16V	1	
	C8072	FIG1C104A116	C 0.10UF, K, 16V	1	
	C8073	FIG1C104A116	C 0.10UF, K, 16V	1	
	C8074	FIG1C104A116	C 0.10UF, K, 16V	1	
	C8075	FIJ1A106A043	C 0.010UF, K, 10V	1	
	C8076	FIG1C104A116	C 0.10UF, K, 16V	1	
	C8077	FIG1C104A116	C 0.10UF, K, 16V	1	
	C8078	FIG1C104A116	C 0.10UF, K, 16V	1	
	C8079	FIG1C104A116	C 0.10UF, K, 16V	1	
	C8080	FIG1C104A116	C 0.10UF, K, 16V	1	
	C8081	FIG1C104A116	C 0.10UF, K, 16V	1	
	C8082	FIG1H102A730	C 1000UF, 50V	1	
	C8083	FIG1C104A116	C 0.10UF, K, 16V	1	
	C8084	FIG1H102A730	C 1000UF, 50V	1	
	C8085	FIG1C104A116	C 0.10UF, K, 16V	1	
	C8086	FIG1C104A116	C 0.10UF, K, 16V	1	
	C8087	FIG1C104A116	C 0.10UF, K, 16V	1	
	C8088	FIG1C104A116	C 0.10UF, K, 16V	1	
	C8089	FIG1C104A116	C 0.10UF, K, 16V	1	
	C8090	FIG1C104A116	C 0.10UF, K, 16V	1	
	C8092	FIG1C104A116	C 0.10UF, K, 16V	1	

Safety	Ref. No.	Part No.	Part Name & Description	Pcs	Remarks
	C8093	FIG1C104A116	C 0.10UF, K, 16V	1	
	C8094	FIG1C104A116	C 0.10UF, K, 16V	1	
	C8095	FIG1C104A116	C 0.10UF, K, 16V	1	
	C8096	FIG1C104A116	C 0.10UF, K, 16V	1	
	C8097	FIG1C104A116	C 0.10UF, K, 16V	1	
	C8098	FIG1C104A116	C 0.10UF, K, 16V	1	
	C8099	FIG1C104A116	C 0.10UF, K, 16V	1	
	C8100	FIG1C104A116	C 0.10UF, K, 16V	1	
	C8101	FIG1C104A116	C 0.10UF, K, 16V	1	
	C8102	FIG1C104A116	C 0.10UF, K, 16V	1	
	C8201	FIG1C104A116	C 0.10UF, K, 16V	1	
	C8202	FIG1C104A116	C 0.10UF, K, 16V	1	
	C8306	FIG1A4740003	C0.047UF, K, 10V	1	
	C8307	FIG1C104A116	C 0.10UF, K, 16V	1	
	C8309	FIG1C104A116	C 0.10UF, K, 16V	1	
	C8311	FIG1H120A731	C 12UF, 50V	1	
	C8312	FIG1H120A731	C 12UF, 50V	1	
	C8313	FIG1C104A116	C 0.10UF, K, 16V	1	
	C8314	FIG1C104A116	C 0.10UF, K, 16V	1	
	C8316	FIG1C271A117	C 270UF, K, 16V	1	
	C8317	FIG1C271A117	C 270UF, K, 16V	1	
	C8319	FIG1C104A116	C 0.10UF, K, 16V	1	
	C8320	FIG1C104A116	C 0.10UF, K, 16V	1	
	C8321	FIG1C104A116	C 0.10UF, K, 16V	1	
	C8327	FIG1H1A225A051	C 22UF, 50V	1	
	C8328	FIG1H1A1050032	C 10UF, 50V	1	
	C8329	FIG1C104A116	C 0.10UF, K, 16V	1	
	C8330	FIG1C104A116	C 0.10UF, K, 16V	1	
	C8331	FIG1C104A116	C 0.10UF, K, 16V	1	
	C8332	FIG1C104A116	C 0.10UF, K, 16V	1	
	C8333	FIG1C104A116	C 0.10UF, K, 16V	1	
	C8334	FIG1C104A116	C 0.10UF, K, 16V	1	
	C8335	FIG1C104A116	C 0.10UF, K, 16V	1	
	C8336	FIG1C104A116	C 0.10UF, K, 16V	1	
	C8340	FIG1C104A116	C 0.10UF, K, 16V	1	
	C8343	FIG1C104A116	C 0.10UF, K, 16V	1	
	C8344	FIG1C104A116	C 0.10UF, K, 16V	1	
	C8345	FIG1C104A116	C 0.10UF, K, 16V	1	
	C8346	FIG1C104A116	C 0.10UF, K, 16V	1	
	C8405	FIG1C104A116	C 0.10UF, K, 16V	1	
	C8408	FIG1C104A116	C 0.10UF, K, 16V	1	
	C8409	FIG1C104A116	C 0.10UF, K, 16V	1	
	C8410	FIG1C104A116	C 0.10UF, K, 16V	1	
	C8411	F2G1A101A019	E 100UF, 10V	1	
	C8412	FIG1C104A116	C 0.10UF, K, 16V	1	
	C8413	FIG1C104A116	C 0.10UF, K, 16V	1	
	C8414	FIG1C104A116	C 0.10UF, K, 16V	1	
	C8415	FIG1C104A116	C 0.10UF, K, 16V	1	
	C8416	FIG1E103A123	C 0.010UF, K, 25V	1	
	C8417	FIG1E103A123	C 0.010UF, K, 25V	1	
	C8418	FIG1C104A116	C 0.10UF, K, 16V	1	
	C8508	FIG1C103A116	C 0.010UF, K, 16V	1	
	C8510	FIJ1A106A043	C 0.010UF, K, 10V	1	
	C8531	FIG1H220A731	C 22UF, 50V	1	
	C8532	F2G1C470A022	E 47UF, 16V	1	
	C8533	FIG1C104A116	C 0.10UF, K, 16V	1	
	C8535	FIG1C103A116	C 0.010UF, K, 16V	1	
	C8544	FIG1J0G2260001	C 0.001UF, 6.3V	1	
	C8580	FIG1C104A116	C 0.10UF, K, 16V	1	
	C8581	FIG1C104A116	C 0.10UF, K, 16V	1	
	C8582	FIG1C104A116	C 0.10UF, K, 16V	1	
	C9033	FIG1C104A116	C 0.10UF, K, 16V	1	
	C9034	FIG1C104A116	C 0.10UF, K, 16V	1	
	C9035	FIJ1A106A043	C 0.010UF, K, 10V	1	
	C9036	FIJ1A106A043	C 0.010UF, K, 10V	1	
	C9037	FIG1E103A123	C 0.010UF, K, 25V	1	

Safety	Ref. No.	Part No.	Part Name & Description	Pcs	Remarks
	C9038	F1G1E103A123	C 0.010UF, K, 25V	1	
	C9040	F1G1C104A116	C 0.10UF, K, 16V	1	
	C9044	F1J1A475A039	C 4.7UF, K, 10V	1	
	C9045	F1G1C104A116	C 0.10UF, K, 16V	1	
	C9046	F1G1C104A116	C 0.10UF, K, 16V	1	
	C9047	F1G1C104A116	C 0.10UF, K, 16V	1	
	C9048	F1G1C104A116	C 0.10UF, K, 16V	1	
	C9049	F1G1C104A116	C 0.10UF, K, 16V	1	
	C9052	F1G1C104A116	C 0.10UF, K, 16V	1	
	C9053	F1G1C104A116	C 0.10UF, K, 16V	1	
	C9055	F1G1C104A116	C 0.10UF, K, 16V	1	
	C9057	F1G1C104A116	C 0.10UF, K, 16V	1	
	C9061	F1G1C104A116	C 0.10UF, K, 16V	1	
	C9062	F1J1A475A039	C 4.7UF, K, 10V	1	
	C9063	F1G1C104A116	C 0.10UF, K, 16V	1	
	C9064	F1G1C104A116	C 0.10UF, K, 16V	1	
	C9065	F1G1C104A116	C 0.10UF, K, 16V	1	
	C9066	F1H1E104A129	C 0.1UF, 25V	1	
	C9067	F1K0J226A008	C 22UF, K,6.3V	1	
	C9068	F1K0J226A008	C 22UF, K,6.3V	1	
	C9069	F1G1H222A730	C 2200UF, 50V	1	
	C9071	F1H1E104A129	C 0.1UF, 25V	1	
	C9072	F1K0J226A008	C 22UF, K,6.3V	1	
	C9073	F1K0J226A008	C 22UF, K,6.3V	1	
	C9074	F1G1H222A730	C 2200UF, 50V	1	
	C9076	F1G1C153A116	C 0.015UF, K, 16V	1	
	C9077	F1K1E106A136	C 10UF, Z, 25V	1	
	C9078	F1K1E106A136	C 10UF, Z, 25V	1	
	C9079	F1G1H220A731	C 22UF, 50V	1	
	C9080	F1G1H201A731	C 200 UF, K, 50V	1	
	C9081	F1G1C104A116	C 0.10UF, K, 16V	1	
	C9082	F1H1E104A129	C 0.1UF, 25V	1	
	C9083	F1K0J226A008	C 22UF, K,6.3V	1	
	C9084	F1K0J226A008	C 22UF, K,6.3V	1	
	C9085	F1G1H222A730	C 2200UF, 50V	1	
	C9087	F1G1A563A053	C 0.56UF, 10V	1	
	C9088	F1K1E106A136	C 10UF, Z, 25V	1	
	C9089	F1K1E106A136	C 10UF, Z, 25V	1	
	C9091	F1G1H201A731	C 200 UF, K, 50V	1	
	C9100	F1G1C104A116	C 0.10UF, K, 16V	1	
	C9101	F1G1C104A116	C 0.10UF, K, 16V	1	
	C9102	F1G1C104A116	C 0.10UF, K, 16V	1	
	C9111	F1J1A106A043	C 0.010UF, K, 10V	1	
	C9112	F1J1A106A043	C 0.010UF, K, 10V	1	
	C9113	F1G1C104A116	C 0.10UF, K, 16V	1	
	C9114	F1G1C104A116	C 0.10UF, K, 16V	1	
	C9115	F1G1C104A116	C 0.10UF, K, 16V	1	
	C9123	F1J1A106A043	C 0.010UF, K, 10V	1	
	C9124	F1J1A106A043	C 0.010UF, K, 10V	1	
	C9134	F1G1C104A116	C 0.10UF, K, 16V	1	
	C9135	F1G1C104A116	C 0.10UF, K, 16V	1	
	C9136	F1G1C104A116	C 0.10UF, K, 16V	1	
	C9138	F1G1C104A116	C 0.10UF, K, 16V	1	
	C9139	F1J1A106A043	C 0.010UF, K, 10V	1	
	C9140	F1G1C104A116	C 0.10UF, K, 16V	1	
	C9141	F1J1A106A043	C 0.010UF, K, 10V	1	
	C9142	F1H1A1050032	C 10UF, 50V	1	
	C9143	F1H1A1050032	C 10UF, 50V	1	
	C9144	F1G1C104A116	C 0.10UF, K, 16V	1	
	C9145	F1H1A1050032	C 10UF, 50V	1	
	C9146	F1H1A1050032	C 10UF, 50V	1	
	C9147	F1H1A1050032	C 10UF, 50V	1	
	C9148	F1H1A1050032	C 10UF, 50V	1	
	C9149	F1H1A1050032	C 10UF, 50V	1	
	C9150	F1H1A1050032	C 10UF, 50V	1	
	C9151	F1H1A1050032	C 10UF, 50V	1	
	C9152	F1H1A1050032	C 10UF, 50V	1	

Safety	Ref. No.	Part No.	Part Name & Description	Pcs	Remarks
	C9153	F1H1A1050032	C 10UF, 50V	1	
	C9154	F1H1A1050032	C 10UF, 50V	1	
	C9155	F1H1A1050032	C 10UF, 50V	1	
	C9156	F1H1A1050032	C 10UF, 50V	1	
	C9157	F1H1A1050032	C 10UF, 50V	1	
	C9158	F1H1A1050032	C 10UF, 50V	1	
	C9159	F1H1A1050032	C 10UF, 50V	1	
	C9160	F1H1A1050032	C 10UF, 50V	1	
	C9161	F1H1A1050032	C 10UF, 50V	1	
	C9162	F1H1A1050032	C 10UF, 50V	1	
	C9163	F1H1A1050032	C 10UF, 50V	1	
	C9164	F1H1A1050032	C 10UF, 50V	1	
	C9165	F1H1A1050032	C 10UF, 50V	1	
	C9166	F1H1A1050032	C 10UF, 50V	1	
	C9167	F1H1A1050032	C 10UF, 50V	1	
	C9168	F1H1A1050032	C 10UF, 50V	1	
	C9169	F1H1A1050032	C 10UF, 50V	1	
	C9300	F1G1C104A116	C 0.10UF, K, 16V	1	
	C9302	F1G1C104A116	C 0.10UF, K, 16V	1	
	C9303	F1G1C104A116	C 0.10UF, K, 16V	1	
	C9305	F1G1C104A116	C 0.10UF, K, 16V	1	
	C9306	F1G1C104A116	C 0.10UF, K, 16V	1	
	C9310	F1G1C104A116	C 0.10UF, K, 16V	1	
	C9311	F1G1C104A116	C 0.10UF, K, 16V	1	
	C9312	F1G1C104A116	C 0.10UF, K, 16V	1	
	C9313	F1G1C104A116	C 0.10UF, K, 16V	1	
	C9314	F1G1C104A116	C 0.10UF, K, 16V	1	
	C9468	F1G1E103A123	C 0.010UF, K, 25V	1	
	C9469	F1G1C104A116	C 0.10UF, K, 16V	1	
	C9535	F1G1C104A116	C 0.10UF, K, 16V	1	
	C9536	F1G1C104A116	C 0.10UF, K, 16V	1	
	C9537	F1G1C104A116	C 0.10UF, K, 16V	1	
	C9538	F1G1C104A116	C 0.10UF, K, 16V	1	
	C9539	F1G1C104A116	C 0.10UF, K, 16V	1	
	C9540	F1G1C104A116	C 0.10UF, K, 16V	1	
	C9541	F1G1C104A116	C 0.10UF, K, 16V	1	
	C9542	F1G1C104A116	C 0.10UF, K, 16V	1	
	C9543	F1G1C104A116	C 0.10UF, K, 16V	1	
	C9544	F1G1C104A116	C 0.10UF, K, 16V	1	
	C9545	F1G1C104A116	C 0.10UF, K, 16V	1	
	C9546	F1G1C104A116	C 0.10UF, K, 16V	1	
	C9547	F1G1C104A116	C 0.10UF, K, 16V	1	
	C9548	F1G1C104A116	C 0.10UF, K, 16V	1	
	C9549	F1G1C104A116	C 0.10UF, K, 16V	1	
	C9550	F1G1C104A116	C 0.10UF, K, 16V	1	
	C9556	F1G1E103A123	C 0.010UF, K, 25V	1	
	C9557	F1G1E103A123	C 0.010UF, K, 25V	1	
	C9700	F1G1C104A116	C 0.10UF, K, 16V	1	
	C9701	F1G1C104A116	C 0.10UF, K, 16V	1	
	C9702	F1G1C104A116	C 0.10UF, K, 16V	1	
	C9703	F1G1C104A116	C 0.10UF, K, 16V	1	
	C9704	F1G1C104A116	C 0.10UF, K, 16V	1	
	C9706	F1G1C104A116	C 0.10UF, K, 16V	1	
	C9709	F1G1C104A116	C 0.10UF, K, 16V	1	
	C9713	F1G1C104A116	C 0.10UF, K, 16V	1	
	C9714	F1G1C104A116	C 0.10UF, K, 16V	1	
	C9715	F1G1C104A116	C 0.10UF, K, 16V	1	
	C9716	F1G1C104A116	C 0.10UF, K, 16V	1	
	C9823	F1K1E106A136	C 10UF, Z, 25V	1	
	C9825	F1G1H101A731	C 100PF, K, 50V	1	
	C9832	F1J1A106A043	C 0.010UF, K, 10V	1	
	C9837	F1J1A106A043	C 0.010UF, K, 10V	1	
	C9840	F1G1E103A123	C 0.010UF, K, 25V	1	
	C9844	F1G1E103A123	C 0.010UF, K, 25V	1	
	C9845	F1G1C104A116	C 0.10UF, K, 16V	1	
	C9846	F1G1C104A116	C 0.10UF, K, 16V	1	
	C9858	F1K1E106A136	C 10UF, Z, 25V	1	

Safety	Ref. No.	Part No.	Part Name & Description	Pcs	Remarks
	C9859	FIG1E103A123	C 0.010UF, K, 25V	1	
	C9863	FIG1E472A123	C 4200UF, Z, 25V	1	
	C9869	FIG1E106A136	C 10UF, Z, 25V	1	
	C9872	FIG1E106A136	C 10UF, Z, 25V	1	
	C9874	FIG1H101A731	C 100PF, K, 50V	1	
	C9882	FIG1H201A731	C 200 UF, K, 50V	1	
	C9889	FIG1A106A043	C 0.010UF, K, 10V	1	
	C9899	FIG1A106A043	C 0.010UF, K, 10V	1	
	C9900	FIG1C104A116	C 0.10UF, K, 16V	1	
	C9901	FIG1C104A116	C 0.10UF, K, 16V	1	
	C9902	FIG1C104A116	C 0.10UF, K, 16V	1	
	C9903	FIG1C104A116	C 0.10UF, K, 16V	1	
	C9904	FIG1C104A116	C 0.10UF, K, 16V	1	
	C9905	FIG1C104A116	C 0.10UF, K, 16V	1	
	C9906	FIG1C104A116	C 0.10UF, K, 16V	1	
	C9907	FIG1C104A116	C 0.10UF, K, 16V	1	
	C9908	FIG1C104A116	C 0.10UF, K, 16V	1	
	C9909	FIG1C104A116	C 0.10UF, K, 16V	1	
	C9910	FIG1C104A116	C 0.10UF, K, 16V	1	
	C9911	FIG1C104A116	C 0.10UF, K, 16V	1	
	C9912	FIG1C104A116	C 0.10UF, K, 16V	1	
	C9913	FIG1C104A116	C 0.10UF, K, 16V	1	
	C9914	FIG1C104A116	C 0.10UF, K, 16V	1	
	C9915	FIG1C104A116	C 0.10UF, K, 16V	1	
	C9916	FIG1C104A116	C 0.10UF, K, 16V	1	
	C9917	FIG1C104A116	C 0.10UF, K, 16V	1	
	C9918	FIG1C104A116	C 0.10UF, K, 16V	1	
	C9920	FIG1C104A116	C 0.10UF, K, 16V	1	
	C9921	FIG1C104A116	C 0.10UF, K, 16V	1	
	C9922	FIG1C104A116	C 0.10UF, K, 16V	1	
	C9923	FIG1C104A116	C 0.10UF, K, 16V	1	
	C9924	FIG1C104A116	C 0.10UF, K, 16V	1	
	C9925	FIG1C104A116	C 0.10UF, K, 16V	1	
	C9926	FIG1A106A043	C 0.010UF, K, 10V	1	
	C9949	FIG1C104A116	C 0.10UF, K, 16V	1	
	C9950	FIG1C104A116	C 0.10UF, K, 16V	1	
	C9952	FIG1C104A116	C 0.10UF, K, 16V	1	
	C9953	FIG1C104A116	C 0.10UF, K, 16V	1	
	C9954	FIG1C104A116	C 0.10UF, K, 16V	1	
	C9956	FIG1C104A116	C 0.10UF, K, 16V	1	
	C9957	FIG1C104A116	C 0.10UF, K, 16V	1	
	C9958	FIG1C104A116	C 0.10UF, K, 16V	1	
	C9960	FIG1A106A043	C 0.010UF, K, 10V	1	
	C9961	FIG1A106A043	C 0.010UF, K, 10V	1	
	C9962	FIG1A106A043	C 0.010UF, K, 10V	1	
	C9965	FIG1C104A116	C 0.10UF, K, 16V	1	
	C9966	FIG1A106A043	C 0.010UF, K, 10V	1	
	C9967	FIG1C104A116	C 0.10UF, K, 16V	1	
	C9968	FIG1C104A116	C 0.10UF, K, 16V	1	
	C9970	FIG1C104A116	C 0.10UF, K, 16V	1	
	C9971	FIG1H150A731	C 15UF, 50V	1	
	C9972	FIG1H180A731	C 18UF, 50V	1	
	C9973	FIG1C104A116	C 0.10UF, K, 16V	1	
	C9976	FIG1C104A116	C 0.10UF, K, 16V	1	
	C9977	FIG1C104A116	C 0.10UF, K, 16V	1	
	C9980	FIG1C104A116	C 0.10UF, K, 16V	1	
	C9984	FIG1A106A043	C 0.010UF, K, 10V	1	
	C9985	FIG1A106A043	C 0.010UF, K, 10V	1	
	C9986	FIG1C104A116	C 0.10UF, K, 16V	1	
	C9987	FIG1C104A116	C 0.10UF, K, 16V	1	
	C9988	FIG1C104A116	C 0.10UF, K, 16V	1	
	C9989	ECGRLO680ER	C 68UF, J, 4V	1	
	C9990	FIG1C104A116	C 0.10UF, K, 16V	1	
	C9991	FIG1C104A116	C 0.10UF, K, 16V	1	
	C9992	FIG1C104A116	C 0.10UF, K, 16V	1	

Safety	Ref. No.	Part No.	Part Name & Description	Pcs	Remarks
	C9993	FIG1C104A116	C 0.10UF, K, 16V	1	
	C9994	FIG1C104A116	C 0.10UF, K, 16V	1	
	C9995	FIG1C104A116	C 0.10UF, K, 16V	1	
	C9996	FIG1C104A116	C 0.10UF, K, 16V	1	
	C9997	FIG1C104A116	C 0.10UF, K, 16V	1	
	CN0100	K1KA11AA0715	11P CONNECTOR	1	
	CN0101	K1KA20AA0009	20P CONNECTOR	1	
	D1107	MA3X704A0L	ZENER DIODE	1	
	D1112	MA2J72800L	ZENER DIODE	1	
	D2014	MA2J11100L	DIODE	1	
	D2017	MA2J11100L	DIODE	1	
	D2512	MAZ80560ML	ZENER DIODE	1	
	D2520	B3AGB0000057	LED	1	
	D2524	MAZ80560ML	ZENER DIODE	1	
	D2525	B3ACB0000225	LED	1	PAVCCZ
	D2526	MAZ80560ML	ZENER DIODE	1	
	D2530	MAZ80560ML	ZENER DIODE	1	
	D2870	BOJCM000037	DIODE	1	
	D2871	MA8120M	ZENER DIODE	1	
	D3013	MAZ81400ML	ZENER DIODE	1	
	D3014	MAZ81400ML	ZENER DIODE	1	
	D3015	K7AAAY000003	PHOTO LINK	1	
	D3048	MA3X704A0L	ZENER DIODE	1	
	D3054	EZJPOV080GA	VARISTOR	1	
	D3201	EZJPOV080GA	VARISTOR	1	
	D3339	MA3X704A0L	ZENER DIODE	1	
	D4503	EZAEG2A50AX	DIODE	1	
	D4505	EZAEG2A50AX	DIODE	1	
	D4507	EZAEG2A50AX	DIODE	1	
	D4509	EZAEG2A50AX	DIODE	1	
	D4511	EZAEG2A50AX	DIODE	1	
	D4512	EZAEG2A50AX	DIODE	1	
	D4513	BOBC5R6A0275	DIODE	1	
	D4516	EZAEG2A50AX	DIODE	1	
	D4517	EZAEG2A50AX	DIODE	1	
	D4518	EZAEG2A50AX	DIODE	1	
	D4520	EZAEG2A50AX	DIODE	1	
	D4521	EZAEG2A50AX	DIODE	1	
	D4523	EZAEG2A50AX	DIODE	1	
	D4525	MA2J11100L	DIODE	1	
	D4526	MA2J11100L	DIODE	1	
	D4541	MA2J11100L	DIODE	1	
	D4542	MA2J11100L	DIODE	1	
	D4573	EZAEG2A50AX	DIODE	1	
	D4574	EZAEG2A50AX	DIODE	1	
	D4575	MA2J11100L	DIODE	1	
	D4576	BOHCMM000014	DIODE	1	
	D4577	BOHCMM000014	DIODE	1	
	D4583	BOHCMM000014	DIODE	1	
	D4587	EZAEG2A50AX	DIODE	1	
	D4588	EZAEG2A50AX	DIODE	1	
	D4589	EZAEG2A50AX	DIODE	1	
	D4590	EZAEG2A50AX	DIODE	1	
	D4591	EZAEG2A50AX	DIODE	1	
	D4592	EZAEG2A50AX	DIODE	1	
	D4593	EZAEG2A50AX	DIODE	1	
	D4594	EZAEG2A50AX	DIODE	1	
	D4595	EZAEG2A50AX	DIODE	1	
	D4596	EZAEG2A50AX	DIODE	1	
	D4597	EZAEG2A50AX	DIODE	1	
	D4598	EZAEG2A50AX	DIODE	1	
	D4599	EZAEG2A50AX	DIODE	1	
	D4600	EZAEG2A50AX	DIODE	1	
	D4601	EZAEG2A50AX	DIODE	1	
	D4602	EZAEG2A50AX	DIODE	1	
	D4611	BOBC5R6A0275	DIODE	1	
	D4615	MA2J11100L	DIODE	1	
	D4617	BOBC5R6A0275	DIODE	1	
	D5481	BOHCMM000014	DIODE	1	
	D5482	BOHCMM000014	DIODE	1	
	D5483	MA3X78900L	ZENER DIODE	1	

Safety	Ref. No.	Part No.	Part Name & Description	Pcs	Remarks
	D5485	B0BC03900015	ZENER DIODE	1	
	D5600	B0BC4R700007	ZENER DIODE	1	
	D5603	B0BC6R600005	ZENER DIODE	1	
	D5607	B0BC4R700007	ZENER DIODE	1	
	D5608	B0BC4R700007	ZENER DIODE	1	
	D5612	MAZ80560LL	ZENER DIODE	1	
	D5620	B0BC01100001	ZENER DIODE	1	
	D5621	MA3X152D0L	DIODE	1	
	D5622	MA3X152D0L	DIODE	1	
	D9000	B0JCCE000008	DIODE	1	
	D9110	B0JCGD000002	DIODE	1	
	D9800	B0JCPE000004	DIODE	1	
	FL3001	J0HABB000003	LC FILTER	1	
	FL3002	J0HABB000003	LC FILTER	1	
	FL3003	J0HABB000004	LC FILTER	1	
	FL3004	J0HABB000004	LC FILTER	1	
	FL3005	J0HABB000004	LC FILTER	1	
	FL9803	F1J1E104A148	C 0.10UF, Z, 25V	1	
	FL9805	F1J1E104A148	C 0.10UF, Z, 25V	1	
	FL9806	F1J1E104A148	C 0.10UF, Z, 25V	1	
	GK1	K1KA02BA0061	2P CONNECTOR	1	
	IC1000	C1ZBZ0003775	IC	1	
	IC1100	MNZSFH9GP83	IC	1	
	IC1101	TVRQ392	IC	1	PAVCCZ
	IC2008	C0DBGY00578	IC	1	
	IC2301	C1AB00002875	IC	1	
	IC2802	C0DBAYY00462	IC	1	
	IC2960	C0DBGHF00001	IC	1	
	IC3001	C1AB00002855	IC	1	
	IC3003	C0DBGY00281	IC	1	
	IC4510	C1AB00003045	IC	1	
	IC4511	C0DBGY00578	IC	1	
	IC4512	C0CBCAG00039	IC	1	
	IC4513	C0DBGY00618	IC	1	
	IC5401	C0CBZZE00001	IC	1	
	IC5470	C0EBM0000026	IC	1	
	IC5480	C1ZBZ0003972	IC	1	
	IC5600	C0DBAYY00480	IC	1	
	IC5601	C0DBAYY00480	IC	1	
	IC8001	MN2WS0059	IC	1	
	IC8002	C3ABTG000007	IC	1	
	IC8003	C3ABTG000007	IC	1	
	IC8004	C0ZBZ0001567	IC	1	
	IC8301	C1AB00003049	IC	1	
	IC8302	C0DBFY000028	IC	1	
	IC8401	C1AB00002913	IC	1	PAVCCZ
	IC8403	C0ZBZ0001584	IC	1	PAVCCZ
	IC8404	C0JBAZ001120	IC	1	
	IC8405	C0JBAZ001120	IC	1	
	IC8408	C0JBAU000025	IC	1	PAVCCZ
	IC8409	C0JBAZ002811	IC	1	
	IC8410	C0JBAU000025	IC	1	PAVCCZ
	IC8411	C0JBAU000025	IC	1	PAVCCZ
	IC8502	TVRQ434	IC	1	PAVCCZ
	IC8580	TVRQ370AE	IC	1	PAVCCZ
	IC9001	TVRQ384	IC	1	PAVCCZ
	IC9003	MNZSFH8KPF3	IC	1	
	IC9004	C1ZBZ0003983	IC	1	
	IC9300	MN84528	IC	1	
	IC9303	TVRQ703	IC	1	PAVCCZ
	IC9500	C1ZBZ0003760	IC	1	
	IC9805	C0DBAYY00477	IC	1	
	IC9806	C0DBAYY00478	IC	1	
	IC9807	C0DBAYY00477	IC	1	
	IC9808	C0CBCAC00365	IC	1	
	IC9902	C3ABRY000040	IC	1	
	IC9903	C3ABRY000040	IC	1	
	JK3001	K1FY115B0021	CONNECTOR	1	
	JK3002A	K1FY121A0008	CONNECTOR	1	PAVCCZ

Safety	Ref. No.	Part No.	Part Name & Description	Pcs	Remarks
	JK3003A	K1FY121A0008	CONNECTOR	1	PAVCCZ
	JK3100A	K2HA7YYA0004	TERMINAL	1	PAVCCZ
	JK3107A	K4AK17B00004	TERMINAL	1	PAVCCZ
	JK4500	K1FY119D00006	CONNECTOR	1	
	JK4501	K1FY119D00006	CONNECTOR	1	
	JK4502	K1FY119E00005	CONNECTOR	1	
	JK8302	K1NA09E000080	9P CONNECTOR	1	
	JK8401	K1NA68B000051	68P CONNECTOR	1	PAVCCZ
	K1	K1KA11B000092	11P CONNECTOR	1	
	L1100	J0JYC0000068	CHIP INDUCTOR	1	
	L2001	G1C150KA0038	INDUCTION COIL	1	
	L2010	G1C220MA0291	INDUCTION COIL	1	
	L2012	G1C220MA0291	INDUCTION COIL	1	
	L2014	G1C220MA0291	INDUCTION COIL	1	
	L2016	G1C220MA0291	INDUCTION COIL	1	
	L2018	J0JHC0000042	CHIP INDUCTOR	1	
	L2023	G1C3R0ZA0156	INDUCTION COIL	1	
	L2032	J0JYC0000068	CHIP INDUCTOR	1	
	L2870	G1C101M00029	INDUCTION COIL	1	
	L2901	J0JCC00000278	CHIP INDUCTOR	1	
	L2902	J0JCC0000269	CHIP INDUCTOR	1	
	L2904	J0JCC0000269	CHIP INDUCTOR	1	
	L3002	J0JCC0000287	CHIP INDUCTOR	1	
	L3003	J0JCC0000287	CHIP INDUCTOR	1	
	L3004	J0JCC0000287	CHIP INDUCTOR	1	
	L3005	J0JCC0000287	CHIP INDUCTOR	1	
	L3006	J0JCC0000287	CHIP INDUCTOR	1	
	L3007	J0JCC0000287	CHIP INDUCTOR	1	
	L3008	J0JCC0000287	CHIP INDUCTOR	1	
	L3009	J0JCC0000287	CHIP INDUCTOR	1	
	L3010	J0JCC0000287	CHIP INDUCTOR	1	
	L3011	J0JCC0000287	CHIP INDUCTOR	1	
	L3014	J0JCC0000287	CHIP INDUCTOR	1	
	L3015	J0JCC0000287	CHIP INDUCTOR	1	
	L3017	J0JCC0000287	CHIP INDUCTOR	1	
	L3018	J0JCC0000287	CHIP INDUCTOR	1	
	L3026	J0JCC0000287	CHIP INDUCTOR	1	
	L3027	J0JCC0000287	CHIP INDUCTOR	1	
	L3028	J0JCC0000287	CHIP INDUCTOR	1	
	L3029	J0JCC0000287	CHIP INDUCTOR	1	
	L3030	J0JCC0000287	CHIP INDUCTOR	1	
	L3034	J0JCC0000364	CHIP INDUCTOR	1	
	L3035	J0JCC0000364	CHIP INDUCTOR	1	
	L4502	J0JYC0000068	CHIP INDUCTOR	1	
	L4503	J0JYC0000068	CHIP INDUCTOR	1	
	L4504	J0JYC0000068	CHIP INDUCTOR	1	
	L4505	J0JYC0000068	CHIP INDUCTOR	1	
	L4506	J0JYC0000068	CHIP INDUCTOR	1	
	L4507	J0JYC0000068	CHIP INDUCTOR	1	
	L4511	J0JYC0000068	CHIP INDUCTOR	1	
	L4512	J0JCC0000059	CHIP INDUCTOR	1	
	L4513	J0JCC0000059	CHIP INDUCTOR	1	
	L4514	J0JYC0000068	CHIP INDUCTOR	1	
	L4515	J0JYC0000068	CHIP INDUCTOR	1	
	L4516	J0JYC0000068	CHIP INDUCTOR	1	
	L4517	J0JYC0000068	CHIP INDUCTOR	1	
	L4518	J0JYC0000068	CHIP INDUCTOR	1	
	L4519	J0JYC0000068	CHIP INDUCTOR	1	
	L4521	J0JYC0000068	CHIP INDUCTOR	1	
	L4522	J0JYC0000068	CHIP INDUCTOR	1	
	L4523	J0JYC0000068	CHIP INDUCTOR	1	
	L5480	J0JYC0000068	CHIP INDUCTOR	1	
	L5481	G1C100MA0072	INDUCTION COIL	1	
	L5544	G1C470MA0291	INDUCTION COIL	1	
	L5600	G1C2R2Z00007	INDUCTION COIL	1	
	L5601	G1C3R3Z00004	INDUCTION COIL	1	
	L5602	G1C4R7Z00014	INDUCTION COIL	1	
	L5603	G1C6R8Z00008	INDUCTION COIL	1	
	L5604	G1C100MA0203	INDUCTION COIL	1	
	L5605	J0JHC0000075	CHIP INDUCTOR	1	
	L5606	G1C100MA0203	INDUCTION COIL	1	

Safety	Ref. No.	Part No.	Part Name & Description	Pcs	Remarks
	L8001	J0JHC0000045	CHIP INDUCTOR	1	
	L8002	J0JHC0000045	CHIP INDUCTOR	1	
	L8003	J0JHC0000045	CHIP INDUCTOR	1	
	L8004	J0JHC0000045	CHIP INDUCTOR	1	
	L8005	J0JHC0000045	CHIP INDUCTOR	1	
	L8007	J0JHC0000045	CHIP INDUCTOR	1	
	L8008	J0JHC0000045	CHIP INDUCTOR	1	
	L8009	J0JHC0000045	CHIP INDUCTOR	1	
	L8010	J0JHC0000045	CHIP INDUCTOR	1	
	L8011	J0JHC0000045	CHIP INDUCTOR	1	
	L8012	J0JHC0000045	CHIP INDUCTOR	1	
	L8013	J0JHC0000045	CHIP INDUCTOR	1	
	L8301	J0JHC0000045	CHIP INDUCTOR	1	
	L8303	G1CR15JA0020	INDUCTION COIL	1	
	L8304	J0JHC0000045	CHIP INDUCTOR	1	
	L8501	J0JHC0000045	CHIP INDUCTOR	1	
	L8580	J0JHC0000075	CHIP INDUCTOR	1	
	L9001	G1C3R3Z00004	INDUCTION COIL	1	
	L9002	G1C6R8Z00008	INDUCTION COIL	1	
	L9700	J0JHC0000117	CHIP INDUCTOR	1	
	L9701	J0JHC0000117	CHIP INDUCTOR	1	
	L9802	G1C6R8Z00010	INDUCTION COIL	1	
	L9900	J0JHC0000117	CHIP INDUCTOR	1	
	L9901	J0JHC0000117	CHIP INDUCTOR	1	
	L9903	J0JHC0000117	CHIP INDUCTOR	1	
	L9904	J0JHC0000117	CHIP INDUCTOR	1	
	PA5600	K5H5022A0031	FUSE	1	
	PC2511	B3JB00000046	IC	1	
△	PCB	TXNGK1EQUE	CIRCUIT BOARD GK	1	(RTL) PAVCCZ
△	PCB	A-P42S10E	CIRCUIT BOARD A	1	(RTL) PAVCCZ
△	PCB	A-P42S10B	CIRCUIT BOARD A	1	(RTL) PAVCCZ
△	PCB	A-P42S10L	CIRCUIT BOARD A	1	(RTL) PAVCCZ
△	PCB	A-PF42S10	CIRCUIT BOARD A	1	(RTL) PAVCCZ
△	PCB	TXN/S1EQUE	CIRCUIT BOARD S	1	(RTL) PAVCCZ
△	PCB	TXN/K1EQUE	CIRCUIT BOARD K	1	(RTL) PAVCCZ
	Q2001	B1ABCF000231	TRANSISTOR	1	
	Q2022	B1ADCE000022	TRANSISTOR	1	
	Q2063	2SD0601ASL	TRANSISTOR	1	
	Q2064	2SD0601ASL	TRANSISTOR	1	
	Q2065	2SB0709ASL	TRANSISTOR	1	
	Q2510	2SD0601ARL	TRANSISTOR	1	
	Q2511	2SD0601ARL	TRANSISTOR	1	
	Q2513	2SD0601ARL	TRANSISTOR	1	
	Q2519	2SD0601ARL	TRANSISTOR	1	
	Q3000	B1ABCF000231	TRANSISTOR	1	
	Q3001	B1ABCF000231	TRANSISTOR	1	
	Q3002	B1ABCF000231	TRANSISTOR	1	
	Q3003	B1ABCF000231	TRANSISTOR	1	
	Q3004	B1ABCF000231	TRANSISTOR	1	
	Q3005	B1ABCF000231	TRANSISTOR	1	
	Q4500	B1ABCF000231	TRANSISTOR	1	
	Q4501	B1ABCF000231	TRANSISTOR	1	
	Q4514	2SB0709ASL	TRANSISTOR	1	
	Q4515	2SB0709ASL	TRANSISTOR	1	
	Q4516	2SB0709ASL	TRANSISTOR	1	
	Q4517	2SB0709ASL	TRANSISTOR	1	
	Q4519	2SB0709ASL	TRANSISTOR	1	
	Q4520	B1ABCF000231	TRANSISTOR	1	
	Q4533	B1ABCF000231	TRANSISTOR	1	
	Q4534	B1ABCF000231	TRANSISTOR	1	
	Q4535	B1ABCF000231	TRANSISTOR	1	
	Q5480	B1ADCE000022	TRANSISTOR	1	
	Q5600	B1MBDDA00003	FET	1	

Safety	Ref. No.	Part No.	Part Name & Description	Pcs	Remarks
	Q5601	B1MBDDA00003	FET	1	
	Q5602	B1MBDDA00003	FET	1	
	Q5603	B1MBDDA00003	FET	1	
	Q5606	2SD0601ARL	TRANSISTOR	1	
	Q5607	2SD0601ARL	TRANSISTOR	1	
	Q5608	2SB0709ARL	TRANSISTOR	1	
	Q8200	2SD0601ARL	TRANSISTOR	1	
	Q8401	2SD0601ARL	TRANSISTOR	1	
	Q8402	2SD0601ARL	TRANSISTOR	1	
	Q9000	B1ABCF000231	TRANSISTOR	1	
	Q9001	B1ABCF000231	TRANSISTOR	1	
	Q9002	B1ABCF000231	TRANSISTOR	1	
	Q9003	B1ABCF000231	TRANSISTOR	1	
	Q9004	B1ABCF000231	TRANSISTOR	1	
	Q9301	2SD0601ARL	TRANSISTOR	1	
	Q9302	2SD0601ARL	TRANSISTOR	1	
	Q9807	2SD0601ARL	TRANSISTOR	1	
	R0180	ERJ2GEJ101	M 100 OHM, J, 0.063W	1	
	R606	ERJ2GEJ223	M 22KOHM, J, 0.063W	1	
	R607	ERJ2GEJ473	M 47KOHM, J, 0.063W	1	
	R0900	ERJ2GEJ680	M 68 OHM, J, 0.063W	1	
	R0901	EXB28V680JX	RESISTOR ARRAY	1	
	R0902	ERJ2GEJ102X	M 1K OHM J 1/4W	1	
	R0905	ERJ2GEJ103	M 10KOHM, J, 0.063W	1	
	R0906	ERJ2GEJ103	M 10KOHM, J, 0.063W	1	
	R0907	ERJ2GEJ103	M 10KOHM, J, 0.063W	1	
	R0909	ERJ2GEJ220	M 22 OHM, J, 0.063W	1	
	R0910	ERJ2GEJ220	M 22 OHM, J, 0.063W	1	
	R0911	ERJ2GEJ220	M 22 OHM, J, 0.063W	1	
	R0912	ERJ2GEJ220	M 22 OHM, J, 0.063W	1	
	R0913	ERJ2GEJ220	M 22 OHM, J, 0.063W	1	
	R0914	ERJ2GEJ220	M 22 OHM, J, 0.063W	1	
	R0915	ERJ2GEJ472	M 4.7KOHM, J, 0.063W	1	
	R0916	ERJ2GEJ472	M 4.7KOHM, J, 0.063W	1	
	R0917	ERJ2GEJ220	M 22 OHM, J, 0.063W	1	
	R0918	ERJ2GEJ220	M 22 OHM, J, 0.063W	1	
	R0919	ERJ2GEJ220	M 22 OHM, J, 0.063W	1	
	R0920	ERJ2GEJ220	M 22 OHM, J, 0.063W	1	
	R0927	ERJ2GEJ220	M 22 OHM, J, 0.063W	1	
	R0928	ERJ2GEJ220	M 22 OHM, J, 0.063W	1	
	R0929	ERJ2GEJ220	M 22 OHM, J, 0.063W	1	
	R0930	ERJ2GEJ220	M 22 OHM, J, 0.063W	1	
	R0933	DOYAR0000007	M 0 OHM 1/4W	1	
	R0934	DOYAR0000007	M 0 OHM 1/4W	1	
	R0935	ERJ2GEJ220	M 22 OHM, J, 0.063W	1	
	R0936	ERJ2GEJ220	M 22 OHM, J, 0.063W	1	
	R0937	ERJ2GEJ472	M 4.7KOHM, J, 0.063W	1	
	R0938	ERJ2GEJ472	M 4.7KOHM, J, 0.063W	1	
	R0939	DOYAR0000007	M 0 OHM 1/4W	1	
	R0940	DOYAR0000007	M 0 OHM 1/4W	1	

Safety	Ref. No.	Part No.	Part Name & Description	Pcs	Remarks
	R0941	DOYAR0000007	M 0 OHM 1/4W	1	
	R0942	DOYAR0000007	M 0 OHM 1/4W	1	
	R0945	ERJ2GEJ220	M 22 OHM, J,0.063W	1	
	R0946	ERJ2GEJ220	M 22 OHM, J,0.063W	1	
	R0947	ERJ2GEJ680	M 68 OHM, J,0.063W	1	
	R0948	ERJ2GEJ680	M 68 OHM, J,0.063W	1	
	R0949	ERJ2GEJ680	M 68 OHM, J,0.063W	1	
	R0950	ERJ2GEJ680	M 68 OHM, J,0.063W	1	
	R0951	ERJ2GEJ680	M 68 OHM, J,0.063W	1	
	R0952	ERJ2GEJ680	M 68 OHM, J,0.063W	1	
	R0953	ERJ2GEJ680	M 68 OHM, J,0.063W	1	
	R0954	ERJ2GEJ680	M 68 OHM, J,0.063W	1	
	R0955	ERJ2GEJ472	M 4.7KOHM, J,0.063W	1	
	R0956	ERJ2GEJ472	M 4.7KOHM, J,0.063W	1	
	R0957	ERJ2GEJ472	M 4.7KOHM, J,0.063W	1	
	R0958	ERJ2GEJ472	M 4.7KOHM, J,0.063W	1	
	R0959	ERJ2GEJ472	M 4.7KOHM, J,0.063W	1	
	R0960	ERJ2GEJ472	M 4.7KOHM, J,0.063W	1	
	R0961	ERJ2GEJ472	M 4.7KOHM, J,0.063W	1	
	R0962	ERJ2GEJ472	M 4.7KOHM, J,0.063W	1	
	R1010	D0GB103JA041	M 10K OHM J 1/ 16W	1	
	R1146	DOYAR0000007	M 0 OHM 1/4W	1	
	R1153	ERJ2GEJ681	M 680 OHM, J,0.063W	1	
	R1163	ERJ2GEJ105	M 1MOHM, J,0.063W	1	
	R1173	ERJ2GEJ331	M 330 OHM, J,0.063W	1	
	R1179	DOYAR0000007	M 0 OHM 1/4W	1	
	R1181	DOYAR0000007	M 0 OHM 1/4W	1	
	R1182	ERJ2GED273X	M 27KOHM ,J,0.063W	1	
	R1197	DOYAR0000007	M 0 OHM 1/4W	1	
	R1203	ERJ2GEJ473	M 47KOHM, J,0.063W	1	
	R1209	ERJ2GEJ472	M 4.7KOHM, J,0.063W	1	
	R1221	D1BB7151A055	M7.15KOHM, 1/10W	1	
	R1224	ERJ2GEJ103	M 10KOHM, J,0.063W	1	
	R1225	ERJ2GEJ103	M 10KOHM, J,0.063W	1	
	R1236	ERJ2GEJ473	M 47KOHM, J,0.063W	1	
	R1237	ERJ2GEJ102X	M 1K OHM J 1/4W	1	
	R1243	ERJ2GEJ473	M 47KOHM, J,0.063W	1	
	R1255	ERJ2GEJ102X	M 1K OHM J 1/4W	1	
	R1400	ERJ2GEJ103	M 10KOHM, J,0.063W	1	
	R1401	ERJ2GEJ104	M 100KOHM, J,0.063W	1	
	R1402	ERJ2GEJ683	M 68KOHM, J,0.063W	1	
	R1403	ERJ2GEJ333	M 33KOHM, J,0.063W	1	
	R1404	ERJ2GEJ683	M 68KOHM, J,0.063W	1	
	R1405	ERJ2GEJ333	M 33KOHM, J,0.063W	1	

Safety	Ref. No.	Part No.	Part Name & Description	Pcs	Remarks
	R1406	ERJ2GEJ683	M 68KOHM, J,0.063W	1	
	R1407	ERJ2GEJ473	M 47KOHM, J,0.063W	1	
	R1410	ERJ2GEJ103	M 10KOHM, J,0.063W	1	
	R1411	ERJ2GEJ104	M 100KOHM, J,0.063W	1	
	R1413	ERJ2GEJ473	M 47KOHM, J,0.063W	1	
	R2002	ERJ2GEJ102X	M 1K OHM J 1/4W	1	
	R2003	ERJ2GEJ105	M 1MOHM, J,0.063W	1	
	R2006	ERJ2GEJ471	M 470 OHM, J,0.063W	1	
	R2007	ERJ2GEJ221	M 220 OHM, J,0.063W	1	
	R2008	ERJ2GEJ471	M 470 OHM, J,0.063W	1	
	R2015	ERJ2GEJ103	M 10KOHM, J,0.063W	1	
	R2016	ERJ2GEJ103	M 10KOHM, J,0.063W	1	
	R2017	ERJ2GEJ103	M 10KOHM, J,0.063W	1	
	R2018	ERJ2GEJ103	M 10KOHM, J,0.063W	1	
	R2019	D1BB2002A055	M 20KOHM, 1/10W	1	
	R2020	D1BB2001A055	M 2KOHM, 1/10W	1	
	R2023	ERJ2GEJ103	M 10KOHM, J,0.063W	1	
	R2032	DOYAR0000007	M 0 OHM 1/4W	1	
	R2047	D1BB2802A055	M 28KOHM, 1/10W	1	
	R2048	D1BB2802A055	M 28KOHM, 1/10W	1	
	R2050	D1BB2802A055	M 28KOHM, 1/10W	1	
	R2051	D1BB2802A055	M 28KOHM, 1/10W	1	
	R2063	DOYAR0000007	M 0 OHM 1/4W	1	
	R2064	DOYAR0000007	M 0 OHM 1/4W	1	
	R2092	ERJ2GEJ103	M 10KOHM, J,0.063W	1	
	R2093	ERJ2GEJ103	M 10KOHM, J,0.063W	1	
	R2110	ERJ2GEJ101	M 100 OHM, J,0.063W	1	
	R2111	ERJ2GEJ101	M 100 OHM, J,0.063W	1	
	R2114	ERJ2GEJ222	M 2.2KOHM, J,0.063W	1	
	R2115	ERJ2GEJ222	M 2.2KOHM, J,0.063W	1	
	R2118	ERJ2GEJ471	M 470 OHM, J,0.063W	1	
	R2119	ERJ2GEJ105	M 1MOHM, J,0.063W	1	
	R2120	ERJ2GEJ473	M 47KOHM, J,0.063W	1	
	R2121	ERJ8GEYJ3R3V	M 3.3 OHM, J,1/ 8W	1	
	R2122	ERJ2GEJ101	M 100 OHM, J,0.063W	1	
	R2123	ERJ8GEYJ3R3V	M 3.3 OHM, J,1/ 8W	1	
	R2124	ERJ2GEJ103	M 10KOHM, J,0.063W	1	
	R2125	ERJ8GEYJ3R3V	M 3.3 OHM, J,1/ 8W	1	
	R2127	ERJ8GEYJ3R3V	M 3.3 OHM, J,1/ 8W	1	
	R2129	ERJ2GEJ100	M 10 OHM, J,0.063W	1	
	R2132	ERJ2GEJ471	M 470 OHM, J,0.063W	1	
	R2137	ERJ2GEJ100	M 10 OHM, J,0.063W	1	
	R2141	ERJ2GEJ102X	M 1K OHM J 1/4W	1	
	R2142	ERJ2GEJ222	M 2.2KOHM, J,0.063W	1	
	R2172	ERJ2GEJ680	M 68 OHM, J,0.063W	1	

Safety	Ref. No.	Part No.	Part Name & Description	Pcs	Remarks
	R2190	ERJ2GEJ472	M 4.7KOHM, J, 0.063W	1	
	R2316	EXB28V220J	RESISTOR ARRAY	1	
	R2325	DOYAR0000007	M 0 OHM 1/4W	1	
	R2516	ERJ3GEYJ223	M 22KOHM, J, 1/16W	1	
	R2517	ERJ3GEYJ470	M 47 OHM, J, 1/16W	1	
	R2520	ERJ3GEYJ224	M 220KOHM, J, 1/16W	1	
	R2524	ERJ3GEYJ223	M 22KOHM, J, 1/16W	1	
	R2525	D1BB7500A055	M 750 OHM, 1/10W	1	
	R2530	D0GB473JA057	M 47KOHM, J, 1/16W	1	
	R2531	D1BB2700A055	M 270 OHM, 1/10W	1	
	R2542	D0GB473JA057	M 47KOHM, J, 1/16W	1	
	R2556	D0GB103JA041	M 10K OHM J 1/16W	1	
	R2557	ERJ3GEYJ223	M 22KOHM, J, 1/16W	1	
	R2561	ERJ3GEYJ223	M 22KOHM, J, 1/16W	1	
	R2562	D0GB473JA057	M 47KOHM, J, 1/16W	1	
	R2565	D1BB1001A055	M 1KOHM, 1/16W	1	
	R2581	D0GDR00Z0002	M 0 OHM, 1/10W	1	
	R2756	ERJ2GEJ101	M 100 OHM, J, 0.063W	1	
	R2757	ERJ2GEJ101	M 100 OHM, J, 0.063W	1	
	R2816	ERJ2GEJ473	M 47KOHM, J, 0.063W	1	
	R2832	ERJ2GEJ473	M 47KOHM, J, 0.063W	1	
	R2870	ERJ2GEJ390	M 39 OHM, J, 0.063W	1	
	R2871	ERJ2GEJ103	M 10KOHM, J, 0.063W	1	
	R2872	ERJ2GEJ683	M 68KOHM, J, 0.063W	1	
	R2873	DOYAR0000007	M 0 OHM 1/4W	1	
	R2874	ERJ2GEJ103	M 10KOHM, J, 0.063W	1	
	R2875	ERJ2GEJ203X	M 20KOHM, J, 0.063W	1	
	R2905	DOYAR0000007	M 0 OHM 1/4W	1	
	R2909	DOYAR0000007	M 0 OHM 1/4W	1	
	R2915	ERJ2GEJ221	M 220 OHM, J, 0.063W	1	
	R2916	ERJ3GEYOR00	M 0 OHM, 1/16W	1	
	R2930	ERJ2GEJ153	M 15KOHM, J, 0.063W	1	
	R2941	DOYAR0000007	M 0 OHM 1/4W	1	
	R2942	DOYAR0000007	M 0 OHM 1/4W	1	
	R2960	ERJ2GEJ103	M 10KOHM, J, 0.063W	1	
	R3000	ERJ2GEJ223	M 22KOHM, J, 0.063W	1	
	R3001	ERJ2GEJ223	M 22KOHM, J, 0.063W	1	
	R3002	ERJ2GEJ223	M 22KOHM, J, 0.063W	1	
	R3003	ERJ2GEJ223	M 22KOHM, J, 0.063W	1	
	R3004	ERJ2GEJ223	M 22KOHM, J, 0.063W	1	
	R3005	ERJ2GEJ223	M 22KOHM, J, 0.063W	1	
	R3006	ERJ2GEJ104	M 100KOHM, J, 0.063W	1	
	R3007	ERJ2GEJ104	M 100KOHM, J, 0.063W	1	
	R3008	ERJ2GEJ222	M 2.2KOHM, J, 0.063W	1	
	R3009	ERJ2GEJ222	M 2.2KOHM, J, 0.063W	1	
	R3010	ERJ2GEJ104	M 100KOHM, J, 0.063W	1	
	R3011	ERJ2GEJ104	M 100KOHM, J, 0.063W	1	
	R3012	ERJ2GEJ222	M 2.2KOHM, J, 0.063W	1	
	R3013	ERJ2GEJ222	M 2.2KOHM, J, 0.063W	1	

Safety	Ref. No.	Part No.	Part Name & Description	Pcs	Remarks
	R3014	ERJ2GEJ103	M 10KOHM, J, 0.063W	1	
	R3019	ERJ2GEJ222	M 2.2KOHM, J, 0.063W	1	
	R3021	ERJ2GEJ222	M 2.2KOHM, J, 0.063W	1	
	R3024	ERJ2GEJ104	M 100KOHM, J, 0.063W	1	
	R3025	ERJ2GEJ104	M 100KOHM, J, 0.063W	1	
	R3028	ERJ2GEJ331	M 330 OHM, J, 0.063W	1	
	R3029	ERJ2GEJ331	M 330 OHM, J, 0.063W	1	
	R3033	ERJ2GEJ221	M 220 OHM, J, 0.063W	1	
	R3034	ERJ2GEJ221	M 220 OHM, J, 0.063W	1	
	R3037	ERJ2GEJ221	M 220 OHM, J, 0.063W	1	
	R3038	ERJ2GEJ221	M 220 OHM, J, 0.063W	1	
	R3041	ERJ2GEJ331	M 330 OHM, J, 0.063W	1	
	R3042	ERJ2GEJ331	M 330 OHM, J, 0.063W	1	
	R3043	ERJ2GEJ221	M 220 OHM, J, 0.063W	1	
	R3045	ERJ2GEJ221	M 220 OHM, J, 0.063W	1	
	R3047	ERJ2GEJ221	M 220 OHM, J, 0.063W	1	
	R3048	ERJ2GEJ221	M 220 OHM, J, 0.063W	1	
	R3049	ERJ2GEJ221	M 220 OHM, J, 0.063W	1	
	R3050	ERJ2GEJ221	M 220 OHM, J, 0.063W	1	
	R3051	ERJ2GEJ221	M 220 OHM, J, 0.063W	1	
	R3052	ERJ2GEJ221	M 220 OHM, J, 0.063W	1	
	R3072	D1BD1500A044	M 150 OHM, 1/10W	1	
	R3073	D1BD1500A044	M 150 OHM, 1/10W	1	
	R3074	D1BD1500A044	M 150 OHM, 1/10W	1	
	R3075	D1BD1500A044	M 150 OHM, 1/10W	1	
	R3076	D1BD1500A044	M 150 OHM, 1/10W	1	
	R3077	D1BD1500A044	M 150 OHM, 1/10W	1	
	R3079	D1BD1500A044	M 150 OHM, 1/10W	1	
	R3081	D1BD1500A044	M 150 OHM, 1/10W	1	
	R3082	D1BD1500A044	M 150 OHM, 1/10W	1	
	R3083	D1BD1500A044	M 150 OHM, 1/10W	1	
	R3084	ERJ6RED750	M 75 OHM, 1/10W	1	
	R3085	ERJ6RED750	M 75 OHM, 1/10W	1	
	R3086	ERJ6RED750	M 75 OHM, 1/10W	1	
	R3087	D1BD1500A044	M 150 OHM, 1/10W	1	
	R3089	ERJ2GEJ680	M 68 OHM, J, 0.063W	1	
	R3091	ERJ2RKF2152	M 21.5K OHM, J, 2W	1	PAVCCZ
	R3092	ERJ2RKF2152	M 21.5K OHM, J, 2W	1	PAVCCZ
	R3094	ERJ2RKF1302	M 13K OHM, J, 2W	1	
	R3097	D1BD1500A044	M 150 OHM, 1/10W	1	
	R3098	D1BD1500A044	M 150 OHM, 1/10W	1	
	R3100	ERJ2GEJ104	M 100KOHM, J, 0.063W	1	
	R3102	D1BD1500A044	M 150 OHM, 1/10W	1	
	R3104	D1BD1500A044	M 150 OHM, 1/10W	1	
	R3106	ERJ2GED273X	M 27KOHM, J, 0.063W	1	
	R3108	ERJ2GED273X	M 27KOHM, J, 0.063W	1	
	R3112	DOYAR0000007	M 0 OHM 1/4W	1	
	R3113	DOYAR0000007	M 0 OHM 1/4W	1	
	R3115	ERJ2GEJ221	M 220 OHM, J, 0.063W	1	
	R3116	ERJ2GEJ221	M 220 OHM, J, 0.063W	1	

Safety	Ref. No.	Part No.	Part Name & Description	Pcs	Remarks
	R3117	ERJ2GEJ221	M 220 OHM, J, 0.063W	1	
	R3118	ERJ2GEJ221	M 220 OHM, J, 0.063W	1	
	R3119	ERJ2GEJ221	M 220 OHM, J, 0.063W	1	
	R3120	ERJ2GEJ331	M 330 OHM, J, 0.063W	1	
	R3121	ERJ6RED750	M 75 OHM, 1/10W	1	
	R3123	ERJ2GEJ221	M 220 OHM, J, 0.063W	1	
	R3128	ERJ2GEJ221	M 220 OHM, J, 0.063W	1	
	R3132	ERJ2GEJ820	M 82 OHM, J, 0.063W	1	
	R3133	ERJ2GEJ820	M 82 OHM, J, 0.063W	1	
	R3134	ERJ2GEJ820	M 82 OHM, J, 0.063W	1	
	R3135	ERJ2GEJ221	M 220 OHM, J, 0.063W	1	
	R3136	ERJ2GEJ221	M 220 OHM, J, 0.063W	1	
	R3137	ERJ2GEJ221	M 220 OHM, J, 0.063W	1	
	R3138	ERJ2GEJ221	M 220 OHM, J, 0.063W	1	
	R3139	ERJ2GEJ221	M 220 OHM, J, 0.063W	1	
	R3140	ERJ2GEJ221	M 220 OHM, J, 0.063W	1	
	R3143	ERJ2GEJ680	M 68 OHM, J, 0.063W	1	
	R3146	ERJ2GEJ331	M 330 OHM, J, 0.063W	1	
	R3150	ERJ2GEJ680	M 68 OHM, J, 0.063W	1	
	R3153	ERJ2GEJ680	M 68 OHM, J, 0.063W	1	
	R3167	ERJ6RED750	M 75 OHM, 1/10W	1	
	R3169	ERJ2GEJ104	M 100KOHM, J, 0.063W	1	
	R3172	ERJ6RED750	M 75 OHM, 1/10W	1	
	R3174	ERJ2GEJ104	M 100KOHM, J, 0.063W	1	
	R3182	ERJ2RKF1302	M 13K OHM, J, 2W	1	
	R3186	D1BD1500A044	M 150 OHM, 1/10W	1	
	R3187	D1BD1500A044	M 150 OHM, 1/10W	1	
	R3188	D1BD1500A044	M 150 OHM, 1/10W	1	
	R3189	ERJ2GEJ680	M 68 OHM, J, 0.063W	1	
	R3190	ERJ2GEJ680	M 68 OHM, J, 0.063W	1	
	R3191	ERJ2GEJ680	M 68 OHM, J, 0.063W	1	
	R3193	D1BD1500A044	M 150 OHM, 1/10W	1	
	R3198	D1BD1500A044	M 150 OHM, 1/10W	1	
	R3204	D1BD1500A044	M 150 OHM, 1/10W	1	
	R3205	D1BD1500A044	M 150 OHM, 1/10W	1	
	R3206	ERJ2GEJ220	M 22 OHM, J, 0.063W	1	
	R3207	ERJ2GEJ220	M 22 OHM, J, 0.063W	1	
	R3212	D1BD1500A044	M 150 OHM, 1/10W	1	
	R3213	D1BD1500A044	M 150 OHM, 1/10W	1	
	R3223	ERJ2GEJ680	M 68 OHM, J, 0.063W	1	
	R3225	ERJ2GEJ680	M 68 OHM, J, 0.063W	1	
	R3226	ERJ2GEJ472	M 4.7KOHM, J, 0.063W	1	
	R3227	ERJ2GEJ472	M 4.7KOHM, J, 0.063W	1	
	R3230	ERJ6RED750	M 75 OHM, 1/10W	1	
	R3232	ERJ6RED750	M 75 OHM, 1/10W	1	
	R3234	ERJ6RED750	M 75 OHM, 1/10W	1	
	R3236	ERJ2GEJ680	M 68 OHM, J, 0.063W	1	

Safety	Ref. No.	Part No.	Part Name & Description	Pcs	Remarks
	R3237	ERJ2GEJ680	M 68 OHM, J, 0.063W	1	
	R3240	ERJ2GEJ221	M 220 OHM, J, 0.063W	1	
	R3245	ERJ2GEJ221	M 220 OHM, J, 0.063W	1	
	R3256	D0GDR00Z0002	M 0 OHM, 1/10W	1	
	R3308	ERJ2GEJ223	M 22KOHM, J, 0.063W	1	
	R3309	ERJ2GEJ223	M 22KOHM, J, 0.063W	1	
	R3770	D1BD1432A044	M14.3KOHM, 1/10W	1	
	R3771	D1BD6651A044	M6.65KOHM, 1/10W	1	
	R3772	D1BD1741A044	M1.74KOHM, 1/10W	1	
	R3775	ERJ6ENF7151	M7.15KOHM, 1/10W	1	
	R4277	ERJ2GEJ103	M 10KOHM, J, 0.063W	1	
	R4284	ERJ2GEJ103	M 10KOHM, J, 0.063W	1	
	R4285	ERJ2GEJ103	M 10KOHM, J, 0.063W	1	
	R4286	ERJ2GEJ103	M 10KOHM, J, 0.063W	1	
	R4294	ERJ2GEJ103	M 10KOHM, J, 0.063W	1	
	R4300	ERJ2GEJ103	M 10KOHM, J, 0.063W	1	
	R4305	ERJ2GEJ473	M 47KOHM, J, 0.063W	1	
	R4306	ERJ2GEJ473	M 47KOHM, J, 0.063W	1	
	R4500	ERJ2GEJ103	M 10KOHM, J, 0.063W	1	
	R4501	ERJ2GEJ103	M 10KOHM, J, 0.063W	1	
	R4502	ERJ2RKD330	M 33 OHM, J, 2W	1	
	R4503	ERJ2RKD330	M 33 OHM, J, 2W	1	
	R4504	ERJ2GEJ102X	M 1K OHM J 1/4W	1	
	R4505	ERJ2GEJ102X	M 1K OHM J 1/4W	1	
	R4506	ERJ2GEJ473	M 47KOHM, J, 0.063W	1	
	R4507	ERJ2GEJ473	M 47KOHM, J, 0.063W	1	
	R4524	ERJ2GEJ103	M 10KOHM, J, 0.063W	1	
	R4525	ERJ2GEJ103	M 10KOHM, J, 0.063W	1	
	R4528	ERJ2GEJ103	M 10KOHM, J, 0.063W	1	
	R4529	ERJ2GEJ103	M 10KOHM, J, 0.063W	1	
	R4530	ERJ2GEJ103	M 10KOHM, J, 0.063W	1	
	R4531	ERJ2GEJ103	M 10KOHM, J, 0.063W	1	
	R4532	ERJ2GEJ473	M 47KOHM, J, 0.063W	1	
	R4533	ERJ2GEJ473	M 47KOHM, J, 0.063W	1	
	R4534	ERJ2GEJ473	M 47KOHM, J, 0.063W	1	
	R4538	ERJ2GEJ473	M 47KOHM, J, 0.063W	1	
	R4539	D0YAR0000007	M 0 OHM 1/4W	1	
	R4540	ERJ2GEJ473	M 47KOHM, J, 0.063W	1	
	R4541	D0YAR0000007	M 0 OHM 1/4W	1	
	R4542	D0YAR0000007	M 0 OHM 1/4W	1	
	R4543	D0YAR0000007	M 0 OHM 1/4W	1	
	R4552	ERJ2GEJ220	M 22 OHM, J, 0.063W	1	
	R4587	D1BB60400001	M 604 OHM, 1/10W	1	
	R4588	D1BB8060A055	M 806 OHM, 1/10W	1	
	R4589	D1BB8060A055	M 806 OHM, 1/10W	1	
	R4592	D1BB8060A055	M 806 OHM, 1/10W	1	
	R4593	D1BB2201A055	M 2.2KOHM, 1/10W	1	
	R4596	ERJ6GEYJ102V	M 1K OHM J 1/10W	1	
	R4597	ERJ6GEYJ102V	M 1K OHM J 1/10W	1	
	R4598	ERJ6GEYJ102V	M 1K OHM J 1/10W	1	

Safety	Ref. No.	Part No.	Part Name & Description	Pcs	Remarks
	R4601	ERJ6GEYJ102V	M 1K OHM J 1/10W	1	
	R4604	DOYAR0000007	M 0 OHM 1/4W	1	
	R4605	D1BB2201A055	M 2.2KOHM, 1/10W	1	
	R4607	DOYAR0000007	M 0 OHM 1/4W	1	
	R4608	ERJ6GEYJ102V	M 1K OHM J 1/10W	1	
	R4609	ERJ2GEJ122	M 1.2KOHM, J,0.063W	1	
	R4613	DOYAR0000007	M 0 OHM 1/4W	1	
	R4614	DOYAR0000007	M 0 OHM 1/4W	1	
	R4615	DOYAR0000007	M 0 OHM 1/4W	1	
	R4616	DOYAR0000007	M 0 OHM 1/4W	1	
	R4620	ERJ2GEJ473	M 47KOHM, J,0.063W	1	
	R4622	ERJ2GEJ102X	M 1K OHM J 1/4W	1	
	R4623	DOYAR0000007	M 0 OHM 1/4W	1	
	R4624	ERJ2GEJ103	M 10KOHM, J,0.063W	1	
	R4626	D1BB2200A055	M 220 OHM, 1/10W	1	
	R4627	D1BB2200A055	M 220 OHM, 1/10W	1	
	R4631	D1BB4990A055	M 499 OHM, 1/10W	1	
	R4634	D1BB2200A055	M 220 OHM, 1/10W	1	
	R4635	EXB28V680JX	RESISTOR ARRAY	1	
	R4636	ERJ2GEJ680	M 68 OHM, J,0.063W	1	
	R4637	ERJ2GEJ473	M 47KOHM, J,0.063W	1	
	R4638	ERJ2GEJ680	M 68 OHM, J,0.063W	1	
	R4639	EXB28V680JX	RESISTOR ARRAY	1	
	R4640	EXB28V680JX	RESISTOR ARRAY	1	
	R4641	ERJ2GEJ473	M 47KOHM, J,0.063W	1	
	R4642	ERJ2GEJ473	M 47KOHM, J,0.063W	1	
	R4645	ERJ2GEJ680	M 68 OHM, J,0.063W	1	
	R4646	ERJ2GEJ680	M 68 OHM, J,0.063W	1	
	R4648	EXB28V680JX	RESISTOR ARRAY	1	
	R4649	EXB28V680JX	RESISTOR ARRAY	1	
	R4650	ERJ2GEJ680	M 68 OHM, J,0.063W	1	
	R4651	ERJ2GEJ680	M 68 OHM, J,0.063W	1	
	R4652	ERJ2GEJ473	M 47KOHM, J,0.063W	1	
	R4656	ERJ2GEJ222	M 2.2KOHM, J,0.063W	1	
	R4664	D1BB60400001	M 604 OHM, 1/10W	1	
	R4665	ERJ2GEJ473	M 47KOHM, J,0.063W	1	
	R4666	ERJ2GEJ473	M 47KOHM, J,0.063W	1	
	R4672	ERJ2GEJ473	M 47KOHM, J,0.063W	1	
	R4674	ERJ2GEJ103	M 10KOHM, J,0.063W	1	
	R4677	ERJ2GEJ103	M 10KOHM, J,0.063W	1	
	R4678	EXB28V680JX	RESISTOR ARRAY	1	
	R4679	EXB28V680JX	RESISTOR ARRAY	1	
	R4698	ERJ2GEJ104	M 100KOHM, J,0.063W	1	
	R4699	ERJ2GEJ104	M 100KOHM, J,0.063W	1	
	R4700	ERJ2GEJ473	M 47KOHM, J,0.063W	1	
	R4707	ERJ2GEJ473	M 47KOHM, J,0.063W	1	
	R4728	ERJ2GEJ103	M 10KOHM, J,0.063W	1	
	R4729	ERJ2RKD330	M 33 OHM, J, 2W	1	
	R4732	ERJ2GEJ473	M 47KOHM, J,0.063W	1	
	R4733	ERJ2GEJ103	M 10KOHM, J,0.063W	1	
	R4734	ERJ2GEJ102X	M 1K OHM J 1/4W	1	

Safety	Ref. No.	Part No.	Part Name & Description	Pcs	Remarks
	R4735	ERJ2GEJ103	M 10KOHM, J,0.063W	1	
	R4736	ERJ2GEJ473	M 47KOHM, J,0.063W	1	
	R4738	ERJ2GEJ473	M 47KOHM, J,0.063W	1	
	R4739	ERJ2GEJ103	M 10KOHM, J,0.063W	1	
	R4740	ERJ2GEJ473	M 47KOHM, J,0.063W	1	
	R4742	DOYAR0000007	M 0 OHM 1/4W	1	
	R4743	DOYAR0000007	M 0 OHM 1/4W	1	
	R4799	EXB28V680JX	RESISTOR ARRAY	1	
	R5470	ERJ2GEJ222	M 2.2KOHM, J,0.063W	1	
	R5471	ERJ2GEJ101	M 100 OHM, J,0.063W	1	
	R5472	ERJ2GEJ470	M 47 OHM, J,0.063W	1	
	R5473	ERJ2GEJ473	M 47KOHM, J,0.063W	1	
	R5474	ERJ2GEJ103	M 10KOHM, J,0.063W	1	
	R5475	ERJ2GEJ123	M 12KOHM, J,0.063W	1	
	R5482	ERJ6GEYJ150V	M 15 OHM, J,1/10W	1	
	R5484	D1BB3902A055	M 39KOHM, 1/10W	1	
	R5485	ERJ2GEJ101	M 100 OHM, J,0.063W	1	
	R5486	ERJ2GEJ103	M 10KOHM, J,0.063W	1	
	R5488	DOYAR0000007	M 0 OHM 1/4W	1	
	R5489	ERJ2RKD330	M 33 OHM, J, 2W	1	
	R5490	ERJ2GEJ473	M 47KOHM, J,0.063W	1	
	R5491	ERJ2GEJ473	M 47KOHM, J,0.063W	1	
	R5492	ERJ2GEJ105	M 1MOHM, J,0.063W	1	
	R5493	ERJ2GEJ203X	M 20KOHM, J,0.063W	1	
	R5494	ERJ2GEJ103	M 10KOHM, J,0.063W	1	
	R5496	ERJ2GEJ680	M 68 OHM, J,0.063W	1	
	R5541	D1BB1003A055	M 100KOHM, 1/10W	1	
	R5542	D1BB3401A055	M 3.4KOHM, 1/10W	1	
	R5543	ERJ6GEYJ153V	M 15KOHM, J,1/10W	1	
	R5581	ERJ2GEJ473	M 47KOHM, J,0.063W	1	
	R5582	ERJ2GEJ473	M 47KOHM, J,0.063W	1	
	R5600	D1BB3901A055	M 3.9KOHM, 1/10W	1	
	R5604	D1BB2402A055	M 24KOHM, 1/10W	1	
	R5605	D1BB3901A055	M 3.9KOHM, 1/10W	1	
	R5610	D1BB2201A055	M 2.2KOHM, 1/10W	1	
	R5611	D1BB1202A055	M 12KOHM, 1/10W	1	
	R5612	D1BB2002A055	M 20KOHM, 1/10W	1	
	R5613	ERJ2GEJ5R6X	M 5.6 OHM, J,0.063W	1	
	R5622	ERJ2GEJ5R6X	M 5.6 OHM, J,0.063W	1	
	R5629	D1BB2101A055	M 2.1KOHM, 1/10W	1	
	R5630	D1BB3301A055	M 3.3KOHM, 1/16W	1	
	R5631	D1BB3901A055	M 3.9KOHM, 1/10W	1	
	R5632	D1BB4021A055	M 4.2KOHM, 1/16W	1	
	R5633	D1BB1202A055	M 12KOHM, 1/10W	1	
	R5634	D1BB1602A055	M 16KOHM, 1/10W	1	
	R5635	ERJ2GEJ223	M 22KOHM, J,0.063W	1	
	R5636	ERJ2GEJ683	M 68KOHM, J,0.063W	1	
	R5646	ERJ2GEJ103	M 10KOHM, J,0.063W	1	
	R5647	ERJ2GEJ473	M 47KOHM, J,0.063W	1	
	R5657	ERJ2GEJ222	M 2.2KOHM, J,0.063W	1	

Safety	Ref. No.	Part No.	Part Name & Description	Pcs	Remarks
	R5658	ERJ2GEJ473	M 47KOHM, J,0.063W	1	
	R5659	ERJ2GEJ103	M 10KOHM, J,0.063W	1	
	R5668	ERJ2GEJ222	M 2.2KOHM, J,0.063W	1	
	R5669	ERJ2GEJ332	M 3.3KOHM, J,0.063W	1	
	R5670	ERJ2GEJ102X	M 1K OHM J 1/4W	1	
	R5671	ERJ2GEJ103	M 10KOHM, J,0.063W	1	
	R5672	ERJ6GEYJ221V	M 220 OHM,J,1/10W	1	
	R5674	ERJ6GEYJ471	M 470 OHM,J,1/10W	1	
	R5676	ERJ2GEJ221	M 220 OHM, J,0.063W	1	
	R5678	ERJ2GEJ471	M 470 OHM, J,0.063W	1	
	R8004	D1BB2402A055	M 24KOHM, 1/10W	1	
	R8005	D1BB1002A055	M 10KOHM, 1/10W	1	
	R8006	D1BB2402A055	M 24KOHM, 1/10W	1	
	R8007	D0GBR00Z0002	M 0 OHM J 1/16W	1	
	R8026	D0YAR0000007	M 0 OHM 1/4W	1	
	R8027	D0YAR0000007	M 0 OHM 1/4W	1	
	R8030	ERJ2GEJ101	M 100 OHM, J,0.063W	1	
	R8031	ERJ2RKF1001	M 1KOHM, 0.063W	1	
	R8032	ERJ2RKF1001	M 1KOHM, 0.063W	1	
	R8056	ERJ2GEJ470	M 47 OHM, J,0.063W	1	
	R8057	ERJ2GEJ470	M 47 OHM, J,0.063W	1	
	R8058	ERJ2GEJ470	M 47 OHM, J,0.063W	1	
	R8059	ERJ2GEJ470	M 47 OHM, J,0.063W	1	
	R8060	ERJ2GEJ470	M 47 OHM, J,0.063W	1	
	R8061	ERJ2GEJ470	M 47 OHM, J,0.063W	1	
	R8062	ERJ2GEJ470	M 47 OHM, J,0.063W	1	
	R8063	ERJ2GEJ470	M 47 OHM, J,0.063W	1	
	R8064	ERJ2GEJ470	M 47 OHM, J,0.063W	1	
	R8065	ERJ2GEJ470	M 47 OHM, J,0.063W	1	
	R8066	ERJ2GEJ470	M 47 OHM, J,0.063W	1	
	R8067	ERJ2GEJ470	M 47 OHM, J,0.063W	1	
	R8068	ERJ2GEJ470	M 47 OHM, J,0.063W	1	
	R8069	ERJ2GEJ470	M 47 OHM, J,0.063W	1	
	R8070	ERJ2GEJ470	M 47 OHM, J,0.063W	1	
	R8071	ERJ2GEJ470	M 47 OHM, J,0.063W	1	
	R8072	ERJ2GEJ470	M 47 OHM, J,0.063W	1	
	R8073	ERJ2GEJ470	M 47 OHM, J,0.063W	1	
	R8074	ERJ2GEJ221	M 220 OHM, J,0.063W	1	
	R8075	ERJ2GEJ470	M 47 OHM, J,0.063W	1	
	R8076	ERJ2GEJ470	M 47 OHM, J,0.063W	1	
	R8077	ERJ2GEJ470	M 47 OHM, J,0.063W	1	
	R8078	ERJ2GEJ470	M 47 OHM, J,0.063W	1	
	R8081	ERJ2GEJ103	M 10KOHM, J,0.063W	1	
	R8082	ERJ2RKF75R0	M 75 OHM, , 0.063W	1	

Safety	Ref. No.	Part No.	Part Name & Description	Pcs	Remarks
	R8083	ERJ2GEJ301	M 300 OHM, J,0.063W	1	
	R8086	ERJ2GEJ104	M 100KOHM, J,0.063W	1	
	R8088	ERJ2GEJ103	M 10KOHM, J,0.063W	1	
	R8090	ERJ2GEJ103	M 10KOHM, J,0.063W	1	
	R8091	ERJ2GEJ470	M 47 OHM, J,0.063W	1	
	R8093	ERJ2GEJ470	M 47 OHM, J,0.063W	1	
	R8095	ERJ2GEJ103	M 10KOHM, J,0.063W	1	
	R8096	ERJ2GEJ820	M 82 OHM, J,0.063W	1	
	R8097	ERJ2GEJ221	M 220 OHM, J,0.063W	1	
	R8100	ERJ2GEJ470	M 47 OHM, J,0.063W	1	
	R8101	ERJ2GEJ103	M 10KOHM, J,0.063W	1	
	R8109	ERJ2GEJ222	M 2.2KOHM, J,0.063W	1	
	R8244	ERJ2GEJ103	M 10KOHM, J,0.063W	1	
	R8245	ERJ2GEJ103	M 10KOHM, J,0.063W	1	
	R8260	ERJ2GEJ102X	M 1K OHM J 1/4W	1	
	R8272	ERJ2GEJ103	M 10KOHM, J,0.063W	1	
	R8301	EXB2HV680J	RESISTOR ARRAY	1	
	R8303	D0YAR0000007	M 0 OHM 1/4W	1	
	R8304	D0YAR0000007	M 0 OHM 1/4W	1	
	R8305	ERJ2GEJ102X	M 1K OHM J 1/4W	1	
	R8306	D0YAR0000007	M 0 OHM 1/4W	1	
	R8307	D0YAR0000007	M 0 OHM 1/4W	1	
	R8308	ERJ2GEJ680	M 68 OHM, J,0.063W	1	
	R8310	D0YAR0000007	M 0 OHM 1/4W	1	
	R8311	D0YAR0000007	M 0 OHM 1/4W	1	
	R8312	ERJ2GEJ102X	M 1K OHM J 1/4W	1	
	R8313	ERJ2GEJ225	M 1MOHM, J,0.063W	1	
	R8314	D0YAR0000007	M 0 OHM 1/4W	1	
	R8315	D0YAR0000007	M 0 OHM 1/4W	1	
	R8316	D0YAR0000007	M 0 OHM 1/4W	1	
	R8317	D0YAR0000007	M 0 OHM 1/4W	1	
	R8319	D0YAR0000007	M 0 OHM 1/4W	1	
	R8321	ERJ2GEJ103	M 10KOHM, J,0.063W	1	
	R8322	ERJ2GEJ222	M 2.2KOHM, J,0.063W	1	
	R8323	ERJ2GEJ222	M 2.2KOHM, J,0.063W	1	
	R8324	ERJ2GEJ222	M 2.2KOHM, J,0.063W	1	
	R8325	ERJ2GEJ680	M 68 OHM, J,0.063W	1	
	R8326	ERJ2GEJ680	M 68 OHM, J,0.063W	1	
	R8327	ERJ2GEJ680	M 68 OHM, J,0.063W	1	
	R8328	ERJ2GEJ103	M 10KOHM, J,0.063W	1	
	R8332	EXB2HV101J	RESISTOR ARRAY	1	
	R8333	EXB2HV101J	RESISTOR ARRAY	1	
	R8335	EXB2HV680J	RESISTOR ARRAY	1	
	R8336	EXB2HV680J	RESISTOR ARRAY	1	
	R8337	EXB28V680JX	RESISTOR ARRAY	1	
	R8338	ERJ2GEJ680	M 68 OHM, J,0.063W	1	
	R8339	ERJ2GEJ680	M 68 OHM, J,0.063W	1	
	R8340	D0YAR0000007	M 0 OHM 1/4W	1	
	R8345	ERJ2GEJ103	M 10KOHM, J,0.063W	1	
	R8347	D0YAR0000007	M 0 OHM 1/4W	1	

Safety	Ref. No.	Part No.	Part Name & Description	Pcs	Remarks
	R8353	ERJ2GEJ680	M 68 OHM, J, 0.063W	1	
	R8354	ERJ2GEJ680	M 68 OHM, J, 0.063W	1	
	R8356	DOYAR0000007	M 0 OHM 1/4W	1	
	R8392	DOYAR0000007	M 0 OHM 1/4W	1	
	R8395	ERJ2GEJ103	M 10KOHM, J, 0.063W	1	
	R8404	ERJ2GEJ103	M 10KOHM, J, 0.063W	1	
	R8405	ERJ2GEJ103	M 10KOHM, J, 0.063W	1	
	R8406	D0GFR10JA020	M 1 OHM, J, 0.33W	1	PAVCCZ
	R8407	ERJ2GEJ473	M 47KOHM, J, 0.063W	1	
	R8410	ERJ2GEJ223	M 22KOHM, J, 0.063W	1	
	R8411	ERJ2GEJ223	M 22KOHM, J, 0.063W	1	
	R8412	ERJ2GEJ103	M 10KOHM, J, 0.063W	1	
	R8415	ERJ2GEJ222	M 2.2KOHM, J, 0.063W	1	
	R8416	ERJ2GEJ223	M 22KOHM, J, 0.063W	1	
	R8417	ERJ2GEJ104	M 100KOHM, J, 0.063W	1	
	R8418	ERJ2GEJ681	M 680 OHM, J, 0.063W	1	
	R8421	ERJ2GEJ680	M 68 OHM, J, 0.063W	1	
	R8422	ERJ2GEJ680	M 68 OHM, J, 0.063W	1	
	R8423	ERJ2GEJ680	M 68 OHM, J, 0.063W	1	
	R8424	ERJ2GEJ680	M 68 OHM, J, 0.063W	1	
	R8425	ERJ2GEJ680	M 68 OHM, J, 0.063W	1	
	R8426	EXB2HV680J	RESISTOR ARRAY	1	
	R8428	EXB2HV680J	RESISTOR ARRAY	1	
	R8430	ERJ2GEJ101	M 100 OHM, J, 0.063W	1	
	R8431	ERJ2GEJ151	M 150 OHM, J, 0.063W	1	
	R8432	ERJ2GEJ151	M 150 OHM, J, 0.063W	1	
	R8433	ERJ2GEJ223	M 22KOHM, J, 0.063W	1	
	R8434	ERJ2GEJ473	M 47KOHM, J, 0.063W	1	
	R8435	ERJ2GEJ103	M 10KOHM, J, 0.063W	1	
	R8436	ERJ2GEJ103	M 10KOHM, J, 0.063W	1	
	R8437	EXB2HV104JV	RESISTOR ARRAY	1	
	R8438	ERJ2GEJ104	M 100KOHM, J, 0.063W	1	
	R8439	ERJ2GEJ680	M 68 OHM, J, 0.063W	1	
	R8440	ERJ2GEJ104	M 100KOHM, J, 0.063W	1	
	R8441	EXB2HV680J	RESISTOR ARRAY	1	
	R8442	ERJ2GEJ680	M 68 OHM, J, 0.063W	1	
	R8445	ERJ2GEJ104	M 100KOHM, J, 0.063W	1	
	R8446	ERJ2GEJ680	M 68 OHM, J, 0.063W	1	
	R8449	ERJ2GEJ680	M 68 OHM, J, 0.063W	1	
	R8450	ERJ2GEJ103	M 10KOHM, J, 0.063W	1	
	R8453	EXB2HV680J	RESISTOR ARRAY	1	
	R8454	EXB28V680JX	RESISTOR ARRAY	1	
	R8455	EXB2HV680J	RESISTOR ARRAY	1	
	R8456	ERJ2GEJ680	M 68 OHM, J, 0.063W	1	
	R8457	ERJ2GEJ680	M 68 OHM, J, 0.063W	1	

Safety	Ref. No.	Part No.	Part Name & Description	Pcs	Remarks
	R8458	ERJ2GEJ680	M 68 OHM, J, 0.063W	1	
	R8459	ERJ2GEJ680	M 68 OHM, J, 0.063W	1	
	R8460	ERJ2GEJ680	M 68 OHM, J, 0.063W	1	
	R8461	ERJ2GEJ680	M 68 OHM, J, 0.063W	1	
	R8463	EXB28V151J	RESISTOR ARRAY	1	
	R8464	ERJ2GEJ680	M 68 OHM, J, 0.063W	1	
	R8465	ERJ2GEJ103	M 10KOHM, J, 0.063W	1	
	R8466	ERJ2GEJ103	M 10KOHM, J, 0.063W	1	
	R8467	EXB28V680JX	RESISTOR ARRAY	1	
	R8468	ERJ2GEJ680	M 68 OHM, J, 0.063W	1	
	R8469	ERJ2GEJ680	M 68 OHM, J, 0.063W	1	
	R8470	EXB28V151J	RESISTOR ARRAY	1	
	R8471	ERJ2GEJ103	M 10KOHM, J, 0.063W	1	
	R8476	ERJ2GEJ103	M 10KOHM, J, 0.063W	1	
	R8477	ERJ2GEJ103	M 10KOHM, J, 0.063W	1	
	R8479	ERJ2GEJ103	M 10KOHM, J, 0.063W	1	
	R8487	EXB28V680JX	RESISTOR ARRAY	1	
	R8488	EXB28V680JX	RESISTOR ARRAY	1	
	R8489	ERJ2GEJ680	M 68 OHM, J, 0.063W	1	
	R8491	ERJ2GEJ223	M 22KOHM, J, 0.063W	1	
	R8494	ERJ2GEJ222	M 2.2KOHM, J, 0.063W	1	
	R8496	ERJ2GEJ222	M 2.2KOHM, J, 0.063W	1	
	R8501	ERJ2GEJ101	M 100 OHM, J, 0.063W	1	
	R8502	ERJ2GEJ331	M 330 OHM, J, 0.063W	1	
	R8503	ERJ2GEJ331	M 330 OHM, J, 0.063W	1	
	R8504	ERJ2GEJ331	M 330 OHM, J, 0.063W	1	
	R8506	ERJ2GEJ331	M 330 OHM, J, 0.063W	1	
	R8508	ERJ2GEJ680	M 68 OHM, J, 0.063W	1	
	R8510	D1BB1600A055	M 160 OHM, 1/10W	1	
	R8511	ERJ2GEJ472	M 4.7KOHM, J, 0.063W	1	
	R8512	ERJ2GEJ222	M 2.2KOHM, J, 0.063W	1	
	R8514	ERJ2GEJ680	M 68 OHM, J, 0.063W	1	
	R8515	ERJ2GEJ222	M 2.2KOHM, J, 0.063W	1	
	R8516	ERJ2GEJ222	M 2.2KOHM, J, 0.063W	1	
	R8517	ERJ2GEJ103	M 10KOHM, J, 0.063W	1	
	R8520	ERJ2GEJ103	M 10KOHM, J, 0.063W	1	
	R8530	ERJ3GEY0R00	M 0 OHM, 1/16W	1	
	R8531	ERJ3GEY0R00	M 0 OHM, 1/16W	1	
	R8558	ERJ2GEJ680	M 68 OHM, J, 0.063W	1	
	R8575	ERJ2GEJ680	M 68 OHM, J, 0.063W	1	
	R8576	ERJ2GEJ680	M 68 OHM, J, 0.063W	1	
	R8577	ERJ2GEJ680	M 68 OHM, J, 0.063W	1	
	R8578	ERJ2GEJ680	M 68 OHM, J, 0.063W	1	
	R8579	ERJ2GEJ680	M 68 OHM, J, 0.063W	1	

Safety	Ref. No.	Part No.	Part Name & Description	Pcs	Remarks
	R8580	ERJ2GEJ680	M 68 OHM, J,0.063W	1	
	R8581	ERJ2GEJ103	M 10KOHM, J,0.063W	1	
	R8582	ERJ2GEJ680	M 68 OHM, J,0.063W	1	
	R8585	ERJ2GEJ680	M 68 OHM, J,0.063W	1	
	R8598	ERJ2GEJ680	M 68 OHM, J,0.063W	1	
	R8599	ERJ2GEJ680	M 68 OHM, J,0.063W	1	
	R8600	ERJ2GEJ680	M 68 OHM, J,0.063W	1	
	R8601	ERJ2GEJ680	M 68 OHM, J,0.063W	1	
	R8608	ERJ2GEJ680	M 68 OHM, J,0.063W	1	
	R8609	ERJ2GEJ103	M 10KOHM, J,0.063W	1	
	R8610	ERJ2GEJ680	M 68 OHM, J,0.063W	1	
	R8611	ERJ2GEJ680	M 68 OHM, J,0.063W	1	
	R8612	ERJ2GEJ680	M 68 OHM, J,0.063W	1	
	R8613	ERJ2GEJ680	M 68 OHM, J,0.063W	1	
	R8614	ERJ2GEJ680	M 68 OHM, J,0.063W	1	
	R8615	ERJ2GEJ680	M 68 OHM, J,0.063W	1	
	R8616	ERJ2GEJ680	M 68 OHM, J,0.063W	1	
	R8617	ERJ2GEJ680	M 68 OHM, J,0.063W	1	
	R8618	ERJ2GEJ103	M 10KOHM, J,0.063W	1	
	R8619	ERJ2GEJ103	M 10KOHM, J,0.063W	1	
	R8620	ERJ2GEJ103	M 10KOHM, J,0.063W	1	
	R8628	ERJ2GEJ103	M 10KOHM, J,0.063W	1	
	R8629	ERJ2GEJ103	M 10KOHM, J,0.063W	1	
	R8630	ERJ2GEJ103	M 10KOHM, J,0.063W	1	
	R8637	ERJ2GEJ680	M 68 OHM, J,0.063W	1	
	R8638	ERJ2GEJ680	M 68 OHM, J,0.063W	1	
	R8639	ERJ2GEJ680	M 68 OHM, J,0.063W	1	
	R8640	ERJ2GEJ103	M 10KOHM, J,0.063W	1	
	R8641	ERJ2GEJ103	M 10KOHM, J,0.063W	1	
	R8642	ERJ2GEJ103	M 10KOHM, J,0.063W	1	
	R8644	D0YAR0000007	M 0 OHM 1/4W	1	
	R8645	ERJ2GEJ680	M 68 OHM, J,0.063W	1	
	R8646	ERJ2GEJ680	M 68 OHM, J,0.063W	1	
	R8647	ERJ2GEJ680	M 68 OHM, J,0.063W	1	
	R8651	ERJ2GEJ680	M 68 OHM, J,0.063W	1	
	R8654	ERJ2GEJ103	M 10KOHM, J,0.063W	1	
	R8658	ERJ2GEJ103	M 10KOHM, J,0.063W	1	
	R8660	D0YAR0000007	M 0 OHM 1/4W	1	
	R8661	ERJ2GEJ103	M 10KOHM, J,0.063W	1	
	R8663	ERJ2GEJ103	M 10KOHM, J,0.063W	1	
	R8665	ERJ2GEJ222	M 2.2KOHM, J,0.063W	1	

Safety	Ref. No.	Part No.	Part Name & Description	Pcs	Remarks
	R8666	ERJ2GEJ103	M 10KOHM, J,0.063W	1	
	R8667	ERJ2GEJ680	M 68 OHM, J,0.063W	1	
	R8670	ERJ2GEJ222	M 2.2KOHM, J,0.063W	1	
	R8671	ERJ2GEJ222	M 2.2KOHM, J,0.063W	1	
	R8672	EXB2HV680J	RESISTOR ARRAY	1	
	R8673	EXB2HV680J	RESISTOR ARRAY	1	
	R8674	EXB2HV103JV	RESISTOR ARRAY	1	
	R8675	ERJ2GEJ222	M 2.2KOHM, J,0.063W	1	
	R8677	ERJ2GEJ103	M 10KOHM, J,0.063W	1	
	R8678	ERJ2GEJ222	M 2.2KOHM, J,0.063W	1	
	R8679	ERJ2GEJ222	M 2.2KOHM, J,0.063W	1	
	R8680	ERJ2GEJ222	M 2.2KOHM, J,0.063W	1	
	R8681	ERJ2GEJ222	M 2.2KOHM, J,0.063W	1	
	R8683	ERJ2GEJ680	M 68 OHM, J,0.063W	1	
	R8688	EXB2HV680J	RESISTOR ARRAY	1	
	R8689	EXB2HV680J	RESISTOR ARRAY	1	
	R8690	EXB2HV680J	RESISTOR ARRAY	1	
	R8691	ERJ2GEJ103	M 10KOHM, J,0.063W	1	
	R8692	ERJ2GEJ680	M 68 OHM, J,0.063W	1	
	R8697	ERJ2GEJ222	M 2.2KOHM, J,0.063W	1	
	R8703	ERJ2GEJ680	M 68 OHM, J,0.063W	1	
	R8715	ERJ2GEJ103	M 10KOHM, J,0.063W	1	
	R8716	ERJ2GEJ103	M 10KOHM, J,0.063W	1	
	R8718	ERJ2GEJ103	M 10KOHM, J,0.063W	1	
	R8719	EXB28V103JX	RESISTOR ARRAY	1	
	R8722	EXB28V103JX	RESISTOR ARRAY	1	
	R8723	ERJ2GEJ103	M 10KOHM, J,0.063W	1	
	R8724	ERJ2GEJ680	M 68 OHM, J,0.063W	1	
	R8726	ERJ2GEJ680	M 68 OHM, J,0.063W	1	
	R8729	ERJ2GEJ121	M 120 OHM, J,0.063W	1	
	R8730	ERJ2GEJ121	M 120 OHM, J,0.063W	1	
	R8732	ERJ2GEJ121	M 120 OHM, J,0.063W	1	
	R8733	ERJ2GEJ121	M 120 OHM, J,0.063W	1	
	R8734	ERJ2GEJ121	M 120 OHM, J,0.063W	1	
	R8735	ERJ2GEJ121	M 120 OHM, J,0.063W	1	
	R8736	ERJ2GEJ121	M 120 OHM, J,0.063W	1	
	R8738	ERJ2GEJ121	M 120 OHM, J,0.063W	1	
	R8739	ERJ2GEJ121	M 120 OHM, J,0.063W	1	
	R8740	ERJ2GEJ121	M 120 OHM, J,0.063W	1	
	R8742	D1HG1218A002	NETWORK RESISTER	1	
	R8745	D1HG1218A002	NETWORK RESISTER	1	
	R8746	ERJ2GEJ103	M 10KOHM, J,0.063W	1	
	R8747	ERJ2GEJ103	M 10KOHM, J,0.063W	1	
	R8750	ERJ2GEJ103	M 10KOHM, J,0.063W	1	
	R8751	ERJ2GEJ103	M 10KOHM, J,0.063W	1	

Safety	Ref. No.	Part No.	Part Name & Description	Pcs	Remarks
	R8765	ERJ2GEJ103	M 10KOHM, J, 0.063W	1	
	R8767	ERJ2GEJ103	M 10KOHM, J, 0.063W	1	
	R8768	ERJ2GEJ103	M 10KOHM, J, 0.063W	1	
	R8802	DOYAR0000007	M 0 OHM 1/4W	1	
	R8803	ERJ2GEJ680	M 68 OHM, J, 0.063W	1	
	R8804	ERJ2GEJ680	M 68 OHM, J, 0.063W	1	
	R8805	ERJ2GEJ680	M 68 OHM, J, 0.063W	1	
	R8806	ERJ2GEJ680	M 68 OHM, J, 0.063W	1	
	R8807	ERJ2GEJ680	M 68 OHM, J, 0.063W	1	
	R8808	ERJ2GEJ680	M 68 OHM, J, 0.063W	1	
	R8855	ERJ2GEJ103	M 10KOHM, J, 0.063W	1	
	R8856	ERJ2GEJ680	M 68 OHM, J, 0.063W	1	
	R8857	ERJ2GEJ680	M 68 OHM, J, 0.063W	1	
	R8858	ERJ2GEJ680	M 68 OHM, J, 0.063W	1	
	R8859	ERJ2GEJ680	M 68 OHM, J, 0.063W	1	
	R8860	ERJ2GEJ680	M 68 OHM, J, 0.063W	1	
	R8862	ERJ2GEJ680	M 68 OHM, J, 0.063W	1	
	R8864	ERJ2GEJ680	M 68 OHM, J, 0.063W	1	
	R8898	ERJ2GEJ103	M 10KOHM, J, 0.063W	1	
	R8899	ERJ2GEJ680	M 68 OHM, J, 0.063W	1	
	R8954	ERJ2GEJ680	M 68 OHM, J, 0.063W	1	
	R8959	ERJ2GEJ680	M 68 OHM, J, 0.063W	1	
	R8960	ERJ2GEJ680	M 68 OHM, J, 0.063W	1	
	R8963	ERJ2GEJ103	M 10KOHM, J, 0.063W	1	
	R9070	ERJ2GEJ103	M 10KOHM, J, 0.063W	1	
	R9071	ERJ2GEJ223	M 22KOHM, J, 0.063W	1	
	R9072	ERJ2GEJ102X	M 1K OHM J 1/4W	1	
	R9073	ERJ2GEJ472	M 4.7KOHM, J, 0.063W	1	
	R9077	D1BB1302A055	M 13KOHM, 1/10W	1	
	R9078	D1BB4302A055	M 43KOHM, 1/10W	1	
	R9079	D1BB2702A055	M 27KOHM, 1/10W	1	
	R9080	D1BB1502A055	M 15KOHM, 1/10W	1	
	R9081	D1BB4702A055	M 47KOHM, 1/10W	1	
	R9083	DOYAR0000007	M 0 OHM 1/4W	1	
	R9084	DOYAR0000007	M 0 OHM 1/4W	1	
	R9085	ERJ2GEJ470	M 47 OHM, J, 0.063W	1	
	R9086	ERJ2GEJ470	M 47 OHM, J, 0.063W	1	
	R9087	ERJ2GEJ101	M 100 OHM, J, 0.063W	1	
	R9088	D1BB1802A055	M 18KOHM, 1/10W	1	
	R9089	D1BB1502A055	M 15KOHM, 1/10W	1	
	R9091	D1BB2702A055	M 27KOHM, 1/10W	1	
	R9092	D1BB1202A055	M 12KOHM, 1/10W	1	
	R9095	ERJ2GEJ103	M 10KOHM, J, 0.063W	1	
	R9096	ERJ2GEJ472	M 4.7KOHM, J, 0.063W	1	
	R9097	ERJ2GEJ472	M 4.7KOHM, J, 0.063W	1	
	R9098	ERJ2GEJ472	M 4.7KOHM, J, 0.063W	1	

Safety	Ref. No.	Part No.	Part Name & Description	Pcs	Remarks
	R9099	ERJ2GEJ101	M 100 OHM, J, 0.063W	1	
	R9100	ERJ2GEJ473	M 47KOHM, J, 0.063W	1	
	R9101	ERJ2GEJ333	M 33KOHM, J, 0.063W	1	
	R9102	ERJ2GEJ101	M 100 OHM, J, 0.063W	1	
	R9103	ERJ2GEJ473	M 47KOHM, J, 0.063W	1	
	R9104	ERJ2GEJ472	M 4.7KOHM, J, 0.063W	1	
	R9105	ERJ2GEJ103	M 10KOHM, J, 0.063W	1	
	R9106	ERJ2GEJ104	M 100KOHM, J, 0.063W	1	
	R9107	ERJ2GEJ332	M 3.3KOHM, J, 0.063W	1	
	R9108	ERJ2GEJ103	M 10KOHM, J, 0.063W	1	
	R9109	ERJ2GEJ103	M 10KOHM, J, 0.063W	1	
	R9110	ERJ2GEJ101	M 100 OHM, J, 0.063W	1	
	R9113	ERJ2GEJ104	M 100KOHM, J, 0.063W	1	
	R9115	ERJ2GEJ101	M 100 OHM, J, 0.063W	1	
	R9116	ERJ2GEJ101	M 100 OHM, J, 0.063W	1	
	R9119	EXB38V470J	RESISTOR ARRAY	1	
	R9120	ERJ2GEJ101	M 100 OHM, J, 0.063W	1	
	R9121	ERJ2GEJ104	M 100KOHM, J, 0.063W	1	
	R9124	ERJ2GEJ470	M 47 OHM, J, 0.063W	1	
	R9129	ERJ2GEJ683	M 68KOHM, J, 0.063W	1	
	R9130	ERJ2GEJ470	M 47 OHM, J, 0.063W	1	
	R9142	ERJ2GEJ101	M 100 OHM, J, 0.063W	1	
	R9145	ERJ2GEJ101	M 100 OHM, J, 0.063W	1	
	R9149	ERJ2GEJ472	M 4.7KOHM, J, 0.063W	1	
	R9152	ERJ2GEJ103	M 10KOHM, J, 0.063W	1	
	R9153	ERJ2GEJ103	M 10KOHM, J, 0.063W	1	
	R9154	ERJ2RHD272	M 2.7KOHM, J, 2W	1	
	R9155	ERJ2RHD272	M 2.7KOHM, J, 2W	1	
	R9164	ERJ2GEJ103	M 10KOHM, J, 0.063W	1	
	R9166	ERJ2GEJ103	M 10KOHM, J, 0.063W	1	
	R9187	ERJ2RHD272	M 2.7KOHM, J, 2W	1	
	R9188	ERJ2RHD272	M 2.7KOHM, J, 2W	1	
	R9189	ERJ2GEJ103	M 10KOHM, J, 0.063W	1	
	R9202	ERJ2GEJ101	M 100 OHM, J, 0.063W	1	
	R9203	ERJ2GEJ223	M 22KOHM, J, 0.063W	1	
	R9205	ERJ2GEJ333	M 33KOHM, J, 0.063W	1	
	R9206	ERJ2GED563X	M 56KOHM, J, 0.063W	1	
	R9207	ERJ2GEJ243	M 24KOHM, J, 0.063W	1	
	R9210	DOGDR00Z0002	M 0 OHM, 1/10W	1	
	R9212	ERJ2GEJ470	M 47 OHM, J, 0.063W	1	
	R9213	ERJ2GEJ470	M 47 OHM, J, 0.063W	1	
	R9215	ERJ2GEJ104	M 100KOHM, J, 0.063W	1	
	R9217	DOYAR0000007	M 0 OHM 1/4W	1	
	R9221	DOGDR00Z0002	M 0 OHM, 1/10W	1	

Safety	Ref. No.	Part No.	Part Name & Description	Pcs	Remarks
	R9223	ERJ2RHD272	M 2.7KOHM, J, 2W	1	
	R9225	ERJ2RHD272	M 2.7KOHM, J, 2W	1	
	R9226	D0YAR0000007	M 0 OHM 1/4W	1	
	R9227	D0YAR0000007	M 0 OHM 1/4W	1	
	R9228	ERJ2GEJ470	M 47 OHM, J, 0.063W	1	
	R9229	ERJ2GEJ470	M 47 OHM, J, 0.063W	1	
	R9234	ERJ2GEJ101	M 100 OHM, J, 0.063W	1	
	R9235	ERJ2GEJ101	M 100 OHM, J, 0.063W	1	
	R9236	ERJ2GEJ101	M 100 OHM, J, 0.063W	1	
	R9237	ERJ2GEJ101	M 100 OHM, J, 0.063W	1	
	R9238	ERJ2GEJ101	M 100 OHM, J, 0.063W	1	
	R9239	ERJ2GEJ101	M 100 OHM, J, 0.063W	1	
	R9240	ERJ2GEJ101	M 100 OHM, J, 0.063W	1	
	R9241	ERJ2GEJ101	M 100 OHM, J, 0.063W	1	
	R9242	ERJ2GEJ101	M 100 OHM, J, 0.063W	1	
	R9243	ERJ2GEJ101	M 100 OHM, J, 0.063W	1	
	R9245	ERJ2GEJ101	M 100 OHM, J, 0.063W	1	
	R9246	ERJ2GEJ101	M 100 OHM, J, 0.063W	1	
	R9249	ERJ2RHD272	M 2.7KOHM, J, 2W	1	
	R9250	ERJ2RHD272	M 2.7KOHM, J, 2W	1	
	R9369	ERJ2GEJ472	M 4.7KOHM, J, 0.063W	1	
	R9370	ERJ2GEJ103	M 10KOHM, J, 0.063W	1	
	R9371	ERJ2GEJ104	M 100KOHM, J, 0.063W	1	
	R9385	ERJ2GEJ472	M 4.7KOHM, J, 0.063W	1	
	R9391	ERJ2GEJ104	M 100KOHM, J, 0.063W	1	
	R9398	ERJ2GEJ301	M 300 OHM, J, 0.063W	1	
	R9399	ERJ2RKF75R0	M 75 OHM, , 0.063W	1	
	R9401	ERJ2GEJ221	M 220 OHM, J, 0.063W	1	
	R9402	ERJ2GEJ470	M 47 OHM, J, 0.063W	1	
	R9403	ERJ2GEJ103	M 10KOHM, J, 0.063W	1	
	R9404	ERJ2GEJ470	M 47 OHM, J, 0.063W	1	
	R9405	ERJ2GEJ470	M 47 OHM, J, 0.063W	1	
	R9406	ERJ2GEJ470	M 47 OHM, J, 0.063W	1	
	R9407	ERJ2GEJ470	M 47 OHM, J, 0.063W	1	
	R9408	ERJ2GEJ470	M 47 OHM, J, 0.063W	1	
	R9409	ERJ2GEJ470	M 47 OHM, J, 0.063W	1	
	R9410	ERJ2GEJ470	M 47 OHM, J, 0.063W	1	
	R9411	ERJ2GEJ470	M 47 OHM, J, 0.063W	1	
	R9412	ERJ2GEJ470	M 47 OHM, J, 0.063W	1	
	R9413	ERJ2GEJ470	M 47 OHM, J, 0.063W	1	
	R9414	ERJ2GEJ470	M 47 OHM, J, 0.063W	1	
	R9415	ERJ2GEJ470	M 47 OHM, J, 0.063W	1	
	R9416	ERJ2GEJ470	M 47 OHM, J, 0.063W	1	

Safety	Ref. No.	Part No.	Part Name & Description	Pcs	Remarks
	R9417	ERJ2GEJ470	M 47 OHM, J, 0.063W	1	
	R9418	ERJ2GEJ470	M 47 OHM, J, 0.063W	1	
	R9419	ERJ2GEJ470	M 47 OHM, J, 0.063W	1	
	R9420	ERJ2GEJ470	M 47 OHM, J, 0.063W	1	
	R9421	ERJ2GEJ470	M 47 OHM, J, 0.063W	1	
	R9422	ERJ2GEJ470	M 47 OHM, J, 0.063W	1	
	R9423	ERJ2GEJ470	M 47 OHM, J, 0.063W	1	
	R9424	ERJ2GEJ470	M 47 OHM, J, 0.063W	1	
	R9425	EXB2HV151J	RESISTOR ARRAY	1	
	R9426	EXB2HV151J	RESISTOR ARRAY	1	
	R9440	D0YAR0000007	M 0 OHM 1/4W	1	
	R9441	D0YAR0000007	M 0 OHM 1/4W	1	
	R9442	D0YAR0000007	M 0 OHM 1/4W	1	
	R9443	D0YAR0000007	M 0 OHM 1/4W	1	
	R9444	D0YAR0000007	M 0 OHM 1/4W	1	
	R9445	D0YAR0000007	M 0 OHM 1/4W	1	
	R9446	D0YAR0000007	M 0 OHM 1/4W	1	
	R9447	D0YAR0000007	M 0 OHM 1/4W	1	
	R9448	D0YAR0000007	M 0 OHM 1/4W	1	
	R9449	D0YAR0000007	M 0 OHM 1/4W	1	
	R9450	D0YAR0000007	M 0 OHM 1/4W	1	
	R9451	D0YAR0000007	M 0 OHM 1/4W	1	
	R9452	D0YAR0000007	M 0 OHM 1/4W	1	
	R9453	D0YAR0000007	M 0 OHM 1/4W	1	
	R9454	D0YAR0000007	M 0 OHM 1/4W	1	
	R9455	D0YAR0000007	M 0 OHM 1/4W	1	
	R9578	ERJ2GEJ472	M 4.7KOHM, J, 0.063W	1	
	R9586	ERJ2GEJ470	M 47 OHM, J, 0.063W	1	
	R9587	ERJ2GEJ470	M 47 OHM, J, 0.063W	1	
	R9592	D0GA103JA015	M 10KOHM, J, 1/16W	1	
	R9594	ERJ2GEJ103	M 10KOHM, J, 0.063W	1	
	R9598	ERJ2GEJ470	M 47 OHM, J, 0.063W	1	
	R9604	ERJ2GEJ103	M 10KOHM, J, 0.063W	1	
	R9608	EXB2HV470JV	RESISTOR ARRAY	1	
	R9609	EXB2HV470JV	RESISTOR ARRAY	1	
	R9610	EXB2HV470JV	RESISTOR ARRAY	1	
	R9611	ERJ2GEJ680	M 68 OHM, J, 0.063W	1	
	R9616	ERJ2GEJ470	M 47 OHM, J, 0.063W	1	
	R9618	ERJ2GEJ331	M 330 OHM, J, 0.063W	1	
	R9839	EXB38V101JV	RESISTOR ARRAY	1	
	R9848	EXB2HV470JV	RESISTOR ARRAY	1	
	R9849	EXB2HV470JV	RESISTOR ARRAY	1	
	R9868	ERJ2GEJ104	M 100KOHM, J, 0.063W	1	
	R9871	ERJ2GEJ103	M 10KOHM, J, 0.063W	1	
	R9872	D1BB1002A055	M 10KOHM, 1/10W	1	
	R9873	ERJ14YJ5R6U	M 6.2OHM, 1/4W	1	
	R9874	ERJ14YJ100H	M 10 OHM, J, 1/4W	1	
	R9893	D1BB2702A055	M 27KOHM, 1/10W	1	
	R9894	D1BB1802A055	M 18KOHM, 1/10W	1	
	R9897	ERJ2GEJ103	M 10KOHM, J, 0.063W	1	
	R9898	ERJ2GEJ103	M 10KOHM, J, 0.063W	1	
	R9899	ERJ2GEJ103	M 10KOHM, J, 0.063W	1	
	R9966	ERJ2GEJ391	M 390 OHM, J, 0.063W	1	
	R9967	ERJ2GEJ470	M 47 OHM, J, 0.063W	1	

Safety	Ref. No.	Part No.	Part Name & Description	Pcs	Remarks
	R9968	ERJ2GEJ470	M 47 OHM, J, 0.063W	1	
	R9969	ERJ2GEJ470	M 47 OHM, J, 0.063W	1	
	R9970	ERJ2GEJ470	M 47 OHM, J, 0.063W	1	
	R9975	ERJ2GEJ470	M 47 OHM, J, 0.063W	1	
	R9977	ERJ2GEJ470	M 47 OHM, J, 0.063W	1	
	R9983	ERJ2GEJ470	M 47 OHM, J, 0.063W	1	
	R9987	ERJ2GEJ470	M 47 OHM, J, 0.063W	1	
	R9988	ERJ2GEJ470	M 47 OHM, J, 0.063W	1	
	R9989	ERJ2GEJ470	M 47 OHM, J, 0.063W	1	
	R9990	DOYAR0000007	M 0 OHM 1/4W	1	
	R9996	ERJ2RKF1001	M 1KOHM, 0.063W	1	
	R9997	ERJ2RKF1001	M 1KOHM, 0.063W	1	
	R9998	ERJ2GEJ221	M 220 OHM, J, 0.063W	1	
	R9999	ERJ2GEJ103	M 10KOHM, J, 0.063W	1	
	RM2501	B3RAD0000160	REMOTE SENSOR	1	
	S1B	K1KA03BA0237	3P CONNECTOR	1	
△	SW2500	K0F162B00002	SWITCH	1	
	SW3759	EVQ11G05R	SWITCH	1	
	SW3760	EVQ11G05R	SWITCH	1	
	SW3761	EVQ11G05R	SWITCH	1	
	SW3762	EVQ11G05R	SWITCH	1	
	SW3763	EVQ11G05R	SWITCH	1	
△	TU2901	ENG37E18KF	TUNER	1	
	X1100	H0J100500035	CRYSTAL	1	
	X2010	H0J245500089	CRYSTAL	1	
	X8001	H0J270500120	CRYSTAL	1	
	X8301	H0J300500027	CRYSTAL	1	
	X9900	H0J200500076	CRYSTAL	1	
	C10	K1MN20BA0231	20P CONNECTOR	1	
	C11	K1MY68BA0345	68P CONNECTOR	1	
	C14	K1KA02A00787	2P CONNECTOR	1	
	C21	K1MY68BA0345	68P CONNECTOR	1	
	C23	K1KA08B00270	8P CONNECTOR	1	
	C25	K1KA04BA0107	4P CONNECTOR	1	
	C16002	F1L2J562A022	C 5600UF, K, 6.3V	1	
	C16012	F2A2E221A183	E 220UF, 250V	1	
	C16013	F2A2E221A183	E 220UF, 250V	1	
	C16018	FOC2E155A252	E 0.015UF, 250V	1	
	C16023	F1L2J562A022	C 5600UF, K, 6.3V	1	
	C16041	F1H1H392A970	C 3900PF, K, 50V	1	
	C16071	F1L2J1020001	C 1000UF, K, 6.3V	1	
	C16092	F1L2J1020001	C 1000UF, K, 6.3V	1	
	C16104	F1H1E470A130	C 47UF, K, 25V	1	
	C16105	F1H1E470A130	C 47UF, K, 25V	1	
	C16131	F1L1E4750004	C 4.7UF, 25V	1	
	C16133	F1L1E4750004	C 4.7UF, 25V	1	
	C16135	F1K1E105A029	C 1UF, Z, 25V	1	
	C16151	F1K1E105A029	C 1UF, Z, 25V	1	
	C16152	F1L1E4750004	C 4.7UF, 25V	1	
	C16153	F1L1E4750004	C 4.7UF, 25V	1	
	C16154	F1L1E4750004	C 4.7UF, 25V	1	
	C16191	F1L1E4750004	C 4.7UF, 25V	1	
	C16192	F1H1E104A129	C 0.1UF, 25V	1	
	C16193	EEUFC1E470	E 47UF, 25V	1	
	C16195	F1L1E4750004	C 4.7UF, 25V	1	
	C16201	FOC2E405A230	E 0.040UF, 250V	1	
	C16202	FOC2E405A230	E 0.040UF, 250V	1	
	C16203	FOC2E405A230	E 0.040UF, 250V	1	

Safety	Ref. No.	Part No.	Part Name & Description	Pcs	Remarks
	C16241	F2A1A101A106	E 100UF, 10V	1	
	C16242	F1H1C105A008	C 1UF, K, 16V	1	
	C16243	F1H1H103A970	C 0.001UF, K, 50V	1	
	C16251	F1H1C105A008	C 1UF, K, 16V	1	
	C16252	F1K1E105A029	C 1UF, Z, 25V	1	
	C16271	EEUFC1E221	E 220UF, 25V	1	
	C16280	F1K1E105A029	C 1UF, Z, 25V	1	
	C16285	F1H1H104A970	C 0.1UF, K, 50V	1	
	C16286	F1H1H104A970	C 0.1UF, K, 50V	1	
	C16287	F1H1H104A970	C 0.1UF, K, 50V	1	
	C16314	F2A2E221A183	E 220UF, 250V	1	
	C16315	F1H1A1050032	C 10UF, 50V	1	
	C16316	F1H1C104A143	C 0.1UF, K, 16V	1	
	C16317	F1H1A1050032	C 10UF, 50V	1	
	C16318	F1J1H104A835	C 0.10UF, 50V	1	
	C16319	F1J1H104A835	C 0.10UF, 50V	1	
	C16328	F2A2C221A195	E 2200UF, 160V	1	PAVCCZ
	C16331	FOC2E105A252	E 0.010UF, 250V	1	PAVCCZ
	C16401	F1L2J562A022	C 5600UF, K, 6.3V	1	
	C16413	FOC2E155A252	E 0.015UF, 250V	1	
	C16414	F2A2E221A183	E 220UF, 250V	1	
	C16415	F2A2E221A183	E 220UF, 250V	1	
	C16417	F2A2E221A183	E 220UF, 250V	1	
	C16421	F1L2J562A022	C 5600UF, K, 6.3V	1	
	C16441	F1H1H392A970	C 3900PF, K, 50V	1	
	C16460	F1E2J152A002	C 1500PF, 600V	1	
	C16471	F1L2J1020001	C 1000UF, K, 6.3V	1	
	C16472	F1K1E105A029	C 1UF, Z, 25V	1	
	C16490	F1H1C105A008	C 1UF, K, 16V	1	
	C16491	F1L2J1020001	C 1000UF, K, 6.3V	1	
	C16501	F1K1E105A029	C 1UF, Z, 25V	1	
	C16502	F1L1E4750004	C 4.7UF, 25V	1	
	C16503	F2A1E471A102	E 470UF, 25V	1	
	C16504	F1L1E4750004	C 4.7UF, 25V	1	
	C16505	F1K1E105A029	C 1UF, Z, 25V	1	
	C16521	F1K1E105A029	C 1UF, Z, 25V	1	
	C16522	F1L1E4750004	C 4.7UF, 25V	1	
	C16523	F2A1E471A102	E 470UF, 25V	1	
	C16524	F1L1E4750004	C 4.7UF, 25V	1	
	C16525	F1L1E4750004	C 4.7UF, 25V	1	
	C16533	F1H1H104A970	C 0.1UF, K, 50V	1	
	C16535	F1H1H104A970	C 0.1UF, K, 50V	1	
	C16536	F1H1H104A970	C 0.1UF, K, 50V	1	
	C16562	F1H1C105A008	C 1UF, K, 16V	1	
	C16563	F2A1A101A106	E 100UF, 10V	1	
	C16564	F1H1C105A008	C 1UF, K, 16V	1	
	C16565	F1H1H103A970	C 0.001UF, K, 50V	1	
	C16566	F1H1H103A970	C 0.001UF, K, 50V	1	
	C16581	F1K1E105A029	C 1UF, Z, 25V	1	
	C16582	F1H1C105A008	C 1UF, K, 16V	1	
	C16593	F1H1H102A971	C 1000PF, K, 50V	1	
	C16602	F1H1H220A971	C 22PF, K, 50V	1	
	C16603	F1K2J102A014	C 1000UF, K, 6.3V	1	
	C16604	F1K2J102A014	C 1000UF, K, 6.3V	1	
	C16608	F1H1H221A971	C 220UF, K, 50V	1	
	C16631	FOC2E405A230	E 0.040UF, 250V	1	
	C16632	FOC2E405A230	E 0.040UF, 250V	1	
	C16633	FOC2E405A230	E 0.040UF, 250V	1	
	C16641	F1K2J222A014	C 2200UF, K, 6.3V	1	
	C16645	F1K2J102A014	C 1000UF, K, 6.3V	1	
	C16646	F1K2J102A014	C 1000UF, K, 6.3V	1	
	C16661	F1K2J102A014	C 1000UF, K, 6.3V	1	
	C16662	F1K2J102A014	C 1000UF, K, 6.3V	1	
	C16664	F1H1H820A971	C 82UF, 50V	1	
	C16665	F1H1H820A971	C 82UF, 50V	1	
	C16666	F1H1H820A971	C 82UF, 50V	1	
	C16668	F1H1H221A971	C 220UF, K, 50V	1	
	C16675	F1H1H391A971	C 391UF, 50V	1	
	C16684	F1H1H104A970	C 0.1UF, K, 50V	1	
	C16685	F1H1H104A970	C 0.1UF, K, 50V	1	
	C16691	F2A2C101A169	E 1000UF, 160V	1	

Safety	Ref. No.	Part No.	Part Name & Description	Pcs	Remarks
	C16692	F1H1H104A970	C 0.1UF, K, 50V	1	
	C16707	F1H1H220A971	C 22PF, K, 50V	1	
	C16708	F1H1H104A970	C 0.1UF, K, 50V	1	
	C16721	F2A1H101A128	E 100UF, 50V	1	
	C16723	F1L1E4750004	C 4.7UF, 25V	1	
	C16724	F1L1E4750004	C 4.7UF, 25V	1	
	C16725	F1L1E4750004	C 4.7UF, 25V	1	
	C16753	F1L1E4750004	C 4.7UF, 25V	1	
	C16755	F1L1E4750004	C 4.7UF, 25V	1	
	C16756	F1L1E4750004	C 4.7UF, 25V	1	
	C16771	F1H1C105A008	C 1UF, K, 16V	1	
	C16772	F1L1E4750004	C 4.7UF, 25V	1	
	C16773	F1L1E4750004	C 4.7UF, 25V	1	
	C16791	EEUFCE221	E 220UF, 25V	1	
	C16795	F2A1E471A102	E 470UF, 25V	1	
	C16796	F2A1E471A102	E 470UF, 25V	1	
	C16797	F1H1H104A970	C 0.1UF, K, 50V	1	
	C16813	F2A2T221A009	E 220UF, 220V	1	
	C16814	F1H1H561A971	C 560UF, 50V	1	
	C16821	F1J1H104A835	C 0.10UF, 50V	1	
	C16822	F2A2G470A187	E 470UF, 400V	1	
	C16823	F1L2J562A022	C 5600UF, K, 6.3V	1	
	C16842	F2A2C101A169	E 1000UF, 160V	1	
	C16843	F1J1H104A835	C 0.10UF, 50V	1	
	C16844	F1J1H104A835	C 0.10UF, 50V	1	
	C16856	F1H1A1050032	C 10UF, 50V	1	
	C16857	F1H1H472A970	C 4700PF, K, 50V	1	
	C16858	F1H1C104A143	C 0.1UF, K, 16V	1	
	C16860	F1H1A1050032	C 10UF, 50V	1	
	C16861	F1H1C104A143	C 0.1UF, K, 16V	1	
	C16862	F1H1A1050032	C 10UF, 50V	1	
	C16863	F1J1H104A835	C 0.10UF, 50V	1	
	C16864	F1J1H104A835	C 0.10UF, 50V	1	
	C16866	F1H1A1050032	C 10UF, 50V	1	
	C16867	F1H1A1050032	C 10UF, 50V	1	
	C16868	F1H1A1050032	C 10UF, 50V	1	
	C16869	F1J1H104A835	C 0.10UF, 50V	1	
	C16891	F1K1E105A029	C 1UF, Z, 25V	1	
	C16903	F1E2J332A002	C 3300PF, 600V	1	
	C17101	F1L2E154A028	E 1500UF, 25V	1	
	C17102	F1L2E154A028	E 1500UF, 25V	1	
	C17103	F1H1C104A143	C 0.1UF, K, 16V	1	
	C17104	F1H1A1050032	C 10UF, 50V	1	
	C17105	F1L2E154A028	E 1500UF, 25V	1	
	C17106	F1L2E154A028	E 1500UF, 25V	1	
	C17107	F1H1A1050032	C 10UF, 50V	1	
	C17108	F1L2E154A028	E 1500UF, 25V	1	
	C17109	F1L2E154A028	E 1500UF, 25V	1	
	C17110	F1H1A1050032	C 10UF, 50V	1	
	C17111	F1L2E154A028	E 1500UF, 25V	1	
	C17112	F1L2E154A028	E 1500UF, 25V	1	
	C17113	F1H1A1050032	C 10UF, 50V	1	
	C17114	F1L2E154A028	E 1500UF, 25V	1	
	C17115	F1L2E154A028	E 1500UF, 25V	1	
	C17116	F1H1A1050032	C 10UF, 50V	1	
	C17117	F1L2E154A028	E 1500UF, 25V	1	
	C17118	F1L2E154A028	E 1500UF, 25V	1	
	C17119	F1H1A1050032	C 10UF, 50V	1	
	C17120	F1L2E154A028	E 1500UF, 25V	1	
	C17121	F1L2E154A028	E 1500UF, 25V	1	
	C17122	F1H1A1050032	C 10UF, 50V	1	
	C17123	F1L2E154A028	E 1500UF, 25V	1	
	C17124	F1L2E154A028	E 1500UF, 25V	1	
	C17125	F1H1A1050032	C 10UF, 50V	1	
	C17141	F1H1H101A971	C 100UF, 50V	1	
	C17202	F1H1C104A143	C 0.1UF, K, 16V	1	
	C17203	F1H1C104A143	C 0.1UF, K, 16V	1	
	C17204	F1L2E154A028	E 1500UF, 25V	1	
	C17205	F1L2E154A028	E 1500UF, 25V	1	
	C17206	F1H1A1050032	C 10UF, 50V	1	
	C17207	F1L2E154A028	E 1500UF, 25V	1	
	C17208	F1L2E154A028	E 1500UF, 25V	1	
	C17209	F1H1A1050032	C 10UF, 50V	1	

Safety	Ref. No.	Part No.	Part Name & Description	Pcs	Remarks
	C17210	F1L2E154A028	E 1500UF, 25V	1	
	C17211	F1L2E154A028	E 1500UF, 25V	1	
	C17212	F1H1A1050032	C 10UF, 50V	1	
	C17213	F1L2E154A028	E 1500UF, 25V	1	
	C17214	F1L2E154A028	E 1500UF, 25V	1	
	C17215	F1H1A1050032	C 10UF, 50V	1	
	C17216	F1L2E154A028	E 1500UF, 25V	1	
	C17217	F1L2E154A028	E 1500UF, 25V	1	
	C17218	F1H1A1050032	C 10UF, 50V	1	
	C17219	F1L2E154A028	E 1500UF, 25V	1	
	C17220	F1L2E154A028	E 1500UF, 25V	1	
	C17221	F1H1A1050032	C 10UF, 50V	1	
	C17222	F1L2E154A028	E 1500UF, 25V	1	
	C17223	F1L2E154A028	E 1500UF, 25V	1	
	C17224	F1H1A1050032	C 10UF, 50V	1	
	C17241	F1H1H101A971	C 100UF, 50V	1	
	CB1	K1MY55B00002	55P CONNECTOR	1	PAVCCZ
	CB2	K1MY55B00002	55P CONNECTOR	1	PAVCCZ
	CB3	K1MY55B00002	55P CONNECTOR	1	PAVCCZ
	CB4	K1MY55B00002	55P CONNECTOR	1	PAVCCZ
	CB5	K1MY55B00002	55P CONNECTOR	1	PAVCCZ
	CB6	K1MY55B00002	55P CONNECTOR	1	PAVCCZ
	CB7	K1MY55B00002	55P CONNECTOR	1	PAVCCZ
	CB8	K1MY55B00002	55P CONNECTOR	1	PAVCCZ
	CB9	K1MY55B00002	55P CONNECTOR	1	PAVCCZ
	CB10	K1MY55B00002	55P CONNECTOR	1	PAVCCZ
	CB11	K1MY55B00002	55P CONNECTOR	1	PAVCCZ
	CB12	K1MY55B00002	55P CONNECTOR	1	PAVCCZ
	CB13	K1MY55B00002	55P CONNECTOR	1	PAVCCZ
	CB14	K1MY55B00002	55P CONNECTOR	1	PAVCCZ
	CB15	K1MY55B00002	55P CONNECTOR	1	PAVCCZ
	D16002	B0FBCN000005	DIODE	1	
	D16021	B0FBCN000005	DIODE	1	
	D16022	B0FBCN000005	DIODE	1	
	D16032	MA2J11100L	DIODE	1	
	D16041	MA3DF46000LW	ZENER DIODE	1	
	D16050	BOECKP000047	DIODE	1	
	D16052	B0FBCN000008	DIODE	1	
	D16101	MA22D3900L	DIODE	1	
	D16131	BOECKP000047	DIODE	1	
	D16132	MAZ81500ML	ZENER DIODE	1	
	D16151	BOECKP000047	DIODE	1	
	D16152	BOECKP000047	DIODE	1	
	D16153	BOECKP000047	DIODE	1	
	D16191	BOECKP000047	DIODE	1	
	D16192	MA2J11100L	DIODE	1	
	D16193	BOECKP000047	DIODE	1	
	D16194	BOECKP000047	DIODE	1	
	D16195	BOECKP000047	DIODE	1	
	D16253	B3ABB0000210	LED	1	
	D16255	MA2J11100L	DIODE	1	
	D16280	MA2J11100L	DIODE	1	
	D16281	MAZ80510LL	ZENER DIODE	1	
	D16282	MAZ80680ML	ZENER DIODE	1	
	D16285	MA3X152D0L	DIODE	1	
	D16286	MA2J11100L	DIODE	1	
	D16315	MAZ81500ML	ZENER DIODE	1	
	D16316	BOECKP000047	DIODE	1	
	D16317	BOECKP000047	DIODE	1	
	D16401	B0FACR000007	DIODE	1	PAVCCZ
	D16402	B0FACR000007	DIODE	1	PAVCCZ
	D16407	MA22D3900L	DIODE	1	
	D16411	MA2J11100L	DIODE	1	
	D16421	MA3DF40000LW	ZENER DIODE	1	
	D16451	BOECKP000047	DIODE	1	
	D16461	MA3DF46001TV	ZENER DIODE	1	PAVCCZ
	D16462	MA3DF46001TV	ZENER DIODE	1	PAVCCZ
	D16466	MA2J11100L	DIODE	1	
	D16473	MA3X152D0L	DIODE	1	
	D16474	MA2J11100L	DIODE	1	
	D16475	MAZ80510LL	ZENER DIODE	1	

Safety	Ref. No.	Part No.	Part Name & Description	Pcs	Remarks
	D16476	MA2J11100L	DIODE	1	
	D16477	MA2J11100L	DIODE	1	
	D16478	BOHCKS000002	DIODE	1	
	D16480	MA2J11100L	DIODE	1	
	D16482	BOFACP000002	DIODE	1	PAVCCZ
	D16490	BOECKP000047	DIODE	1	
	D16491	MA2J11100L	DIODE	1	
	D16492	MAZ80470ML	ZENER DIODE	1	
	D16493	MA3X152E0L	ZENER DIODE	1	
	D16503	BOECHR000001	DIODE	1	
	D16522	BOECKP000047	DIODE	1	
	D16523	BOECHR000001	DIODE	1	
	D16524	BOECKP000047	DIODE	1	
	D16534	BOECHR000001	DIODE	1	
	D16536	BOECHR000001	DIODE	1	
	D16583	B3ABB0000210	LED	1	
	D16602	MAZ81500ML	ZENER DIODE	1	
	D16604	MA3X152E0L	ZENER DIODE	1	
	D16605	MAZ80510LL	ZENER DIODE	1	
	D16606	BOECKM000038	DIODE	1	
	D16607	MA2J11100L	DIODE	1	
	D16608	MA8120M	ZENER DIODE	1	
	D16610	MA2J11100L	DIODE	1	
	D16615	MA2J11100L	DIODE	1	
	D16616	MA3X152E0L	ZENER DIODE	1	
	D16618	BOECKP000047	DIODE	1	
	D16619	BOECKP000047	DIODE	1	
	D16621	BOFBCN000006	DIODE	1	
	D16622	BOFBCN000006	DIODE	1	
	D16624	BOECKP000047	DIODE	1	
	D16625	MAZ82000ML	ZENER DIODE	1	
	D16641	BOFBCN000007	DIODE	1	
	D16642	BOFBCN000007	DIODE	1	
	D16645	MAZ81500ML	ZENER DIODE	1	
	D16646	MAZ81500ML	ZENER DIODE	1	
	D16647	MAZ81500ML	ZENER DIODE	1	
	D16648	MAZ80510LL	ZENER DIODE	1	
	D16649	MA2J11100L	DIODE	1	
	D16650	MA2J11100L	DIODE	1	
	D16652	BOECKP000047	DIODE	1	
	D16653	MA2J11100L	DIODE	1	
	D16654	MA2J11100L	DIODE	1	
	D16662	MAZ81500ML	ZENER DIODE	1	
	D16663	MAZ81500ML	ZENER DIODE	1	
	D16664	MAZ81500ML	ZENER DIODE	1	
	D16669	MA2J11100L	DIODE	1	
	D16671	MA2J11100L	DIODE	1	
	D16673	BOECHR000001	DIODE	1	
	D16674	BOECHR000001	DIODE	1	
	D16677	MA3X152D0L	DIODE	1	
	D16678	MAZ815000L	ZENER DIODE	1	
	D16679	BOECKP000047	DIODE	1	
	D16702	MA2J11100L	DIODE	1	
	D16710	MAZ815000L	ZENER DIODE	1	
	D16711	BOECHR000001	DIODE	1	
	D16712	MAZ815000L	ZENER DIODE	1	
	D16713	BOECHR000001	DIODE	1	
	D16714	MAZ815000L	ZENER DIODE	1	
	D16715	BOECHR000001	DIODE	1	
	D16717	MAZ83300ML	ZENER DIODE	1	
	D16719	BOECKP000047	DIODE	1	
	D16720	BOECKP000047	DIODE	1	
	D16721	BOECHR000001	DIODE	1	
	D16725	MA2J11100L	DIODE	1	
	D16765	BOECHR000001	DIODE	1	
	D16791	MAZ82000ML	ZENER DIODE	1	
	D16792	MA2J11100L	DIODE	1	
	D16811	MA2J11100L	DIODE	1	
	D16820	MA3X152E0L	ZENER DIODE	1	
	D16821	MAZ83600ML	ZENER DIODE	1	
	D16824	MAZ83300ML	ZENER DIODE	1	
	D16825	MAZ83300ML	ZENER DIODE	1	
	D16859	BOHCKS000002	DIODE	1	

Safety	Ref. No.	Part No.	Part Name & Description	Pcs	Remarks
	D16860	BOHCKS000002	DIODE	1	
	D16865	BOECKP000047	DIODE	1	
	D16871	MAZ83300ML	ZENER DIODE	1	
	D16874	MAZ80510LL	ZENER DIODE	1	
	D16875	MA2J11100L	DIODE	1	
	D16901	MA3X152E0L	ZENER DIODE	1	
	D16902	MA2J11100L	DIODE	1	
	D16920	MA3X152E0L	ZENER DIODE	1	
	IC16131	COZBZ0000895	IC	1	
	IC16151	COZBZ0001324	IC	1	
	IC16241	COJBAZ002811	IC	1	
	IC16251	COBBBA000024	IC	1	
	IC16304	MIP3900MSSCF	IC	1	
	IC16312	CODBZMC00006	IC	1	
	IC16464	COJBAB000715	IC	1	
	IC16465	COJBAB000715	IC	1	
	IC16471	CODBEKA00003	IC	1	
	IC16490	CODBZMC00006	IC	1	
	IC16491	NJM2406F	LINEAR IC	1	
	IC16501	COZBZ0001324	IC	1	
	IC16521	COZBZ0001324	IC	1	
	IC16561	COJBAZ001120	IC	1	
	IC16562	COJBAZ001120	IC	1	
	IC16563	COJBAB000388	IC	1	
	IC16564	COJBAB000715	IC	1	
	IC16581	COBBBA000024	IC	1	
	IC16661	COBBBA000024	IC	1	
	IC16691	COJBAC000363	IC	1	
	IC16692	CODBZMC00006	IC	1	
	IC16724	COCBADC00072	IC	1	
	IC16725	COCBADC00072	IC	1	
	IC16771	COCBADC00072	IC	1	
	IC16773	COJBAB000715	IC	1	
	IC16784	MIP9L02MBS	IC	1	
	IC16786	MIP3900MSSCF	IC	1	
	IC16787	CODBZMC00006	IC	1	
	IC16788	MIP3900MSSCF	IC	1	
	IC16789	CODBZMC00006	IC	1	
	IC16791	EHMDD9920	LINEAR IC	1	
	IC16792	NJM2406F	LINEAR IC	1	
	IC16793	CODBZMC00006	IC	1	
	IC16801	CODBZMC00006	IC	1	
	IC16920	COBBBA000024	IC	1	
	IC17101	COJBAZ001120	IC	1	
	IC17201	COJBAZ001120	IC	1	
	IC17202	COJBAZ001120	IC	1	
	L16002	GOC1R1KA0206	PEAKING COIL	1	
	L16003	GOC1R1KA0206	PEAKING COIL	1	
	L16005	GOC1R1KA0206	PEAKING COIL	1	
	L16012	GOC1R1KA0206	PEAKING COIL	1	
	L16013	GOC1R1KA0206	PEAKING COIL	1	
	L16015	GOC1R1KA0206	PEAKING COIL	1	
	L16103	GOZZ00002183	PEAKING COIL	1	
	L16222	GOZZ00002183	PEAKING COIL	1	
	L16271	GOZZ00002183	PEAKING COIL	1	
	L16303	GOC471KA0167	PEAKING COIL	1	
	L16402	GOCR82KA0147	CHOKE COIL	1	
	L16403	GOCR82KA0147	CHOKE COIL	1	
	L16411	GOCR82KA0147	CHOKE COIL	1	
	L16412	GOCR82KA0147	CHOKE COIL	1	
	L16472	GOZZ00002183	PEAKING COIL	1	
	L16697	GOC102KA0187	PEAKING COIL	1	
	L16698	GOC681MA0065	PEAKING COIL	1	
	L16699	GOC471KA0167	PEAKING COIL	1	
	L16851	GOZZ00002183	PEAKING COIL	1	
	PC16191	B3PBA0000496	IC	1	
	PC16301	B3PBA0000498	IC	1	
	PC16461	B3PBA0000457	IC	1	
	PC16480	B3PBA0000498	IC	1	
	PC16601	B3PBA0000498	IC	1	

Safety	Ref. No.	Part No.	Part Name & Description	Pcs	Remarks
	PC16603	B3PBA0000498	IC	1	
	PC16684	B3PBA0000496	IC	1	
	PC16685	B3PBA0000496	IC	1	
	PC16722	B3PBA0000498	IC	1	
	PC16723	B3PBA0000498	IC	1	
	PC16896	B3PBA0000498	IC	1	
△	PCB	ETX2MM747MFE	CIRCUIT BOARD P	1	(RTL) PAVCCZ
△	PCB	TNPA4762	CIRCUIT BOARD C1	1	(RTL)
△	PCB	TNPA4763	CIRCUIT BOARD C2	1	(RTL)
△	PCB	TXNSC11XBH	CIRCUIT BOARD SC	1	(RTL) PAVCCZ
△	PCB	TNPA4785	CIRCUIT BOARD SD	1	
△	PCB	TXNSS11XBH	CIRCUIT BOARD SS	1	(RTL) PAVCCZ
△	PCB	TNPA4802	CIRCUIT BOARD SS2	1	(RTL)
△	PCB	TNPA4784	CIRCUIT BOARD SU	1	
	Q16001	2PG0060000RP	TRANSISTOR	1	
	Q16002	2PG0060000RP	TRANSISTOR	1	
	Q16022	B1JADP000004	TRANSISTOR	1	
	Q16023	B1JADP000004	TRANSISTOR	1	
	Q16041	B1JAEN000007	TRANSISTOR	1	PAVCCZ
	Q16051	B1JAEN000007	TRANSISTOR	1	PAVCCZ
	Q16055	B1HFPPFA00001	TRANSISTOR	1	
	Q16056	B1HFPPFA00001	TRANSISTOR	1	
	Q16101	2SK399500L	FET	1	
	Q16102	2SK399500L	FET	1	
	Q16141	B1HFPPFA00001	TRANSISTOR	1	
	Q16161	B1HFPPFA00001	TRANSISTOR	1	
	Q16191	B1HFPPFA00001	TRANSISTOR	1	
	Q16251	2SD0601ARL	TRANSISTOR	1	
	Q16280	2SD0601ARL	TRANSISTOR	1	
	Q16401	2PG0110000RP	TRANSISTOR	1	
	Q16402	2PG0110000RP	TRANSISTOR	1	
	Q16421	B1JADP000004	TRANSISTOR	1	
	Q16422	B1JADP000004	TRANSISTOR	1	
	Q16441	B1JAEP000006	TRANSISTOR	1	
	Q16451	B1JAEP000006	TRANSISTOR	1	
	Q16471	B1ABCF000231	TRANSISTOR	1	
	Q16490	B1CBGD000001	FET	1	
	Q16501	B1HFPPFA00001	TRANSISTOR	1	
	Q16521	B1HFPPFA00001	TRANSISTOR	1	
	Q16531	B1HFPPFA00001	TRANSISTOR	1	
	Q16551	B1HFPPFA00001	TRANSISTOR	1	
	Q16601	B1CERR000025	FET	1	
	Q16602	2SD0601AQL	TRANSISTOR	1	
	Q16603	2SB0709ASL	TRANSISTOR	1	
	Q16604	B1CHPM000001	FET	1	
	Q16606	2SD0601AQL	TRANSISTOR	1	
	Q16607	B1CBGD000001	FET	1	
	Q16608	B1CBGD000001	FET	1	
	Q16621	B1JADN000004	TRANSISTOR	1	
	Q16622	B1JADN000004	TRANSISTOR	1	
	Q16624	2SB0709ASL	TRANSISTOR	1	
	Q16645	2SD0601AQL	TRANSISTOR	1	
	Q16646	2SB0709ASL	TRANSISTOR	1	
	Q16647	B1CBGD000001	FET	1	
	Q16649	B1ABCN000007	TRANSISTOR	1	
	Q16660	B1CERR000025	FET	1	
	Q16661	B1JAER000003	TRANSISTOR	1	
	Q16662	2SD0601AQL	TRANSISTOR	1	
	Q16663	2SB0709ASL	TRANSISTOR	1	
	Q16667	2SB0709ARL	TRANSISTOR	1	
	Q16668	2SD0601AQL	TRANSISTOR	1	
	Q16670	B1ADCN000007	TRANSISTOR	1	
	Q16671	B1ABCF000231	TRANSISTOR	1	
	Q16675	B1ADCN000007	TRANSISTOR	1	
	Q16676	B1ABCF000231	TRANSISTOR	1	
	Q16677	2SD0601AQL	TRANSISTOR	1	
	Q16678	B1ABCF000231	TRANSISTOR	1	
	Q16701	B1ADCN000007	TRANSISTOR	1	

Safety	Ref. No.	Part No.	Part Name & Description	Pcs	Remarks
	Q16702	B1ABCF000231	TRANSISTOR	1	
	Q16743	2SD0601ARL	TRANSISTOR	1	
	Q16762	B1HFPPFA00001	TRANSISTOR	1	
	Q16801	B1ADCN000007	TRANSISTOR	1	
	Q16810	B1ABCF000231	TRANSISTOR	1	
	Q16815	B1ABCN000007	TRANSISTOR	1	
	Q16816	2SD0601AQL	TRANSISTOR	1	
	Q16817	B1CBGD000001	FET	1	
	Q16818	B1CBGD000001	FET	1	
	Q16874	B1CBGD000001	FET	1	
	Q16875	B1ABCF000231	TRANSISTOR	1	
	Q16876	B1ABCF000231	TRANSISTOR	1	
	Q16882	B1ABCF000231	TRANSISTOR	1	
	Q16884	2SD0601ARL	TRANSISTOR	1	
	Q16920	B1ABCN000007	TRANSISTOR	1	
	R16001	D0GF7R5JA047	M 7.5 OHM, J, 0.33W	1	
	R16002	D0GF7R5JA047	M 7.5 OHM, J, 0.33W	1	
	R16022	D0GF7R5JA047	M 7.5 OHM, J, 0.33W	1	
	R16023	D0GF7R5JA047	M 7.5 OHM, J, 0.33W	1	
	R16031	ERJ6ENF8202	M 82KOHM, 1/10W	1	
	R16032	ERJ6ENF8202	M 82KOHM, 1/10W	1	
	R16033	D1BD5602A044	M 56KOHM, 1/10W	1	
	R16034	D1BD2702A044	M 27KOHM, 1/10W	1	
	R16041	D0GF5R6JA047	M 5.6 OHM, J, 0.33W	1	
	R16051	D0GF5R6JA047	M 5.6 OHM, J, 0.33W	1	
	R16101	D0GD221JA059	M 220 OHM, J, 1/10W	1	
	R16102	D0GD221JA059	M 220 OHM, J, 1/10W	1	
	R16103	D0GD100JA059	M 10 OHM, J, 0.25W	1	
	R16104	D0GD100JA059	M 10 OHM, J, 0.25W	1	
	R16105	ERJ8GEYJ474	M 470KOHM, J, 1/8W	1	
	R16109	D0GD100JA059	M 10 OHM, J, 0.25W	1	
	R16110	ERJ6GEYF473	M 47KOHM, J, 1/10W	1	
	R16116	ERJ6GEYF473	M 47KOHM, J, 1/10W	1	
	R16131	D0GD101JA036	M 100 OHM, J, 0.25W	1	
	R16132	D0GD101JA036	M 100 OHM, J, 0.25W	1	
	R16133	D0GD750JA059	M 75 OHM, J, 0.25W	1	
	R16134	D0GD750JA059	M 75 OHM, J, 0.25W	1	
	R16137	D0GF1R0JA047	M 1.0 OHM, J, 0.33W	1	
	R16141	D0GD100JA059	M 10 OHM, J, 0.25W	1	
	R16142	ERJ6GEYF473	M 47KOHM, J, 1/10W	1	
	R16143	ERJ6GEYF473	M 47KOHM, J, 1/10W	1	
	R16151	D0GD101JA036	M 100 OHM, J, 0.25W	1	
	R16152	D0GD101JA036	M 100 OHM, J, 0.25W	1	
	R16154	D0GD750JA059	M 75 OHM, J, 0.25W	1	
	R16155	D0GF1R0JA047	M 1.0 OHM, J, 0.33W	1	
	R16159	D0GF1R0JA047	M 1.0 OHM, J, 0.33W	1	
	R16161	D0GD100JA059	M 10 OHM, J, 0.25W	1	
	R16162	ERJ6GEYF473	M 47KOHM, J, 1/10W	1	
	R16163	ERJ6GEYF473	M 47KOHM, J, 1/10W	1	
	R16171	D0GD100JA059	M 10 OHM, J, 0.25W	1	
	R16172	ERJ6GEYF473	M 47KOHM, J, 1/10W	1	
	R16173	ERJ6GEYF473	M 47KOHM, J, 1/10W	1	
	R16181	D0GD100JA059	M 10 OHM, J, 0.25W	1	
	R16182	ERJ6GEYF473	M 47KOHM, J, 1/10W	1	
	R16183	ERJ6GEYF473	M 47KOHM, J, 1/10W	1	
	R16191	ERJ6GEYJ151V	M 150 OHM, J, 1/10W	1	
	R16192	ERJ6GEYJ103V	M 10K OHM J 1/10W	1	

Safety	Ref. No.	Part No.	Part Name & Description	Pcs	Remarks
	R16193	ERJ6GEYJ750	M 75 OHM,J,1/10W	1	
	R16194	D0GF7R5JA047	M 7.5 OHM,J,0.33W	1	
	R16195	D0GF1R0JA047	M 1.0 OHM,J,0.33W	1	
	R16196	D0GF7R5JA047	M 7.5 OHM,J,0.33W	1	
	R16230	ERJ6GEYJ470V	M 47 OHM,J,1/10W	1	
	R16231	ERJ6GEYJ472V	M 4.7K OHM J 1/10W	1	
	R16241	EXB38V470J	RESISTOR ARRAY	1	
	R16242	EXB38V472JV	RESISTOR ARRAY	1	
	R16251	D1BD1401A044	M 1.4KOHM, 1/10W	1	
	R16252	D1BD3902A044	M 39KOHM, 1/10W	1	
	R16253	D1BD3902A044	M 39KOHM, 1/10W	1	
	R16254	D1BD6801A044	M 6.8KOHM, 1/10W	1	
	R16255	D1BD1201A044	M 1.2KOHM, 1/10W	1	
	R16256	D1BD1501A044	M 1.4KOHM, 1/10W	1	
	R16257	ERJ6GEYJ273	M 27KOHM,J,1/10W	1	
	R16258	ERJ6GEYJ103V	M 10K OHM J 1/10W	1	
	R16260	ERJ6GEYJ222V	M 2.2K OHM J 1/10W	1	
	R16280	ERJ6GEYJ222V	M 2.2K OHM J 1/10W	1	
	R16281	D0GD103JA036	M 10KOHM,J,0.25W	1	
	R16282	ERJ6GEYJ221V	M 220 OHM,J,1/10W	1	
	R16283	ERJ6GEYF473	M 47KOHM,J,1/10W	1	
	R16284	ERJ6GEYJ224	M 220KOHM,J,1/10W	1	
	R16285	EXB38V623J	RESISTOR ARRAY	1	
	R16288	D0GF334JA047	M 330KOHM,F,0.33W	1	
	R16289	D0GF334JA047	M 330KOHM,F,0.33W	1	
	R16290	D0GF334JA047	M 330KOHM,F,0.33W	1	
	R16302	ERJ8GEYJ333	M 33KOHM, J,1/8W	1	
	R16307	ERJ6RBD683	M 68KOHM,J,1/10W	1	
	R16309	ERJ8GEYJ333	M 33KOHM, J,1/8W	1	
	R16310	ERJ8GEYJ333	M 33KOHM, J,1/8W	1	
	R16311	ERJ8GEYJ333	M 33KOHM, J,1/8W	1	
	R16317	ERJ6RBD162	M 1.6KOHM,J,1/10W	1	
	R16318	ERJ6RBD683	M 68KOHM,J,1/10W	1	
	R16319	ERJ6RBD2491	M 2.49KOHM, 1/10W	1	PAVCCZ
	R16320	ERJ14YJ683	M 68KOHM, 1/2W	1	
	R16330	ERJ6GEYJ102V	M 1K OHM J 1/10W	1	
	R16332	ERJ6GEYJ474	M 470KOHM,J,1/10W	1	
	R16334	ERJ6GEYJ472V	M 4.7K OHM J 1/10W	1	
	R16335	ERJ6GEYJ102V	M 1K OHM J 1/10W	1	
	R16401	ERJT08J7R5V	M 7.5OHM,J,0.33W	1	
	R16402	ERJT08J7R5V	M 7.5OHM,J,0.33W	1	
	R16410	ERJ6GEYG391	M 390 OHM,F,1/10W	1	
	R16411	D1BD2700A044	M 270 OHM, 1/10W	1	
	R16414	ERJ6GEYJ331V	M 330 OHM J 1/10W	1	
	R16415	ERJ6GEYJ331V	M 330 OHM J 1/10W	1	
	R16416	D0GD103JA036	M 10KOHM,J,0.25W	1	
	R16421	ERJT08J7R5V	M 7.5OHM,J,0.33W	1	
	R16422	ERJT08J7R5V	M 7.5OHM,J,0.33W	1	
	R16441	ERJT08J5R6V	M 5.6 OHM,F,0.33W	1	
	R16451	ERJT08J5R6V	M 5.6 OHM,F,0.33W	1	
	R16465	D1BD2702A044	M 27KOHM, 1/10W	1	
	R16466	D1BD5602A044	M 56KOHM, 1/10W	1	
	R16467	ERJ6ENF8202	M 82KOHM, 1/10W	1	

Safety	Ref. No.	Part No.	Part Name & Description	Pcs	Remarks
	R16468	ERJ6ENF8202	M 82KOHM, 1/10W	1	
	R16471	ERJ6GEYG392	M 3.9KOHM,J,1/10W	1	
	R16472	ERJ6GEYJ222V	M 2.2K OHM J 1/10W	1	
	R16473	ERJ6GEYF561	M 560 OHM,F,1/10W	1	
	R16474	ERJ6GEYJ102V	M 1K OHM J 1/10W	1	
	R16475	ERJ6GEYJ472V	M 4.7K OHM J 1/10W	1	
	R16476	ERJ6GEYJ472V	M 4.7K OHM J 1/10W	1	
	R16478	ERJ6GEYJ562V	M 5.6KOHM,J,1/10W	1	
	R16479	D0GD103JA036	M 10KOHM,J,0.25W	1	
	R16480	ERJ6GEYJ472V	M 4.7K OHM J 1/10W	1	
	R16490	ERJ6RED134V	M 130KOHM, 1/10W	1	
	R16491	ERJ6RED124	M 120KOHM, 1/10W	1	
	R16492	ERJ6RED154	M 150KOHM, 1/10W	1	
	R16493	ERJ6RBD103V	M 10KOHM,J,1/10W	1	
	R16494	D1BD2001A044	M 2KOHM, 1/10W	1	
	R16495	D1BD6800A044	M 680 OHM, 1/10W	1	
	R16496	ERJ6GEYJ470V	M 47 OHM,J,1/10W	1	
	R16497	ERJ6GEYF473	M 47KOHM,J,1/10W	1	
	R16498	D0GD103JA036	M 10KOHM,J,0.25W	1	
	R16501	D0GD101JA036	M 100 OHM,J,0.25W	1	
	R16502	D0GD101JA036	M 100 OHM,J,0.25W	1	
	R16503	ERJT06J100V	M 10 OHM,F,0.25W	1	
	R16504	ERJT06J750V	M 75 OHM,F,0.25W	1	
	R16506	ERJT06J100V	M 10 OHM,F,0.25W	1	
	R16509	ERJT08J1R0V	M 1.8OHM,J,0.33W	1	
	R16511	ERJ6GEYF473	M 47KOHM,J,1/10W	1	
	R16512	ERJ6GEYF473	M 47KOHM,J,1/10W	1	
	R16516	ERJ6GEYF473	M 47KOHM,J,1/10W	1	
	R16517	ERJ6GEYF473	M 47KOHM,J,1/10W	1	
	R16521	D0GD101JA036	M 100 OHM,J,0.25W	1	
	R16522	D0GD101JA036	M 100 OHM,J,0.25W	1	
	R16523	ERJT06J750V	M 75 OHM,F,0.25W	1	
	R16531	ERJT06J100V	M 10 OHM,F,0.25W	1	
	R16532	ERJ6GEYF473	M 47KOHM,J,1/10W	1	
	R16533	ERJ6GEYF473	M 47KOHM,J,1/10W	1	
	R16534	ERJT08J1R0V	M 1.8OHM,J,0.33W	1	
	R16536	ERJT08J1R0V	M 1.8OHM,J,0.33W	1	
	R16551	ERJT06J100V	M 10 OHM,F,0.25W	1	
	R16552	ERJ6GEYF473	M 47KOHM,J,1/10W	1	
	R16553	ERJ6GEYF473	M 47KOHM,J,1/10W	1	
	R16561	EXB38V470J	RESISTOR ARRAY	1	
	R16562	EXB38V470J	RESISTOR ARRAY	1	
	R16563	EXB38V470J	RESISTOR ARRAY	1	
	R16564	EXB38V470J	RESISTOR ARRAY	1	
	R16565	EXB38V472JV	RESISTOR ARRAY	1	
	R16566	EXB38V472JV	RESISTOR ARRAY	1	
	R16567	EXB38V472JV	RESISTOR ARRAY	1	
	R16568	EXB38V472JV	RESISTOR ARRAY	1	
	R16570	EXB38V472JV	RESISTOR ARRAY	1	
	R16573	ERJ6GEYJ220	M 22 OHM,J,1/10W	1	
	R16579	EXB38V470J	RESISTOR ARRAY	1	
	R16582	D1BD3902A044	M 39KOHM, 1/10W	1	
	R16583	D1BD3902A044	M 39KOHM, 1/10W	1	
	R16584	D1BD6801A044	M 6.8KOHM, 1/10W	1	
	R16585	D1BD1001A044	M 1KOHM, 1/10W	1	
	R16586	D1BD2151A044	M 2.15KOHM, 1/10W	1	
	R16587	ERJ6GEYJ222V	M 2.2K OHM J 1/10W	1	
	R16588	D0GD103JA036	M 10KOHM,J,0.25W	1	
	R16590	ERJ6GEYJ221V	M 220 OHM,J,1/10W	1	
	R16591	EXB38V472JV	RESISTOR ARRAY	1	

Safety	Ref. No.	Part No.	Part Name & Description	Pcs	Remarks
	R16592	ERJ6GEYJ472V	M 4.7K OHM J 1/10W	1	
	R16593	D1BD1401A044	M 1.4KOHM, 1/10W	1	
	R16602	ERJ6GEYJ102V	M 1K OHM J 1/10W	1	
	R16604	ERJ6GEYJ331V	M 330 OHM J 1/10W	1	
	R16605	ERJ6GEYJ182	M 1.8KOHM, J, 1/10W	1	
	R16606	D0GD103JA036	M 10KOHM, J, 0.25W	1	
	R16607	D1BD6651A044	M 6.65KOHM, 1/10W	1	
	R16608	ERJT08J102V	M 1KOHM, J, 0.33W	1	
	R16609	ERJT08J102V	M 1KOHM, J, 0.33W	1	
	R16610	ERJ6GEYJ104V	M 100KOHM, J, 1/10W	1	
	R16611	ERJ8GEYJ683	M 68KOHM, J, 1/8W	1	
	R16612	ERJT06J470V	M 47 OHM, F, 0.25W	1	
	R16613	ERJ8GEYJ473	M 47KOHM, J, 1/8W	1	
	R16614	ERJ8GEYJ683	M 68KOHM, J, 1/8W	1	
	R16615	D1BD1101A044	M 1.41KOHM, 1/10W	1	
	R16617	ERJ6GEYJ222V	M 2.2K OHM J 1/10W	1	
	R16621	ERJ6GEYJ221V	M 220 OHM, J, 1/10W	1	
	R16622	ERJ6GEYJ221V	M 220 OHM, J, 1/10W	1	
	R16627	ERJ6GEYJ220	M 22 OHM, J, 1/10W	1	
	R16628	ERJ6GEYF473	M 47KOHM, J, 1/10W	1	
	R16631	D0GD103JA036	M 10KOHM, J, 0.25W	1	
	R16633	ERJ6GEYJ223	M 22KOHM, J, 1/10W	1	
	R16634	ERJ6GEYJ471	M 470 OHM, J, 1/10W	1	
	R16646	D1BD1181A044	M 1.18KOHM, 1/10W	1	
	R16648	ERJT08J202V	M 2KOHM, J, 0.33W	1	
	R16649	ERJT06J330V	M 33 OHM, F, 0.25W	1	
	R16650	ERJ6GEYJ104V	M 100KOHM, J, 1/10W	1	
	R16651	ERJT08J202V	M 2KOHM, J, 0.33W	1	
	R16652	ERJ6GEYF822	M 8.2KOHM, F, 1/10W	1	
	R16653	ERJ8GEYJ182	M 1.8KOHM, J, 1/8W	1	
	R16654	ERJ6GEYJ470V	M 47 OHM, J, 1/10W	1	
	R16655	ERJ6GEYJ103V	M 10K OHM J 1/10W	1	
	R16656	ERJ8GEYJ472V	M 4.7KOHM, J, 1/8W	1	
	R16657	ERJ6GEYJ103V	M 10K OHM J 1/10W	1	
	R16658	D1BD6491A044	M 6.49KOHM, 1/10W	1	
	R16660	ERJ6GEYJ222V	M 2.2K OHM J 1/10W	1	
	R16661	ERJ6GEYJ122V	M 1.2KOHM, J, 1/10W	1	
	R16662	D1BD1002A044	M 10.0KOHM, 1/10W	1	
	R16663	D1BD6801A044	M 6.8KOHM, 1/10W	1	
	R16664	ERJT08J202V	M 2KOHM, J, 0.33W	1	
	R16665	ERJT06J330V	M 33 OHM, F, 0.25W	1	
	R16666	ERJ6GEYJ223	M 22KOHM, J, 1/10W	1	
	R16667	ERJT08J202V	M 2KOHM, J, 0.33W	1	
	R16668	ERJT08J202V	M 2KOHM, J, 0.33W	1	
	R16673	ERJ6GEYJ472V	M 4.7K OHM J 1/10W	1	
	R16674	ERJT08J202V	M 2KOHM, J, 0.33W	1	
	R16675	ERJ6GEYJ472V	M 4.7K OHM J 1/10W	1	
	R16677	ERJT08J202V	M 2KOHM, J, 0.33W	1	
	R16678	ERJT08J202V	M 2KOHM, J, 0.33W	1	
	R16679	D1BD7501A044	M 7.5KOHM, 1/10W	1	
	R16680	ERJ6GEYJ472V	M 4.7K OHM J 1/10W	1	
	R16681	ERJT06J100V	M 10 OHM, F, 0.25W	1	
	R16682	ERJT06J100V	M 10 OHM, F, 0.25W	1	
	R16684	ERJ6GEYJ221V	M 220 OHM, J, 1/10W	1	
	R16685	ERJ6GEYJ221V	M 220 OHM, J, 1/10W	1	
	R16686	D0GD103JA036	M 10KOHM, J, 0.25W	1	

Safety	Ref. No.	Part No.	Part Name & Description	Pcs	Remarks
	R16687	D1BD2702A044	M 27KOHM, 1/10W	1	
	R16688	D1BD1272A044	M 12.7KOHM, 1/10W	1	
	R16690	ERJ6GEYJ472V	M 4.7K OHM J 1/10W	1	
	R16691	ERJ8GEYJ563	M 56KOHM, J, 1/8W	1	
	R16692	ERJ6RBD152	M 1.5KOHM, J, 1/10W	1	
	R16694	ERJ8GEYJ563	M 56KOHM, J, 1/8W	1	
	R16695	ERJ6RBD152	M 1.5KOHM, J, 1/10W	1	
	R16696	ERF5TK2R2	W 2.2 OHM, K, 5W	1	
	R16699	D0GD103JA036	M 10KOHM, J, 0.25W	1	
	R16707	ERJ6GEYJ392	M 3.9KOHM, J, 1/10W	1	
	R16711	ERJ6GEYJ472V	M 4.7K OHM J 1/10W	1	
	R16712	ERJ6GEYJ102V	M 1K OHM J 1/10W	1	
	R16713	ERG1FJS104D	M 100KOHM, J, 1W	1	
	R16714	ERJ6GEYF473	M 47KOHM, J, 1/10W	1	
	R16715	ERJ6GEYJ103V	M 10K OHM J 1/10W	1	
	R16717	ERJ6GEYJ102V	M 1K OHM J 1/10W	1	
	R16719	ERJ3GEYJ220	M 22 OHM, J, 1/16W	1	
	R16720	ERJ3GEYJ220	M 22 OHM, J, 1/16W	1	
	R16721	ERJ3GEYJ220	M 22 OHM, J, 1/16W	1	
	R16722	ERJ3GEYJ220	M 22 OHM, J, 1/16W	1	
	R16723	ERJ3GEYJ220	M 22 OHM, J, 1/16W	1	
	R16731	ERG2FJS104D	M 100KOHM, J, 2W	1	
	R16733	ERJ6GEYJ474	M 470KOHM, J, 1/10W	1	
	R16734	D1BD4991A044	M 4.99KOHM, 1/10W	1	
	R16735	D1BD1873A044	M 187KOHM, 1/10W	1	
	R16736	D1BD1873A044	M 187KOHM, 1/10W	1	
	R16737	D1BD2053A044	M 205KOHM, 1/10W	1	
	R16742	D0GD103JA036	M 10KOHM, J, 0.25W	1	
	R16744	D1BD1273A044	M 127KOHM, 1/10W	1	
	R16745	D1BD2202A044	M 2.2KOHM, 1/10W	1	
	R16746	ERJT06J473V	M 47KOHM, F, 0.25W	1	
	R16747	ERJT06J103V	M 10KOHM, F, 0.25W	1	
	R16749	D0GD103JA036	M 10KOHM, J, 0.25W	1	
	R16750	ERJT06J123	M 12KOHM, F, 0.25W	1	
	R16751	ERJT06J154V	M 150KOHM, F, 0.25W	1	
	R16752	ERJ6GEYJ472V	M 4.7K OHM J 1/10W	1	
	R16753	ERJ6GEYJ224	M 220KOHM, J, 1/10W	1	
	R16755	ERJT06J123	M 12KOHM, F, 0.25W	1	
	R16756	ERJT06J123	M 12KOHM, F, 0.25W	1	
	R16761	ERJT06J100V	M 10 OHM, F, 0.25W	1	
	R16762	ERJ6GEYF473	M 47KOHM, J, 1/10W	1	
	R16763	ERJ6GEYF473	M 47KOHM, J, 1/10W	1	
	R16765	ERJT08J1R0V	M 1.8OHM, J, 0.33W	1	
	R16766	D0GDR00Z0002	M 0 OHM, 1/10W	1	
	R16769	ERJT06J750V	M 75 OHM, F, 0.25W	1	
	R16772	ERJ6GEYJ472V	M 4.7K OHM J 1/10W	1	
	R16773	ERJ6GEYJ102V	M 1K OHM J 1/10W	1	
	R16774	ERG1S273	M 27KOHM, J, 1W	1	
	R16775	ERJ6GEYJ472V	M 4.7K OHM J 1/10W	1	
	R16776	ERJ6GEYJ470V	M 47 OHM, J, 1/10W	1	
	R16777	ERJ6GEYJ103V	M 10K OHM J 1/10W	1	
	R16783	ERJT06J154V	M 150KOHM, F, 0.25W	1	
	R16785	D1BD1003A044	M 100KOHM, 1/10W	1	
	R16786	D1BD1003A044	M 100KOHM, 1/10W	1	
	R16787	D1BD3302A044	M 33KOHM, 1/10W	1	
	R16789	D0GD103JA036	M 10KOHM, J, 0.25W	1	
	R16791	ERJ6GEYJ102V	M 1K OHM J 1/10W	1	
	R16794	D1BD2003A044	M 200KOHM, 1/10W	1	
	R16795	D1BD2003A044	M 200KOHM, 1/10W	1	
	R16796	D1BD5602A044	M 56KOHM, 1/10W	1	
	R16797	ERJ6GEYJ220	M 22 OHM, J, 1/10W	1	

Safety	Ref. No.	Part No.	Part Name & Description	Pcs	Remarks
	R16798	ERJ6GEYJ222V	M 2.2K OHM J 1/10W	1	
	R16799	ERJ6GEYJ102V	M 1K OHM J 1/10W	1	
	R16801	D1BD4702A044	M 47KOHM, 1/10W	1	
	R16802	D1BD4702A044	M 47KOHM, 1/10W	1	
	R16804	ERJ8GEYJ104V	M 100KOHM, J,1/8W	1	
	R16806	ERJ6GEYJ102V	M 1K OHM J 1/10W	1	
	R16812	ERJ6GEYJ182	M 1.8KOHM, J,1/10W	1	
	R16813	ERJ8GEYJ222V	M 2.2KOHM, J,1/8W	1	
	R16814	D1BD2212A044	M 22KOHM, 1/10W	1	
	R16815	D1BD2491A044	M2.49KOHM, 1/10W	1	
	R16818	D1BD3302A044	M 33KOHM, 1/10W	1	
	R16819	D1BD1003A044	M 100KOHM, 1/10W	1	
	R16820	D1BD1003A044	M 100KOHM, 1/10W	1	
	R16821	D1BD1003A044	M 100KOHM, 1/10W	1	
	R16822	ERJ6ENF8202	M 82KOHM, 1/10W	1	
	R16823	ERJ6ENF8202	M 82KOHM, 1/10W	1	
	R16824	D1BD3302A044	M 33KOHM, 1/10W	1	
	R16825	ERJT06J154V	M 150KOHM, F, 0.25W	1	
	R16826	DOGD103JA036	M 10KOHM, J, 0.25W	1	
	R16829	ERJ6GEYJ102V	M 1K OHM J 1/10W	1	
	R16831	D1BD6192A044	M61.9KOHM, 1/10W	1	
	R16832	D1BD7322A044	M73.2KOHM, 1/10W	1	
	R16833	DOGD103JA036	M 10KOHM, J, 0.25W	1	
	R16838	ERJ14YJ563U	M 56KOHM, 1/2W	1	
	R16841	ERJ14YJ563U	M 56KOHM, 1/2W	1	
	R16844	D1BD1241A044	M1.24KOHM, 1/10W	1	
	R16845	D1BD8662A044	M86.6KOHM, 1/10W	1	
	R16846	D1BD8202A044	M 82KOHM, 1/10W	1	
	R16847	ERJ6GEYJ472V	M 4.7K OHM J 1/10W	1	
	R16848	ERJ6GEYJ472V	M 4.7K OHM J 1/10W	1	
	R16851	ERJ6GEYJ474	M 470KOHM, J, 1/10W	1	
	R16860	D0D28R2JA021	M 8.2 OHM, J, 2W	1	
	R16869	ERJ8GEYJ473	M 47KOHM, J, 1/8W	1	
	R16870	ERJ14YJ683	M 68KOHM, 1/2W	1	
	R16873	D1BD2491A044	M2.49KOHM, 1/10W	1	
	R16877	ERJ6GEYJ681	M 680 OHM, J, 1/10W	1	
	R16891	D1BD4702A044	M 47KOHM, 1/10W	1	
	R16892	D1BD4702A044	M 47KOHM, 1/10W	1	
	R16893	D1BD4702A044	M 47KOHM, 1/10W	1	
	R16894	D1BD4702A044	M 47KOHM, 1/10W	1	
	R16895	D1BD4702A044	M 47KOHM, 1/10W	1	
	R16896	D1BD3302A044	M 33KOHM, 1/10W	1	
	R16897	D1BD1541A044	M1.54KOHM, 1/10W	1	
	R16898	D1BD2371A044	M2.37KOHM, 1/10W	1	
	R16899	D1BD2261A044	M22.6KOHM, 1/10W	1	
	R16900	DOGD103JA036	M 10KOHM, J, 0.25W	1	
	R16901	ERJ6GEYJ472V	M 4.7K OHM J 1/10W	1	
	R16904	ERJ6GEYJ223	M 22KOHM, J, 1/10W	1	
	R16919	D1BD7501A044	M 7.5KOHM, 1/10W	1	
	R16920	DOGD103JA036	M 10KOHM, J, 0.25W	1	
	R16921	D1BD2611A044	M2.61KOHM, 1/10W	1	
	R16922	D1BD2001A044	M 2KOHM, 1/10W	1	
	R16923	ERJ6GEYJ103V	M 10K OHM J 1/10W	1	
	R16926	ERJ6GEYJ222V	M 2.2K OHM J 1/10W	1	
	R16927	ERJ6GEYJ223	M 22KOHM, J, 1/10W	1	
	R17101	DOGDR00Z0002	M 0 OHM, 1/10W	1	
	R17102	ERJ3GEYOR00	M 0 OHM, 1/16W	1	
	R17103	EXB38V681J	RESISTOR ARRAY	1	
	R17104	EXB38V470J	RESISTOR ARRAY	1	
	R17105	EXB38V470J	RESISTOR ARRAY	1	
	R17106	ERJT14J6R8U	C6.8 OHM, J, 1/4W	1	
	R17107	ERJT14J6R8U	C6.8 OHM, J, 1/4W	1	
	R17108	ERJ3GEYJ101	M 100 OHM, J, 1/16W	1	

Safety	Ref. No.	Part No.	Part Name & Description	Pcs	Remarks
	R17109	ERJ3GEYJ101	M 100 OHM, J, 1/16W	1	
	R17110	ERJ3GEYJ201	M 200 OHM, J, 1/16W	1	
	R17111	ERJT14J6R8U	C6.8 OHM, J, 1/4W	1	
	R17112	ERJT14J6R8U	C6.8 OHM, J, 1/4W	1	
	R17113	ERJ3GEYJ101	M 100 OHM, J, 1/16W	1	
	R17114	ERJ3GEYJ101	M 100 OHM, J, 1/16W	1	
	R17115	ERJ3GEYJ201	M 200 OHM, J, 1/16W	1	
	R17116	ERJT14J6R8U	C6.8 OHM, J, 1/4W	1	
	R17117	ERJT14J6R8U	C6.8 OHM, J, 1/4W	1	
	R17118	ERJ3GEYJ101	M 100 OHM, J, 1/16W	1	
	R17119	ERJ3GEYJ101	M 100 OHM, J, 1/16W	1	
	R17120	ERJ3GEYJ201	M 200 OHM, J, 1/16W	1	
	R17121	ERJT14J6R8U	C6.8 OHM, J, 1/4W	1	
	R17122	ERJT14J6R8U	C6.8 OHM, J, 1/4W	1	
	R17123	ERJ3GEYJ101	M 100 OHM, J, 1/16W	1	
	R17124	ERJ3GEYJ101	M 100 OHM, J, 1/16W	1	
	R17125	ERJ3GEYJ201	M 200 OHM, J, 1/16W	1	
	R17126	ERJT14J6R8U	C6.8 OHM, J, 1/4W	1	
	R17127	ERJT14J6R8U	C6.8 OHM, J, 1/4W	1	
	R17128	ERJ3GEYJ101	M 100 OHM, J, 1/16W	1	
	R17129	ERJ3GEYJ101	M 100 OHM, J, 1/16W	1	
	R17130	ERJ3GEYJ201	M 200 OHM, J, 1/16W	1	
	R17131	ERJT14J6R8U	C6.8 OHM, J, 1/4W	1	
	R17132	ERJT14J6R8U	C6.8 OHM, J, 1/4W	1	
	R17133	ERJ3GEYJ101	M 100 OHM, J, 1/16W	1	
	R17134	ERJ3GEYJ101	M 100 OHM, J, 1/16W	1	
	R17135	ERJ3GEYJ201	M 200 OHM, J, 1/16W	1	
	R17136	ERJT14J6R8U	C6.8 OHM, J, 1/4W	1	
	R17137	ERJT14J6R8U	C6.8 OHM, J, 1/4W	1	
	R17138	ERJ3GEYJ101	M 100 OHM, J, 1/16W	1	
	R17139	ERJ3GEYJ101	M 100 OHM, J, 1/16W	1	
	R17140	ERJ3GEYJ101	M 100 OHM, J, 1/16W	1	
	R17141	ERJT14J6R8U	C6.8 OHM, J, 1/4W	1	
	R17142	ERJT14J6R8U	C6.8 OHM, J, 1/4W	1	
	R17143	ERJ3GEYJ101	M 100 OHM, J, 1/16W	1	
	R17144	ERJ3GEYJ101	M 100 OHM, J, 1/16W	1	
	R17145	ERJ3GEYJ101	M 100 OHM, J, 1/16W	1	
	R17146	ERJ3GEYJ681	M 680 OHM, J, 1/16W	1	
	R17147	ERJ6GEYJ224	M 220KOHM, J, 1/10W	1	
	R17148	DOGF472JA047	M 4.7KOHM, J, 0.33W	1	
	R17149	ERJ3GEYOR00	M 0 OHM, 1/16W	1	
	R17150	DOGB102JA057	M 1KOHM, J, 1/16W	1	
	R17201	ERJ6GEYJ224	M 220KOHM, J, 1/10W	1	
	R17202	EXB38V470J	RESISTOR ARRAY	1	
	R17203	EXB38V470J	RESISTOR ARRAY	1	
	R17204	EXB38V681J	RESISTOR ARRAY	1	
	R17205	EXB38V470J	RESISTOR ARRAY	1	
	R17206	EXB38V470J	RESISTOR ARRAY	1	
	R17207	EXB38V681J	RESISTOR ARRAY	1	
	R17208	EXB38V681J	RESISTOR ARRAY	1	
	R17210	ERJT14J6R8U	C6.8 OHM, J, 1/4W	1	

Safety	Ref. No.	Part No.	Part Name & Description	Pcs	Remarks
	R17211	ERJT14J6R8U	C6.8 OHM, J,1/4W	1	
	R17212	ERJ3GEYJ101	M 100 OHM, J,1/16W	1	
	R17213	ERJ3GEYJ101	M 100 OHM, J,1/16W	1	
	R17214	ERJ3GEYJ201	M 200 OHM, J,1/16W	1	
	R17215	ERJT14J6R8U	C6.8 OHM, J,1/4W	1	
	R17216	ERJT14J6R8U	C6.8 OHM, J,1/4W	1	
	R17217	ERJ3GEYJ101	M 100 OHM, J,1/16W	1	
	R17218	ERJ3GEYJ101	M 100 OHM, J,1/16W	1	
	R17219	ERJ3GEYJ201	M 200 OHM, J,1/16W	1	
	R17220	ERJT14J6R8U	C6.8 OHM, J,1/4W	1	
	R17221	ERJT14J6R8U	C6.8 OHM, J,1/4W	1	
	R17222	ERJ3GEYJ101	M 100 OHM, J,1/16W	1	
	R17223	ERJ3GEYJ101	M 100 OHM, J,1/16W	1	
	R17224	ERJ3GEYJ201	M 200 OHM, J,1/16W	1	
	R17225	ERJT14J6R8U	C6.8 OHM, J,1/4W	1	
	R17226	ERJT14J6R8U	C6.8 OHM, J,1/4W	1	
	R17227	ERJ3GEYJ101	M 100 OHM, J,1/16W	1	
	R17228	ERJ3GEYJ101	M 100 OHM, J,1/16W	1	
	R17229	ERJ3GEYJ201	M 200 OHM, J,1/16W	1	
	R17230	ERJT14J6R8U	C6.8 OHM, J,1/4W	1	
	R17231	ERJT14J6R8U	C6.8 OHM, J,1/4W	1	
	R17232	ERJ3GEYJ101	M 100 OHM, J,1/16W	1	
	R17233	ERJ3GEYJ101	M 100 OHM, J,1/16W	1	
	R17234	ERJ3GEYJ201	M 200 OHM, J,1/16W	1	
	R17235	ERJT14J6R8U	C6.8 OHM, J,1/4W	1	
	R17236	ERJT14J6R8U	C6.8 OHM, J,1/4W	1	
	R17237	ERJ3GEYJ101	M 100 OHM, J,1/16W	1	
	R17238	ERJ3GEYJ101	M 100 OHM, J,1/16W	1	
	R17239	ERJ3GEYJ201	M 200 OHM, J,1/16W	1	
	R17240	ERJT14J6R8U	C6.8 OHM, J,1/4W	1	
	R17241	ERJT14J6R8U	C6.8 OHM, J,1/4W	1	
	R17242	ERJ3GEYJ101	M 100 OHM, J,1/16W	1	
	R17243	ERJ3GEYJ101	M 100 OHM, J,1/16W	1	
	R17244	ERJ3GEYJ101	M 100 OHM, J,1/16W	1	
	R17245	ERJ3GEYJ681	M 680 OHM, J,1/16W	1	
	R17247	D0GF472JA047	M 4.7KOHM, J, 0.33W	1	
	R17260	D0GDR00Z0002	M 0 OHM, 1/10W	1	
	SC2	K1KY02B00012	2P CONNECTOR	1	
	SC20	K1MY35BA0345	35P CONNECTOR	1	
	SC41	K1KA09AA0707	9P CONNECTOR	1	
	SC42	K1KA09AA0707	9P CONNECTOR	1	
	SC46	K1KA09AA0707	9P CONNECTOR	1	
	SC50	K1KA02AA0193	2P CONNECTOR	1	
	SS11	K1KA03A00608	3P CONNECTOR	1	
	SS21	K1KA07A00170	7P CONNECTOR	1	
	SS24	K1KB07AA0087	7P CONNECTOR	1	
	SS33	K1KA08B00270	8P CONNECTOR	1	
	SS58	K1MN13B00091	13P CONNECTOR	1	
	SS61	K1MN13B00091	13P CONNECTOR	1	
	SS64	K1MN13B00091	13P CONNECTOR	1	
	VR16600	EVMEASA00B54	CONTROL 50KOHMB 0.3W	1	

Safety	Ref. No.	Part No.	Part Name & Description	Pcs	Remarks
	VR16601	EVMEASA00B53	CONTROL 50KOHMB 0.3W	1	
	VR16841	EVMEASA00B24	CONTROL 20KOHMB 0.3W	1	
	ZA16001	K4CD01000011	AV TERMINAL	1	
	ZA16002	K4CD01000011	AV TERMINAL	1	
	ZA16401	K4CD01000011	AV TERMINAL	1	
	ZA16402	K4CD01000011	AV TERMINAL	1	
	ZA16403	K4CD01000011	AV TERMINAL	1	
	ZA17101	K4AD01Z00001	TERMINAL	1	
	ZA17102	K4AD01Z00001	TERMINAL	1	
	ZA17103	K4AD01Z00001	TERMINAL	1	
	ZA17104	K4AD01Z00001	TERMINAL	1	
	ZA17201	K4AD01Z00001	TERMINAL	1	
	ZA17202	K4AD01Z00001	TERMINAL	1	
	ZA17203	K4AD01Z00001	TERMINAL	1	
	ZA17204	K4AD01Z00001	TERMINAL	1	
△	A601	AYRA652MSV8T	ARRESTOR	1	
	C201	ECJ2XB1H104K	C 0.1UF, K, 50V	1	
	C202	ACKZE1H220T	50V 22PF	1	
	C203	ECJ2XB1H104K	C 0.1UF, K, 50V	1	
	C204	ACMBB474K2T	CERAMIC CHIP CAPACITOR	1	
	C205	ACMBB474K2T	CERAMIC CHIP CAPACITOR	1	
	C206	ACCC3AD470JP	CERAMIC CAPACITOR	1	
	C207	ECJ1VB1H103K	C 0.001UF, K, 50V	1	
	C208	ACMEB224K1T	CERAMIC CHIP CAPACITOR	1	
	C209	ECJ1VB1H222K	C 2200PF, K, 50V	1	
	C211	ECJ1XC1H101J	C 100PF, J, 50V	1	
	C212	ECWH8333HVB	PLASTIC FILM CAPACITOR (PP)	1	
	C214	ECWF6104JLB	PLASTIC FILM CAPACITOR (PP)	1	
	C215	ECWF6104JLB	PLASTIC FILM CAPACITOR (PP)	1	
	C216	ACDE1SL221JP	CERAMIC CAPACITOR	1	
	C217	ACRR3DD122KP	CERAMIC CAPACITOR	1	
	C218	ACDE1SL100DP	CERAMIC CAPACITOR	1	
	C251	ACDE1R152KT	CERAMIC CAPACITOR	1	
△	C253	EETHC2E821KH	ELECTROLYTIC CAPACITOR	1	
	C256	ACMEB105K1T	CERAMIC CHIP CAPACITOR	1	
	C257	ECJ1VC1H471J	C 470PF J 50V	1	
	C258	ECQE2224RKF	PLASTIC FILM CAPACITOR	1	
	C352	ACKZE1V561T	ELECTROLYTIC CAPACITOR	1	
△	C353	ACKZE1K821E	A1 ELECTROLYTIC CAPACITOR	1	
	C354	ACKZE1H100T	50V 10PF	1	
△	C355	ACKZE1K681E	A1 ELECTROLYTIC CAPACITOR	1	
	C358	ECQE2104SKF	250V 0.1PF	1	
	C359	ECJ2XB1H104K	C 0.1UF, K, 50V	1	
	C360	ECJ1VC1H471J	C 470PF J 50V	1	
	C361	ECQE2224RKF	PLASTIC FILM CAPACITOR	1	
	C366	ACKZE1E471LT	25V 470PF	1	
	C367	ECQV1H105JL	50V 1PF	1	
	C369	ACKZE1A102ST	ELECTROLYTIC CAPACITOR	1	
	C370	ACMEB104K5T	CERAMIC CHIP CAPACITOR	1	
	C374	ACMAB105K5T	CERAMIC CHIP CAPACITOR	1	

Safety	Ref. No.	Part No.	Part Name & Description	Pcs	Remarks
	C375	ACMAB105K5T	CERAMIC CHIP CAPACITOR	1	
	C376	ACMEB105K1T	CERAMIC CHIP CAPACITOR	1	
	C379	ECJ1VB1H472K	C 4700PF, K, 50V	1	
	C380	ACMEB333K5T	CERAMIC CHIP CAPACITOR	1	
	C381	ACKZE1V271T	ELECTROLYTIC CAPACITOR	1	
	C382	ECJ1VB1H102K	C 1000PF, K, 50V	1	
	C383	ACMEB474K1T	CERAMIC CHIP CAPACITOR	1	
	C384	ACRC2HD222KP	CERAMIC CAPACITOR	1	
	C385	ECJ1VB1E223K	C 0.023UF, K, 25V	1	
	C501	ACLE103KC	PLASTIC FILM CAPACITOR (Xcap)	1	
△	C503	ACKMQ2W330T	Al ELECTROLYTIC CAPACITOR	1	
	C504	ECJ1VB1H103K	C 0.001UF, K, 50V	1	
	C505	ACKZE1H220T	50V 22PF	1	
	C506	ECJ1VB1H102K	C 1000PF, K, 50V	1	
	C507	ECJ1VB1H103K	C 0.001UF, K, 50V	1	
	C508	ACMBB474K2T	CERAMIC CHIP CAPACITOR	1	
	C509	ECJ1VB1H103K	C 0.001UF, K, 50V	1	
	C510	ACKZE1H100T	50V 10PF	1	
	C511	ECJ1VB1H102K	C 1000PF, K, 50V	1	
	C512	ACMEB103K5T	CERAMIC CHIP CAPACITOR	1	
	C513	ECJ1VB1H102K	C 1000PF, K, 50V	1	
	C514	ACKZE1H221T	50V 220PF	1	
	C515	ACKZE1H220T	50V 22PF	1	
	C551	ACKZE1A471C	10V 470PF	1	
	C553	ACMEB474K1T	CERAMIC CHIP CAPACITOR	1	
	C554	ACKZE1E821LT	ELECTROLYTIC CAPACITOR	1	
	C555	ACMBB225K2T	CERAMIC CHIP CAPACITOR	1	
	C556	ACMBB105K2T	CERAMIC CHIP CAPACITOR	1	
	C557	ECJ2XB1H104K	C 0.1UF, K, 50V	1	
	C558	ECJ1VB1H103K	C 0.001UF, K, 50V	1	
	C560	ACKZE1E221T	ELECTROLYTIC CAPACITOR	1	
	C561	ACKZE1H100T	50V 10PF	1	
	C573	ECKD3A221KRP	CERAMIC CAPACITOR	1	
	C601	ACLEMX474KC	PLASTIC FILM CAPACITOR (Xcap)	1	
△	C602	ECKENA221KBR	C 221P 250V	1	
△	C603	ECKENA221KBR	C 221P 250V	1	
	C604	ACLEMX474KC	PLASTIC FILM CAPACITOR (Xcap)	1	
	C605	ECWF2W105KA	PLASTIC FILM CAPACITOR (PP)	1	
	C606	ACTEB104K5T	CERAMIC CHIP CAPACITOR	1	
	C608	ACTEB683K5T	CERAMIC CHIP CAPACITOR	1	
	C609	ACTEB104K5T	CERAMIC CHIP CAPACITOR	1	
	C610	ACTEB223K5T	CERAMIC CHIP CAPACITOR	1	
	C611	ECJ1VC1H471J	C 470PF J 50V	1	
	C613	ECJ1VC1H471J	C 470PF J 50V	1	
	C614	ACTEB104K5T	CERAMIC CHIP CAPACITOR	1	
	C615	ACTEB104K5T	CERAMIC CHIP CAPACITOR	1	
	C616	ACTEB104K5T	CERAMIC CHIP CAPACITOR	1	
	C618	ECJ1VB1H472K	C 4700PF, K, 50V	1	

Safety	Ref. No.	Part No.	Part Name & Description	Pcs	Remarks
	C620	ACMBB474K2T	CERAMIC CHIP CAPACITOR	1	
	C621	ECQE6472B45	C 4700U 630V	1	
	C622	ECJ1VB1H103K	C 0.001UF, K, 50V	1	
△	C623	ACKMQ2W391KZ	Al ELECTROLYTIC CAPACITOR	1	
△	C624	ECKENA331KBR	CERAMIC CAPACITOR	1	
	C626	ECJ1VB1H102K	C 1000PF, K, 50V	1	
	C627	ECQE6473RKF	P 0.047UF, K, 630V	1	
	C628	ACKZE1H220T	50V 22PF	1	
	C629	ECQV1H334JL	PLASTIC FILM CAPACITOR	1	
	C630	ECJ1XC1H102J	C 1000PF, J, 50V	1	
	C701	ACKZE1A221T	ELECTROLYTIC CAPACITOR	1	
	C702	ACMEB104K5T	CERAMIC CHIP CAPACITOR	1	
	C703	ACMEB104K5T	CERAMIC CHIP CAPACITOR	1	
	C704	ECJ1VB1H103K	C 0.001UF, K, 50V	1	
	C705	ACMEB104K5T	CERAMIC CHIP CAPACITOR	1	
	C706	ECJ2VB1H102K	C 1000PF, J, 50V	1	
	C711	ECJ1VB1H103K	C 0.001UF, K, 50V	1	
	C712	ACMEB224K2T	CERAMIC CHIP CAPACITOR	1	
	C713	ECJ1VB1H103K	C 0.001UF, K, 50V	1	
	C714	ACMEB223K5T	CERAMIC CHIP CAPACITOR	1	
	CN01	AKB6B-PH-KS	CONNECTOR	1	
	D201	VDAG01AT	DIODE	1	
	D202	VDAG01AT	DIODE	1	
	D203	MA165TAKU	DIODE	1	
	D204	VDERA83-004T	DIODE	1	
	D205	VDERA83-004T	DIODE	1	
	D206	VDERA83-004T	DIODE	1	
	D207	VDERA83-004T	DIODE	1	
	D208	MA165TAKU	DIODE	1	
	D209	VDAG01AT	DIODE	1	
	D252	VDSAR02LFA4	DIODE	1	
	D253	VDYG971S8R	DIODE	1	
	D351	VDFCH10A10	DIODE	1	
	D353	MA3DF3000S	DIODE	1	
	D356	VDRK36C4	DIODE	1	
	D358	VD1T7GA1	DIODE	1	
	D359	VDFCHS10A045	DIODE	1	
	D360	VDSAR02LFA4	DIODE	1	
△	D501	VDS1WBA80	DIODE	1	
	D502	MA165TAKU	DIODE	1	
	D503	VXST3D82BL3	DIODE	1	
	D504	VDAG01AT	DIODE	1	
	D505	VDAG01AT	DIODE	1	
△	D507	VD1T7GA1	DIODE	1	
	D551	VDFCH20B10	DIODE	1	
	D552	MA2DF3100S	DIODE	1	
	D601	MA165TAKU	DIODE	1	
	D602	MA165TAKU	DIODE	1	
△	D603	VDD15XB80	DIODE	1	
	D605	MA165TAKU	DIODE	1	
	D606	VDS3V60L1	DIODE	1	
	D607	VDYG982S6R	DIODE	1	
	D608	VDAG01AT	DIODE	1	
△	D609	VD1T7GA1	DIODE	1	
	D701	VDERA83-004T	DIODE	1	
△	F351	HU216008BEP	FUSE	1	
△	F501	HU5013002PRC	CARTRIDGE FUSE	1	

Safety	Ref. No.	Part No.	Part Name & Description	Pcs	Remarks
△	F601	HU5013010PRC	CARTRIDGE FUSE	1	
△	F602	HU5013010PRC	CARTRIDGE FUSE	1	
△	F603	HU216002BEP	FUSE	1	
	IC201	VINJM2904ME1	INTEGRATED CIRCUIT	1	
	IC202	VISSC9101M	INTEGRATED CIRCUIT	1	
	IC251	VIKIA431A	INTEGRATED CIRCUIT	1	
	IC351	VIKIA431A	INTEGRATED CIRCUIT	1	
	IC352	VISC2628T	INTEGRATED CIRCUIT	1	
	IC353	VIBD9703FP	POWER INTEGRATED CIRCUIT	1	
△	IC501	MIP3E50MY	POWER INTEGRATED CIRCUIT	1	
	IC551	VIKIA431A	INTEGRATED CIRCUIT	1	
	IC601	VIFA5502MTE1	INTEGRATED CIRCUIT	1	
	IC701	VILC87F2G081	INTEGRATED CIRCUIT	1	
	IC702	VIR3111N40AT	INTEGRATED CIRCUIT	1	
△	K602	ALKT329C93	RELAY	1	
△	K604	ALKT329C93	RELAY	1	
△	K605	ALKT329C93	RELAY	1	
	L351	AYS1615005Y	CHOKE COIL	1	
	L352	ELC10E470L	CHOKE COIL	1	
	L353	EXCELSA24T	FERRITE BEAD INDUCTOR	1	
	L501	EXCELSA35T	BEAD CHOKE	1	
	L502	EXCELD35V	CORE	1	
	L503	EXCELD35V	CORE	1	
△	L601	AYP2512305Y	FILTER CHOKE	1	
△	L602	AYP2512305Y	FILTER CHOKE	1	
	L603	ETB42AY11GAD	CHOKE COIL	1	
	L604	EXCELSA35T	BEAD CHOKE	1	
	P2	AKB2P3S-VH	CONNECTOR	1	
	P6	AKB12B-EH-A	12P CONNECTOR	1	
	P7	AKB11B-EH-A	11P CONNECTOR	1	
△	P9	AKS02B-VT	CONNECTOR	1	
	P11	AKB3P4S-VH-L	CONNECTOR	1	
	P25	AKB13B-PH-KS	13P CONNECTOR	1	
	P34	AKB3B-PH-KS	CONNECTOR	1	
	P35	AKB4B-PH-KS	CONNECTOR	1	
	P60	AKB3B-EH-A	CONNECTOR	1	
△	PC201	VPS2581AL2HE	OPTOISOLATOR	1	
△	PC301	VPS2581AL2HE	OPTOISOLATOR	1	
△	PC501	VPS2581AL2HE	OPTOISOLATOR	1	
△	PC502	VPS2581AL2HE	OPTOISOLATOR	1	
△	PC503	VPS2581AL2HE	OPTOISOLATOR	1	
△	PC504	VPS2581AL2HE	OPTOISOLATOR	1	
	Q201	2SC5866T	TRANSISTOR	1	
	Q202	2SC5866T	TRANSISTOR	1	
△	Q203	VKFMV19N57ES	FET	1	
△	Q204	VKFMV19N57ES	FET	1	
△	Q205	VKFMV19N57ES	FET	1	
△	Q206	VKFMV19N57ES	FET	1	
	Q207	2SA2094T	TRANSISTOR	1	
	Q208	2SA2094T	TRANSISTOR	1	
	Q354	2SD0601ARL	TRANSISTOR	1	
	Q355	2SJ651	FET	1	
	Q501	2SB710A-RTX	TRANSISTOR	1	
	Q502	2SK3018TL	FET	1	
	Q503	2SC5866T	TRANSISTOR	1	

Safety	Ref. No.	Part No.	Part Name & Description	Pcs	Remarks
	Q504	2SB709-R-RTX	TRANSISTOR	1	
	Q505	2SK3018TL	FET	1	
	Q506	2SB709-R-RTX	TRANSISTOR	1	
	Q551	2SJ651	FET	1	
	Q557	VKHAT1130R	FET	1	
△	Q601	VKFMR23N57E	FET	1	
	Q602	2SC5866T	TRANSISTOR	1	
	Q603	2SA2094T	TRANSISTOR	1	
△	Q604	VKFMR23N57E	FET	1	
	Q605	2SB709-R-RTX	TRANSISTOR	1	
	Q606	2SD0601ARL	TRANSISTOR	1	
	Q701	2SD0601ARL	TRANSISTOR	1	
	Q702	2SD0601ARL	TRANSISTOR	1	
	Q703	2SB710A-RTX	TRANSISTOR	1	
	Q704	2SD0601ARL	TRANSISTOR	1	
	Q705	2SB710A-RTX	TRANSISTOR	1	
	R201	D0GB103JA057	M 10K OHM J 1/16W	1	
	R202	ERJ6GEYJ100V	M 10 OHM, J, 1/10W	1	
	R203	ERJ3GEYJ223	M 22KOHM, J, 1/16W	1	
	R204	ERQ14AJ100JP	FUSIBLE METAL FILM RESISTOR	1	
	R206	ERQ14ZJ1R0JP	FUSIBLE METAL FILM RESISTOR	1	
	R207	ERQ14AJ100JP	FUSIBLE METAL FILM RESISTOR	1	
	R209	ERJ6GEYJ222V	M 2.2K OHM J 1/10W	1	
	R210	ERJ3GEYJ223	M 22KOHM, J, 1/16W	1	
	R211	ERJ3GEYJ221	M 220 OHM, J, 1/16W	1	
	R212	ERJ3GEYJ333	M 33KOHM, J, 1/16W	1	
	R213	ERJ3GEYJ223	M 22KOHM, J, 1/16W	1	
	R214	ERJ3GEYJ222	M 2.2KOHM, J, 1/16W	1	
	R215	ERJ3GEYD153V	M 15KOHM, J, 1/16W	1	
	R216	D0GB102JA057	M 1KOHM, J, 1/16W	1	
	R225	ERJ6GEYJ104V	M 100KOHM, J, 1/10W	1	
	R226	ERJ6GEYJ104V	M 100KOHM, J, 1/10W	1	
	R227	ERJ6ENF1001	M 1KOHM, 1/10W	1	
	R228	ERJ3GEYJ682	M 6.8KOHM, J, 1/16W	1	
	R229	ERJ3GEYJ472	M 4.7KOHM, J, 1/16W	1	
	R231	ERJ6GEYJ104V	M 100KOHM, J, 1/10W	1	
	R232	ERJ6GEYJ104V	M 100KOHM, J, 1/10W	1	
	R233	ERJ6ENF82R0	M 82 OHM, 1/10W	1	
	R234	ERJ6ENF47R0	M 47 OHM, 1/10W	1	
	R235	ERJ6GEYJ104V	M 100KOHM, J, 1/10W	1	
	R236	ARRCR2F1004T	METAL GLAZE FIXED RESISTOR	1	
	R251	ARRCR1F1503T	METAL GLAZE FIXED RESISTOR	1	
	R252	ARRCR1F1503T	METAL GLAZE FIXED RESISTOR	1	
	R253	ARRCR1F1503T	METAL GLAZE FIXED RESISTOR	1	
	R258	D0GB102JA057	M 1KOHM, J, 1/16W	1	
	R259	ERJ6GEYJ102V	M 1K OHM J 1/10W	1	
	R260	ERJ6GEYJ101V	M 100 OHM, J, 1/10W	1	
	R261	D0GB1R0JA057	CHIP RESISTOR	1	
	R262	ERJ6GEYG681	M 680 OHM, J, 1/10W	1	
	R264	ERJ6ENF4702	M 47KOHM, 1/10W	1	
	R265	ERJ6ENF4702	M 47KOHM, 1/10W	1	
	R266	ERJ6ENF4702	M 47KOHM, 1/10W	1	
	R267	ERJ6ENF4702	M 47KOHM, 1/10W	1	
	R268	ERJ6ENF2491	M2.49KOHM, 1/10W	1	
	R270	ERJ6ENF5492	M54.9KOHM, 1/10W	1	

Safety	Ref. No.	Part No.	Part Name & Description	Pcs	Remarks
	R271	ERJ6GEYJ2R7V	M 2.7 OHM,J,1/10W	1	
	R272	ERJ6GEYJ2R7V	M 2.7 OHM,J,1/10W	1	
	R273	ERJ6GEYJ2R7V	M 2.7 OHM,J,1/10W	1	
	R274	ERJ6GEYJ2R7V	M 2.7 OHM,J,1/10W	1	
	R275	ERJ6GEYJ2R7V	M 2.7 OHM,J,1/10W	1	
	R276	ERJ6GEYJ2R7V	M 2.7 OHM,J,1/10W	1	
	R277	ERJ6GEYJ2R7V	M 2.7 OHM,J,1/10W	1	
	R278	ERJ6GEYJ2R7V	M 2.7 OHM,J,1/10W	1	
	R279	ERJ6GEYJ2R7V	M 2.7 OHM,J,1/10W	1	
	R280	ERJ6GEYJ2R7V	M 2.7 OHM,J,1/10W	1	
	R281	ERJ6GEYJ2R7V	M 2.7 OHM,J,1/10W	1	
	R282	ERJ6GEYJ2R7V	M 2.7 OHM,J,1/10W	1	
	R283	ERJ6GEYJ2R7V	M 2.7 OHM,J,1/10W	1	
	R284	ERJ6GEYJ2R7V	M 2.7 OHM,J,1/10W	1	
	R285	ERJ6GEYJ2R7V	M 2.7 OHM,J,1/10W	1	
	R286	ERJ6GEYJ2R7V	M 2.7 OHM,J,1/10W	1	
	R287	ERJ6GEYJ511	M 510 OHM,J,1/10W	1	
	R300	ERJ6ENF4992	M49.9KOHM, 1/10W	1	
	R301	ERJ6ENF4992	M49.9KOHM, 1/10W	1	
	R302	ERJ6ENF4992	M49.9KOHM, 1/10W	1	
	R303	ERJ6ENF4992	M49.9KOHM, 1/10W	1	
	R304	ERJ6ENF4992	M49.9KOHM, 1/10W	1	
	R306	ERJ6GEYJ101V	M 100 OHM,J,1/10W	1	
	R307	ERJ6GEYJ101V	M 100 OHM,J,1/10W	1	
	R308	ERJ6GEYJ101V	M 100 OHM,J,1/10W	1	
	R309	ERJ6GEYJ101V	M 100 OHM,J,1/10W	1	
	R310	ERJ6GEYJ101V	M 100 OHM,J,1/10W	1	
	R311	ERJ6GEYJ101V	M 100 OHM,J,1/10W	1	
	R312	ERJ6GEYJ101V	M 100 OHM,J,1/10W	1	
	R313	ERJ6GEYJ101V	M 100 OHM,J,1/10W	1	
	R314	ERJ6GEYJ221V	M 220 OHM,J,1/10W	1	
	R315	ERJ6GEYJ221V	M 220 OHM,J,1/10W	1	
	R316	ERJ6GEYJ221V	M 220 OHM,J,1/10W	1	
	R317	ERJ6GEYJ221V	M 220 OHM,J,1/10W	1	
	R318	ERJ6GEYJ100V	M 10 OHM,J,1/10W	1	
	R319	ERJ6GEYJ221V	M 220 OHM,J,1/10W	1	
	R320	ERJ6GEYJ221V	M 220 OHM,J,1/10W	1	
	R321	ERJ6GEYJ221V	M 220 OHM,J,1/10W	1	
	R322	ERJ6GEYJ221V	M 220 OHM,J,1/10W	1	
	R323	ERJ6GEYJ100V	M 10 OHM,J,1/10W	1	
	R324	ERJ6GEYJ100V	M 10 OHM,J,1/10W	1	
	R325	ERJ6GEYJ100V	M 10 OHM,J,1/10W	1	
	R326	ERJ6GEYJ100V	M 10 OHM,J,1/10W	1	
	R327	ERJ6GEYJ221V	M 220 OHM,J,1/10W	1	
	R328	ERJ6GEYJ221V	M 220 OHM,J,1/10W	1	

Safety	Ref. No.	Part No.	Part Name & Description	Pcs	Remarks
	R329	ERJ6GEYJ100V	M 10 OHM,J,1/10W	1	
	R330	ERJ6GEYJ221V	M 220 OHM,J,1/10W	1	
	R331	ERJ6GEYJ221V	M 220 OHM,J,1/10W	1	
	R332	ERJ6GEYJ100V	M 10 OHM,J,1/10W	1	
	R333	ERJ6GEYJ100V	M 10 OHM,J,1/10W	1	
	R334	ERJ6GEYJ100V	M 10 OHM,J,1/10W	1	
	R335	ERJ6GEYJ100V	M 10 OHM,J,1/10W	1	
	R336	ERJ6GEYJ221V	M 220 OHM,J,1/10W	1	
	R337	ERJ6GEYJ221V	M 220 OHM,J,1/10W	1	
	R338	ERJ6GEYJ221V	M 220 OHM,J,1/10W	1	
	R339	ERJ6GEYJ221V	M 220 OHM,J,1/10W	1	
	R340	ERJ6GEYJ100V	M 10 OHM,J,1/10W	1	
	R341	ERJ6GEYJ100V	M 10 OHM,J,1/10W	1	
	R342	ERJ6GEYJ100V	M 10 OHM,J,1/10W	1	
	R343	ERJ6GEYJ100V	M 10 OHM,J,1/10W	1	
	R344	ERJ6GEYJ100V	M 10 OHM,J,1/10W	1	
	R345	ERJ6GEYJ100V	M 10 OHM,J,1/10W	1	
	R351	DOGB102JA057	M 1KOHM,J,1/16W	1	
	R352	DOGB102JA057	M 1KOHM,J,1/16W	1	
	R353	ERJ6GEYJ102V	M 1K OHM J 1/10W	1	
	R354	ERJ6GEYJ102V	M 1K OHM J 1/10W	1	
	R355	ERJ6GEYJ222V	M 2.2K OHM J 1/10W	1	
	R356	ERJ6ENF2672	M26.7KOHM, 1/10W	1	
	R357	ERJ6ENF2612	M26.1KOHM, 1/10W	1	
	R358	ERJ6ENF2491	M2.49KOHM, 1/10W	1	
	R359	ERJ6ENF1102	M 11KOHM, 1/10W	1	
	R360	ERJ12YJ473U	M 47KOHM,J, 1/2W	1	
	R361	ERJ12YJ473U	M 47KOHM,J, 1/2W	1	
	R362	ERJ12YJ473U	M 47KOHM,J, 1/2W	1	
	R363	ERJ12YJ473U	M 47KOHM,J, 1/2W	1	
	R371	ERJ6RND1782	CHIP RESISTOR	1	
	R372	ERJ6RND1001	CHIP RESISTOR	1	
	R374	ERJ6ENF3301	M 3.3KOHM, 1/10W	1	
	R375	ERJ6ENF8200	M 820 OHM, 1/10W	1	
	R383	ERJ6GEYJ223	M 22KOHM,J,1/10W	1	
	R384	ERJ6ENF3402	M 34KOHM, 1/10W	1	
	R385	ERJ6ENF3402	M 34KOHM, 1/10W	1	
	R386	ERJ6ENF1582	M15.8KOHM, 1/10W	1	
	R387	ERJ6ENF1582	M15.8KOHM, 1/10W	1	
	R389	ERJ3GEYJ104	M 100KOHM,J,1/16W	1	
	R390	ERJ3GEY0R00	M 0 OHM, 1/16W	1	
	R391	ERJ6GEYJ183V	M 18KOHM,J,1/10W	1	
	R392	ERJ6ENF3921	M3.92KOHM, 1/10W	1	
	R393	ERJ6GEYJ472V	M 4.7K OHM J 1/10W	1	
	R394	ERJ6ENF1002	M 10KOHM, 1/10W	1	
	R395	ERJ6GEYJ683V	M 68K OHM J 1/10W	1	
	R396	ERJ6GEYJ683V	M 68K OHM J 1/10W	1	
	R397	ERJ6GEYJ683V	M 68K OHM J 1/10W	1	
	R398	DOGB102JA057	M 1KOHM,J,1/16W	1	
	R501	ARRCR1F8253T	METAL GLAZE FIXED RESISTOR	1	
	R502	ARRCR1F8253T	METAL GLAZE FIXED RESISTOR	1	
	R503	ARRCR1F8253T	METAL GLAZE FIXED RESISTOR	1	
	R504	ARRCR1F8253T	METAL GLAZE FIXED RESISTOR	1	
	R505	ARRCR1F8253T	METAL GLAZE FIXED RESISTOR	1	
	R506	ARRCR1F8253T	METAL GLAZE FIXED RESISTOR	1	
	△ R507	ARRCR6J825M	METAL GLAZE FIXED RESISTOR	1	
	R508	ERJ3EKF1303	M 130KOHM, 1/16W	1	

Safety	Ref. No.	Part No.	Part Name & Description	Pcs	Remarks
	R509	D0GB103JA057	M 10K OHM J 1/16W	1	
	R510	D0GB183JA057	M 18K OHM J 1/16W	1	
	R511	ERJ3GEY0R00	M 0 OHM, 1/16W	1	
	R512	ERJ3GEYJ224	M 220KOHM,J,1/16W	1	
	R513	ERJ3GEYJ223	M 22KOHM,J,1/16W	1	
	R514	ERJ3EKF1303	M 130KOHM, 1/16W	1	
	R515	D0GB103JA057	M 10K OHM J 1/16W	1	
	R516	D0GB473JA057	M 47KOHM,J,1/16W	1	
	R517	ERJ3GEY0R00	M 0 OHM, 1/16W	1	
	R518	ERJ12YJ120	CHIP RESISTOR	1	
	R519	ERJ3GEYJ224	M 220KOHM,J,1/16W	1	
	R520	ERDS2FJ121	C 120 OHM, J,1/4W	1	
	R521	ERJ3GEYJ223	M 22KOHM,J,1/16W	1	
	R522	ERJ6GEYJ180	M 18 OHM,J,1/10W	1	
	R523	ERJ12YJ120	CHIP RESISTOR	1	
	R524	ERJ3GEYJ223	M 22KOHM,J,1/16W	1	
	R525	D0GB103JA057	M 10K OHM J 1/16W	1	
	R526	ERJ3GEYJ472	M 4.7KOHM,J,1/16W	1	
	R530	ERJ3GEYJ471	M 470 OHM,J,1/16W	1	
	R531	ERJ6ENF3303	M 330KOHM, 1/10W	1	
	R551	ERJ6GEYJ150V	M 15 OHM,J,1/10W	1	
	R552	ERJ3GEYJ472	M 4.7KOHM,J,1/16W	1	
	R553	D0GB102JA057	M 1KOHM,J,1/16W	1	
	R554	ERDS2FJ102	M 1KOHM,J,1/10W	1	
	R555	ERJ3EKF1072	CHIP RESISTOR	1	
	R556	ERJ3EKF1002	M 10KOHM, 1/16W	1	
	R557	ERJ3GEYD153V	M 15KOHM,J,1/16W	1	
	R558	ERJ6GEYF473	M 47KOHM,J,1/10W	1	
	R570	D0GB473JA057	M 47KOHM,J,1/16W	1	
	R573	ERJ3GEYJ332	M 3.3KOHM,J,1/16W	1	
	R574	ERG2SJ561H	M 560 OHM, J, 2W	1	
	R575	ERJ6GEYJ474	M 470KOHM,J,1/10W	1	
△	R601	ARRCR5J624M	METAL GLAZE FIXED RESISTOR	1	
	R603	ERJ6ENF8062	M80.6KOHM, 1/10W	1	
	R604	ERJ6ENF8062	M80.6KOHM, 1/10W	1	
	R605	ERJ6ENF8062	M80.6KOHM, 1/10W	1	
	R606	ERJ6ENF8062	M80.6KOHM, 1/10W	1	
	R607	ERJ3EKF3302	M 33KOHM, 1/16W	1	
	R608	ERJ3EKF2701	M 2.7KOHM, 1/16W	1	
	R609	ERJ3GEYJ104	M 100KOHM,J,1/16W	1	
	R610	ERJ3GEYJ100	M 10 OHM,J,1/16W	1	
	R611	ERJ3GEYJ100	M 10 OHM,J,1/16W	1	
	R612	ERJ3EKF3162	M31.6KOHM, 1/16W	1	
	R613	D0GB103JA057	M 10K OHM J 1/16W	1	
	R614	ERJ3GEYJ474	M 470KOHM,J,1/16W	1	
	R615	D0GB123JA057	M 12K OHM J 1/16W	1	
	R616	ARRF2EJR15B	METAL PLATE RESISTOR	1	
	R617	ARRF2EJR15B	METAL PLATE RESISTOR	1	
	R618	ARRF2EJR15B	METAL PLATE RESISTOR	1	
	R620	ERJ3EKF3302	M 33KOHM, 1/16W	1	
	R621	ERJ3EKF6041	M6.04KOHM, 1/16W	1	
	R622	ERJ3EKF3242	M32.4KOHM, 1/16W	1	
	R623	ERJ3EKF6191	M6.19KOHM, 1/16W	1	
	R624	ERJ6GEYJ472V	M 4.7K OHM J 1/10W	1	
	R625	ERDS2FJ101	C 100 OHM, J,1/4W	1	

Safety	Ref. No.	Part No.	Part Name & Description	Pcs	Remarks
	R627	ERDS2FJ154	C 150KOHM, J,1/4W	1	
	R629	ERG12SJ150J	METAL OXIDE FILM RESISTOR	1	
	R630	ERJ6GEYJ472V	M 4.7K OHM J 1/10W	1	
	R632	ERDS2FJ273	CARBON FILM RESISTOR	1	
	R633	ERDS2FJ273	CARBON FILM RESISTOR	1	
	R634	ARRCR1F4993T	METAL GLAZE FIXED RESISTOR	1	
	R635	ARRCR1F4993T	METAL GLAZE FIXED RESISTOR	1	
	R636	ARRCR1F4993T	METAL GLAZE FIXED RESISTOR	1	
	R637	ERJ6GEYJ183V	M 18KOHM,J,1/10W	1	
	R638	D0GB103JA057	M 10K OHM J 1/16W	1	
	R639	ARRCR1F5363T	METAL GLAZE FIXED RESISTOR	1	
	R640	ARRCR1F5363T	METAL GLAZE FIXED RESISTOR	1	
	R641	ARRCR1F5363T	METAL GLAZE FIXED RESISTOR	1	
	R642	ERJ6GEYF473	M 47KOHM,J,1/10W	1	
	R643	D0GB103JA057	M 10K OHM J 1/16W	1	
	R644	ERJ6ENF3303	M 330KOHM, 1/10W	1	
	R645	ERDS2FJ334	C 330KOHM, J,1/4W	1	
	R646	ARR5B100JC2	5W 10 OHM	1	
	R649	ERJ6ENF8062	M80.6KOHM, 1/10W	1	
	R650	ERJ6ENF8062	M80.6KOHM, 1/10W	1	
	R651	ERJ6GEYJ270	M 27 OHM,J,1/10W	1	
	R652	ERJ6GEYJ270	M 27 OHM,J,1/10W	1	
	R653	ERJ6GEYJ270	M 27 OHM,J,1/10W	1	
	R654	ERJ6GEYJ270	M 27 OHM,J,1/10W	1	
	R659	ERJ6GEYJ270	M 27 OHM,J,1/10W	1	
	R670	ERJ6GEYJ270	M 27 OHM,J,1/10W	1	
	R671	ERJ6GEYJ270	M 27 OHM,J,1/10W	1	
	R672	ERJ6GEYJ270	M 27 OHM,J,1/10W	1	
	R701	ERJ6GEYJ102V	M 1K OHM J 1/10W	1	
	R702	ERJ3GEYJ221	M 220 OHM,J,1/16W	1	
	R703	D0GB103JA057	M 10K OHM J 1/16W	1	
	R705	ERJ3GEYJ224	M 220KOHM,J,1/16W	1	
	R706	ERJ6GEYJ104V	M 100KOHM,J,1/10W	1	
	R707	D0GB103JA057	M 10K OHM J 1/16W	1	
	R708	D0GB103JA057	M 10K OHM J 1/16W	1	
	R711	ERJ3EKF4991	M4.99KOHM, 1/16W	1	
	R712	ERJ3EKF4991	M4.99KOHM, 1/16W	1	
	R713	ERJ3EKF4991	M4.99KOHM, 1/16W	1	
	R714	ERJ3GEYJ101	M 100 OHM,J,1/16W	1	
	R715	ERJ3GEYJ514	M 510KOHM,J,1/16W	1	
	R717	ERJ3GEYJ104	M 100KOHM,J,1/16W	1	
	R718	D0GB103JA057	M 10K OHM J 1/16W	1	
	R719	D0GB103JA057	M 10K OHM J 1/16W	1	
	R720	D0GB103JA057	M 10K OHM J 1/16W	1	
	R721	D0GB103JA057	M 10K OHM J 1/16W	1	
	R722	D0GB103JA057	M 10K OHM J 1/16W	1	
	R723	D0GB103JA057	M 10K OHM J 1/16W	1	
	R724	D0GB152JA057	M 1.5KOHM J 1/16W	1	

Safety	Ref. No.	Part No.	Part Name & Description	Pcs	Remarks
	R725	D0GB152JA057	M 1.5KOHM J 1/16W	1	
	R731	ERJ3GEYJ471	M 470 OHM,J,1/16W	1	
	R733	D0GB103JA057	M 10K OHM J 1/16W	1	
	R734	D0GB103JA057	M 10K OHM J 1/16W	1	
	R736	ERJ3GEYJ821	M820 OHM,J,1/16W	1	
	R738	D0GB102JA057	M 1KOHM,J,1/16W	1	
	R740	ERJ3GEYJ821	M820 OHM,J,1/16W	1	
	R741	D0GB103JA057	M 10K OHM J 1/16W	1	
	R742	ERJ3GEYJ821	M820 OHM,J,1/16W	1	
	R743	ERJ3GEYJ471	M 470 OHM,J,1/16W	1	
	R744	ERJ3GEYJ101	M 100 OHM,J,1/16W	1	
	R745	ERJ3GEYJ101	M 100 OHM,J,1/16W	1	
	R746	ERJ3GEYJ101	M 100 OHM,J,1/16W	1	
	R747	D0GB102JA057	M 1KOHM,J,1/16W	1	
	R748	D0GB103JA057	M 10K OHM J 1/16W	1	
	R749	ERJ3GEYJ221	M 220 OHM,J,1/16W	1	
	R750	ERJ3GEYJ221	M 220 OHM,J,1/16W	1	
	R751	D0GB102JA057	M 1KOHM,J,1/16W	1	
	R752	ERJ6GEYJ1R0	M 1 OHM,J,1/10W	1	
	R753	ERJ6GEYJ1R0	M 1 OHM,J,1/10W	1	
△	RF501	HUA5MC100JP2	THERMAL CUTOFF WITH RESISTOR	1	
△	RF601	HUY5JA200JP	W 20 OHM, J, 5W	1	
△	T201	ETB42BJ15GAD	TRANSFORMER	1	
△	T301	ETB35BC28GAD	TRANSFORMER	1	
△	T501	ETB29AK1L8AD	TRANSFORMER	1	
	VR251	EVMEASA01B15	VARIABLE RESISTOR	1	
	VR351	EVMEASA01B54	VARIABLE RESISTOR	1	
△	Z601	ERZVGED751	VARISTOR	1	
△	Z602	ERZVGAD471	VARISTOR	1	
	ZD353	MA4120NM	ZENER DIODE	1	
	ZD354	MAZ4068NMF	ZENER DIODE	1	
	ZD501	MA4300NMTA	ZENER DIODE	1	
	ZD502	MA4300NMTA	ZENER DIODE	1	
	ZD503	MA4300NMTA	ZENER DIODE	1	
	ZD504	MA4150NMTA	ZENER DIODE	1	
	ZD505	MA4300NMTA	ZENER DIODE	1	
	ZD506	MA4220NM	ZENER DIODE	1	
	ZD507	MA4082NM	ZENER DIODE	1	
	ZD508	MA4150NMTA	ZENER DIODE	1	
	ZD552	MA4062NM	ZENER DIODE	1	
	ZD601	MA4051NM	ZENER DIODE	1	
	ZD602	MA4047NM	ZENER DIODE	1	
	ZD701	MA4036H	ZENER DIODE	1	
	ZD702	MA4036H	ZENER DIODE	1	