

Model No. : TX-P50GT30E/J Parts List

Safety	Ref. No.	Part No.	Part Name & Description	Q'ty	Remarks
	PCB	A-P50GT30E	CIRCUIT BOARD A	1	(RTL) PAVCCZ P50GT30E
	PCB	A-P50GT30J	CIRCUIT BOARD A	1	(RTL) PAVCCZ P50GT30J
	PCB	TXNP21PNUB	CIRCUIT BOARD P2	1	(RTL) PAVCCZ
	PCB	TXNP11QJUE	CIRCUIT BOARD P	1	(RTL)
	PCB	TXN/K1RLUE	CIRCUIT BOARD K	1	(RTL) PAVCCZ
	PCB	TXN/S1QNUe	CIRCUIT BOARD S	1	(RTL) PAVCCZ
	PCB	TXN/V1QNUe	CIRCUIT BOARD V	1	(RTL) PAVCCZ
	PCB	TNPA5318	CIRCUIT BOARD C1	1	(RTL)
	PCB	TXNC21MPUC	CIRCUIT BOARD C2	1	(RTL) PAVCCZ
	PCB	TXNC31MPUC	CIRCUIT BOARD C3	1	(RTL) PAVCCZ
	PCB	TXNSC1MPUC	CIRCUIT BOARD SC	1	(RTL) PAVCCZ
	PCB	TNPA5337	CIRCUIT BOARD SD	1	
	PCB	TXNSS1MPUC	CIRCUIT BOARD SS	1	(RTL) PAVCCZ
	PCB	TXNSS21MPUC	CIRCUIT BOARD SS2	1	(RTL) PAVCCZ
	PCB	TXNSU1MPUC	CIRCUIT BOARD SU	1	PAVCCZ
	A1	K1KY08AA0719	8P CONNECTOR	1	
	A6	K1KY15B00006	15P CONNECTOR	1	PAVCCZ
	A8	K1KY12AA0719	12P CONNECTOR	1	
	A11	K1KY04B00013	4P CONNECTOR	1	PAVCCZ
	A14	K1KY06AA0719	6P CONNECTOR	1	
	A20	K1MY35BA0345	35P CONNECTOR	1	
	A31	K1MY55BA0345	55P CONNECTOR	1	
	A32	K1MY55BA0345	55P CONNECTOR	1	
	A40	K1MN20BA0231	20P CONNECTOR	1	
	C101	F0CAF334A105	C 0.33UF, 250V	1	PAVCCZ
	C102	F1BAF221A088	C 220PF, 250V	1	PAVCCZ
	C103	F1BAF221A088	C 220PF, 250V	1	PAVCCZ
	C104	F0CAF334A105	C 0.33UF, 250V	1	PAVCCZ
	C106	F1H1H472A970	C 4700PF, , 50V	1	
	C111	F1H1H102A971	C 1000PF, 50V	1	
	C112	F1H1H103A970	C 0.01 uF 50 V	1	
	C192	F1BAF471A088	C 470PF, 250V	1	PAVCCZ
	C201	FOC2H1050001	C 1.5 UF 50 V	1	PAVCCZ
	C202	FOC2H1050001	C 1.5 UF 50 V	1	PAVCCZ
	C205	F1H1C105A148	C 1UF, 16V	1	
	C206	F1H1H104A970	C 0.1UF, , 50V	1	
	C207	F1H1H681A971	C 680PF, 50V	1	
	C208	F1H1E1050008	C 1U 25V	1	PAVCCZ
	C209	F1H1H104A970	C 0.1UF, , 50V	1	
	C210	F1H1H102A971	C 1000PF, 50V	1	
	C211	F1H1E1050008	C 1U 25V	1	PAVCCZ
	C212	F1H1H102A971	C 1000PF, 50V	1	
	C213	F1H1H102A971	C 1000PF, 50V	1	
	C214	ECA1HHG010	E 1UF, 50V	1	
	C215	F1H1H104A970	C 0.1UF, , 50V	1	
	C220	F1A3A471A060	C 470PF 1KV	1	PAVCCZ
	C221	F1A3A471A060	C 470PF 1KV	1	PAVCCZ
	C222	F2A2W1010010	E 100UF 450V	1	PAVCCZ
	C223	F2A2W1010010	E 100UF 450V	1	PAVCCZ
	C224	F2A2W1010010	E 100UF 450V	1	PAVCCZ
	C225	F1A3A471A060	C 470PF 1KV	1	PAVCCZ
	C226	F1A3A471A060	C 470PF 1KV	1	PAVCCZ
	C301	F1H1E473A029	C 047PF 25V	1	PAVCCZ
	C302	ECA1HHG010	E 1UF, 50V	1	
	C303	F1H1H104A970	C 0.1UF, , 50V	1	
	C305	F2A1H2R2A122	E 2.2UF, 50V	1	
	C306	F1H1H332A970	C 3300PF, 50V	1	PAVCCZ
	C307	F1K1E225A085	C 2.2UF, 25V	1	
	C308	F1H1H681A971	C 680PF, 50V	1	
	C309	F1H1H101A971	C 100PF, 50V	1	

Model No. : TX-P50GT30E/J Parts List

Safety	Ref. No.	Part No.	Part Name & Description	Q'ty	Remarks
	C310	F1K2J681A017	C 680PF ,630V	1	PAVCCZ
	C311	F1K2J1500001	C 15PF, 630V	1	PAVCCZ
	C312	F1K2J1500001	C 15PF, 630V	1	PAVCCZ
	C313	F1H1H104A970	C 0.1UF, , 50V	1	
	C314	F1A3A471A060	C 470PF 1KV	1	PAVCCZ
	C315	F1H1C474A143	C 0.47UF, 16V	1	
	C316	ECWH8473HA	P 0.033UF 800V	1	
	C317	ECWH8473HA	P 0.033UF 800V	1	
	C321	F1K2J681A017	C 680PF ,630V	1	PAVCCZ
	C322	F1K2J1500001	C 15PF, 630V	1	PAVCCZ
	C323	F1K2J681A017	C 680PF ,630V	1	PAVCCZ
	C351	F2A2E2910001	E 290UF, 250V	1	PAVCCZ
	C352	F2A2E2910001	E 290UF, 250V	1	PAVCCZ
	C353	F2A2E2910001	E 290UF, 250V	1	PAVCCZ
	C354	FOC2E103A070	C 0.010UF, 250V	1	PAVCCZ
	C355	F1H1H104A970	C 0.1UF, , 50V	1	
	C358	F2A1H101A118	E 100UF, 50V	1	
	C359	F1H1H104A970	C 0.1UF, , 50V	1	
	C360	F1K1V1050001	C 1UF, 35V	1	PAVCCZ
	C361	F2A1H1000089	E 10UF, 50V	1	PAVCCZ
	C362	F2A1J1820001	C 1800UF ,63V	1	PAVCCZ
	C363	F1K1E225A085	C 2.2UF, 25V	1	
	C364	F1H1H104A970	C 0.1UF, , 50V	1	
	C365	F1H1H102A971	C 1000PF, 50V	1	
	C366	F2A1H4R7A794	E 4.7UF, 50V	1	PAVCCZ
	C367	F2A1J1820001	C 1800UF ,63V	1	PAVCCZ
	C368	F2A1J1820001	C 1800UF ,63V	1	PAVCCZ
	C370	F1K2A474A006	C 0.47UF, 100V	1	
	C372	FOC2E104A070	C 0.10UF, 250V	1	PAVCCZ
	C373	ECKD3A102KBP	C 1000PF, 1KV	1	
	C374	F1H1E1050008	C 1U 25V	1	PAVCCZ
	C376	F2A1J1820001	C 1800UF ,63V	1	PAVCCZ
	C378	ECKD3A102KBP	C 1000PF, 1KV	1	
	C379	ECKD3A102KBP	C 1000PF, 1KV	1	
	C401	F2A2W4700020	E 47UF 450V	1	PAVCCZ
	C403	F2A1H2200060	E 22UF, 50V	1	PAVCCZ
	C404	F1B3D331A011	C 330P 2000V	1	
	C405	F1H1H104A970	C 0.1UF, , 50V	1	
	C406	F1K1E225A085	C 2.2UF, 25V	1	
	C407	F1H1H222A970	C 2200PF, 50V	1	
	C408	F1H1H101A971	C 100PF, 50V	1	
	C410	F1B3A222A009	C 2200U 1000V	1	PAVCCZ
	C411	F1K1V1050001	C 1UF, 35V	1	PAVCCZ
	C452	F2A1E6810033	E 680UF 25V	1	PAVCCZ
	C453	F2A1E6810033	E 680UF 25V	1	PAVCCZ
	C454	F2A1E6810033	E 680UF 25V	1	PAVCCZ
	C455	F2A1E6810033	E 680UF 25V	1	PAVCCZ
	C456	F1H1H104A970	C 0.1UF, , 50V	1	
	C457	F1H1E473A029	C 047PF 25V	1	PAVCCZ
	C458	F1H1H104A970	C 0.1UF, , 50V	1	
	C459	F1H1C105A148	C 1UF, 16V	1	
	C460	F1H1C334A143	C 0.3UF. 16V	1	PAVCCZ
	C461	F1H1H104A970	C 0.1UF, , 50V	1	
	C462	F1H1C474A143	C 0.47UF, 16V	1	
	C463	F1H1H104A970	C 0.1UF, , 50V	1	
	C464	F1H1H102A971	C 1000PF, 50V	1	
	C465	F1H1H102A971	C 1000PF, 50V	1	
	C467	F1K1V1050001	C 1UF, 35V	1	PAVCCZ
	C468	F2A1V3310067	C 150UF 35V	1	PAVCCZ
	C469	F1H1C105A148	C 1UF, 16V	1	
	C470	F1H1H472A970	C 4700PF, , 50V	1	
	C471	F1H1H222A970	C 2200PF, 50V	1	

Model No. : TX-P50GT30E/J Parts List

Safety	Ref. No.	Part No.	Part Name & Description	Q'ty	Remarks
	C472	F1H1C105A148	C 1UF, 16V	1	
	C473	ECKD3A102KBP	C 1000PF, 1KV	1	
	C474	F2A1H101A118	E 100UF, 50V	1	
	C476	F1K1E684A130	C 0.68UF, 25V	1	PAVCCZ
	C478	F1H1H104A970	C 0.1UF, , 50V	1	
	C479	F1H1H104A970	C 0.1UF, , 50V	1	
	C480	F1K1V1050001	C 1UF, 35V	1	PAVCCZ
	C490	F1K2J102A014	C 1000PF, 630V	1	
	C501	F2A1H101A118	E 100UF, 50V	1	
	C502	F1H1H104A970	C 0.1UF, , 50V	1	
	C505	F2A1H101A118	E 100UF, 50V	1	
	C551	F1K1E684A130	C 0.68UF, 25V	1	PAVCCZ
	C552	F1J1E224A227	C 0.22UF, 25V	1	
	C553	F1H1H102A971	C 1000PF, 50V	1	
	C554	F2A1H2200060	E 22UF, 50V	1	PAVCCZ
	C555	F1H1C105A148	C 1UF, 16V	1	
	C556	F1H1H104A970	C 0.1UF, , 50V	1	
	C557	F1H1C105A148	C 1UF, 16V	1	
	C558	F1H1C474A143	C 0.47UF, 16V	1	
	C601	F1H1H104A970	C 0.1UF, , 50V	1	
	C602	F1J1A4750009	C 4.7UF, 10V	1	PAVCCZ
	C651	F2A1H2200060	E 22UF, 50V	1	PAVCCZ
	C652	F1H1H104A970	C 0.1UF, , 50V	1	
	C654	F1K1E4750002	C 4.7UF, 25V	1	
	C655	F1H1H103A970	C 0.01 uF 50 V	1	
	C659	F1H1H102A971	C 1000PF, 50V	1	
	C701	F1H1H102A971	C 1000PF, 50V	1	
	C702	F1H1H102A971	C 1000PF, 50V	1	
	C0900	F1G1H101A565	C 100PF 50V	1	
	C0901	F1G1H101A565	C 100PF 50V	1	
	C0902	F1G1H101A565	C 100PF 50V	1	
	C0903	F1G1H101A565	C 100PF 50V	1	
	C2000	F1G1E1030005	C 0.01UF 25V	1	
	C2003	F1J1A106A087	C 10UF, 10V	1	
	C2004	F1J1E105A231	C 1 UF 25V	1	
	C2010	F1G1C104A077	C 0.1UF 16V	1	
	C2752	F1G1E1030005	C 0.01UF 25V	1	
	C2753	F1G1A105A047	C 1UF 10V	1	
	C2810	ECJ1VB1H103K	C 0.01UF, 50V	1	
	C2811	F1J1A106A087	C 10UF, 10V	1	
	C2815	ECJ1VB1H103K	C 0.01UF, 50V	1	
	C2821	ECJ1XB1C104K	C 0.1UF, Z, 16V	1	
	C2850	F1G1A473A032	C0.047UF, 10V	1	
	C2851	F1G1A473A032	C0.047UF, 10V	1	
	C2852	F1G1A473A032	C0.047UF, 10V	1	
	C2853	F1G1A473A032	C0.047UF, 10V	1	
	C3001	F1G1A105A047	C 1UF 10V	1	
	C3002	F1G1A105A047	C 1UF 10V	1	
	C3003	F1G1C104A077	C 0.1UF 16V	1	
	C3004	F1G1C104A077	C 0.1UF 16V	1	
	C3005	F1G1A105A047	C 1UF 10V	1	
	C3006	F1G1A105A047	C 1UF 10V	1	
	C3011	F1J1A106A043	C 10UF, 10V	1	
	C3016	F1G1C104A077	C 0.1UF 16V	1	
	C3018	F1G1C104A077	C 0.1UF 16V	1	
	C3019	F1G1C104A077	C 0.1UF 16V	1	
	C3020	F1J1A106A043	C 10UF, 10V	1	
	C3084	F1J1A106A043	C 10UF, 10V	1	
	C3085	F1J1A106A043	C 10UF, 10V	1	
	C3086	F1J1A106A043	C 10UF, 10V	1	
	C3105	F1G1H5610004	C 560 pF 50 V	1	PAVCCZ
	C3106	F1G1H5610004	C 560 pF 50 V	1	PAVCCZ

Model No. : TX-P50GT30E/J Parts List

Safety	Ref. No.	Part No.	Part Name & Description	Q'ty	Remarks
	C3108	FIG1E333A091	C 0.033UF 25V	1	
	C3109	FIG1E333A091	C 0.033UF 25V	1	
	C3111	FIG1A105A047	C 1UF 10V	1	
	C3112	FIG1A105A047	C 1UF 10V	1	
	C3113	FIG1A106A043	C 10UF, 10V	1	
	C3120	F2H1A101A040	C 100UF, 10V	1	PAVCCZ
	C3121	F2H1A101A040	C 100UF, 10V	1	PAVCCZ
	C3124	FIG1A106A087	C 10UF, 10V	1	
	C3130	FIG1A106A043	C 10UF, 10V	1	
	C3131	FIG1A106A043	C 10UF, 10V	1	
	C3132	FIG1A106A043	C 10UF, 10V	1	
	C3135	FIG1H5610004	C 560 pF 50 V	1	PAVCCZ
	C3136	FIG1H5610004	C 560 pF 50 V	1	PAVCCZ
	C3139	FIG1H5610004	C 560 pF 50 V	1	PAVCCZ
	C3140	FIG1H5610004	C 560 pF 50 V	1	PAVCCZ
	C3145	FIG1A106A043	C 10UF, 10V	1	
	C3146	FIG1A106A043	C 10UF, 10V	1	
	C3147	FIG1A106A043	C 10UF, 10V	1	
	C3148	FIG1A106A043	C 10UF, 10V	1	
	C3151	FIG1A105A047	C 1UF 10V	1	
	C3152	FIG1A105A047	C 1UF 10V	1	
	C3153	FIG1H5610004	C 560 pF 50 V	1	PAVCCZ
	C3154	FIG1H5610004	C 560 pF 50 V	1	PAVCCZ
	C3159	FIG1A106A043	C 10UF, 10V	1	
	C3160	FIG1A106A043	C 10UF, 10V	1	
	C3161	FIG1A106A043	C 10UF, 10V	1	
	C3162	FIG1A106A043	C 10UF, 10V	1	
	C3163	FIG1A106A043	C 10UF, 10V	1	
	C3166	FIG1H1020008	C 1000PF 50V	1	
	C3172	FIG1A105A047	C 1UF 10V	1	
	C3173	FIG1A105A047	C 1UF 10V	1	
	C3174	FIG1A105A047	C 1UF 10V	1	
	C3175	FIG1A105A047	C 1UF 10V	1	
	C3178	FIG1A106A043	C 10UF, 10V	1	
	C3179	FIG1A106A043	C 10UF, 10V	1	
	C3851	ECJ1VB1A105K	C 1UF, 10V	1	
	C4546	FIG1A105A047	C 1UF 10V	1	
	C4551	ECJ1VB0J105K	C 1UF, 6.3V	1	
	C4713	FIG1C104A077	C 0.1UF 16V	1	
	C4716	FIG1C104A077	C 0.1UF 16V	1	
	C4717	FIG1A106A087	C 10UF, 10V	1	
	C4718	FIG1A475A087	C 4.7UF, 10V	1	
	C4719	FIG1C104A077	C 0.1UF 16V	1	
	C4721	FIG1C104A077	C 0.1UF 16V	1	
	C4722	FIG1C104A077	C 0.1UF 16V	1	
	C4723	FIG1C104A077	C 0.1UF 16V	1	
	C4727	FIG1A106A087	C 10UF, 10V	1	
	C4800	FIG1A105A047	C 1UF 10V	1	
	C4801	FIG1A105A047	C 1UF 10V	1	
	C4804	FIG1C104A077	C 0.1UF 16V	1	
	C4805	FIG1C104A077	C 0.1UF 16V	1	
	C4808	FIG1C104A077	C 0.1UF 16V	1	
	C4809	FIG1A106A043	C 10UF, 10V	1	
	C4813	FIG1C104A077	C 0.1UF 16V	1	
	C4816	FIG1H220A565	C 22PF, 50V	1	
	C4817	FIG1H330A565	C 33PF, 50V	1	
	C4818	FIG1H330A565	C 33PF, 50V	1	
	C4820	FIG1E105A231	C 1 UF 25V	1	
	C4821	ECJ1VB1A105K	C 1UF, 10V	1	
	C4822	FIG1H1020008	C 1000PF 50V	1	
	C4830	FIG1H101A565	C 100PF 50V	1	
	C4831	FIG1H101A565	C 100PF 50V	1	

Model No. : TX-P50GT30E/J Parts List

Safety	Ref. No.	Part No.	Part Name & Description	Q'ty	Remarks
	C4898	FIG1H150A565	C 15PF, 50V	1	
	C4899	FIG1H150A565	C 15PF, 50V	1	
	C4900	ECJ1XC1H102J	C 1000PF, J, 50V	1	
	C4901	FIG1C104A077	C 0.1UF 16V	1	
	C4902	FIG1H1020008	C 1000PF 50V	1	
	C4903	FIG1C104A077	C 0.1UF 16V	1	
	C4908	FIG1H1020008	C 1000PF 50V	1	
	C4909	FIG1E105A231	C 1 UF 25V	1	
	C4910	FIG1E106A136	C 10UF, 25V	1	
	C4911	FIG1H104A970	C 0.1UF, , 50V	1	
	C4912	FIG1E105A231	C 1 UF 25V	1	
	C4913	FIG1H104A970	C 0.1UF, , 50V	1	
	C4914	FIG1E105A231	C 1 UF 25V	1	
	C4915	FIG1H104A970	C 0.1UF, , 50V	1	
	C4916	FIG1E106A136	C 10UF, 25V	1	
	C4917	FIG1H104A970	C 0.1UF, , 50V	1	
	C4918	FIG1E105A231	C 1 UF 25V	1	
	C4919	FIG1H1020008	C 1000PF 50V	1	
	C4921	FIG1E4740001	C 0.47UF, 25V	1	PAVCCZ
	C4922	FIG1E4740001	C 0.47UF, 25V	1	PAVCCZ
	C4924	FIG1E4740001	C 0.47UF, 25V	1	PAVCCZ
	C4925	FIG1E4740001	C 0.47UF, 25V	1	PAVCCZ
	C4934	FIG1H1020008	C 1000PF 50V	1	
	C4935	FIG1H1020008	C 1000PF 50V	1	
	C4936	FIG1H1020008	C 1000PF 50V	1	
	C4937	FIG1H1020008	C 1000PF 50V	1	
	C4938	FIG1E106A136	C 10UF, 25V	1	
	C4939	FIG1E106A136	C 10UF, 25V	1	
	C4970	FIG1A106A087	C 10UF, 10V	1	
	C4971	FIG1A106A087	C 10UF, 10V	1	
	C4972	FIG2H1A101A040	C 100UF, 10V	1	PAVCCZ
	C4973	FIG2H1A101A040	C 100UF, 10V	1	PAVCCZ
	C4974	FIG1E333A091	C 0.033UF 25V	1	
	C4975	FIG1E333A091	C 0.033UF 25V	1	
	C5000	FIG1E1030005	C 0.01UF 25V	1	
	C5002	FIG1E106A136	C 10UF, 25V	1	
	C5003	FIG1H105A145	C 1 uF 16 V	1	
	C5007	FIG1C104A077	C 0.1UF 16V	1	
	C5009	FIG1C104A077	C 0.1UF 16V	1	
	C5011	FIG1C104A077	C 0.1UF 16V	1	
	C5012	EEEHB1C101UF	C 100PF, J, 16V	1	
	C5013	ECJ1VB1A105K	C 1UF, 10V	1	
	C5014	ECJ1VB1A105K	C 1UF, 10V	1	
	C5015	ECJ1VB1A105K	C 1UF, 10V	1	
	C5016	ECJ1VB1A105K	C 1UF, 10V	1	
	C5017	ECJ1VB1A105K	C 1UF, 10V	1	
	C5018	FIG1C104A077	C 0.1UF 16V	1	
	C5020	FIG1E1030005	C 0.01UF 25V	1	
	C5200	FIG1E106A136	C 10UF, 25V	1	
	C5201	FIG1C104A077	C 0.1UF 16V	1	
	C5202	FIG1A106A043	C 10UF, 10V	1	
	C5203	FIG1C104A077	C 0.1UF 16V	1	
	C5204	FIG1A106A043	C 10UF, 10V	1	
	C5205	FIG1E6820007	C 6800pF 25V	1	
	C5449	FIG1H103A509	C 0.01PF, 50V	1	PAVCCZ
	C5452	FIG1A106A043	C 10UF, 10V	1	
	C5453	FIG1A106A043	C 10UF, 10V	1	
	C5454	FIG1A106A043	C 10UF, 10V	1	
	C5455	FIG1E106A136	C 10UF, 25V	1	
	C5456	FIG1E106A136	C 10UF, 25V	1	
	C5457	FIG1H821A459	C 820 pF 50 V	1	PAVCCZ
	C5900	FIG1A106A043	C 10UF, 10V	1	

Model No. : TX-P50GT30E/J Parts List

Safety	Ref. No.	Part No.	Part Name & Description	Q'ty	Remarks
	C5901	FIJ1A106A043	C 10UF, 10V	1	
	C5902	FIJ1A106A043	C 10UF, 10V	1	
	C5905	FIG1C223A081	C 0.022UF, 16V	1	
	C5906	FIK1E106A136	C 10UF, 25V	1	
	C5908	FIG1A333A032	CO.033UF, 10V	1	
	C5909	FIG1H1020008	C 1000PF 50V	1	
	C5911	FIJ1A106A043	C 10UF, 10V	1	
	C5912	FIG1E472A086	C 4700pF 25V	1	
	C5913	FIG1A473A032	CO.047UF, 10V	1	
	C5915	FIG1A473A032	CO.047UF, 10V	1	
	C5917	FIG1A473A032	CO.047UF, 10V	1	
	C5919	FIG1A473A032	CO.047UF, 10V	1	
	C5921	FIG1H1020008	C 1000PF 50V	1	
	C5923	ECJ1VB1A105K	C 1UF, 10V	1	
	C6776	FIJ1A106A087	C 10UF, 10V	1	
	C6778	FIJ1A106A087	C 10UF, 10V	1	
	C6780	FIJ1A106A087	C 10UF, 10V	1	
	C6781	FIJ0G2260001	C 22 UF 4 V	1	
	C6782	FIJ0G2260001	C 22 UF 4 V	1	
	C6787	FIJ1A106A087	C 10UF, 10V	1	
	C6788	FIJ1A106A087	C 10UF, 10V	1	
	C6789	FIG1C1030008	C 0.01UF 16V	1	
	C6790	FIK1E106A136	C 10UF, 25V	1	
	C6791	FIG1C1030008	C 0.01UF 16V	1	
	C6792	FIG1E392A123	C 3900pF 25V	1	
	C6793	ECJ1VB1E104K	C 0.1 UF, 25V	1	
	C6808	FIJ1E105A171	C 1 UF 25V	1	
	C6809	ECJ1VB1A105K	C 1UF, 10V	1	
	C6810	FIG1H152A571	C 1500PF, 50V	1	
	C6811	FIH1H473A918	C 0.047UF, 50V	1	PAVCCZ
	C6812	FIG1C104A077	C 0.1UF 16V	1	
	C6813	FIJ1E2240015	C 0.22UF, 25V	1	PAVCCZ
	C6814	F2G1E1010028	E 100PF, 25V	1	PAVCCZ
	C6815	EEEEPE101XAP	C 100UF, Z, 25V	1	PAVCCZ
	C6816	FIG1H471A731	C 470PF, 50V	1	
	C6817	FIK1E106A136	C 10UF, 25V	1	
	C6818	FIK1E106A136	C 10UF, 25V	1	
	C6819	FIK1E106A136	C 10UF, 25V	1	
	C6830	ECJ1XC1H102J	C 1000PF, J, 50V	1	
	C6925	FIG1C104A077	C 0.1UF 16V	1	
	C8001	FIG1C104A077	C 0.1UF 16V	1	
	C8002	FIJ1A106A087	C 10UF, 10V	1	
	C8003	FIG1C104A077	C 0.1UF 16V	1	
	C8004	FIG1C104A077	C 0.1UF 16V	1	
	C8005	FIG1C104A077	C 0.1UF 16V	1	
	C8006	FIG1C104A077	C 0.1UF 16V	1	
	C8007	FIG1C104A077	C 0.1UF 16V	1	
	C8008	FIG1C104A077	C 0.1UF 16V	1	
	C8009	FIJ1A106A087	C 10UF, 10V	1	
	C8011	FIG1C104A077	C 0.1UF 16V	1	
	C8013	FIG1C104A077	C 0.1UF 16V	1	
	C8014	FIG1C104A077	C 0.1UF 16V	1	
	C8015	FIG1C104A077	C 0.1UF 16V	1	
	C8016	FIG1C104A077	C 0.1UF 16V	1	
	C8017	FIJ1A106A087	C 10UF, 10V	1	
	C8018	FIG1C104A077	C 0.1UF 16V	1	
	C8019	FIG1C104A077	C 0.1UF 16V	1	
	C8020	FIG1C104A077	C 0.1UF 16V	1	
	C8021	FIG1C104A077	C 0.1UF 16V	1	
	C8022	FIJ1A106A087	C 10UF, 10V	1	
	C8023	FIJ1A106A087	C 10UF, 10V	1	
	C8024	FIJ0G2260001	C 22 UF 4 V	1	

Model No. : TX-P50GT30E/J Parts List

Safety	Ref. No.	Part No.	Part Name & Description	Q'ty	Remarks
	C8026	FIG1C104A077	C 0.1UF 16V	1	
	C8027	FIG1C104A077	C 0.1UF 16V	1	
	C8028	FIG1C104A077	C 0.1UF 16V	1	
	C8030	FIG1C104A077	C 0.1UF 16V	1	
	C8032	FIG1C104A077	C 0.1UF 16V	1	
	C8036	FIG1C104A077	C 0.1UF 16V	1	
	C8039	FIG1C104A077	C 0.1UF 16V	1	
	C8041	FIG1H1020008	C 1000PF 50V	1	
	C8042	FIG1C104A077	C 0.1UF 16V	1	
	C8043	FIG1C104A077	C 0.1UF 16V	1	
	C8044	FIG1C104A077	C 0.1UF 16V	1	
	C8045	FIG1C104A077	C 0.1UF 16V	1	
	C8047	FIG1C104A077	C 0.1UF 16V	1	
	C8048	FIG1C104A077	C 0.1UF 16V	1	
	C8049	FIG1A106A087	C 10UF, 10V	1	
	C8050	FIG1C104A077	C 0.1UF 16V	1	
	C8051	FIG1A106A087	C 10UF, 10V	1	
	C8052	FIG1C104A077	C 0.1UF 16V	1	
	C8053	FIG1C104A077	C 0.1UF 16V	1	
	C8054	FIG1C104A077	C 0.1UF 16V	1	
	C8055	FIG1C104A077	C 0.1UF 16V	1	
	C8056	FIG1C104A077	C 0.1UF 16V	1	
	C8057	FIG1C104A077	C 0.1UF 16V	1	
	C8100	FIG1E682A123	C 6800 pF 25 V	1	
	C8102	FIG1A475A087	C 4.7UF, 10V	1	
	C8104	FIG1H105A145	C 1 uF 16 V	1	
	C8106	FIG1C223A081	C 0.022UF, 16V	1	
	C8108	FIG1C104A077	C 0.1UF 16V	1	
	C8110	FIG1C104A077	C 0.1UF 16V	1	
	C8112	FIG1E106A136	C 10UF, 25V	1	
	C8114	FIG1E106A136	C 10UF, 25V	1	
	C8116	FIG1E106A136	C 10UF, 25V	1	
	C8118	FIG1E106A136	C 10UF, 25V	1	
	C8120	FIG1J0G2260001	C 22 UF 4 V	1	
	C8122	FIG1J0G2260001	C 22 UF 4 V	1	
	C8124	FIG1J0G2260001	C 22 UF 4 V	1	
	C8126	FIG1J0G2260001	C 22 UF 4 V	1	
	C8128	FIG1J0G2260001	C 22 UF 4 V	1	
	C8200	FIG1C104A077	C 0.1UF 16V	1	
	C8201	FIG1C104A077	C 0.1UF 16V	1	
	C8202	FIG1C104A077	C 0.1UF 16V	1	
	C8203	FIG1C104A077	C 0.1UF 16V	1	
	C8204	FIG1C104A077	C 0.1UF 16V	1	
	C8205	FIG1A106A087	C 10UF, 10V	1	
	C8206	FIG1C104A077	C 0.1UF 16V	1	
	C8208	FIG1C104A077	C 0.1UF 16V	1	
	C8210	FIG1C104A077	C 0.1UF 16V	1	
	C8213	FIG1C104A077	C 0.1UF 16V	1	
	C8214	FIG1A106A087	C 10UF, 10V	1	
	C8216	FIG1C104A077	C 0.1UF 16V	1	
	C8218	FIG1C104A077	C 0.1UF 16V	1	
	C8219	FIG1C104A077	C 0.1UF 16V	1	
	C8222	FIG1C104A077	C 0.1UF 16V	1	
	C8223	FIG1C104A077	C 0.1UF 16V	1	
	C8224	FIG1C104A077	C 0.1UF 16V	1	
	C8225	FIG1C104A077	C 0.1UF 16V	1	
	C8226	FIG1C104A077	C 0.1UF 16V	1	
	C8227	FIG1C104A077	C 0.1UF 16V	1	
	C8300	FIG1H9R0A732	C 9 PF, 50V	1	
	C8301	FIG1H8R0A564	C 8 PF, 50V	1	
	C8302	FIG1C104A077	C 0.1UF 16V	1	
	C8303	FIG1C104A077	C 0.1UF 16V	1	



Model No. : TX-P50GT30E/J Parts List

Safety	Ref. No.	Part No.	Part Name & Description	Q'ty	Remarks
	C8304	FIG1C104A077	C 0.1UF 16V	1	
	C8305	FIG1A105A047	C 1UF 10V	1	
	C8306	FIG1A105A047	C 1UF 10V	1	
	C8307	FIG1A105A047	C 1UF 10V	1	
	C8308	FIG1A105A047	C 1UF 10V	1	
	C8309	FIG1A105A047	C 1UF 10V	1	
	C8310	FIG1A105A047	C 1UF 10V	1	
	C8311	FIG1A105A047	C 1UF 10V	1	
	C8401	FIG1C104A077	C 0.1UF 16V	1	
	C8402	FIK0J226A049	C 22UF, 6.3V	1	PAVCCZ
	C8403	FIK0J226A049	C 22UF, 6.3V	1	PAVCCZ
	C8406	FIG1C104A077	C 0.1UF 16V	1	
	C8407	FIG1C104A077	C 0.1UF 16V	1	
	C8411	FIG1C104A077	C 0.1UF 16V	1	
	C8532	FIJ1A106A043	C 10UF, 10V	1	
	C8533	FIG1C104A077	C 0.1UF 16V	1	
	C8603	FIJ1A106A087	C 10UF, 10V	1	
	C8604	FIG1C104A077	C 0.1UF 16V	1	
	C8605	FIG1C104A077	C 0.1UF 16V	1	
	C8606	FIG1H101A565	C 100PF 50V	1	
	C8607	FIG1H100A565	C 10PF 50V	1	
	C8608	FIG1H100A565	C 10PF 50V	1	
	C8609	FIG1C104A077	C 0.1UF 16V	1	
	C8611	FIG1C104A077	C 0.1UF 16V	1	
	C8613	FIG1C104A077	C 0.1UF 16V	1	
	C8614	FIG1C104A077	C 0.1UF 16V	1	
	C8615	FIJ1A106A087	C 10UF, 10V	1	
	C8616	FIJ1A106A087	C 10UF, 10V	1	
	C8617	FIG1C104A077	C 0.1UF 16V	1	
	C8618	FIJ1A106A087	C 10UF, 10V	1	
	C8619	FIG1C104A077	C 0.1UF 16V	1	
	C8620	FIG1C104A077	C 0.1UF 16V	1	
	C8627	FIG1C104A077	C 0.1UF 16V	1	
	C8628	FIJ0G2260001	C 22 UF 4 V	1	
	C8629	FIJ0G2260001	C 22 UF 4 V	1	
	C8630	EEEHBOJ221UP	E 220UF, 6.3V	1	
	C8631	EEEHBOJ221UP	E 220UF, 6.3V	1	
	C8632	FIJ1A106A087	C 10UF, 10V	1	
	C8633	FIG1C104A077	C 0.1UF 16V	1	
	C8636	FIJ1A106A043	C 10UF, 10V	1	
	C8637	FIJ1A106A087	C 10UF, 10V	1	
	C8638	FIG1C104A077	C 0.1UF 16V	1	
	C8639	FIJ1A106A087	C 10UF, 10V	1	
	C8640	FIG1C104A077	C 0.1UF 16V	1	
	C8641	FIJ1A106A043	C 10UF, 10V	1	
	C8642	FIJ1A106A087	C 10UF, 10V	1	
	C8643	FIG1C104A077	C 0.1UF 16V	1	
	C8644	FIG1C104A077	C 0.1UF 16V	1	
	C8647	EEEHBOJ221UP	E 220UF, 6.3V	1	
	C8654	FIG1H470A565	C 47PF, 50V	1	
	C8655	FIG1H470A565	C 47PF, 50V	1	
	C8656	FIG1H470A565	C 47PF, 50V	1	
	C8657	FIG1H470A565	C 47PF, 50V	1	
	C8658	FIJ1A106A087	C 10UF, 10V	1	
	C8659	FIG1C104A077	C 0.1UF 16V	1	
	C8660	FIG1H101A565	C 100PF 50V	1	
	C8661	FIG1H101A565	C 100PF 50V	1	
	C8754	FIJ1A106A087	C 10UF, 10V	1	
	C8756	FIJ1A106A087	C 10UF, 10V	1	
	C8760	FIG1H1020008	C 1000PF 50V	1	
	C8761	FIG1H1020008	C 1000PF 50V	1	
	C8762	FIG1H1020008	C 1000PF 50V	1	

Model No. : TX-P50GT30E/J Parts List

Safety	Ref. No.	Part No.	Part Name & Description	Q'ty	Remarks
	C8763	FIG1C104A077	C 0.1UF 16V	1	
	C8764	FIG1C223A081	C 0.022UF, 16V	1	
	C8765	FIJ1A106A043	C 10UF, 10V	1	
	C8766	FIJ1A106A043	C 10UF, 10V	1	
	C8768	FIG1A333A032	C0.033UF, 10V	1	
	C8769	FIG1H5610004	C 560 pF 50 V	1	PAVCCZ
	C8771	FIJ1A475A087	C 4.7UF, 10V	1	
	C8772	FIJ1A106A087	C 10UF, 10V	1	
	C8773	FIG1C104A077	C 0.1UF 16V	1	
	C8774	FIG1C104A077	C 0.1UF 16V	1	
	C8776	FIK1E106A136	C 10UF, 25V	1	
	C8777	FIG1C104A077	C 0.1UF 16V	1	
	C8780	ECJ1VB1A105K	C 1UF, 10V	1	
	C8781	ECJ1VB1A105K	C 1UF, 10V	1	
	C8786	FIG1C104A077	C 0.1UF 16V	1	
	C8787	FIG1C104A077	C 0.1UF 16V	1	
	C8789	FIK1E106A136	C 10UF, 25V	1	
	C8790	FIK1E106A136	C 10UF, 25V	1	
	C8791	FIG1C223A081	C 0.022UF, 16V	1	
	C8792	FIG1C1030008	C 0.01UF 16V	1	
	C8793	FIG1C1030008	C 0.01UF 16V	1	
	C8795	FIJ1A106A043	C 10UF, 10V	1	
	C8796	FIJ1A106A043	C 10UF, 10V	1	
	C8797	FIJ1A106A043	C 10UF, 10V	1	
	C8798	FIJ1A106A043	C 10UF, 10V	1	
	C8802	FIJ1H102A721	C 1000pF, 50V	1	
	C8803	FIG1E1030005	C 0.01UF 25V	1	
	C8807	FIK1E106A136	C 10UF, 25V	1	
	C8808	FIK1E106A136	C 10UF, 25V	1	
	C8809	FIG1C223A081	C 0.022UF, 16V	1	
	C8810	FIG1C1030008	C 0.01UF 16V	1	
	C8811	FIG1C1030008	C 0.01UF 16V	1	
	C8812	FIJ1A106A043	C 10UF, 10V	1	
	C8813	FIJ1A106A043	C 10UF, 10V	1	
	C8814	FIJ1A106A043	C 10UF, 10V	1	
	C8815	FIJ1A106A043	C 10UF, 10V	1	
	C8900	FIG1C104A077	C 0.1UF 16V	1	
	C8901	FIG1C104A077	C 0.1UF 16V	1	
	C8902	FIG1C104A077	C 0.1UF 16V	1	
	C8903	FIG1C104A077	C 0.1UF 16V	1	
	C9099	FIG1C104A077	C 0.1UF 16V	1	
	C9100	FIJ1A106A087	C 10UF, 10V	1	
	C9101	FIG1E1030005	C 0.01UF 25V	1	
	C9102	FIK1E106A136	C 10UF, 25V	1	
	C9103	FIG1E1030005	C 0.01UF 25V	1	
	C9300	FIG1C104A077	C 0.1UF 16V	1	
	C9301	FIG1H180A565	C 18PF, 50V	1	
	C9302	FIG1H180A565	C 18PF, 50V	1	
	C9304	FIG1C104A077	C 0.1UF 16V	1	
	C9308	FIG1C104A077	C 0.1UF 16V	1	
	C9311	FIG1C104A077	C 0.1UF 16V	1	
	C9312	FIJ1A106A087	C 10UF, 10V	1	
	C9313	FIG1C104A077	C 0.1UF 16V	1	
	C9328	FIG1C104A077	C 0.1UF 16V	1	
	C9330	FIG1A105A047	C 1UF 10V	1	
	C9331	FIG1A105A047	C 1UF 10V	1	
	C9332	FIG1A105A047	C 1UF 10V	1	
	C9337	FIJ1A106A087	C 10UF, 10V	1	
	C9362	FIG1C104A077	C 0.1UF 16V	1	
	C9366	FIG1A105A047	C 1UF 10V	1	
	C9371	FIJ1A106A087	C 10UF, 10V	1	
	C9375	FIG1C104A077	C 0.1UF 16V	1	

Model No. : TX-P50GT30E/J Parts List

Safety	Ref. No.	Part No.	Part Name & Description	Q'ty	Remarks
	C9380	FIG1C104A077	C 0.1UF 16V	1	
	C9389	FIG1A105A047	C 1UF 10V	1	
	C9392	FIJ1A106A087	C 10UF, 10V	1	
	C9400	FIG1C104A077	C 0.1UF 16V	1	
	C9401	FIG1C104A077	C 0.1UF 16V	1	
	C9402	FIG1C104A077	C 0.1UF 16V	1	
	C9404	FIG1C104A077	C 0.1UF 16V	1	
	C9407	FIG1C104A077	C 0.1UF 16V	1	
	C9409	FIJ1A106A087	C 10UF, 10V	1	
	C9411	FIJ1A106A087	C 10UF, 10V	1	
	C9413	FIJ1A106A087	C 10UF, 10V	1	
	C9415	FIJ1A106A087	C 10UF, 10V	1	
	C9506	FIG1C104A077	C 0.1UF 16V	1	
	C9509	FIG1C104A077	C 0.1UF 16V	1	
	C9510	FIJ1A106A087	C 10UF, 10V	1	
	C9511	FIG1C104A077	C 0.1UF 16V	1	
	C9526	FIG1C104A077	C 0.1UF 16V	1	
	C9528	FIG1A105A047	C 1UF 10V	1	
	C9529	FIG1A105A047	C 1UF 10V	1	
	C9530	FIG1A105A047	C 1UF 10V	1	
	C9535	FIJ1A106A087	C 10UF, 10V	1	
	C9550	FIG1C104A077	C 0.1UF 16V	1	
	C9551	FIG1A105A047	C 1UF 10V	1	
	C9554	FIJ1A106A087	C 10UF, 10V	1	
	C9556	FIG1C104A077	C 0.1UF 16V	1	
	C9561	FIG1C104A077	C 0.1UF 16V	1	
	C9570	FIG1A105A047	C 1UF 10V	1	
	C9573	FIJ1A106A087	C 10UF, 10V	1	
	C9577	FIG1C104A077	C 0.1UF 16V	1	
	C9580	FIG1C104A077	C 0.1UF 16V	1	
	C9582	FIJ1A106A087	C 10UF, 10V	1	
	C9584	FIJ1A106A087	C 10UF, 10V	1	
	C9586	FIJ1A106A087	C 10UF, 10V	1	
	C9588	FIJ1A106A087	C 10UF, 10V	1	
	C9589	FIJ1A106A087	C 10UF, 10V	1	
	C9590	FIG1E1030005	C 0.01UF 25V	1	
	C9591	FIG1C104A077	C 0.1UF 16V	1	
	C9593	FIG1H470A565	C 47PF, 50V	1	
	C9860	FIG1E122A123	C 1200pF 25V	1	PAVCCZ
	C9861	FIJ1A475A087	C 4.7UF, 10V	1	
	C9862	FIK1E106A136	C 10UF, 25V	1	
	C9863	FIK1E106A136	C 10UF, 25V	1	
	C9864	FIK1E106A136	C 10UF, 25V	1	
	C9865	FIJ0G2260001	C 22 UF 4 V	1	
	C9866	FIJ0G2260001	C 22 UF 4 V	1	
	C9867	FIJ0G2260001	C 22 UF 4 V	1	
	C9868	FIJ0G2260001	C 22 UF 4 V	1	
	C9869	FIJ0G2260001	C 22 UF 4 V	1	
	C9871	FIJ0G2260001	C 22 UF 4 V	1	
	C9872	FIH1C105A145	C 1 uF 16 V	1	
	C9873	FIG1E122A123	C 1200pF 25V	1	PAVCCZ
	C9874	FIG1C104A077	C 0.1UF 16V	1	
	C9875	FIG1C104A077	C 0.1UF 16V	1	
	C9876	FIK1E106A136	C 10UF, 25V	1	
	CN0100	K1KA14A00248	14P CONNECTOR	1	
	CN8400	KINA68B00058	CONNECTOR	1	PAVCCZ
	CN8600	KINA09E00121	CONNECTOR	1	
	D101	BOFBCR000025	DIODE	1	PAVCCZ
	D102	BOEAKT000067	DIODE	1	PAVCCZ
	D103	BOEAKT000067	DIODE	1	PAVCCZ





Model No. : TX-P50GT30E/J Parts List

Safety	Ref. No.	Part No.	Part Name & Description	Q'ty	Remarks
	D104	B0AACK000004	DIODE	1	
	D105	B0AACK000004	DIODE	1	
⚠	D106	B0FBCE000025	DIODE	1	PAVCCZ
	D107	B0ACCC000048	DIODE	1	
	D131	B0BA02800001	ZENER DIODE	1	
	D132	B0BA02800001	ZENER DIODE	1	
	D133	B0BA01400009	ZENER DIODE	1	
	D201	B0FABR000018	DIODE	1	PAVCCZ (P)
⚠	D201	D4EAC6210002	VARISTOR	1	(P2)
	D202	B0FABR000018	DIODE	1	PAVCCZ (P)
⚠	D202	D4EAC6210002	VARISTOR	1	(P2)
	D203	B0ECKM000053	DIODE	1	PAVCCZ (P)
⚠	D203	D4EAC6210002	VARISTOR	1	(P2)
	D204	B0ECKM000053	DIODE	1	PAVCCZ (P)
⚠	D204	D4EAC6210002	VARISTOR	1	(P2)
⚠	D205	D4EAC6210002	VARISTOR	1	
	D206	B0ECKM000053	DIODE	1	PAVCCZ
	D207	B0ECKM000053	DIODE	1	PAVCCZ
⚠	D209	TVSRM10B	DIODE	1	
	D210	B0ECKM000053	DIODE	1	PAVCCZ
	D211	B0ECKM000053	DIODE	1	PAVCCZ
	D301	B0HAGV000004	DIODE	1	
	D302	B0ECKM000053	DIODE	1	PAVCCZ
	D303	B0ECKM000053	DIODE	1	PAVCCZ
	D304	B0ECKM000053	DIODE	1	PAVCCZ
	D305	B0ECKM000053	DIODE	1	PAVCCZ
	D331	B0BC01400019	DIODE	1	PAVCCZ
	D332	B0BC01000014	ZENER DIODE	1	
	D333	B0BC01000014	ZENER DIODE	1	
	D351	B0AAQP000002	DIODE	1	PAVCCZ
	D352	B0AAQM000003	DIODE	1	PAVCCZ
	D353	B0ECKM000053	DIODE	1	PAVCCZ
	D354	B0JBSL000049	DIODE	1	PAVCCZ
	D382	B0BC5R600003	DIODE	1	
	D383	B0BB14500002	ZENER DIODE	1	PAVCCZ
	D384	B0BB14500002	ZENER DIODE	1	PAVCCZ
	D401	B0EAKT000048	DIODE	1	
⚠	D402	TVSRM10B	DIODE	1	
⚠	D403	TVSRM10B	DIODE	1	
	D404	B0ECKP000060	DIODE	1	PAVCCZ
	D405	B0BA3R100012	ZENER DIODE	1	PAVCCZ
	D406	B0HAGV000004	DIODE	1	
	D407	B0ECKP000060	DIODE	1	PAVCCZ
	D408	B0ECKM000053	DIODE	1	PAVCCZ
	D409	B0ECKM000053	DIODE	1	PAVCCZ
	D410	B0ECKM000053	DIODE	1	PAVCCZ
	D411	B0HAGV000004	DIODE	1	
	D412	DB2X41500L	DIODE	1	PAVCCZ
⚠	D421	D4EAC6210002	VARISTOR	1	
⚠	D422	D4EAC6210002	VARISTOR	1	
	D451	B0JBSL000049	DIODE	1	PAVCCZ
	D452	B0ACCC000048	DIODE	1	
	D453	B0ACCC000048	DIODE	1	
	D454	B0ACCC000048	DIODE	1	
	D455	B0ACCC000048	DIODE	1	
	D456	DB2X41500L	DIODE	1	PAVCCZ
	D458	B0ACCC000048	DIODE	1	
	D459	B0JBSL000049	DIODE	1	PAVCCZ
	D463	B0ACCC000048	DIODE	1	
	D464	B0ACCC000048	DIODE	1	
	D501	B0ECKP000060	DIODE	1	PAVCCZ
	D531	B0BA01400009	ZENER DIODE	1	

Model No. : TX-P50GT30E/J Parts List

Safety	Ref. No.	Part No.	Part Name & Description	Q'ty	Remarks
	D532	B0BC5R600003	DIODE	1	
	D553	B0ACCCJ000048	DIODE	1	
	D554	B0ACCCJ000048	DIODE	1	
	D555	B0ACCCJ000048	DIODE	1	
	D556	B0ACCCJ000048	DIODE	1	
	D581	B0BC5R600003	DIODE	1	
	D583	B0BA3R100012	ZENER DIODE	1	PAVCCZ
	D584	B0BA3R100012	ZENER DIODE	1	PAVCCZ
	D601	B0ACCCJ000048	DIODE	1	
	D603	B0ECKM000053	DIODE	1	PAVCCZ
	D631	B0BC6R700006	DIODE	1	PAVCCZ
	D655	B0ACCCJ000048	DIODE	1	
	D656	B0ACCCJ000048	DIODE	1	
	D657	B0ACCCJ000048	DIODE	1	
	D658	B0ACCCJ000048	DIODE	1	
	D663	B0ACCCJ000048	DIODE	1	
	D664	B0ACCCJ000048	DIODE	1	
	D667	B0ACCCJ000048	DIODE	1	
	D670	B0ACCCJ000048	DIODE	1	
	D674	B0ACCCJ000048	DIODE	1	
	D681	B0BC7R500001	DIODE	1	
	D682	B0BC6R100010	DIODE	1	PAVCCZ
	D683	B0BC01000014	ZENER DIODE	1	
	D2820	B3AGB0000065	LED	1	PAVCCZ
	D2850	B3EB00000056	LED	1	PAVCCZ
	D2851	B3EB00000056	LED	1	PAVCCZ
	D2852	B3EB00000056	LED	1	PAVCCZ
	D2853	B3EB00000056	LED	1	PAVCCZ
	D3130	B0JCCE000008	DIODE	1	
	D4703	DZ2J056M0L	ZENER DIODE	1	
	D4704	B0JCCE000008	DIODE	1	
	D4720	DZ2J056M0L	ZENER DIODE	1	
	D4721	B0JCCE000008	DIODE	1	
	D4722	B0JCCE000008	DIODE	1	
	D4771	DZ2J056M0L	ZENER DIODE	1	
	D4773	B0JCCE000008	DIODE	1	
	D4774	DZ2J056M0L	ZENER DIODE	1	
	D4775	B0JCCE000008	DIODE	1	
	D4785	B0ECKM000048	DIODE	1	
	D5200	B0JCMD000066	ZENER DIODE	1	
	D5201	B0ACCCJ000048	DIODE	1	
	D5202	B0BC013A0007	DIODE	1	
	D5203	B0ACCCJ000048	DIODE	1	
	D5204	DZ2J033M0L	ZENER DIODE	1	
	D5205	B0ACCCJ000048	DIODE	1	
	D5206	B0ACCCJ000048	DIODE	1	
	D5207	B0ACCCJ000048	DIODE	1	
	D5441	B0JCPE000038	DIODE	1	
	D5904	B0JCMD000066	ZENER DIODE	1	
	D6775	B0ECKP000002	DIODE	1	
	D6777	B0ECKP000002	DIODE	1	
	D6778	B0JCMD000010	DIODE	1	
	D6779	B0JCND000029	DIODE	1	PAVCCZ
	D6780	B0JCND000029	DIODE	1	PAVCCZ
	D6781	B0JC PG000030	DIODE	1	
	D8708	DZ2J068M0L	ZENER DIODE	1	
	D8709	B0ADCJ000100	DIODE	1	
	D8711	B0ADCJ000100	DIODE	1	
	D8712	DZ2J068M0L	ZENER DIODE	1	
	D8713	DZ2J068M0L	ZENER DIODE	1	
	D8717	B0ACCCJ000048	DIODE	1	
	D8718	B0JCMD000066	ZENER DIODE	1	



Model No. : TX-P50GT30E/J Parts List

Safety	Ref. No.	Part No.	Part Name & Description	Q'ty	Remarks
	D8719	DZ2J068M0L	ZENER DIODE	1	
	D8720	B0ADCJ000100	DIODE	1	
	D8721	DZ2J068M0L	ZENER DIODE	1	
	D9806	B0ADCJ000100	DIODE	1	
	D9807	B0ADCJ000100	DIODE	1	
	F101	K5E103BZ0002	FUSE	1	
	F102	K5E103BZ0002	FUSE	1	
	F103	K5Y202Y00001	FUSE	1	PAVCCZ
	F301	K5Y502Y00001	FUSE	1	PAVCCZ
	FL8600	JOZZB0000142	FILTER	1	
	FL8601	JOZZB0000142	FILTER	1	
	FL8602	JOZZB0000142	FILTER	1	
	IC201	C0DBBYY00025	IC	1	PAVCCZ
	IC301	C0DABYY00025	IC	1	PAVCCZ
	IC351	C0DBEYY00078	IC	1	
	IC352	C0DAAYY00063	IC	1	PAVCCZ
	IC401	C0DAAYY00065	IC	1	PAVCCZ
	IC451	C0DBEYY00078	IC	1	
	IC453	C0ABBA000059	IC	1	PAVCCZ
	IC455	C0DBAYY00922	IC	1	PAVCCZ
	IC601	C0DBEYY00078	IC	1	
	IC651	C0BBBA000024	IC	1	
	IC652	C0DBEYY00078	IC	1	
	IC2001	C1ZBZ0004368	IC	1	PAVCCZ
	IC3001	C1AB00003384	IC	1	PAVCCZ
	IC4700	C1AB00003469	IC	1	PAVCCZ
	IC4701	C0DBGYY00578	IC	1	
	IC4800	C0DBGYY02190	IC	1	PAVCCZ
	IC4900	C1AB00003457	IC	1	PAVCCZ
	IC5000	AN34044A-VF	IC	1	PAVCCZ
	IC5200	C0DBAYY00932	IC	1	PAVCCZ
	IC5441	C0DBAYY01058	IC	1	PAVCCZ
	IC5900	C0DBAYY00931	IC	1	PAVCCZ
	IC5901	C1ZBZ0004339	IC	1	PAVCCZ
	IC6776	C0DBAGF00030	IC	1	
	IC6777	C0DBAYY00462	IC	1	
	IC6778	C1AB00003521	IC	1	PAVCCZ
	IC8000	MN2WS0200LE	IC	1	PAVCCZ
	IC8100	C0DBAYY00715	IC	1	
	IC8200	C3ABUY000009	IC	1	PAVCCZ
	IC8201	C3ABTY000025	IC	1	
	IC8403	C0JBAZ003032	IC	1	PAVCCZ
	IC8404	C0DBZYY00382	IC	1	PAVCCZ
	IC8601	C1CB00003239	IC	1	
	IC8602	C0DBZYY00368	IC	1	
	IC8603	C0DBZYY00368	IC	1	
	IC8606	C0DBZYY00450	IC	1	PAVCCZ
	IC8701	C0DBAYY00931	IC	1	PAVCCZ
	IC8702	C0DBAFG00029	IC	1	PAVCCZ
	IC8704	C0CBCAG00046	IC	1	
	IC8706	C0DBGYY00887	IC	1	
	IC8707	C0DBAYY00915	IC	1	PAVCCZ
	IC8709	C0DBAYY00915	IC	1	PAVCCZ
	IC8900	TVRS076AE	IC	1	PAVCCZ
	IC8901	TVR****	IC	1	PAVCCZ
	IC8902	TVR****	IC	1	PAVCCZ
	IC9300	C1AB00003461	IC	1	PAVCCZ
	IC9304	TVRS213AB	IC	1	PAVCCZ
	IC9400	C0JBAU000089	IC	1	PAVCCZ









Model No. : TX-P50GT30E/J Parts List

Safety	Ref. No.	Part No.	Part Name & Description	Q'ty	Remarks
	IC9401	C0JBAU000089	IC	1	PAVCCZ
	IC9402	C0JBAU000089	IC	1	PAVCCZ
	IC9500	CIAB00003461	IC	1	PAVCCZ
	IC9501	C0JBAU000010	IC	1	
	IC9860	C0DBAYY00715	IC	1	
	JA1	D0GFR00J0005	M 0 OHM, J, 1/3W	1	PAVCCZ
	JA2	D0GFR00J0005	M 0 OHM, J, 1/3W	1	PAVCCZ
	JA3	D0GFR00J0005	M 0 OHM, J, 1/3W	1	PAVCCZ
	JA4	D0GFR00J0005	M 0 OHM, J, 1/3W	1	PAVCCZ
	JA5	D0GFR00J0005	M 0 OHM, J, 1/3W	1	PAVCCZ
	JA6	D0GFR00J0005	M 0 OHM, J, 1/3W	1	PAVCCZ
	JA7	D0GFR00J0005	M 0 OHM, J, 1/3W	1	PAVCCZ
	JA8	D0GFR00J0005	M 0 OHM, J, 1/3W	1	PAVCCZ
	JA10	D0GFR00J0005	M 0 OHM, J, 1/3W	1	PAVCCZ
	JA11	D0GFR00J0005	M 0 OHM, J, 1/3W	1	PAVCCZ
	JA14	D0GFR00J0005	M 0 OHM, J, 1/3W	1	PAVCCZ
	JA15	D0GFR00J0005	M 0 OHM, J, 1/3W	1	PAVCCZ
	JA16	D0GFR00J0005	M 0 OHM, J, 1/3W	1	PAVCCZ
	JA18	D0GFR00J0005	M 0 OHM, J, 1/3W	1	PAVCCZ
	JA19	D0GFR00J0005	M 0 OHM, J, 1/3W	1	PAVCCZ
	JA22	D0GFR00J0005	M 0 OHM, J, 1/3W	1	PAVCCZ
	JA23	D0GFR00J0005	M 0 OHM, J, 1/3W	1	PAVCCZ
	JA24	D0GFR00J0005	M 0 OHM, J, 1/3W	1	PAVCCZ
	JA26	D0GFR00J0005	M 0 OHM, J, 1/3W	1	PAVCCZ
	JA27	D0GFR00J0005	M 0 OHM, J, 1/3W	1	PAVCCZ
	JA28	D0GFR00J0005	M 0 OHM, J, 1/3W	1	PAVCCZ
	JA29	D0GFR00J0005	M 0 OHM, J, 1/3W	1	PAVCCZ
	JA30	D0GFR00J0005	M 0 OHM, J, 1/3W	1	PAVCCZ
	JA32	D0GFR00J0005	M 0 OHM, J, 1/3W	1	PAVCCZ
	JA34	D0GFR00J0005	M 0 OHM, J, 1/3W	1	PAVCCZ
	JA36	D0GFR00J0005	M 0 OHM, J, 1/3W	1	PAVCCZ
	JA37	D0GFR00J0005	M 0 OHM, J, 1/3W	1	PAVCCZ
	JA38	D0GFR00J0005	M 0 OHM, J, 1/3W	1	PAVCCZ
	JA39	D0GFR00J0005	M 0 OHM, J, 1/3W	1	PAVCCZ
	JA40	D0GFR00J0005	M 0 OHM, J, 1/3W	1	PAVCCZ
	JA42	D0GFR00J0005	M 0 OHM, J, 1/3W	1	PAVCCZ
	JA43	D0GFR00J0005	M 0 OHM, J, 1/3W	1	PAVCCZ
	JA45	D0GFR00J0005	M 0 OHM, J, 1/3W	1	PAVCCZ
	JA46	D0GFR00J0005	M 0 OHM, J, 1/3W	1	PAVCCZ
	JA48	D0GFR00J0005	M 0 OHM, J, 1/3W	1	PAVCCZ
	JA49	D0GFR00J0005	M 0 OHM, J, 1/3W	1	PAVCCZ
	JK3003	K1FY120E0001	CONNECTOR	1	PAVCCZ
	JK3100	K2HC104E0020	JACK	1	PAVCCZ
	JK3707	K2HC104E0020	JACK	1	PAVCCZ
	JK3708	K2HC104E0020	JACK	1	PAVCCZ
	JK3709	B3MBZ0000012	IC	1	PAVCCZ
	JK4700	K1FY119E0030	CONNECTOR	1	PAVCCZ
	JK4701	K1FY119E0030	CONNECTOR	1	PAVCCZ
	JK4702	K1FY119E0030	CONNECTOR	1	PAVCCZ
	JK4703	K1FY119E0030	CONNECTOR	1	PAVCCZ
	JK8301	K2LC108E0014	JACK	1	PAVCCZ
	JK8601	K1FY104B0065	CONNECTOR	1	PAVCCZ
	JK8602	K1FY104B0065	CONNECTOR	1	PAVCCZ
	JK8603	K1FY104B0065	CONNECTOR	1	PAVCCZ
	K1	K1KA08B00270	8P CONNECTOR	1	
	L192	EXCELSA35T	BEAD CHOKE	1	
	L202	EXCELD35V	BEAD CHOKE	1	
	L203	EXCELD35V	BEAD CHOKE	1	

Model No. : TX-P50GT30E/J Parts List

Safety	Ref. No.	Part No.	Part Name & Description	Q'ty	Remarks
	L354	G0C121Z00011	PEAKING COIL	1	PAVCCZ
	L401	G0A100ZA0023	CHOKE COIL	1	PAVCCZ
	L402	EXCELSA35T	BEAD CHOKE	1	
	L451	G0A100ZA0023	CHOKE COIL	1	PAVCCZ
	L2751	J0JHC0000045	CHIP INDUCTOR	1	
	L3100	J0JYC0000331	CHIP INDUCTOR	1	
	L3101	J0JYC0000331	CHIP INDUCTOR	1	
	L3104	J0JCC0000287	CHIP INDUCTOR	1	
	L3108	J0JCC0000287	CHIP INDUCTOR	1	
	L3111	J0JYC0000331	CHIP INDUCTOR	1	
	L3112	J0JYC0000331	CHIP INDUCTOR	1	
	L3113	J0JYC0000331	CHIP INDUCTOR	1	
	L3116	J0JYC0000331	CHIP INDUCTOR	1	
	L3119	J0JYC0000331	CHIP INDUCTOR	1	
	L3120	J0JYC0000331	CHIP INDUCTOR	1	
	L3300	J0ZZB0000150	FILTER	1	PAVCCZ
	L3301	J0ZZB0000150	FILTER	1	PAVCCZ
	L4702	J0JYC0000068	CHIP INDUCTOR	1	
	L4705	J0JYC0000068	CHIP INDUCTOR	1	
	L4708	J0JYC0000068	CHIP INDUCTOR	1	
	L4712	J0JHC0000045	CHIP INDUCTOR	1	
	L4717	J0JYC0000068	CHIP INDUCTOR	1	
	L4802	J0JGC0000020	CHIP INDUCTOR	1	
	L4803	G1CR39J00009	INDUCTION COIL	1	
	L4804	G1CR39J00009	INDUCTION COIL	1	
	L4805	J0JCC0000278	CHIP INDUCTOR	1	
	L4900	G1C150MA0426	INDUCTION COIL	1	PAVCCZ
	L4901	G1C150MA0426	INDUCTION COIL	1	PAVCCZ
	L4902	G1C150MA0426	INDUCTION COIL	1	PAVCCZ
	L4903	G1C150MA0426	INDUCTION COIL	1	PAVCCZ
	L5200	G1C100MA0496	INDUCTION COIL	1	PAVCCZ
	L5441	G1C4R7MA0445	INDUCTION COIL	1	PAVCCZ
	L5900	G1C6R8MA0445	INDUCTION COIL	1	PAVCCZ
	L6776	G1C4R7MA0445	INDUCTION COIL	1	PAVCCZ
	L6777	J0JGC0000020	CHIP INDUCTOR	1	
	L6782	G1C150MA0426	INDUCTION COIL	1	PAVCCZ
	L6783	G1C4R7ZA0240	INDUCTION COIL	1	
	L6784	J0JHC0000116	CHIP INDUCTOR	1	
	L8001	J0JCC0000287	CHIP INDUCTOR	1	
	L8002	J0JHC0000045	CHIP INDUCTOR	1	
	L8003	J0JHC0000045	CHIP INDUCTOR	1	
	L8004	J0JHC0000045	CHIP INDUCTOR	1	
	L8005	J0JHC0000021	CHIP INDUCTOR	1	
	L8006	J0JCC0000287	CHIP INDUCTOR	1	
	L8007	J0JCC0000287	CHIP INDUCTOR	1	
	L8100	G1C4R7MA0416	INDUCTION COIL	1	
	L8102	G1C3R3MA0460	INDUCTION COIL	1	PAVCCZ
	L8600	J0JHC0000045	CHIP INDUCTOR	1	
	L8601	J0JHC0000045	CHIP INDUCTOR	1	
	L8603	J0JHC0000045	CHIP INDUCTOR	1	
	L8604	J0JHC0000045	CHIP INDUCTOR	1	
	L8605	J0JHC0000045	CHIP INDUCTOR	1	
	L8702	G1C6R8MA0445	INDUCTION COIL	1	PAVCCZ
	L8703	G1C6R8MA0445	INDUCTION COIL	1	PAVCCZ
	L8704	G1C6R8MA0445	INDUCTION COIL	1	PAVCCZ
	L9303	J0JHC0000117	CHIP INDUCTOR	1	
	L9501	J0JHC0000117	CHIP INDUCTOR	1	
	L9860	G1C2R2MA0449	INDUCTION COIL	1	PAVCCZ
	L9861	G1C2R2MA0449	INDUCTION COIL	1	PAVCCZ
	LF101	G0B382KA0010	CHOKE COIL	1	PAVCCZ
	LF102	G0B382KA0010	CHOKE COIL	1	PAVCCZ

Model No. : TX-P50GT30E/J Parts List

Safety	Ref. No.	Part No.	Part Name & Description	Q'ty	Remarks
	LF103	G0B382KA0010	CHOKE COIL	1	PAVCCZ
	LF104	G0B382KA0010	CHOKE COIL	1	PAVCCZ
	P2	K1KY02B00012	2P CONNECTOR	1	
	P6	K1KA15BA0311	15P CONNECTOR	1	PAVCCZ
	P9	K1KA02B00295	2P CONNECTOR	1	
	P11	K1KY03B00006	3P CONNECTOR	1	
	P25	K1KA10BA0237	10P CONNECTOR	1	PAVCCZ
	P34	K1KA03BA0237	3P CONNECTOR	1	
	P35	K1KA04BA0237	4P CONNECTOR	1	
	P51	K1KY02B00012	2P CONNECTOR	1	
	P52	K1KY02B00012	2P CONNECTOR	1	
	P55	K1KY03B00006	3P CONNECTOR	1	
	P56	K1KY03B00006	3P CONNECTOR	1	
	P57	K1KA05B00211	5P CONNECTOR	1	PAVCCZ
	P58	K1KA05B00211	5P CONNECTOR	1	PAVCCZ
	P1MM10	TMM27463	CLAMPER	1	PAVCCZ
	P1MM11	TMM27463	CLAMPER	1	PAVCCZ
	P1MM12	TMM27463	CLAMPER	1	PAVCCZ
	P1MM13	TMM27463	CLAMPER	1	PAVCCZ
	P1MM14	TMM27463	CLAMPER	1	PAVCCZ
	P1MM15	TMM27463	CLAMPER	1	PAVCCZ
	P1MM16	TMM27463	CLAMPER	1	PAVCCZ
	P1MM17	TMM27463	CLAMPER	1	PAVCCZ
	P1MM18	TMM27463	CLAMPER	1	PAVCCZ
	P2MM10	TMM27463	CLAMPER	1	PAVCCZ
	P2MM11	TMM27463	CLAMPER	1	PAVCCZ
	P2MM12	TMM27463	CLAMPER	1	PAVCCZ
	P2MM13	TMM27463	CLAMPER	1	PAVCCZ
	P2MM14	TMM27463	CLAMPER	1	PAVCCZ
	P2MM15	TMM27463	CLAMPER	1	PAVCCZ
	PA451	K5H502YA0063	FUSE	1	PAVCCZ
	PA501	K5H502YA0063	FUSE	1	PAVCCZ
	PA2005	K5H4022A0031	FUSE	1	
	PA5201	K5H1022A0031	FUSE	1	
	PA5440	K5H5022A0031	FUSE	1	
	PA5900	K5H1022A0031	FUSE	1	
	PA6779	K5H1622A0031	FUSE	1	
	PA6780	K5H1622A0031	FUSE	1	
	PC101	B3PAA0000363	IC	1	
	PC302	B3PAA0000363	IC	1	
	PC402	B3PAA0000363	IC	1	
	PC501	B3PAA0000363	IC	1	
	PC602	B3PAA0000363	IC	1	
	PC603	B3PAA0000363	IC	1	
	Q101	B1CFNG000010	FET	1	
	Q102	DSA200100L	TRANSISTOR	1	
	Q201	B1CERR000060	FET	1	PAVCCZ
	Q202	B1CERR000060	FET	1	PAVCCZ
	Q203	B1ADMF000001	TRANSISTOR	1	PAVCCZ
	Q204	B1ADMF000001	TRANSISTOR	1	PAVCCZ
	Q301	B1CERR000056	FET	1	PAVCCZ
	Q302	B1CERR000056	FET	1	PAVCCZ
	Q354	DSC200100L	TRANSISTOR	1	
	Q374	B1DHBC000008	FET	1	
	Q375	B1CERM000033	FET	1	PAVCCZ
	Q376	B1ADMF000001	TRANSISTOR	1	PAVCCZ

Model No. : TX-P50GT30E/J Parts List

Safety	Ref. No.	Part No.	Part Name & Description	Q'ty	Remarks
	Q377	B1ABMD000022	TRANSISTOR	1	PAVCCZ
	Q451	B1CHRD000046	FET	1	PAVCCZ
	Q452	B1CBGD000001	FET	1	
	Q453	B1CBGD000001	FET	1	
	Q454	B1CHRD000046	FET	1	PAVCCZ
	Q455	B1CBGD000001	FET	1	
	Q456	B1CBGD000001	FET	1	
	Q457	B1DHBC000008	FET	1	
	Q458	B1CBGD000001	FET	1	
	Q459	B1CBGD000001	FET	1	
	Q460	B1CBGD000001	FET	1	
	Q462	B1CBGD000001	FET	1	
	Q463	B1CBGD000001	FET	1	
	Q501	B1AAPG000009	TRANSISTOR	1	PAVCCZ
	Q502	DSC200100L	TRANSISTOR	1	
	Q503	B1DHBC000008	FET	1	
	Q551	B1CBGD000001	FET	1	
	Q552	DSC200100L	TRANSISTOR	1	
	Q553	DSC200100L	TRANSISTOR	1	
	Q554	DSC200100L	TRANSISTOR	1	
	Q555	DSC200100L	TRANSISTOR	1	
	Q556	B1CBGD000001	FET	1	
	Q557	B1DHBC000008	FET	1	
	Q558	DSC200100L	TRANSISTOR	1	
	Q559	DSA200100L	TRANSISTOR	1	
	Q560	B1DHBC000008	FET	1	
	Q561	DSC200100L	TRANSISTOR	1	
	Q562	DSC200100L	TRANSISTOR	1	
	Q563	DSC200100L	TRANSISTOR	1	
	Q564	B1DHBC000008	FET	1	
	Q565	B1DHBC000008	FET	1	
	Q601	DSA200100L	TRANSISTOR	1	
	Q651	B1DHBC000008	FET	1	
	Q652	B1CBGD000001	FET	1	
	Q653	B1DHBC000008	FET	1	
	Q656	B1DHBC000008	FET	1	
	Q658	B1DHBC000008	FET	1	
	Q701	DSC200100L	TRANSISTOR	1	
	Q702	DSC200100L	TRANSISTOR	1	
	Q0900	DSA200100L	TRANSISTOR	1	
	Q2810	B1ABCE000015	TRANSISTOR	1	
	Q2811	B1ABCE000015	TRANSISTOR	1	
	Q2812	B1ABCE000015	TRANSISTOR	1	
	Q3008	DSA200100L	TRANSISTOR	1	
	Q3102	B1Aafb000004	TRANSISTOR	1	PAVCCZ
	Q3103	B1Aafb000004	TRANSISTOR	1	PAVCCZ
	Q3104	B1Aafb000004	TRANSISTOR	1	PAVCCZ
	Q3105	B1Aafb000004	TRANSISTOR	1	PAVCCZ
	Q4512	BIHFCA000026	TRANSISTOR	1	
	Q4513	DSA2001S0L	TRANSISTOR	1	
	Q4700	B1ABCF000231	TRANSISTOR	1	
	Q4702	B1ABCF000231	TRANSISTOR	1	
	Q4709	B1ABCF000231	TRANSISTOR	1	
	Q4710	B1ABCF000231	TRANSISTOR	1	
	Q4970	DSA200100L	TRANSISTOR	1	
	Q4971	B1Aafb000004	TRANSISTOR	1	PAVCCZ
	Q4972	B1Aafb000004	TRANSISTOR	1	PAVCCZ
	Q4974	DSC2001S0L	TRANSISTOR	1	
	Q6775	B1CFQD000001	FET	1	
	Q8100	B1CFRD000077	FET	1	PAVCCZ
	Q8101	B1CFRD000077	FET	1	PAVCCZ
	Q8102	B1MBEDA00027	FET	1	

Model No. : TX-P50GT30E/J Parts List

Safety	Ref. No.	Part No.	Part Name & Description	Q'ty	Remarks
	Q8709	DSA200100L	TRANSISTOR	1	
	Q8710	DSA200100L	TRANSISTOR	1	
	Q8711	DSC2001S0L	TRANSISTOR	1	
	Q9860	B1MBEDA00027	FET	1	
	Q9861	B1MBEDA00027	FET	1	
	R004	D0GBR00J0004	M 0 OHM J 1/10W	1	
⚠	R101	DOB1185JA033	M 1.8 MOHM J 1 W	1	PAVCCZ
⚠	R102	DOB1825JA033	M 8.2 MOHM J 1 W	1	
⚠	R103	D1F5150Y0001	F 150 OHM, 5W	1	PAVCCZ
	R104	D0D54R7J0002	M 4.7 OHM, J, 2W	1	PAVCCZ
	R105	D1BD2003A066	M 200KOHM.F.1/8W	1	PAVCCZ
	R106	D1BD2003A066	M 200KOHM.F.1/8W	1	PAVCCZ
	R107	D1BD2003A066	M 200KOHM.F.1/8W	1	PAVCCZ
	R108	D1BD2003A066	M 200KOHM.F.1/8W	1	PAVCCZ
	R109	D1BD2003A066	M 200KOHM.F.1/8W	1	PAVCCZ
	R110	D1BD1003A066	M 100KOHM, J.1/8 W	1	PAVCCZ
	R111	D1BD2003A066	M 200KOHM.F.1/8W	1	PAVCCZ
	R113	D0D5180J0002	M 18 OHM, J, 2W	1	PAVCCZ
	R114	D1BD1003A066	M 100KOHM, J.1/8 W	1	PAVCCZ
	R115	D1BD1003A066	M 100KOHM, J.1/8 W	1	PAVCCZ
	R116	D1BB2202A073	M 22KOHM, J.1/10W	1	PAVCCZ
	R117	D1BB2202A073	M 22KOHM, J.1/10W	1	PAVCCZ
	R118	D1BB2203A073	M 220KOHM, J.1/10W	1	PAVCCZ
	R121	D0GBR00J0004	M 0 OHM J 1/10W	1	
	R201	D1BD3303A066	M330KOHM.F.1/8W	1	PAVCCZ
	R202	D1BD3303A066	M330KOHM.F.1/8W	1	PAVCCZ
	R203	D1BD3303A066	M330KOHM.F.1/8W	1	PAVCCZ
	R204	D1BD3303A066	M330KOHM.F.1/8W	1	PAVCCZ
	R205	D1BD3303A066	M330KOHM.F.1/8W	1	PAVCCZ
	R206	D1BD3003A066	M 300KOHM.F.1/8W	1	PAVCCZ
	R207	D1BB2002A073	M 20KOHM, J.1/10W	1	PAVCCZ
	R209	D1BD7503A066	M 750KOHM, F.1/8W	1	PAVCCZ
	R210	D1BB1002A073	M 10KOHM, J.1/10W	1	PAVCCZ
	R211	D1BD2202A066	M 22KOHM, F.1/8W	1	PAVCCZ
	R212	D1BB1802A073	M 18KOHM, J.1/10W	1	PAVCCZ
	R213	D1BB1502A073	M 15KOHM, J.1/10W	1	PAVCCZ
	R214	D1BB1802A073	M 18KOHM, J.1/10W	1	PAVCCZ
	R215	D1BB1502A073	M 15KOHM, J.1/10W	1	PAVCCZ
	R217	D1BD51R0A066	M0.51KOHM, F.1/8W	1	PAVCCZ
	R219	D0GDR00J0004	M 0 OHM, 1/8W	1	
	R220	D1DE100JA019	M 100 OHM, 1/4W	1	PAVCCZ
	R221	D1BB2202A073	M 22KOHM, J.1/10W	1	PAVCCZ
	R224	D0XGR10J0007	M 0.10OHM, J, 5W	1	
	R225	D0XGR10J0007	M 0.10OHM, J, 5W	1	
	R227	D1BD51R0A066	M0.51KOHM, F.1/8W	1	PAVCCZ
	R229	D0GDR00J0004	M 0 OHM, 1/8W	1	
	R230	D1DE100JA019	M 100 OHM, 1/4W	1	PAVCCZ
	R231	D1BB2202A073	M 22KOHM, J.1/10W	1	PAVCCZ
	R234	D0XGR10J0007	M 0.10OHM, J, 5W	1	
	R235	D0XGR10J0007	M 0.10OHM, J, 5W	1	
	R236	D1BB2200A073	M 220 OHM, J.1/10W	1	PAVCCZ
	R237	D1BB2200A073	M 220 OHM, J.1/10W	1	PAVCCZ
	R238	D1BB5103A073	M510KOHM, J.1/10W	1	PAVCCZ
	R239	D1BB5103A073	M510KOHM, J.1/10W	1	PAVCCZ
	R247	D0GDR00J0004	M 0 OHM, 1/8W	1	
	R250	D1BB1800A073	M 180 OHM, J.1/10W	1	PAVCCZ
	R251	D1BB1200A073	M 120 OHM, J.1/10W	1	PAVCCZ
	R252	D1BB1800A073	M 180 OHM, J.1/10W	1	PAVCCZ
	R253	D1BB1200A073	M 120 OHM, J.1/10W	1	PAVCCZ
	R258	D1BD51R0A066	M0.51KOHM, F.1/8W	1	PAVCCZ
	R259	D1BD51R0A066	M0.51KOHM, F.1/8W	1	PAVCCZ

Model No. : TX-P50GT30E/J Parts List

Safety	Ref. No.	Part No.	Part Name & Description	Q'ty	Remarks
	R260	D1BD3303A066	M330KOHM.F.1/8W	1	PAVCCZ
	R261	D1BD3303A066	M330KOHM.F.1/8W	1	PAVCCZ
	R262	D1BD3303A066	M330KOHM.F.1/8W	1	PAVCCZ
	R263	D1BD1603A066	M 160KOHM.F.1/8W	1	PAVCCZ
	R301	D1BD3303A066	M330KOHM.F.1/8W	1	PAVCCZ
	R302	D1BD3303A066	M330KOHM.F.1/8W	1	PAVCCZ
	R303	D1BD3303A066	M330KOHM.F.1/8W	1	PAVCCZ
	R304	D1BD3303A066	M330KOHM.F.1/8W	1	PAVCCZ
	R305	D1BD3303A066	M330KOHM.F.1/8W	1	PAVCCZ
	R306	D1BD1002A066	M 10KOHM, J.1/8W	1	PAVCCZ
	R307	D1BD3301A066	M 3.3KOHM, F.1/8W	1	PAVCCZ
	R308	D1BD4702A066	M 47KOHM, F.1/8W	1	PAVCCZ
	R309	D1BD5600A066	M 560 OHM, F.1/8W	1	PAVCCZ
	R310	D1BD4700A066	M 470 OHM, F.1/8W	1	PAVCCZ
	R311	D1BD1200A066	M 120 OHM, J.1/8W	1	PAVCCZ
	R312	D1BD33R0A066	M 33 OHM, F.1/8W	1	PAVCCZ
	R313	D1BD10R0A066	M 10 OHM, F. 1/8W	1	PAVCCZ
	R314	D1DE2R2JA019	M 2.2 OHM, 1/4W	1	PAVCCZ
	R315	D1BB2202A073	M 22KOHM, J.1/10W	1	PAVCCZ
	R316	D1BD10R0A066	M 10 OHM, F. 1/8W	1	PAVCCZ
	R317	D1DE2R2JA019	M 2.2 OHM, 1/4W	1	PAVCCZ
	R318	D1BB2202A073	M 22KOHM, J.1/10W	1	PAVCCZ
	R319	D1BD10R0A066	M 10 OHM, F. 1/8W	1	PAVCCZ
	R320	D1BD3303A066	M330KOHM.F.1/8W	1	PAVCCZ
	R321	D1BD3303A066	M330KOHM.F.1/8W	1	PAVCCZ
	R322	D1BD3303A066	M330KOHM.F.1/8W	1	PAVCCZ
	R323	D1BD1603A066	M 160KOHM.F.1/8W	1	PAVCCZ
	R351	D1BB6202A073	M 62KOHM, J.1/10W	1	PAVCCZ
	R352	D1BB6202A073	M 62KOHM, J.1/10W	1	PAVCCZ
	R353	D1BB6202A073	M 62KOHM, J.1/10W	1	PAVCCZ
	R354	D1BB7502A073	M 75KOHM, J.1/10W	1	PAVCCZ
	R355	D1BB7502A073	M 75KOHM, J.1/10W	1	PAVCCZ
	R356	D1BB7502A073	M 75KOHM, J.1/10W	1	PAVCCZ
	R357	D1BB5101A073	M 5.1KOHM, J.1/10W	1	PAVCCZ
	R358	D1BB4702A073	M 47KOHM, J.1/10W	1	PAVCCZ
	R359	DOGBR00J0004	M 0 OHM J 1/10W	1	
	R360	D1BB2201A073	M 2.2KOHM, J.1/10W	1	PAVCCZ
	R361	D1BD1001A066	M 1KOHM, J.1/8W	1	PAVCCZ
	R369	D1BD4701A066	M 4.7KOHM, F.1/8W	1	PAVCCZ
	R370	D1BD4701A066	M 4.7KOHM, F.1/8W	1	PAVCCZ
	R371	D1BD4701A066	M 4.7KOHM, F.1/8W	1	PAVCCZ
	R372	D1BD4701A066	M 4.7KOHM, F.1/8W	1	PAVCCZ
	R373	D1BD1002A066	M 10KOHM, J.1/8W	1	PAVCCZ
	R374	D1BB1002A073	M 10KOHM, J.1/10W	1	PAVCCZ
	R375	D1BB4701A073	M 4.7KOHM, J.1/10W	1	PAVCCZ
	R376	D1BB4701A073	M 4.7KOHM, J.1/10W	1	PAVCCZ
	R377	D1BB2003A073	M 200KOHM, J.1/10W	1	PAVCCZ
	R378	D1DE330J0001	M 330 OHM, 1/4W	1	PAVCCZ
	R379	D1BB2702A073	M 27KOHM, J.1/10W	1	PAVCCZ
	R380	D1BB3303A073	M 330KOHM, J.1/10W	1	PAVCCZ
	R381	D1BB1803A073	M 18KOHM, J.1/10W	1	PAVCCZ
	R382	D1BB1003A073	M 100KOHM, J.1/10W	1	PAVCCZ
	R383	D1BD8202A066	M 750KOHM, F.1/8W	1	PAVCCZ
	R384	D1BD1003A066	M 100KOHM, J.1/8 W	1	PAVCCZ
	R385	D1BD1202A066	M 12KOHM, F.1/8W	1	PAVCCZ
	R386	D1BD6200A066	M 620 OHM, F.1/8W	1	PAVCCZ
	R387	D1BD1601A066	M 1.6KOHM, F.1/8W	1	PAVCCZ
	R388	ERG1SJ473P	M 47KOHM, J, 1W	1	
	R389	ERG2SJ104P	M 100KOHM, J, 2W	1	
	R390	D1BD1003A066	M 100KOHM, J.1/8 W	1	PAVCCZ
	R391	D1BD1001A066	M 1KOHM, J.1/8W	1	PAVCCZ
	R393	D1BD2001A066	M 2.0KOHM, F.1/8W	1	PAVCCZ

Model No. : TX-P50GT30E/J Parts List

Safety	Ref. No.	Part No.	Part Name & Description	Q'ty	Remarks
	R394	D0GDR00J0004	M 0 OHM, 1/8W	1	
	R399	D0GBR00J0004	M 0 OHM J 1/10W	1	
	R401	D1DE470JA022	M 470 OHM, 1/4W	1	PAVCCZ
	R403	D0XGR22J0005	M 0.22OHM, J, 5W	1	PAVCCZ
	R405	D1BD1003A066	M 100KOHM, J.1/8 W	1	PAVCCZ
	R406	D1BD2202A066	M 22KOHM, F.1/8W	1	PAVCCZ
	R407	D1BB2201A073	M 2.2KOHM, J.1/10W	1	PAVCCZ
	R408	ERG2DG224	M 220KOHM.G.2W	1	PAVCCZ
	R409	ERG2DG224	M 220KOHM.G.2W	1	PAVCCZ
	R410	ERG2DG224	M 220KOHM.G.2W	1	PAVCCZ
	R411	D1BD1004A066	M1000KOHM, F.1/8W	1	PAVCCZ
	R412	D1BD1002A066	M 10KOHM, J.1/8W	1	PAVCCZ
	R413	ERG2DG224	M 220KOHM.G.2W	1	PAVCCZ
	R441	D1BB6803A073	M680KOHM, J.1/10W	1	PAVCCZ
	R442	D1BB1003A073	M 100KOHM, J.1/10W	1	PAVCCZ
	R445	D0GDR00J0004	M 0 OHM J 1/10W	1	
	R447	D1BB2200A073	M 220 OHM, J.1/10W	1	PAVCCZ
	R448	D1BD3003A066	M 300KOHM.F.1/8W	1	PAVCCZ
	R449	D1BD2003A066	M 200KOHM.F.1/8W	1	PAVCCZ
	R451	D1BD3901A066	M 3.9KOHM, F.1/8W	1	PAVCCZ
	R452	D1BB2702A073	M 27KOHM, J.1/10W	1	PAVCCZ
	R453	D1BB2702A073	M 27KOHM, J.1/10W	1	PAVCCZ
	R454	D1BD6201A066	M 6.2KOHM, F.1/8W	1	PAVCCZ
	R455	D1BD3901A066	M 3.9KOHM, F.1/8W	1	PAVCCZ
	R456	D1BB1202A073	M 120 OHM, J.1/10W	1	PAVCCZ
	R457	D1BB3301A073	M 3.3KOHM, J.1/10W	1	PAVCCZ
	R458	D1BB1203A073	M 120KOHM, J.1/10W	1	PAVCCZ
	R459	D1BB2003A073	M 200KOHM, J.1/10W	1	PAVCCZ
	R460	D1BB2201A073	M 2.2KOHM, J.1/10W	1	PAVCCZ
	R461	D1BD2003A066	M 200KOHM.F.1/8W	1	PAVCCZ
	R462	D1BB1001A073	M 100 OHM, J.1/10W	1	PAVCCZ
	R463	D1BB1203A073	M 120KOHM, J.1/10W	1	PAVCCZ
	R464	D1BB2203A073	M 220KOHM, J.1/10W	1	PAVCCZ
	R465	D1BB1202A073	M 120 OHM, J.1/10W	1	PAVCCZ
	R466	D1BB1003A073	M 100KOHM, J.1/10W	1	PAVCCZ
	R467	D1BB1001A073	M 100 OHM, J.1/10W	1	PAVCCZ
	R468	D0XGR10J0007	M 0.10OHM, J, 5W	1	
	R469	D0GDR00J0004	M 0 OHM J 1/10W	1	
	R471	D0GDR00J0004	M 0 OHM J 1/10W	1	
	R473	D1BB1002A073	M 10KOHM, J.1/10W	1	PAVCCZ
	R474	D1BB1002A073	M 10KOHM, J.1/10W	1	PAVCCZ
	R476	D1BB1003A073	M 100KOHM, J.1/10W	1	PAVCCZ
	R477	D1BB1003A073	M 100KOHM, J.1/10W	1	PAVCCZ
	R478	D1BB6802A073	M 68KOHM, J.1/10W	1	PAVCCZ
	R483	D1BB8202A073	M 82KOHM, J.1/10W	1	PAVCCZ
	R484	D0GDR00J0004	M 0 OHM J 1/10W	1	
	R485	D1BB2702A073	M 27KOHM, J.1/10W	1	PAVCCZ
	R486	ERX1SJ3R9	M 3.9 OHM, J, 1W	1	PAVCCZ
	R487	D1BB4702A073	M 47KOHM, J.1/10W	1	PAVCCZ
	R488	D1BD1003A066	M 100KOHM, J.1/8 W	1	PAVCCZ
	R489	D1BD1303A066	M 130KOHM.F.1/8W	1	PAVCCZ
	R490	D1BD2003A066	M 200KOHM.F.1/8W	1	PAVCCZ
	R491	D1BB1000A073	M 100 OHM, J.1/10W	1	PAVCCZ
	R492	D1BB1503A073	M 150KOHM, J.1/10W	1	PAVCCZ
	R493	D1BD3003A066	M 300KOHM.F.1/8W	1	PAVCCZ
	R496	D0GDR00J0004	M 0 OHM J 1/10W	1	
	R497	D1BB1002A073	M 10KOHM, J.1/10W	1	PAVCCZ
	R498	D1BB1002A073	M 10KOHM, J.1/10W	1	PAVCCZ
	R502	D1BD3900A066	M 390 OHM, F.1/8W	1	PAVCCZ
	R503	D1BD1004A066	M1000KOHM, F.1/8W	1	PAVCCZ
	R505	D1BB4701A073	M 4.7KOHM, J.1/10W	1	PAVCCZ
	R506	D1BB1002A073	M 10KOHM, J.1/10W	1	PAVCCZ

Model No. : TX-P50GT30E/J Parts List

Safety	Ref. No.	Part No.	Part Name & Description	Q'ty	Remarks
	R507	D1BB4701A073	M 4.7KOHM, J.1/10W	1	PAVCCZ
	R508	D1BB4701A073	M 4.7KOHM, J.1/10W	1	PAVCCZ
	R512	ERG2SJ222H	M 2.2KOHM, J, 2W	1	
	R513	D1BB1001A073	M 100 OHM, J.1/10W	1	PAVCCZ
	R514	D1BD1004A066	M1000KOHM, F.1/8W	1	PAVCCZ
	R515	D1BB1002A073	M 10KOHM, J.1/10W	1	PAVCCZ
	R516	D1BB1002A073	M 10KOHM, J.1/10W	1	PAVCCZ
	R517	D1BB1001A073	M 100 OHM, J.1/10W	1	PAVCCZ
	R518	D1BD3900A066	M 390 OHM, F.1/8W	1	PAVCCZ
	R519	D1BD3900A066	M 390 OHM, F.1/8W	1	PAVCCZ
	R550	D1DE2R2JA019	M 2.2 OHM, 1/4W	1	PAVCCZ
	R551	D1BB4703A073	M470KOHM, J.1/10W	1	PAVCCZ
	R552	D1BB4703A073	M470KOHM, J.1/10W	1	PAVCCZ
	R553	D1BB6801A073	M 6.8KOHM, J.1/10W	1	PAVCCZ
	R554	D1BB6803A073	M680KOHM, J.1/10W	1	PAVCCZ
	R555	D1BB1003A073	M 100KOHM, J.1/10W	1	PAVCCZ
	R556	D1BB1503A073	M 150KOHM, J.1/10W	1	PAVCCZ
	R557	D1BB3001A073	M 3.0KOHM, J.1/10W	1	PAVCCZ
	R558	D1BB4702A073	M 47KOHM, J.1/10W	1	PAVCCZ
	R559	D1BB1002A073	M 10KOHM, J.1/10W	1	PAVCCZ
	R560	D1BB1002A073	M 10KOHM, J.1/10W	1	PAVCCZ
	R561	D1BB4701A073	M 4.7KOHM, J.1/10W	1	PAVCCZ
	R562	D1BB1002A073	M 10KOHM, J.1/10W	1	PAVCCZ
	R563	D1BB1003A073	M 100KOHM, J.1/10W	1	PAVCCZ
	R564	D1BB3301A073	M 3.3KOHM, J.1/10W	1	PAVCCZ
	R565	D1BB3302A073	M 33KOHM, J.1/10W	1	PAVCCZ
	R566	D1BB1002A073	M 10KOHM, J.1/10W	1	PAVCCZ
	R567	D1BB3302A073	M 33KOHM, J.1/10W	1	PAVCCZ
	R568	D1BB2202A073	M 22KOHM, J.1/10W	1	PAVCCZ
	R569	D1BB1002A073	M 10KOHM, J.1/10W	1	PAVCCZ
	R570	D1BB1002A073	M 10KOHM, J.1/10W	1	PAVCCZ
	R571	D1BB4701A073	M 4.7KOHM, J.1/10W	1	PAVCCZ
	R572	D1BB4701A073	M 4.7KOHM, J.1/10W	1	PAVCCZ
	R573	D1BB1002A073	M 10KOHM, J.1/10W	1	PAVCCZ
	R574	D1BB1002A073	M 10KOHM, J.1/10W	1	PAVCCZ
	R576	D1BB1001A073	M 100 OHM, J.1/10W	1	PAVCCZ
	R577	D1BB1001A073	M 100 OHM, J.1/10W	1	PAVCCZ
	R578	D1BB5600A073	M 560 OHMJ.1/10W	1	PAVCCZ
	R579	D1BB1001A073	M 100 OHM, J.1/10W	1	PAVCCZ
	R580	D1BB1001A073	M 100 OHM, J.1/10W	1	PAVCCZ
	R581	DOGDR00J0004	M 0 OHM, 1/8W	1	
	R582	DOGDR00J0004	M 0 OHM, 1/8W	1	
	R583	D1BB6802A073	M 68KOHM, J.1/10W	1	PAVCCZ
	R584	D1BB6802A073	M 68KOHM, J.1/10W	1	PAVCCZ
	R585	D1BB4703A073	M470KOHM, J.1/10W	1	PAVCCZ
	R586	D1BB4703A073	M470KOHM, J.1/10W	1	PAVCCZ
	R587	D1BB1503A073	M 150KOHM, J.1/10W	1	PAVCCZ
	R588	D1BB1002A073	M 10KOHM, J.1/10W	1	PAVCCZ
	R589	D1BB4702A073	M 47KOHM, J.1/10W	1	PAVCCZ
	R590	D1BB4703A073	M470KOHM, J.1/10W	1	PAVCCZ
	R591	D1BB1002A073	M 10KOHM, J.1/10W	1	PAVCCZ
	R592	D1BB1002A073	M 10KOHM, J.1/10W	1	PAVCCZ
	R593	D1BB4701A073	M 4.7KOHM, J.1/10W	1	PAVCCZ
	R594	D1BB4701A073	M 4.7KOHM, J.1/10W	1	PAVCCZ
	R595	D1BB3001A073	M 3.0KOHM, J.1/10W	1	PAVCCZ
	R596	D1BB4701A073	M 4.7KOHM, J.1/10W	1	PAVCCZ
	R597	D1BB1002A073	M 10KOHM, J.1/10W	1	PAVCCZ
	R598	D1BB4701A073	M 4.7KOHM, J.1/10W	1	PAVCCZ
	R601	D1BD3903A066	M 390KOHM, F. 1/8W	1	PAVCCZ
	R602	D1BD3903A066	M 390KOHM, F. 1/8W	1	PAVCCZ
	R603	D1BD3903A066	M 390KOHM, F. 1/8W	1	PAVCCZ
	R604	D1BD3903A066	M 390KOHM, F. 1/8W	1	PAVCCZ

Model No. : TX-P50GT30E/J Parts List

Safety	Ref. No.	Part No.	Part Name & Description	Q'ty	Remarks
	R605	D1BD3903A066	M 390KOHM, F. 1/8W	1	PAVCCZ
	R606	D1BD3903A066	M 390KOHM, F. 1/8W	1	PAVCCZ
	R607	D1BD3903A066	M 390KOHM, F. 1/8W	1	PAVCCZ
	R608	D1BB2002A073	M 20KOHM, J.1/10W	1	PAVCCZ
	R609	D1BB1003A073	M 100KOHM, J.1/10W	1	PAVCCZ
	R610	D1BB5600A073	M 560 OHMJ.1/10W	1	PAVCCZ
	R611	D1BB1001A073	M 100 OHM, J.1/10W	1	PAVCCZ
	R612	D1BB5600A073	M 560 OHMJ.1/10W	1	PAVCCZ
	R613	D1BD5600A066	M 560 OHM, F.1/8W	1	PAVCCZ
	R614	D1BB1002A073	M 10KOHM, J.1/10W	1	PAVCCZ
	R615	D1BB1002A073	M 10KOHM, J.1/10W	1	PAVCCZ
	R616	D1BD3903A066	M 390KOHM, F. 1/8W	1	PAVCCZ
	R617	D1BD3303A066	M330KOHM. F.1/8W	1	PAVCCZ
	R618	D1BD1002A066	M 10KOHM, J.1/8W	1	PAVCCZ
	R619	D0GBR00J0004	M 0 OHM J 1/10W	1	
	R620	D0GBR00J0004	M 0 OHM J 1/10W	1	
	R621	D1BB1003A073	M 100KOHM, J.1/10W	1	PAVCCZ
	R635	D1BB4701A073	M 4.7KOHM, J.1/10W	1	PAVCCZ
	R636	D1BB4701A073	M 4.7KOHM, J.1/10W	1	PAVCCZ
	R637	D1BD22R0A066	M 0.22 OHM, F.1/8W	1	PAVCCZ
	R648	D1BB3303A073	M 330KOHM, J.1/10W	1	PAVCCZ
	R650	D1BB9102A073	M 91KOHM, J.1/10W	1	PAVCCZ
	R651	D1BB9102A073	M 91KOHM, J.1/10W	1	PAVCCZ
	R653	D1BB9102A073	M 91KOHM, J.1/10W	1	PAVCCZ
	R654	D1BB8202A073	M 82KOHM, J.1/10W	1	PAVCCZ
	R655	D1BB8202A073	M 82KOHM, J.1/10W	1	PAVCCZ
	R656	D1BB8202A073	M 82KOHM, J.1/10W	1	PAVCCZ
	R657	D1BB1502A073	M 15KOHM, J.1/10W	1	PAVCCZ
	R658	D1BB3902A073	M 39KOHM, J.1/10W	1	PAVCCZ
	R659	D1BB1002A073	M 10KOHM, J.1/10W	1	PAVCCZ
	R660	D1BB1002A073	M 10KOHM, J.1/10W	1	PAVCCZ
	R661	D1BB1002A073	M 10KOHM, J.1/10W	1	PAVCCZ
	R662	D1BB1502A073	M 15KOHM, J.1/10W	1	PAVCCZ
	R663	D1BB3001A073	M 3.0KOHM, J.1/10W	1	PAVCCZ
	R666	D1BB4701A073	M 4.7KOHM, J.1/10W	1	PAVCCZ
	R667	D1BB3601A073	M 3.6KOHM, J.1/10W	1	PAVCCZ
	R668	D1BB2201A073	M 2.2KOHM, J.1/10W	1	PAVCCZ
	R669	D1BB4701A073	M 4.7KOHM, J.1/10W	1	PAVCCZ
	R670	D1BB3601A073	M 3.6KOHM, J.1/10W	1	PAVCCZ
	R671	D1BB2201A073	M 2.2KOHM, J.1/10W	1	PAVCCZ
	R672	D1BB1003A073	M 100KOHM, J.1/10W	1	PAVCCZ
	R673	D1BB6801A073	M 6.8KOHM, J.1/10W	1	PAVCCZ
	R674	D1BB1202A073	M 120 OHM, J.1/10W	1	PAVCCZ
	R675	D1BB1802A073	M 18KOHM, J.1/10W	1	PAVCCZ
	R678	D1BB1003A073	M 100KOHM, J.1/10W	1	PAVCCZ
	R679	D1BB4701A073	M 4.7KOHM, J.1/10W	1	PAVCCZ
	R680	D1BB4701A073	M 4.7KOHM, J.1/10W	1	PAVCCZ
	R681	D1BB1003A073	M 100KOHM, J.1/10W	1	PAVCCZ
	R682	D1BB2203A073	M 220KOHM, J.1/10W	1	PAVCCZ
	R684	D1BB1001A073	M 100 OHM, J.1/10W	1	PAVCCZ
	R685	D1BB2203A073	M 220KOHM, J.1/10W	1	PAVCCZ
	R686	D1BB4701A073	M 4.7KOHM, J.1/10W	1	PAVCCZ
	R688	D1BB4701A073	M 4.7KOHM, J.1/10W	1	PAVCCZ
	R693	D1BD1000A066	M 100 OHM, J.1/10W	1	PAVCCZ
	R694	D1BB1001A073	M 100 OHM, J.1/10W	1	PAVCCZ
	R696	D1BB4701A073	M 4.7KOHM, J.1/10W	1	PAVCCZ
	R697	D1BB4701A073	M 4.7KOHM, J.1/10W	1	PAVCCZ
	R701	D0GBR00J0004	M 0 OHM J 1/10W	1	
	R703	D1BB1603A073	M 160KOHM, J.1/10W	1	PAVCCZ
	R704	D1BB4702A073	M 47KOHM, J.1/10W	1	PAVCCZ
	R705	D1BB1002A073	M 10KOHM, J.1/10W	1	PAVCCZ
	R706	D1BB1002A073	M 10KOHM, J.1/10W	1	PAVCCZ

Model No. : TX-P50GT30E/J Parts List

Safety	Ref. No.	Part No.	Part Name & Description	Q'ty	Remarks
	R707	D1BB1203A073	M 120KOHM, J.1/10W	1	PAVCCZ
	R708	D1BB1202A073	M 120 OHM, J.1/10W	1	PAVCCZ
	R709	D1BB1002A073	M 10KOHM, J.1/10W	1	PAVCCZ
	R710	D1BB1002A073	M 10KOHM, J.1/10W	1	PAVCCZ
	R0902	D0GA473JA015	M 47KOHM, J,1/16W	1	
	R0903	D0GA272JA023	M 2.7KOHM, J.1/16W	1	
	R0904	D0GA272JA023	M 2.7KOHM, J.1/16W	1	
	R0905	D0GA272JA023	M 2.7KOHM, J.1/16W	1	
	R0906	D0GA272JA023	M 2.7KOHM, J.1/16W	1	
	R0907	D0GA272JA023	M 2.7KOHM, J.1/16W	1	
	R0908	D0GA272JA023	M 2.7KOHM, J.1/16W	1	
	R0909	D0GA272JA023	M 2.7KOHM, J.1/16W	1	
	R0910	D0GA272JA023	M 2.7KOHM, J.1/16W	1	
	R0911	EXB28V332J	M 3.3 KOHM 1/32 W	1	
	R0912	D0GA101JA015	M 100 OHM, J,1/16W	1	
	R0913	D0GA101JA015	M 100 OHM, J,1/16W	1	
	R0951	D0GA473JA015	M 47KOHM, J,1/16W	1	
	R0952	D0GA102JA023	M1KOHM, J.1/16 W	1	
	R1201	D0GA103JA015	M 10KOHM, J,1/16W	1	
	R1202	D0GA103JA015	M 10KOHM, J,1/16W	1	
	R1304	D0GA103JA015	M 10KOHM, J,1/16W	1	
	R1350	D0GA103JA015	M 10KOHM, J,1/16W	1	
	R2012	D0GA103JA015	M 10KOHM, J,1/16W	1	
	R2752	D0GA184JA023	M 180KOHM J.1/16W	1	
	R2753	D0GB102JA065	M 1KOHM, J,1/10W	1	
	R2810	D0GB470JA065	M 47 OHM, J,1/10W	1	
	R2811	D0GB104JA065	M 100KOHM J 1/10W	1	
	R2812	D0GB224JA065	M 220KOHM, J,1/10W	1	PAVCCZ
	R2813	D0GB223JA065	M 22KOHM, J,1/10W	1	PAVCCZ
	R2814	D0GB103JA065	M 10K OHM J 1/10W	1	
	R2815	D0GB473JA065	M 47KOHM J. 1/10W	1	PAVCCZ
	R2816	D1BB1621A055	M1.62KOHM, J.1/10W	1	
	R2817	D0GB223JA065	M 22KOHM, J,1/10W	1	PAVCCZ
	R2818	D0GB473JA065	M 47KOHM J. 1/10W	1	PAVCCZ
	R2819	D1BB4301A055	M4.30KOHM, J.1/10W	1	
	R3001	D0GA102JA023	M1KOHM, J.1/16 W	1	
	R3002	D0GA122JA023	M 1.2KOHM, J,1/16W	1	
	R3104	D0GBR00J0004	M 0 OHM J 1/10W	1	
	R3106	D0GA333JA023	M 33KOHM, J,1/16W	1	
	R3107	D0GA333JA023	M 33KOHM, J,1/16W	1	
	R3109	D1BF75R0A011	M 75.0 OHM, 1/4W	1	PAVCCZ
	R3117	D0GA221JA023	M220 OHM, J.1/16 W	1	
	R3121	EXB28V221J	M220 OHM 1/32 W	1	
	R3129	D0GA104JA023	M100KOHM, J.1/16 W	1	
	R3137	D1BD75R0A066	M 75.0 OHM, J.1/8 W	1	
	R3141	D1BF75R0A011	M 75.0 OHM, 1/4W	1	PAVCCZ
	R3142	D1BF75R0A011	M 75.0 OHM, 1/4W	1	PAVCCZ
	R3143	D1BF75R0A011	M 75.0 OHM, 1/4W	1	PAVCCZ
	R3147	D1BF75R0A011	M 75.0 OHM, 1/4W	1	PAVCCZ
	R3153	D0GA221JA023	M220 OHM, J.1/16 W	1	
	R3157	EXB28V221J	M220 OHM 1/32 W	1	
	R3163	D0GA104JA023	M100KOHM, J.1/16 W	1	
	R3164	D0GA104JA023	M100KOHM, J.1/16 W	1	
	R3167	D0GA333JA023	M 33KOHM, J,1/16W	1	
	R3168	D0GA333JA023	M 33KOHM, J,1/16W	1	
	R3171	D0GA222JA023	M 2.2KOHM, J,1/16W	1	
	R3172	D0GA222JA023	M 2.2KOHM, J,1/16W	1	
	R3173	EXB28V221J	M220 OHM 1/32 W	1	
	R3174	D0GA221JA023	M220 OHM, J.1/16 W	1	
	R3175	D0GA221JA023	M220 OHM, J.1/16 W	1	
	R3179	D0GA331JA023	M 330 OHM, J,1/16W	1	
	R3180	D0GA331JA023	M 330 OHM, J,1/16W	1	

Model No. : TX-P50GT30E/J Parts List

Safety	Ref. No.	Part No.	Part Name & Description	Q'ty	Remarks
	R3181	D1BD75R0A066	M 75.0 OHM, J.1/8 W	1	
	R3182	D1BD75R0A066	M 75.0 OHM, J.1/8 W	1	
	R3183	D1BD75R0A066	M 75.0 OHM, J.1/8 W	1	
	R3184	D0GA104JA023	M100KOHM, J.1/16 W	1	
	R3185	D0GA104JA023	M100KOHM, J.1/16 W	1	
	R3190	D0GA222JA023	M 2.2KOHM, J,1/16W	1	
	R3191	D0GA222JA023	M 2.2KOHM, J,1/16W	1	
	R3192	EXB28V820JX	M 82 OHM 1/32 W	1	
	R3194	D0GA331JA023	M 330 OHM, J,1/16W	1	
	R3195	D0GA331JA023	M 330 OHM, J,1/16W	1	
	R3202	D1BF75R0A011	M 75.0 OHM, 1/4W	1	PAVCCZ
	R3204	D1BA2152A014	M21.5KOHM, J.1/16 W	1	PAVCCZ
	R3206	D1BA1302A014	M 13KOHM, J.1/16 W	1	
	R3208	D0GA273JA023	M 27K OHM J,1/16W	1	
	R3211	D0GA220JA023	M22 OHM, J.1/16 W	1	
	R3212	D0GA680JA023	M 68 OHM, J,1/16W	1	
	R3290	D0GA473JA015	M 47KOHM, J,1/16W	1	
	R3291	D0GA473JA015	M 47KOHM, J,1/16W	1	
	R3292	D0GA105JA023	M 1M OHM, J,1/16W	1	
	R3293	D0GA473JA015	M 47KOHM, J,1/16W	1	
	R4548	D0GA220JA023	M22 OHM, J.1/16 W	1	
	R4549	D0GA151JA023	M 150 OHM, J,1/16W	1	
	R4550	D0GA151JA023	M 150 OHM, J,1/16W	1	
	R4551	D0GA151JA023	M 150 OHM, J,1/16W	1	
	R4552	D0GA560JA023	M 56 OHM, J,1/16W	1	
	R4553	D0GA103JA015	M 10KOHM, J,1/16W	1	
	R4554	D0GA102JA023	M1KOHM, J.1/16 W	1	
	R4599	D0GA473JA015	M 47KOHM, J,1/16W	1	
	R4600	D0GA103JA015	M 10KOHM, J,1/16W	1	
	R4702	D0GA103JA015	M 10KOHM, J,1/16W	1	
	R4708	D0GA103JA015	M 10KOHM, J,1/16W	1	
	R4709	D0GA103JA015	M 10KOHM, J,1/16W	1	
	R4710	EXB28V473JX	M 47KOHM 1/32 W	1	
	R4711	D0GA102JA023	M1KOHM, J.1/16 W	1	
	R4715	D0GA103JA015	M 10KOHM, J,1/16W	1	
	R4721	D0GA103JA015	M 10KOHM, J,1/16W	1	
	R4722	D0GA103JA015	M 10KOHM, J,1/16W	1	
	R4723	EXB28V473JX	M 47KOHM 1/32 W	1	
	R4724	D0GA102JA023	M1KOHM, J.1/16 W	1	
	R4748	D0GA680JA023	M 68 OHM, J,1/16W	1	
	R4749	D0GA680JA023	M 68 OHM, J,1/16W	1	
	R4750	D0GA680JA023	M 68 OHM, J,1/16W	1	
	R4751	D0GA680JA023	M 68 OHM, J,1/16W	1	
	R4763	D0GA104JA023	M100KOHM, J.1/16 W	1	
	R4767	D0GA392JA023	M 3.9KOHM, J,1/16W	1	
	R4770	D0GA473JA015	M 47KOHM, J,1/16W	1	
	R4771	D0GA152JA023	M 1.5KOHM, J,0.063W	1	
	R4772	D0GA152JA023	M 1.5KOHM, J,0.063W	1	
	R4774	D0GA473JA015	M 47KOHM, J,1/16W	1	
	R4775	D0GA473JA015	M 47KOHM, J,1/16W	1	
	R4780	D0GA121JA023	M 120 OHM, J,1/16W	1	
	R4781	D0GA680JA023	M 68 OHM, J,1/16W	1	
	R4783	D0GA103JA015	M 10KOHM, J,1/16W	1	
	R4784	D0GA103JA015	M 10KOHM, J,1/16W	1	
	R4785	D0GA680JA023	M 68 OHM, J,1/16W	1	
	R4786	D0GA680JA023	M 68 OHM, J,1/16W	1	
	R4787	D0GA680JA023	M 68 OHM, J,1/16W	1	
	R4788	D0GA103JA015	M 10KOHM, J,1/16W	1	
	R4789	D0GA103JA015	M 10KOHM, J,1/16W	1	
	R4790	D0GA680JA023	M 68 OHM, J,1/16W	1	
	R4791	D0GA680JA023	M 68 OHM, J,1/16W	1	
	R4792	EXB28V473JX	M 47KOHM 1/32 W	1	

Model No. : TX-P50GT30E/J Parts List

Safety	Ref. No.	Part No.	Part Name & Description	Q'ty	Remarks
	R4793	D0GA102JA023	M1KOHM, J.1/16 W	1	
	R4794	D0GA103JA015	M 10KOHM, J, 1/16W	1	
	R4795	D0GA103JA015	M 10KOHM, J, 1/16W	1	
	R4796	EXB28V473JX	M 47KOHM 1/32 W	1	
	R4797	D0GA102JA023	M1KOHM, J.1/16 W	1	
	R4798	D0GA273JA023	M 27K OHM J ,1/16W	1	
	R4801	D0GAR00J0005	M 0 OHM, 1/16W	1	
	R4814	D0GD103JA052	M 10KOHM, J, 1/8W	1	PAVCCZ
	R4910	D0GA472JA023	M 4.7KOHM, J, 1/16W	1	
	R4911	D0GA102JA023	M1KOHM, J.1/16 W	1	
	R4913	D0GA103JA015	M 10KOHM, J, 1/16W	1	
	R4914	EXB28V220J	M 22 OHM 1/32 W	1	
	R4921	D0GA103JA015	M 10KOHM, J, 1/16W	1	
	R4970	D1BB1403A055	M 140KOHM, J.1/10W	1	
	R4971	D1BB1403A055	M 140KOHM, J.1/10W	1	
	R4972	D0GA103JA015	M 10KOHM, J, 1/16W	1	
	R4973	D0GA103JA015	M 10KOHM, J, 1/16W	1	
	R4974	D0GA101JA015	M 100 OHM, J, 1/16W	1	
	R4975	D0GA473JA015	M 47KOHM, J, 1/16W	1	
	R4976	D0GA103JA015	M 10KOHM, J, 1/16W	1	
	R4977	D0GA105JA023	M 1M OHM, J, 1/16W	1	
	R4978	D0GA101JA015	M 100 OHM, J, 1/16W	1	
	R4979	D0GA101JA015	M 100 OHM, J, 1/16W	1	
	R4984	D0GA473JA015	M 47KOHM, J, 1/16W	1	
	R4985	D0GA103JA015	M 10KOHM, J, 1/16W	1	
	R4987	D0GF102JA048	M 1.0 KOHM, J, 1/3W	1	PAVCCZ
	R5000	D0GA102JA023	M1KOHM, J.1/16 W	1	
	R5001	D0GA473JA015	M 47KOHM, J, 1/16W	1	
	R5009	D0GA103JA015	M 10KOHM, J, 1/16W	1	
	R5010	D0GA222JA023	M 2.2KOHM, J, 1/16W	1	
	R5011	D0GA104JA023	M100KOHM, J.1/16 W	1	
	R5012	D0GA223JA023	M 22K OHM J 1/16W	1	
	R5013	D0GA103JA015	M 10KOHM, J, 1/16W	1	
	R5089	D0GAR00J0005	M 0 OHM, 1/16W	1	
	R5090	D0GAR00J0005	M 0 OHM, 1/16W	1	
	R5200	D0GA102JA023	M1KOHM, J.1/16 W	1	
	R5201	D0GA510JA023	M 51 OHM, J, 1/16W	1	PAVCCZ
	R5202	EXB28V472JX	M 4.7 OHM 1/32 W	1	
	R5203	D0GA472JA023	M 4.7KOHM, J, 1/16W	1	
	R5204	D0GA471JA023	M 470OHM, J, 1/16W	1	
	R5209	D1BB9100A055	M 910 OHM, J.1/10W	1	
	R5210	D1BB1052A055	M10.5KOHM, J.1/10W	1	
	R5211	D1BB4300A055	M 430 OHM, J.1/10W	1	
	R5212	D0GA473JA015	M 47KOHM, J, 1/16W	1	
	R5213	D0GD471JA059	M 470 OHM, J, 1/4W	1	PAVCCZ
	R5214	D0GA473JA015	M 47KOHM, J, 1/16W	1	
	R5445	D0GF151JA048	M 150 OHM, J, 1/3W	1	PAVCCZ
	R5446	D0GD4R7JA059	M 4.7 OHM, J, 1/4W	1	
	R5449	D1BB1001A055	M 1KOHM, J. 1/10W	1	
	R5450	D1BB5101A055	M 5.1KOHM, J.1/10W	1	
	R5451	D0GB332JA065	M 3.3KOHM, J, 1/10W	1	
	R5658	D0GAR00J0005	M 0 OHM, 1/16W	1	
	R5901	D1BB1002A055	M 10KOHM, J.1/10W	1	
	R5902	D1BB5362A055	M53.6KOHM, J.1/10W	1	PAVCCZ
	R5903	D0GAR00J0005	M 0 OHM, 1/16W	1	
	R5904	D1BB3002A055	M 30KOHM, J.1/10W	1	
	R5905	D0GA470JA023	M 47 OHM, J, 1/16W	1	
	R5906	D1BA4642A014	M46.4KOHM, J.1/16 W	1	PAVCCZ
	R5907	D0GB363JA065	M 36K OHM J 1/10W	1	PAVCCZ
	R5910	D0GA472JA023	M 4.7KOHM, J, 1/16W	1	
	R5911	D0GA472JA023	M 4.7KOHM, J, 1/16W	1	
	R5912	D0GA472JA023	M 4.7KOHM, J, 1/16W	1	

Model No. : TX-P50GT30E/J Parts List

Safety	Ref. No.	Part No.	Part Name & Description	Q'ty	Remarks
	R5913	D0GA472JA023	M 4.7KOHM, J,1/16W	1	
	R5916	D0GA683JA023	M 68KOHM, J,1/16W	1	
	R5924	D0GA390JA023	M 39 OHM, J,1/16W	1	
	R6775	EXB2HV680J	M 68 OHM 1/16 W	1	
	R6777	D0GBR00J0004	M 0 OHM J 1/10W	1	
	R6780	D0GA390JA023	M 39 OHM, J,1/16W	1	
	R6781	D1BA1002A014	M 10KOHM, J. 1/16 W	1	
	R6782	D1BA2701A014	M 2.7 KOHM, J.1/16 W	1	
	R6783	D0GA392JA023	M 3.9KOHM, J,1/16W	1	
	R6784	EXB28V680JX	M 68 OHM 1/32 W	1	
	R6785	D0GFR20JA020	M 0.2 OHM, J,1/4W	1	PAVCCZ
	R6786	D0GA681JA023	M680 OHM, J,1/16W	1	
	R6787	D0GA220JA023	M22 OHM, J.1/16 W	1	
	R6792	D0GB2R2JA065	M 2.2OHM J 1/10W	1	PAVCCZ
	R6793	D0GF100JA048	M 10 OHM, J,1/3W	1	PAVCCZ
	R6794	D1BA4700A014	M 470 OHM, J.1/16 W	1	PAVCCZ
	R6795	D0GF100JA048	M 10 OHM, J,1/3W	1	PAVCCZ
	R6953	D0GAR00J0005	M 0 OHM, 1/16W	1	
	R6954	D0GA103JA015	M 10KOHM, J,1/16W	1	
	R8008	D0GA331JA023	M 330 OHM, J,1/16W	1	
	R8100	D1BB1271A087	M1.27KOHM, J.1/16W	1	PAVCCZ
	R8102	D1BB2101A087	M 2.1KOHM, J.1/10W	1	
	R8104	D1BB8200A087	M 820 OHM, J.1/10W	1	
	R8106	D1BB2001A087	M 2KOHM, J.1/10W	1	
	R8108	D0GB100JA065	M 10 OHM J 1/10W	1	
	R8110	D0GB100JA065	M 10 OHM J 1/10W	1	
	R8114	D0GA303JA023	M 30K OHM J 0.063W	1	PAVCCZ
	R8118	D0GA183JA023	M 18K OHM J.1/16W	1	
	R8200	D1BA2400A014	M 240 OHM, J.1/16 W	1	
	R8201	D1BA1001A014	M 1KOHM, J. 1/16 W	1	
	R8202	D1BA1001A014	M 1KOHM, J. 1/16 W	1	
	R8203	D1BA1001A014	M 1KOHM, J. 1/16 W	1	
	R8204	D1BA1001A014	M 1KOHM, J. 1/16 W	1	
	R8205	D1BA1001A014	M 1KOHM, J. 1/16 W	1	
	R8206	D1BA1001A014	M 1KOHM, J. 1/16 W	1	
	R8207	D1BA1001A014	M 1KOHM, J. 1/16 W	1	
	R8208	D1BA1001A014	M 1KOHM, J. 1/16 W	1	
	R8209	D0GA111JA023	M 110 OHM, J.1/16W	1	
	R8210	D0GA111JA023	M 110 OHM, J.1/16W	1	
	R8211	D1BA2400A014	M 240 OHM, J.1/16 W	1	
	R8212	D1BA2400A014	M 240 OHM, J.1/16 W	1	
	R8213	D0GA103JA015	M 10KOHM, J,1/16W	1	
	R8214	D0GA103JA015	M 10KOHM, J,1/16W	1	
	R8215	D1BA2400A014	M 240 OHM, J.1/16 W	1	
	R8216	D1BA1001A014	M 1KOHM, J. 1/16 W	1	
	R8217	D1BA1001A014	M 1KOHM, J. 1/16 W	1	
	R8218	EXB28V220J	M 22 OHM 1/32 W	1	
	R8219	EXB28V220J	M 22 OHM 1/32 W	1	
	R8220	EXB28V220J	M 22 OHM 1/32 W	1	
	R8221	EXB28V220J	M 22 OHM 1/32 W	1	
	R8222	EXB28V220J	M 22 OHM 1/32 W	1	
	R8223	EXB28V220J	M 22 OHM 1/32 W	1	
	R8224	EXB28V220J	M 22 OHM 1/32 W	1	
	R8225	EXB28V220J	M 22 OHM 1/32 W	1	
	R8226	EXB28V220J	M 22 OHM 1/32 W	1	
	R8227	EXB28V220J	M 22 OHM 1/32 W	1	
	R8228	EXB28V220J	M 22 OHM 1/32 W	1	
	R8229	EXB28V220J	M 22 OHM 1/32 W	1	
	R8230	D0GA220JA023	M22 OHM, J.1/16 W	1	
	R8231	D0GA220JA023	M22 OHM, J.1/16 W	1	
	R8232	D0GA220JA023	M22 OHM, J.1/16 W	1	
	R8301	D0GA471JA023	M 470OHM, J,1/16W	1	

Model No. : TX-P50GT30E/J Parts List

Safety	Ref. No.	Part No.	Part Name & Description	Q'ty	Remarks
	R8302	DOGA360JA023	M 36 OHM, J,1/16W	1	PAVCCZ
	R8303	DOGA360JA023	M 36 OHM, J,1/16W	1	PAVCCZ
	R8304	D1BA6201A014	M 6.2KOHM, J,1/16 W	1	
	R8305	D1BA6201A014	M 6.2KOHM, J,1/16 W	1	
	R8307	D1BA6201A014	M 6.2KOHM, J,1/16 W	1	
	R8381	D1BA75R0A014	M 75 OHM, J,1/16 W	1	
	R8382	D1BA75R0A014	M 75 OHM, J,1/16 W	1	
	R8383	D1BA75R0A014	M 75 OHM, J,1/16 W	1	
	R8384	D1BA75R0A014	M 75 OHM, J,1/16 W	1	
	R8400	DOGA680JA023	M 68 OHM, J,1/16W	1	
	R8401	DOGA680JA023	M 68 OHM, J,1/16W	1	
	R8402	DOGA680JA023	M 68 OHM, J,1/16W	1	
	R8403	DOGA680JA023	M 68 OHM, J,1/16W	1	
	R8404	DOGA680JA023	M 68 OHM, J,1/16W	1	
	R8405	DOGA680JA023	M 68 OHM, J,1/16W	1	
	R8406	EXB2HV680J	M 68 OHM 1/16 W	1	
	R8407	EXB2HV680J	M 68 OHM 1/16 W	1	
	R8408	EXB2HV680J	M 68 OHM 1/16 W	1	
	R8409	EXB28V680JX	M 68 OHM 1/32 W	1	
	R8410	EXB2HV680J	M 68 OHM 1/16 W	1	
	R8411	EXB2HV680J	M 68 OHM 1/16 W	1	
	R8418	DOGA103JA015	M 10KOHM, J,1/16W	1	
	R8421	EXB2HV101J	M 100 OHM 1/16 W	1	
	R8424	DOGA223JA023	M 22K OHM J 1/16W	1	
	R8425	DOGA223JA023	M 22K OHM J 1/16W	1	
	R8426	DOGA473JA015	M 47KOHM, J,1/16W	1	
	R8427	DOGA473JA015	M 47KOHM, J,1/16W	1	
	R8429	DOGA103JA015	M 10KOHM, J,1/16W	1	
	R8433	DOGA103JA015	M 10KOHM, J,1/16W	1	
	R8434	DOGA103JA015	M 10KOHM, J,1/16W	1	
	R8435	DOGA223JA023	M 22K OHM J 1/16W	1	
	R8436	EXB2HV101J	M 100 OHM 1/16 W	1	
	R8437	EXB2HV473JV	M 47 KOHM 1/16 W	1	
	R8438	EXB2HV103JV	M 10 KOHM 1/16 W	1	
	R8440	DOGA103JA015	M 10KOHM, J,1/16W	1	
	R8441	DOGA103JA015	M 10KOHM, J,1/16W	1	
	R8442	DOGA103JA015	M 10KOHM, J,1/16W	1	
	R8606	DOGA472JA023	M 4.7KOHM, J,1/16W	1	
	R8607	DOGA472JA023	M 4.7KOHM, J,1/16W	1	
	R8608	DOGA102JA023	M1KOHM, J,1/16 W	1	
	R8609	D1BA6491A014	M6.49KOHM, J,1/16 W	1	
	R8610	DOGA221JA023	M220 OHM, J,1/16 W	1	
	R8611	D1BA49R9A014	M 49.9 OHM, J,1/16 W	1	
	R8612	D1BA49R9A014	M 49.9 OHM, J,1/16 W	1	
	R8613	D1BA49R9A014	M 49.9 OHM, J,1/16 W	1	
	R8614	D1BA49R9A014	M 49.9 OHM, J,1/16 W	1	
	R8615	DOGA105JA023	M 1M OHM, J,1/16W	1	
	R8617	DOGA103JA015	M 10KOHM, J,1/16W	1	
	R8618	DOGA103JA015	M 10KOHM, J,1/16W	1	
	R8620	DOGA103JA015	M 10KOHM, J,1/16W	1	
	R8621	DOGA103JA015	M 10KOHM, J,1/16W	1	
	R8624	DOGA560JA023	M 56 OHM, J,1/16W	1	
	R8625	DOGA560JA023	M 56 OHM, J,1/16W	1	
	R8626	DOGA560JA023	M 56 OHM, J,1/16W	1	
	R8627	DOGA560JA023	M 56 OHM, J,1/16W	1	
	R8628	DOGA560JA023	M 56 OHM, J,1/16W	1	
	R8629	DOGA560JA023	M 56 OHM, J,1/16W	1	
	R8630	D1HG1038A002	NETWORK RESISTER	1	
	R8631	DOGA560JA023	M 56 OHM, J,1/16W	1	
	R8632	EXB28V560JX	M 56 OHM 1/32 W	1	
	R8633	DOGA560JA023	M 56 OHM, J,1/16W	1	
	R8634	EXB28V560JX	M 56 OHM 1/32 W	1	

Model No. : TX-P50GT30E/J Parts List

Safety	Ref. No.	Part No.	Part Name & Description	Q'ty	Remarks
	R8636	D0GA220JA023	M22 OHM, J.1/16 W	1	
	R8637	D0GA272JA023	M 2.7KOHM, J.1/16W	1	
	R8638	D0GA272JA023	M 2.7KOHM, J.1/16W	1	
	R8639	D0GA103JA015	M 10KOHM, J,1/16W	1	
	R8640	D0GA103JA015	M 10KOHM, J,1/16W	1	
	R8642	D0GBR00J0004	M 0 OHM J 1/10W	1	
	R8643	D0GA272JA023	M 2.7KOHM, J.1/16W	1	
	R8645	D0GAR00J0005	M 0 OHM, 1/16W	1	
	R8646	D0GAR00J0005	M 0 OHM, 1/16W	1	
	R8648	D0GA273JA023	M 27K OHM J ,1/16W	1	
	R8649	D0GA103JA015	M 10KOHM, J,1/16W	1	
	R8650	D0GA560JA023	M 56 OHM, J,1/16W	1	
	R8652	D0GA101JA015	M 100 OHM, J,1/16W	1	
	R8653	D0GA560JA023	M 56 OHM, J,1/16W	1	
	R8654	EXB28V560JX	M 56 OHM 1/32 W	1	
	R8655	D0GA560JA023	M 56 OHM, J,1/16W	1	
	R8657	D0GBR00J0004	M 0 OHM J 1/10W	1	
	R8659	D0GA560JA023	M 56 OHM, J,1/16W	1	
	R8660	D0GA560JA023	M 56 OHM, J,1/16W	1	
	R8661	D0GA103JA015	M 10KOHM, J,1/16W	1	
	R8662	D0GA560JA023	M 56 OHM, J,1/16W	1	
	R8663	D0GA101JA015	M 100 OHM, J,1/16W	1	
	R8664	D0GA560JA023	M 56 OHM, J,1/16W	1	
	R8665	D0GA560JA023	M 56 OHM, J,1/16W	1	
	R8666	D0GA560JA023	M 56 OHM, J,1/16W	1	
	R8668	D0GA560JA023	M 56 OHM, J,1/16W	1	
	R8669	D0GBR00J0004	M 0 OHM J 1/10W	1	
	R8740	D0GD472JA052	M 4.7KOHM, J,1/8W	1	PAVCCZ
	R8741	D0GD472JA052	M 4.7KOHM, J,1/8W	1	PAVCCZ
	R8742	D1BB5362A055	M53.6KOHM, J.1/10W	1	PAVCCZ
	R8743	D1BB1002A055	M 10KOHM, J.1/10W	1	
	R8744	D0GA390JA023	M 39 OHM, J,1/16W	1	
	R8745	D1BB1002A055	M 10KOHM, J.1/10W	1	
	R8746	D0GA222JA023	M 2.2KOHM, J,1/16W	1	
	R8747	D0GA683JA023	M 68KOHM, J,1/16W	1	
	R8748	D0GA473JA015	M 47KOHM, J,1/16W	1	
	R8749	D0GA222JA023	M 2.2KOHM, J,1/16W	1	
	R8750	D0GA392JA023	M 3.9KOHM, J,1/16W	1	
	R8751	D0GA222JA023	M 2.2KOHM, J,1/16W	1	
	R8752	D0GA332JA023	M 3.3KOHM, J,1/16W	1	
	R8753	D0GA102JA023	M1KOHM, J.1/16 W	1	
	R8754	D0GA103JA015	M 10KOHM, J,1/16W	1	
	R8755	D0GB221JA065	M 220 OHM J 1/10W	1	
	R8756	D0GD104JA052	M 100KOHM, J,1/8W	1	PAVCCZ
	R8757	D0GD102JA052	M 1.0KOHM, J,1/8W	1	PAVCCZ
	R8758	D0GD472JA052	M 4.7KOHM, J,1/8W	1	PAVCCZ
	R8759	D0GD472JA052	M 4.7KOHM, J,1/8W	1	PAVCCZ
	R8760	D0GA104JA023	M100KOHM, J.1/16 W	1	
	R8765	D0GA103JA015	M 10KOHM, J,1/16W	1	
	R8767	D0GBR00J0004	M 0 OHM J 1/10W	1	
	R8768	D0GA390JA023	M 39 OHM, J,1/16W	1	
	R8769	D1BB4301A055	M4.30KOHM, J.1/10W	1	
	R8770	D1BB3922A055	M39.2KOHM, 1/10W	1	PAVCCZ
	R8771	D1BB1002A055	M 10KOHM, J.1/10W	1	
	R8772	D0GD472JA052	M 4.7KOHM, J,1/8W	1	PAVCCZ
	R8773	D0GD472JA052	M 4.7KOHM, J,1/8W	1	PAVCCZ
	R8776	D0GBR00J0004	M 0 OHM J 1/10W	1	
	R8777	D0GA390JA023	M 39 OHM, J,1/16W	1	
	R8778	D1BB4301A055	M4.30KOHM, J.1/10W	1	
	R8779	D1BB3922A055	M39.2KOHM, 1/10W	1	PAVCCZ
	R8780	D1BB1002A055	M 10KOHM, J.1/10W	1	
	R8806	D1BA7151A014	M7.15KOHM, J.1/16 W	1	

Model No. : TX-P50GT30E/J Parts List

Safety	Ref. No.	Part No.	Part Name & Description	Q'ty	Remarks
	R8807	D0GA102JA023	M1KOHM, J.1/16 W	1	
	R8811	D0GA103JA015	M 10KOHM, J,1/16W	1	
	R8816	D0GA103JA015	M 10KOHM, J,1/16W	1	
	R8818	D0GA103JA015	M 10KOHM, J,1/16W	1	
	R8819	D0GA103JA015	M 10KOHM, J,1/16W	1	
	R8820	D0GA103JA015	M 10KOHM, J,1/16W	1	
	R8821	D0GA473JA015	M 47KOHM, J,1/16W	1	
	R8824	D0GA103JA015	M 10KOHM, J,1/16W	1	
	R8831	D0GA103JA015	M 10KOHM, J,1/16W	1	
	R8835	D0GA103JA015	M 10KOHM, J,1/16W	1	
	R8848	D0GA102JA023	M1KOHM, J.1/16 W	1	
	R8849	D0GA103JA015	M 10KOHM, J,1/16W	1	
	R8852	D0GA243JA023	M 24K OHM J 0.063W	1	
	R8909	D0GA222JA023	M 2.2KOHM, J,1/16W	1	
	R8910	D0GA103JA015	M 10KOHM, J,1/16W	1	
	R8914	D0GA472JA023	M 4.7KOHM, J,1/16W	1	
	R8921	D0GA223JA023	M 22K OHM J 1/16W	1	
	R8964	D0GA472JA023	M 4.7KOHM, J,1/16W	1	
	R9035	D0GA332JA023	M 3.3KOHM, J,1/16W	1	
	R9103	D0GA101JA015	M 100 OHM, J,1/16W	1	
	R9104	D0GA101JA015	M 100 OHM, J,1/16W	1	
	R9105	D0GA473JA015	M 47KOHM, J,1/16W	1	
	R9198	EXB28V101JX	M 100 OHM 1/32 W	1	
	R9203	D0GA272JA023	M 2.7KOHM, J.1/16W	1	
	R9205	D0GA333JA023	M 33KOHM, J,1/16W	1	
	R9206	D0GA563JA023	M 56KOHM, J,0.063W	1	PAVCCZ
	R9208	EXB2HV470JV	M 47 OHM 1/16 W	1	
	R9209	EXB2HV470JV	M 47 OHM 1/16 W	1	
	R9224	D0GA470JA023	M 47 OHM, J,1/16W	1	
	R9226	D0GA470JA023	M 47 OHM, J,1/16W	1	
	R9247	D0GA470JA023	M 47 OHM, J,1/16W	1	
	R9307	D0GA470JA023	M 47 OHM, J,1/16W	1	
	R9308	D0GA470JA023	M 47 OHM, J,1/16W	1	
	R9310	D0GA101JA023	M 100 OHM, J,1/16W	1	PAVCCZ
	R9320	D0GA182JA023	M 1.8KOHM, J,0.063W	1	
	R9321	D0GA105JA023	M 1M OHM, J,1/16W	1	
	R9324	D0GB122JA065	M 1.2KOHM J 1/10W	1	PAVCCZ
	R9325	D0GB122JA065	M 1.2KOHM J 1/10W	1	PAVCCZ
	R9326	D0GB122JA065	M 1.2KOHM J 1/10W	1	PAVCCZ
	R9327	D0GB122JA065	M 1.2KOHM J 1/10W	1	PAVCCZ
	R9329	D0GA102JA023	M1KOHM, J.1/16 W	1	
	R9330	D0GA102JA023	M1KOHM, J.1/16 W	1	
	R9400	EXB2HV103JV	M 10 KOHM 1/16 W	1	
	R9401	EXB2HV103JV	M 10 KOHM 1/16 W	1	
	R9402	EXB28V103JX	M 10KOHM 1/32 W	1	
	R9503	D0GA473JA015	M 47KOHM, J,1/16W	1	
	R9508	EXB28V101JX	M 100 OHM 1/32 W	1	
	R9518	D0GA101JA023	M 100 OHM, J,1/16W	1	PAVCCZ
	R9519	D0GA101JA023	M 100 OHM, J,1/16W	1	PAVCCZ
	R9520	D0GA101JA023	M 100 OHM, J,1/16W	1	PAVCCZ
	R9521	D0GA101JA023	M 100 OHM, J,1/16W	1	PAVCCZ
	R9522	EXB28V102JX	M 1KOHM 1/32 W	1	
	R9524	D0GA470JA023	M 47 OHM, J,1/16W	1	
	R9526	D0GA221JA023	M220 OHM, J.1/16 W	1	
	R9527	D0GA470JA023	M 47 OHM, J,1/16W	1	
	R9528	D0GA470JA023	M 47 OHM, J,1/16W	1	
	R9529	D0GA470JA023	M 47 OHM, J,1/16W	1	
	R9533	EXB28V103JX	M 10KOHM 1/32 W	1	
	R9534	D0GA103JA015	M 10KOHM, J,1/16W	1	
	R9535	EXB28V470JX	M 47 OHM 1/32 W	1	
	R9536	D0GA470JA023	M 47 OHM, J,1/16W	1	
	R9541	D0GA470JA023	M 47 OHM, J,1/16W	1	

Model No. : TX-P50GT30E/J Parts List

Safety	Ref. No.	Part No.	Part Name & Description	Q'ty	Remarks
	R9542	D0GA470JA023	M 47 OHM, J,1/16W	1	
	R9603	D0GB122JA065	M 1.2KOHM J 1/10W	1	PAVCCZ
	R9604	D0GB122JA065	M 1.2KOHM J 1/10W	1	PAVCCZ
	R9605	D0GB122JA065	M 1.2KOHM J 1/10W	1	PAVCCZ
	R9606	D0GB122JA065	M 1.2KOHM J 1/10W	1	PAVCCZ
	R9608	EXB2HV470JV	M 47 OHM 1/16 W	1	
	R9610	EXB28V470JX	M 47 OHM 1/32 W	1	
	R9860	D1BB1911A074	M1.91 KOHM,J.1/10W	1	PAVCCZ
	R9861	D1BB1911A074	M1.91 KOHM,J.1/10W	1	PAVCCZ
	R9862	D1BB9100A087	M 910 OHM,J.1/10W	1	PAVCCZ
	R9863	D1BB9100A087	M 910 OHM,J.1/10W	1	PAVCCZ
	R9864	D0GB100JA065	M 10 OHM J 1/10W	1	
	R9865	D0GB100JA065	M 10 OHM J 1/10W	1	
	R9866	D0GA273JA023	M 27K OHM J ,1/16W	1	
	R9867	D0GA273JA023	M 27K OHM J ,1/16W	1	
	R9907	D0GA101JA015	M 100 OHM, J,1/16W	1	
⚠	RL100	K6B1AAY00081	RELAY	2	PAVCCZ
	RM2810	B3RAD0000168	REMOTE SENSOR	1	
	S10	K1KA03BA0061	3P CONNECTOR	1	
⚠	S202	J0LY00000161	SERGE ABSORBER	1	PAVCCZ
	SN2810	B3JB00000078	IC	1	
	SW2890	K0F126A00003	SWITCH	1	PAVCCZ
⚠	T201	G0C181K00005	PEAKING COIL	1	PAVCCZ
⚠	T202	G0C181K00005	PEAKING COIL	1	PAVCCZ
⚠	T301	G4CYAYY00239	TRANS	1	PAVCCZ
⚠	T302	G4CYAYY00239	TRANS	1	PAVCCZ
	T303	G0C200K00001	PEAKING COIL	1	PAVCCZ
⚠	T401	G4DYA0000278	TRANS	1	PAVCCZ
	T8301	G5BYC0000015	TRANS	1	
⚠	TU6775	J3ACBC000001	TUNER	1	PAVCCZ
	V14	K1KA06B00220	6P CONNECTOR	1	
	VR251	EVMAASA00BE4	CONTROL 22KOHMB	1	PAVCCZ
	VR600	EVMAASA00BE4	CONTROL 22KOHMB	1	PAVCCZ
	X8300	H0J245500110	CRYSTAL	1	PAVCCZ
	X8600	H0J250500109	CRYSTAL	1	
	X9300	H0J200500091	CRYSTAL	1	PAVCCZ
	ZA1	K4AD01A00002	TERMINAL	1	
	ZA100	K4AD01A00002	TERMINAL	1	
	ZA101	K4AD01A00002	TERMINAL	1	
	C10	K1MY40BA0345	40P CONNECTOR	1	
	C14	K1KY03AA0719	3P CONNECTOR	1	
	C20	K1MY40BA0345	40P CONNECTOR	1	
	C21	K1MY55BA0345	55P CONNECTOR	1	
	C26	K1MY30BA0345	30P CONNECTOR	1	
	C31	K1MY55BA0345	55P CONNECTOR	1	
	C35	K1KY04B00013	4P CONNECTOR	1	PAVCCZ
	C36	K1MY30BA0345	30P CONNECTOR	1	
	C16003	F1L2J562A022	C 5600PF, 630V	1	
	C16011	F2A2E191A264	E 190UF, 250V	1	PAVCCZ
	C16012	F2A2E191A264	E 190UF, 250V	1	PAVCCZ

Model No. : TX-P50GT30E/J Parts List

Safety	Ref. No.	Part No.	Part Name & Description	Q'ty	Remarks
	C16013	F2A2E191A264	E 190UF, 250V	1	PAVCCZ
	C16018	FOC2E115A280	C 1.1 UF 250 V	1	PAVCCZ
	C16024	F1L2J332A022	C 3300PF, 630V	1	
	C16041	ECJ1VB1H392K	C 3900UF, 50V	1	
	C16043	ECJ1VB1H392K	C 3900UF, 50V	1	
	C16044	F1E2J821A002	C 820PF, 630V	1	
	C16045	F1E2J821A002	C 820PF, 630V	1	
	C16051	ECJ1VB1H392K	C 3900UF, 50V	1	
	C16053	ECJ1VB1H392K	C 3900UF, 50V	1	
	C16061	F1E2J821A002	C 820PF, 630V	1	
	C16101	F1L2J222A022	C 2200PF, 630V	1	
	C16104	F1H1E470A130	C 47PF, 25V	1	
	C16105	F1H1E470A130	C 47PF, 25V	1	
	C16131	F1K1E475A134	C 4.7UF 25V	1	
	C16132	F1H1C105A145	C 1 uF 16 V	1	
	C16133	F2A1E1010130	E 100UF, 25V	1	PAVCCZ
	C16135	F1K1E105A029	C 1UF, 25V	1	
	C16153	F1K1E475A134	C 4.7UF 25V	1	
	C16154	F1K1E475A134	C 4.7UF 25V	1	
	C16191	F1K1E475A134	C 4.7UF 25V	1	
	C16192	F1H1C105A145	C 1 uF 16 V	1	
	C16193	F2A1E4700094	E 47UF, 25V	1	
	C16195	F1K1E105A029	C 1UF, 25V	1	
	C16201	FOC2E405A279	C 4.0 UF 250 V	1	PAVCCZ
	C16202	FOC2E405A279	C 4.0 UF 250 V	1	PAVCCZ
	C16242	F1H1C105A145	C 1 uF 16 V	1	
	C16243	ECJ1VB1H103K	C 0.01UF, 50V	1	
	C16244	F1J1A106A087	C 10UF, 10V	1	
	C16271	F2A1E151B705	E 150UF, 25V	1	PAVCCZ
	C16280	F1K1E105A029	C 1UF, 25V	1	
	C16285	F1H1H104A970	C 0.1UF, , 50V	1	
	C16286	F1H1H104A970	C 0.1UF, , 50V	1	
	C16287	F1H1H104A970	C 0.1UF, , 50V	1	
	C16314	F2A2E191A264	E 190UF, 250V	1	PAVCCZ
	C16315	ECJ1VB1A105K	C 1UF, 10V	1	
	C16316	ECJ1XB1C104K	C 0.1UF, Z, 16V	1	
	C16317	ECJ1VB1A105K	C 1UF, 10V	1	
	C16318	F1J1H104A717	C 0.1UF, 50V	1	
	C16319	F1J1H104A717	C 0.1UF, 50V	1	
	C16328	F2A2T131A021	E 130UF, 220V	1	PAVCCZ
	C16330	FOC2E115A280	C 1.1 UF 250 V	1	PAVCCZ
	C16362	F1L2J562A022	C 5600PF, 630V	1	
	C16363	F1L2J332A022	C 3300PF, 630V	1	
	C16401	F1L2J332A022	C 3300PF, 630V	1	
	C16402	F1L2J332A022	C 3300PF, 630V	1	
	C16403	F1L2J332A022	C 3300PF, 630V	1	
	C16411	F2A2E191A264	E 190UF, 250V	1	PAVCCZ
	C16412	F2A2E191A264	E 190UF, 250V	1	PAVCCZ
	C16413	F2A2E191A264	E 190UF, 250V	1	PAVCCZ
	C16414	F2A2E191A264	E 190UF, 250V	1	PAVCCZ
	C16415	FOC2E115A280	C 1.1 UF 250 V	1	PAVCCZ
	C16421	F1L2J332A022	C 3300PF, 630V	1	
	C16422	F1L2J332A022	C 3300PF, 630V	1	
	C16441	ECJ1VB1H392K	C 3900UF, 50V	1	
	C16442	ECJ1VB1H392K	C 3900UF, 50V	1	
	C16451	ECJ1VB1H392K	C 3900UF, 50V	1	
	C16452	ECJ1VB1H392K	C 3900UF, 50V	1	
	C16460	F1E2J222A002	C 2200PF, 630V	1	
	C16472	ECJ1VB1A105K	C 1UF, 10V	1	
	C16490	F1H1C105A145	C 1 uF 16 V	1	
	C16502	F1K1E475A134	C 4.7UF 25V	1	
	C16503	F2A1E151B705	E 150UF, 25V	1	PAVCCZ

Model No. : TX-P50GT30E/J Parts List

Safety	Ref. No.	Part No.	Part Name & Description	Q'ty	Remarks
	C16505	F1K1E105A029	C 1UF, 25V	1	
	C16506	F1H1C105A145	C 1 uF 16 V	1	
	C16507	FOC2E115A280	C 1.1 UF 250 V	1	PAVCCZ
	C16531	F1K1E475A134	C 4.7UF 25V	1	
	C16534	F1H1C105A145	C 1 uF 16 V	1	
	C16551	F1K1E475A134	C 4.7UF 25V	1	
	C16561	FLJ1A106A087	C 10UF, 10V	1	
	C16562	F1H1C105A145	C 1 uF 16 V	1	
	C16564	F1H1C105A145	C 1 uF 16 V	1	
	C16565	ECJ1VB1H103K	C 0.01UF, 50V	1	
	C16566	ECJ1VB1H103K	C 0.01UF, 50V	1	
	C16567	F1H1C105A145	C 1 uF 16 V	1	
	C16584	ECJ1VB1H392K	C 3900UF, 50V	1	
	C16593	ECJ1XC1H102J	C 1000PF, J, 50V	1	
	C16602	F1H1H2200008	C 22PF, 50V	1	
	C16603	F1K2J102A014	C 1000PF, 630V	1	
	C16604	F1K2J102A014	C 1000PF, 630V	1	
	C16631	FOC2E405A279	C 4.0 UF 250 V	1	PAVCCZ
	C16632	FOC2E405A279	C 4.0 UF 250 V	1	PAVCCZ
	C16641	F1K2J222A014	C 2200PF ,630V	1	
	C16645	F1K2J102A014	C 1000PF, 630V	1	
	C16646	F1K2J102A014	C 1000PF, 630V	1	
	C16661	F1K2J102A038	C 1000PF, 630V	1	
	C16662	F1K2J102A038	C 1000PF, 630V	1	
	C16664	ECJ1XC1H820J	C 82PF, J, 50V	1	
	C16665	ECJ1XC1H820J	C 82PF, J, 50V	1	
	C16666	ECJ1XC1H820J	C 82PF, J, 50V	1	
	C16668	F1H1H821A831	C 820 PF, 50V	1	PAVCCZ
	C16685	F1H1H104A970	C 0.1UF, , 50V	1	
	C16692	F1H1H104A970	C 0.1UF, , 50V	1	
	C16723	F1K1E105A029	C 1UF, 25V	1	
	C16724	F1K1E475A134	C 4.7UF 25V	1	
	C16753	F1K1E475A134	C 4.7UF 25V	1	
	C16770	F1H1C105A145	C 1 uF 16 V	1	
	C16791	F2A1E151B705	E 150UF, 25V	1	PAVCCZ
	C16793	F2A1E151B705	E 150UF, 25V	1	PAVCCZ
	C16794	FLJ1A106A087	C 10UF, 10V	1	
	C16795	F2A1E151B705	E 150UF, 25V	1	PAVCCZ
	C16796	F1K1E475A134	C 4.7UF 25V	1	
	C16797	F1H1H104A970	C 0.1UF, , 50V	1	
	C16813	F2A2T131A021	E 130UF, 220V	1	PAVCCZ
	C16833	F1K2J222A014	C 2200PF ,630V	1	
	C16834	F1K2J222A014	C 2200PF ,630V	1	
	C16842	F2A2C131A210	E 130UF, 160V	1	PAVCCZ
	C16843	ECJ1VB1A105K	C 1UF, 10V	1	
	C16844	FLJ1H104A717	C 0.1UF, 50V	1	
	C16854	FLJ1H104A717	C 0.1UF, 50V	1	
	C16856	ECJ1VB1A105K	C 1UF, 10V	1	
	C16858	ECJ1XB1C104K	C 0.1UF, Z, 16V	1	
	C16859	FLJ1H104A717	C 0.1UF, 50V	1	
	C16860	ECJ1VB1A105K	C 1UF, 10V	1	
	C16861	ECJ1XB1C104K	C 0.1UF, Z, 16V	1	
	C16862	ECJ1VB1A105K	C 1UF, 10V	1	
	C16863	FLJ1H104A717	C 0.1UF, 50V	1	
	C16865	F1H1C105A145	C 1 uF 16 V	1	
	C16891	F1K1E105A029	C 1UF, 25V	1	
	C16902	F1E2J472A001	C 4700PF, 630V	1	
	C16903	F1E2J152A002	C 1500PF, 630V	1	
	C16907	F1E2J221A002	C 220PF, 630V	1	
	C16910	F1E2J821A002	C 820PF, 630V	1	
	C16912	F1E2J821A002	C 820PF, 630V	1	
	C17101	ECJ1VB1A105K	C 1UF, 10V	1	

Model No. : TX-P50GT30E/J Parts List

Safety	Ref. No.	Part No.	Part Name & Description	Q'ty	Remarks
	C17102	ECJ1VB1A105K	C 1UF, 10V	1	
	C17103	ECJ1VB1A105K	C 1UF, 10V	1	
	C17109	F1K2A224A033	C 0.22UF, 100V	1	PAVCCZ
	C17110	F1K2A224A033	C 0.22UF, 100V	1	PAVCCZ
	C17112	F1K2A224A033	C 0.22UF, 100V	1	PAVCCZ
	C17114	ECJ1XC1H102J	C 1000PF, J, 50V	1	
	C17115	ECJ1XC1H102J	C 1000PF, J, 50V	1	
	C17116	ECJ1XC1H102J	C 1000PF, J, 50V	1	
	C17117	ECJ1XC1H102J	C 1000PF, J, 50V	1	
	C17201	ECJ1VB1A105K	C 1UF, 10V	1	
	C17202	ECJ1VB1A105K	C 1UF, 10V	1	
	C17203	ECJ1VB1A105K	C 1UF, 10V	1	
	C17204	ECJ1VB1A105K	C 1UF, 10V	1	
	C17205	ECJ1VB1A105K	C 1UF, 10V	1	
	C17206	ECJ1VB1A105K	C 1UF, 10V	1	
	C17207	ECJ1XB1C104K	C 0.1UF, Z, 16V	1	
	C17208	ECJ1XB1C104K	C 0.1UF, Z, 16V	1	
	C17223	F1K2A224A033	C 0.22UF, 100V	1	PAVCCZ
	C17224	F1K2A224A033	C 0.22UF, 100V	1	PAVCCZ
	C17228	F1K2A224A033	C 0.22UF, 100V	1	PAVCCZ
	C17229	F1K2A224A033	C 0.22UF, 100V	1	PAVCCZ
	C17231	F1K2A224A033	C 0.22UF, 100V	1	PAVCCZ
	C17233	F1K2A224A033	C 0.22UF, 100V	1	PAVCCZ
	C17301	ECJ1VB1A105K	C 1UF, 10V	1	
	C17302	ECJ1VB1A105K	C 1UF, 10V	1	
	C17303	ECJ1VB1A105K	C 1UF, 10V	1	
	C17304	ECJ1VB1A105K	C 1UF, 10V	1	
	C17305	ECJ1VB1A105K	C 1UF, 10V	1	
	C17306	ECJ1VB1A105K	C 1UF, 10V	1	
	C17307	ECJ1XB1C104K	C 0.1UF, Z, 16V	1	
	C17328	F1K2A224A033	C 0.22UF, 100V	1	PAVCCZ
	C17330	F1K2A224A033	C 0.22UF, 100V	1	PAVCCZ
	C17331	F1L2E224A028	C 0.22UF, 250V	1	
	C17334	F1L2E224A028	C 0.22UF, 250V	1	
	C17336	F1K2A224A033	C 0.22UF, 100V	1	PAVCCZ
	C17337	F1K2A224A033	C 0.22UF, 100V	1	PAVCCZ
	CB1	K1MY55B00002	55P CONNECTOR	1	
	CB2	K1MY55B00002	55P CONNECTOR	1	
	CB3	K1MY55B00002	55P CONNECTOR	1	
	CB4	K1MY55B00002	55P CONNECTOR	1	
	CB5	K1MY55B00002	55P CONNECTOR	1	
	CB6	K1MY55B00002	55P CONNECTOR	1	
	CB7	K1MY55B00002	55P CONNECTOR	1	
	CB8	K1MY55B00002	55P CONNECTOR	1	
	CB9	K1MY55B00002	55P CONNECTOR	1	
	CB10	K1MY55B00002	55P CONNECTOR	1	
	CB11	K1MY55B00002	55P CONNECTOR	1	
	CB12	K1MY55B00002	55P CONNECTOR	1	
	CB13	K1MY55B00002	55P CONNECTOR	1	
	CB14	K1MY55B00002	55P CONNECTOR	1	
	CB15	K1MY55B00002	55P CONNECTOR	1	
	D16001	DA3CF30ACL	ZENER DIODE	1	PAVCCZ
	D16021	DA3CF30ACL	ZENER DIODE	1	PAVCCZ
	D16041	BOFCCN000003	DIODE	1	
	D16043	BOFCCN000003	DIODE	1	
	D16051	BOFCCN000001	DIODE	1	
	D16053	BOFCCN000001	DIODE	1	
	D16071	BOECKP000055	DIODE	1	
	D16072	DA3CF30ACL	ZENER DIODE	1	PAVCCZ
	D16131	BOECKP000055	DIODE	1	

Model No. : TX-P50GT30E/J Parts List

Safety	Ref. No.	Part No.	Part Name & Description	Q'ty	Remarks
	D16133	B0ACJ000048	DIODE	1	
	D16134	DZ2J051M0L	ZENER DIODE	1	
	D16191	B0ECKP000055	DIODE	1	
	D16192	B0ACJ000048	DIODE	1	
	D16193	DZ2J051M0L	ZENER DIODE	1	
	D16243	B0ADCJ000100	DIODE	1	
	D16251	DZ2J330M0L	ZENER DIODE	1	
	D16252	DZ2J330M0L	ZENER DIODE	1	
	D16253	DZ2J051M0L	ZENER DIODE	1	
	D16254	B3ABB0000210	LED	1	
	D16255	B0ADCJ000100	DIODE	1	
	D16282	DZ2J068M0L	ZENER DIODE	1	
	D16285	B0ADEJ000035	ZENER DIODE	1	
	D16286	B0ACJ000048	DIODE	1	
	D16315	DZ2J150M0L	ZENER DIODE	1	
	D16316	B0ECKP000055	DIODE	1	
	D16317	B0ECKP000055	DIODE	1	
	D16362	DA3CF30ACL	ZENER DIODE	1	PAVCCZ
	D16401	B0FCCN000003	DIODE	1	
	D16407	B0JCME000093	DIODE	1	
	D16411	B0ADCJ000100	DIODE	1	
	D16413	B0ACJ000048	DIODE	1	
	D16421	DA3CF30ACL	ZENER DIODE	1	PAVCCZ
	D16430	B0ECKP000055	DIODE	1	
	D16432	B0FCBN000001	DIODE	1	PAVCCZ
	D16461	B0FCCN000003	DIODE	1	
	D16462	B0FCCN000003	DIODE	1	
	D16473	B0ACJ000048	DIODE	1	
	D16474	B0ACJ000048	DIODE	1	
	D16475	DZ2J051M0L	ZENER DIODE	1	
	D16476	B0ACJ000048	DIODE	1	
	D16481	B0FCCN000001	DIODE	1	
	D16482	B0FCCN000001	DIODE	1	
	D16491	B0ACJ000048	DIODE	1	
	D16492	DZ2J047M0L	ZENER DIODE	1	
	D16493	B0ADCJ000100	DIODE	1	
	D16506	DZ2J051M0L	ZENER DIODE	1	
	D16534	DZ2J051M0L	ZENER DIODE	1	
	D16536	B0ECKP000055	DIODE	1	
	D16537	B0ADCJ000100	DIODE	1	
	D16538	B0ADCJ000100	DIODE	1	
	D16581	DZ2J330M0L	ZENER DIODE	1	
	D16582	DZ2J330M0L	ZENER DIODE	1	
	D16583	B3ABB0000210	LED	1	
	D16602	DZ2J043M0L	ZENER DIODE	1	
	D16603	B0ACJ000048	DIODE	1	
	D16604	B0ADCJ000100	DIODE	1	
	D16605	B0ACJ000048	DIODE	1	
	D16607	B0ACJ000048	DIODE	1	
	D16608	B0ECKP000055	DIODE	1	
	D16609	B0ECKP000055	DIODE	1	
	D16618	B0ECKP000055	DIODE	1	
	D16641	B0FCCN000004	DIODE	1	PAVCCZ
	D16642	B0FCCN000004	DIODE	1	PAVCCZ
	D16643	B0FCCN000004	DIODE	1	PAVCCZ
	D16645	DZ2J150M0L	ZENER DIODE	1	
	D16646	DZ2J150M0L	ZENER DIODE	1	
	D16647	DZ2J150M0L	ZENER DIODE	1	
	D16648	DZ2J043M0L	ZENER DIODE	1	
	D16651	DZ2J051M0L	ZENER DIODE	1	
	D16652	B0ECKP000055	DIODE	1	
	D16662	DZ2J150M0L	ZENER DIODE	1	

Model No. : TX-P50GT30E/J Parts List

Safety	Ref. No.	Part No.	Part Name & Description	Q'ty	Remarks
	D16663	DZ2J150M0L	ZENER DIODE	1	
	D16664	DZ2J150M0L	ZENER DIODE	1	
	D16669	B0ACJ000048	DIODE	1	
	D16673	B0ECHR000004	DIODE	1	PAVCCZ
	D16674	B0ECHR000004	DIODE	1	PAVCCZ
	D16685	B0ACJ000048	DIODE	1	
	D16710	DZ2J15000L	ZENER DIODE	1	
	D16711	B0ECHR000004	DIODE	1	PAVCCZ
	D16712	B0ECHR000004	DIODE	1	PAVCCZ
	D16713	B0ECHS000002	DIODE	1	PAVCCZ
	D16714	B0ECHS000002	DIODE	1	PAVCCZ
	D16720	B0ECHR000004	DIODE	1	PAVCCZ
	D16728	B0ECKP000055	DIODE	1	
	D16791	DZ2J240M0L	ZENER DIODE	1	
	D16792	B0ACJ000048	DIODE	1	
	D16795	B0ACJ000048	DIODE	1	
	D16822	B0ACJ000048	DIODE	1	
	D16823	B0ADCJ000100	DIODE	1	
	D16824	B0ACJ000048	DIODE	1	
	D16825	DZ2J330M0L	ZENER DIODE	1	
	D16833	B0ECHR000004	DIODE	1	PAVCCZ
	D17101	B0ACJ000048	DIODE	1	
	D17102	B0ACJ000048	DIODE	1	
	D17103	B0JCCD000020	DIODE	1	PAVCCZ
	D17301	B0ACJ000048	DIODE	1	
	D17302	B0ACJ000048	DIODE	1	
	D17303	B0JCCD000020	DIODE	1	PAVCCZ
	IC16131	COZBZ0001822	IC	1	PAVCCZ
	IC16132	COZBZ0001822	IC	1	PAVCCZ
	IC16151	COZBZ0001822	IC	1	PAVCCZ
	IC16152	COZBZ0001822	IC	1	PAVCCZ
	IC16191	COZBZ0001822	IC	1	PAVCCZ
	IC16241	COJBAU000088	IC	1	
	IC16243	COJBAB000715	IC	1	
	IC16244	COJBAA000558	IC	1	PAVCCZ
	IC16304	MIP3910MSSCF	IC	1	
	IC16312	C0DBZMC00006	IC	1	
	IC16471	C0DBEYY00114	IC	1	
	IC16490	C0DBZMC00006	IC	1	
	IC16491	COBBAA000008	LINEAR IC	1	
	IC16501	COZBZ0001822	IC	1	PAVCCZ
	IC16502	COZBZ0001822	IC	1	PAVCCZ
	IC16521	COZBZ0001822	IC	1	PAVCCZ
	IC16522	COZBZ0001822	IC	1	PAVCCZ
	IC16561	COJBAU000088	IC	1	
	IC16562	COJBAU000088	IC	1	
	IC16563	COJBAB000996	IC	1	PAVCCZ
	IC16564	COJBAE000321	IC	1	
	IC16565	COJBAE000321	IC	1	
	IC16684	COZBZ0001822	IC	1	PAVCCZ
	IC16691	COJBAC000509	IC	1	PAVCCZ
	IC16724	COCBAD00049	IC	1	
	IC16784	MIP3910MSSCF	IC	1	
	IC16785	C0DBZYY00352	IC	1	
	IC16786	MIP3910MSSCF	IC	1	
	IC16787	C0DBZYY00352	IC	1	
	IC16792	COBBAA000008	LINEAR IC	1	
	IC16793	C0DBZMC00006	IC	1	
	IC16795	COCBALC00012	IC	1	
	IC16921	C1ZBZ0004292	IC	1	PAVCCZ
	IC17201	COJBAU000088	IC	1	

Model No. : TX-P50GT30E/J Parts List

Safety	Ref. No.	Part No.	Part Name & Description	Q'ty	Remarks
	IC17202	COJBAU000088	IC	1	
	IC17301	COJBAU000088	IC	1	
	L16001	G0CR16KA0214	PEAKING COIL	1	PAVCCZ
	L16002	G0CR16KA0214	PEAKING COIL	1	PAVCCZ
	L16303	G0C471MA0049	PEAKING COIL	1	
	L16411	G0CR16KA0214	PEAKING COIL	1	PAVCCZ
	L16412	G0CR16KA0214	PEAKING COIL	1	PAVCCZ
	PC16131	B3PBE0000058	IC	1	PAVCCZ
	PC16191	B3PBE0000060	IC	1	PAVCCZ
	PC16251	B3PBA0000498	IC	1	
	PC16301	B3PBA0000498	IC	1	
	PC16461	B3PBE0000058	IC	1	PAVCCZ
	PC16462	B3PBE0000060	IC	1	PAVCCZ
	PC16480	B3PBA0000498	IC	1	
	PC16581	B3PBA0000498	IC	1	
	PC16603	B3PBA0000498	IC	1	
	PC16685	B3PBA0000496	IC	1	
	PC16723	B3PBA0000498	IC	1	
	PC16896	B3PBA0000498	IC	1	
	PC16897	B3PBA0000498	IC	1	
	Q16001	B1JBDN000004	TRANSISTOR	1	PAVCCZ
	Q16002	B1JBDN000004	TRANSISTOR	1	PAVCCZ
	Q16003	B1JBDN000004	TRANSISTOR	1	PAVCCZ
	Q16021	B1JBEN000004	TRANSISTOR	1	PAVCCZ
	Q16022	B1JBEN000004	TRANSISTOR	1	PAVCCZ
	Q16023	B1JBEN000004	TRANSISTOR	1	PAVCCZ
	Q16041	DG3C3020CL	TRANSISTOR	1	PAVCCZ
	Q16043	DG3C3020CL	TRANSISTOR	1	PAVCCZ
	Q16051	DG3C3020CL	TRANSISTOR	1	PAVCCZ
	Q16053	DG3C3020CL	TRANSISTOR	1	PAVCCZ
	Q16055	B1HFPPA00001	TRANSISTOR	1	
	Q16056	B1HFPPA00001	TRANSISTOR	1	
	Q16101	B1CFRM000015	FET	1	
	Q16102	B1CFRM000023	FET	1	PAVCCZ
	Q16141	B1HFPPA00001	TRANSISTOR	1	
	Q16161	B1HFPPA00001	TRANSISTOR	1	
	Q16251	B1ABCF000231	TRANSISTOR	1	
	Q16280	B1ABCE000015	TRANSISTOR	1	
	Q16401	B1JBDN000004	TRANSISTOR	1	PAVCCZ
	Q16402	B1JBDN000004	TRANSISTOR	1	PAVCCZ
	Q16403	B1JBDN000004	TRANSISTOR	1	PAVCCZ
	Q16421	B1JBEN000004	TRANSISTOR	1	PAVCCZ
	Q16422	B1JBEN000004	TRANSISTOR	1	PAVCCZ
	Q16423	B1JBEN000004	TRANSISTOR	1	PAVCCZ
	Q16441	DG3C3020CL	TRANSISTOR	1	PAVCCZ
	Q16442	DG3C3020CL	TRANSISTOR	1	PAVCCZ
	Q16451	DG3C3020CL	TRANSISTOR	1	PAVCCZ
	Q16452	DG3C3020CL	TRANSISTOR	1	PAVCCZ
	Q16471	B1ABCE000015	TRANSISTOR	1	
	Q16501	B1HFPPA00001	TRANSISTOR	1	
	Q16521	B1HFPPA00001	TRANSISTOR	1	
	Q16531	B1HFPPA00001	TRANSISTOR	1	
	Q16538	B1CBGD000001	FET	1	
	Q16551	B1HFPPA00001	TRANSISTOR	1	
	Q16581	B1ABCF000231	TRANSISTOR	1	
	Q16600	B1CFRM000020	FET	1	PAVCCZ
	Q16601	B1CFRQ000022	FET	1	PAVCCZ
	Q16602	DSA2001S0L	TRANSISTOR	1	
	Q16606	DSC2001S0L	TRANSISTOR	1	

Model No. : TX-P50GT30E/J Parts List

Safety	Ref. No.	Part No.	Part Name & Description	Q'ty	Remarks
	Q16607	B1CBGD000001	FET	1	
	Q16621	B1JBDN000004	TRANSISTOR	1	PAVCCZ
	Q16622	B1JBDN000004	TRANSISTOR	1	PAVCCZ
	Q16623	B1JBDN000004	TRANSISTOR	1	PAVCCZ
	Q16646	DSA2001S0L	TRANSISTOR	1	
	Q16647	B1CBGD000001	FET	1	
	Q16660	B1CFRQ000021	FET	1	PAVCCZ
	Q16661	B1JBER000002	TRANSISTOR	1	PAVCCZ
	Q16762	B1HFFFA00001	TRANSISTOR	1	
	Q16815	B1ABCN000007	TRANSISTOR	1	
	Q16817	DSC2001Q0L	TRANSISTOR	1	
	Q16818	B1CBGD000001	FET	1	
	Q16819	B1CBGD000001	FET	1	
	Q16820	B1CBGD000001	FET	1	
	Q16891	DSA2001S0L	TRANSISTOR	1	
	Q16892	DSC2001Q0L	TRANSISTOR	1	
	Q16921	B1CBGD000001	FET	1	
	Q16922	B1CBGD000001	FET	1	
	Q16931	B1ABCN000007	TRANSISTOR	1	
	Q17101	B1ABCN000007	TRANSISTOR	1	
	Q17301	B1ABCN000007	TRANSISTOR	1	
	R16001	D0GF7R5JA047	M 7.5 OHM, J, 1/3W	1	
	R16002	D0GF7R5JA047	M 7.5 OHM, J, 1/3W	1	
	R16003	D0GF7R5JA047	M 7.5 OHM, J, 1/3W	1	
	R16021	D0GF7R5JA047	M 7.5 OHM, J, 1/3W	1	
	R16022	D0GF7R5JA047	M 7.5 OHM, J, 1/3W	1	
	R16023	D0GF7R5JA047	M 7.5 OHM, J, 1/3W	1	
	R16031	D0GF473JA048	M 47KOHM, J, 1/3W	1	PAVCCZ
	R16032	D0GF473JA048	M 47KOHM, J, 1/3W	1	PAVCCZ
	R16041	D0GF5R6JA047	M 5.6 OHM, J, 1/3W	1	
	R16043	D0GF5R6JA047	M 5.6 OHM, J, 1/3W	1	
	R16051	D0GF5R6JA047	M 5.6 OHM, J, 1/3W	1	
	R16053	D0GF5R6JA047	M 5.6 OHM, J, 1/3W	1	
	R16101	D0GD150JA059	M 15 OHM, J, 1/4W	1	
	R16102	D0GD150JA059	M 15 OHM, J, 1/4W	1	
	R16105	D0GF474JA048	M 47KOHM, J, 1/3W	1	PAVCCZ
	R16116	D0GB473JA065	M 47KOHM J. 1/10W	1	PAVCCZ
	R16130	D0GB103JA065	M 10K OHM J 1/10W	1	
	R16131	D0GB220JA065	M 22 OHM J 1/10W	1	PAVCCZ
	R16132	D0GB101JA065	M 100 OHM, J, 1/10W	1	
	R16133	D1BD2700A044	M 270 OHM, J, 1/8 W	1	
	R16134	D0GD750JA059	M 75 OHM, J, 1/4W	1	
	R16135	D0GB4R7JA065	M 4.7 OHM J 1/10W	1	PAVCCZ
	R16137	D0GZ1R0JA020	M 1 OHM, J, 1/2W	1	
	R16138	D0GF561JA047	M 560 OHM, J, 1/3W	1	PAVCCZ
	R16141	D0GD100JA059	M 10 OHM, J, 1/4W	1	
	R16143	D0GB473JA065	M 47KOHM J. 1/10W	1	PAVCCZ
	R16151	D0GB220JA065	M 22 OHM J 1/10W	1	PAVCCZ
	R16152	D0GB220JA065	M 22 OHM J 1/10W	1	PAVCCZ
	R16153	D0GB331JA065	M330 OHM J 1/10W	1	PAVCCZ
	R16154	D0GD750JA059	M 75 OHM, J, 1/4W	1	
	R16155	D0GB4R7JA065	M 4.7 OHM J 1/10W	1	PAVCCZ
	R16161	D0GD100JA059	M 10 OHM, J, 1/4W	1	
	R16163	D0GB473JA065	M 47KOHM J. 1/10W	1	PAVCCZ
	R16171	D0GD100JA059	M 10 OHM, J, 1/4W	1	
	R16173	D0GB473JA065	M 47KOHM J. 1/10W	1	PAVCCZ
	R16181	D0GD100JA059	M 10 OHM, J, 1/4W	1	
	R16183	D0GB473JA065	M 47KOHM J. 1/10W	1	PAVCCZ
	R16191	D1BD2700A044	M 270 OHM, J, 1/8 W	1	
	R16192	D0GB103JA065	M 10K OHM J 1/10W	1	
	R16193	D0GD750JA052	M 75 OHM, J, 1/8W	1	PAVCCZ

Model No. : TX-P50GT30E/J Parts List

Safety	Ref. No.	Part No.	Part Name & Description	Q'ty	Remarks
	R16195	D0GF1R0JA047	M 1 OHM,J,1/3W	1	
	R16196	D0GF102JA048	M 1.0 KOHM,J,1/3W	1	PAVCCZ
	R16197	D0GB220JA065	M 22 OHM J 1/10W	1	PAVCCZ
	R16230	D0GD470JA052	M 47 OHM,J,1/8W	1	PAVCCZ
	R16231	D0GB472JA065	M 4.7KOHM, J,1/10W	1	
	R16241	EXB38V470J	M 47 OHM 1/16 W	1	
	R16242	EXB38V472JV	M 4.7 kOHM 1/16 W	1	
	R16243	D0GB103JA065	M 10K OHM J 1/10W	1	
	R16244	D0GB273JA065	M 27K OHM J 1/10W	1	PAVCCZ
	R16245	D0GB472JA065	M 4.7KOHM, J,1/10W	1	
	R16246	D0GD222JA052	M 2.2KOHM,J,1/8W	1	PAVCCZ
	R16252	D0GF563JA048	M 56 KOHM,J,1/3W	1	PAVCCZ
	R16253	D1BD1003A044	M 100KOHM,J.1/8 W	1	
	R16254	D1BD4422A044	M44.2KOHM,F.1/8W	1	PAVCCZ
	R16255	D0GB103JA065	M 10K OHM J 1/10W	1	
	R16257	D0GB473JA065	M 47KOHM J. 1/10W	1	PAVCCZ
	R16281	D0GB103JA065	M 10K OHM J 1/10W	1	
	R16282	D0GD221JA052	M 220 OHM,J 1/4W	1	PAVCCZ
	R16283	D0GB473JA065	M 47KOHM J. 1/10W	1	PAVCCZ
	R16284	D0GB224JA065	M 220KOHM,J,1/10W	1	PAVCCZ
	R16285	EXB38V623J	M 62 kOHM 1/16 W	1	
	R16288	D0GF334JA047	M 330KOHMJ,1/3W	1	
	R16289	D0GF334JA047	M 330KOHMJ,1/3W	1	
	R16290	D0GF334JA047	M 330KOHMJ,1/3W	1	
	R16307	D1BD5232A077	M52.3KOHM,D.1/10W	1	PAVCCZ
	R16309	ERG2FJX563	M 56KOHM, J, 2W	1	PAVCCZ
	R16310	ERG2FJX563	M 56KOHM, J, 2W	1	PAVCCZ
	R16311	ERG2FJX563	M 56KOHM, J, 2W	1	PAVCCZ
	R16317	D1BD5762A077	M57.6KOHM,D.1/10W	1	PAVCCZ
	R16318	D1BD5762A077	M57.6KOHM,D.1/10W	1	PAVCCZ
	R16319	D1BD2491A077	M 2.49KOHM,D.1/10W	1	PAVCCZ
	R16320	ERJ14YJ683	M 68KOHM, J. 1/4W	1	
	R16330	D0GB102JA065	M 1KOHM,J,1/10W	1	
	R16332	D0GB474JA065	M 470KOHM,J,1/10W	1	
	R16334	D0GB472JA065	M 4.7KOHM, J,1/10W	1	
	R16335	D0GB102JA065	M 1KOHM,J,1/10W	1	
	R16401	D0GF7R5JA047	M 7.5 OHM,J, 1/3W	1	
	R16402	D0GF7R5JA047	M 7.5 OHM,J, 1/3W	1	
	R16403	D0GF7R5JA047	M 7.5 OHM,J, 1/3W	1	
	R16411	D1BD2700A044	M 270 OHM,J.1/8 W	1	
	R16412	D1BD2700A044	M 270 OHM,J.1/8 W	1	
	R16414	D0GB103JA065	M 10K OHM J 1/10W	1	
	R16416	D0GB103JA065	M 10K OHM J 1/10W	1	
	R16421	D0GF7R5JA047	M 7.5 OHM,J, 1/3W	1	
	R16422	D0GF7R5JA047	M 7.5 OHM,J, 1/3W	1	
	R16423	D0GF7R5JA047	M 7.5 OHM,J, 1/3W	1	
	R16441	D0GF5R6JA047	M 5.6 OHM,J, 1/3W	1	
	R16442	D0GF5R6JA047	M 5.6 OHM,J, 1/3W	1	
	R16451	D0GF5R6JA047	M 5.6 OHM,J, 1/3W	1	
	R16452	D0GF5R6JA047	M 5.6 OHM,J, 1/3W	1	
	R16466	D0GF473JA048	M 47KOHM,J,1/3W	1	PAVCCZ
	R16467	D0GF473JA048	M 47KOHM,J,1/3W	1	PAVCCZ
	R16471	D0GB392JA065	M 3.9KOHM,J,1/10W	1	PAVCCZ
	R16472	D0GB222JA065	M 2.2KOHM,J,1/10W	1	
	R16473	D0GD561JA052	M 560 OHM,J,1/4W	1	PAVCCZ
	R16474	D0GB102JA065	M 1KOHM,J,1/10W	1	
	R16475	D0GB472JA065	M 4.7KOHM, J,1/10W	1	
	R16476	D0GB222JA065	M 2.2KOHM,J,1/10W	1	
	R16478	D0GB562JA065	M 5.6KOHM,J,1/10W	1	PAVCCZ
	R16479	D0GD103JA052	M 10KOHM,J,1/8W	1	PAVCCZ
	R16490	D1BD1203A077	M 120KOHM,D.1/10W	1	PAVCCZ
	R16491	D1BD1203A077	M 120KOHM,D.1/10W	1	PAVCCZ

Model No. : TX-P50GT30E/J Parts List

Safety	Ref. No.	Part No.	Part Name & Description	Q'ty	Remarks
	R16492	D1BD1203A077	M 120KOHM,D.1/10W	1	PAVCCZ
	R16493	D1BD5111A077	M5.11KOHM.J.1/8 W	1	PAVCCZ
	R16494	D1BB2001A055	M 2KOHM,J.1/10W	1	
	R16497	D0GB473JA065	M 47KOHM J. 1/10W	1	PAVCCZ
	R16498	D0GB103JA065	M 10K OHM J 1/10W	1	
	R16501	D0GB220JA065	M 22 OHM J 1/10W	1	PAVCCZ
	R16503	D0GD100JA059	M 10 OHM,J,1/4W	1	
	R16505	D0GF102JA048	M 1.0 KOHM,J,1/3W	1	PAVCCZ
	R16506	D0GD100JA059	M 10 OHM,J,1/4W	1	
	R16507	D0GB220JA065	M 22 OHM J 1/10W	1	PAVCCZ
	R16508	D0GB220JA065	M 22 OHM J 1/10W	1	PAVCCZ
	R16512	D0GB473JA065	M 47KOHM J. 1/10W	1	PAVCCZ
	R16517	D0GB473JA065	M 47KOHM J. 1/10W	1	PAVCCZ
	R16522	D0GB101JA065	M 100 OHM,J,1/10W	1	
	R16525	D0GB4R7JA065	M 4.7 OHM J 1/10W	1	PAVCCZ
	R16526	D0GB4R7JA065	M 4.7 OHM J 1/10W	1	PAVCCZ
	R16531	D0GD100JA059	M 10 OHM,J,1/4W	1	
	R16532	D0GB473JA065	M 47KOHM J. 1/10W	1	PAVCCZ
	R16534	D0GF561JA047	M 560 OHM,J, 1/3W	1	PAVCCZ
	R16536	D0GF1R0JA047	M 1 OHM,J,1/3W	1	
	R16537	D0GF1R0JA047	M 1 OHM,J,1/3W	1	
	R16551	D0GD100JA059	M 10 OHM,J,1/4W	1	
	R16552	D0GB473JA065	M 47KOHM J. 1/10W	1	PAVCCZ
	R16561	EXB38V470J	M 47 OHM 1/16 W	1	
	R16562	EXB38V470J	M 47 OHM 1/16 W	1	
	R16563	EXB38V470J	M 47 OHM 1/16 W	1	
	R16564	EXB38V470J	M 47 OHM 1/16 W	1	
	R16565	EXB38V472JV	M 4.7 KOHM 1/16 W	1	
	R16566	EXB38V472JV	M 4.7 KOHM 1/16 W	1	
	R16567	EXB38V472JV	M 4.7 KOHM 1/16 W	1	
	R16568	EXB38V472JV	M 4.7 KOHM 1/16 W	1	
	R16570	EXB38V472JV	M 4.7 KOHM 1/16 W	1	
	R16573	D0GB103JA065	M 10K OHM J 1/10W	1	
	R16574	D0GB103JA065	M 10K OHM J 1/10W	1	
	R16575	D0GB751JA065	M750 OHM J 1/10W	1	PAVCCZ
	R16576	D0GB101JA065	M 100 OHM,J,1/10W	1	
	R16579	EXB38V470J	M 47 OHM 1/16 W	1	
	R16581	D0GB103JA065	M 10K OHM J 1/10W	1	
	R16582	D0GF563JA048	M 56 KOHM,J,1/3W	1	PAVCCZ
	R16583	D1BD1003A044	M 100KOHM,J.1/8 W	1	
	R16584	D1BD4422A044	M44.2KOHM,F.1/8W	1	PAVCCZ
	R16585	D0GB473JA065	M 47KOHM J. 1/10W	1	PAVCCZ
	R16587	D0GB222JA065	M 2.2KOHM,J,1/10W	1	
	R16588	D0GB223JA065	M 22KOHM,J,1/10W	1	PAVCCZ
	R16590	D0GB221JA065	M 220 OHM J 1/10W	1	
	R16591	EXB38V472JV	M 4.7 KOHM 1/16 W	1	
	R16594	D0GB472JA065	M 4.7KOHM, J,1/10W	1	
	R16601	D0GF1R0JA047	M 1 OHM,J,1/3W	1	
	R16604	D0GD331JA052	M 330 OHM,J,1/4W	1	PAVCCZ
	R16605	D0GD220JA059	M 22 OHM,J,1/4W	1	PAVCCZ
	R16606	D0GD223JA052	M 22KOHM,J,1/4W	1	PAVCCZ
	R16607	D1BB5111A055	M5.11KOHM,J.1/10W	1	
	R16608	ERG2FJX153	M 15KOHM, J, 2W	1	PAVCCZ
	R16609	D0GF102JA047	M 1.0 KOHM,J,1/3W	1	
	R16610	D0GB104JA065	M 100KOHM J 1/10W	1	
	R16612	D0GD220JA059	M 22 OHM,J,1/4W	1	PAVCCZ
	R16615	D1BB1871A055	M1.87KOHM, 1/10W	1	PAVCCZ
	R16617	D0GD222JA052	M 2.2KOHM,J,1/8W	1	PAVCCZ
	R16621	D0GD221JA052	M 220 OHM,J 1/4W	1	PAVCCZ
	R16622	D0GD221JA052	M 220 OHM,J 1/4W	1	PAVCCZ
	R16623	D0GD221JA052	M 220 OHM,J 1/4W	1	PAVCCZ
	R16631	D0GB103JA065	M 10K OHM J 1/10W	1	

Model No. : TX-P50GT30E/J Parts List

Safety	Ref. No.	Part No.	Part Name & Description	Q'ty	Remarks
	R16633	D0GD223JA052	M 22KOHM, J, 1/4W	1	PAVCCZ
	R16634	D0GD222JA052	M 2.2KOHM, J, 1/8W	1	PAVCCZ
	R16645	D0GB562JA065	M 5.6KOHM, J, 1/10W	1	PAVCCZ
	R16646	D1BD8660A044	M 866 OHM, F. 1/8W	1	PAVCCZ
	R16648	D0GF202JA047	M 2KOHM, J, 1/3W	1	
	R16649	D0GD330JA059	M 33 OHM, F, 1/4W	1	
	R16650	D0GB104JA065	M 100KOHM J 1/10W	1	
	R16651	D0GF202JA047	M 2KOHM, J, 1/3W	1	
	R16653	D0GD222JA052	M 2.2KOHM, J, 1/8W	1	PAVCCZ
	R16654	D0GD470JA052	M 47 OHM, J, 1/8W	1	PAVCCZ
	R16658	D1BD6491A077	M6.49KOHM, D. 1/10W	1	PAVCCZ
	R16661	D0GD100JA059	M 10 OHM, J, 1/4W	1	
	R16662	D1BB1002A087	M 10KOHM, J, 1/10W	1	
	R16663	D1BD9091A077	M 9.09KOHM, D. 1/10W	1	PAVCCZ
	R16664	D0GF202JA047	M 2KOHM, J, 1/3W	1	
	R16665	D0GD222JA052	M 2.2KOHM, J, 1/8W	1	PAVCCZ
	R16666	D1BB1003A087	M100KOHM, D 1/10W	1	PAVCCZ
	R16667	D0GF202JA047	M 2KOHM, J, 1/3W	1	
	R16668	D0GF202JA047	M 2KOHM, J, 1/3W	1	
	R16674	D0GF202JA047	M 2KOHM, J, 1/3W	1	
	R16675	D0GB103JA065	M 10K OHM J 1/10W	1	
	R16676	D1BD2700A044	M 270 OHM, J, 1/8 W	1	
	R16677	D0GF202JA047	M 2KOHM, J, 1/3W	1	
	R16678	D0GF202JA047	M 2KOHM, J, 1/3W	1	
	R16681	D0GD100JA059	M 10 OHM, J, 1/4W	1	
	R16682	D0GD100JA059	M 10 OHM, J, 1/4W	1	
	R16683	D0GD100JA059	M 10 OHM, J, 1/4W	1	
	R16684	D0GB220JA065	M 22 OHM J 1/10W	1	PAVCCZ
	R16685	D1BD1500A044	M 150 OHM, J, 1/8 W	1	
	R16686	D0GB103JA065	M 10K OHM J 1/10W	1	
	R16696	D0D26R2JA034	M 2.6 OHM, J, 2W	1	
	R16697	D0D26R2JA034	M 2.6 OHM, J, 2W	1	
	R16698	D0D26R2JA034	M 2.6 OHM, J, 2W	1	
	R16699	D0D26R2JA034	M 2.6 OHM, J, 2W	1	
	R16719	D0GB220JA065	M 22 OHM J 1/10W	1	PAVCCZ
	R16721	EXB38V220JV	M 22 OHM 1/16 W	1	
	R16761	D0GD100JA059	M 10 OHM, J, 1/4W	1	
	R16763	D0GB473JA065	M 47KOHM J. 1/10W	1	PAVCCZ
	R16772	D0GB472JA065	M 4.7KOHM, J, 1/10W	1	
	R16773	D0GD102JA052	M 1.0KOHM, J, 1/8W	1	PAVCCZ
	R16776	D0GD470JA052	M 47 OHM, J, 1/8W	1	PAVCCZ
	R16786	D1BD5902A044	M 59KOHM, F. 1/8W	1	PAVCCZ
	R16791	D0GB102JA065	M 1KOHM, J, 1/10W	1	
	R16797	D0GD220JA052	M 22 OHM, J, 1/4W	1	PAVCCZ
	R16798	D0GB222JA065	M 2.2KOHM, J, 1/10W	1	
	R16799	D0GB102JA065	M 1KOHM, J, 1/10W	1	
	R16815	D0GB103JA065	M 10K OHM J 1/10W	1	
	R16818	D1BB3302A055	M 33KOHM, J, 1/10W	1	
	R16819	D1BD1503A044	M 150KOHM. F. 1/8W	1	PAVCCZ
	R16820	D1BD1503A044	M 150KOHM. F. 1/8W	1	PAVCCZ
	R16822	D1BD8202A044	M 82KOHM, J, 1/8 W	1	
	R16823	D1BD6192A044	M61.9KOHM, J. 1/8 W	1	
	R16824	D1BD3742A044	M37.4KOHM, F. 1/8W	1	
	R16825	D0GD154JA059	M 150KOHM, J, 1/4W	1	
	R16826	D0GB103JA065	M 10K OHM J 1/10W	1	
	R16829	D0GB102JA065	M 1KOHM, J, 1/10W	1	
	R16831	D1BD6812A077	M68.1KOHM, D. 1/10W	1	PAVCCZ
	R16832	D1BD7152A077	M71.5K0OHM, D. 1/10W	1	PAVCCZ
	R16833	ERG1FJX683	M 68KOHM, J, 1W	1	PAVCCZ
	R16834	ERG1FJX683	M 68KOHM, J, 1W	1	PAVCCZ
	R16838	ERG2FJX104	M 100KOHM, J, 1W	1	
	R16841	D0GB472JA065	M 4.7KOHM, J, 1/10W	1	

Model No. : TX-P50GT30E/J Parts List

Safety	Ref. No.	Part No.	Part Name & Description	Q'ty	Remarks
	R16842	D0GD102JA052	M 1.0KOHM, J, 1/8W	1	PAVCCZ
	R16844	ERA6YEB242	M 2.4KOHM, B 1/10W	1	
	R16845	D1BD6812A077	M68.1KOHM, D.1/10W	1	PAVCCZ
	R16846	D1BD5762A077	M57.6KOHM, D.1/10W	1	PAVCCZ
	R16847	D1BD6492A077	M64.9KOHM, D.1/10W	1	PAVCCZ
	R16851	D0GB474JA065	M 470KOHM, J, 1/10W	1	
	R16852	D0GB474JA065	M 470KOHM, J, 1/10W	1	
	R16856	D0GB102JA065	M 1KOHM, J, 1/10W	1	
	R16873	ERA6YEB242	M 2.4KOHM, B 1/10W	1	
	R16891	D1BF6982A058	M 69.8KOHM, 1/4W	1	
	R16892	D1BF8252A058	M82.50KOHM, 1/4W	1	
	R16893	D1BF8252A058	M82.50KOHM, 1/4W	1	
	R16894	D1BB3091A087	M3.09KOHM, D 1/16W	1	PAVCCZ
	R16895	D1BB9091A087	M9.09 KOHM, J.1/10W	1	PAVCCZ
	R16897	D1BB2262A055	M22.6KOHM F 1/10W	1	PAVCCZ
	R16898	D1BB1051A055	M1.05KOHM, J.1/10W	1	
	R16899	D1BB1372A055	M13.7KOHM, 1/10W	1	PAVCCZ
	R16900	D1BB3831A055	M3.83KOHM, D 1/16W	1	PAVCCZ
	R16902	D0GB6R2JA065	M 6.2 OHM J 1/10W	1	PAVCCZ
	R16919	D1BB1582A055	M15.8KOHM, 1/10W	1	PAVCCZ
	R16920	D0GB101JA065	M 100 OHM, J, 1/10W	1	
	R16921	D1BB2152A055	M 21.5KOHM, 1/10W	1	PAVCCZ
	R16922	D1BB9531A055	M9.53KOHM, J.1/10W	1	
	R16923	D1BB5111A055	M5.11KOHM, J.1/10W	1	
	R16924	D1BB1152A055	M 11.5KOHM 1/10W	1	PAVCCZ
	R16931	D1BF2R70A021	M 2.7 OHM, 1/4W	1	
	R16932	D0GD223JA052	M 22KOHM, J, 1/4W	1	PAVCCZ
	R16937	D0GB184JA065	M 180KOHM J 1/10W	1	PAVCCZ
	R16939	D0GD102JA052	M 1.0KOHM, J, 1/8W	1	PAVCCZ
	R16940	D0GB473JA065	M 47KOHM J. 1/10W	1	PAVCCZ
	R16941	D0GB472JA065	M 4.7KOHM, J, 1/10W	1	
	R16942	D0GB473JA065	M 47KOHM J. 1/10W	1	PAVCCZ
	R16945	D0GB471JA065	M 470 OHM, J, 1/10W	1	PAVCCZ
	R17101	D0GB101JA065	M 100 OHM, J, 1/10W	1	
	R17102	D0GB101JA065	M 100 OHM, J, 1/10W	1	
	R17103	D0GB101JA065	M 100 OHM, J, 1/10W	1	
	R17104	D1BB49R90002	M 49 OHM, J, 1/10W	1	
	R17105	D1BB49R90002	M 49 OHM, J, 1/10W	1	
	R17106	D1BB49R90002	M 49 OHM, J, 1/10W	1	
	R17107	D0GB101JA065	M 100 OHM, J, 1/10W	1	
	R17108	D1BB49R90002	M 49 OHM, J, 1/10W	1	
	R17110	D0GF223JA047	M 22KOHM, J, 1/3W	1	PAVCCZ
	R17111	D0GB331JA065	M330 OHM J 1/10W	1	PAVCCZ
	R17112	D0GB102JA065	M 1KOHM, J, 1/10W	1	
	R17131	D0GZ1R0JA020	M 1 OHM, J, 1/2W	1	
	R17133	D0GZ1R0JA020	M 1 OHM, J, 1/2W	1	
	R17135	D0GZ1R0JA020	M 1 OHM, J, 1/2W	1	
	R17145	D0GBR00J0004	M 0 OHM J 1/10W	1	
	R17146	D0GBR00J0004	M 0 OHM J 1/10W	1	
	R17161	D0GBR00J0004	M 0 OHM J 1/10W	1	
	R17162	D0GBR00J0004	M 0 OHM J 1/10W	1	
	R17164	D0GB470JA065	M 47 OHM, J, 1/10W	1	
	R17165	D1BB49R90002	M 49 OHM, J, 1/10W	1	
	R17166	D1BB49R90002	M 49 OHM, J, 1/10W	1	
	R17167	D1BB49R90002	M 49 OHM, J, 1/10W	1	
	R17168	D1BB49R90002	M 49 OHM, J, 1/10W	1	
	R17196	D0GB102JA065	M 1KOHM, J, 1/10W	1	
	R17198	D0GD224JA052	M 220KOHM, J, 1/8W	1	PAVCCZ
	R17199	D0GF102JA047	M 1.0 KOHM, J, 1/3W	1	
	R17201	D0GB101JA065	M 100 OHM, J, 1/10W	1	
	R17202	D0GB101JA065	M 100 OHM, J, 1/10W	1	
	R17203	D0GB101JA065	M 100 OHM, J, 1/10W	1	

Model No. : TX-P50GT30E/J Parts List



Safety	Ref. No.	Part No.	Part Name & Description	Q'ty	Remarks
	R17204	D0GB101JA065	M 100 OHM, J, 1/10W	1	
	R17205	D0GB101JA065	M 100 OHM, J, 1/10W	1	
	R17206	D0GB101JA065	M 100 OHM, J, 1/10W	1	
	R17207	D0GB101JA065	M 100 OHM, J, 1/10W	1	
	R17208	D0GB101JA065	M 100 OHM, J, 1/10W	1	
	R17209	D0GB101JA065	M 100 OHM, J, 1/10W	1	
	R17210	D0GB101JA065	M 100 OHM, J, 1/10W	1	
	R17211	D0GB101JA065	M 100 OHM, J, 1/10W	1	
	R17212	D0GB101JA065	M 100 OHM, J, 1/10W	1	
	R17231	DOGZ1R0JA020	M 1 OHM, J, 1/2W	1	
	R17233	DOGZ1R0JA020	M 1 OHM, J, 1/2W	1	
	R17235	DOGZ1R0JA020	M 1 OHM, J, 1/2W	1	
	R17237	DOGZ1R0JA020	M 1 OHM, J, 1/2W	1	
	R17239	DOGZ1R0JA020	M 1 OHM, J, 1/2W	1	
	R17241	DOGZ1R0JA020	M 1 OHM, J, 1/2W	1	
	R17262	D0GB470JA065	M 47 OHM, J, 1/10W	1	
	R17263	D0GB681JA065	M 680 OHM, J, 1/10W	1	PAVCCZ
	R17264	D0GB681JA065	M 680 OHM, J, 1/10W	1	PAVCCZ
	R17268	DOGD224JA052	M 220KOHM, J, 1/8W	1	PAVCCZ
	R17270	EXB38V470J	M 47 OHM 1/16 W	1	
	R17271	EXB38V470J	M 47 OHM 1/16 W	1	
	R17272	EXB38V681J	M 680 OHM 1/16 W	1	
	R17301	D0GB101JA065	M 100 OHM, J, 1/10W	1	
	R17302	D0GB101JA065	M 100 OHM, J, 1/10W	1	
	R17303	D0GB101JA065	M 100 OHM, J, 1/10W	1	
	R17304	D0GB101JA065	M 100 OHM, J, 1/10W	1	
	R17305	D0GB101JA065	M 100 OHM, J, 1/10W	1	
	R17306	D0GB101JA065	M 100 OHM, J, 1/10W	1	
	R17307	D0GB101JA065	M 100 OHM, J, 1/10W	1	
	R17308	D0GB101JA065	M 100 OHM, J, 1/10W	1	
	R17309	D0GB101JA065	M 100 OHM, J, 1/10W	1	
	R17310	D0GB101JA065	M 100 OHM, J, 1/10W	1	
	R17311	D0GB101JA065	M 100 OHM, J, 1/10W	1	
	R17312	D0GB101JA065	M 100 OHM, J, 1/10W	1	
	R17313	D0GB331JA065	M330 OHM J 1/10W	1	PAVCCZ
	R17314	D0GB102JA065	M 1KOHM, J, 1/10W	1	
	R17315	DOGF223JA047	M 22KOHM, J, 1/3W	1	PAVCCZ
	R17331	DOGZ1R0JA020	M 1 OHM, J, 1/2W	1	
	R17333	DOGZ1R0JA020	M 1 OHM, J, 1/2W	1	
	R17335	DOGZ1R0JA020	M 1 OHM, J, 1/2W	1	
	R17337	DOGZ1R0JA020	M 1 OHM, J, 1/2W	1	
	R17339	DOGZ1R0JA020	M 1 OHM, J, 1/2W	1	
	R17341	DOGZ1R0JA020	M 1 OHM, J, 1/2W	1	
	R17361	D0GB681JA065	M 680 OHM, J, 1/10W	1	PAVCCZ
	R17362	D0GB681JA065	M 680 OHM, J, 1/10W	1	PAVCCZ
	R17366	EXB38V470J	M 47 OHM 1/16 W	1	
	R17367	EXB38V470J	M 47 OHM 1/16 W	1	
	R17370	EXB38V681J	M 680 OHM 1/16 W	1	
	R17398	DOGD224JA052	M 220KOHM, J, 1/8W	1	PAVCCZ
	R17399	DOGF102JA047	M 1.0 KOHM, J, 1/3W	1	
	SC2	K1KY02B00012	2P CONNECTOR	1	
	SC20	K1MY35BA0345	35P CONNECTOR	1	
	SC41	K1KA09AA0707	9P CONNECTOR	1	
	SC42	K1KA09AA0707	9P CONNECTOR	1	
	SC46	K1KA09AA0707	9P CONNECTOR	1	
	SC50	K1KA02AA0193	2P CONNECTOR	1	
	SS11	K1KY03B00006	3P CONNECTOR	1	
	SS33	K1MY20BA0345	20P CONNECTOR	1	
	SS53	K1MY13BA0343	13P CONNECTOR	1	
	SS54	K1MY13BA0443	13P CONNECTOR	1	PAVCCZ

Model No. : TX-P50GT30E/J Parts List

Safety	Ref. No.	Part No.	Part Name & Description	Q'ty	Remarks
	SS56	K1MY13BA0443	13P CONNECTOR	1	PAVCCZ
	T16471	G4DYA0000254	SWITCHING TRANS	1	PAVCCZ
	T16472	G4DYA0000255	SWITCHING TRANS	1	PAVCCZ
	ZA16001	K4AZ01D00004	TERMINAL	1	
	ZA16002	K4AZ01D00004	TERMINAL	1	
	ZA16011	K4AZ01D00004	TERMINAL	1	
	ZA16012	K4AZ01D00004	TERMINAL	1	
	ZA16101	K4AD01Z00003	TERMINAL	1	
	ZA16102	K4AD01Z00003	TERMINAL	1	
	ZA16105	K4AD01Z00003	TERMINAL	1	
	ZA16106	K4AD01Z00003	TERMINAL	1	
	ZA16111	K4AA04D00002	TERMINAL	1	PAVCCZ
	ZA16112	K4AA04D00002	TERMINAL	1	PAVCCZ
	ZA16115	K4AA04D00002	TERMINAL	1	PAVCCZ
	ZA16116	K4AA04D00002	TERMINAL	1	PAVCCZ
	ZA16402	K4AZ01D00004	TERMINAL	1	
	ZA16403	K4AZ01D00004	TERMINAL	1	
	ZA16411	K4AA04D00002	TERMINAL	1	PAVCCZ
	ZA16412	K4AA04D00002	TERMINAL	1	PAVCCZ
	ZA16421	K4AA04D00002	TERMINAL	1	PAVCCZ
	ZA16422	K4AA04D00002	TERMINAL	1	PAVCCZ
	ZA17101	K4CD01000013	AV TERMINAL	1	
	ZA17102	K4CD01000013	AV TERMINAL	1	
	ZA17103	K4CD01000013	AV TERMINAL	1	
	ZA17201	K4CD01000013	AV TERMINAL	1	
	ZA17202	K4CD01000013	AV TERMINAL	1	
	ZA17203	K4CD01000013	AV TERMINAL	1	
	ZA17204	K4CD01000013	AV TERMINAL	1	
	ZA17301	K4CD01000013	AV TERMINAL	1	
	ZA17302	K4CD01000013	AV TERMINAL	1	
	ZA17303	K4CD01000013	AV TERMINAL	1	
	ZA17304	K4CD01000013	AV TERMINAL	1	

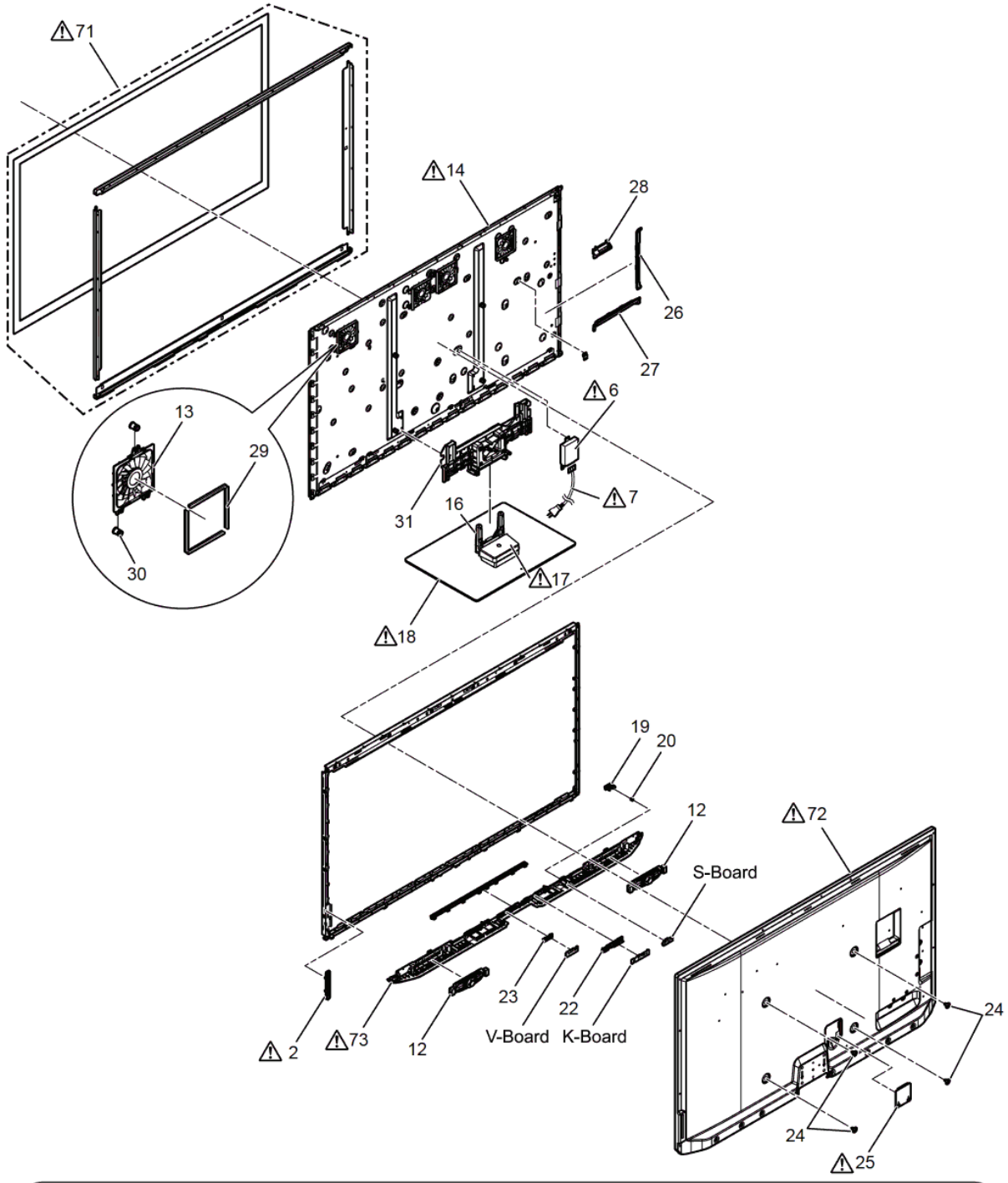
Model No. : TX-P50GT30E/J Exploded View 1

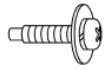
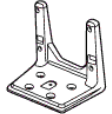
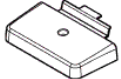
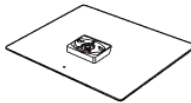

<p>Assembly screws</p> <p>82  M5 × 20 (silver) (4)</p> <p>81  M4 × 8 (black) (4)</p>	<p>21  M5 × 25 (black) (4)</p>	<p>16 Stand pole (1) </p>	<p>▲17 Pole cover (1) </p>	<p>▲18 Base (1) </p>
---	---	--	--	---

Model No. : TX-P50GT30E/J Exploded View 2

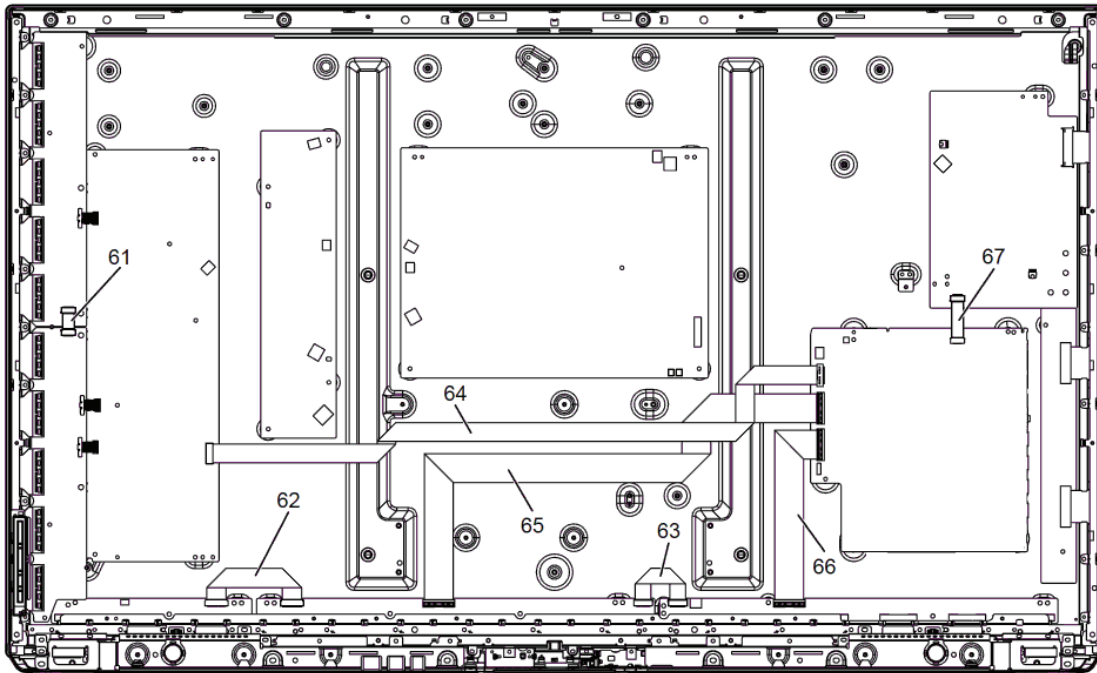

Model No. : TX-P50GT30E/J Packing 1

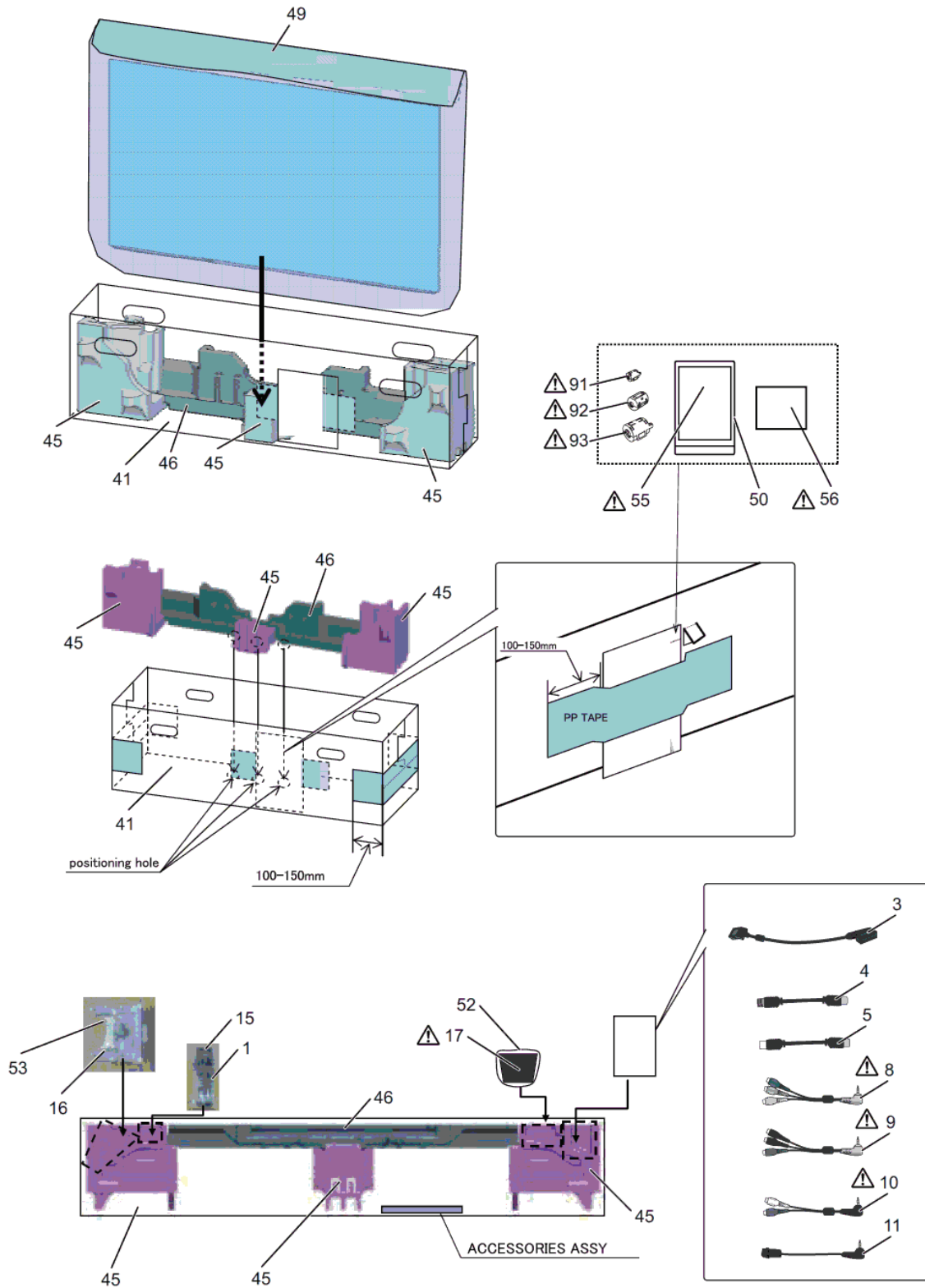

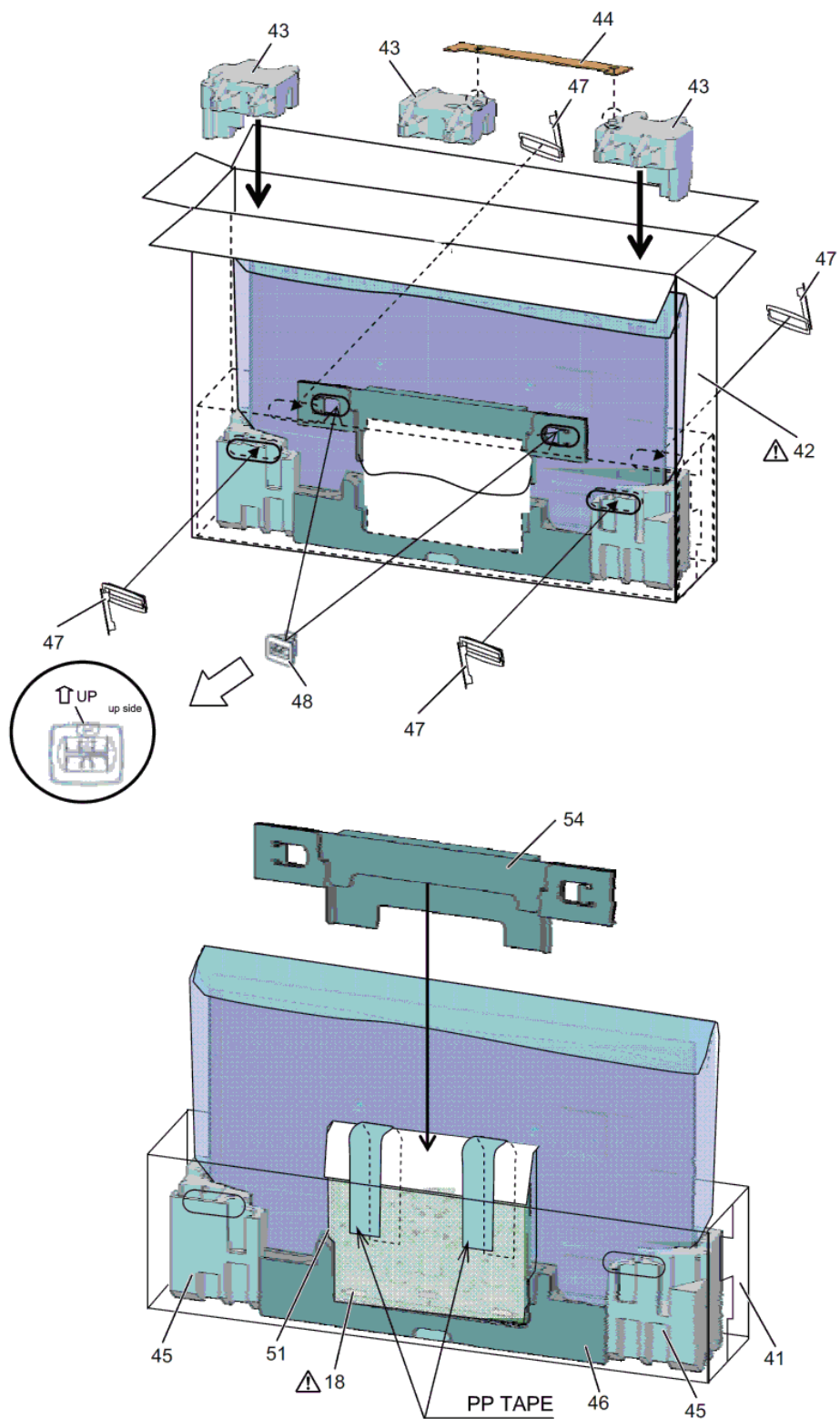































Model No. : TX-P50GT30E/J Parts List

Safety	Ref. No.	Part No.	Part Name & Description	Q'ty	Remarks
	1	BAT-C-0572	Battery Cover of RC	1	PAVCCZ
⚠	91	J0KG0000011	FERRITE CORE	1	
⚠	92	J0KG00000100	FERRITE CORE	1	
⚠	93	J0KG00000146	FERRITE CORE PACK	1	
⚠	2	K0RB00500039	SIDE UNIT ASSY	1	PAVCCZ
	3	K1HY20YY0008	CABLE (SCART)	1	PAVCCZ
	4	K1TYYYY00158	CABLE (TUNER_F)	1	PAVCCZ
	5	K1TYYYY00159	CABLE (TUNER_PAL)	1	PAVCCZ
⚠	6	K2AZYH000024	AC-INLET WITH CABLE	1	PAVCCZ
⚠	7	K2CN3YY00011	AC CORD	1	PAVCCZ P50GT30E
⚠	7	K2CS3YY00015	AC CORD	1	PAVCCZ P50GT30J
⚠	8	K2KYYYY00136	CABLE (AV)	1	PAVCCZ
⚠	9	K2KYYYY00137	CABLE (COMPONENT)	1	PAVCCZ
⚠	10	K2KYYYY00138	CABLE (AUDIO)	1	PAVCCZ
	11	K7CXGYC00001	CABLE (OPTICAL_L)	1	PAVCCZ
	12	L0AA12C00011	SPEAKER	2	PAVCCZ
	13	L6FAYYYH0111	FAN	4	
⚠	14	MD50F14C9Z	PLASMA DISPLAY PANEL	1	PAVCCZ
	15	N2QAYB000572	REMOTE CONTROL	1	PAVCCZ
	16	TBL5ZA3065	STAND POLE	1	
⚠	17	TBL5ZB3054-1	POLE COVER	1	PAVCCZ
⚠	18	TBL5ZX0067	PEDESTAL STAND	1	PAVCCZ
	19	TBX5ZA00101A	POWER BUTTON	1	
	20	TESD114	POWER BUTTON SPRING	1	
		THEC141J	SCREW (CONTACT_METAL-AL_CABINET:14)	14	
		THEJ036J	SCREW (CONT_MET-AL_CAB:6 SIDE UNIT MET:1)	7	
		THEJ036J	SCREW (CONTACT_METAL:12 INLET_METAL:2 P:9)	23	
		THEJ036J	SCREW (SS:6 SC:7 SUS:3 PSM:1)	17	
		THEJ036J	SCREW (C:11)	11	
		THEJ039J	SCREW	8	
		THEJ0409	SCREW	31	chap.3.1. (1)
		THEL0239	SCREW (SP_SHI:14 STA_BR:4 K:1 V:1)	20	
		THEL0239	SCREW (A:5)	5	
		THEL0239	SCREW (DD:15)	15	
		THEL052Z	SCREW	9	
	21	THEL088N	SCREW M5x25	4	
	22	TKKC5410-1	LED PANEL	1	PAVCCZ
	23	TKKC5411	EMITTER PANEL	1	
	24	TKKL5493	M8 CAP	4	chap.3.1. (2)
⚠	25	TKP0E48801	INLET COVER	1	PAVCCZ
	26	TKP0E48901	SIDE TERMINAL COVER	1	PAVCCZ
	27	TKP0E49001	BOTTOM TERMINAL COVER	1	PAVCCZ
	28	TKP0E49201	USB TERMINAL COVER	1	PAVCCZ
	29	TMKH292	FAN SPONGE	8	
		TMME289	CLAMPER	1	
		TMME292	CLAMPER	7	
		TMME332	CLAMPER	1	
		TMME332	CLAMPER (STD_BRKT:9 SP_S:6 AC_INLET:1 INLET_MET:1)	17	
		TMME351	CLAMPER	5	
		TMME380	CLAMPER (CONTACT METAL BOT:2)	2	
		TMME397	SPACER	4	PAVCCZ
		TMME409	SPACER	4	PAVCCZ
	30	TMMJ117	RUBBER CUSHION	8	
	31	TMZ2AX5012	STAND BRACKET	1	PAVCCZ
	41	TPC0EA04801	CARTON BOX BOTTOM	1	PAVCCZ
⚠	42	TPC0EA05201	CARTON BOX TOP	1	PAVCCZ
	43	TPD0E1156	TOP CUSHION	1	PAVCCZ
	44	TPD0E1170	TOP PAD	1	PAVCCZ
	45	TPD0E2162	BOTTOM CUSHION	1	PAVCCZ
	46	TPD0E9183	PEDESTAL CUSHION	1	PAVCCZ
	47	TPD169487	JOINT	4	

Model No. : TX-P50GT30E/J Parts List

Safety	Ref. No.	Part No.	Part Name & Description	Q'ty	Remarks
	48	TPDX0016-1	JOINT FOR PEDESTAL	2	
	49	TPE0E4010	PROTECT COVER	1	PAVCCZ
	50	TPE0E9008	BAG (INSTRUCTION BOOK)	1	PAVCCZ
	51	TPEB494	BAG (PEDESTAL STAND)	1	
	52	TPEB497	BAG (POLE COVER)	1	
	53	TPEB515	BAG (STAND POLE)	1	PAVCCZ
	54	TPG0E9710	PEDESTAL PAD	1	PAVCCZ
		TPG0E9720	PAPER CAP	0.25	PAVCCZ
	55	TQB0E2070A	INSTRUCTION BOOK (GERMAN)	1	PAVCCZ P50GT30E
	55	TQB0E2070B	INSTRUCTION BOOK (DUTCH)	1	PAVCCZ P50GT30E
	55	TQB0E2070C	INSTRUCTION BOOK (ITALIAN)	1	PAVCCZ P50GT30E
	55	TQB0E2070D	INSTRUCTION BOOK (FRENCH)	1	PAVCCZ P50GT30E
	55	TQB0E2070E	INSTRUCTION BOOK (SPANISH)	1	PAVCCZ P50GT30E
	55	TQB0E2070F	INSTRUCTION BOOK (SWEDISH)	1	PAVCCZ P50GT30E
	55	TQB0E2070G	INSTRUCTION BOOK (NORWEGIAN)	1	PAVCCZ P50GT30E
	55	TQB0E2070H	INSTRUCTION BOOK (FINNISH)	1	PAVCCZ P50GT30E
	55	TQB0E2070I	INSTRUCTION BOOK (LITHUANIAN)	1	PAVCCZ P50GT30E
	55	TQB0E2070J	INSTRUCTION BOOK (PORTUGUESE)	1	PAVCCZ P50GT30E
	55	TQB0E2070K	INSTRUCTION BOOK (DANISH)	1	PAVCCZ P50GT30E
	55	TQB0E2070M	INSTRUCTION BOOK (BULGARIAN)	1	PAVCCZ P50GT30E
	55	TQB0E2070N	INSTRUCTION BOOK (ROMANIAN)	1	PAVCCZ P50GT30E
	55	TQB0E2070O	INSTRUCTION BOOK (LATVIAN)	1	PAVCCZ P50GT30E
	55	TQB0E2070P	INSTRUCTION BOOK (POLISH)	1	PAVCCZ P50GT30E
	55	TQB0E2070Q	INSTRUCTION BOOK (HUNGARIAN)	1	PAVCCZ P50GT30E
	55	TQB0E2070R	INSTRUCTION BOOK (CZECH)	1	PAVCCZ P50GT30E
	55	TQB0E2070S	INSTRUCTION BOOK (GREEK)	1	PAVCCZ P50GT30E
	55	TQB0E2070T	INSTRUCTION BOOK (TURKISH)	1	PAVCCZ P50GT30E
	55	TQB0E2070U	INSTRUCTION BOOK (ENGLISH)	1	PAVCCZ P50GT30E
	55	TQB0E2070V	INSTRUCTION BOOK (CROATIAN)	1	PAVCCZ P50GT30E
	55	TQB0E2070W	INSTRUCTION BOOK (SLOVAKIAN)	1	PAVCCZ P50GT30E
	55	TQB0E2070Z	INSTRUCTION BOOK (ESTONIAN)	1	PAVCCZ P50GT30E
	55	TQB0E2072A	INSTRUCTION BOOK (GERMAN)	1	PAVCCZ P50GT30J
	55	TQB0E2072C	INSTRUCTION BOOK (ITALIAN)	1	PAVCCZ P50GT30J
	55	TQB0E2072D	INSTRUCTION BOOK (FRENCH)	1	PAVCCZ P50GT30J
	56	TQB0E2070X	INSTRUCTION BOOK (CD-ROM)	1	PAVCCZ P50GT30E
		TQZJ350	SCREW USE HANDBILE	1	
	61	TSXM217	CABLE (SU11-SD11)	1	
	62	TSXM238-1	CABLE (C10-C20)	1	
	63	TSXM240-1	CABLE (C26-C36)	1	
	64	TSXM296	CABLE (A20-SC20)	1	PAVCCZ
	65	TSXM297	CABLE (C21-A31)	1	PAVCCZ
	66	TSXM298	CABLE (C31-A32)	1	PAVCCZ
	67	TSXM302	CABLE (A40-SS33)	1	PAVCCZ
	71	TTROE0002	CABINET COMPLETE	1	PAVCCZ
	72	TTU0E0912	REAR COVER	1	PAVCCZ P50GT30E
	72	TTU0E0922	REAR COVER	1	PAVCCZ P50GT30J
	73	TXFKY5Z0032	BOTTOM CABINET ASSY	1	PAVCCZ
		TXJA11QLUE	SPEAKER LEAD (A11-SPR/SPL)	1	PAVCCZ
	81	XSB4+8FNK	SCREW M4x8	1	
		XTB4+8GFJ	SCREW (S:2 SP:4)	6	
		XTB4+8GFJ	SCREW (SP_SHIELD:6)	6	
		XYN3+J10FJK	SCREW	15	
		XYN4+E6FJ	SCREW (INLET:1)	1	
		XYN4+F8FJ	SCREW (SC-SUSD:4 SS-SS2:4)	8	
	82	XYN5+F20FN	SCREW M5x20 SILVER	4	
		XZB6X12B03	POLY BAG (SCREW)	1	