

14 Exploded View and Replacement Parts List

14.1. Exploded View and Mechanical Replacement Parts List

14.1.1. Exploded View 1

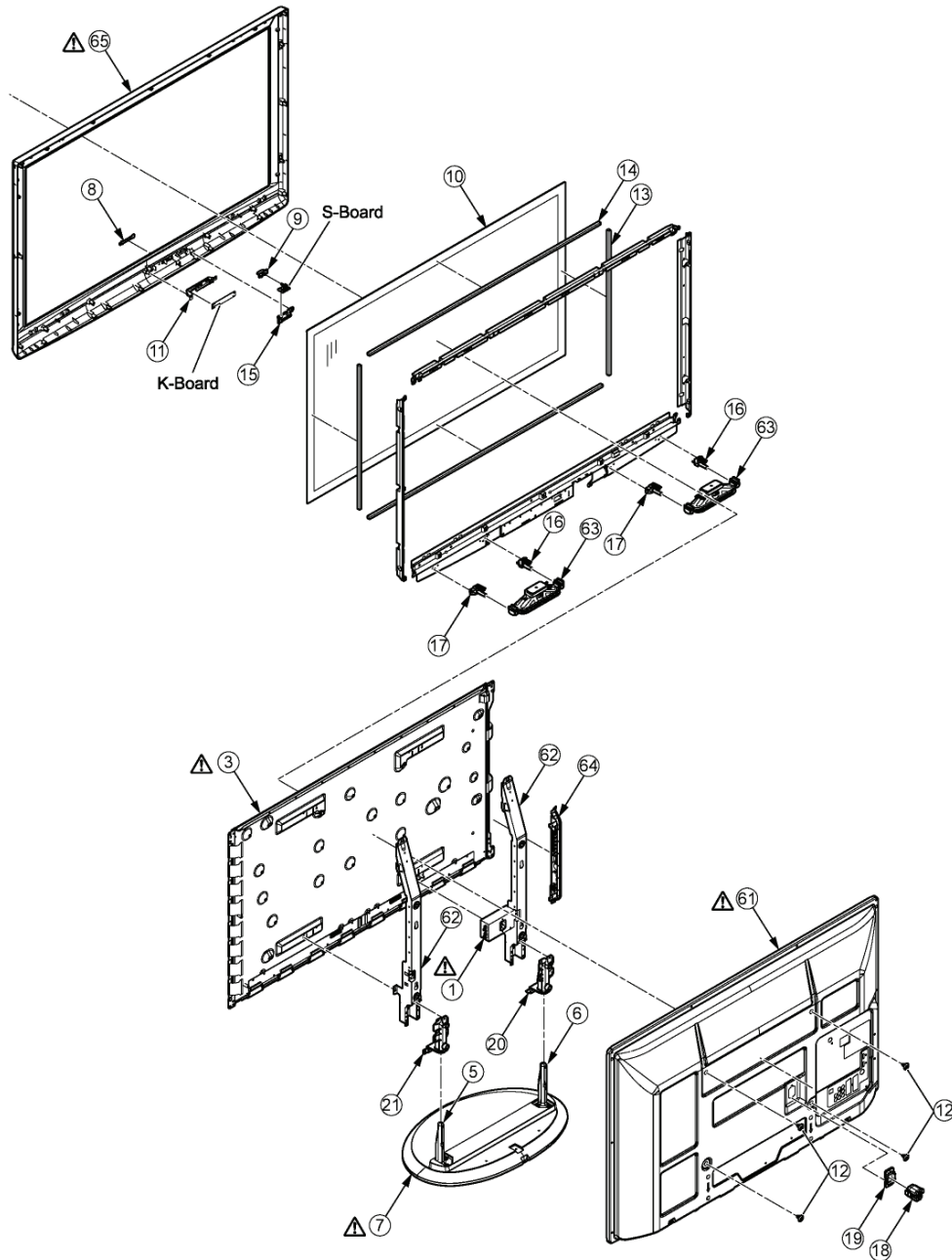

14.1.2. Exploded View 2

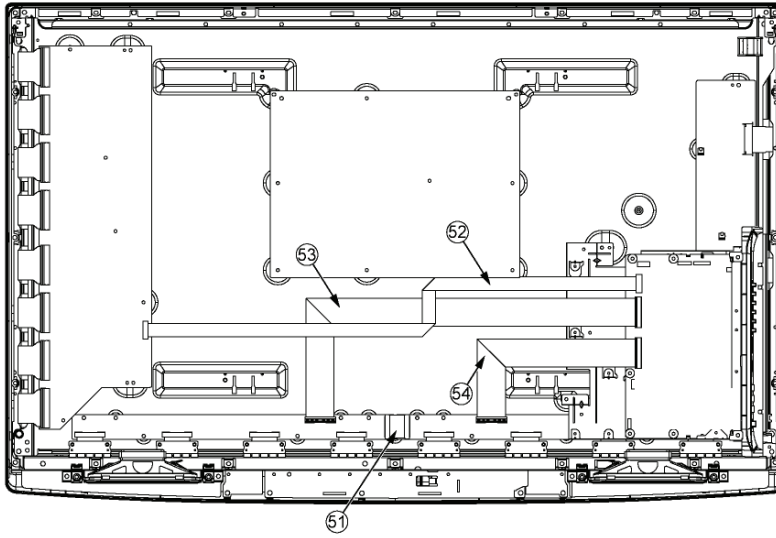

14.1.3. Packing 1

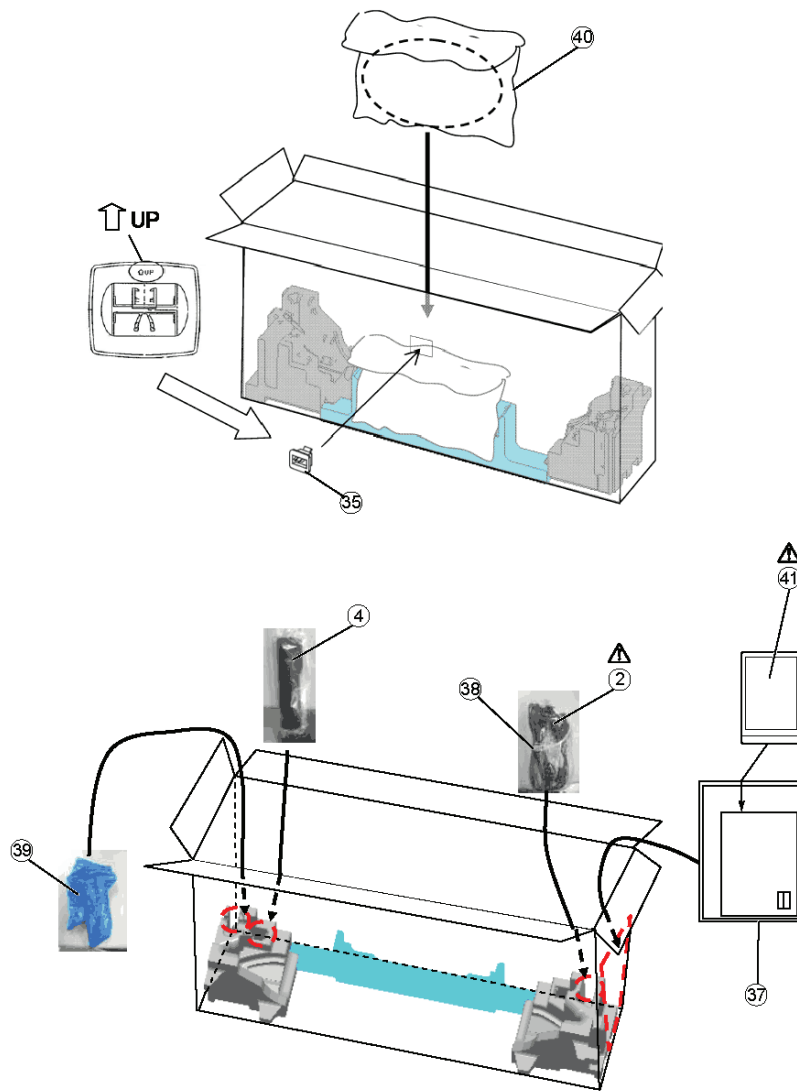



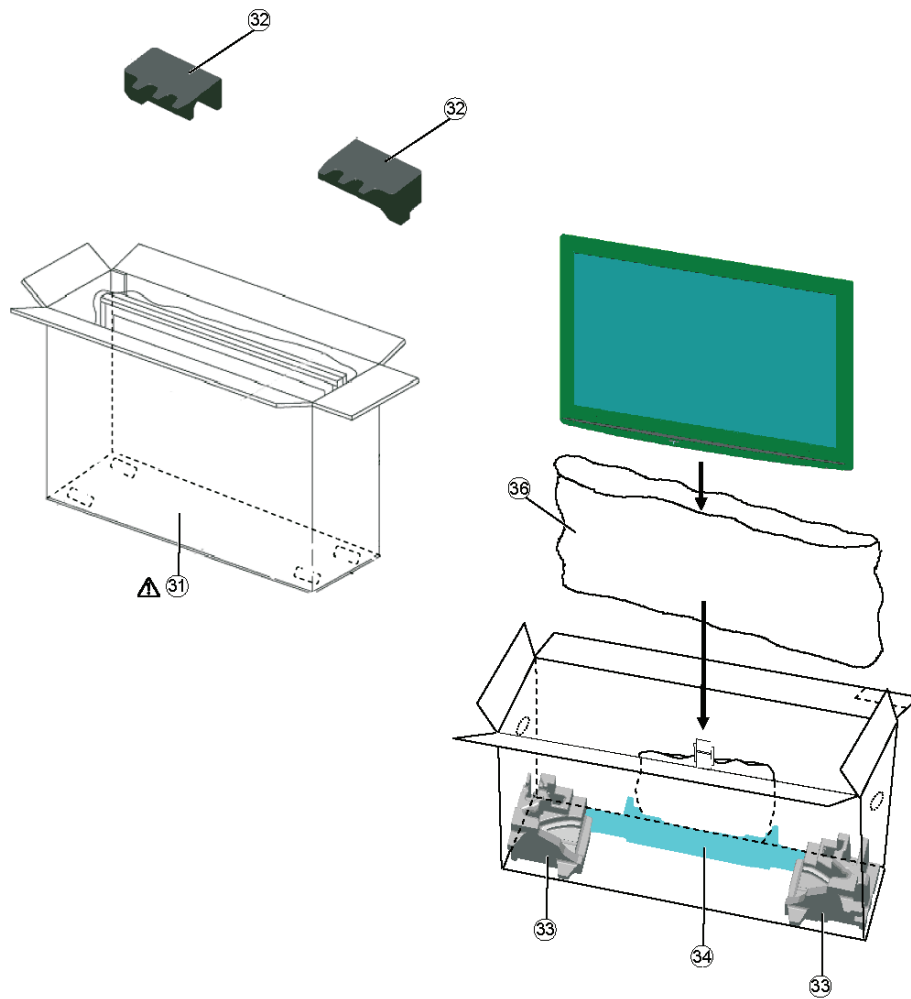



































14.1.4. Packing 2





14.1.5. Mechanical Replacement Parts List

Note: All parts except parts mentioned [PAVCCZ] in the Remarks column are supplied by AVC-CSPC.
Parts mentioned [PAVCCZ] are supplied by PAVCCZ.

Safety	Ref. No.	Part No.	Part Name & Description	Q'ty	Remarks
	1	K2AHYH000033	AC INLET WITH CABLE	1	PAVCCZ
	2	K2CN3YY00006	AC CORD	1	PAVCCZ E/R
	2	K2CT3YY00021	AC CORD	1	PAVCCZ B/L
	3	MD42H13C2Z	PLASMA DISPLAY PANEL	1	PAVCCZ
	4	N2QAYB000487	REMOTE CONTROL	1	PAVCCZ
	5	TBLA3689	STAND POLE R	1	
	6	TBLA3690	STAND POLE L	1	
	7	TBLX0136	PEDESTAL STAND(SQUARE GB)	1	PAVCCZ
	8	TBM3EA002	PANASONIC SHEET BADGE	1	PAVCCZ
	9	TBX3EA00201	POWER BUTTON	1	PAVCCZ
		THEJ0339	SCREW(BC-TUNER:1 SIDE_COVER:2)	3	
		THEL0429	SCREW	2	
		THEL052Z	SCREW (BC TOP:4)	2	
		THEL079N	PF SCREW (5x30)	4	
		THTD020J	SCREW(A-PRINT:4)	4	
		THTF011N	SCREW	11	
		THTF011N	SCREW(SN:8 SS:4 K-P:2 K-D:2)	16	
		THTF011N	SCREW(DD:16 C:6)	22	
	10	TKGA5594	FRONT GLASS	1	PAVCCZ
	11	TKK3EC5002	LED PANEL	1	PAVCCZ
	12	TKKL5493	M8 CAP	4	
	13	TMK0EG010	SPONGE (FRONT GLASS/LEFT/RIGHT)	2	PAVCCZ
	14	TMK0EG011	SPONGE (FRONT GLASS/UPPER/BOTTOM)	2	PAVCCZ
		TMM23417	CLAMPER	2	
		TMME292	CLAMPER	1	
		TMME331	CLAMPER (P:1)	1	
		TMME332	CLAMPER (HANGER:4)	4	
		TMME332	CLAMPER(SS:1)	1	
		TMME332	CLAMPER	1	
		TMME332	CLAMPER(GLASS HOLDER BOTTOM)	1	
		TMME379	CLAMPER	3	
	15	TMW3EC002	POWER BUTTON BRACKET	1	PAVCCZ
	16	TMW3EX002	SP BRACKET L	2	
	17	TMW3EX003	SP BRACKET R	2	
	18	TMXX064	AC CORD CLAMPER A	1	
	19	TMXX065	AC CORD CLAMPER B	1	
	20	TMZX5174	STAND BRACKET-L	1	
	21	TMZX5175	STAND BRACKET-R	1	
	31	TPC0E65402	CARTON BOX	1	PAVCCZ B/E/L
	31	TPC0EA01201	CARTON BOX	1	PAVCCZ R
	32	TPD0E1129	TOP CUSHION	1	PAVCCZ
	33	TPD0E2131	BOTTOM CUSHION	1	PAVCCZ
	34	TPD0E2132	PEDESTAL CUSHION	1	PAVCCZ

Safety	Ref. No.	Part No.	Part Name & Description	Q'ty	Remarks
	35	TPDX0016-1	JOINT FOR PEDESTAL	1	
	36	TPE0E4047	SET BAG	1	PAVCCZ
	37	TPE0E9002	ACCESSORIES BAG	1	PAVCCZ
	38	TPE0E9003	BAG FOR AC CORD	1	PAVCCZ
	39	TPEB341	STAND ACCESSORY BAG	1	
	40	TPEB423	BAG (PEDESTAL STAND)	1	
		TPG0E9530	PAPER CAP	0.25	PAVCCZ
		TQA0E1273	SCHEMATIC DIAGRAM	1	PAVCCZ
	41	TQB0E0908	INSTRUCTION BOOK (ENGLISH)	1	PAVCCZ B
	41	TQB0E0909A	INSTRUCTION BOOK (GERMAN)	1	PAVCCZ E
	41	TQB0E0909B	INSTRUCTION BOOK (DUTCH)	1	PAVCCZ E
	41	TQB0E0909C	INSTRUCTION BOOK (ITALIAN)	1	PAVCCZ E
	41	TQB0E0909D	INSTRUCTION BOOK (FRENCH)	1	PAVCCZ E
	41	TQB0E0909E	INSTRUCTION BOOK (SPANISH)	1	PAVCCZ E
	41	TQB0E0909F	INSTRUCTION BOOK (SWEDISH)	1	PAVCCZ E
	41	TQB0E0909G	INSTRUCTION BOOK (NORWEGIAN)	1	PAVCCZ E
	41	TQB0E0909H	INSTRUCTION BOOK (FINNISH)	1	PAVCCZ E
	41	TQB0E0909I	INSTRUCTION BOOK (LITHUANIAN)	1	PAVCCZ E
	41	TQB0E0909J	INSTRUCTION BOOK (PORTUGUESE)	1	PAVCCZ E
	41	TQB0E0909K	INSTRUCTION BOOK (DANISH)	1	PAVCCZ E
	41	TQB0E0909M	INSTRUCTION BOOK (BULGARIAN)	1	PAVCCZ E
	41	TQB0E0909N	INSTRUCTION BOOK (ROMANIAN)	1	PAVCCZ E
	41	TQB0E0909O	INSTRUCTION BOOK (LATVIAN)	1	PAVCCZ E
	41	TQB0E0909P	INSTRUCTION BOOK (POLISH)	1	PAVCCZ E
	41	TQB0E0909Q	INSTRUCTION BOOK (HUNGARIAN)	1	PAVCCZ E
	41	TQB0E0909R	INSTRUCTION BOOK (CZECH)	1	PAVCCZ E
	41	TQB0E0909S	INSTRUCTION BOOK (GREEK)	1	PAVCCZ E
	41	TQB0E0909T	INSTRUCTION BOOK (TURKISH)	1	PAVCCZ E
	41	TQB0E0909U	INSTRUCTION BOOK (ENGLISH)	1	PAVCCZ E
	41	TQB0E0909W	INSTRUCTION BOOK (SLOVAKIAN)	1	PAVCCZ E
	41	TQB0E0909X	INSTRUCTION BOOK (CD-ROM)	1	PAVCCZ E
	41	TQB0E0909Z	INSTRUCTION BOOK (ESTONIAN)	1	PAVCCZ E
	41	TQB0E09119	INSTRUCTION BOOK (KAZAKHATAN)	1	PAVCCZ R
	41	TQB0E0911L	INSTRUCTION BOOK (RUSSIAN)	1	PAVCCZ R
	41	TQB0E0911Y	INSTRUCTION BOOK (UKRAINAN)	1	PAVCCZ R
	41	TQB0E0966	INSTRUCTION BOOK (ENGLISH)	1	PAVCCZ L
		TQZJ202	SCREW USE HANDBILL	1	
	51	TSXL519	CABLE (C10-C20)	1	
	52	TSXM037	CABLE (A20-SN20)	1	PAVCCZ
	53	TSXM038	CABLE (A31-C11)	1	PAVCCZ
	54	TSXM039	CABLE (A32-C21)	1	PAVCCZ
	61	TTU0E0708	REAR COVER	1	PAVCCZ E
	61	TTU0E0717	REAR COVER	1	PAVCCZ R

Safety	Ref. No.	Part No.	Part Name & Description	Q'ty	Remarks
	61	TTU0E0720	REAR COVER	1	PAVCCZ B
	61	TTU0E0757	REAR COVER	1	PAVCCZ L
	62	TUX0E152	42HANGER METAL	2	PAVCCZ
	63	TXFEA01LWUE	SPEAKER ASSY	2	PAVCCZ
	64	TXFKP01LGUE	SIDE TERMINAL COVER ASSY	1	PAVCCZ
	65	TXFKY01LGUE	CABINET ASSY	1	PAVCCZ
		TXJA11LWUE	SPEAKER LEAD(A11-SPL/SPR)	1	PAVCCZ
		XSB3+6FJ	SCREW (HDMI:3)	2	
		XTB4+12GFJ	SCREW (GH:20 PW:2 LED:1)	17	
		XTB4+12GFJK	SCREW (BC:11)	11	
		XTB4+12GFN	SCREW (4*12)	6	
		XTV3+10JFJK	SCREW (REAR AV:2)	2	
		XTW3+10TFJ	SCREW	1	
		XYN3+F10FJK	SCREW (BC-AC_INLET:2)	2	
		XYN3+J10FJ	SCREW	15	
		XYN4+E6FJ	SCREW (INLET:1)	1	
		XYN4+F10FJ	SCREW (AL-GHT:4)	4	
		XYN4+F10FJ	SCREW (AL-GHT:4)	14	
		XYN4+F10FJ	SCREW (KARI-HANGER METAL:4)	4	
		XYN5+F18FN	SCREW (STAND POLE)	4	
		XZB17X19C03	POLY BAG (STAND POLE)	1	
		XZBT6506	POLY BAG (INSTRUCTION BOOK)	1	

14.2.2. Electrical Replacement Parts List

Note: All parts except parts mentioned [PAVCCZ] in the Remarks column are supplied by AVC-CSPC.
Parts mentioned [PAVCCZ] are supplied by PAVCCZ.

Safety	Ref. No.	Part No.	Part Name & Description	Pcs	Remarks
△	PCB	LSEP1287LEHB	CIRCUIT BOARD P	1	(RTL) PA VCCZ
△	PCB	A-P42C2B	CIRCUIT BOARD A	1	(RTL) PA VCCZ P42C2B
△	PCB	A-P42C2E	CIRCUIT BOARD A	1	(RTL) PA VCCZ P42C2E
△	PCB	A-P42C2L	CIRCUIT BOARD A	1	(RTL) PA VCCZ P42C2L
△	PCB	A-PR42C2	CIRCUIT BOARD A	1	(RTL) PA VCCZ PR42C2
△	PCB	TNPA4858AB	CIRCUIT BOARD S	1	(RTL)
△	PCB	TXN/K1LGUE	CIRCUIT BOARD K	1	(RTL) PA VCCZ
△	PCB	TXNC111BEK	CIRCUIT BOARD C1	1	(RTL) PA VCCZ
△	PCB	TXNC211BEK	CIRCUIT BOARD C2	1	(RTL) PA VCCZ
△	PCB	TXNSN11BEK	CIRCUIT BOARD SN	1	(RTL) PA VCCZ
△	PCB	TXNSS11BEK	CIRCUIT BOARD SS	1	(RTL) PA VCCZ
	A1	K1KY08AA0719	8P CONNECTOR	1	
	A6	K1KY11AA0719	11P CONNECTOR	1	
	A7	K1KY14AA0719	14P CONNECTOR	1	PAVCCZ
	A11	K1KA04AA0728	4P CONNECTOR	1	
	A20	K1MY30BA0345	30P CONNECTOR	1	PAVCCZ
	A31	K1MY40BA0345	40P CONNECTOR	1	PAVCCZ
	A32	K1MY55BA0345	55P CONNECTOR	1	
	C0900	FIG1C104A116	C 0.10UF, K, 16V	1	
	C1100	FIG1E103A123	C 0.010UF, K, 25V	1	
	C1101	FIG1E103A123	C 0.010UF, K, 25V	1	
	C1102	FIG1C104A116	C 0.10UF, K, 16V	1	
	C2055	FIJ1A106A087	C 0.010UF, K, 10V	1	
	C2057	FIJ1A106A087	C 0.010UF, K, 10V	1	
	C2071	EEHBOJ101UR	C 100PF, J, 6.3V	1	
	C2072	EEHBOJ101UR	C 100PF, J, 6.3V	1	
	C2073	FIG1E333A091	C 0.033UF, K, 25V	1	
	C2074	FIG1E333A091	C 0.033UF, K, 25V	1	
	C2104	FIG1H100A731	C 10PF, K, 50V	1	
	C2107	FIG1A105A047	C 1UF, K, 10V	1	
	C2108	FIG1A105A047	C 1UF, K, 10V	1	
	C2110	FIG1C104A116	C 0.10UF, K, 16V	1	
	C2301	FIG1C104A116	C 0.10UF, K, 16V	1	
	C2302	FIG1C104A116	C 0.10UF, K, 16V	1	
	C2304	FIJ1E105A231	C 1 UF 25V	1	
	C2309	FK1E106A136	C 10UF, Z, 25V	1	
	C2312	FK1E106A136	C 10UF, Z, 25V	1	
	C2313	FIG1H102A730	C 1000UF, 50V	1	
	C2314	FIJ1E105A231	C 1 UF 25V	1	
	C2316	FIH1H104A970	C 0.1UF, K, 50V	1	
	C2317	FIJ1E105A231	C 1 UF 25V	1	
	C2318	FIH1H104A970	C 0.1UF, K, 50V	1	
	C2320	FIJ1E105A231	C 1 UF 25V	1	
	C2321	FIH1H104A970	C 0.1UF, K, 50V	1	
	C2323	FIH1H104A970	C 0.1UF, K, 50V	1	
	C2324	FIJ1E105A231	C 1 UF 25V	1	
	C2325	FIG1H102A730	C 1000UF, 50V	1	
	C2334	FIJ1H474A757	C 0.47UF, 50V	1	
	C2335	FIH1E104A129	C 0.1UF, 25V	1	
	C2336	FIH1E104A129	C 0.1UF, 25V	1	
	C2337	FIJ1H474A757	C 0.47UF, 50V	1	
	C2338	FIH1E104A129	C 0.1UF, 25V	1	
	C2339	FIH1E104A129	C 0.1UF, 25V	1	
	C2340	FIH1H223A970	C 0.22UF, K, 50V	1	
	C2341	FIH1H223A970	C 0.22UF, K, 50V	1	
	C2342	FIH1H223A970	C 0.22UF, K, 50V	1	
	C2343	FIH1H223A970	C 0.22UF, K, 50V	1	
	C2344	FIH1H223A970	C 0.22UF, K, 50V	1	
	C2345	FIH1H223A970	C 0.22UF, K, 50V	1	
	C2346	FIH1H223A970	C 0.22UF, K, 50V	1	
	C2347	FIH1H223A970	C 0.22UF, K, 50V	1	
	C2349	FIG1H102A730	C 1000UF, 50V	1	
	C2351	FIG1H102A730	C 1000UF, 50V	1	
	C2353	FIG1H102A730	C 1000UF, 50V	1	
	C2355	FIG1H102A730	C 1000UF, 50V	1	
	C2356	FK1E106A136	C 10UF, Z, 25V	1	
	C2357	FK1E106A136	C 10UF, Z, 25V	1	
	C2510	FIH1H103A970	C 0.001UF, K, 50V	1	
	C2511	FIJ1A106A087	C 0.010UF, K, 10V	1	
	C2515	FIH1H103A970	C 0.001UF, K, 50V	1	
	C2751	FIJ1E105A231	C 1 UF 25V	1	
	C2824	FIJ1A106A087	C 0.010UF, K, 10V	1	
	C2871	FK1E106A136	C 10UF, Z, 25V	1	
	C2872	FIG1E103A123	C 0.010UF, K, 25V	1	
	C2873	FIJ1A106A087	C 0.010UF, K, 10V	1	
	C2874	FIJ1A106A087	C 0.010UF, K, 10V	1	
	C2877	FIH1H223A970	C 0.22UF, K, 50V	1	
	C2878	FIH1H472A970	C 4700PF, K, 50V	1	
	C2883	F2H1E470A007	E 47UF, 25V	1	
	C2884	FIJ1E105A231	C 1 UF 25V	1	
	C2885	FK1E106A136	C 10UF, Z, 25V	1	
	C2886	FK1E106A136	C 10UF, Z, 25V	1	
	C2905	EEHBC101P	C 100PF, J, 16V	1	
	C2907	FIG1C104A116	C 0.10UF, K, 16V	1	
	C2908	FIG1C104A116	C 0.10UF, K, 16V	1	
	C2910	FIG1C104A116	C 0.10UF, K, 16V	1	
	C2911	FIG1C104A116	C 0.10UF, K, 16V	1	
	C2917	FIG1H222A730	C 2200UF, 50V	1	
	C2950	ECJ2YB0J475K	C 3.3UF, Z, 4.7V	1	
	C2951	ECJ2YB0J475K	C 3.3UF, Z, 4.7V	1	
	C2959	FIG1C104A116	C 0.10UF, K, 16V	1	
	C2961	ECJ1VB1A105K	C 0.01UF, Z, 10V	1	
	C2965	ECJ1VB1A105K	C 0.01UF, Z, 10V	1	
	C2966	FIH1A225A051	C 22UF, 50V	1	
	C3003	FIG1C104A116	C 0.10UF, K, 16V	1	
	C3004	FIG1C104A116	C 0.10UF, K, 16V	1	
	C3011	FIJ1A106A087	C 0.010UF, K, 10V	1	
	C3015	FIJ1A106A087	C 0.010UF, K, 10V	1	
	C3016	FIG1C104A116	C 0.10UF, K, 16V	1	
	C3018	FIG1C104A116	C 0.10UF, K, 16V	1	
	C3019	FIG1C104A116	C 0.10UF, K, 16V	1	

Safety	Ref. No.	Part No.	Part Name & Description	Pcs	Remarks
	C3020	ECJ1VB1A105K	C 0.01UF, Z, 10V	1	
	C3021	ECJ1VB1A105K	C 0.01UF, Z, 10V	1	
	C3022	ECJ1VB1A105K	C 0.01UF, Z, 10V	1	
	C3023	ECJ1VB1A105K	C 0.01UF, Z, 10V	1	
	C3024	F1J1A106A087	C 0.010UF, K, 10V	1	
	C3025	F1J1A106A087	C 0.010UF, K, 10V	1	
	C3026	F1J1A106A087	C 0.010UF, K, 10V	1	
	C3031	ECJ1VB1A105K	C 0.01UF, Z, 10V	1	
	C3032	ECJ1VB1A105K	C 0.01UF, Z, 10V	1	
	C3108	F1G1E333A091	C 0.033UF, K, 25V	1	
	C3109	F1G1E333A091	C 0.033UF, K, 25V	1	
	C3120	EEHBC101P	C 100PF, J, 16V	1	
	C3121	EEHBC101P	C 100PF, J, 16V	1	
	C3124	F1J1A106A087	C 0.010UF, K, 10V	1	
	C3125	F1J1A106A087	C 0.010UF, K, 10V	1	
	C3129	F1J1A106A087	C 0.010UF, K, 10V	1	
	C3130	F1G1C104A116	C 0.10UF, K, 16V	1	
	C3131	F1J1A106A087	C 0.010UF, K, 10V	1	
	C3132	F1J1A106A087	C 0.010UF, K, 10V	1	
	C3135	F1G1H561A730	C 56UF, 50V	1	
	C3136	F1G1H561A730	C 56UF, 50V	1	
	C3139	F1G1H561A730	C 56UF, 50V	1	
	C3140	F1G1H561A730	C 56UF, 50V	1	
	C3145	F1J1A106A087	C 0.010UF, K, 10V	1	
	C3146	F1J1A106A087	C 0.010UF, K, 10V	1	
	C3147	F1J1A106A087	C 0.010UF, K, 10V	1	
	C3148	F1J1A106A087	C 0.010UF, K, 10V	1	
	C3151	ECJ1VB1A105K	C 0.01UF, Z, 10V	1	
	C3152	ECJ1VB1A105K	C 0.01UF, Z, 10V	1	
	C3155	F1G1H561A730	C 56UF, 50V	1	
	C3156	F1G1H561A730	C 56UF, 50V	1	
	C3157	ECJ1VB1A105K	C 0.01UF, Z, 10V	1	
	C3158	ECJ1VB1A105K	C 0.01UF, Z, 10V	1	
	C3163	F1J1A106A087	C 0.010UF, K, 10V	1	
	C3164	F1J1A106A087	C 0.010UF, K, 10V	1	
	C3165	F1J1A106A087	C 0.010UF, K, 10V	1	
	C4546	ECJ1VB0J105K	C 1UF, K, 6.3V	1	
	C4547	ECJ1VB0J105K	C 1UF, K, 6.3V	1	
	C4660	ECJ1VB0J105K	C 1UF, K, 6.3V	1	
	C4661	ECJ1VB0J105K	C 1UF, K, 6.3V	1	
	C4662	ECJ1VB0J105K	C 1UF, K, 6.3V	1	
	C4663	ECJ1VB0J105K	C 1UF, K, 6.3V	1	
	C4664	ECJ1VB0J105K	C 1UF, K, 6.3V	1	
	C4665	ECJ1VB0J105K	C 1UF, K, 6.3V	1	
	C4666	ECJ1VB0J105K	C 1UF, K, 6.3V	1	
	C4667	ECJ1VB0J105K	C 1UF, K, 6.3V	1	
	C4701	F1G1C104A116	C 0.10UF, K, 16V	1	
	C4702	F1G1C104A116	C 0.10UF, K, 16V	1	
	C4704	F1G1C104A116	C 0.10UF, K, 16V	1	
	C4705	F1G1C104A116	C 0.10UF, K, 16V	1	
	C5000	F1G1C104A116	C 0.10UF, K, 16V	1	
	C5001	F1G1C104A116	C 0.10UF, K, 16V	1	
	C5002	F1G1C104A116	C 0.10UF, K, 16V	1	
	C5003	F1G1C104A116	C 0.10UF, K, 16V	1	
	C5004	F1G1H102A730	C 1000UF, 50V	1	
	C5050	F1J1A475A087	C 4.7UF, K, 10V	1	
	C5052	F2G1A221A149	E 220UF, 10V	1	
	C5055	F1G1C104A116	C 0.10UF, K, 16V	1	
	C5058	ECJ1VB0J105K	C 1UF, K, 6.3V	1	

Safety	Ref. No.	Part No.	Part Name & Description	Pcs	Remarks
	C5100	F1G1C104A116	C 0.10UF, K, 16V	1	
	C5101	F1H1A474A084	C 0.47UF, 50V	1	
	C5155	F1J0J106A004	C 0.010UF, K, 16V	1	
	C5156	F1J0J106A004	C 0.010UF, K, 16V	1	
	C5157	F1J0J106A004	C 0.010UF, K, 16V	1	
	C5158	F1J0J106A004	C 0.010UF, K, 16V	1	
	C5159	F1J0J106A004	C 0.010UF, K, 16V	1	
	C5160	F1J0J106A004	C 0.010UF, K, 16V	1	
	C5471	F1G1C104A116	C 0.10UF, K, 16V	1	
	C5472	F1G1C104A116	C 0.10UF, K, 16V	1	
	C5600	F1K1E106A136	C 10UF, Z, 25V	1	
	C5601	F1K1E106A136	C 10UF, Z, 25V	1	
	C5602	F1G1E682A123	C 6800UF, Z, 25V	1	
	C5603	F1K1E106A136	C 10UF, Z, 25V	1	
	C5604	F1K1E106A136	C 10UF, Z, 25V	1	
	C5606	F1G1A154A053	C0.015UF, K, 10V	1	
	C5607	F1J1A475A087	C 4.7UF, K, 10V	1	
	C5608	F1H1C104A143	C 0.1UF, K, 16V	1	
	C5609	F1H1C104A143	C 0.1UF, K, 16V	1	
	C5611	F1J1E105A231	C 1 UF 25V	1	
	C5612	F1H1C105A145	C 0.01UF, K, 16V	1	
	C5615	F1H1A225A051	C 22UF, 50V	1	
	C5616	F1G1E103A123	C 0.010UF, K, 25V	1	
	C5617	F1K0J226A008	C 22UF, K, 6.3V	1	
	C5618	F1K0J226A008	C 22UF, K, 6.3V	1	
	C5619	F1K0J226A008	C 22UF, K, 6.3V	1	
	C5620	F1K0J226A008	C 22UF, K, 6.3V	1	
	C5621	F1K0J226A008	C 22UF, K, 6.3V	1	
	C5622	F1K0J226A008	C 22UF, K, 6.3V	1	
	C5625	F1K1E106A136	C 10UF, Z, 25V	1	
	C5626	F1K1E106A136	C 10UF, Z, 25V	1	
	C5627	F1G1A393A053	C0.015UF, K, 10V	1	
	C5628	F1K1E106A136	C 10UF, Z, 25V	1	
	C5629	F1K1E106A136	C 10UF, Z, 25V	1	
	C5631	F1G1C104A116	C 0.10UF, K, 16V	1	
	C5632	F1J1A475A087	C 4.7UF, K, 10V	1	
	C5633	F1H1C104A143	C 0.1UF, K, 16V	1	
	C5634	F1H1C104A143	C 0.1UF, K, 16V	1	
	C5635	F1H1C105A145	C 0.01UF, K, 16V	1	
	C5641	F1K0J226A008	C 22UF, K, 6.3V	1	
	C5642	F1K0J226A008	C 22UF, K, 6.3V	1	
	C5643	F1K0J226A008	C 22UF, K, 6.3V	1	
	C5649	ECJ1VB1A105K	C 0.01UF, Z, 10V	1	
	C5650	F1H1A225A051	C 22UF, 50V	1	
	C5651	F1J1A475A087	C 4.7UF, K, 10V	1	
	C5652	F1J1A475A087	C 4.7UF, K, 10V	1	
	C5658	F1K0J226A008	C 22UF, K, 6.3V	1	
	C5659	F1K0J226A008	C 22UF, K, 6.3V	1	
	C5660	F1K0J226A008	C 22UF, K, 6.3V	1	
	C5722	F1J1E105A231	C 1 UF 25V	1	
	C5723	F1H1C105A145	C 0.01UF, K, 16V	1	
	C8000	F1G1C104A116	C 0.10UF, K, 16V	1	
	C8001	F1G1C104A116	C 0.10UF, K, 16V	1	
	C8002	F1G1C104A116	C 0.10UF, K, 16V	1	
	C8003	F1G1C104A116	C 0.10UF, K, 16V	1	
	C8004	F1G1C104A116	C 0.10UF, K, 16V	1	
	C8005	F1G1C104A116	C 0.10UF, K, 16V	1	
	C8006	F1G1C104A116	C 0.10UF, K, 16V	1	
	C8007	F1G1C104A116	C 0.10UF, K, 16V	1	
	C8008	F1G1C104A116	C 0.10UF, K, 16V	1	
	C8009	F1G1C104A116	C 0.10UF, K, 16V	1	
	C8010	F1G1C104A116	C 0.10UF, K, 16V	1	
	C8011	F1G1C104A116	C 0.10UF, K, 16V	1	
	C8012	F1G1C104A116	C 0.10UF, K, 16V	1	
	C8013	F1G1C104A116	C 0.10UF, K, 16V	1	
	C8014	F1G1C104A116	C 0.10UF, K, 16V	1	
	C8015	ECJ1VB0J105K	C 1UF, K, 6.3V	1	

Safety	Ref. No.	Part No.	Part Name & Description	Pcs	Remarks
	C8016	ECJ1VB0J105K	C 1UF, K, 6.3V	1	
	C8017	FIG1C104A116	C 0.10UF, K, 16V	1	
	C8019	FIG1C104A116	C 0.10UF, K, 16V	1	
	C8020	FIG1C104A116	C 0.10UF, K, 16V	1	
	C8021	FIG1C104A116	C 0.10UF, K, 16V	1	
	C8022	FIJ1A106A087	C 0.010UF, K, 10V	1	
	C8023	FIJ1A106A087	C 0.010UF, K, 10V	1	
	C8024	FIJ1A106A087	C 0.010UF, K, 10V	1	
	C8035	FIJ1A106A087	C 0.010UF, K, 10V	1	
	C8036	FIJ1A106A087	C 0.010UF, K, 10V	1	
	C8037	FIG1C104A116	C 0.10UF, K, 16V	1	
	C8042	ECJ1VB0J105K	C 1UF, K, 6.3V	1	
	C8044	FIJ1A106A087	C 0.010UF, K, 10V	1	
	C8045	FIG1C104A116	C 0.10UF, K, 16V	1	
	C8046	FIG1C104A116	C 0.10UF, K, 16V	1	
	C8047	FIG1C104A116	C 0.10UF, K, 16V	1	
	C8048	ECJ1VB0J105K	C 1UF, K, 6.3V	1	
	C8050	FIG1C104A116	C 0.10UF, K, 16V	1	
	C8051	FIG1C104A116	C 0.10UF, K, 16V	1	
	C8052	FIG1C104A116	C 0.10UF, K, 16V	1	
	C8053	FIG1C104A116	C 0.10UF, K, 16V	1	
	C8054	FIG1C104A116	C 0.10UF, K, 16V	1	
	C8055	FIG1C104A116	C 0.10UF, K, 16V	1	
	C8056	FIG1C104A116	C 0.10UF, K, 16V	1	
	C8057	FIG1C104A116	C 0.10UF, K, 16V	1	
	C8058	FIG1C104A116	C 0.10UF, K, 16V	1	
	C8062	FIG1C104A116	C 0.10UF, K, 16V	1	
	C8063	FIG1C104A116	C 0.10UF, K, 16V	1	
	C8064	FIJOG2260001	C 0.001UF, 6.3V	1	
	C8067	FIG1C104A116	C 0.10UF, K, 16V	1	
	C8068	FIG1C104A116	C 0.10UF, K, 16V	1	
	C8069	FIG1C104A116	C 0.10UF, K, 16V	1	
	C8070	FIG1C104A116	C 0.10UF, K, 16V	1	
	C8073	ECJ1VB0J105K	C 1UF, K, 6.3V	1	
	C8074	ECJ1VB0J105K	C 1UF, K, 6.3V	1	
	C8075	ECJ1VB0J105K	C 1UF, K, 6.3V	1	
	C8076	FIG1C104A116	C 0.10UF, K, 16V	1	
	C8077	FIG1E103A123	C 0.010UF, K, 25V	1	
	C8079	FIG1H120A731	C 12UF, 50V	1	
	C8080	FIG1H8R0A732	C 8.0UF, 50V	1	
	C8081	FIG1H100A731	C 10PF, K, 50V	1	
	C8082	FIG1H8R0A732	C 8.0UF, 50V	1	
	C8085	FIJ1A106A087	C 0.010UF, K, 10V	1	
	C8091	FIG1C104A116	C 0.10UF, K, 16V	1	
	C8093	ECJ1VB0J105K	C 1UF, K, 6.3V	1	
	C8097	FIG1C104A116	C 0.10UF, K, 16V	1	
	C8099	ECJ1VB0J105K	C 1UF, K, 6.3V	1	
	C8100	FIJ1A106A087	C 0.010UF, K, 10V	1	
	C8101	FIJ1A106A087	C 0.010UF, K, 10V	1	
	C8104	ECJ1VB0J105K	C 1UF, K, 6.3V	1	
	C8105	FIG1C104A116	C 0.10UF, K, 16V	1	
	C8108	FIG1C104A116	C 0.10UF, K, 16V	1	
	C8110	FIG1C104A116	C 0.10UF, K, 16V	1	
	C8111	FIG1C104A116	C 0.10UF, K, 16V	1	
	C8112	FIG1C104A116	C 0.10UF, K, 16V	1	
	C8113	FIG1C104A116	C 0.10UF, K, 16V	1	
	C8114	FIG1C104A116	C 0.10UF, K, 16V	1	
	C8115	FIG1C104A116	C 0.10UF, K, 16V	1	
	C8116	FIG1C104A116	C 0.10UF, K, 16V	1	
	C8117	FIG1C104A116	C 0.10UF, K, 16V	1	
	C8120	FIG1C104A116	C 0.10UF, K, 16V	1	
	C8123	FIG1C104A116	C 0.10UF, K, 16V	1	
	C8124	FIJ1A106A087	C 0.010UF, K, 10V	1	

Safety	Ref. No.	Part No.	Part Name & Description	Pcs	Remarks
	C8125	FIJ1A106A087	C 0.010UF, K, 10V	1	
	C8126	FIJ1A106A087	C 0.010UF, K, 10V	1	
	C8127	ECJ1VB0J105K	C 1UF, K, 6.3V	1	
	C8300	FIG1C104A116	C 0.10UF, K, 16V	1	
	C8301	FIG1C104A116	C 0.10UF, K, 16V	1	
	C8303	FIG1C104A116	C 0.10UF, K, 16V	1	
	C8304	FIG1H100A731	C 10PF, K, 50V	1	
	C8305	FIG1H100A731	C 10PF, K, 50V	1	
	C8306	FIG1C104A116	C 0.10UF, K, 16V	1	
	C8308	FIG1C104A116	C 0.10UF, K, 16V	1	
	C8309	FIG1C104A116	C 0.10UF, K, 16V	1	
	C8310	FIG1C104A116	C 0.10UF, K, 16V	1	
	C8311	FIJ1A106A087	C 0.010UF, K, 10V	1	
	C8314	FIG1C104A116	C 0.10UF, K, 16V	1	
	C8315	FIG1C104A116	C 0.10UF, K, 16V	1	
	C8316	FIG1C104A116	C 0.10UF, K, 16V	1	
	C8317	FIG1C104A116	C 0.10UF, K, 16V	1	
	C8318	FIG1C104A116	C 0.10UF, K, 16V	1	
	C8319	FIG1C104A116	C 0.10UF, K, 16V	1	
	C8320	ECJ1VB1A105K	C 0.01UF, Z, 10V	1	
	C8321	FIH1A225A051	C 22UF, 50V	1	
	C8322	FIG1C104A116	C 0.10UF, K, 16V	1	
	C8324	FIG1H560A731	C 56UF, 50V	1	
	C8325	FIG1H560A731	C 56UF, 50V	1	
	C8400	FIG1C104A116	C 0.10UF, K, 16V	1	
	C8401	FIG1C104A116	C 0.10UF, K, 16V	1	
	C8402	FIG1C104A116	C 0.10UF, K, 16V	1	
	C8403	FIG1C104A116	C 0.10UF, K, 16V	1	
	C8404	FIG1C104A116	C 0.10UF, K, 16V	1	
	C8405	FIG1C104A116	C 0.10UF, K, 16V	1	
	C8406	FIG1C104A116	C 0.10UF, K, 16V	1	
	C8407	FIG1C104A116	C 0.10UF, K, 16V	1	
	C8408	FIG1C104A116	C 0.10UF, K, 16V	1	
	C8409	FIG1C104A116	C 0.10UF, K, 16V	1	
	C8410	FIG1C104A116	C 0.10UF, K, 16V	1	
	C8411	EEEB1C101P	C 100PF, J, 16V	1	
	C8412	FIG1C104A116	C 0.10UF, K, 16V	1	
	C8413	FIG1E103A123	C 0.010UF, K, 25V	1	
	C8414	FIG1E103A123	C 0.010UF, K, 25V	1	
	C8415	FIG1C104A116	C 0.10UF, K, 16V	1	
	C8600	FIG1H102A730	C 1000UF, 50V	1	
	C8853	FIG1C104A116	C 0.10UF, K, 16V	1	
	C8854	FIG1C104A116	C 0.10UF, K, 16V	1	
	C8860	F2G1C470A022	E 47UF, 16V	1	
	C8861	FIG1C104A116	C 0.10UF, K, 16V	1	
	C8862	FIG1C103A116	C 0.010UF, K, 16V	1	
	C8863	FIJOG226A001	C 0.001UF, 6.3V	1	
	C8922	FIG1C104A116	C 0.10UF, K, 16V	1	
	C8923	FIG1C104A116	C 0.10UF, K, 16V	1	
	C8950	FIG1C103A116	C 0.010UF, K, 16V	1	
	C9040	FIG1C104A116	C 0.10UF, K, 16V	1	
	C9052	FIG1C104A116	C 0.10UF, K, 16V	1	
	C9066	FIK0J226A008	C 22UF, K, 6.3V	1	
	C9067	FIG1H561A730	C 56UF, 50V	1	
	C9100	FIJ1A106A087	C 0.010UF, K, 10V	1	
	C9101	FIG1E103A123	C 0.010UF, K, 25V	1	
	C9102	FIK1E106A136	C 10UF, Z, 25V	1	
	C9103	FIG1E103A123	C 0.010UF, K, 25V	1	
	C9106	FIK1E106A136	C 10UF, Z, 25V	1	
	C9108	FIG1E103A123	C 0.010UF, K, 25V	1	
	C9116	FIG1C104A116	C 0.10UF, K, 16V	1	
	C9300	FIG1C104A116	C 0.10UF, K, 16V	1	
	C9301	FIG1H150A731	C 15UF, 50V	1	
	C9302	FIG1H180A731	C 18UF, 50V	1	

Safety	Ref. No.	Part No.	Part Name & Description	Pcs	Remarks
	C9303	F1G1C104A116	C 0.10UF, K, 16V	1	
	C9307	F1G1C104A116	C 0.10UF, K, 16V	1	
	C9308	F1G1C104A116	C 0.10UF, K, 16V	1	
	C9311	F1G1C104A116	C 0.10UF, K, 16V	1	
	C9312	F1J1A106A087	C 0.010UF, K, 10V	1	
	C9313	F1G1C104A116	C 0.10UF, K, 16V	1	
	C9314	F1J1A106A087	C 0.010UF, K, 10V	1	
	C9315	F1G1C104A116	C 0.10UF, K, 16V	1	
	C9316	F1J1A106A087	C 0.010UF, K, 10V	1	
	C9319	F1G1C104A116	C 0.10UF, K, 16V	1	
	C9322	F1G1C104A116	C 0.10UF, K, 16V	1	
	C9323	F1G1C104A116	C 0.10UF, K, 16V	1	
	C9325	F1G1C104A116	C 0.10UF, K, 16V	1	
	C9327	F1G1C104A116	C 0.10UF, K, 16V	1	
	C9335	F1J1A106A087	C 0.010UF, K, 10V	1	
	C9336	F1J1A106A087	C 0.010UF, K, 10V	1	
	C9337	F1J1A106A087	C 0.010UF, K, 10V	1	
	C9339	F1G1C104A116	C 0.10UF, K, 16V	1	
	C9340	F1G1C104A116	C 0.10UF, K, 16V	1	
	C9342	F1G1C104A116	C 0.10UF, K, 16V	1	
	C9344	F1G1C104A116	C 0.10UF, K, 16V	1	
	C9347	ECJ1VB0J105K	C 1UF, K, 6.3V	1	
	C9349	F1J1A106A087	C 0.010UF, K, 10V	1	
	C9350	F1G1C104A116	C 0.10UF, K, 16V	1	
	C9351	F1G1C104A116	C 0.10UF, K, 16V	1	
	C9352	ECJ1VB0J105K	C 1UF, K, 6.3V	1	
	C9356	F1G1C104A116	C 0.10UF, K, 16V	1	
	C9361	F1G1C104A116	C 0.10UF, K, 16V	1	
	C9363	F1G1C104A116	C 0.10UF, K, 16V	1	
	C9371	F1J1A106A087	C 0.010UF, K, 10V	1	
	C9372	F1J1A106A087	C 0.010UF, K, 10V	1	
	C9373	F1J1A106A087	C 0.010UF, K, 10V	1	
	C9374	F1G1C104A116	C 0.10UF, K, 16V	1	
	C9375	F1G1C104A116	C 0.10UF, K, 16V	1	
	C9380	F1G1C104A116	C 0.10UF, K, 16V	1	
	C9383	F1G1C104A116	C 0.10UF, K, 16V	1	
	C9391	F1J1A106A087	C 0.010UF, K, 10V	1	
	C9392	F1J1A106A087	C 0.010UF, K, 10V	1	
	C9393	F1G1C104A116	C 0.10UF, K, 16V	1	
	C9394	F1G1C104A116	C 0.10UF, K, 16V	1	
	C9400	F1G1C104A116	C 0.10UF, K, 16V	1	
	C9401	F1G1C104A116	C 0.10UF, K, 16V	1	
	C9800	F1H1E104A129	C 0.1UF, 25V	1	
	C9801	F1G1E682A123	C 6800UF, Z, 25V	1	
	C9803	F1G1E472A123	C 4200UF, Z, 25V	1	
	C9804	F1K1E106A136	C 10UF, Z, 25V	1	
	C9805	F1K1E106A136	C 10UF, Z, 25V	1	
	C9806	F1G1H101A731	C 100PF, K, 50V	1	
	C9807	F1G1H201A731	C 200 UF, K, 50V	1	
	C9809	F1G1H102A730	C 1000UF, 50V	1	
	C9811	F1G1C104A116	C 0.10UF, K, 16V	1	
	C9812	F1K1E106A136	C 10UF, Z, 25V	1	
	C9813	F1K1E106A136	C 10UF, Z, 25V	1	
	C9814	F1K0J226A008	C 22UF, K, 6.3V	1	
	C9815	F1K0J226A008	C 22UF, K, 6.3V	1	
	C9816	F1G1E103A123	C 0.010UF, K, 25V	1	
	C9817	F1J1A106A087	C 0.010UF, K, 10V	1	
	C9819	F1J1A106A087	C 0.010UF, K, 10V	1	
	C9825	F1K0J226A008	C 22UF, K, 6.3V	1	
	C9900	F1G1E103A123	C 0.010UF, K, 25V	1	

Safety	Ref. No.	Part No.	Part Name & Description	Pcs	Remarks
		CN0102	K1KA11A00178	11P CONNECTOR	1
		D1101	B0JCCE000008	DIODE	1
		D2014	B0ACCJ000048	DIODE	1
		D2520	B3AGB0000060	LED	1 PAVCCZ
		D2870	B0JCME000092	DIODE	1
		D3124	DZ2J140M0L	ZENER DIODE	1 PAVCCZ
		D3130	B0ACCJ000048	DIODE	1
		D3300	K7AAAY000006	PHOTO LINK	1
		D4702	B0ACCJ000048	DIODE	1
		D4704	B0JCCE000008	DIODE	1
		D4719	B0ACCJ000048	DIODE	1
		D4721	B0JCCE000008	DIODE	1
		D5000	B0ADCJ000100	DIODE	1
		D5051	B0JCME000076	DIODE	1
		D5052	B0ACCJ000048	DIODE	1
		D5100	B0ADEJ000035	ZENER DIODE	1
		D5471	B0ACCJ000048	DIODE	1
		D5472	B0ADEJ000035	ZENER DIODE	1
		D5475	B0ADCJ000100	DIODE	1
		D5476	DZ2J068M0L	ZENER DIODE	1 PAVCCZ
		D5477	DZ2J068M0L	ZENER DIODE	1 PAVCCZ
		D5478	B0ADCJ000100	DIODE	1
		D5479	B0ADCJ000100	DIODE	1
		D5480	B0ADCJ000100	DIODE	1
		D5481	DZ2J120M0L	ZENER DIODE	1
		D5482	DZ2J120M0L	ZENER DIODE	1
		D5483	DZ2J068M0L	ZENER DIODE	1 PAVCCZ
		D5484	DZ2J068M0L	ZENER DIODE	1 PAVCCZ
		D5485	DZ2J068M0L	ZENER DIODE	1 PAVCCZ
		D5486	DZ2J068M0L	ZENER DIODE	1 PAVCCZ
		D5602	DZ2J056M0L	ZENER DIODE	1
		D5605	B0HCCM000014	DIODE	1
		D9804	B0JCPG000030	DIODE	1
		D9806	B0ADCJ000100	DIODE	1
		D9807	B0ADCJ000100	DIODE	1
		IC1000	C1ZBZ0003775	IC	1
		IC1100	TVRR539	IC	1 PAVCCZ
		IC2301	C1AB00003230	IC	1
		IC2870	C0DBAY00462	IC	1
		IC2950	C0CBCAG00031	IC	1
		IC2952	C0DBGY00281	IC	1
		IC2953	C0DBFY00049	IC	1
		IC3000	C1AB00003218	IC	1
		IC3001	C0DBGY00281	IC	1
		IC5000	C1ZBZ0004161	IC	1
		IC5401	C0DBGY00884	IC	1
		IC5600	C0DBAY00715	IC	1
		IC5601	C0DBAY00715	IC	1
		IC5603	C0DBFY00049	IC	1
		IC5604	C0DBGY00578	IC	1
		IC8001	MN2WS0125FE	IC	1 PAVCCZ
		IC8300	C1AB00003188	IC	1 PAVCCZ
		IC8302	C0DBFY00041	IC	1 PAVCCZ
		IC8400	C1AB00003193	IC	1 PAVCCZ
		IC8401	C1AB00002913	IC	1 PAVCCZ
		IC8402	C0ZBZ0001584	IC	1 PAVCCZ
		IC8921	TVRR431	IC	1 PAVCCZ
		IC8950	TVRR502	IC	1 PAVCCZ
		IC9300	C1AB00003259	IC	1 PAVCCZ
		IC9304	TVRR577	IC	1 PAVCCZ
		IC9400	C0JBAZ002692	IC	1
		IC9401	C0JBAZ002692	IC	1
		IC9800	C0DBAY00605	IC	1
		IC9801	C0DBAY00462	IC	1
		IC9802	C0DBEH00006	IC	1
		JK3100C	K2HA608A0008	JACK	1 PAVCCZ
		JK3302A	K1FY121A0010	CONNECTOR	1 PAVCCZ
		JK4700	K1FY119D0011	CONNECTOR	1 PAVCCZ
		JK4701	K1FY119D0011	CONNECTOR	1 PAVCCZ

Safety	Ref. No.	Part No.	Part Name & Description	Pcs	Remarks
	JK8850	K1NA12E00017	12P CONNECTOR	1	
	JK8940	K1NA68B00054	68P CONNECTOR	1	PAVCCZ
	JK3107A	K4AK04B00002	TERMINAL BOARD	1	
	K1	K1KA05B00219	5P CONNECTOR	1	
	L2301	J0JHC0000042	CHIP INDUCTOR	1	
	L2302	G1C3R0ZA0156	INDUCTION COIL	1	
	L2303	G1C220MA0416	INDUCTION COIL	1	
	L2304	G1C220MA0416	INDUCTION COIL	1	
	L2305	G1C220MA0416	INDUCTION COIL	1	
	L2306	G1C220MA0416	INDUCTION COIL	1	
	L2870	G1C101MA0416	INDUCTION COIL	1	PAVCCZ
	L2871	J0JHC0000075	CHIP INDUCTOR	1	
	L2900	J0JCC0000278	CHIP INDUCTOR	1	
	L2901	J0JCC0000278	CHIP INDUCTOR	1	
	L2904	J0JCC0000278	CHIP INDUCTOR	1	
	L2905	J0JHC0000046	CHIP INDUCTOR	1	
	L2906	J0JCC0000278	CHIP INDUCTOR	1	
	L2950	J0JHC0000045	CHIP INDUCTOR	1	
	L3102	J0JYC0000331	CHIP INDUCTOR	1	PAVCCZ
	L3103	J0JYC0000331	CHIP INDUCTOR	1	PAVCCZ
	L3108	J0JCC0000287	CHIP INDUCTOR	1	
	L3111	J0JYC0000331	CHIP INDUCTOR	1	PAVCCZ
	L3112	J0JYC0000331	CHIP INDUCTOR	1	PAVCCZ
	L3113	J0JYC0000331	CHIP INDUCTOR	1	PAVCCZ
	L3116	J0JYC0000331	CHIP INDUCTOR	1	PAVCCZ
	L3117	J0JYC0000331	CHIP INDUCTOR	1	PAVCCZ
	L3118	J0JYC0000331	CHIP INDUCTOR	1	PAVCCZ
	L3121	J0JCC0000287	CHIP INDUCTOR	1	
	L3125	J0JYC0000331	CHIP INDUCTOR	1	PAVCCZ
	L4700	J0JYC0000068	CHIP INDUCTOR	1	
	L4701	J0JYC0000068	CHIP INDUCTOR	1	
	L4702	J0JYC0000068	CHIP INDUCTOR	1	
	L4703	J0JYC0000068	CHIP INDUCTOR	1	
	L4704	J0JYC0000068	CHIP INDUCTOR	1	
	L4705	J0JYC0000068	CHIP INDUCTOR	1	
	L5000	J0JYC0000068	CHIP INDUCTOR	1	
	L5600	G1C2R2Z00006	INDUCTION COIL	1	
	L5601	G1C3R3Z00004	INDUCTION COIL	1	
	L5602	G1C100MA0077	INDUCTION COIL	1	
	L5603	J0JHC0000075	CHIP INDUCTOR	1	
	L5604	G1C3R3Z00005	INDUCTION COIL	1	
	L5605	G1C4R7Z00014	INDUCTION COIL	1	
	L5606	G1C100MA0077	INDUCTION COIL	1	
	L5608	J0JHC0000045	CHIP INDUCTOR	1	
	L8000	J0JHC0000045	CHIP INDUCTOR	1	
	L8001	J0JHC0000116	CHIP INDUCTOR	1	
	L8002	J0JKC0000021	CHIP INDUCTOR	1	
	L8003	J0JKC0000021	CHIP INDUCTOR	1	
	L8004	J0JHC0000045	CHIP INDUCTOR	1	
	L8005	J0JKC0000021	CHIP INDUCTOR	1	
	L8007	J0JHC0000045	CHIP INDUCTOR	1	
	L8008	J0JHC0000045	CHIP INDUCTOR	1	
	L8009	J0JHC0000045	CHIP INDUCTOR	1	
	L8010	J0JHC0000045	CHIP INDUCTOR	1	
	L8011	J0JHC0000045	CHIP INDUCTOR	1	
	L8012	J0JHC0000045	CHIP INDUCTOR	1	
	L8013	J0JHC0000045	CHIP INDUCTOR	1	
	L8014	J0JHC0000045	CHIP INDUCTOR	1	
	L8015	J0JHC0000045	CHIP INDUCTOR	1	
	L8016	J0JHC0000045	CHIP INDUCTOR	1	
	L8017	J0JHC0000045	CHIP INDUCTOR	1	
	L8018	J0JHC0000045	CHIP INDUCTOR	1	
	L8019	J0JHC0000045	CHIP INDUCTOR	1	
	L8020	J0JHC0000045	CHIP INDUCTOR	1	
	L8021	J0JHC0000045	CHIP INDUCTOR	1	
	L8022	J0JHC0000045	CHIP INDUCTOR	1	
	L8023	J0JHC0000045	CHIP INDUCTOR	1	
	L8024	J0JHC0000045	CHIP INDUCTOR	1	
	L8025	J0JHC0000045	CHIP INDUCTOR	1	
	L8300	J0JHC0000045	CHIP INDUCTOR	1	
	L8302	J0JHC0000045	CHIP INDUCTOR	1	

Safety	Ref. No.	Part No.	Part Name & Description	Pcs	Remarks
	L8303	J0JHC0000045	CHIP INDUCTOR	1	
	L8304	J0JHC0000045	CHIP INDUCTOR	1	
	L8400	J0JHC0000045	CHIP INDUCTOR	1	
	L8401	J0JHC0000045	CHIP INDUCTOR	1	
	L8850	J0JHC0000045	CHIP INDUCTOR	1	
	L8920	J0JHC0000075	CHIP INDUCTOR	1	
	L9300	J0JHC0000117	CHIP INDUCTOR	1	
	L9301	J0JHC0000117	CHIP INDUCTOR	1	
	L9302	J0JHC0000117	CHIP INDUCTOR	1	
	L9800	G1C6R8Z00010	INDUCTION COIL	1	
	L9801	G1C100MA0416	INDUCTION COIL	1	
	PA5610	K5H4022A0031	FUSE	1	
	Q2101	DSA200100L	TRANSISTOR	1	
	Q2109	DSA200100L	TRANSISTOR	1	
	Q2252	DSA200100L	TRANSISTOR	1	
	Q2253	B1AAF000002	TRANSISTOR	1	PAVCCZ
	Q2254	B1AAF000002	TRANSISTOR	1	PAVCCZ
	Q2255	DSC2001S0L	TRANSISTOR	1	
	Q2301	DSA200100L	TRANSISTOR	1	
	Q2510	DSC200100L	TRANSISTOR	1	
	Q2511	DSC200100L	TRANSISTOR	1	
	Q2512	DSC200100L	TRANSISTOR	1	
	Q3102	DSC200100L	TRANSISTOR	1	
	Q3103	DSC200100L	TRANSISTOR	1	
	Q4512	B1HFCA00026	TRANSISTOR	1	
	Q4513	DSA200100L	TRANSISTOR	1	
	Q4700	DSC200100L	TRANSISTOR	1	
	Q4702	DSC200100L	TRANSISTOR	1	
	Q5000	DSC200100L	TRANSISTOR	1	
	Q5051	DSA200100L	TRANSISTOR	1	
	Q5100	DSC2001S0L	TRANSISTOR	1	
	Q5101	DSC200100L	TRANSISTOR	1	
	Q5471	DSA200100L	TRANSISTOR	1	
	Q5472	DSC2001S0L	TRANSISTOR	1	
	Q5600	B1MBDA00003	FET	1	
	Q5601	B1MBEDA00015	FET	1	
	Q5602	DSC2001S0L	TRANSISTOR	1	
	Q5603	DSC2001S0L	TRANSISTOR	1	
	Q5604	B1MBDA00003	FET	1	
	Q5605	B1MBEDA00015	FET	1	
	Q8400	DSC200100L	TRANSISTOR	1	
	Q8401	DSC200100L	TRANSISTOR	1	
	Q9900	DSC200100L	TRANSISTOR	1	
	Q9901	DSC200100L	TRANSISTOR	1	
	R0900	DOGA680JA015	M 68 OHM, J, 0.063W	1	
	R0901	DOGA680JA015	M 68 OHM, J, 0.063W	1	
	R0902	EXB28V680JX	RESISTOR ARRAY	1	
	R0903	DOGA680JA015	M 68 OHM, J, 0.063W	1	
	R0905	ERJ2GEJ103	M 10KOHM, J, 0.063W	1	
	R0910	ERJ2GEJ103	M 10KOHM, J, 0.063W	1	
	R0911	ERJ2GEJ103	M 10KOHM, J, 0.063W	1	
	R0912	ERJ2GEJ103	M 10KOHM, J, 0.063W	1	
	R0913	ERJ2GEJ103	M 10KOHM, J, 0.063W	1	
	R0940	DOGA680JA015	M 68 OHM, J, 0.063W	1	
	R0941	DOGA680JA015	M 68 OHM, J, 0.063W	1	
	R0942	DOGA680JA015	M 68 OHM, J, 0.063W	1	
	R0943	DOGA680JA015	M 68 OHM, J, 0.063W	1	
	R0944	DOGA680JA015	M 68 OHM, J, 0.063W	1	
	R0945	DOGA680JA015	M 68 OHM, J, 0.063W	1	

Safety	Ref. No.	Part No.	Part Name & Description	Pcs	Remarks
	R0948	D0GA222JA015	M 2.2KOHM, J,0.063W	1	
	R0949	D0GA222JA015	M 2.2KOHM, J,0.063W	1	
	R0957	ERJ2GEJ102X	M 1K OHM J 1/4W	1	
	R0966	D0GA472JA015	M 4.7KOHM, J,0.063W	1	
	R0967	D0GA472JA015	M 4.7KOHM, J,0.063W	1	
	R0980	D0GA472JA015	M 4.7KOHM, J,0.063W	1	
	R0981	D0GA472JA015	M 4.7KOHM, J,0.063W	1	
	R0982	ERJ2GEJ220	M 22 OHM, J,0.063W	1	
	R0983	ERJ2GEJ220	M 22 OHM, J,0.063W	1	
	R0984	D0GA472JA015	M 4.7KOHM, J,0.063W	1	
	R0985	D0GA472JA015	M 4.7KOHM, J,0.063W	1	
	R1179	D1BB7151A055	M7.15KOHM, 1/10W	1	
	R1180	ERJ2GEJ102X	M 1K OHM J 1/4W	1	
	R1181	D0GA473JA015	M 47KOHM, J,0.063W	1	
	R1183	D0GA472JA015	M 4.7KOHM, J,0.063W	1	
	R1185	D0GA101JA015	M 100 OHM, J,0.063W	1	
	R1186	D0GA473JA015	M 47KOHM, J,0.063W	1	
	R1187	D0GA273JA015	M 27K OHM J ,0.063W	1	
	R1503	D0GA473JA015	M 47KOHM, J,0.063W	1	
	R1518	D0GA683JA015	M 68KOHM, J,0.063W	1	
	R1519	D0GA473JA015	M 47KOHM, J,0.063W	1	
	R1520	ERJ2GEJ103	M 10KOHM, J,0.063W	1	
	R1521	ERJ2GEJ104	M 100KOHM, J,0.063W	1	
	R1552	D0GA472JA015	M 4.7KOHM, J,0.063W	1	
	R1562	D0GA473JA015	M 47KOHM, J,0.063W	1	
	R1563	D0GA473JA015	M 47KOHM, J,0.063W	1	
	R2053	D1BB1403A055	M 140KOHM, 1/10W	1	
	R2055	D1BB1403A055	M 140KOHM, 1/10W	1	
	R2069	ERJ2GEJ103	M 10KOHM, J,0.063W	1	
	R2070	ERJ2GEJ103	M 10KOHM, J,0.063W	1	
	R2101	D0GA332JA015	M 3.3KOHM, J,0.063W	1	
	R2102	D0GA472JA015	M 4.7KOHM, J,0.063W	1	
	R2103	ERJ2GEJ220	M 22 OHM, J,0.063W	1	
	R2104	D0GA122JA015	M 1.2KOHM, J,0.063W	1	
	R2110	ERJ2GEJ220	M 22 OHM, J,0.063W	1	
	R2121	D0GA681JA015	M680 OHM, J,0.063W	1	
	R2135	ERJ2GEJ102X	M 1K OHM J 1/4W	1	
	R2139	ERJ2GEJ221	M 220 OHM, J,0.063W	1	
	R2254	D0GA101JA015	M 100 OHM, J,0.063W	1	
	R2255	D0GA473JA015	M 47KOHM, J,0.063W	1	
	R2256	ERJ2GEJ103	M 10KOHM, J,0.063W	1	
	R2257	D0GA105JA015	M 1M OHM, J,0.063W	1	
	R2258	D0GA101JA015	M 100 OHM, J,0.063W	1	

Safety	Ref. No.	Part No.	Part Name & Description	Pcs	Remarks
	R2259	D0GA101JA015	M 100 OHM, J,0.063W	1	
	R2260	ERJ2GEJ103	M 10KOHM, J,0.063W	1	
	R2263	ERJ2GEJ103	M 10KOHM, J,0.063W	1	
	R2264	D0GA101JA015	M 100 OHM, J,0.063W	1	
	R2301	ERJ2GEJ103	M 10KOHM, J,0.063W	1	
	R2302	EXB28V220J	RESISTOR ARRAY	1	
	R2304	D0GA473JA015	M 47KOHM, J,0.063W	1	
	R2307	D0GA472JA015	M 4.7KOHM, J,0.063W	1	
	R2308	ERJ2GEJ221	M 220 OHM, J,0.063W	1	
	R2309	D0GA222JA015	M 2.2KOHM, J,0.063W	1	
	R2310	D0GA222JA015	M 2.2KOHM, J,0.063W	1	
	R2318	ERJ8GEYJ3R3V	M 3.3 OHM, J,1/8W	1	
	R2319	ERJ8GEYJ3R3V	M 3.3 OHM, J,1/8W	1	
	R2320	ERJ8GEYJ3R3V	M 3.3 OHM, J,1/8W	1	
	R2321	ERJ8GEYJ3R3V	M 3.3 OHM, J,1/8W	1	
	R2330	D0GAR00Z0001	C 0 OHM, 0.063W	1	
	R2331	D0GAR00Z0001	C 0 OHM, 0.063W	1	
	R2510	ERJ3GEYJ470	M 47 OHM, J,1/16W	1	
	R2511	D0GB104JA041	M 100KOHM J 1/10W	1	
	R2512	D0GB224JA041	M 2.2KOHM, J,1/10W	1	
	R2513	ERJ3GEYJ223	M 22KOHM, J,1/16W	1	
	R2514	D0GB103JA057	M 10K OHM J 1/10W	1	
	R2515	D0GB473JA057	M 47KOHM, J,1/10W	1	
	R2516	D1BB6800A055	M 680 OHM, 1/10W	1	
	R2517	ERJ3GEYJ223	M 22KOHM, J,1/16W	1	
	R2518	D0GB473JA057	M 47KOHM, J,1/10W	1	
	R2519	D1BB1821A055	M1.82KOHM, 1/10W	1	
	R2750	D0GA101JA015	M 100 OHM, J,0.063W	1	
	R2753	D0GB103JA057	M 10K OHM J 1/10W	1	
	R2816	D0GA473JA015	M 47KOHM, J,0.063W	1	
	R2820	D0GA101JA015	M 100 OHM, J,0.063W	1	
	R2823	D0GA473JA015	M 47KOHM, J,0.063W	1	
	R2870	D0GA222JA015	M 2.2KOHM, J,0.063W	1	
	R2871	ERJ2GEJ103	M 10KOHM, J,0.063W	1	
	R2872	D1BA1501A014	M 1.5KOHM, 0.063W	1	PAVCCZ
	R2873	D1BA1002A014	M 10KOHM, 0.063W	1	
	R2875	D0GA390JA015	M 39 OHM, J,0.063W	1	
	R2880	D1BB1432A055	M14.3KOHM, 1/10W	1	
	R2881	D1BB6651A055	M6.65KOHM, 1/10W	1	
	R2882	D1BB7151A055	M7.15KOHM, 1/10W	1	
	R2883	D1BB1741A055	M 1.74KOHM, 1/16W	1	
	R2914	ERJ2GEJ103	M 10KOHM, J,0.063W	1	
	R2918	D0GAR00Z0001	C 0 OHM, 0.063W	1	
	R2926	D0GA680JA015	M 68 OHM, J,0.063W	1	
	R3003	ERJ2GEJ104	M 100KOHM, J,0.063W	1	
	R3012	ERJ2GEJ221	M 220 OHM, J,0.063W	1	
	R3013	ERJ2GEJ221	M 220 OHM, J,0.063W	1	

Safety	Ref. No.	Part No.	Part Name & Description	Pcs	Remarks
	R3014	ERJ2GEJ221	M 220 OHM, J, 0.063W	1	
	R3108	D0GA101JA015	M 100 OHM, J, 0.063W	1	
	R3120	EXB28V221J	RESISTOR ARRAY	1	
	R3129	ERJ2GEJ104	M 100KOHM, J, 0.063W	1	
	R3134	ERJ6ENF1500	M 150 OHM, 1/10W	1	
	R3135	ERJ6ENF1500	M 150 OHM, 1/10W	1	
	R3136	ERJ6ENF1500	M 150 OHM, 1/10W	1	
	R3137	ERJ6RED750	M 75 OHM, 1/10W	1	
	R3141	ERJ6ENF1500	M 150 OHM, 1/10W	1	
	R3142	ERJ6ENF1500	M 150 OHM, 1/10W	1	
	R3143	ERJ6ENF1500	M 150 OHM, 1/10W	1	
	R3144	ERJ6ENF1500	M 150 OHM, 1/10W	1	
	R3146	ERJ6ENF1500	M 150 OHM, 1/10W	1	
	R3147	ERJ6ENF1500	M 150 OHM, 1/10W	1	
	R3148	D0GAR00Z0001	C 0 OHM, 0.063W	1	
	R3150	ERJ2GEJ221	M 220 OHM, J, 0.063W	1	
	R3151	ERJ2GEJ221	M 220 OHM, J, 0.063W	1	
	R3153	ERJ2GEJ221	M 220 OHM, J, 0.063W	1	
	R3157	EXB28V221J	RESISTOR ARRAY	1	
	R3163	ERJ2GEJ104	M 100KOHM, J, 0.063W	1	
	R3164	ERJ2GEJ104	M 100KOHM, J, 0.063W	1	
	R3167	D0GA333JA015	M 33KOHM, J, 0.063W	1	
	R3168	D0GA333JA015	M 33KOHM, J, 0.063W	1	
	R3171	D0GA222JA015	M 2.2KOHM, J, 0.063W	1	
	R3172	D0GA222JA015	M 2.2KOHM, J, 0.063W	1	
	R3173	EXB28V221J	RESISTOR ARRAY	1	
	R3177	EXB28V331J	RESISTOR ARRAY	1	
	R3181	ERJ6RED750	M 75 OHM, 1/10W	1	
	R3182	ERJ6RED750	M 75 OHM, 1/10W	1	
	R3183	ERJ6RED750	M 75 OHM, 1/10W	1	
	R3186	D0GA333JA015	M 33KOHM, J, 0.063W	1	
	R3187	D0GA333JA015	M 33KOHM, J, 0.063W	1	
	R3192	EXB28V820JX	RESISTOR ARRAY	1	
	R3198	D0GA680JA015	M 68 OHM, J, 0.063W	1	
	R3200	ERJ6ENF1500	M 150 OHM, 1/10W	1	
	R3202	ERJ6ENF1500	M 150 OHM, 1/10W	1	
	R3204	D1BA2152A014	M21.5KOHM, 0.063W	1	PAVCCZ
	R3205	D0GAR00Z0001	C 0 OHM, 0.063W	1	
	R3206	D1BA1302A014	M 13KOHM, 0.063W	1	PAVCCZ
	R3208	D0GA273JA015	M 27K OHM J, 0.063W	1	
	R3211	ERJ2GEJ220	M 22 OHM, J, 0.063W	1	
	R3212	D0GA680JA015	M 68 OHM, J, 0.063W	1	
	R3213	D0GA473JA015	M 47KOHM, J, 0.063W	1	
	R3221	ERJ6ENF1500	M 150 OHM, 1/10W	1	
	R3222	ERJ6ENF1500	M 150 OHM, 1/10W	1	
	R4003	D0GA473JA015	M 47KOHM, J, 0.063W	1	
	R4004	D0GA473JA015	M 47KOHM, J, 0.063W	1	
	R4005	D0GA473JA015	M 47KOHM, J, 0.063W	1	
	R4006	D0GA473JA015	M 47KOHM, J, 0.063W	1	
	R4011	D0GA473JA015	M 47KOHM, J, 0.063W	1	
	R4548	ERJ2GEJ220	M 22 OHM, J, 0.063W	1	
	R4549	D0GA151JA015	M 150 OHM, J, 0.063W	1	

Safety	Ref. No.	Part No.	Part Name & Description	Pcs	Remarks
	R4550	D0GA151JA015	M 150 OHM, J, 0.063W	1	
	R4551	D0GA151JA015	M 150 OHM, J, 0.063W	1	
	R4552	D0GA560JA015	M 56 OHM, J, 0.063W	1	
	R4553	ERJ2GEJ103	M 10KOHM, J, 0.063W	1	
	R4554	ERJ2GEJ102X	M 1K OHM J 1/4W	1	
	R4556	ERJ2GEJ103	M 10KOHM, J, 0.063W	1	
	R4560	D0GA473JA015	M 47KOHM, J, 0.063W	1	
	R4651	ERJ2GEJ220	M 22 OHM, J, 0.063W	1	
	R4655	ERJ2GEJ220	M 22 OHM, J, 0.063W	1	
	R4659	ERJ2GEJ220	M 22 OHM, J, 0.063W	1	
	R4663	ERJ2GEJ220	M 22 OHM, J, 0.063W	1	
	R4666	D0GA330JA015	M 33 OHM, J, 0.063W	1	
	R4668	D0GA330JA015	M 33 OHM, J, 0.063W	1	
	R4670	D0GA330JA015	M 33 OHM, J, 0.063W	1	
	R4672	D0GA330JA015	M 33 OHM, J, 0.063W	1	
	R4676	ERJ2GEJ102X	M 1K OHM J 1/4W	1	
	R4677	D0GA122JA015	M 1.2KOHM, J, 0.063W	1	
	R4702	ERJ2GEJ103	M 10KOHM, J, 0.063W	1	
	R4703	D0GA330JA015	M 33 OHM, J, 0.063W	1	
	R4704	D0GA473JA015	M 47KOHM, J, 0.063W	1	
	R4708	ERJ2GEJ103	M 10KOHM, J, 0.063W	1	
	R4709	ERJ2GEJ103	M 10KOHM, J, 0.063W	1	
	R4711	ERJ2GEJ102X	M 1K OHM J 1/4W	1	
	R4712	D0GA473JA015	M 47KOHM, J, 0.063W	1	
	R4715	ERJ2GEJ103	M 10KOHM, J, 0.063W	1	
	R4716	D0GA330JA015	M 33 OHM, J, 0.063W	1	
	R4717	D0GA473JA015	M 47KOHM, J, 0.063W	1	
	R4721	ERJ2GEJ103	M 10KOHM, J, 0.063W	1	
	R4722	ERJ2GEJ103	M 10KOHM, J, 0.063W	1	
	R4724	ERJ2GEJ102X	M 1K OHM J 1/4W	1	
	R4725	D0GA473JA015	M 47KOHM, J, 0.063W	1	
	R4739	ERJ2GEJ220	M 22 OHM, J, 0.063W	1	
	R4752	D0GA680JA015	M 68 OHM, J, 0.063W	1	
	R4753	D0GA680JA015	M 68 OHM, J, 0.063W	1	
	R4754	D0GA680JA015	M 68 OHM, J, 0.063W	1	
	R4755	D0GA680JA015	M 68 OHM, J, 0.063W	1	
	R4763	ERJ2GEJ104	M 100KOHM, J, 0.063W	1	
	R4764	ERJ2GEJ104	M 100KOHM, J, 0.063W	1	
	R4766	D0GA473JA015	M 47KOHM, J, 0.063W	1	
	R4767	D0GA473JA015	M 47KOHM, J, 0.063W	1	
	R5005	D0GA473JA015	M 47KOHM, J, 0.063W	1	
	R5006	ERJ2GEJ103	M 10KOHM, J, 0.063W	1	

Safety	Ref. No.	Part No.	Part Name & Description	Pcs	Remarks
	R5007	D0GA473JA015	M 47KOHM, J, 0.063W	1	
	R5008	D0GA822JA015	M 8.2KOHM, J, 0.063W	1	
	R5050	D0GA473JA015	M 47KOHM, J, 0.063W	1	
	R5051	D0GA473JA015	M 47KOHM, J, 0.063W	1	
	R5052	D0GA105JA015	M 1M OHM, J, 0.063W	1	
	R5061	ERJ6GEYJ150V	M 15 OHM, J, 1/10W	1	
	R5065	ERJ2GEJ103	M 10KOHM, J, 0.063W	1	
	R5100	D0GA273JA015	M 27K OHM J, 0.063W	1	
	R5101	ERJ2GEJ104	M 100KOHM, J, 0.063W	1	
	R5102	ERJ2GEJ104	M 100KOHM, J, 0.063W	1	
	R5103	D0GA683JA015	M 68KOHM, J, 0.063W	1	
	R5104	D0GA473JA015	M 47KOHM, J, 0.063W	1	
	R5106	D0GA683JA015	M 68KOHM, J, 0.063W	1	
	R5110	D0GA101JA015	M 100 OHM, J, 0.063W	1	
	R5151	D0GA101JA015	M 100 OHM, J, 0.063W	1	
	R5152	D0GA222JA015	M 2.2KOHM, J, 0.063W	1	
	R5153	D0GA101JA015	M 100 OHM, J, 0.063W	1	
	R5154	D0GA470JA015	M 47 OHM, J, 0.063W	1	
	R5155	D0GA101JA015	M 100 OHM, J, 0.063W	1	
	R5471	D0GA222JA015	M 2.2KOHM, J, 0.063W	1	
	R5472	D0GA332JA015	M 3.3KOHM, J, 0.063W	1	
	R5473	ERJ2GEJ102X	M 1K OHM J 1/4W	1	
	R5474	ERJ2GEJ103	M 10KOHM, J, 0.063W	1	
	R5475	ERJ6GEYJ221V	M 220 OHM, J, 1/10W	1	
	R5479	ERJ6GEYJ471	M 470 OHM, J, 1/10W	1	
	R5481	ERJ2GEJ221	M 220 OHM, J, 0.063W	1	
	R5485	ERJ6GEYJ104V	M 100KOHM, J, 1/10W	1	
	R5486	ERJ6GEYJ102V	M 1K OHM J 1/10W	1	
	R5487	ERJ6GEYJ472V	M 4.7K OHM J 1/10W	1	
	R5488	ERJ6GEYJ472V	M 4.7K OHM J 1/10W	1	
	R5489	ERJ6GEYJ472V	M 4.7K OHM J 1/10W	1	
	R5490	ERJ6GEYJ472V	M 4.7K OHM J 1/10W	1	
	R5491	ERJ6GEYJ472V	M 4.7K OHM J 1/10W	1	
	R5492	ERJ6GEYJ472V	M 4.7K OHM J 1/10W	1	
	R5493	ERJ6GEYJ472V	M 4.7K OHM J 1/10W	1	
	R5494	ERJ6GEYJ472V	M 4.7K OHM J 1/10W	1	
	R5600	D0GA680JA015	M 68 OHM, J, 0.063W	1	
	R5601	D1BB8200A087	M 820 OHM, 1/10W	1	
	R5602	D1BB2701A087	M 2.7KOHM, 1/10W	1	
	R5603	D1BB1241A087	M 1.24KOHM, 1/10W	1	
	R5604	D1BB2001A087	M 2KOHM, 1/10W	1	
	R5605	D1BB2002A055	M 20KOHM, 1/10W	1	
	R5606	D1BB2402A055	M 24KOHM, 1/10W	1	
	R5607	D0GA223JA015	M 22K OHM J 0.063W	1	

Safety	Ref. No.	Part No.	Part Name & Description	Pcs	Remarks
	R5608	D0GA683JA015	M 68KOHM, J, 0.063W	1	
	R5609	ERJ2GEJ103	M 10KOHM, J, 0.063W	1	
	R5610	D0GA473JA015	M 47KOHM, J, 0.063W	1	
	R5611	D0GA222JA015	M 2.2KOHM, J, 0.063W	1	
	R5612	ERJ2GEJ103	M 10KOHM, J, 0.063W	1	
	R5613	D0GA473JA015	M 47KOHM, J, 0.063W	1	
	R5616	D0GB100JA041	M 10 OHM J 1/10W	1	
	R5617	D0GB100JA041	M 10 OHM J 1/10W	1	
	R5618	D1BB3301A055	M 3.3KOHM, 1/10W	1	
	R5619	D1BB5601A055	M 5.6KOHM, 1/10W	1	
	R5620	D1BB1001A055	M 1KOHM, 1/10W	1	
	R5621	D1BB1001A055	M 1KOHM, 1/10W	1	
	R5622	D1BB2402A055	M 24KOHM, 1/10W	1	
	R5623	D1BB2202A055	M 22KOHM, 1/10W	1	
	R5626	D0GB100JA041	M 10 OHM J 1/10W	1	
	R5627	D0GB100JA041	M 10 OHM J 1/10W	1	
	R5640	ERJ2GEJ103	M 10KOHM, J, 0.063W	1	
	R5641	ERJ2GEJ103	M 10KOHM, J, 0.063W	1	
	R5642	ERJ2GEJ104	M 100KOHM, J, 0.063W	1	
	R5643	ERJ2GEJ103	M 10KOHM, J, 0.063W	1	
	R5644	D0GA752JA015	M 7.5KOHM, J, 0.063W	1	
	R8002	D1BB2402A055	M 24KOHM, 1/10W	1	
	R8003	D1BB1002A055	M 10KOHM, 1/10W	1	
	R8004	D1BB2402A055	M 24KOHM, 1/10W	1	
	R8005	D1BA1001A014	M 1KOHM, 0.063W	1	
	R8006	D1BA1001A014	M 1KOHM, 0.063W	1	
	R8007	D0GA111JA015	M 110 OHM, J, 0.063W	1	
	R8008	ERJ2GEJ103	M 10KOHM, J, 0.063W	1	
	R8009	D1BA56R0A014	M 56 OHM, 0.063W	1	
	R8010	D1BA3000A014	M 30 OHM, 0.063W	1	
	R8011	D0GB331JA041	M 330 OHM J 1/10W	1	
	R8014	ERJ2GEJ103	M 10KOHM, J, 0.063W	1	
	R8015	ERJ2GEJ102X	M 1K OHM J 1/4W	1	
	R8017	D0GA471JA015	M 470OHM, J, 0.063W	1	
	R8031	D0GA222JA015	M 2.2KOHM, J, 0.063W	1	
	R8032	ERJ2GEJ103	M 10KOHM, J, 0.063W	1	
	R8211	ERJ2GEJ103	M 10KOHM, J, 0.063W	1	
	R8212	ERJ2GEJ103	M 10KOHM, J, 0.063W	1	
	R8300	EXB2HV680J	RESISTOR ARRAY	1	
	R8301	ERJ2GEJ103	M 10KOHM, J, 0.063W	1	
	R8302	D0GA471JA015	M 470OHM, J, 0.063W	1	
	R8303	D0GA680JA015	M 68 OHM, J, 0.063W	1	
	R8305	D0GA680JA015	M 68 OHM, J, 0.063W	1	
	R8306	D0GA680JA015	M 68 OHM, J, 0.063W	1	
	R8310	D0GA680JA015	M 68 OHM, J, 0.063W	1	
	R8315	D0GAR00Z0001	C 0 OHM, 0.063W	1	
	R8316	D0GAR00Z0001	C 0 OHM, 0.063W	1	
	R8322	ERJ2GEJ220	M 22 OHM, J, 0.063W	1	
	R8323	ERJ2GEJ220	M 22 OHM, J, 0.063W	1	
	R8324	D0GA561JA015	M 560OHM, J, 0.063W	1	PAVCCZ

Safety	Ref. No.	Part No.	Part Name & Description	Pcs	Remarks
	R8325	D0GA561JA015	M 560OHM, J, 0.063W	1	PAVCCZ
	R8326	D0GA472JA015	M 4.7KOHM, J, 0.063W	1	
	R8327	D0GA472JA015	M 4.7KOHM, J, 0.063W	1	
	R8393	ERJ2GEJ103	M 10KOHM, J, 0.063W	1	
	R8394	ERJ2GEJ103	M 10KOHM, J, 0.063W	1	
	R8395	ERJ2GEJ103	M 10KOHM, J, 0.063W	1	
	R8396	ERJ2GEJ103	M 10KOHM, J, 0.063W	1	
	R8397	EXB2HV103JV	RESISTOR ARRAY	1	
	R8400	ERJ2GEJ103	M 10KOHM, J, 0.063W	1	
	R8404	EXB2HV680J	RESISTOR ARRAY	1	
	R8406	EXB28V680JX	RESISTOR ARRAY	1	
	R8409	EXB28V680JX	RESISTOR ARRAY	1	
	R8411	D0GA680JA015	M 68 OHM, J, 0.063W	1	
	R8413	D0GA680JA015	M 68 OHM, J, 0.063W	1	
	R8414	EXB28V151J	RESISTOR ARRAY	1	
	R8415	EXB28V104JX	RESISTOR ARRAY	1	
	R8416	EXB28V151J	RESISTOR ARRAY	1	
	R8417	EXB28V104JX	RESISTOR ARRAY	1	
	R8419	EXB2HV101J	RESISTOR ARRAY	1	
	R8420	EXB2HV101J	RESISTOR ARRAY	1	
	R8422	EXB2HV680J	RESISTOR ARRAY	1	
	R8423	EXB2HV680J	RESISTOR ARRAY	1	
	R8424	EXB28V680JX	RESISTOR ARRAY	1	
	R8425	D0GA680JA015	M 68 OHM, J, 0.063W	1	
	R8426	D0GA680JA015	M 68 OHM, J, 0.063W	1	
	R8428	D0GA222JA015	M 2.2KOHM, J, 0.063W	1	
	R8429	EXB28V473JX	RESISTOR ARRAY	1	
	R8431	ERJ2GEJ103	M 10KOHM, J, 0.063W	1	
	R8432	ERJ2GEJ103	M 10KOHM, J, 0.063W	1	
	R8433	ERJ8RSJR10	M 1 OHM, 1/8W	1	
	R8434	D0GA473JA015	M 47KOHM, J, 0.063W	1	
	R8436	D0GA223JA015	M 22K OHM J 0.063W	1	
	R8437	D0GA223JA015	M 22K OHM J 0.063W	1	
	R8438	ERJ2GEJ103	M 10KOHM, J, 0.063W	1	
	R8439	D0GA223JA015	M 22K OHM J 0.063W	1	
	R8440	ERJ2GEJ104	M 100KOHM, J, 0.063W	1	
	R8441	D0GA681JA015	M680 OHM, J, 0.063W	1	
	R8445	D0GA680JA015	M 68 OHM, J, 0.063W	1	
	R8447	D0GA151JA015	M 150 OHM, J, 0.063W	1	
	R8448	D0GA151JA015	M 150 OHM, J, 0.063W	1	
	R8449	D0GA151JA015	M 150 OHM, J, 0.063W	1	
	R8450	D0GA473JA015	M 47KOHM, J, 0.063W	1	
	R8451	ERJ2GEJ103	M 10KOHM, J, 0.063W	1	
	R8452	D0GA680JA015	M 68 OHM, J, 0.063W	1	
	R8453	D0GA680JA015	M 68 OHM, J, 0.063W	1	
	R8454	ERJ2GEJ104	M 100KOHM, J, 0.063W	1	
	R8455	ERJ2GEJ104	M 100KOHM, J, 0.063W	1	

Safety	Ref. No.	Part No.	Part Name & Description	Pcs	Remarks
	R8456	ERJ2GEJ104	M 100KOHM, J, 0.063W	1	
	R8457	ERJ2GEJ103	M 10KOHM, J, 0.063W	1	
	R8462	EXB28V680JX	RESISTOR ARRAY	1	
	R8463	D0GA680JA015	M 68 OHM, J, 0.063W	1	
	R8464	D0GA680JA015	M 68 OHM, J, 0.063W	1	
	R8465	EXB28V680JX	RESISTOR ARRAY	1	
	R8466	ERJ2GEJ103	M 10KOHM, J, 0.063W	1	
	R8467	ERJ2GEJ103	M 10KOHM, J, 0.063W	1	
	R8468	EXB2HV680J	RESISTOR ARRAY	1	
	R8469	D0GA680JA015	M 68 OHM, J, 0.063W	1	
	R8470	ERJ2GEJ103	M 10KOHM, J, 0.063W	1	
	R8471	EXB28V103JX	RESISTOR ARRAY	1	
	R8480	D0GA680JA015	M 68 OHM, J, 0.063W	1	
	R8481	D0GA223JA015	M 22K OHM J 0.063W	1	
	R8483	D0GA680JA015	M 68 OHM, J, 0.063W	1	
	R8484	D0GA680JA015	M 68 OHM, J, 0.063W	1	
	R8485	ERJ2GEJ103	M 10KOHM, J, 0.063W	1	
	R8488	D0GA680JA015	M 68 OHM, J, 0.063W	1	
	R8489	D0GA680JA015	M 68 OHM, J, 0.063W	1	
	R8490	D0GA680JA015	M 68 OHM, J, 0.063W	1	
	R8491	D0GA680JA015	M 68 OHM, J, 0.063W	1	
	R8492	D0GA680JA015	M 68 OHM, J, 0.063W	1	
	R8493	D0GA680JA015	M 68 OHM, J, 0.063W	1	
	R8494	D0GA680JA015	M 68 OHM, J, 0.063W	1	
	R8495	D0GA680JA015	M 68 OHM, J, 0.063W	1	
	R8496	D0GA680JA015	M 68 OHM, J, 0.063W	1	
	R8497	D0GA680JA015	M 68 OHM, J, 0.063W	1	
	R8498	D0GA680JA015	M 68 OHM, J, 0.063W	1	
	R8499	D0GA680JA015	M 68 OHM, J, 0.063W	1	
	R8500	EXB2HV103JV	RESISTOR ARRAY	1	
	R8501	EXB28V680JX	RESISTOR ARRAY	1	
	R8505	D0GA680JA015	M 68 OHM, J, 0.063W	1	
	R8506	D0GA680JA015	M 68 OHM, J, 0.063W	1	
	R8507	D0GA680JA015	M 68 OHM, J, 0.063W	1	
	R8508	D0GA680JA015	M 68 OHM, J, 0.063W	1	
	R8509	D0GA680JA015	M 68 OHM, J, 0.063W	1	
	R8510	D0GA680JA015	M 68 OHM, J, 0.063W	1	
	R8511	EXB28V103JX	RESISTOR ARRAY	1	
	R8515	ERJ2GEJ103	M 10KOHM, J, 0.063W	1	
	R8516	ERJ2GEJ103	M 10KOHM, J, 0.063W	1	
	R8606	D0GA222JA015	M 2.2KOHM, J, 0.063W	1	
	R8610	D0GA680JA015	M 68 OHM, J, 0.063W	1	
	R8616	D0GA222JA015	M 2.2KOHM, J, 0.063W	1	

Safety	Ref. No.	Part No.	Part Name & Description	Pcs	Remarks
	R8617	D0GA222JA015	M 2.2KOHM, J,0.063W	1	
	R8618	ERJ2GEJ103	M 10KOHM, J,0.063W	1	
	R8622	D0GA680JA015	M 68 OHM, J,0.063W	1	
	R8627	ERJ2GEJ103	M 10KOHM, J,0.063W	1	
	R8628	ERJ2GEJ103	M 10KOHM, J,0.063W	1	
	R8631	ERJ2GEJ103	M 10KOHM, J,0.063W	1	
	R8632	ERJ2GEJ103	M 10KOHM, J,0.063W	1	
	R8633	D0GA222JA015	M 2.2KOHM, J,0.063W	1	
	R8636	D0GA680JA015	M 68 OHM, J,0.063W	1	
	R8638	ERJ2GEJ103	M 10KOHM, J,0.063W	1	
	R8639	ERJ2GEJ103	M 10KOHM, J,0.063W	1	
	R8645	D0GA680JA015	M 68 OHM, J,0.063W	1	
	R8646	ERJ2GEJ103	M 10KOHM, J,0.063W	1	
	R8649	ERJ2GEJ103	M 10KOHM, J,0.063W	1	
	R8652	ERJ2GEJ103	M 10KOHM, J,0.063W	1	
	R8660	EXB2HV680J	RESISTOR ARRAY	1	
	R8661	D0GA222JA015	M 2.2KOHM, J,0.063W	1	
	R8664	ERJ2GEJ103	M 10KOHM, J,0.063W	1	
	R8669	ERJ2GEJ103	M 10KOHM, J,0.063W	1	
	R8671	D0GA222JA015	M 2.2KOHM, J,0.063W	1	
	R8733	D1BB1600A055	M 160 OHM, 1/10W	1	
	R8824	D1BA6201A014	M 6.2KOHM, 0.063W	1	
	R8856	D0GA473JA015	M 47KOHM, J,0.063W	1	
	R8857	D0GA680JA015	M 68 OHM, J,0.063W	1	
	R8859	D0GA680JA015	M 68 OHM, J,0.063W	1	
	R8860	D0GA680JA015	M 68 OHM, J,0.063W	1	
	R8861	D0GA680JA015	M 68 OHM, J,0.063W	1	
	R8862	D0GA680JA015	M 68 OHM, J,0.063W	1	
	R8863	D0GA680JA015	M 68 OHM, J,0.063W	1	
	R8867	ERJ2GEJ103	M 10KOHM, J,0.063W	1	
	R8868	D0GA330JA015	M 33 OHM, J,0.063W	1	
	R8869	ERJ2GEJ103	M 10KOHM, J,0.063W	1	
	R8870	ERJ2GEJ103	M 10KOHM, J,0.063W	1	
	R8872	D0GA330JA015	M 33 OHM, J,0.063W	1	
	R8873	D0GA330JA015	M 33 OHM, J,0.063W	1	
	R8874	D0GA330JA015	M 33 OHM, J,0.063W	1	
	R8875	D0GA330JA015	M 33 OHM, J,0.063W	1	
	R8876	D0GA330JA015	M 33 OHM, J,0.063W	1	
	R8877	D0GA330JA015	M 33 OHM, J,0.063W	1	
	R8878	ERJ2GEJ103	M 10KOHM, J,0.063W	1	
	R8879	EXB28V103JX	RESISTOR ARRAY	1	
	R8890	ERJ2GEJ103	M 10KOHM, J,0.063W	1	

Safety	Ref. No.	Part No.	Part Name & Description	Pcs	Remarks
	R8900	D0GA680JA015	M 68 OHM, J,0.063W	1	
	R8918	EXB2HV680J	RESISTOR ARRAY	1	
	R8919	EXB2HV680J	RESISTOR ARRAY	1	
	R8920	D0GA222JA015	M 2.2KOHM, J,0.063W	1	
	R8922	EXB2HVR000	RESISTOR ARRAY	1	
	R8923	D0GA680JA015	M 68 OHM, J,0.063W	1	
	R8924	D0GA680JA015	M 68 OHM, J,0.063W	1	
	R8925	D0GA680JA015	M 68 OHM, J,0.063W	1	
	R8926	D0GA680JA015	M 68 OHM, J,0.063W	1	
	R8927	D0GA680JA015	M 68 OHM, J,0.063W	1	
	R8928	D0GA680JA015	M 68 OHM, J,0.063W	1	
	R8950	D0GA472JA015	M 4.7KOHM, J,0.063W	1	
	R9014	D1BB5601A055	M 5.6KOHM, 1/10W	1	
	R9016	D0GA2R2JA014	M 2.2OHM, J,0.063W	1	
	R9030	ERJ6GEYJ472V	M 4.7K OHM J 1/10W	1	
	R9031	ERJ6GEYJ331V	M 330 OHM J 1/10W	1	
	R9035	D0GA332JA015	M 3.3KOHM, J,0.063W	1	
	R9039	D0GA473JA015	M 47KOHM, J,0.063W	1	
	R9040	D0GA472JA015	M 4.7KOHM, J,0.063W	1	
	R9054	D0GAR00Z0001	C 0 OHM, 0.063W	1	
	R9058	D0GAR00Z0001	C 0 OHM, 0.063W	1	
	R9103	D0GA101JA015	M 100 OHM, J,0.063W	1	
	R9104	D0GA101JA015	M 100 OHM, J,0.063W	1	
	R9105	D0GA473JA015	M 47KOHM, J,0.063W	1	
	R9107	D0GA332JA015	M 3.3KOHM, J,0.063W	1	
	R9120	D0GA101JA015	M 100 OHM, J,0.063W	1	
	R9145	D0GA101JA015	M 100 OHM, J,0.063W	1	
	R9190	D0GA101JA015	M 100 OHM, J,0.063W	1	
	R9191	D0GA101JA015	M 100 OHM, J,0.063W	1	
	R9198	EXB28V101JX	RESISTOR ARRAY	1	
	R9203	D0GA272JA015	M 2.7KOHM, J,0.063W	1	
	R9205	D0GA333JA015	M 33KOHM, J,0.063W	1	
	R9206	D0GA563JA015	M 56KOHM, J,0.063W	1	
	R9208	EXB2HV470JV	RESISTOR ARRAY	1	
	R9209	EXB2HV470JV	RESISTOR ARRAY	1	
	R9318	ERJ2GEJ102X	M 1K OHM J 1/4W	1	
	R9320	D0GA152JA015	M 1.5KOHM, J,0.063W	1	
	R9321	D0GA105JA015	M 1M OHM, J,0.063W	1	
	R9323	ERJ2GEJ102X	M 1K OHM J 1/4W	1	
	R9324	D0GB162JA041	N 1.6KOHM J 1/10W	1	
	R9325	D0GB162JA041	N 1.6KOHM J 1/10W	1	
	R9326	D0GB162JA041	N 1.6KOHM J 1/10W	1	
	R9327	D0GB162JA041	N 1.6KOHM J 1/10W	1	
	R9400	EXB2HV103JV	RESISTOR ARRAY	1	
	R9401	EXB2HV103JV	RESISTOR ARRAY	1	
	R9608	EXB2HV470JV	RESISTOR ARRAY	1	
	R9609	EXB2HV470JV	RESISTOR ARRAY	1	

Safety	Ref. No.	Part No.	Part Name & Description	Pcs	Remarks
	R9610	EXB2HV470JV	RESISTOR ARRAY	1	
	R9872	D1BB3301A055	M 3.3KOHM, 1/10W	1	
	R9873	D1BB1002A055	M 10KOHM, 1/10W	1	
	R9874	D1BB2702A055	M 27KOHM, 1/10W	1	
	R9875	D1BB2002A055	M 20KOHM, 1/10W	1	
	R9877	D1BB4702A055	M 47KOHM, 1/10W	1	
	R9878	D1BB1002A055	M 10KOHM, 1/10W	1	
	R9879	D1BB1502A055	M 15KOHM, 1/10W	1	
	R9890	D1BB11030002	M 110KOHM, 1/10W	1	
	R9891	D1BB3242A055	M32.4KOHM, 1/10W	1	
	R9903	DOGA472JA015	M 4.7KOHM, J,0.063W	1	
	R9904	ERJ2GEJ104	M 100KOHM, J,0.063W	1	
	R9905	ERJ2GEJ103	M 10KOHM, J,0.063W	1	
	R9907	DOGA101JA015	M 100 OHM, J,0.063W	1	
	R9920	DOGA390JA015	M 39 OHM, J,0.063W	1	
	RM2510	B3RAD0000168	REMOTE SENSOR	1	
	S1B	K1KA03BA0237	3P CONNECTOR	1	
△	SW2500	K0F162B00002	SWITCH	1	
	SW5150	K0H1BA000445	SWITCH	1	
	SW5151	K0H1BA000445	SWITCH	1	
	SW5152	K0H1BA000445	SWITCH	1	
	SW5153	K0H1BA000445	SWITCH	1	
	SW5154	K0H1BA000445	SWITCH	1	
△	TU2901A	ENG37F03KF	TUNER	1	PAVCCZ
	X8000	H0J245500101	CRYSTAL	1	
	X8001	H0J120500062	CRYSTAL	1	
	X8300	H0J410500001	CRYSTAL	1	PAVCCZ
	X9300	H0J200500076	CRYSTAL	1	
	C10	K1MN20BA0231	20P CONNECTOR	1	
	C11	K1MY40BA0345	40P CONNECTOR	1	PAVCCZ
	C20	K1MY20BA0345	20P CONNECTOR	1	
	C21	K1MY55BA0345	55P CONNECTOR	1	
	C23	K1KY06AA0719	6P CONNECTOR	1	
	C25	K1KA04BA0107	4P CONNECTOR	1	
	C14901	FIG1H102A730	C 1000UF, 50V	1	
	C14902	FIH1C105A145	C 0.01UF, K, 16V	1	
	C14906	FIH1C105A145	C 0.01UF, K, 16V	1	
	C14908	FIH1C105A145	C 0.01UF, K, 16V	1	
	C14909	FIL2J1020001	C 1000UF, K,6.3V	1	
	C14912	FIH1C105A145	C 0.01UF, K, 16V	1	
	C14923	FIL2E224A028	E 2200UF, 25V	1	
	C14926	FIH1H104A970	C 0.1UF, K, 50V	1	
	C14928	FIL2E224A028	E 2200UF, 25V	1	
	C14931	FIG1H102A730	C 1000UF, 50V	1	
	C14934	FIL2E224A028	E 2200UF, 25V	1	
	C14935	FIL2E224A028	E 2200UF, 25V	1	
	C14936	FIG1H221A731	C 220UF, 50V	1	
	C14937	FIG1H221A731	C 220UF, 50V	1	
	C14938	FIG1H221A731	C 220UF, 50V	1	
	C14939	FIG1H221A731	C 220UF, 50V	1	
	C14940	FIG1H102A730	C 1000UF, 50V	1	
	C14941	FIG1H221A731	C 220UF, 50V	1	
	C14942	FIG1H221A731	C 220UF, 50V	1	
	C14943	FK1E475A134	C 4.7UF, Z, 25V	1	
	C14950	FIG1H221A731	C 220UF, 50V	1	
	C14952	FIH1C105A145	C 0.01UF, K, 16V	1	
	C14957	FIH1C105A145	C 0.01UF, K, 16V	1	
	C14958	FIH1C105A145	C 0.01UF, K, 16V	1	
	C14959	FIL2J1020001	C 1000UF, K,6.3V	1	
	C14963	FIH1C105A145	C 0.01UF, K, 16V	1	
	C14970	FIG1H221A731	C 220UF, 50V	1	
	C14971	FIG1H221A731	C 220UF, 50V	1	
	C14972	FIG1H221A731	C 220UF, 50V	1	

Safety	Ref. No.	Part No.	Part Name & Description	Pcs	Remarks
	C14973	FIG1H102A730	C 1000UF, 50V	1	
	C14975	FIL2E224A028	E 2200UF, 25V	1	
	C14976	FIG1H102A730	C 1000UF, 50V	1	
	C14979	FIL2E224A028	E 2200UF, 25V	1	
	C14981	FIG1H221A731	C 220UF, 50V	1	
	C14982	FIL2E224A028	E 2200UF, 25V	1	
	C14984	FIL2E224A028	E 2200UF, 25V	1	
	C14987	FIH1H104A970	C 0.1UF, K, 50V	1	
	C14988	FIH1H104A970	C 0.1UF, K, 50V	1	
	C14989	FIG1H221A731	C 220UF, 50V	1	
	C14991	FIG1H100A731	C 10PF, K, 50V	1	
	C14992	FIH1C105A145	C 0.01UF, K, 16V	1	
	C14993	FIH1C105A145	C 0.01UF, K, 16V	1	
	C16001	FIL2J1020001	C 1000UF, K,6.3V	1	
	C16002	FIL2J562A022	C 5600UF, K,6.3V	1	
	C16003	FIE2J821A002	C 82PF, 600V	1	
	C16011	F2A2T301A016	E 300UF, 220V	1	PAVCCZ
	C16018	FOC2E155A252	E 0.015UF, 250V	1	
	C16022	FIL2J1020001	C 1000UF, K,6.3V	1	
	C16023	FIE2J821A002	C 82PF, 600V	1	
	C16101	FIL2J1020001	C 1000UF, K,6.3V	1	
	C16102	FIL2J562A022	C 5600UF, K,6.3V	1	
	C16103	FIH1E470A130	C 47UF, K, 25V	1	
	C16104	FIH1E470A130	C 47UF, K, 25V	1	
	C16105	FIE2J221A002	C 22PF, 600V	1	PAVCCZ
	C16106	FIE2J221A002	C 22PF, 600V	1	PAVCCZ
	C16131	FK1E475A134	C 4.7UF, Z, 25V	1	
	C16133	FK1E475A134	C 4.7UF, Z, 25V	1	
	C16135	FK1E105A029	C 1UF, Z, 25V	1	
	C16191	FK1E475A134	C 4.7UF, Z, 25V	1	
	C16192	FIH1E104A129	C 0.1UF, 25V	1	
	C16193	EEUFC1E470	E 47UF, 25V	1	
	C16195	FK1E105A029	C 1UF, Z, 25V	1	
	C16242	FIH1C105A145	C 0.01UF, K, 16V	1	
	C16243	FIH1H103A970	C 0.001UF, K, 50V	1	
	C16244	FIJ1A106A087	C 0.010UF, K, 10V	1	
	C16272	F2A1E471A102	E 470UF, 25V	1	
	C16286	FIH1H104A970	C 0.1UF, K, 50V	1	
	C16287	FIH1H104A970	C 0.1UF, K, 50V	1	
	C16310	F2A2T301A016	E 300UF, 220V	1	PAVCCZ
	C16315	ECJ1VB1A105K	C 0.01UF, Z, 50V	1	
	C16316	FIH1C104A143	C 0.1UF, K, 16V	1	
	C16317	ECJ1VB1A105K	C 0.01UF, Z, 50V	1	
	C16318	FIJ1H104A835	C 0.10UF, 50V	1	
	C16319	FIJ1H104A835	C 0.10UF, 50V	1	
	C16328	F2A2D201A226	E 220UF, 200V	1	
	C16401	FIL2J562A022	C 5600UF, K,6.3V	1	
	C16412	FOC2E155A252	E 0.015UF, 250V	1	
	C16413	F2A2T301A016	E 300UF, 220V	1	PAVCCZ
	C16421	FIL2J562A022	C 5600UF, K,6.3V	1	
	C16460	FIE2J821A002	C 82PF, 600V	1	
	C16461	FIE2J221A002	C 22PF, 600V	1	PAVCCZ
	C16462	FIE2J221A002	C 22PF, 600V	1	PAVCCZ
	C16463	FIE2J472A001	C 4700PF, 600V	1	
	C16471	FIL2J1020001	C 1000UF, K,6.3V	1	
	C16490	FIH1C105A145	C 0.01UF, K, 16V	1	
	C16491	FIL2J1020001	C 1000UF, K,6.3V	1	
	C16501	FK1E105A029	C 1UF, Z, 25V	1	
	C16502	FK1E475A134	C 4.7UF, Z, 25V	1	
	C16503	F2A1E471A102	E 470UF, 25V	1	
	C16504	FK1E475A134	C 4.7UF, Z, 25V	1	
	C16505	FK1E105A029	C 1UF, Z, 25V	1	
	C16521	FK1E105A029	C 1UF, Z, 25V	1	
	C16522	FK1E475A134	C 4.7UF, Z, 25V	1	
	C16523	F2A1E471A102	E 470UF, 25V	1	
	C16524	FK1E475A134	C 4.7UF, Z, 25V	1	
	C16525	FK1E475A134	C 4.7UF, Z, 25V	1	
	C16527	FK1E475A134	C 4.7UF, Z, 25V	1	
	C16533	FK1E475A134	C 4.7UF, Z, 25V	1	
	C16561	FIJ1A106A087	C 0.010UF, K, 10V	1	

Safety	Ref. No.	Part No.	Part Name & Description	Pcs	Remarks
	C16562	F1H1C105A145	C 0.01UF, K, 16V	1	
	C16564	F1H1C105A145	C 0.01UF, K, 16V	1	
	C16565	F1H1H103A970	C 0.001UF, K, 50V	1	
	C16566	F1H1H103A970	C 0.001UF, K, 50V	1	
	C16581	F1K1E105A029	C 1UF, Z, 25V	1	
	C16582	F1K1E475A134	C 4.7UF, Z, 25V	1	
	C16593	F1H1H102A971	C 1000PF, K, 50V	1	
	C16602	F1H1H220A971	C 22PF, K, 50V	1	
	C16603	F1K2J102A014	C 1000UF, K, 6.3V	1	
	C16604	F1K2J102A014	C 1000UF, K, 6.3V	1	
	C16608	F1H1H221A971	C 220UF, K, 50V	1	
	C16641	F1E2J332A002	C 3300PF, 600V	1	
	C16642	F1E2J332A002	C 3300PF, 600V	1	
	C16661	F1K2J102A038	C 1000UF, K, 6.3V	1	
	C16662	F1K2J102A038	C 1000UF, K, 6.3V	1	
	C16664	F1H1H680A971	C 68PF, K, 50V	1	
	C16665	F1H1H680A971	C 68PF, K, 50V	1	
	C16666	F1H1H680A971	C 68PF, K, 50V	1	
	C16675	F1H1H391A971	C 391UF, 50V	1	
	C16684	F1H1H104A970	C 0.1UF, K, 50V	1	
	C16685	F1H1H104A970	C 0.1UF, K, 50V	1	
	C16691	F2A2C101A097	E 1000UF, 160V	1	
	C16707	F1H1H220A971	C 22PF, K, 50V	1	
	C16708	F1H1H104A970	C 0.1UF, K, 50V	1	
	C16712	F1G1H201A731	C 200 UF, K, 50V	1	
	C16721	F2A1H101A128	E 100UF, 50V	1	
	C16723	F1K1E105A029	C 1UF, Z, 25V	1	
	C16724	F1K1E475A134	C 4.7UF, Z, 25V	1	
	C16727	F1L2J1520001	C 1500UF, K, 6.3V	1	
	C16753	F1K1E475A134	C 4.7UF, Z, 25V	1	
	C16755	F1K1E475A134	C 4.7UF, Z, 25V	1	
	C16756	F1K1E475A134	C 4.7UF, Z, 25V	1	
	C16771	F1H1C105A145	C 0.01UF, K, 16V	1	
	C16773	F1K1E105A029	C 1UF, Z, 25V	1	
	C16791	EEUFCE221	E 220UF, 25V	1	
	C16793	EEUFCE221	E 220UF, 25V	1	
	C16794	F1J1A106A087	C 0.010UF, K, 10V	1	
	C16795	F2A1E471A102	E 470UF, 25V	1	
	C16796	F2A1E471A102	E 470UF, 25V	1	
	C16813	F2A2T221A015	E 220UF, 220V	1	PAVCCZ
	C16842	F2A2C101A097	E 1000UF, 160V	1	
	C16843	F1J1H104A835	C 0.10UF, 50V	1	
	C16844	F1J1H104A835	C 0.10UF, 50V	1	
	C16854	F1J1H104A835	C 0.10UF, 50V	1	
	C16856	ECJ1VB1A105K	C 0.01UF, Z, 50V	1	
	C16857	F1H1C104A143	C 0.1UF, K, 16V	1	
	C16858	ECJ1VB1A105K	C 0.01UF, Z, 50V	1	
	C16859	F1J1H104A835	C 0.10UF, 50V	1	
	C16860	ECJ1VB1A105K	C 0.01UF, Z, 50V	1	
	C16861	F1H1C104A143	C 0.1UF, K, 16V	1	
	C16862	ECJ1VB1A105K	C 0.01UF, Z, 50V	1	
	C16863	F1J1H104A835	C 0.10UF, 50V	1	
	C16864	F1J1H104A835	C 0.10UF, 50V	1	
	C16891	F1K1E105A029	C 1UF, Z, 25V	1	
	C16892	F1L2J222A022	C 2200UF, K, 6.3V	1	
	C17104	ECJ1VB1A105K	C 0.01UF, Z, 50V	1	
	C17105	ECJ1VB1A105K	C 0.01UF, Z, 50V	1	
	C17107	ECJ1VB1A105K	C 0.01UF, Z, 50V	1	
	C17108	ECJ1VB1A105K	C 0.01UF, Z, 50V	1	
	C17109	F1L2A334A031	E 3300UF, 100V	1	
	C17110	F1L2A334A031	E 3300UF, 100V	1	
	C17111	F1L2A334A031	E 3300UF, 100V	1	
	C17112	F1L2A334A031	E 3300UF, 100V	1	
	C17113	F1H1C104A143	C 0.1UF, K, 16V	1	
	C17208	ECJ1VB1A105K	C 0.01UF, Z, 50V	1	
	C17209	ECJ1VB1A105K	C 0.01UF, Z, 50V	1	
	C17210	F1H1C104A143	C 0.1UF, K, 16V	1	
	C17211	F1L2A334A031	E 3300UF, 100V	1	
	C17212	F1L2A334A031	E 3300UF, 100V	1	
	C17214	F1H1C104A143	C 0.1UF, K, 16V	1	
	C17215	F1L2A334A031	E 3300UF, 100V	1	

Safety	Ref. No.	Part No.	Part Name & Description	Pcs	Remarks
	C17216	ECJ1VB1A105K	C 0.01UF, Z, 50V	1	
	C17217	ECJ1VB1A105K	C 0.01UF, Z, 50V	1	
	C17218	F1L2A334A031	E 3300UF, 100V	1	
	CB1	K1MY55B00001	55P CONNECTOR	1	
	CB2	K1MY55B00001	55P CONNECTOR	1	
	CB3	K1MY55B00001	55P CONNECTOR	1	
	CB4	K1MY55B00001	55P CONNECTOR	1	
	CB5	K1MY55B00001	55P CONNECTOR	1	
	CB6	K1MY55B00001	55P CONNECTOR	1	
	CB7	K1MY55B00001	55P CONNECTOR	1	
	CB8	K1MY55B00001	55P CONNECTOR	1	
	D14904	BOECKM000046	DIODE	1	
	D14905	BOECKM000046	DIODE	1	
	D14907	BOECKM000046	DIODE	1	
	D14909	BOADCJ000100	DIODE	1	
	D14910	BOADCJ000100	DIODE	1	
	D14955	BOECKM000046	DIODE	1	
	D14956	BOECKM000046	DIODE	1	
	D14958	BOECKM000046	DIODE	1	
	D14962	BOACCJ000048	DIODE	1	
	D14974	BOADCJ000100	DIODE	1	
	D14976	BOACCJ000048	DIODE	1	
	D16001	BOFCCN000003	DIODE	1	PAVCCZ
	D16021	BOFCCN000003	DIODE	1	PAVCCZ
	D16101	BOJCM000093	DIODE	1	
	D16131	BOECKP000055	DIODE	1	
	D16192	BOACCJ000048	DIODE	1	
	D16195	BOECKP000055	DIODE	1	
	D16196	DZ2J200M0L	ZENER DIODE	1	
	D16280	BOACCJ000048	DIODE	1	
	D16281	DZ2J051M0L	ZENER DIODE	1	
	D16282	DZ2J068M0L	ZENER DIODE	1	PAVCCZ
	D16285	BOADEJ000035	ZENER DIODE	1	
	D16315	DZ2J150M0L	ZENER DIODE	1	
	D16316	BOECKP000055	DIODE	1	
	D16317	BOECKP000055	DIODE	1	
	D16401	DA3DF50ACSLW	ZENER DIODE	1	
	D16407	BOJCM000093	DIODE	1	
	D16411	BOACCJ000048	DIODE	1	
	D16421	BOFACP000006	DIODE	1	
	D16441	BOECHR000001	DIODE	1	
	D16451	BOECHR000001	DIODE	1	
	D16461	BOFACQ000001	DIODE	1	
	D16473	BOACCJ000048	DIODE	1	
	D16474	BOACCJ000048	DIODE	1	
	D16477	DZ2J047L0L	ZENER DIODE	1	
	D16478	BOACCJ000048	DIODE	1	
	D16480	BOACCJ000048	DIODE	1	
	D16481	BOFACQ000002	DIODE	1	
	D16490	BOECKP000055	DIODE	1	
	D16492	DZ2J047M0L	ZENER DIODE	1	
	D16493	BOADCJ000100	DIODE	1	
	D16494	BOADCJ000100	DIODE	1	
	D16497	BOECKP000055	DIODE	1	
	D16503	BOECHR000001	DIODE	1	
	D16522	BOECHR000001	DIODE	1	
	D16534	BOECHR000001	DIODE	1	
	D16536	BOECHR000001	DIODE	1	
	D16583	B3ABB0000210	LED	1	
	D16602	DZ2J150M0L	ZENER DIODE	1	
	D16604	BOADCJ000100	DIODE	1	
	D16605	DZ2J051L0L	ZENER DIODE	1	
	D16607	BOACCJ000048	DIODE	1	
	D16610	BOACCJ000048	DIODE	1	
	D16618	BOECKP000055	DIODE	1	
	D16620	BOECKP000055	DIODE	1	
	D16641	BOFBCN000006	DIODE	1	
	D16662	DZ2J330M0L	ZENER DIODE	1	
	D16663	DZ2J330M0L	ZENER DIODE	1	
	D16664	DZ2J330M0L	ZENER DIODE	1	
	D16670	BOECHR000001	DIODE	1	

Safety	Ref. No.	Part No.	Part Name & Description	Pcs	Remarks
	D16671	B0ACCJ000048	DIODE	1	
	D16672	B0ECHR000001	DIODE	1	
	D16678	DZ2J15000L	ZENER DIODE	1	
	D16701	B0ACCJ000048	DIODE	1	
	D16702	B0ACCJ000048	DIODE	1	
	D16710	DZ2J15000L	ZENER DIODE	1	
	D16711	B0ECHR000001	DIODE	1	
	D16712	DZ2J15000L	ZENER DIODE	1	
	D16713	B0ECHR000001	DIODE	1	
	D16719	B0ECKP000055	DIODE	1	
	D16720	B0ECKP000055	DIODE	1	
	D16721	B0ECHR000001	DIODE	1	
	D16722	DA3DF30ACSRP	ZENER DIODE	1	PAVCCZ
	D16724	DA3DF30ACSLW	ZENER DIODE	1	PAVCCZ
	D16728	B0ECKP000055	DIODE	1	
	D16765	B0ECKP000055	DIODE	1	
	D16790	B0JCME000093	DIODE	1	
	D16820	B0ACCJ000048	DIODE	1	
	D16821	DZ2J330M0L	ZENER DIODE	1	
	D16822	B0ADCJ000100	DIODE	1	
	D16824	DZ2J330M0L	ZENER DIODE	1	
	D16825	DZ2J330M0L	ZENER DIODE	1	
	D16859	B0ECHR000001	DIODE	1	
	D16871	DZ2J330M0L	ZENER DIODE	1	
	D16874	DZ2J051M0L	ZENER DIODE	1	
	D16875	B0ACCJ000048	DIODE	1	
	D16893	DZ2J056H0L	ZENER DIODE	1	
	D16901	B0ADCJ000100	DIODE	1	
	D16920	B0ADCJ000100	DIODE	1	
	IC14901	C0HBC0000018	IC	1	PAVCCZ
	IC14902	C0HBC0000018	IC	1	PAVCCZ
	IC14903	C0HBC0000018	IC	1	PAVCCZ
	IC14904	C0HBC0000018	IC	1	PAVCCZ
	IC14951	C0HBC0000018	IC	1	PAVCCZ
	IC14952	C0HBC0000018	IC	1	PAVCCZ
	IC14953	C0HBC0000018	IC	1	PAVCCZ
	IC14954	C0HBC0000018	IC	1	PAVCCZ
	IC14961	C0JBAB000916	IC	1	
	IC14962	C0JBAB000916	IC	1	
	IC14963	C0JBAA000377	IC	1	
	IC16131	C0ZBZ0001707	IC	1	
	IC16241	C0JBAU000043	IC	1	
	IC16304	MIP390MSSCF	IC	1	
	IC16312	C0DBZMC00006	IC	1	
	IC16471	C0DBEYY00114	IC	1	
	IC16490	C0DBZMC00006	IC	1	
	IC16491	NJM2406F	LINEAR IC	1	
	IC16501	C0ZBZ0001708	IC	1	
	IC16521	C0ZBZ0001708	IC	1	
	IC16561	C0JBAU000043	IC	1	
	IC16562	C0JBAU000043	IC	1	
	IC16563	C0JBAB000916	IC	1	
	IC16581	C0BBBA000024	IC	1	
	IC16661	C0BBBA000024	IC	1	
	IC16692	C0DBZYY00352	IC	1	
	IC16724	C0CBADE00049	IC	1	
	IC16771	C0CBADC00072	IC	1	
	IC16773	C0JBAB000715	IC	1	
	IC16784	MIP3910MSSCF	IC	1	
	IC16785	C0DBZYY00352	IC	1	
	IC16786	MIP3910MSSCF	IC	1	
	IC16787	C0DBZYY00352	IC	1	
	IC17101	C0JBAU000043	IC	1	
	IC17202	C0JBAU000043	IC	1	
	IC17203	C0JBAZ002692	IC	1	
	L16011	GOZZ00002183	PEAKING COIL	1	
	L16012	GOZZ00002183	PEAKING COIL	1	
	L16013	GOZZ00002183	PEAKING COIL	1	
	L16014	GOZZ00002183	PEAKING COIL	1	
	L16103	GOZZ00002183	PEAKING COIL	1	
	L16303	GOC471MA0049	PEAKING COIL	1	PAVCCZ

Safety	Ref. No.	Part No.	Part Name & Description	Pcs	Remarks
	L16401	GOC1R5K00004	PEAKING COIL	1	PAVCCZ
	L16411	GOC1R5K00004	PEAKING COIL	1	PAVCCZ
	L16472	GOZZ00002183	PEAKING COIL	1	
	L16698	GOC681MA0065	PEAKING COIL	1	
	L16851	GOZZ00002183	PEAKING COIL	1	
	PC14951	B3PBA0000457	IC	1	
	PC14952	B3PBA0000457	IC	1	
	PC16191	B3PBA0000496	IC	1	
	PC16192	B3PBA0000223	IC	1	
	PC16461	B3PBE0000054	IC	1	
	PC16480	B3PBA0000223	IC	1	
	PC16603	B3PBA0000223	IC	1	
	PC16684	B3PBA0000496	IC	1	
	PC16685	B3PBA0000496	IC	1	
	PC16722	B3PBA0000223	IC	1	
	PC16723	B3PBA0000223	IC	1	
	PC16896	B3PBA0000223	IC	1	
	PC16897	B3PBA0000223	IC	1	
	Q16001	B1JBEN000002	TRANSISTOR	1	PAVCCZ
	Q16002	B1JBEN000002	TRANSISTOR	1	PAVCCZ
	Q16021	B1JBEN000002	TRANSISTOR	1	PAVCCZ
	Q16022	B1JBEN000002	TRANSISTOR	1	PAVCCZ
	Q16101	B1CFRM000008	FET	1	
	Q16102	B1CFRM000008	FET	1	
	Q16141	B1HFFFA00001	TRANSISTOR	1	
	Q16161	B1HFFFA00001	TRANSISTOR	1	
	Q16191	B1HFFFA00001	TRANSISTOR	1	
	Q16280	B1ABCF000231	TRANSISTOR	1	
	Q16401	B1JAEQ000010	TRANSISTOR	1	PAVCCZ
	Q16402	B1JAEQ000010	TRANSISTOR	1	PAVCCZ
	Q16421	B1JAEF000014	TRANSISTOR	1	PAVCCZ
	Q16441	DG3D5010CSLW	ZENER DIODE	1	PAVCCZ
	Q16451	DG3D5010CSRP	ZENER DIODE	1	PAVCCZ
	Q16490	B1CBGD000001	FET	1	
	Q16501	B1HFFFA00001	TRANSISTOR	1	
	Q16521	B1HFFFA00001	TRANSISTOR	1	
	Q16531	B1HFFFA00001	TRANSISTOR	1	
	Q16551	B1HFFFA00001	TRANSISTOR	1	
	Q16601	B1CERR000042	FET	1	
	Q16602	DSC2001Q0L	TRANSISTOR	1	
	Q16603	DSA2001S0L	TRANSISTOR	1	
	Q16606	DSC2001Q0L	TRANSISTOR	1	
	Q16607	B1CBGD000001	FET	1	
	Q16621	B1JADN000009	TRANSISTOR	1	
	Q16661	B1JAER000009	TRANSISTOR	1	PAVCCZ
	Q16662	DSC2001Q0L	TRANSISTOR	1	
	Q16663	DSA2001S0L	TRANSISTOR	1	
	Q16670	B1ADCN000007	TRANSISTOR	1	
	Q16671	B1ABCF000231	TRANSISTOR	1	
	Q16672	B1CBGD000001	FET	1	
	Q16675	B1ADCN000007	TRANSISTOR	1	
	Q16676	B1ABCF000231	TRANSISTOR	1	
	Q16701	B1ADCN000007	TRANSISTOR	1	
	Q16702	B1ABCF000231	TRANSISTOR	1	
	Q16762	B1HFFFA00001	TRANSISTOR	1	
	Q16801	DSA2001S0L	TRANSISTOR	1	
	Q16810	B1ABCF000231	TRANSISTOR	1	
	Q16815	B1ABCN000007	TRANSISTOR	1	
	Q16816	DSC2001Q0L	TRANSISTOR	1	
	Q16817	DSC2001Q0L	TRANSISTOR	1	
	Q16818	B1CBGD000001	FET	1	
	Q16876	B1ABCF000231	TRANSISTOR	1	
	Q16885	B1CFNG000001	FET	1	
	Q16920	B1ABCN000007	TRANSISTOR	1	
	Q16921	B1ABCN000007	TRANSISTOR	1	
	Q16930	DSC2001Q0L	TRANSISTOR	1	
	Q16931	B1ABCN000007	TRANSISTOR	1	
	Q16932	DSC2001Q0L	TRANSISTOR	1	
	R14349	D0GB103JA057	M 10K OHM J 1/ 10W	1	

Safety	Ref. No.	Part No.	Part Name & Description	Pcs	Remarks
	R14901	ERJ6GEYJ101V	M 100 OHM,J,1/10W	1	
	R14903	ERJ6GEYJ221V	M 220 OHM,J,1/10W	1	
	R14904	ERJ6GEYJ221V	M 220 OHM,J,1/10W	1	
	R14906	ERJ6GEYJ221V	M 220 OHM,J,1/10W	1	
	R14911	D0GB103JA057	M 10K OHM J 1/10W	1	
	R14912	EXB38V103JV	RESISTOR ARRAY	1	
	R14923	EXB38V103JV	RESISTOR ARRAY	1	
	R14943	ERJ6GEYJ470V	M 47 OHM,J,1/10W	1	
	R14944	ERJ6GEYJ100V	M 10 OHM,J,1/10W	1	
	R14949	ERJ6GEYJ203	M 20KOHM,J,1/10W	1	
	R14950	D0GB103JA057	M 10K OHM J 1/10W	1	
	R14951	ERJ6GEYJ221V	M 220 OHM,J,1/10W	1	
	R14953	ERJ6GEYJ221V	M 220 OHM,J,1/10W	1	
	R14954	ERJ6GEYJ221V	M 220 OHM,J,1/10W	1	
	R14956	EXB38V470J	RESISTOR ARRAY	1	
	R14958	ERJ3GEYJ470	M 47 OHM,J,1/16W	1	
	R14960	EXB38V470J	RESISTOR ARRAY	1	
	R14961	ERJ6GEYJ331V	M 330 OHM J 1/10W	1	
	R14962	ERJ6GEYJ331V	M 330 OHM J 1/10W	1	
	R14963	ERJ6GEYJ331V	M 330 OHM J 1/10W	1	
	R14965	ERJ6GEYJ331V	M 330 OHM J 1/10W	1	
	R14973	EXB38V470J	RESISTOR ARRAY	1	
	R14975	EXB38V470J	RESISTOR ARRAY	1	
	R14977	EXB38V222J	RESISTOR ARRAY	1	
	R14980	ERJ6GEYJ221V	M 220 OHM,J,1/10W	1	
	R14981	EXB38V103JV	RESISTOR ARRAY	1	
	R14986	ERJ8GEYJ224V	M 220KOHM, J,1/8W	1	
	R14989	ERJ6ENF1502	M 15KOHM, 1/10W	1	
	R14995	EXB38V103JV	RESISTOR ARRAY	1	
	R16001	ERJT08J7R5V	M 7.5OHM,J,0.33W	1	
	R16002	ERJT08J7R5V	M 7.5OHM,J,0.33W	1	
	R16021	ERJT08J7R5V	M 7.5OHM,J,0.33W	1	
	R16022	ERJT08J7R5V	M 7.5OHM,J,0.33W	1	
	R16101	ERJT06J221V	M 220 OHM,F,0.25W	1	
	R16102	ERJT06J221V	M 220 OHM,F,0.25W	1	
	R16103	ERJT06J100V	M 10 OHM,F,0.25W	1	
	R16104	ERJT06J100V	M 10 OHM,F,0.25W	1	
	R16105	ERJ8GEYJ474	M 470KOHM, J,1/8W	1	
	R16109	ERJT06J100V	M 10 OHM,F,0.25W	1	
	R16116	D0GB473JA057	M 47KOHM,J,1/10W	1	
	R16131	ERJ6GEYJ101V	M 100 OHM,J,1/10W	1	
	R16132	ERJ6GEYJ101V	M 100 OHM,J,1/10W	1	
	R16134	ERJT06J750V	M 75 OHM,F,0.25W	1	
	R16137	ERJT08J1R0V	M 1.8OHM,J,0.33W	1	
	R16141	ERJT06J100V	M 10 OHM,F,0.25W	1	
	R16143	D0GB473JA057	M 47KOHM,J,1/10W	1	
	R16161	ERJT06J100V	M 10 OHM,F,0.25W	1	
	R16163	D0GB473JA057	M 47KOHM,J,1/10W	1	
	R16191	ERJ6GEYJ151V	M 150 OHM,J,1/10W	1	
	R16192	D0GB103JA057	M 10K OHM J 1/10W	1	
	R16193	ERJ6GEYJ750	M 75 OHM,J,1/10W	1	

Safety	Ref. No.	Part No.	Part Name & Description	Pcs	Remarks
	R16195	ERJT08J1R0V	M 1.8OHM,J,0.33W	1	
	R16241	EXB38V470J	RESISTOR ARRAY	1	
	R16242	EXB38V472JV	RESISTOR ARRAY	1	
	R16280	D0GB222JA041	M 2.2KOHM,J,1/10W	1	
	R16281	D0GB103JA057	M 10K OHM J 1/10W	1	
	R16282	ERJ6GEYJ221V	M 220 OHM,J,1/10W	1	
	R16283	D0GB473JA057	M 47KOHM,J,1/10W	1	
	R16284	D0GB224JA041	M 2.2KOHM,J,1/10W	1	
	R16285	EXB38V623J	RESISTOR ARRAY	1	
	R16289	ERJT08J334V	M 330KOHM,F,0.33W	1	
	R16290	ERJT08J334V	M 330KOHM,F,0.33W	1	
	R16307	ERJ6RBD623	M 62KOHM,J,1/10W	1	
	R16309	ERG1FJS333D	M 33KOHM, J, 1W	1	
	R16318	ERJ6RBD563	M 56KOHM, J,1/10W	1	
	R16319	ERJ6RBD242	M 2.4KOHM,J,1/10W	1	
	R16320	ERJ14YJ683	M 68KOHM, 1/2W	1	
	R16330	D0GB102JA041	M 1KOHM,J,1/10W	1	
	R16332	D0GB474JA041	M 470KOHM,J,1/10W	1	
	R16334	ERJ3GEYJ472	M 4.7KOHM,J,1/16W	1	
	R16335	D0GB102JA041	M 1KOHM,J,1/10W	1	
	R16401	ERJT08J7R5V	M 7.5OHM,J,0.33W	1	
	R16402	ERJT08J7R5V	M 7.5OHM,J,0.33W	1	
	R16410	D0GB391JA041	M 390 OHM,J,1/10W	1	
	R16411	ERJ6ENF2700	M 270 OHM, 1/10W	1	
	R16416	D0GB103JA057	M 10K OHM J 1/10W	1	
	R16417	ERJ6GEYJ101V	M 100 OHM,J,1/10W	1	
	R16418	ERJ6GEYJ101V	M 100 OHM,J,1/10W	1	
	R16421	ERJT08J7R5V	M 7.5OHM,J,0.33W	1	
	R16441	ERJT08J5R6V	M 5.6 OHM,F,0.33W	1	
	R16451	ERJT08J5R6V	M 5.6 OHM,F,0.33W	1	
	R16471	D0GB392JA041	M 3.9KOHM,J,1/10W	1	
	R16472	D0GB222JA041	M 2.2KOHM,J,1/10W	1	
	R16473	ERJ6GEYF561	M 560 OHM,F,1/10W	1	
	R16474	D0GB102JA041	M 1KOHM,J,1/10W	1	
	R16475	ERJ3GEYJ472	M 4.7KOHM,J,1/16W	1	
	R16476	ERJ3GEYJ472	M 4.7KOHM,J,1/16W	1	
	R16490	ERJ6RBD104	M 100KOHM, 1/10W	1	
	R16491	ERJ6RED114	M 110KOHM, 1/10W	1	
	R16492	ERJ6RED124	M 120KOHM, 1/10W	1	
	R16493	ERJ6RBD6981	M69.8 OHM,F,1/10W	1	PAVCCZ
	R16494	D1BB2001A055	M 2KOHM, 1/10W	1	
	R16495	ERJ6ENF3900	M 390 OHM, 1/10W	1	
	R16496	ERJ6GEYJ470V	M 47 OHM,J,1/10W	1	
	R16497	D0GB473JA057	M 47KOHM,J,1/10W	1	
	R16498	D0GB103JA057	M 10K OHM J 1/10W	1	
	R16503	ERJT06J100V	M 10 OHM,F,0.25W	1	
	R16504	ERJT06J750V	M 75 OHM,F,0.25W	1	
	R16506	ERJT06J100V	M 10 OHM,F,0.25W	1	
	R16510	ERJT14J1R0U	M 1.0 OHM, J,1/4W	1	
	R16512	D0GB473JA057	M 47KOHM,J,1/10W	1	
	R16517	D0GB473JA057	M 47KOHM,J,1/10W	1	

Safety	Ref. No.	Part No.	Part Name & Description	Pcs	Remarks
	R16521	ERJ6GEYJ101V	M 100 OHM,J,1/10W	1	
	R16522	ERJ6GEYJ101V	M 100 OHM,J,1/10W	1	
	R16523	ERJT06J750V	M 75 OHM,F,0.25W	1	
	R16524	ERJT06J750V	M 75 OHM,F,0.25W	1	
	R16531	ERJT06J100V	M 10 OHM,F,0.25W	1	
	R16533	D0GB473JA057	M 47KOHM,J,1/10W	1	
	R16534	ERJT08J5R6V	M 5.6 OHM,F,0.33W	1	
	R16551	ERJT06J100V	M 10 OHM,F,0.25W	1	
	R16553	D0GB473JA057	M 47KOHM,J,1/10W	1	
	R16561	EXB38V470J	RESISTOR ARRAY	1	
	R16562	EXB38V470J	RESISTOR ARRAY	1	
	R16563	EXB38V470J	RESISTOR ARRAY	1	
	R16564	EXB38V470J	RESISTOR ARRAY	1	
	R16565	EXB38V472JV	RESISTOR ARRAY	1	
	R16566	EXB38V472JV	RESISTOR ARRAY	1	
	R16567	EXB38V472JV	RESISTOR ARRAY	1	
	R16568	EXB38V472JV	RESISTOR ARRAY	1	
	R16580	D0GB562JA041	M 5.6KOHM,J,1/10W	1	
	R16581	ERJ3GEYJ223	M 22KOHM,J,1/16W	1	
	R16582	ERJT08J393	M 39 KOHM,J,0.33W	1	
	R16583	ERJT08J393	M 39 KOHM,J,0.33W	1	
	R16584	D1BD6811A044	M6.81KOHM,1/10W	1	
	R16585	D1BB1001A055	M 1KOHM,1/16W	1	
	R16586	D1BB1691A055	M1.69KOHM,1/10W	1	PAVCCZ
	R16587	D0GB222JA041	M 2.2KOHM,J,1/10W	1	
	R16588	D0GB103JA057	M 10K OHM J 1/10W	1	
	R16590	ERJ3GEYJ221	M 220 OHM,J,1/16W	1	
	R16591	EXB38V472JV	RESISTOR ARRAY	1	
	R16593	D1BB1331A055	M1.33KOHM,1/10W	1	PAVCCZ
	R16601	ERJT08J1R0V	M 1.8OHM,J,0.33W	1	
	R16604	ERJ6GEYJ331V	M 330 OHM J 1/10W	1	
	R16605	ERJ6GEYJ182	M 1.8KOHM,J,1/10W	1	
	R16607	D1BB6491A055	M6.49KOHM,1/10W	1	PAVCCZ
	R16609	ERJT08J202V	M 2KOHM,J,0.33W	1	
	R16610	D0GB104JA041	M 100KOHM J 1/10W	1	
	R16612	ERJT06J470V	M 47 OHM,F,0.25W	1	
	R16615	D1BB1131A055	M1.13KOHM,1/10W	1	PAVCCZ
	R16617	ERJ6GEYJ222V	M 2.2K OHM J 1/10W	1	
	R16619	ERJT08J1R0V	M 1.8OHM,J,0.33W	1	
	R16621	ERJ6GEYJ221V	M 220 OHM,J,1/10W	1	
	R16631	D0GB103JA057	M 10K OHM J 1/10W	1	
	R16633	ERJ6GEYJ223	M 22KOHM,J,1/10W	1	
	R16634	ERJ6GEYJ471	M 470 OHM,J,1/10W	1	
	R16658	ERJ3RBD9761	M9.76K OHM, 1/13W	1	PAVCCZ
	R16661	D0GB122JA041	N 1.2KOHM J 1/10W	1	
	R16663	ERJ3RBD6981	M6.98K OHM, 1/13W	1	PAVCCZ
	R16664	ERJT08J102V	M 1KOHM,J,0.33W	1	
	R16665	ERJT06J330V	M 33 OHM,F,0.25W	1	
	R16666	D1BB2202A087	M 22KOHM,1/10W	1	
	R16674	ERJT08J102V	M 1KOHM,J,0.33W	1	
	R16675	ERJ3GEYJ472	M 4.7KOHM,J,1/16W	1	
	R16679	D1BB1002A087	M 10KOHM,1/10W	1	
	R16680	D1BB1002A087	M 10KOHM,1/10W	1	
	R16681	ERJT06J100V	M 10 OHM,F,0.25W	1	

Safety	Ref. No.	Part No.	Part Name & Description	Pcs	Remarks
	R16684	ERJ6GEYJ221V	M 220 OHM,J,1/10W	1	
	R16685	ERJ6GEYJ221V	M 220 OHM,J,1/10W	1	
	R16686	D0GB103JA057	M 10K OHM J 1/10W	1	
	R16690	ERJ3GEYJ472	M 4.7KOHM,J,1/16W	1	
	R16691	ERJ8GEYJ563	M 56KOHM, J,1/8W	1	
	R16692	ERJ6RBD152	M 1.5KOHM,J,1/10W	1	
	R16694	ERJ8GEYJ563	M 56KOHM, J,1/8W	1	
	R16695	ERJ6RBD152	M 1.5KOHM,J,1/10W	1	
	R16696	ERF5TK2R2	W 2.2 OHM, K, 5W	1	
	R16699	D0GB103JA057	M 10K OHM J 1/10W	1	
	R16707	ERJ6GEYJ392	M 3.9KOHM,J,1/10W	1	
	R16711	ERJ3GEYJ472	M 4.7KOHM,J,1/16W	1	
	R16712	ERJ6GEYJ102V	M 1K OHM J 1/10W	1	
	R16717	D0GB102JA041	M 1KOHM,J,1/10W	1	
	R16742	D0GB473JA057	M 47KOHM,J,1/10W	1	
	R16745	D0GB474JA041	M 470KOHM,J,1/10W	1	
	R16746	ERJ6GEYF473	M 47KOHM,J,1/10W	1	
	R16747	ERJ6GEYJ222V	M 2.2K OHM J 1/10W	1	
	R16750	ERJT06J273V	M 27KOHM,J,0.25W	1	PAVCCZ
	R16751	ERJT06J154V	M 150KOHM,F,0.25W	1	
	R16752	ERJ3GEYJ472	M 4.7KOHM,J,1/16W	1	
	R16753	ERJ6GEYF473	M 47KOHM,J,1/10W	1	
	R16755	ERJT06J273V	M 27KOHM,J,0.25W	1	PAVCCZ
	R16761	ERJT06J100V	M 10 OHM,F,0.25W	1	
	R16763	D0GB473JA057	M 47KOHM,J,1/10W	1	
	R16765	ERJT06J100V	M 10 OHM,F,0.25W	1	
	R16769	ERJT06J750V	M 75 OHM,F,0.25W	1	
	R16772	ERJ3GEYJ472	M 4.7KOHM,J,1/16W	1	
	R16773	ERJ6GEYJ102V	M 1K OHM J 1/10W	1	
	R16774	ERG1SJ273	M 27KOHM, J, 1W	1	
	R16776	ERJ6GEYJ470V	M 47 OHM,J,1/10W	1	
	R16783	ERJT06J154V	M 150KOHM,F,0.25W	1	
	R16785	ERJ6ENF1003	M 100KOHM,1/10W	1	
	R16786	ERJ6ENF1003	M 100KOHM,1/10W	1	
	R16787	ERJ6ENF3302	M 33KOHM,1/10W	1	
	R16789	D0GB103JA057	M 10K OHM J 1/10W	1	
	R16801	ERJ6RBD223V	M 22KOHM,1/16W	1	
	R16802	ERJ6RBD3322	M33.2KOHM,F,1/10W	1	PAVCCZ
	R16804	ERJ8GEYJ112	M 1.1KOHM, J,1/8W	1	
	R16822	ERJ6ENF8202	M 82KOHM,1/10W	1	
	R16823	ERJ6ENF8202	M 82KOHM,1/10W	1	
	R16824	ERJ6ENF3302	M 33KOHM,1/10W	1	
	R16825	ERJT06J154V	M 150KOHM,F,0.25W	1	
	R16826	ERJ6GEYJ103V	M 10K OHM J 1/10W	1	
	R16827	D0GB222JA041	M 2.2KOHM,J,1/10W	1	
	R16829	D0GB102JA041	M 1KOHM,J,1/10W	1	
	R16831	ERJ6RBD6812	M68.1KOHM,F,1/10W	1	
	R16832	ERJ6RBD7152	M71.5KOHM,F,1/10W	1	
	R16837	D0GB102JA041	M 1KOHM,J,1/10W	1	
	R16838	ERG1FJS823D	M 82KOHM, J, 1W	1	
	R16841	ERJ3GEYJ472	M 4.7KOHM,J,1/16W	1	
	R16843	ERJ6GEYJ102V	M 1K OHM J 1/10W	1	
	R16844	ERA6YEB242	M 24KOHM,1/10W	1	

Safety	Ref. No.	Part No.	Part Name & Description	Pcs	Remarks
	R16845	ERJ6RBD6042	M60.4KOHM,F,1/10W	1	PAVCCZ
	R16846	ERJ6RBD6042	M60.4KOHM,F,1/10W	1	PAVCCZ
	R16849	ERJ6RBD6042	M60.4KOHM,F,1/10W	1	PAVCCZ
	R16851	D0GB474JA041	M 470KOHM,J,1/10W	1	
	R16852	D0GB474JA041	M 470KOHM,J,1/10W	1	
	R16860	ERG2FNJS8R2E	M 8.2 OHM, J, 2W	1	
	R16870	ERJ14YJ683	M 68KOHM, 1/2W	1	
	R16873	ERA6YEB242	M 24KOHM, 1/10W	1	
	R16891	D1BF6982A058	M 6.98KOHM, 1/10W	1	
	R16892	D1BF8252A058	M 8.25KOHM, 1/10W	1	
	R16893	D1BF8252A058	M 8.25KOHM, 1/10W	1	
	R16897	ERJ6ENF2611	M2.61KOHM, 1/10W	1	
	R16899	ERJ6ENF3011	M3.01KOHM, 1/10W	1	
	R16904	ERJ6GEYJ223	M 22KOHM,J,1/10W	1	
	R16920	D0GB103JA057	M 10K OHM J 1/10W	1	
	R16921	ERJ6ENF1541	M1.54KOHM, 1/10W	1	
	R16922	ERJ6ENF4021	M4.02KOHM, 1/10W	1	
	R16923	D0GB103JA057	M 10K OHM J 1/10W	1	
	R16926	D0GB222JA041	M 2.2KOHM,J,1/10W	1	
	R16927	ERJ6GEYJ223	M 22KOHM,J,1/10W	1	
	R16928	ERJ6GEYJ472V	M 4.7K OHM J 1/10W	1	
	R16929	ERJT08J1R0V	M 1.8OHM,J,0.33W	1	
	R16930	D1BF2R70A021	M 2.7 OHM, 1/10W	1	
	R16931	D1BF2R70A021	M 2.7 OHM, 1/10W	1	
	R16932	ERJ6GEYJ223	M 22KOHM,J,1/10W	1	
	R16933	D1BB1002A055	M 10KOHM, 1/10W	1	
	R16934	D1BB6801A055	M 6.8KOHM, 1/10W	1	
	R16935	ERJ6GEYJ512	M 5.1KOHM,J,1/10W	1	
	R16936	D0GB222JA041	M 2.2KOHM,J,1/10W	1	
	R16937	D0GB184JA041	M 180KOHM J 1/10W	1	
	R16938	D0GB184JA041	M 180KOHM J 1/10W	1	
	R17101	ERJT08J151V	M150 OHM,F,0.33W	1	
	R17112	ERJT14J1R0U	C1.0 OHM, J,1/4W	1	
	R17116	ERJT14J1R0U	C1.0 OHM, J,1/4W	1	
	R17118	ERJT14J1R0U	C1.0 OHM, J,1/4W	1	
	R17120	ERJT14J1R0U	C1.0 OHM, J,1/4W	1	
	R17124	D0GB470JA041	M 47 OHM,J,1/10W	1	
	R17125	EXB38V470J	RESISTOR ARRAY	1	
	R17126	D0GB681JA041	M 680 OHM,J,1/10W	1	
	R17127	EXB38V681J	RESISTOR ARRAY	1	
	R17128	D0GB102JA041	M 1KOHM,J,1/10W	1	
	R17129	ERJ6GEYJ224	M 220KOHM,J,1/10W	1	
	R17130	ERJ6GEY0R00V	M 0 OHM J 1/10W	1	
	R17131	D0GBR00Z0002	M 0 OHM J 1/10W	1	
	R17132	D0GBR00Z0002	M 0 OHM J 1/10W	1	
	R17133	EXB38V101JV	RESISTOR ARRAY	1	
	R17134	EXB38V101JV	RESISTOR ARRAY	1	
	R17135	EXB38V101JV	RESISTOR ARRAY	1	
	R17136	EXB38V101JV	RESISTOR ARRAY	1	
	R17203	EXB38V681J	RESISTOR ARRAY	1	
	R17204	D0GB681JA041	M 680 OHM,J,1/10W	1	
	R17209	EXB38V470J	RESISTOR ARRAY	1	
	R17210	D0GB470JA041	M 47 OHM,J,1/10W	1	
	R17213	ERJT14J1R0U	C1.0 OHM, J,1/4W	1	
	R17215	ERJT14J1R0U	C1.0 OHM, J,1/4W	1	
	R17217	EXB38V681J	RESISTOR ARRAY	1	
	R17218	EXB38V470J	RESISTOR ARRAY	1	

Safety	Ref. No.	Part No.	Part Name & Description	Pcs	Remarks
	R17219	ERJ6GEY0R00V	M 0 OHM J 1/10W	1	
	R17226	ERJ6GEYJ224	M 220KOHM,J,1/10W	1	
	R17227	ERJT14J1R0U	C1.0 OHM, J,1/4W	1	
	R17229	ERJT14J1R0U	C1.0 OHM, J,1/4W	1	
	R17231	ERJT08J151V	M150 OHM,F,0.33W	1	
	R17232	D0GBR00Z0002	M 0 OHM J 1/10W	1	
	R17233	D0GBR00Z0002	M 0 OHM J 1/10W	1	
	R17234	EXB38V101JV	RESISTOR ARRAY	1	
	R17235	EXB38V101JV	RESISTOR ARRAY	1	
	R17236	EXB38V101JV	RESISTOR ARRAY	1	
	R17237	EXB38V101JV	RESISTOR ARRAY	1	
	SN2	K1KA02A00676	2P CONNECTOR	1	
	SN3	K1KY03BA0236	3P CONNECTOR	1	
	SN11	K1MY96BA0342	96P CONNECTOR	1	PAVCCZ
	SN12	K1MY96BA0342	96P CONNECTOR	1	PAVCCZ
	SN13	K1MY96BA0342	96P CONNECTOR	1	PAVCCZ
	SN14	K1MY96BA0342	96P CONNECTOR	1	PAVCCZ
	SN15	K1MY96BA0342	96P CONNECTOR	1	PAVCCZ
	SN16	K1MY96BA0342	96P CONNECTOR	1	PAVCCZ
	SN17	K1MY96BA0342	96P CONNECTOR	1	PAVCCZ
	SN18	K1MY96BA0342	96P CONNECTOR	1	PAVCCZ
	SN20	K1MY30BA0345	30P CONNECTOR	1	PAVCCZ
	SS3	K1KY03BA0236	3P CONNECTOR	1	
	SS11	K1KY03B00006	3P CONNECTOR	1	
	SS23	K1KY06AA0719	6P CONNECTOR	1	
	SS53A	K1MY13BA0376	13P CONNECTOR	1	PAVCCZ
	SS55A	K1MY13BA0376	13P CONNECTOR	1	PAVCCZ
	T16471	G4DYA0000201	TRANSFORMER	1	PAVCCZ
	ZA001	K4CD01000011	AV TERMINAL	1	
	ZA002	K4CD01000011	AV TERMINAL	1	
	ZA16401	K4CD01000011	AV TERMINAL	1	
	ZA16402	K4CD01000011	AV TERMINAL	1	
	ZA16403	K4CD01000011	AV TERMINAL	1	
	ZA17102	K4CD01000013	AV TERMINAL	1	
	ZA17103	K4CD01000013	AV TERMINAL	1	
	ZA17104	K4CD01000013	AV TERMINAL	1	
	ZA17201	K4CD01000013	AV TERMINAL	1	
	ZA17202	K4CD01000013	AV TERMINAL	1	
	ZA17203	K4CD01000013	AV TERMINAL	1	
	C100	F1J1C474A059	C 0.47UF, Z, 16V	1	
△	C101	F0CAF334A021	C 0.33UF, 250V	1	
△	C102	F1BAF221A131	C 220UF, 250V	1	
△	C103	F1BAF221A131	C 220UF, 250V	1	
△	C104	F0CAF474A021	C 0.47UF, 250V	1	
△	C105	F0CAF224A021	C 0.22UF, 250V	1	
△	C109	ECWF2W225X03	P 0.022UF, 200V	1	
	C111	ECJ1VB1H102K	C 1000PF, K, 50V	1	
	C113	F1J1E225A209	C 2.2 UF 25V	1	
	C114	F1H1C224A065	C 0.22UF, K, 50V	1	
	C115	ECJ1VB1H103K	C 0.001UF, K, 50V	1	
	C116	ECJ1VB1H472K	C 4700PF, K, 50V	1	
	C118	ECJ1VB1H102K	C 1000PF, K, 50V	1	
	C120	F1E2J4730001	C 0.047PF, , 600V	1	
	C122	ECKD3A102KBP	C 1000PF, K, 1KV	1	
	C123	ECKD3A102KBP	C 1000PF, K, 1KV	1	
△	C125	F2B2W3310012	C 330UF, 450V	1	
	C127	F1H1C105A148	C 1UF, K, 16V	1	
	C200	ECJ1VB1H102K	C 1000PF, K, 50V	1	
△	C201	F2B2W220A032	C 22UF, 450V	1	
	C204	ECJ1VB1E104K	C 0.10UF, K, 25V	1	
	C205	F1H1H222A219	C 2200PF, K, 50V	1	
	C207	F2A1H1000083	E 10UF, 50V	1	
△	C209	F1BAF221A131	C 220UF, 250V	1	
	C210	F2A1H4700057	E 47UF, 50V	1	
	C211	F1J1E225A209	C 2.2 UF 25V	1	

Safety	Ref. No.	Part No.	Part Name & Description	Pcs	Remarks
	C212	ECJ1VB1H102K	C 1000PF, K, 50V	1	
△	C300	F1BAF221A131	C 220UF, 250V	1	
	C301	ECKD3A101KBP	C 100PF, K, 1KV	1	
△	C302	F1BAF221A131	C 220UF, 250V	1	
△	C314	ECWH8153HAB	P 0.015PF, J, 8KV	1	
	C400	ECJ1VB1H102K	C 1000PF, K, 50V	1	
	C401	F1A3A221A039	E 220UF, 1KV	1	
	C402	F1H1C105A148	C 1UF, K, 16V	1	
	C403	FIJ1E105A231	C 1 UF 25V	1	
	C406	F2A1H1000083	E 10UF, 50V	1	
△	C407	ECWF6103HLB	P 0.010UF, J, 600V	1	
	C410	ECQE6104KF	P 0.1UF, K, 630V	1	
	C411	ECJ2VB1H103K	C 0.01UF, K, 50V	1	
	C412	ECJ1VB1H103K	C 0.001UF, K, 50V	1	
	C413	ECJ1VB1H102K	C 1000PF, K, 50V	1	
	C414	ECJ1VB1H103K	C 0.001UF, K, 50V	1	
	C500	ECJ1VB1E104K	C 0.10UF, K, 25V	1	
	C505	F2A1A681B345	E 680UF, 10V	1	
	C519	ECJ1VB1H102K	C 1000PF, K, 50V	1	
	C601	ECJ1VB1H103K	C 0.001UF, K, 50V	1	
	C603	ECJ1VB1H103K	C 0.001UF, K, 50V	1	
	C607	ECJ1VB1H103K	C 0.001UF, K, 50V	1	
	C616	ECJ1VB1H103K	C 0.001UF, K, 50V	1	
	C617	ECJ1VB1H103K	C 0.001UF, K, 50V	1	
	C623	FIJ0J4750018	C 4.7UF, K, 16V	1	
	C625	ECJ1VB1H102K	C 1000PF, K, 50V	1	
	C627	ECJ2VB1H103K	C 0.01UF, K, 50V	1	
	C628	ECJ1VB1H103K	C 0.001UF, K, 50V	1	
	C700	FIJ1E105A231	C 1 UF 25V	1	
	C703	ECJ1VB1H332K	C 3300PF, K, 50V	1	
	C706	F1H1C105A148	C 1UF, K, 16V	1	
	C707	FIJ1E105A231	C 1 UF 25V	1	
	C709	FIJ1E104A137	C 0.10UF, Z, 25V	1	
	C711	ECJ1VB1H102K	C 1000PF, K, 50V	1	
	C712	FIJ1H471A721	C 470UF, 50V	1	
	C713	FIJ1E105A231	C 1 UF 25V	1	
	C714	FIJ1H333A571	C 0.033UF, 50V	1	
	C715	FIJ1H332A623	C 3300UF, 50V	1	
	C716	FIJ1E105A231	C 1 UF 25V	1	
	C717	ECJ1VB1H103K	C 0.001UF, K, 50V	1	
	C718	ECJ1VB1H102K	C 1000PF, K, 50V	1	
△	C721	F2A2T4210002	E 420UF, 220V	1	
	C724	ECJ1VB1H103K	C 0.001UF, K, 50V	1	
	C725	ECJ1VB1H103K	C 0.001UF, K, 50V	1	
	C726	FIJ1H333A571	C 0.033UF, 50V	1	
	C727	ECJ1VB1E104K	C 0.10UF, K, 25V	1	
	C728	ECJ1VB1E104K	C 0.10UF, K, 25V	1	
	C800	F2A1E1020108	E 1000UF, 25V	1	
	C802	ECJ1VB1E104K	C 0.10UF, K, 25V	1	
	C804	ECJ1VB1H103K	C 0.001UF, K, 50V	1	
	C805	FIJ1E105A231	C 1 UF 25V	1	
	C806	F2A1E1020108	E 1000UF, 25V	1	
	C807	FIJ1E105A231	C 1 UF 25V	1	
	C808	ECJ1VB1E104K	C 0.10UF, K, 25V	1	
	C810	FIJ1E105A231	C 1 UF 25V	1	
△	C901	F2AZZ6810001	E 681UF, 80V	1	
	C902	F2A1H4700057	E 47UF, 50V	1	
	C903	FIJ1H104A459	C 0.10UF, 50V	1	
	C905	ECJ2VB1H103K	C 0.01UF, K, 50V	1	
	C906	F1H1H222A219	C 2200PF, K, 50V	1	
	C907	F1H1C105A148	C 1UF, K, 16V	1	

Safety	Ref. No.	Part No.	Part Name & Description	Pcs	Remarks
	C908	ECJ1VB1H102K	C 1000PF, K, 50V	1	
	C909	FIJ1H273A571	C 0.027PF, 50V	1	
△	D100	BOFBAT000006	DIODE	1	
	D102	BOACDD000001	DIODE	1	
	D103	BOBC01400033	ZENER DIODE	1	
	D104	BOJCM000093	DIODE	1	
	D106	BOEAKT000048	DIODE	1	
	D108	BOHAPR000016	DIODE	1	
	D109	BOHAPR000016	DIODE	1	
	D114	BOACDJ000010	DIODE	1	
△	D200	BOEBKT000007	DIODE	1	
	D201	MTZJ10B	ZENER DIODE	1	
	D202	MTZJ10B	ZENER DIODE	1	
	D205	MTZJ10B	ZENER DIODE	1	
	D206	BOACDJ000010	DIODE	1	
	D207	BOBB17000009	ZENER DIODE	1	
	D208	BOECKM000046	DIODE	1	
	D209	BOECKM000046	DIODE	1	
	D210	BOBA03300004	ZENER DIODE	1	
	D300	BOEAD000001	DIODE	1	
	D301	BOEAD000001	DIODE	1	
	D400	MTZJ10B	ZENER DIODE	1	
	D401	MTZJ10B	ZENER DIODE	1	
	D402	BOJCCC000002	DIODE	1	
	D404	MTZJ12B	ZENER DIODE	1	
	D405	BOBA05100010	ZENER DIODE	1	
	D406	BOEAKS000003	DIODE	1	
	D408	BOECKM000046	DIODE	1	
	D410	BOHAMP000067	DIODE	1	
	D411	BOBC8R100015	ZENER DIODE	1	
	D501	BOJAMG000031	DIODE	1	
	D600	BOACDJ000010	DIODE	1	
	D604	BOEAD000001	DIODE	1	
	D605	BOEAD000001	DIODE	1	
	D611	BOACDJ000010	DIODE	1	
	D701	BOECKM000046	DIODE	1	
	D702	BOHBRR000001	DIODE	1	
	D703	BOFBAR000044	DIODE	1	
	D706	BOBC5R600065	ZENER DIODE	1	
	D708	BOACDJ000010	DIODE	1	
	D800	BOFBM000023	DIODE	1	
	D801	BOACDJ000010	DIODE	1	
	D900	BOBA03600020	ZENER DIODE	1	
	D901	BOJCM000093	DIODE	1	
	D902	BOEAMR000015	DIODE	1	
	D903	BOBA02100001	ZENER DIODE	1	
	D904	BOBA02100001	ZENER DIODE	1	
	D905	BOBA03600020	ZENER DIODE	1	
	D908	BOBA01500003	ZENER DIODE	1	
△	F100	K5E802BZ0002	FUSE	1	
△	F101	K5E802BZ0002	FUSE	1	
△	F200	K5G631B00008	FUSE	1	
	IC100	C0DBZYY00361	IC	1	
	IC200	C0DBZMC00006	IC	1	
△	IC201	MIP2K20MSSCF	IC	1	
△	IC202	B3PBA0000459	IC	1	
△	IC400	MIP418AMDS	IC	1	
△	IC401	B3PBA0000459	IC	1	
	IC500	C0DBZMC00006	IC	1	
△	IC600	B3PBA0000459	IC	1	
△	IC601	B3PBA0000459	IC	1	
	IC602	C0EBH0000210	IC	1	
	IC603	C2ABDB000130	IC	1	
	IC700	LSSK0087	IC	1	
	IC701	C0DBZMC00006	IC	1	
	IC800	C0DBZMC00006	IC	1	
	IC901	C0DBZMC00006	IC	1	
	IC902	C0DBZYY00360	IC	1	
△	IC903	B3PBA0000459	IC	1	

Safety	Ref. No.	Part No.	Part Name & Description	Pcs	Remarks
	IC904	C0DBZMC00006	IC	1	
△	L100	G0B103J00003	COIL	1	
△	L101	G0B103J00003	COIL	1	
	L700	J0JCC0000119	CHIP INDUCTOR	1	
	P2	K1KY02BA0001	2P CONNECTOR	1	
	P6	K1KA11AA0082	11P CONNECTOR	1	
	P7	K1KA14AA0082	14P CONNECTOR	1	
	P9	K1KA02B00295	2P CONNECTOR	1	
	P11	K1KA03B00246	3P CONNECTOR	1	
	P25	K1KA10AA0082	10P CONNECTOR	1	
	P34	K1KA03AA0193	3P CONNECTOR	1	
	P35	K1KA03A00647	3P CONNECTOR	1	
△	PR101	K5Y502B00008	FUSE	1	
△	PR900	K5Y402B00006	FUSE	1	
	Q101	DSC5001R0L	TRANSISTOR	1	
	Q103	B1BCCF000022	TRANSISTOR	1	
△	Q104	B1CERR000045	FET	1	
	Q300	B1CHPD000008	FET	1	
	Q301	B1CHPD000008	FET	1	
△	Q302	B1CERQ000058	FET	1	
△	Q303	B1CERQ000058	FET	1	
	Q400	DSC5001R0L	TRANSISTOR	1	
	Q401	B1CFGD000030	FET	1	
	Q402	B1CFGD000030	FET	1	
	Q505	B1CHPD000008	FET	1	
	Q600	DSC5001R0L	TRANSISTOR	1	
	Q602	DSC5001R0L	TRANSISTOR	1	
	Q701	B1HBCFA00033	TRANSISTOR	1	
	Q703	B1ADCF000111	TRANSISTOR	1	
	Q705	B1CFGD000030	FET	1	
	Q706	B1HDCEA00001	TRANSISTOR	1	
	Q707	DSC5001R0L	TRANSISTOR	1	
	Q708	B1ADCF000111	TRANSISTOR	1	
	Q709	B1CFGD000030	FET	1	
	Q710	B1CFGD000030	FET	1	
	Q711	DSC5001R0L	TRANSISTOR	1	
	Q712	DSC5001R0L	TRANSISTOR	1	
	Q714	B1ADCF000116	TRANSISTOR	1	
	Q715	B1ADCF000116	TRANSISTOR	1	
	Q800	B1CHRD000028	TRANSISTOR	1	
	Q801	DSC5001R0L	TRANSISTOR	1	
	Q805	B1ADCF000111	TRANSISTOR	1	
	Q806	DSC5001R0L	TRANSISTOR	1	
	Q807	B1HBCFA00033	TRANSISTOR	1	
△	Q901	B1CERP000025	FET	1	
	R101	D0GB394JA057	M 390KOHM J 1/10W	1	
△	R102	ERF5TJ100	W 10 OHM, J, 5W	1	
	R103	ERJ6GEYF333	M 33KOHM, J, 1/10W	1	
	R104	ERJ6GEYG104	M 100KOHM, J, 1/10W	1	
	R105	D1AB6343A023	CHIP RESISTOR	1	
	R106	ERJ3GEYJ434	M 430KOHM, J, 1/16W	1	
	R107	D1AB6343A023	CHIP RESISTOR	1	
	R108	ERJ3GEYJ223	M 22KOHM, J, 1/16W	1	
	R109	ERJ6GEYG103	M 10KOHM, J, 1/10W	1	
	R112	ERJ6GEY0R00V	M 0 OHM J 1/10W	1	
	R113	ERJ3EKF1002	M 10KOHM, 1/16W	1	
	R114	D0BF6R8JA035	M 6.8OHM, J, 0.05W	1	
	R115	D0BF6R8JA035	M 6.8OHM, J, 0.05W	1	
	R116	ERJ8GEYJ153	M 15KOHM, J, 1/8W	1	
	R117	ERJ8GEYJ153	M 15KOHM, J, 1/8W	1	
	R118	ERJ6GEYG183	M 18KOHM, J, 1/10W	1	
	R119	D0GB103JA057	M 10K OHM J 1/10W	1	

Safety	Ref. No.	Part No.	Part Name & Description	Pcs	Remarks
	R121	ERJ3GEYJ333	M 33KOHM, J, 1/16W	1	
	R122	ERX12SJ4R7	M 4.7 OHM, J, 1/2W	1	
	R123	D0GB103JA057	M 10K OHM J 1/10W	1	
	R125	D0XGR10J0003	M 0.100HM, J, 5W	1	
	R126	D0XGR10J0003	M 0.100HM, J, 5W	1	
	R127	ERJ6GEYG331	M 330 OHM, G, 1/10W	1	
	R128	ERJ6GEYG103	M 10KOHM, J, 1/10W	1	
	R129	D0GD4R7JA059	M 4.7 OHM, J, 0.25W	1	
	R130	ERJ3GEY0R00	M 0 OHM, 1/16W	1	
	R131	ERJ6GEY0R00V	M 0 OHM J 1/10W	1	
	R132	ERJ6GEY0R00V	M 0 OHM J 1/10W	1	
	R133	D1AB1004A023	CHIP RESISTOR	1	
	R134	D1AB1004A023	CHIP RESISTOR	1	
	R136	ERJ6GEYG104	M 100KOHM, J, 1/10W	1	
	R138	ERJ6GEYF123	M 12KOHM, J, 1/10W	1	
	R139	ERJ6RBD123V	M 12KOHM, J, 1/10W	1	
	R141	EVMAASA00B23	CONTROL 2KOHMB	1	
	R147	D1AB8453A023	CHIP RESISTOR	1	
	R148	D1AB8453A023	CHIP RESISTOR	1	
	R150	ERJ6ENF9101	M 9.1KOHM, 1/10W	1	
	R200	D1AB3303A023	CHIP RESISTOR	1	
	R201	D1AB3303A023	CHIP RESISTOR	1	
	R203	D1AB3303A023	CHIP RESISTOR	1	
	R204	D1AB3303A023	CHIP RESISTOR	1	
	R206	ERJ6ENF3302	M 33KOHM, 1/10W	1	
	R207	ERJ6ENF1272	M12.7KOHM, 1/10W	1	
	R208	ERJ6GEYG222	M 2.2KOHM, J, 1/10W	1	
	R209	D0GB102JA057	M 1KOHM, J, 1/10W	1	
	R210	ERJ3GEY0R00	M 0 OHM, 1/16W	1	
	R211	ERJ6GEYJ224	M 220KOHM, J, 1/10W	1	
	R214	ERJ6GEYG153	M 15KOHM, J, 1/10W	1	
	R215	ERJ6GEY0R00V	M 0 OHM J 1/10W	1	
	R216	D0GD4R7JA059	M 4.7 OHM, J, 0.25W	1	
	R217	D0GD4R7JA059	M 4.7 OHM, J, 0.25W	1	
△	R218	D0B1825JA033	M1.22MOHM, J, 0.05W	1	
	R300	D0GZ181JA020	M 180 OHM, J, 0.5W	1	
	R301	D0GZ181JA020	M 180 OHM, J, 0.5W	1	
	R302	ERJ8GEYJ220	M 22 OHM, J, 1/8W	1	
	R303	ERJ8GEYJ220	M 22 OHM, J, 1/8W	1	
	R304	ERX12SJ1R0	M 0.1 OHM, J, 1/2W	1	
	R305	ERX12SJ1R0	M 0.1 OHM, J, 1/2W	1	
	R400	ERJ6GEYG222	M 2.2KOHM, J, 1/10W	1	
	R401	ERJ6GEYJ203	M 20KOHM, J, 1/10W	1	
	R403	ERJ6ENF3001	M 3KOHM, 1/10W	1	
	R404	ERG2SJW563	M 56KOHM, J, 2W	1	
	R405	D0GD4R7JA059	M 4.7 OHM, J, 0.25W	1	
	R406	D0GD123JA059	M 12KOHM, F, 0.25W	1	
	R407	ERG2SJW563	M 56KOHM, J, 2W	1	
	R408	D0GD123JA059	M 12KOHM, F, 0.25W	1	
	R409	ERJ3GEYJ273	M 27KOHM, J, 1/16W	1	
	R410	ERJ3GEYJ273	M 27KOHM, J, 1/16W	1	
	R411	ERJ6GEYG104	M 100KOHM, J, 1/10W	1	
	R412	ERJ6GEYG102	M 1KOHM, J, 1/10W	1	
	R413	ERJ3GEYJ104	M 100KOHM, J, 1/16W	1	
	R414	D0GB105JA057	M 1M OHM F 1/10W	1	
	R415	ERJ6GEYG103	M 10KOHM, J, 1/10W	1	
	R416	D1AB7503A023	CHIP RESISTOR	1	
	R417	D1AB6343A023	CHIP RESISTOR	1	

Safety	Ref. No.	Part No.	Part Name & Description	Pcs	Remarks
	R418	ERJ6ENF1003	M 100KOHM, 1/10W	1	
	R500	ERJ6GEYG221	M 220 OHM,J,1/10W	1	
	R502	ERJ3GEYJ332	M 3.3KOHM,J,1/16W	1	
	R503	ERJ3GEYJ472	M 4.7KOHM,J,1/16W	1	
	R507	ERJ6RBD333	M 33KOHM,J,1/10W	1	
	R508	ERJ6RBD333	M 33KOHM,J,1/10W	1	
	R517	ERJ6GEYG103	M 10KOHM,J,1/10W	1	
	R518	ERJ3GEYJ104	M 100KOHM,J,1/16W	1	
	R601	DOGB102JA057	M 1KOHM,J,1/10W	1	
	R602	ERJ3GEYJ224	M 220KOHM,J,1/16W	1	
	R604	ERJ3GEYJ104	M 100KOHM,J,1/16W	1	
	R605	ERJ3GEYJ224	M 220KOHM,J,1/16W	1	
	R608	ERJ6GEYG102	M 1KOHM,J,1/10W	1	
	R609	ERJ3GEYJ104	M 100KOHM,J,1/16W	1	
	R610	ERJ6GEYJ101V	M 100 OHM,J,1/10W	1	
	R611	ERJ3GEYJ101	M 100 OHM,J,1/16W	1	
	R613	DOGB154JA057	M 150KOHM J 1/10W	1	
	R615	DOGB182JA057	M 1.8KOHM J 1/10W	1	
	R616	ERJ3GEYJ104	M 100KOHM,J,1/16W	1	
	R619	ERJ6GEYJ101V	M 100 OHM,J,1/10W	1	
	R620	DOGB102JA057	M 1KOHM,J,1/10W	1	
	R622	DOGB102JA057	M 1KOHM,J,1/10W	1	
	R623	ERJ3GEYJ104	M 100KOHM,J,1/16W	1	
	R624	ERJ6GEY0R00V	M 0 OHM J 1/10W	1	
	R625	ERJ6ENF2701	M 2.7KOHM, 1/10W	1	
	R626	ERJ3EKF3302	M 33KOHM, 1/16W	1	
	R627	DOGB103JA057	M 10K OHM J 1/10W	1	
	R628	ERJ3GEYJ222	M 2.2KOHM,J,1/16W	1	
	R630	ERJ6GEYJ101V	M 100 OHM,J,1/10W	1	
	R633	ERJ6GEY0R00V	M 0 OHM J 1/10W	1	
	R635	ERJ3GEYJ472	M 4.7KOHM,J,1/16W	1	
	R637	ERJ6GEYG152	M 1.5KOHM,J,1/10W	1	
	R639	ERJ3EKF10R0	M 10 OHM, 1/16W	1	
	R641	ERJ3GEYJ472	M 4.7KOHM,J,1/16W	1	
	R643	ERJ6GEYG103	M 10KOHM,J,1/10W	1	
	R644	ERJ8GEYJ330	M 33 OHM, J,1/8W	1	
	R645	ERJ3GEYJ333	M 33KOHM,J,1/16W	1	
	R646	DOGB102JA057	M 1KOHM,J,1/10W	1	
	R647	DOGB103JA057	M 10K OHM J 1/10W	1	
	R649	ERJ6GEYJ101V	M 100 OHM,J,1/10W	1	
	R652	ERJ6GEYG392	M 3.9KOHM,J,1/10W	1	
	R653	ERJ6GEYG392	M 3.9KOHM,J,1/10W	1	
	R661	ERJ6GEY0R00V	M 0 OHM J 1/10W	1	
	R662	ERJ3GEYJ104	M 100KOHM,J,1/16W	1	
	R663	ERJ3GEYJ104	M 100KOHM,J,1/16W	1	
	R700	DOGD4R7JA059	M 4.7 OHM,J,0.25W	1	
	R702	ERJ3GEYJ101	M 100 OHM,J,1/16W	1	
	R703	ERJ6GEYG105	M 1.0 OHM,J,1/10W	1	
	R704	ERJ6GEYJ100V	M 10 OHM,J,1/10W	1	

Safety	Ref. No.	Part No.	Part Name & Description	Pcs	Remarks
	R706	ERJ8ENF1500	M 150 OHM, 1/8W	1	
	R707	ERJ3EKF1003	M 100KOHM, 1/16W	1	
	R708	ERJ6GEYG681	M 680 OHM,J,1/10W	1	
	R709	ERJ3EKF2702V	M27.0KOHM, 1/16W	1	
	R711	ERJ3EKF3302	M 33KOHM, 1/16W	1	
	R712	ERJ6GEY0R00V	M 0 OHM J 1/10W	1	
	R714	ERJ6GEYG102	M 1KOHM,J,1/10W	1	
	R726	ERJ6GEY0R00V	M 0 OHM J 1/10W	1	
	R727	ERJ6ENF1201	M 1.2KOHM, 1/10W	1	
	R728	ERJ6GEYJ101V	M 100 OHM,J,1/10W	1	
	R729	ERJ6GEYJ100V	M 10 OHM,J,1/10W	1	
	R730	ERJ8GEYJ472	M 4.7KOHM, J,1/8W	1	
	R731	ERJ6GEYJ4R7	M 4.7 OHM,J,1/10W	1	
	R732	ERJ6ENF1802	M 18KOHM, 1/10W	1	
	R733	ERJ6GEYJ4R7	M 4.7 OHM,J,1/10W	1	
	R734	ERJ6GEYJ101V	M 100 OHM,J,1/10W	1	
	R736	ERJ6GEYJ101V	M 100 OHM,J,1/10W	1	
	R739	ERJ6ENF3901	M 3.9KOHM, 1/10W	1	
	R740	ERJ3GEYJ331	M 330 OHM,J,1/16W	1	
	R741	ERJ6ENF6201	M 6.2KOHM, 1/10W	1	
	R742	ERJ6ENF1003	M 100KOHM, 1/10W	1	
	R743	ERJ6ENF1002	M 10KOHM, 1/10W	1	
	R744	ERJ6ENF1001	M 1KOHM, 1/10W	1	
	R745	ERJ6GEYF333	M 33KOHM,J,1/10W	1	
	R746	ERJ6GEYG103	M 10KOHM,J,1/10W	1	
	R749	ERJ6GEY0R00V	M 0 OHM J 1/10W	1	
	R750	ERJ6ENF1002	M 10KOHM, 1/10W	1	
	R752	ERJ6GEYF473	M 47KOHM,J,1/10W	1	
	R753	ERJ6ENF9102	M91.0KOHM, 1/10W	1	
	R754	ERJ6ENF9102	M91.0KOHM, 1/10W	1	
	R755	ERJ6ENF9102	M91.0KOHM, 1/10W	1	
	R756	ERJ6ENF9102	M91.0KOHM, 1/10W	1	
	R757	ERJ6ENF3302	M 33KOHM, 1/10W	1	
	R758	ERJ6ENF1503	M 150KOHM, 1/10W	1	
	R759	ERJ6ENF1503	M 150KOHM, 1/10W	1	
	R760	ERJ6ENF1503	M 150KOHM, 1/10W	1	
	R761	ERJ6ENF1503	M 150KOHM, 1/10W	1	
	R762	ERJ6ENF1603	M 160KOHM, 1/10W	1	
	R763	ERJ6ENF1502	M 150KOHM, 1/10W	1	
	R764	ERJ6ENF8201	M 8.2KOHM, 1/10W	1	
	R766	ERJ6GEYG104	M 100KOHM,J,1/10W	1	
	R767	ERJ6GEYJ101V	M 100 OHM,J,1/10W	1	
	R770	D1AGR022A025	CHIP RESISTOR	1	
	R773	ERJ6ENF1201	M 1.2KOHM, 1/10W	1	
	R774	ERJ6GEYG103	M 10KOHM,J,1/10W	1	
	R775	ERJ6RBD303	M 30KOHM,J,1/10W	1	
	R776	ERJ6GEYG103	M 10KOHM,J,1/10W	1	
	R777	ERJ6GEYG104	M 100KOHM,J,1/10W	1	
	R778	ERJ6GEYF473	M 47KOHM,J,1/10W	1	
	R779	ERJ6GEYF473	M 47KOHM,J,1/10W	1	
	R780	ERJ6GEY0R00V	M 0 OHM J 1/10W	1	
	R781	ERJ6GEY0R00V	M 0 OHM J 1/10W	1	
	R783	ERJ6ENF2003	M 200KOHM, 1/10W	1	
	R784	ERJ6ENF2003	M 200KOHM, 1/10W	1	
	R785	ERJ6GEYG102	M 1KOHM,J,1/10W	1	
	R786	ERJ6GEYG104	M 100KOHM,J,1/10W	1	
	R787	ERJ3GEYJ331	M 330 OHM,J,1/16W	1	
	R788	ERJ6GEYJ101V	M 100 OHM,J,1/10W	1	
	R789	ERJ3GEYJ334	M 330KOHM,J,1/16W	1	
	R790	ERJ3EKF3301	M 3.3KOHM, 1/16W	1	
	R792	ERJ3GEY0R00	M 0 OHM, 1/16W	1	

Safety	Ref. No.	Part No.	Part Name & Description	Pcs	Remarks
	R793	ERJ3GEY0R00	M 0 OHM, 1/16W	1	
	R798	ERJ3GEY0R00	M 0 OHM, 1/16W	1	
	R800	ERJ6GEYJ102	M 1KOHM, J, 1/10W	1	
	R801	ERJ6GEYJ562	M 5.6KOHM, J, 1/10W	1	
	R802	ERJ3GEYJ431V	M 430 OHM, J, 1/16W	1	
	R803	ERJ6RBD333	M 33KOHM, J, 1/10W	1	
	R804	ERJ6RBD622	M 6.2KOHM, J, 1/10W	1	
	R807	ERJ3GEYJ274	M 270KOHM, J, 1/16W	1	
	R808	D0GB102JA057	M 1KOHM, J, 1/10W	1	
	R809	D0GB184JA057	M 180KOHM J 1/10W	1	
	R810	D0GB473JA057	M 47KOHM, J, 1/10W	1	
	R811	ERJ3GEYJ104	M 100KOHM, J, 1/16W	1	
	R812	ERJ6GEYJ103	M 10KOHM, J, 1/10W	1	
	R900	ERJ8GEYJ222	M 2.2KOHM, J, 1/8W	1	
	R901	ERJ6GEY0R00V	M 0 OHM J 1/10W	1	
	R902	D0GF101JA047	M 100 OHM, J, 0.33W	1	
	R903	D1AGR068A025	CHIP RESISTOR	1	
	R905	ERJ8GEYJ243	M 24KOHM, J, 1/8W	1	
	R906	ERJ8GEYJ222	M 2.2KOHM, J, 1/8W	1	
	R907	ERJ6ENF1001	M 1KOHM, 1/10W	1	
	R908	ERJ6ENF3301	M 3.3KOHM, 1/10W	1	
	R909	D0GB473JA057	M 47KOHM, J, 1/10W	1	
	R910	ERJ3GEYJ333	M 33KOHM, J, 1/16W	1	
	R911	ERJ3GEYD153V	M 15KOHM, J, 1/16W	1	
	R912	ERJ6GEYJ331	M 330 OHM, G, 1/10W	1	
	R913	ERJ6GEYJ152	M 1.5KOHM, J, 1/10W	1	
	R914	ERJ6GEYJ102	M 1KOHM, J, 1/10W	1	
	R915	ERJ6GEY0R00V	M 0 OHM J 1/10W	1	
	R916	ERJ6ENF1103	M 110KOHM, 1/10W	1	
	R917	ERJ6ENF1003	M 100KOHM, 1/10W	1	
	R918	ERJ6ENF8201	M 8.2KOHM, 1/10W	1	
	R919	ERJ6GEY0R00V	M 0 OHM J 1/10W	1	
	R921	ERJ8GEYJ101	M 100 OHM, J, 1/8W	1	
	R922	ERX12SJ5R6	M 5.6 OHM, J, 1/2W	1	
	R923	EVMAASA00B23	CONTROL 2KOHMB	1	
	R924	ERJ8GEYJ243	M 24KOHM, J, 1/8W	1	
	R926	ERJ6ENF2003	M 200KOHM, 1/10W	1	
	R927	ERJ6ENF2003	M 200KOHM, 1/10W	1	
	R928	ERJ6ENF2202	M 2.2KOHM, 1/10W	1	
	R933	ERJ8GEYJ101	M 100 OHM, J, 1/8W	1	
	R941	D0XGR10J0003	M 0.100HM, J, 5W	1	
	R942	ERJ6GEYJ222	M 2.2KOHM, J, 1/10W	1	
	R943	ERJ6GEYJ223	M 22KOHM, J, 1/10W	1	
	R944	ERJ6ENF1001	M 1KOHM, 1/10W	1	
	R945	ERJ6ENF9102	M91.0KOHM, 1/10W	1	
	R946	ERJ6GEYF473	M 47KOHM, J, 1/10W	1	
	R947	ERJ6GEYF473	M 47KOHM, J, 1/10W	1	
	R948	ERJ6GEYJ223	M 22KOHM, J, 1/10W	1	
	R949	ERJ6GEY0R00V	M 0 OHM J 1/10W	1	
	R950	ERJ6ENF4702	M 47KOHM, 1/10W	1	
△	RL101	K6B1AYY00057	RELAY	1	
△	RL102	K6B1AYY00057	RELAY	1	
△	S102	J0LV00000011	SERGE ABSORBER	1	
	T100	G4DYA0000206	SWITCHING TRANS	1	
△	T200	ETS15AC116AH	SWITCHING TRANS-FORMER	1	
△	T300	G4DYA0000194	SWITCHING TRANS-FORMER	1	

Safety	Ref. No.	Part No.	Part Name & Description	Pcs	Remarks
△	T301	ETS35LK11GAD	SWITCHING TRANS-FORMER	1	
△	T400	ETS29AZ2YGAD	SWITCHING TRANS-FORMER	1	
	T900	ETS25AG11GAD	SWITCHING TRANS-FORMER	1	
	TP700	G0ZZ00002183	PEAKING COIL	1	
	TP900	G0ZZ00002183	PEAKING COIL	1	
	VR251	EVMAASA00B33	CONTROL 3KOHMB	1	
	X600	H2B400400021	CRYSTAL	1	
	Z1	K4CZ01000027	AV TERMINAL	1	
	Z2	K4CZ01000027	AV TERMINAL	1	
	Z3	K4CZ01000027	AV TERMINAL	1	
△	ZN100	D4EAD6210001	VARISTOR	1	
△	ZN101	D4EAB681A011	VARISTOR	1	
△	ZN102	D4EAD6210001	VARISTOR	1	
△	ZN200	D4EA8511A001	VARISTOR	1	
△	ZN201	D4EA8511A001	VARISTOR	1	