

Parts Location

NOTE:

The numbers on the exploded view below refer to the exploded view section of the Replacement Parts List.

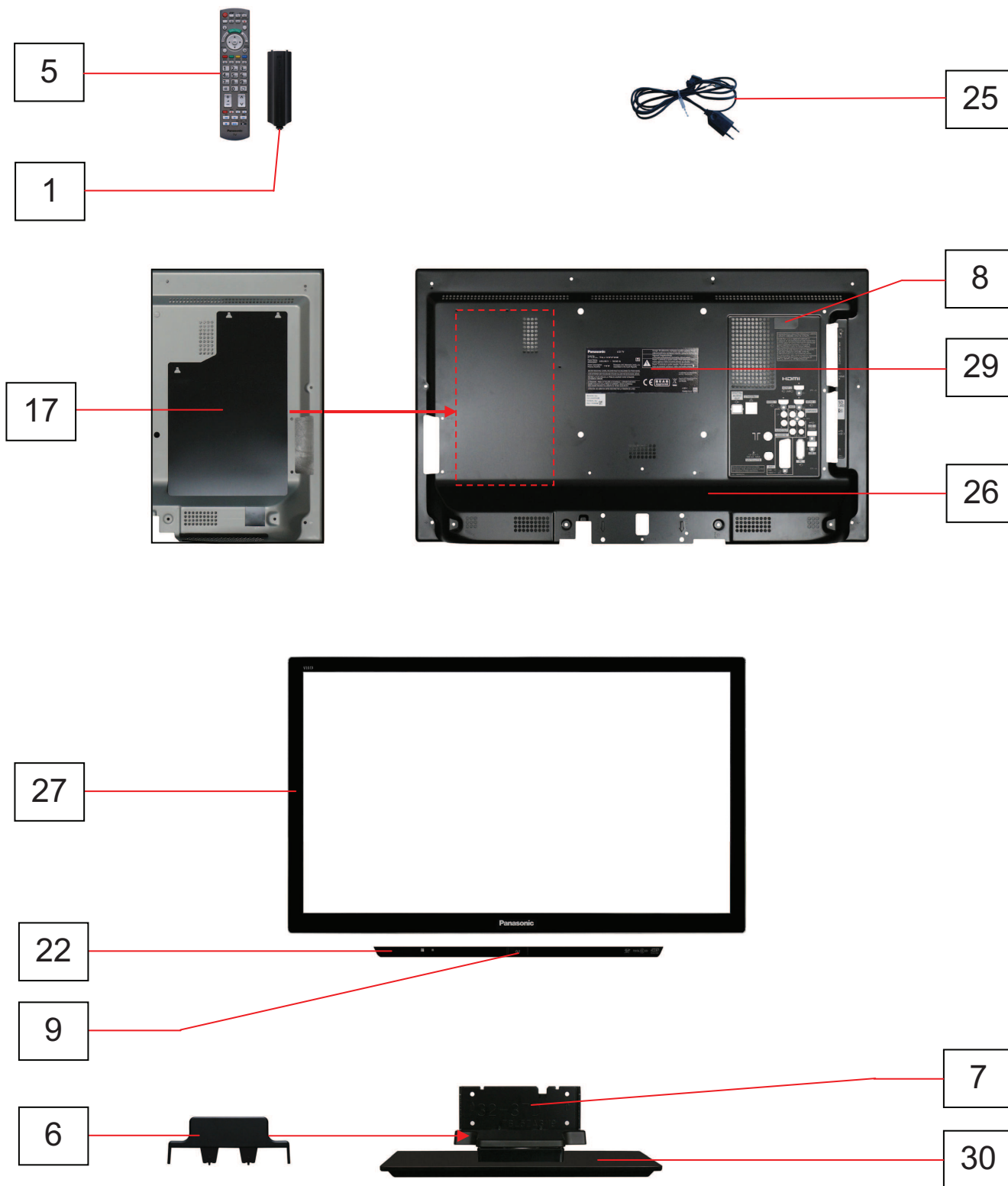

Parts Location

NOTE:
The numbers on the exploded view below refer to the exploded view section of the Replacement Parts List.

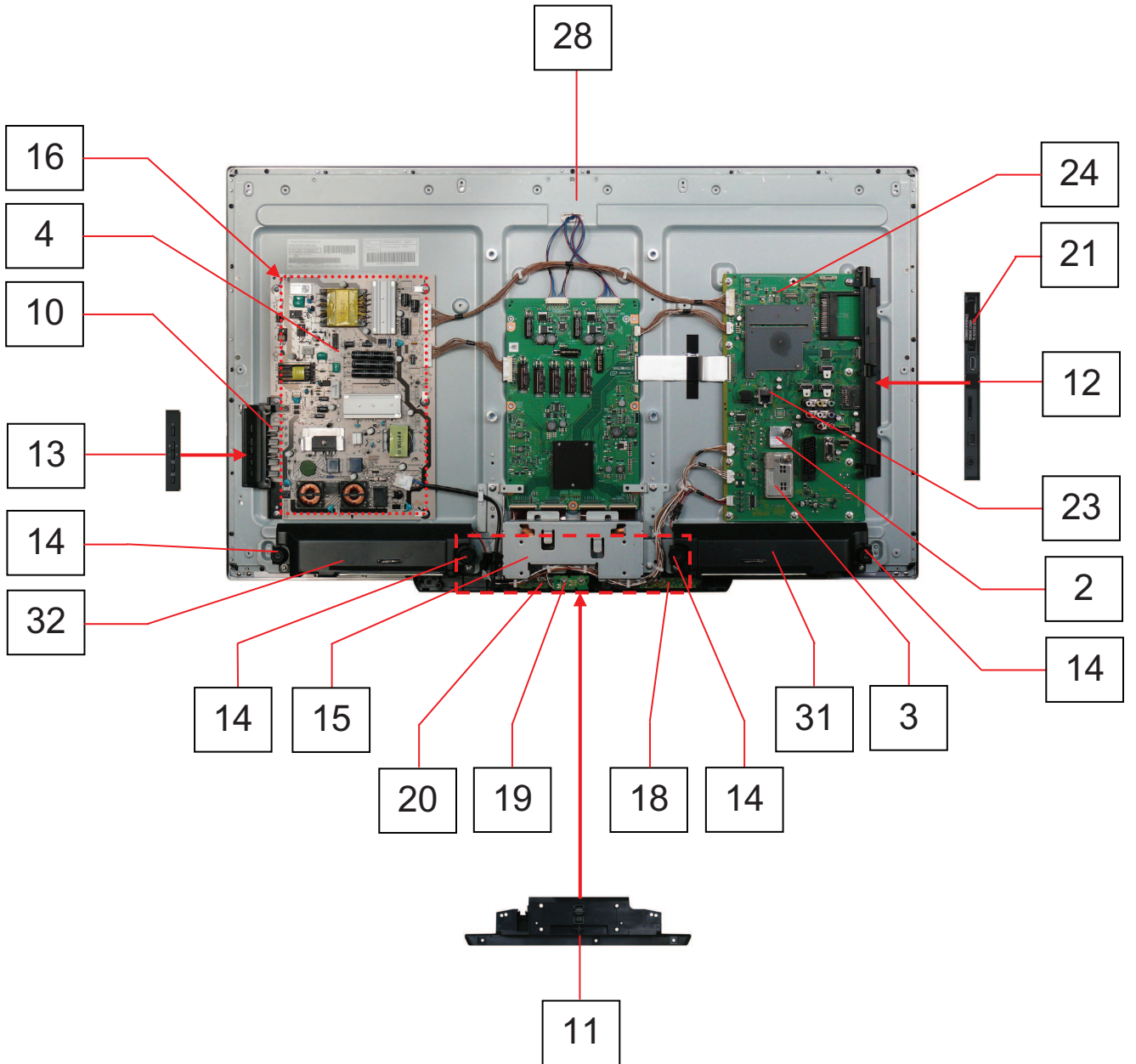

Replacement Parts List













Important Safety Notice

























Components Identified by  mark have special characteristics important for safety.
 * When replacing any of these components, use only manufacturers specified parts.
 In case of ordering these spare parts, please always add the complete Model-Type number to your order.

RTL (Retention Time Limited)

Note: The marking (RTL) indicates that the Retention Time is Limited for this item. After the discontinuation of this assembly in production, the item will continue to be available for a specific period of time. The retention period of availability is dependent on the type of assembly, and in accordance with the laws governing part and product retention. After the end of this period, the assembly will no longer be available.

X The marking (X) indicates that board should be exchanged for service.

Cct Ref	Parts Number	Description	
COMMON PARTS			
EXPLODED VIEW			
1	BAT-C-0572	BATTERY COVER OF RC	
2	ENGS7302D5F	TUNER DVB-T/T2/C	
3	J3BBCBC00007	TUNER DVB SAT	
4	N0AE3GJ00006	POWER UNIT	
5	N2QAYB000572	REMOTE CONTROL	
6	TBL5ZB3087-1	STAND METAL COVER	
7	TBL5ZX0160	STAND MOUNT ASSY	
8	TBM4GU113	COVER LABEL	
9	TBX0E87300	POWER BUTTON	
10	TBX0E87400	CONTROL BUTTON	
11	TKP0E48201	COVER BOTTOM	
12	TKP0E48301	SIDE AV BRACKET	
13	TKP0E48501	CONTROL PANEL	
14	TKXA28901	SPEAKER BRACKET	
15	TKZ4GC5076	METAL BRACKET BOTTOM	
16	TMK0EX041	BARRIER LCD ASSY	
17	TMK0EX042	BARRIER BC ASSY	
18	TNPA5378AB	KA P.C.B.	RTL 
19	TNPA5394AB	S P.C.B.	RTL 
20	TNPA5414AA	V P.C.B.	RTL 
21	TQF4GX013	CI SLOT COVER SHEET	
22	TTP0E0114	BOTTOM PANEL ASSY	
23	TUC4GC5037	LAN SHIELD	
MISCELLANEOUS COMPONENTS			
.	R6DB/2P	BATTERY	
.	TBM0E2551	SIDE AV LABEL	
.	TBM0E2552	REAR AV LABEL	
.	TEWB412	GASKET	
.	THEJ024	SCREW	
.	THEJ036J	SCREW	
.	THEJ0389	SCREW	
.	TKK4GC5031	LED PANEL	
.	TKKL5521	M6_CAP	
.	TMK0EG036	SPONGE	
.	TMME268	CLAMPER	
.	TMME397	CLAMPER	
.	TMME400	CLAMPER	
.	TPE0E4043	PROTECTION SHEET	
.	TPE0E9004	POLYBAG_PEDESTAL	
.	TPE0E9008	BAG	
.	TQF0EM3534	LABEL	
.	XSB26+3FN	SCREW	

Cct Ref	Parts Number	Description	
.	XSB3+5FJK	SCREW	
.	XSB4+12FN	SCREW	
.	XSS5+15FNK	SCREW	
.	XTB4+15JFJK	SCREW	
.	XTV3+10JFJK	SCREW	
.	XTW3+12TFJ	SCREW	
.	XYN4+F30FJK	SCREW	
.	XYN4+F8FJ	SCREW	
.	XYN5+F14FN	SCREW	
B-CENCU	TPD0E2182	BOTTOM CUSHION CENTER	
T-CENCU	TPD0E1177	TOP CUSHION CENTER	
INSTRUCTION BOOKS			
.	TQB0E2110A	GERMAN	
.	TQB0E2110B	DUTCH	
.	TQB0E2110C	ITALIAN	
.	TQB0E2110D	FRENCH	
.	TQB0E2110E	SPANISH	
.	TQB0E2110F	SWEDISH	
.	TQB0E2110G	NORWEGIAN	
.	TQB0E2110H	FINNISH	
.	TQB0E2110I	LITHUANIAN	
.	TQB0E2110J	PORTUGUESE	
.	TQB0E2110K	DANISH	
.	TQB0E2110M	BULGARIAN	
.	TQB0E2110N	ROMANIAN	
.	TQB0E2110O	LATVIAN	
.	TQB0E2110P	POLISH	
.	TQB0E2110Q	HUNGARIAN	
.	TQB0E2110R	CZECH	
.	TQB0E2110S	GREEK	
.	TQB0E2110T	TURKISH	
.	TQB0E2110U	ENGLISH	
.	TQB0E2110V	CROATIAN	
.	TQB0E2110W	SLOVAKIAN	
.	TQB0E2110X	CD	
.	TQB0E2110Z	ESTONIAN	
I.C.s			
IC3001	C1AB00003384	AUDIO VIDEO SWITCH	
IC4700	C1AB00003469	HDMI SWITCH	
IC4900	C1AB00003457	AUDIO AMPLIFIER	
IC5000	AN34043A-VF	ANALOG ASIC	
IC5205	C0DBGYY00281	REGULATOR	
IC5300	C0DBAYY01058	REGULATOR	
IC5400	C0DBAYY00915	REGULATOR	
IC5420	C0DBAYY00915	REGULATOR	
IC5440	C0DBAYY01058	REGULATOR	
IC5602	C0DBZYY00368	SWITCH IC	
IC5603	C0DBZYY00368	SWITCH IC	

Cct Ref	Parts Number	Description
IC5605	C0DBZY00450	USB POWER SWITCH
IC5900	C0DBAYY00931	REGULATOR
IC5901	C1ZBZ0004339	LED DRIVER
IC6775	C1AB00003521	LNB SUPPLY + VOL.REG.
IC6820	C0DBAYY00462	REGULATOR
IC8000	MN2WS0200LE	PEAKS_LDA3
IC8100	C0DBAYY00715	DC/DC CONVERTER
IC8200	C3ABUY000009	DDR SDRAM
IC8201	C3ABTY000026	DDR SDRAM
IC8403	C0JBAZ003032	BUFFER
IC8404	C0DBZY00382	POWER SWITCH IC
IC8601	C1CB00003239	LAN TRANSCEIVER
IC8702	C0CBCAG00039	REGULATOR
IC8703	C0DBAFF00019	REGULATOR
IC8706	C0DBAGF00030	REGULATOR
IC8900	TVRS076AE	NAND FLASH MEMORY
RM2800	PNJ4815M01TV	RC RECEIVER
SN2800	B3JB00000078	PHOTO IC DIODE
FUSES		
PA5300	K5H5022A0031	FUSE
PA5440	K5H5022A0031	FUSE
PA5900	K5H1022A0031	FUSE
PA6775	K5H2022A0031	FUSE
DIODES		
D1101	B0JCCD000020	DIODE
D2016	EZJZ0V120JA	VARISTOR
D2800A	B3AGB0000065	LED DIODE
D2851	B3EB00000056	INFRARED EMITTER
D2852	B3EB00000056	INFRARED EMITTER
D2853	B3EB00000056	INFRARED EMITTER
D2854	B3EB00000056	INFRARED EMITTER
D3130	DA2J10100L	DIODE
D4702	DA2J10100L	DIODE
D4704	B0JCCD000020	DIODE
D4719	DA2J10100L	DIODE
D4721	B0JCCD000020	DIODE
D4735	DA2J10100L	DIODE
D4737	B0JCCD000020	DIODE
D4770	DA2J10100L	DIODE
D4772	B0JCCD000020	DIODE
D4785	B0JCCD000020	DIODE
D5172	DZ2J220M0L	DIODE
D5173	DA2J10100L	DIODE
D5178	DZ2J068M0L	ZENER DIODE
D5179	DA2J10100L	DIODE
D5180	DZ2J033M0L	ZENER DIODE
D5183	DZ2J068M0L	ZENER DIODE
D5184	DA2J10100L	DIODE
D5187	DZ2J047M0L	ZENER DIODE
D5188	DA2J10100L	DIODE
D5189	DZ2J068M0L	ZENER DIODE
D5190	DA2J10100L	DIODE
D5193	DZ2J047M0L	ZENER DIODE
D5194	DA2J10100L	DIODE
D5207	B0JCCD000020	DIODE
D5301	B0JCPE000038	DIODE
D5440	B0JCPE000038	DIODE
D5900	B0JCMD000066	DIODE
D6775	B0JCMD000010	DIODE
D6776	B0JCND000029	DIODE
D6777	B0JCND000029	DIODE
D6778	B0ECKP000002	DIODE
D6781	B0ECKP000002	DIODE
D6820	B0JCPD000021	DIODE
D8716	B0ECKM000048	DIODE
TRANSISTORS		
Q0900	B1ADCF000194	TRANSISTOR

Cct Ref	Parts Number	Description
Q2800	B1ABCE000015	TRANSISTOR
Q2801	B1ABCE000015	TRANSISTOR
Q2802	B1ABCE000015	TRANSISTOR
Q3102	B1ABCF000231	TRANSISTOR
Q3103	B1ABCF000231	TRANSISTOR
Q3104	B1ABCF000231	TRANSISTOR
Q3105	B1ABCF000231	TRANSISTOR
Q4512	B1HFCFA00026	TRANSISTOR
Q4513	B1ADCE000022	TRANSISTOR
Q4700	B1ABCF000231	TRANSISTOR
Q4702	B1ABCF000231	TRANSISTOR
Q4704	B1ABCF000231	TRANSISTOR
Q4709	B1ABCF000231	TRANSISTOR
Q4971	B1AAF0000002	TRANSISTOR
Q4972	B1AAF0000002	TRANSISTOR
Q4974	DSC2001S0L	TRANSISTOR
Q6775	B1CFQD000001	TRANSISTOR
Q8100	B1CFRD000077	TRANSISTOR
Q8101	B1CFRD000077	TRANSISTOR
Q8102	B1MBEDA00027	TRANSISTOR
COILS		
L1080	JOJHC0000045	COIL BLM18PG121SN1D
L3002	G1C100MA0072	COIL
L3102	JOJCC0000287	COIL
L3103	JOJCC0000287	COIL
L3108	JOJCC0000287	COIL
L3111	JOJCC0000287	COIL
L3112	JOJCC0000287	COIL
L3113	JOJCC0000287	COIL
L3116	JOJCC0000287	COIL
L3117	JOJCC0000287	COIL
L3118	JOJCC0000287	COIL
L3119	JOJCC0000287	COIL
L3120	JOJCC0000287	COIL
L3121	JOJCC0000287	COIL
L4700	JOJYC0000068	CHIP INDUCTOR
L4701	JOJYC0000068	CHIP INDUCTOR
L4702	JOJYC0000068	CHIP INDUCTOR
L4703	JOJYC0000068	CHIP INDUCTOR
L4704	JOJYC0000068	CHIP INDUCTOR
L4705	JOJYC0000068	CHIP INDUCTOR
L4706	JOJYC0000068	CHIP INDUCTOR
L4707	JOJYC0000068	CHIP INDUCTOR
L4708	JOJYC0000068	CHIP INDUCTOR
L4715	JOJYC0000068	CHIP INDUCTOR
L4716	JOJYC0000068	CHIP INDUCTOR
L4717	JOJYC0000068	CHIP INDUCTOR
L4800	G1CR39J00009	COIL
L4801	G1CR39J00009	COIL
L4802	JOJGC0000020	COIL
L4803	JOJGC0000020	COIL
L4804	JOJGC0000020	COIL
L4805	JOJCC0000287	COIL
L4900	G1C150MA0426	COIL
L4901	G1C150MA0426	COIL
L4902	G1C150MA0426	COIL
L4903	G1C150MA0426	COIL
L4905	JOJHC0000042	CHIP INDUCTOR
L5300	G1C3R3ZA0240	COIL
L5400	G1C4R5ZA0156	COIL
L5420	G1C4R5ZA0156	COIL
L5440	G1C3R3ZA0240	COIL
L5601	JOJHC0000045	COIL BLM18PG121SN1D
L5602	JOJHC0000045	COIL BLM18PG121SN1D
L5603	JOJHC0000045	COIL BLM18PG121SN1D
L5900	G1C2R2MA0449	COIL
L6775	JOJGC0000020	COIL

Cct Ref	Parts Number	Description
L6776	G1C150MA0426	COIL
L6777	G1C4R7ZA0240	COIL
L6779	J0JGC0000020	COIL
L6780	J0JHC0000116	COIL
L6820	G1C4R7ZA0240	COIL
L8001	J0JCC0000287	COIL
L8002	J0JHC0000045	COIL BLM18PG121SN1D
L8003	J0JHC0000045	COIL BLM18PG121SN1D
L8004	J0JHC0000045	COIL BLM18PG121SN1D
L8005	J0JJC0000021	COIL
L8006	J0JCC0000287	COIL
L8007	J0JCC0000287	COIL
L8100	G1C4R7MA0416	COIL
L8102	G1C3R3MA0460	COIL
L8250	J0JHC0000045	COIL BLM18PG121SN1D
L8600	J0JHC0000045	COIL BLM18PG121SN1D
L8603	J0JBC0000115	FILTER
L8604	J0JBC0000115	FILTER
L8751	J0JHC0000045	COIL BLM18PG121SN1D
L8752	J0JHC0000045	COIL BLM18PG121SN1D
R8641	J0JBC0000115	FILTER
FILTERS		
FL4000	EXC28CE201U	FILTER
FL4001	EXC28CE201U	FILTER
FL4002	EXC28CE201U	FILTER
FL4003	EXC28CE201U	FILTER
FL4004	EXC28CE201U	FILTER
FL4005	EXC28CE201U	FILTER
FL5600	EXC24CE900U	FILTER
FL5601	EXC24CE900U	FILTER
FL5602	EXC24CE900U	FILTER
CRYSTALS		
X8300	H0J245500110	CRYSTAL
X8600	H0J250500109	CRYSTAL
RESISTORS		
JS0036	D0GAR00J0005	SMD .063W 5% 0 Ω
JS0055	D0GAR00J0005	SMD .063W 5% 0 Ω
R900	D0GA220JA023	SMD .063W 5% 22 Ω
R901	D0GA220JA023	SMD .063W 5% 22 Ω
R904	D0GA473JA015	SMD .063W 5% 47K Ω
R905	D0GA272JA023	SMD .063W 5% 2K7 Ω
R906	D0GA272JA023	SMD .063W 5% 2K7 Ω
R907	D0GA272JA023	SMD .063W 5% 2K7 Ω
R908	D0GA272JA023	SMD .063W 5% 2K7 Ω
R909	D0GA272JA023	SMD .063W 5% 2K7 Ω
R910	D0GA272JA023	SMD .063W 5% 2K7 Ω
R911	D0GA272JA023	SMD .063W 5% 2K7 Ω
R912	D0GA272JA023	SMD .063W 5% 2K7 Ω
R913	EXB28V332JX	SMD OTHER 5% 3K3 Ω
R916	D0GA220JA023	SMD .063W 5% 22 Ω
R917	D0GA220JA023	SMD .063W 5% 22 Ω
R918	D0GA220JA023	SMD .063W 5% 22 Ω
R919	D0GA220JA023	SMD .063W 5% 22 Ω
R920	D0GA220JA023	SMD .063W 5% 22 Ω
R921	D0GA220JA023	SMD .063W 5% 22 Ω
R926	D0GA220JA023	SMD .063W 5% 22 Ω
R927	D0GA220JA023	SMD .063W 5% 22 Ω
R928	D0GA220JA023	SMD .063W 5% 22 Ω
R929	D0GA220JA023	SMD .063W 5% 22 Ω
R932	D0GA220JA023	SMD .063W 5% 22 Ω
R933	D0GA220JA023	SMD .063W 5% 22 Ω
R934	D0GA220JA023	SMD .063W 5% 22 Ω
R935	D0GA220JA023	SMD .063W 5% 22 Ω
R0951	D0GA473JA015	SMD .063W 5% 47K Ω
R0952	D0GA102JA023	SMD .063W 5% 1K Ω
R1007	D0GAR00J0005	SMD .063W 5% 0 Ω
R1008	D0GAR00J0005	SMD .063W 5% 0 Ω

Cct Ref	Parts Number	Description
R1009	D0GAR00J0005	SMD .063W 5% 0 Ω
R1010	D0GAR00J0005	SMD .063W 5% 0 Ω
R1011	D0GAR00J0005	SMD .063W 5% 0 Ω
R1012	D0GAR00J0005	SMD .063W 5% 0 Ω
R1101	D0GA331JA023	SMD .063W 5% 330 Ω
R1102	D1BB7151A055	SMD 0.1W 1% 7K15 Ω
R1105	D0GA102JA023	SMD .063W 5% 1K Ω
R1106	D0GA182JA023	SMD .063W 5% 1K8 Ω
R1108	D0GA102JA023	SMD .063W 5% 1K Ω
R1111	D0GA472JA023	SMD .063W 5% 4K7 Ω
R1300	D0GA103JA015	SMD .063W 5% 10K Ω
R1301	D0GA103JA015	SMD .063W 5% 10K Ω
R1302	D0GA103JA015	SMD .063W 5% 10K Ω
R2001	D0GAR00J0005	SMD .063W 5% 0 Ω
R2002	D0GAR00J0005	SMD .063W 5% 0 Ω
R2008	D0GA473JA015	SMD .063W 5% 47K Ω
R2014	D0GA101JA015	SMD .063W 5% 100 Ω
R2015	D0GAR00J0005	SMD .063W 5% 0 Ω
R2016	D0GAR00J0005	SMD .063W 5% 0 Ω
R2017	D0GAR00J0005	SMD .063W 5% 0 Ω
R2018	D0GAR00J0005	SMD .063W 5% 0 Ω
R2019	D0GAR00J0005	SMD .063W 5% 0 Ω
R2035	D0GDR00J0004	SMD .125W 5% 0 Ω
R2045	D0GAR00J0005	SMD .063W 5% 0 Ω
R2046	D0GDR00J0004	SMD .125W 5% 0 Ω
R2047	D0GAR00J0005	SMD .063W 5% 0 Ω
R2048	D0GAR00J0005	SMD .063W 5% 0 Ω
R2052	D0GAR00J0005	SMD .063W 5% 0 Ω
R2800	D1BA9530A014	SMD .063W 1% 953 Ω
R2801	D0GA473JA015	SMD .063W 5% 47K Ω
R2802	D0GA223JA023	SMD .063W 5% 22K Ω
R2803	D0GA473JA015	SMD .063W 5% 47K Ω
R2804	D0GA103JA015	SMD .063W 5% 10K Ω
R2805	D1BA2261A014	SMD .063W 1% 2K26 Ω
R2806	D0GA470JA023	SMD .063W 5% 47 Ω
R2807	D0GA562JA023	SMD .063W 5% 5K6 Ω
R2808	D0GA184JA023	SMD .063W 5% 180K Ω
R2809	D0GA103JA015	SMD .063W 5% 10K Ω
R2810	D0GA104JA023	SMD .063W 5% 100K Ω
R2811	D0GA103JA015	SMD .063W 5% 10K Ω
R2826	D0GAR00J0005	SMD .063W 5% 0 Ω
R2851	D0GAR00J0005	SMD .063W 5% 0 Ω
R3001	D0GA102JA023	SMD .063W 5% 1K Ω
R3002	D0GA122JA023	SMD .063W 5% 1K2 Ω
R3030	D0GA101JA015	SMD .063W 5% 100 Ω
R3052	D0GA221JA023	SMD .063W 5% 220 Ω
R3101	D0GA472JA023	SMD .063W 5% 4K7 Ω
R3102	D0GA472JA023	SMD .063W 5% 4K7 Ω
R3103	D1BD75R0A066	SMD .125W 1% 75 Ω
R3104	D1BD75R0A066	SMD .125W 1% 75 Ω
R3105	D1BD75R0A066	SMD .125W 1% 75 Ω
R3121	D0GA221JA023	SMD .063W 5% 220 Ω
R3123	EXB28V680JX	SMD .031W 5% 68 Ω
R3127	D0GA680JA023	SMD .063W 5% 68 Ω
R3129	D0GA104JA023	SMD .063W 5% 100K Ω
R3137	D1BD75R0A066	SMD .125W 1% 75 Ω
R3141	D1BF75R0A011	SMD 0.25W 1% 75 Ω
R3142	D1BF75R0A011	SMD 0.25W 1% 75 Ω
R3143	D1BF75R0A011	SMD 0.25W 1% 75 Ω
R3147	D1BF75R0A011	SMD 0.25W 1% 75 Ω
R3150	D0GA221JA023	SMD .063W 5% 220 Ω
R3157	EXB28V221JX	SMD .031W 5% 220 Ω
R3163	D0GA104JA023	SMD .063W 5% 100K Ω
R3164	D0GA104JA023	SMD .063W 5% 100K Ω
R3167	D0GA333JA023	SMD .063W 5% 33K Ω
R3168	D0GA333JA023	SMD .063W 5% 33K Ω
R3171	D0GA101JA015	SMD .063W 5% 100 Ω
R3172	D0GA101JA015	SMD .063W 5% 100 Ω

Cct Ref	Parts Number	Description			
R3173	D0GA221JA023	SMD	.063W	5%	220 Ω
R3174	D0GA221JA023	SMD	.063W	5%	220 Ω
R3175	D0GA221JA023	SMD	.063W	5%	220 Ω
R3179	D0GA331JA023	SMD	.063W	5%	330 Ω
R3180	D0GA331JA023	SMD	.063W	5%	330 Ω
R3181	D1BD75R0A066	SMD	.125W	1%	75 Ω
R3182	D1BD75R0A066	SMD	.125W	1%	75 Ω
R3183	D1BD75R0A066	SMD	.125W	1%	75 Ω
R3184	D0GA104JA023	SMD	.063W	5%	100K Ω
R3185	D0GA104JA023	SMD	.063W	5%	100K Ω
R3186	D0GA333JA023	SMD	.063W	5%	33K Ω
R3187	D0GA333JA023	SMD	.063W	5%	33K Ω
R3188	D0GA221JA023	SMD	.063W	5%	220 Ω
R3189	D0GA221JA023	SMD	.063W	5%	220 Ω
R3190	D0GA101JA015	SMD	.063W	5%	100 Ω
R3191	D0GA101JA015	SMD	.063W	5%	100 Ω
R3192	EXB28V820JX	SMD	OTHER	5%	82 Ω
R3194	D0GA331JA023	SMD	.063W	5%	330 Ω
R3195	D0GA331JA023	SMD	.063W	5%	330 Ω
R3198	D0GA680JA023	SMD	.063W	5%	68 Ω
R3202	D1BF75R0A011	SMD	0.25W	1%	75 Ω
R3204	D1BA2152A014	SMD	.063W	1%	21K5 Ω
R3206	D1BA1302A014	SMD	.063W	1%	13K Ω
R3208	D0GA273JA023	SMD	.063W	5%	27K Ω
R3212	D0GA680JA023	SMD	.063W	5%	68 Ω
R3221	D1BF75R0A011	SMD	0.25W	1%	75 Ω
R3361	D0GA473JA015	SMD	.063W	5%	47K Ω
R3362	D0GAR00J0005	SMD	.063W	5%	0 Ω
R3900	D0GA103JA015	SMD	.063W	5%	10K Ω
R3901	D0GA103JA015	SMD	.063W	5%	10K Ω
R4042	EXB28VR000X	SMD	0W	-	0 Ω
R4043	EXB28VR000X	SMD	0W	-	0 Ω
R4044	EXB28VR000X	SMD	0W	-	0 Ω
R4045	EXB28VR000X	SMD	0W	-	0 Ω
R4046	EXB28VR000X	SMD	0W	-	0 Ω
R4047	EXB28VR000X	SMD	0W	-	0 Ω
R4081	D0GA101JA015	SMD	.063W	5%	100 Ω
R4082	D0GA101JA015	SMD	.063W	5%	100 Ω
R4107	D0GA473JA015	SMD	.063W	5%	47K Ω
R4108	D0GAR00J0005	SMD	.063W	5%	0 Ω
R4548	D0GA220JA023	SMD	.063W	5%	22 Ω
R4549	D0GA151JA023	SMD	.063W	5%	150 Ω
R4550	D0GA151JA023	SMD	.063W	5%	150 Ω
R4551	D0GA151JA023	SMD	.063W	5%	150 Ω
R4552	D0GA560JA023	SMD	.063W	5%	56 Ω
R4553	D0GA103JA015	SMD	.063W	5%	10K Ω
R4554	D0GA102JA023	SMD	.063W	5%	1K Ω
R4556	D0GA103JA015	SMD	.063W	5%	10K Ω
R4557	D0GAR00J0005	SMD	.063W	5%	0 Ω
R4560	D0GA473JA015	SMD	.063W	5%	47K Ω
R4702	D0GA103JA015	SMD	.063W	5%	10K Ω
R4703	D0GA330JA023	SMD	.063W	5%	33 Ω
R4708	D0GA103JA015	SMD	.063W	5%	10K Ω
R4709	D0GA103JA015	SMD	.063W	5%	10K Ω
R4710	D0GA473JA015	SMD	.063W	5%	47K Ω
R4711	D0GA102JA023	SMD	.063W	5%	1K Ω
R4712	D0GA473JA015	SMD	.063W	5%	47K Ω
R4715	D0GA103JA015	SMD	.063W	5%	10K Ω
R4716	D0GA330JA023	SMD	.063W	5%	33 Ω
R4721	D0GA103JA015	SMD	.063W	5%	10K Ω
R4722	D0GA103JA015	SMD	.063W	5%	10K Ω
R4723	D0GA473JA015	SMD	.063W	5%	47K Ω
R4724	D0GA102JA023	SMD	.063W	5%	1K Ω
R4725	D0GA473JA015	SMD	.063W	5%	47K Ω
R4728	D0GA103JA015	SMD	.063W	5%	10K Ω
R4729	D0GA330JA023	SMD	.063W	5%	33 Ω
R4734	D0GA103JA015	SMD	.063W	5%	10K Ω
R4735	D0GA103JA015	SMD	.063W	5%	10K Ω

Cct Ref	Parts Number	Description			
R4736	D0GA473JA015	SMD	.063W	5%	47K Ω
R4737	D0GA102JA023	SMD	.063W	5%	1K Ω
R4738	D0GA473JA015	SMD	.063W	5%	47K Ω
R4739	D0GA220JA023	SMD	.063W	5%	22 Ω
R4744	D0GA680JA023	SMD	.063W	5%	68 Ω
R4745	D0GA680JA023	SMD	.063W	5%	68 Ω
R4746	D0GA680JA023	SMD	.063W	5%	68 Ω
R4747	D0GA680JA023	SMD	.063W	5%	68 Ω
R4748	D0GA680JA023	SMD	.063W	5%	68 Ω
R4749	D0GA680JA023	SMD	.063W	5%	68 Ω
R4750	D0GA680JA023	SMD	.063W	5%	68 Ω
R4751	D0GA680JA023	SMD	.063W	5%	68 Ω
R4763	D0GA473JA015	SMD	.063W	5%	47K Ω
R4764	D0GA473JA015	SMD	.063W	5%	47K Ω
R4765	D0GA473JA015	SMD	.063W	5%	47K Ω
R4766	D0GA473JA015	SMD	.063W	5%	47K Ω
R4767	D0GA392JA023	SMD	.063W	5%	3K9 Ω
R4770	D0GA473JA015	SMD	.063W	5%	47K Ω
R4771	D0GA152JA023	SMD	.063W	5%	1K5 Ω
R4772	D0GA152JA023	SMD	.063W	5%	1K5 Ω
R4774	D0GA473JA015	SMD	.063W	5%	47K Ω
R4775	D0GA473JA015	SMD	.063W	5%	47K Ω
R4776	D0GA680JA023	SMD	.063W	5%	68 Ω
R4777	D0GA680JA023	SMD	.063W	5%	68 Ω
R4780	D0GA121JA023	SMD	.063W	5%	120 Ω
R4788	D0GA103JA015	SMD	.063W	5%	10K Ω
R4789	D0GA330JA023	SMD	.063W	5%	33 Ω
R4794	D0GA103JA015	SMD	.063W	5%	10K Ω
R4795	D0GA103JA015	SMD	.063W	5%	10K Ω
R4796	D0GA473JA015	SMD	.063W	5%	47K Ω
R4797	D0GA102JA023	SMD	.063W	5%	1K Ω
R4798	D0GA473JA015	SMD	.063W	5%	47K Ω
R4799	D0GA273JA023	SMD	.063W	5%	27K Ω
R4800	D0GA103JA015	SMD	.063W	5%	10K Ω
R4803	D0GA103JA015	SMD	.063W	5%	10K Ω
R4910	D0GA100JA023	SMD	.063W	5%	10 Ω
R4911	D0GA100JA023	SMD	.063W	5%	10 Ω
R4912	D0GA100JA023	SMD	.063W	5%	10 Ω
R4913	D0GA103JA015	SMD	.063W	5%	10K Ω
R4914	EXB28V220JX	SMD	.031W	5%	22 Ω
R4915	D0GF5R6JA020	SMD	0.25	5%	5R6 Ω
R4916	D0GF5R6JA020	SMD	0.25	5%	5R6 Ω
R4917	D0GF5R6JA020	SMD	0.25	5%	5R6 Ω
R4918	D0GF5R6JA020	SMD	0.25	5%	5R6 Ω
R4921	D0GA103JA015	SMD	.063W	5%	10K Ω
R4970	D1BB1403A055	SMD	0.1W	1%	140K Ω
R4971	D1BB1403A055	SMD	0.1W	1%	140K Ω
R4972	D0GA103JA015	SMD	.063W	5%	10K Ω
R4973	D0GA103JA015	SMD	.063W	5%	10K Ω
R4974	D0GF122JA048	SMD	0.1W	5%	1K2 Ω
R4978	D0GA101JA015	SMD	.063W	5%	100 Ω
R4979	D0GA101JA015	SMD	.063W	5%	100 Ω
R4984	D0GA473JA015	SMD	.063W	5%	47K Ω
R4985	D0GA103JA015	SMD	.063W	5%	10K Ω
R4986	D0GAR00J0005	SMD	.063W	5%	0 Ω
R4987	D0GF122JA048	SMD	0.1W	5%	1K2 Ω
R5002	D0GA683JA023	SMD	.063W	5%	68K Ω
R5003	D0GA103JA015	SMD	.063W	5%	10K Ω
R5006	D0GA563JA023	SMD	.063W	5%	56K Ω
R5007	D0GA223JA023	SMD	.063W	5%	22K Ω
R5009	D1BA5602A014	SMD	.063W	1%	56K Ω
R5012	D1BA2202A014	SMD	.063W	1%	22K Ω
R5030	D0GA103JA015	SMD	.063W	5%	10K Ω
R5100	D0GA101JA015	SMD	.063W	5%	100 Ω
R5104	D0GA103JA015	SMD	.063W	5%	10K Ω
R5152	D0GA222JA023	SMD	.063W	5%	2K2 Ω
R5174	D0GA103JA015	SMD	.063W	5%	10K Ω
R5175	D0GA680JA023	SMD	.063W	5%	68 Ω

Cct Ref	Parts Number	Description				
R5179	D0GA153JA023	SMD	.063W	5%	15K Ω	
R5180	D0GA683JA023	SMD	.063W	5%	68K Ω	
R5181	D0GA103JA015	SMD	.063W	5%	10K Ω	
R5182	D0GA104JA023	SMD	.063W	5%	100K Ω	
R5300	D0GD4R7JA059	SMD	0.25W	5%	4R7 Ω	
R5302	D1BB1102A055	SMD	0.1W	1%	11K Ω	
R5303	D1BB8200A055	SMD	0.1W	1%	820 Ω	
R5304	D0GA473JA015	SMD	.063W	5%	47K Ω	
R5306	D0GB472JA065	SMD	0.1W	5%	4K7 Ω	
R5400	D0GA390JA023	SMD	.063W	5%	39 Ω	
R5401	D1BB4301A055	SMD	0.1W	1%	4K3 Ω	
R5402	D1BB6041A055	SMD	0.1W	1%	6K04 Ω	
R5403	D1BB2402A055	SMD	0.1W	1%	24K Ω	
R5420	D0GA390JA023	SMD	.063W	5%	39 Ω	
R5421	D1BB5601A055	SMD	0.1W	1%	5K6 Ω	
R5422	D1BB3001A055	SMD	0.1W	1%	3K Ω	
R5423	D1BB2002A055	SMD	0.1W	1%	20K Ω	
R5441	D0GB332JA065	SMD	0.1W	5%	3K3 Ω	
R5442	D1BB7870A055	SMD	0.1W	1%	787 Ω	
R5443	D1BB4021A055	SMD	0.1W	1%	4K02 Ω	
R5444	D0GD4R7JA059	SMD	0.25W	5%	4R7 Ω	
R5448	D0GAR00J0005	SMD	.063W	5%	0 Ω	
R5449	D0GA103JA015	SMD	.063W	5%	10K Ω	
R5606	D0GA103JA015	SMD	.063W	5%	10K Ω	
R5607	D0GA103JA015	SMD	.063W	5%	10K Ω	
R5608	D0GA103JA015	SMD	.063W	5%	10K Ω	
R5609	D0GA103JA015	SMD	.063W	5%	10K Ω	
R5612	D0GA103JA015	SMD	.063W	5%	10K Ω	
R5613	D0GA103JA015	SMD	.063W	5%	10K Ω	
R5900	D0GB390JA065	SMD	0.1W	5%	39 Ω	
R5901	D1BB1002A055	SMD	0.1W	1%	10K Ω	
R5902	D1BB5362A055	SMD	0.1W	1%	53K6 Ω	
R5904	D1BB3002A055	SMD	0.1W	1%	30K Ω	
R5906	D1BA4642A014	SMD	.063W	1%	46K4 Ω	
R5909	D0GA102JA023	SMD	.063W	5%	1K Ω	
R5910	D0GA472JA023	SMD	.063W	5%	4K7 Ω	
R5911	D0GA472JA023	SMD	.063W	5%	4K7 Ω	
R5912	D0GA472JA023	SMD	.063W	5%	4K7 Ω	
R5913	D0GA472JA023	SMD	.063W	5%	4K7 Ω	
R5918	D0GA103JA015	SMD	.063W	5%	10K Ω	
R6775	EXB2HVR000V	SMD	0W	-	0 Ω	
R6777	D0GFR20JA020	SMD	0.25W	5%	R2 Ω	
R6778	D0GA101JA015	SMD	.063W	5%	100 Ω	
R6779	D0GA220JA023	SMD	.063W	5%	22 Ω	
R6790	EXB28VR000X	SMD	0W	-	0 Ω	
R6820	D0GB101JA065	SMD	0.1W	5%	100 Ω	
R6821	D1BA1002A014	SMD	.063W	1%	10K Ω	
R6822	D1BA2701A014	SMD	.063W	1%	2K7 Ω	
R6823	D0GA392JA023	SMD	.063W	5%	3K9 Ω	
R6824	EXB2HV680JV	SMD	.063W	5%	68 Ω	
R6825	EXB28V680JX	SMD	.031W	5%	68 Ω	
R6826	D0GF100JA048	SMD	0.1W	5%	10 Ω	
R6827	D0GF100JA048	SMD	0.1W	5%	10 Ω	
R6828	D1BA4700A014	SMD	.063W	1%	470 Ω	
R6829	D0GB2R2JA065	SMD	0.1W	5%	2R2 Ω	
R6943	D0GAR00J0005	SMD	.063W	5%	0 Ω	
R6955	D0GBR00J0004	SMD	0.1W	5%	0 Ω	
R6957	D0GBR00J0004	SMD	0.1W	5%	0 Ω	
R8008	D0GA331JA023	SMD	.063W	5%	330 Ω	
R8100	D1BB1271A087	SMD	0.1W	0.5	1K27 Ω	
R8102	D1BB2101A087	SMD	0.1W	0.5	2K1 Ω	
R8104	D1BB8200A087	SMD	0.1W	0.5	820 Ω	
R8106	D1BB2001A087	SMD	0.1W	0.5	2K Ω	
R8108	D0GB100JA065	SMD	0.1W	5%	10 Ω	
R8110	D0GB100JA065	SMD	0.1W	5%	10 Ω	
R8114	D0GA303JA023	SMD	.063W	5%	30K Ω	
R8118	D0GA183JA023	SMD	.063W	5%	18K Ω	
R8200	D1BA2400A014	SMD	.063W	1%	240 Ω	

Cct Ref	Parts Number	Description				
R8201	D1BA1001A014	SMD	.063W	1%	1K Ω	
R8202	D1BA1001A014	SMD	.063W	1%	1K Ω	
R8203	D1BA1001A014	SMD	.063W	1%	1K Ω	
R8204	D1BA1001A014	SMD	.063W	1%	1K Ω	
R8205	D1BA1001A014	SMD	.063W	1%	1K Ω	
R8206	D1BA1001A014	SMD	.063W	1%	1K Ω	
R8207	D1BA1001A014	SMD	.063W	1%	1K Ω	
R8208	D1BA1001A014	SMD	.063W	1%	1K Ω	
R8209	D0GA111JA023	SMD	.063W	5%	110 Ω	
R8210	D0GA111JA023	SMD	.063W	5%	110 Ω	
R8211	D1BA2400A014	SMD	.063W	1%	240 Ω	
R8212	D1BA2400A014	SMD	.063W	1%	240 Ω	
R8213	D0GA103JA015	SMD	.063W	5%	10K Ω	
R8214	D0GA103JA015	SMD	.063W	5%	10K Ω	
R8215	D1BA2400A014	SMD	.063W	1%	240 Ω	
R8216	D1BA1001A014	SMD	.063W	1%	1K Ω	
R8217	D1BA1001A014	SMD	.063W	1%	1K Ω	
R8218	EXB28V220JX	SMD	.031W	5%	22 Ω	
R8219	EXB28V220JX	SMD	.031W	5%	22 Ω	
R8220	EXB28V220JX	SMD	.031W	5%	22 Ω	
R8221	EXB28V220JX	SMD	.031W	5%	22 Ω	
R8222	EXB28V220JX	SMD	.031W	5%	22 Ω	
R8223	EXB28V220JX	SMD	.031W	5%	22 Ω	
R8224	EXB28V220JX	SMD	.031W	5%	22 Ω	
R8225	EXB28V220JX	SMD	.031W	5%	22 Ω	
R8226	EXB28V220JX	SMD	.031W	5%	22 Ω	
R8227	EXB28V220JX	SMD	.031W	5%	22 Ω	
R8228	EXB28V220JX	SMD	.031W	5%	22 Ω	
R8229	EXB28V220JX	SMD	.031W	5%	22 Ω	
R8230	D0GA220JA023	SMD	.063W	5%	22 Ω	
R8231	D0GA220JA023	SMD	.063W	5%	22 Ω	
R8232	D0GA220JA023	SMD	.063W	5%	22 Ω	
R8301	D0GA471JA023	SMD	.063W	5%	470 Ω	
R8302	D0GA360JA023	SMD	.063W	5%	36 Ω	
R8303	D0GA360JA023	SMD	.063W	5%	36 Ω	
R8304	D1BA6201A014	SMD	.063W	1%	6K2 Ω	
R8305	D1BA6201A014	SMD	.063W	1%	6K2 Ω	
R8307	D1BA6201A014	SMD	.063W	1%	6K2 Ω	
R8400	D0GA680JA023	SMD	.063W	5%	68 Ω	
R8401	D0GA680JA023	SMD	.063W	5%	68 Ω	
R8402	D0GA680JA023	SMD	.063W	5%	68 Ω	
R8403	D0GA680JA023	SMD	.063W	5%	68 Ω	
R8404	D0GA680JA023	SMD	.063W	5%	68 Ω	
R8405	D0GA680JA023	SMD	.063W	5%	68 Ω	
R8406	EXB2HV680JV	SMD	.063W	5%	68 Ω	
R8407	EXB2HV680JV	SMD	.063W	5%	68 Ω	
R8408	EXB2HV680JV	SMD	.063W	5%	68 Ω	
R8409	EXB28V680JX	SMD	.031W	5%	68 Ω	
R8410	EXB2HV680JV	SMD	.063W	5%	68 Ω	
R8411	EXB2HV680JV	SMD	.063W	5%	68 Ω	
R8418	D0GA103JA015	SMD	.063W	5%	10K Ω	
R8421	EXB2HV101JV	SMD	.063W	5%	100 Ω	
R8424	D0GA223JA023	SMD	.063W	5%	22K Ω	
R8425	D0GA223JA023	SMD	.063W	5%	22K Ω	
R8426	D0GA473JA015	SMD	.063W	5%	47K Ω	
R8427	D0GA473JA015	SMD	.063W	5%	47K Ω	
R8429	D0GA103JA015	SMD	.063W	5%	10K Ω	
R8433	D0GA103JA015	SMD	.063W	5%	10K Ω	
R8434	D0GA103JA015	SMD	.063W	5%	10K Ω	
R8435	D0GA223JA023	SMD	.063W	5%	22K Ω	
R8436	EXB2HV101JV	SMD	.063W	5%	100 Ω	
R8437	EXB2HV473JV	CHIP RES	.063W	5%	47K Ω	
R8438	EXB2HV103JV	SMD	.063W	5%	10K Ω	
R8440	D0GA103JA015	SMD	.063W	5%	10K Ω	
R8441	D0GA103JA015	SMD	.063W	5%	10K Ω	
R8442	D0GA103JA015	SMD	.063W	5%	10K Ω	
R8606	D0GA472JA023	SMD	.063W	5%	4K7 Ω	
R8607	D0GA472JA023	SMD	.063W	5%	4K7 Ω	

Cct Ref	Parts Number	Description			
R8608	D0GA102JA023	SMD	.063W	5%	1K Ω
R8609	D1BA6491A014	SMD	.063W	1%	6K49 Ω
R8610	D0GA221JA023	SMD	.063W	5%	220 Ω
R8611	D1BA49R9A014	SMD	.063W	1%	49R9 Ω
R8612	D1BA49R9A014	SMD	.063W	1%	49R9 Ω
R8613	D1BA49R9A014	SMD	.063W	1%	49R9 Ω
R8614	D1BA49R9A014	SMD	.063W	1%	49R9 Ω
R8615	D0GA105JA023	SMD	.063W	5%	1M Ω
R8624	D0GA560JA023	SMD	.063W	5%	56 Ω
R8625	D0GA560JA023	SMD	.063W	5%	56 Ω
R8626	D0GA560JA023	SMD	.063W	5%	56 Ω
R8627	D0GA560JA023	SMD	.063W	5%	56 Ω
R8628	D0GA560JA023	SMD	.063W	5%	56 Ω
R8629	D0GA820JA023	SMD	.063W	5%	82 Ω
R8630	D1HG1038A002	SMD	.063W	5%	10K Ω
R8634	EXB28V560JX	SMD	.031W	5%	56 Ω
R8636	D0GA220JA023	SMD	.063W	5%	22 Ω
R8645	D0GAR00J0005	SMD	.063W	5%	0 Ω
R8646	D0GAR00J0005	SMD	.063W	5%	0 Ω
R8648	D0GA273JA023	SMD	.063W	5%	27K Ω
R8649	D0GA101JA015	SMD	.063W	5%	100 Ω
R8650	D0GA101JA015	SMD	.063W	5%	100 Ω
R8651	D0GA101JA015	SMD	.063W	5%	100 Ω
R8652	D0GA101JA015	SMD	.063W	5%	100 Ω
R8653	D0GA101JA015	SMD	.063W	5%	100 Ω
R8654	D0GA101JA015	SMD	.063W	5%	100 Ω
R8655	D0GA101JA015	SMD	.063W	5%	100 Ω
R8656	D0GAR00J0005	SMD	.063W	5%	0 Ω
R8657	D0GA101JA015	SMD	.063W	5%	100 Ω
R8658	D0GA101JA015	SMD	.063W	5%	100 Ω
R8659	D0GA101JA015	SMD	.063W	5%	100 Ω
R8660	D0GA101JA015	SMD	.063W	5%	100 Ω
R8661	D0GA101JA015	SMD	.063W	5%	100 Ω
R8662	D0GA101JA015	SMD	.063W	5%	100 Ω
R8663	D0GA101JA015	SMD	.063W	5%	100 Ω
R8664	D0GA101JA015	SMD	.063W	5%	100 Ω
R8665	D0GA101JA015	SMD	.063W	5%	100 Ω
R8666	D0GA101JA015	SMD	.063W	5%	100 Ω
R8667	D0GA101JA015	SMD	.063W	5%	100 Ω
R8670	D0GA560JA023	SMD	.063W	5%	56 Ω
R8671	D0GA560JA023	SMD	.063W	5%	56 Ω
R8672	D0GA560JA023	SMD	.063W	5%	56 Ω
R8755	D0GA104JA023	SMD	.063W	5%	100K Ω
R8811	D0GA103JA015	SMD	.063W	5%	10K Ω
R8816	D0GA103JA015	SMD	.063W	5%	10K Ω
R8818	D0GA103JA015	SMD	.063W	5%	10K Ω
R8819	D0GA103JA015	SMD	.063W	5%	10K Ω
R8821	D0GA473JA015	SMD	.063W	5%	47K Ω
R8824	D0GA103JA015	SMD	.063W	5%	10K Ω
R8830	D0GA103JA015	SMD	.063W	5%	10K Ω
R8831	D0GA103JA015	SMD	.063W	5%	10K Ω
R8835	D0GA103JA015	SMD	.063W	5%	10K Ω
R8849	D0GA103JA015	SMD	.063W	5%	10K Ω
R8852	D0GA243JA023	SMD	.063W	5%	24K Ω
R8856	D0GA103JA015	SMD	.063W	5%	10K Ω
R8909	D0GA222JA023	SMD	.063W	5%	2K2 Ω
R8910	D0GA103JA015	SMD	.063W	5%	10K Ω
R8914	D0GA472JA023	SMD	.063W	5%	4K7 Ω
R8964	D0GA472JA023	SMD	.063W	5%	4K7 Ω
R9901	D0GAR00J0005	SMD	.063W	5%	0 Ω
CAPACITORS					
C053	F1G1E1030005	S.M.CAP	25V		10nF
C086	F1G1E1030005	S.M.CAP	25V		10nF
C1080	F1G1C104A077	S.M.CAP	16V		100nF
C1081	F1J1A106A087	S.M.CAP	10V		10μF
C1082	F2G1C470A022	ELECT	16V		47μF
C1101	F1G1E1030005	S.M.CAP	25V		10nF

Cct Ref	Parts Number	Description			
C1102	F1H1H104A970	S.M.CAP	50V		100nF
C2000	F1G1C104A077	S.M.CAP	16V		100nF
C2001	F1G1H1020008	S.M.CAP	50V		1nF
C2004	F1G1H1020008	S.M.CAP	50V		1nF
C2005	F1G1H1020008	S.M.CAP	50V		1nF
C2008	F1G1C104A077	S.M.CAP	16V		100nF
C2009	F1G1H1020008	S.M.CAP	50V		1nF
C2014	F1K1E106A136	S.M.CAP	25V		10μF
C2023	F1G1C104A077	S.M.CAP	16V		100nF
C2801	F2G0J470A019	ELECT	6.3V		47μF
C2802	F1G1C1030008	S.M.CAP	16V		10nF
C2805	F1H1C104A041	CERAMIC	16V		100nF
C2850	F1G1A473A032	S.M.CAP	10V		47nF
C2851	F1G1A473A032	S.M.CAP	10V		47nF
C2852	F1G1A473A032	S.M.CAP	10V		47nF
C2853	F1G1A473A032	S.M.CAP	10V		47nF
C3001	F1G1A105A047	S.M.CAP	10V		1000nF
C3002	F1G1A105A047	S.M.CAP	10V		1000nF
C3003	F1G1C104A077	S.M.CAP	16V		100nF
C3004	F1G1C104A077	S.M.CAP	16V		100nF
C3005	F1G1A105A047	S.M.CAP	10V		1000nF
C3006	F1G1A105A047	S.M.CAP	10V		1000nF
C3008	F1J1A106A087	S.M.CAP	10V		10μF
C3011	F1J1A106A087	S.M.CAP	10V		10μF
C3016	F1G1C104A077	S.M.CAP	16V		100nF
C3018	F1G1C104A077	S.M.CAP	16V		100nF
C3019	F1G1C104A077	S.M.CAP	16V		100nF
C3020	F1J1A106A043	S.M.CAP	10V		10μF
C3056	F1J1A106A087	S.M.CAP	10V		10μF
C3084	F1J1A106A043	S.M.CAP	10V		10μF
C3085	F1J1A106A043	S.M.CAP	10V		10μF
C3086	F1J1A106A043	S.M.CAP	10V		10μF
C3108	F1G1H5610004	S.M.CAP	50V		560pF
C3109	F1G1H5610004	S.M.CAP	50V		560pF
C3114	F1G1C333A081	S.M.CAP	16V		33nF
C3115	F1G1C333A081	S.M.CAP	16V		33nF
C3116	F1J1A106A087	S.M.CAP	10V		10μF
C3117	F1J1A106A087	S.M.CAP	10V		10μF
C3118	F1J1A106A087	S.M.CAP	10V		10μF
C3120	F2H1A101A040	ELECT	10V		100μF
C3121	F2H1A101A040	ELECT	10V		100μF
C3124	F1J1A106A087	S.M.CAP	10V		10μF
C3130	F1J1A106A087	S.M.CAP	10V		10μF
C3131	F1J1A106A087	S.M.CAP	10V		10μF
C3132	F1J1A106A087	S.M.CAP	10V		10μF
C3135	F1G1H5610004	S.M.CAP	50V		560pF
C3136	F1G1H5610004	S.M.CAP	50V		560pF
C3139	F1G1H5610004	S.M.CAP	50V		560pF
C3140	F1G1H5610004	S.M.CAP	50V		560pF
C3145	F1J1A106A087	S.M.CAP	10V		10μF
C3146	F1J1A106A087	S.M.CAP	10V		10μF
C3147	F1J1A106A087	S.M.CAP	10V		10μF
C3148	F1J1A106A087	S.M.CAP	10V		10μF
C3151	F1H1A105A025	S.M.CAP	10V		1μF
C3152	F1H1A105A025	S.M.CAP	10V		1μF
C3153	F1G1H5610004	S.M.CAP	50V		560pF
C3154	F1G1H5610004	S.M.CAP	50V		560pF
C3155	F1G1H5610004	S.M.CAP	50V		560pF
C3156	F1G1H5610004	S.M.CAP	50V		560pF
C3157	F1H1A105A025	S.M.CAP	10V		1μF
C3158	F1H1A105A025	S.M.CAP	10V		1μF
C3159	F1J1A106A087	S.M.CAP	10V		10μF
C3160	F1J1A106A087	S.M.CAP	10V		10μF
C3161	F1J1A106A087	S.M.CAP	10V		10μF
C3162	F1J1A106A087	S.M.CAP	10V		10μF
C3172	F1G1A105A047	S.M.CAP	10V		1000nF
C3173	F1G1A105A047	S.M.CAP	10V		1000nF
C3174	F1G1A105A047	S.M.CAP	10V		1000nF

Cct Ref	Parts Number	Description		
C3175	F1G1A105A047	S.M.CAP	10V	1000nF
C3178	F1J1A106A087	S.M.CAP	10V	10µF
C3179	F1J1A106A087	S.M.CAP	10V	10µF
C4089	F2G1C470A022	ELECT	16V	47µF
C4091	F1K1E106A136	S.M.CAP	25V	10µF
C4093	F1G1H1020008	S.M.CAP	50V	1nF
C4094	F1G1H1020008	S.M.CAP	50V	1nF
C4546	F1H0J1050013	CERAMIC	6.3V	1µF
C4547	F1H0J1050013	CERAMIC	6.3V	1µF
C4701	F1G1C104A077	S.M.CAP	16V	100nF
C4704	F1G1C104A077	S.M.CAP	16V	100nF
C4707	F1G1C104A077	S.M.CAP	16V	100nF
C4713	F1G1C104A077	S.M.CAP	16V	100nF
C4716	F1G1C104A077	S.M.CAP	16V	100nF
C4722	F1G1C104A077	S.M.CAP	16V	100nF
C4723	F1G1C104A077	S.M.CAP	16V	100nF
C4727	F1J1A106A087	S.M.CAP	10V	10µF
C4730	F1G1C104A077	S.M.CAP	16V	100nF
C4800	F1G1A105A047	S.M.CAP	10V	1000nF
C4801	F1G1A105A047	S.M.CAP	10V	1000nF
C4802	F1G1H220A565	S.M.CAP	50V	22pF
C4804	F1G1C104A077	S.M.CAP	16V	100nF
C4805	F1G1C104A077	S.M.CAP	16V	100nF
C4806	F1G1C104A077	S.M.CAP	16V	100nF
C4807	F1J1A106A043	S.M.CAP	10V	10µF
C4809	F1J1A106A043	S.M.CAP	10V	10µF
C4811	F1J1A106A043	S.M.CAP	10V	10µF
C4816	F1G1H220A565	S.M.CAP	50V	22pF
C4817	F1G1H220A565	S.M.CAP	50V	22pF
C4819	F1G1C104A077	S.M.CAP	16V	100nF
C4820	F1G1C104A077	S.M.CAP	16V	100nF
C4824	F1G1H220A565	S.M.CAP	50V	22pF
C4906	F1K1E106A136	S.M.CAP	25V	10µF
C4907	F1K1E106A136	S.M.CAP	25V	10µF
C4908	F1G1H1020008	S.M.CAP	50V	1nF
C4909	F1J1E105A231	S.M.CAP	25V	1µF
C4911	F1H1H104A970	S.M.CAP	50V	100nF
C4912	F1J1E105A231	S.M.CAP	25V	1µF
C4913	F1H1H104A970	S.M.CAP	50V	100nF
C4914	F1J1E105A231	S.M.CAP	25V	1µF
C4915	F1H1H104A970	S.M.CAP	50V	100nF
C4917	F1H1H104A970	S.M.CAP	50V	100nF
C4918	F1J1E105A231	S.M.CAP	25V	1µF
C4919	F1G1H1020008	S.M.CAP	50V	1nF
C4921	F1J1E4740001	S.M.CAP	25V	470nF
C4922	F1J1E4740001	S.M.CAP	25V	470nF
C4924	F1J1E4740001	S.M.CAP	25V	470nF
C4925	F1J1E4740001	S.M.CAP	25V	470nF
C4926	F1H1H222A219	S.M.CAP	50V	2.2nF
C4927	F1H1H222A219	S.M.CAP	50V	2.2nF
C4928	F1H1H222A219	S.M.CAP	50V	2.2nF
C4929	F1H1H222A219	S.M.CAP	50V	2.2nF
C4930	F1H1H222A219	S.M.CAP	50V	2.2nF
C4931	F1H1H222A219	S.M.CAP	50V	2.2nF
C4932	F1H1H222A219	S.M.CAP	50V	2.2nF
C4933	F1H1H222A219	S.M.CAP	50V	2.2nF
C4938	F1K1E106A136	S.M.CAP	25V	10µF
C4939	F1K1E106A136	S.M.CAP	25V	10µF
C4970	F1J1A106A087	S.M.CAP	10V	10µF
C4971	F1J1A106A087	S.M.CAP	10V	10µF
C4972	F2H1A101A040	ELECT	10V	100µF
C4973	F2H1A101A040	ELECT	10V	100µF
C5000	F1H1A105A025	S.M.CAP	10V	1µF
C5001	F2H0J1010009	ELECT	6.3V	100µF
C5002	F1H1A105A025	S.M.CAP	10V	1µF
C5004	F1H1A105A025	S.M.CAP	10V	1µF
C5006	F1J1E105A231	S.M.CAP	25V	1µF
C5012	F1H1A105A025	S.M.CAP	10V	1µF

Cct Ref	Parts Number	Description		
C5020	F1G1C104A077	S.M.CAP	16V	100nF
C5021	F1G1A105A047	S.M.CAP	10V	1000nF
C5022	F1G1A105A047	S.M.CAP	10V	1000nF
C5026	F1H1C105A145	S.M.CAP	16V	1000nF
C5151	F1H1H103A219	CERAMIC	50V	10nF
C5171	F1G1C1030008	S.M.CAP	16V	10nF
C5240	F1H1A105A025	S.M.CAP	10V	1µF
C5243	F1H1A105A025	S.M.CAP	10V	1µF
C5300	F1G1H821A459	S.M.CAP	50V	820pF
C5301	F1K1E106A136	S.M.CAP	25V	10µF
C5302	F1K1E106A136	S.M.CAP	25V	10µF
C5303	F1K1E106A136	S.M.CAP	25V	10µF
C5304	F1K1E106A136	S.M.CAP	25V	10µF
C5305	F1K1E106A136	S.M.CAP	25V	10µF
C5306	F1K1E106A136	S.M.CAP	25V	10µF
C5310	F1G1H472A571	S.M.CAP	50V	4.7nF
C5400	F1K1E106A136	S.M.CAP	25V	10µF
C5401	F1K1E106A136	S.M.CAP	25V	10µF
C5402	F1G1E1030005	S.M.CAP	25V	10nF
C5403	F1J1A106A087	S.M.CAP	10V	10µF
C5404	F1J1A106A087	S.M.CAP	10V	10µF
C5405	F1J1A106A087	S.M.CAP	10V	10µF
C5406	F1J1A106A087	S.M.CAP	10V	10µF
C5407	F1G1C223A081	S.M.CAP	16V	22nF
C5408	F1G1E1030005	S.M.CAP	25V	10nF
C5420	F1K1E106A136	S.M.CAP	25V	10µF
C5421	F1K1E106A136	S.M.CAP	25V	10µF
C5422	F1G1E1030005	S.M.CAP	25V	10nF
C5423	F1J1A106A087	S.M.CAP	10V	10µF
C5424	F1J1A106A087	S.M.CAP	10V	10µF
C5425	F1J1A106A087	S.M.CAP	10V	10µF
C5426	F1J1A106A087	S.M.CAP	10V	10µF
C5427	F1G1C223A081	S.M.CAP	16V	22nF
C5428	F1G1H272A571	S.M.CAP	50V	2.7nF
C5440	F1K1E106A136	S.M.CAP	25V	10µF
C5441	F1K1E106A136	S.M.CAP	25V	10µF
C5443	F1J1A106A043	S.M.CAP	10V	10µF
C5444	F1J1A106A043	S.M.CAP	10V	10µF
C5445	F1J1A106A043	S.M.CAP	10V	10µF
C5448	F1G1H103A509	S.M.CAP	50V	10nF
C5451	F1G1H821A459	S.M.CAP	50V	820pF
C5613	F2H0J2210005	ELECT	6.3V	220µF
C5616	F1G1C104A077	S.M.CAP	16V	100nF
C5618	F2H0J2210005	ELECT	6.3V	220µF
C5621	F1G1C104A077	S.M.CAP	16V	100nF
C5622	F1J1A106A087	S.M.CAP	10V	10µF
C5623	F1G1C104A077	S.M.CAP	16V	100nF
C5624	F1J1A106A087	S.M.CAP	10V	10µF
C5625	F1G1C104A077	S.M.CAP	16V	100nF
C5627	F2H0J2210005	ELECT	6.3V	220µF
C5630	F1G1C104A077	S.M.CAP	16V	100nF
C5631	F1J1A106A087	S.M.CAP	10V	10µF
C5632	F1G1C104A077	S.M.CAP	16V	100nF
C5900	F1J1A106A043	S.M.CAP	10V	10µF
C5901	F1J1A106A043	S.M.CAP	10V	10µF
C5902	F1J1A106A043	S.M.CAP	10V	10µF
C5905	F1G1C223A081	S.M.CAP	16V	22nF
C5906	F1K1E106A136	S.M.CAP	25V	10µF
C5908	F1G1A333A032	S.M.CAP	10V	33nF
C5909	F1G1H1020008	S.M.CAP	50V	1nF
C5911	F1J1A106A043	S.M.CAP	10V	10µF
C5912	F1G1E472A086	S.M.CAP	25V	4.7nF
C5913	F1G1A473A032	S.M.CAP	10V	47nF
C5915	F1G1A473A032	S.M.CAP	10V	47nF
C5917	F1G1A473A032	S.M.CAP	10V	47nF
C5919	F1G1A473A032	S.M.CAP	10V	47nF
C5921	F1H1A105A025	S.M.CAP	10V	1µF
C6776	F1J1A106A087	S.M.CAP	10V	10µF

Cct Ref	Parts Number	Description		
C6778	F1J1A106A087	S.M.CAP	10V	10µF
C6780	F1J1A106A087	S.M.CAP	10V	10µF
C6781	F1J1E105A171	S.M.CAP	25V	1µF
C6783	F1H1A105A025	S.M.CAP	10V	1µF
C6785	F1G1H152A571	S.M.CAP	50V	1500pF
C6786	F1H1H473A918	S.M.CAP	50V	47nF
C6787	F1G1C104A077	S.M.CAP	16V	100nF
C6788	F1J1E2240015	S.M.CAP	25V	220nF
C6789	F2G1E1010028	ELECT	25V	100µF
C6790	F2G1E1010028	ELECT	25V	100µF
C6791	F1G1H471A731	S.M.CAP	50V	470pF
C6792	F1K1E106A136	S.M.CAP	25V	10µF
C6793	F1K1E106A136	S.M.CAP	25V	10µF
C6820	F1G1H103A509	S.M.CAP	50V	10nF
C6821	F1H1E104A029	S.M.CAP	25V	100nF
C6822	F1J1A106A043	S.M.CAP	10V	10µF
C6823	F1J1A106A043	S.M.CAP	10V	10µF
C6824	F1J1A106A043	S.M.CAP	10V	10µF
C6825	F1J1A106A043	S.M.CAP	10V	10µF
C6826	F1G1E153A103	S.M.CAP	25V	15nF
C6827	F1G1E392A123	S.M.CAP	25V	3.9nF
C6828	F1K1E106A136	S.M.CAP	25V	10µF
C6829	F1K1E106A136	S.M.CAP	25V	10µF
C6830	F1H1H102A831	S.M.CAP	50V	1nF
C8001	F1G1C104A077	S.M.CAP	16V	100nF
C8002	F1J1A106A087	S.M.CAP	10V	10µF
C8003	F1G1C104A077	S.M.CAP	16V	100nF
C8004	F1G1C104A077	S.M.CAP	16V	100nF
C8005	F1G1C104A077	S.M.CAP	16V	100nF
C8006	F1G1C104A077	S.M.CAP	16V	100nF
C8007	F1G1C104A077	S.M.CAP	16V	100nF
C8008	F1G1C104A077	S.M.CAP	16V	100nF
C8009	F1J1A106A087	S.M.CAP	10V	10µF
C8011	F1G1C104A077	S.M.CAP	16V	100nF
C8013	F1G1C104A077	S.M.CAP	16V	100nF
C8014	F1G1C104A077	S.M.CAP	16V	100nF
C8015	F1G1C104A077	S.M.CAP	16V	100nF
C8016	F1G1C104A077	S.M.CAP	16V	100nF
C8017	F1J1A106A087	S.M.CAP	10V	10µF
C8018	F1G1C104A077	S.M.CAP	16V	100nF
C8019	F1G1C104A077	S.M.CAP	16V	100nF
C8020	F1G1C104A077	S.M.CAP	16V	100nF
C8021	F1G1C104A077	S.M.CAP	16V	100nF
C8022	F1J1A106A087	S.M.CAP	10V	10µF
C8023	F1J1A106A087	S.M.CAP	10V	10µF
C8024	F1J0G2260001	S.M.CAP	4V	22µF
C8026	F1G1C104A077	S.M.CAP	16V	100nF
C8027	F1G1C104A077	S.M.CAP	16V	100nF
C8028	F1G1C104A077	S.M.CAP	16V	100nF
C8030	F1G1C104A077	S.M.CAP	16V	100nF
C8032	F1G1C104A077	S.M.CAP	16V	100nF
C8036	F1G1C104A077	S.M.CAP	16V	100nF
C8039	F1G1C104A077	S.M.CAP	16V	100nF
C8041	F1G1H1020008	S.M.CAP	50V	1nF
C8042	F1G1C104A077	S.M.CAP	16V	100nF
C8043	F1G1C104A077	S.M.CAP	16V	100nF
C8044	F1G1C104A077	S.M.CAP	16V	100nF
C8045	F1G1C104A077	S.M.CAP	16V	100nF
C8047	F1G1C104A077	S.M.CAP	16V	100nF
C8048	F1G1C104A077	S.M.CAP	16V	100nF
C8049	F1J1A106A087	S.M.CAP	10V	10µF
C8050	F1G1C104A077	S.M.CAP	16V	100nF
C8051	F1J1A106A087	S.M.CAP	10V	10µF
C8052	F1G1C104A077	S.M.CAP	16V	100nF
C8053	F1G1C104A077	S.M.CAP	16V	100nF
C8054	F1G1C104A077	S.M.CAP	16V	100nF
C8055	F1G1C104A077	S.M.CAP	16V	100nF
C8056	F1G1C104A077	S.M.CAP	16V	100nF

Cct Ref	Parts Number	Description		
C8057	F1G1C104A077	S.M.CAP	16V	100nF
C8100	F1G1E682A123	S.M.CAP	25V	6.8nF
C8102	F1J1A475A087	S.M.CAP	10V	4.7µF
C8104	F1H1C105A145	S.M.CAP	16V	1000nF
C8106	F1G1C223A081	S.M.CAP	16V	22nF
C8108	F1G1C104A077	S.M.CAP	16V	100nF
C8110	F1G1C104A077	S.M.CAP	16V	100nF
C8112	F1K1E106A136	S.M.CAP	25V	10µF
C8114	F1K1E106A136	S.M.CAP	25V	10µF
C8116	F1K1E106A136	S.M.CAP	25V	10µF
C8118	F1K1E106A136	S.M.CAP	25V	10µF
C8120	F1J0G2260001	S.M.CAP	4V	22µF
C8122	F1J0G2260001	S.M.CAP	4V	22µF
C8124	F1J0G2260001	S.M.CAP	4V	22µF
C8126	F1J0G2260001	S.M.CAP	4V	22µF
C8128	F1J0G2260001	S.M.CAP	4V	22µF
C8200	F1G1C104A077	S.M.CAP	16V	100nF
C8201	F1G1C104A077	S.M.CAP	16V	100nF
C8202	F1G1C104A077	S.M.CAP	16V	100nF
C8203	F1G1C104A077	S.M.CAP	16V	100nF
C8204	F1G1C104A077	S.M.CAP	16V	100nF
C8205	F1J1A106A087	S.M.CAP	10V	10µF
C8206	F1G1C104A077	S.M.CAP	16V	100nF
C8208	F1G1C104A077	S.M.CAP	16V	100nF
C8210	F1G1C104A077	S.M.CAP	16V	100nF
C8213	F1G1C104A077	S.M.CAP	16V	100nF
C8214	F1J1A106A087	S.M.CAP	10V	10µF
C8216	F1G1C104A077	S.M.CAP	16V	100nF
C8218	F1G1C104A077	S.M.CAP	16V	100nF
C8219	F1G1C104A077	S.M.CAP	16V	100nF
C8222	F1G1C104A077	S.M.CAP	16V	100nF
C8223	F1G1C104A077	S.M.CAP	16V	100nF
C8224	F1G1C104A077	S.M.CAP	16V	100nF
C8225	F1G1C104A077	S.M.CAP	16V	100nF
C8226	F1G1C104A077	S.M.CAP	16V	100nF
C8227	F1G1C104A077	S.M.CAP	16V	100nF
C8300	F1G1H9R0A732	S.M.CAP	50V	9pF
C8301	F1G1H8R0A732	S.M.CAP	50V	8pF
C8302	F1G1C104A077	S.M.CAP	16V	100nF
C8303	F1G1C104A077	S.M.CAP	16V	100nF
C8304	F1G1C104A077	S.M.CAP	16V	100nF
C8305	F1G1A105A047	S.M.CAP	10V	1000nF
C8306	F1G1A105A047	S.M.CAP	10V	1000nF
C8307	F1G1A105A047	S.M.CAP	10V	1000nF
C8308	F1G1A105A047	S.M.CAP	10V	1000nF
C8309	F1G1A105A047	S.M.CAP	10V	1000nF
C8310	F1G1A105A047	S.M.CAP	10V	1000nF
C8311	F1G1A105A047	S.M.CAP	10V	1000nF
C8401	F1G1C104A077	S.M.CAP	16V	100nF
C8402	F1K0J226A049	S.M.CAP	6.3V	22µF
C8403	F1K0J226A049	S.M.CAP	6.3V	22µF
C8406	F1G1C104A077	S.M.CAP	16V	100nF
C8407	F1G1C104A077	S.M.CAP	16V	100nF
C8411	F1G1C104A077	S.M.CAP	16V	100nF
C8602	F1G1H390A565	S.M.CAP	50V	39pF
C8603	F1J1A106A087	S.M.CAP	10V	10µF
C8604	F1G1C104A077	S.M.CAP	16V	100nF
C8605	F1G1C104A077	S.M.CAP	16V	100nF
C8606	F1G1H101A565	S.M.CAP	50V	100pF
C8607	F1G1H100A565	S.M.CAP	50V	10pF
C8608	F1G1H100A565	S.M.CAP	50V	10pF
C8609	F1G1C104A077	S.M.CAP	16V	100nF
C8610	F1G1C104A077	S.M.CAP	16V	100nF
C8611	F1G1C104A077	S.M.CAP	16V	100nF
C8612	F1G1C104A077	S.M.CAP	16V	100nF
C8613	F1G1C104A077	S.M.CAP	16V	100nF
C8614	F1G1C104A077	S.M.CAP	16V	100nF
C8615	F1J1A106A087	S.M.CAP	10V	10µF

Cct Ref	Parts Number	Description		
C8616	F1J1A106A087	S.M.CAP	10V	10µF
C8617	F1G1C1030008	S.M.CAP	16V	10nF
C8618	F1J1A106A087	S.M.CAP	10V	10µF
C8619	F1G1C104A077	S.M.CAP	16V	100nF
C8620	F1G1C104A077	S.M.CAP	16V	100nF
C8621	F1G1H100A565	S.M.CAP	50V	10pF
C8622	F1G1H100A565	S.M.CAP	50V	10pF
C8624	F1G1H100A565	S.M.CAP	50V	10pF
C8625	F1G1H100A565	S.M.CAP	50V	10pF
C8626	F1G1H100A565	S.M.CAP	50V	10pF
C8629	F1G1H390A565	S.M.CAP	50V	39pF
C8630	F1G1H220A565	S.M.CAP	50V	22pF
C8714	F1J1A475A087	S.M.CAP	10V	4.7µF
C8715	F1J1A106A087	S.M.CAP	10V	10µF
C8716	F1G1C104A077	S.M.CAP	16V	100nF
C8717	F1G1C104A077	S.M.CAP	16V	100nF
C8724	F1J1A475A087	S.M.CAP	10V	4.7µF
C8725	F1J1A475A087	S.M.CAP	10V	4.7µF
C8764	F1J1A475A087	S.M.CAP	10V	4.7µF
C8765	F1J1A475A087	S.M.CAP	10V	4.7µF
C8900	F1G1C104A077	S.M.CAP	16V	100nF
C8901	F1G1C104A077	S.M.CAP	16V	100nF
C8902	F1G1C104A077	S.M.CAP	16V	100nF
C8903	F1G1C104A077	S.M.CAP	16V	100nF

TERMINALS AND LINKS

A02	K1KY15BA0324	15P CONNECTOR
A10	K1KY10AA0719	10P CONNECTOR
A12	K1KA04BA0055	4P CONNECTOR
A15	K1MY51B00004	51P CONNECTOR
A16	K1KY08AA0719	8P CONNECTOR
A30	K1KY09AA0719	9P CONNECTOR
CN0100	K1KA14A00248	14P CONNECTOR
D1006	K7AAAY000011	OPTICAL LINK
JK1001	K1U811A00005	YUV,VIDEO IN,AUDIO I/O
JK1003	K1FY121A0012	SCART TERMINAL
JK1005	K1FY315A0009	PC TERMINAL
JK1020	K1FY119D0015	HDMI TERMINAL
JK1021	K1FY119D0015	HDMI TERMINAL
JK1022	K1FY119D0015	HDMI TERMINAL
JK1030	K1FY104A0020	USB TERMINAL
JK1031	K1FY104A0020	USB TERMINAL
JK1040	K2LC1YYA0016	ETHERNET TERMINAL
JK1051	K2HC1YYB0063	HP TERMINAL
JK1061	K1FY119E0026	HDMI TERMINAL
JK1070	K1NA68B00057	CI SLOT
JK1080	K1NA09E00121	SD SLOT
JK1090	K1FY104E0009	USB TERMINAL
KA10	K1KA07B00135	7P CONNECTOR
S10	K1KA03BA0061	3P CONNECTOR
V30	K1KA08A00506	8P CONNECTOR

SWITCHES

SW2890	K0F126A00003	SWITCH
--------	--------------	--------

DIFFERENCES FOR MODEL TX--L32DT30E

EXPLODED VIEW

24	A-L32DT30E	A P.C.B.	X	RTL	⚠
25	K2CQ2YY00087	AC CORD			⚠
26	TKU5ZX03101	BACK COVER			
27	TXFKR5Z0022	CABINET ASSY			
28	VVX32F105G00	LCD PANEL			⚠
29	TBM0E2554	MODEL LABEL			⚠
30	TBL5ZX0105	PACKED STAND ASSY			⚠
31	L0AZ14C00005	SPEAKER UNIT_L			
32	L0AZ14C00006	SPEAKER UNIT_R			

Cct Ref	Parts Number	Description
MISCELLANEOUS COMPONENTS		
.	TMK0EG046	SPONGE
BOTCUS	TPD0E2183	BOTTOM CUSHION
CARTON	TPC0EA07001	CARTON
TOPCUS	TPD0E1178	TOP CUSHION

I.C.s

IC8901	STML32DT30E	EEPROM STM
IC8902	X24CL32DT30E	EEPROM LDA3

TERMINALS AND LINKS

A02-P02	TXJA02NZUE	A02-P02 WIRE
A10-S10-	TXJA10NZUE	A10-S10-KA10 WIRE
A12-SPK	TXJA12NZUE	A12-SPK WIRE
A15-CN70	TSXM398	LVDS FFC
A16-CN70	TXJA16NZUE	A16-TCON WIRE
A30-V30	TXJA30NZUE	A30-V30 WIRE
P4-CN901	TXJ/P4NZUE	P4-TCON WIRE

DIFFERENCES FOR MODEL TX--L37DT30E

EXPLODED VIEW

24	A-L37DT30E	A P.C.B.	X	RTL	⚠
25	K2CQ2YY00088	AC CORD			⚠
26	TKU5ZX02901	BACK COVER			
27	TXFKR5Z0020	CABINET ASSY			
28	VVX37F105G00	LCD PANEL			⚠
29	TBM0E2553	MODEL LABEL			⚠
30	TBL5ZX0107	PACKED STAND ASSY			⚠
31	L0AZ14C00007	SPEAKER UNIT_L			
32	L0AZ14C00008	SPEAKER UNIT_R			

MISCELLANEOUS COMPONENTS

BOTCUS	TPD0E2181	BOTTOM CUSHION
CARTON	TPC0EA07101	CARTON
FC01	JKG00000100	FERRITE CORE
TOPCUS	TPD0E1176	TOP CUSHION

I.C.s

IC8901	STML37DT30E	EEPROM STM
IC8902	X24CL37DT30E	EEPROM LDA3

TERMINALS AND LINKS

A02-P02	TXJA02NUUE	A02-P02 WIRE
A10-S10-	TXJA10NUUE	A10-S10-KA10 WIRE
A12-SPK	TXJA12NUUE	A12-SPK WIRE
A15-CN70	TSXM399	LVDS FFC
A16-CN70	TXJA16NUUE	A16-TCON WIRE
A30-V30	TXJA30NUUE	A30-V30 WIRE
P4-CN901	TXJ/P4NUUE	P4-TCON WIRE