

13 Exploded View and Replacement Parts List

13.1. Exploded View and Mechanical Replacement Parts List

13.1.1. Exploded View

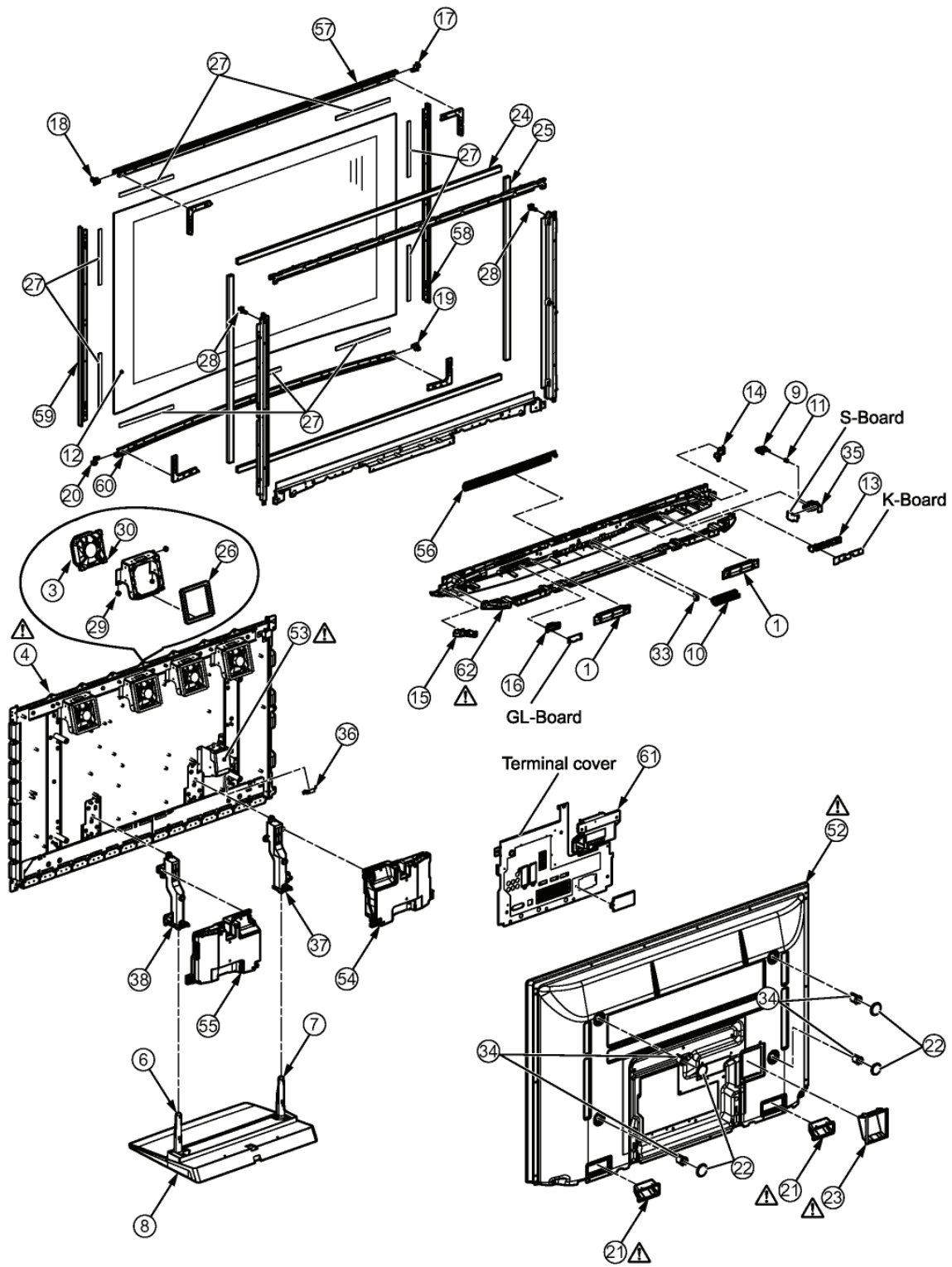

13.1.2. Packing

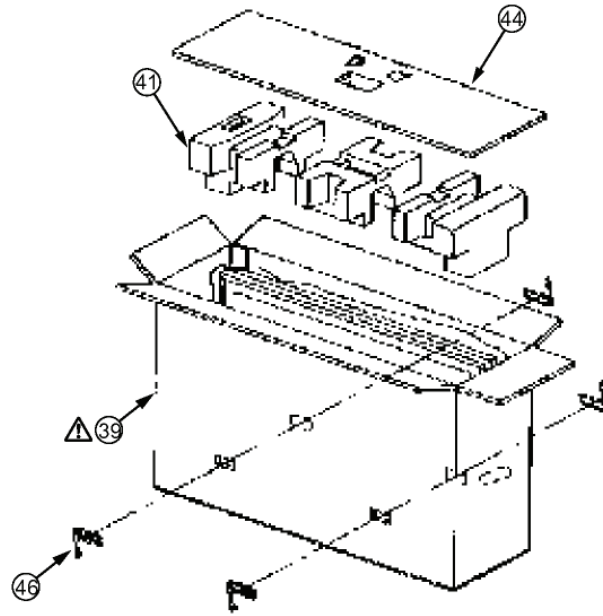
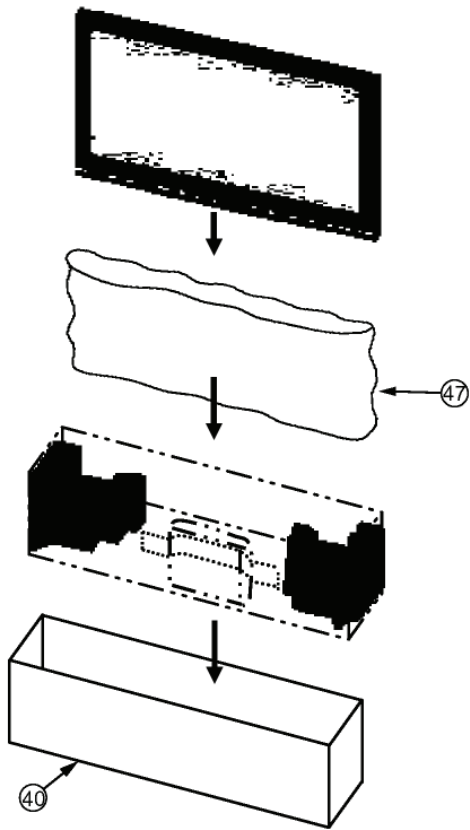

BACK SIDE VIEW

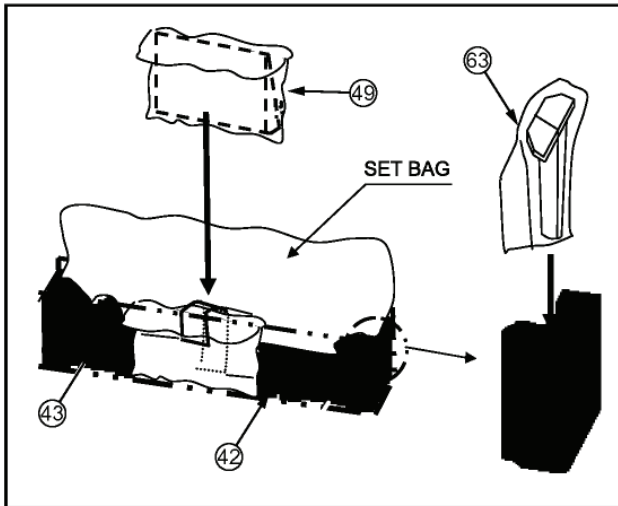

ACCESSORY

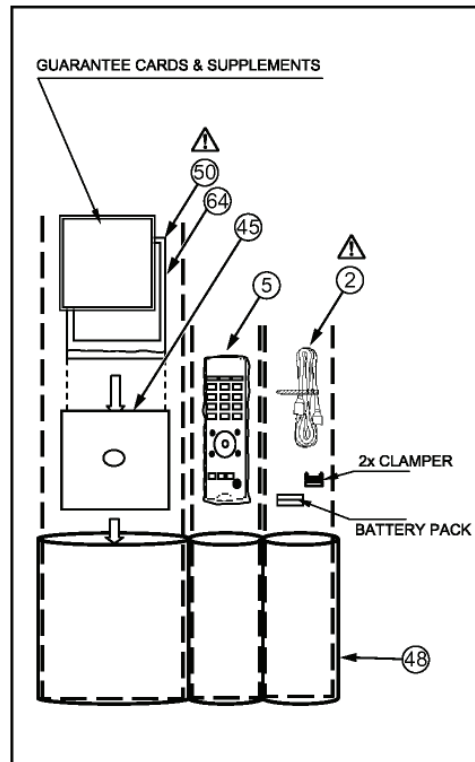

















13.1.3. Mechanical Replacement Parts List







































Note: Important Safety Notice







Components identified by  mark have special characteristics important for safety.
When replacing any of these components, use only manufacturer's specified parts.

Note: All parts except parts mentioned [PAVCCZ] in the Remarks column are supplied by PAVC-CSG.
Parts mentioned [PAVCCZ] are supplied by PAVCCZ.

Safety	Ref. No.	Part No.	Part Name & Description	Q'ty	Remarks
	1	EAS10D85J	SPEAKER(SQUAWKER)	2	
	2	K2CN3DH00006	AC CORD	1	E/P
	2	K2CT3DH00018	AC CORD	1	B
	3	L6FAYYYH0050	FAN(80MM-T25)	4	
	4	MD42F11A1J	PLASMA DISPLAY PANEL	1	
	5	N2QAYB000238	REMOTE CONTROL	1	PAVCCZ B/E
	5	N2QAYB000240	REMOTE CONTROL	1	PAVCCZ P
	6	TBLA3614	STAND POLE RIGHT	1	
	7	TBLA3615	STAND POLE LEFT	1	
	8	TBLX0039	PEDESTAL STAND	1	PAVCCZ
	9	TBXA53801	POWER BUTTON	1	
	10	TBXA53902	SELECTION BUTTON	1	
	11	TES0E201	POWER BUTTON SPRING	1	PAVCCZ
		THEC118N	STEP SCREW	2	
		THEJ016J	SCREW(AC INRET:2)	2	
		THEL037N	SCREW	30	
		THEL0429	SCREW	13	
		THEL049	SCREW(WOOFER_SP)	2	
		THEL052Z	SCREW (BC TOP:4)	10	
		THEL060N	SCREW(STAND-TV)	4	
		THTA052J	SCREW(CM/GF:8 GF/GH T:7 L:5 R:5)L=8	25	
		THTA053J	SCREW(GF/CAB:2 GF/GH B:8)L=12	10	
		THTD013N	SCREW	12	
		THTF011N	SCREW	48	
	12	TKGA5455-1	FRONT GLASS	1	PAVCCZ
	13	TKKC5317	LED PANEL LIGHT	1	B/E
	13	TKKC5336	LED PANEL LIGHT	1	PAVCCZ P
	14	TKKL5430	CORNER PROTECTION LEFT	1	
	15	TKKL5431	CORNER PROTECTION RIGHT	1	
	16	TKPB23701	SD PANEL LIGHT	1	
	17	TKPB23801	CORNER COVER (LEFT-TOP)	1	PAVCCZ
	18	TKPB23901	CORNER COVER (RIGHT-TOP)	1	PAVCCZ
	19	TKPB24001	CORNER COVER (LEFT-BOTTOM)	1	
	20	TKPB24101	CORNER COVER (RIGHT-BOTTOM)	1	
	21	TKR0E0101-1	REAR COVER HANDLE	2	PAVCCZ
	22	TKR0E0202	M8 SPACER CAP	4	PAVCCZ
	23	TKR0E1301	INLET COVER	1	PAVCCZ
	24	TMK0E779	SPONGE (UPPER/BOTTOM)	2	PAVCCZ
	25	TMK0E780	SPONGE (LEFT/RIGHT)	2	PAVCCZ
	26	TMKG669	FAN SPONGE	4	
	27	TMKY438	GLASS EDGE GUARD	9	
		TMM17499	CLAMPER	2	
		TMM6428-1	CLAMPER	1	

Safety	Ref. No.	Part No.	Part Name & Description	Q'ty	Remarks
		TMM7464-2	CLAMPER	1	
	28	TMMD013	REAR COVER HOOK HOLDER	2	
		TMME190	CLAMPER	1	
		TMME224	CLAMPER	2	
		TMME260	CLAMPER	5	
		TMME261	CLAMPER	1	
		TMME287	CLAMPER	6	
		TMME289	CLAMPER	2	
		TMME292	CLAMPER	23	
		TMME305	CLAMPER	2	
		TMME308	CLAMPER	1	
	29	TMMJ068	RUBBER (FAN)	12	
		TMMJ070	SPEAKER RUBBER	8	
	30	TMMJ082	SPONGE (FAN CORNER)	16	
	33	TMMX226	DOOR SPRING	1	
	34	TMMX227	M8 SPACER	4	
	35	TMWC026	POWER BUTTON BRACKET	1	PAVCCZ
	36	TMXX045	AC CORD HOLDER	1	
		TMXX054	AC CORD CLAMPER	2	PAVCCZ E/P
		TMXX055	AC CORD CLAMPER	2	PAVCCZ B
	37	TMZX5129	STAND BRACKET LEFT	1	
	38	TMZX5130	STAND BRACKET RIGHT	1	
	39	TPC0E49000	CARTON BOX TOP	1	PAVCCZ
	40	TPC0E49100	CARTON BOX BOTTOM	1	PAVCCZ
	41	TPD0E1049	TOP SIDE CUSHION	1	PAVCCZ
	42	TPD0E2006	PEDESTAL CUSHION	1	PAVCCZ
	43	TPD0E2022	BOTTOM SIDE CUSHION	1	PAVCCZ
	44	TPD0E9130	TOP PAD	1	PAVCCZ
	45	TPD0E9137	ACCESSORIES PAD	1	PAVCCZ
	46	TPD169487	JOINT	4	
	47	TPE0E4019-1	SET BAG	1	PAVCCZ
	48	TPE0E9001	ACCESSORIES BAG	1	PAVCCZ
	49	TPEB331-1	BAG (PEDESTAL STAND)	1	
		TPEB340	SCREW BAG (STAND-TV)	1	
	50	TQB0E0602	INSTRUCTION BOOK (ENGLISH)	1	PAVCCZ B
	50	TQB0E0603A	INSTRUCTION BOOK (GERMAN)	1	PAVCCZ E
	50	TQB0E0603B	INSTRUCTION BOOK (DUTCH)	1	PAVCCZ E
	50	TQB0E0603C	INSTRUCTION BOOK (ITALIAN)	1	PAVCCZ E
	50	TQB0E0603D	INSTRUCTION BOOK (FRENCH)	1	PAVCCZ E
	50	TQB0E0603E	INSTRUCTION BOOK (SPANISH)	1	PAVCCZ E
	50	TQB0E0603F	INSTRUCTION BOOK (SWEDISH)	1	PAVCCZ E
	50	TQB0E0603G	INSTRUCTION BOOK (NORWEGIAN)	1	PAVCCZ E
	50	TQB0E0603H	INSTRUCTION BOOK (FINNISH)	1	PAVCCZ E

Safety	Ref. No.	Part No.	Part Name & Description	Q'ty	Remarks
	50	TQB0E0603I	INSTRUCTION BOOK (LITHUANIAN)	1	PAVCCZ E
	50	TQB0E0603J	INSTRUCTION BOOK (PORTUGUESE)	1	PAVCCZ E
	50	TQB0E0603K	INSTRUCTION BOOK (DANISH)	1	PAVCCZ E
	50	TQB0E0603M	INSTRUCTION BOOK (BULGARIAN)	1	PAVCCZ E
	50	TQB0E0603N	INSTRUCTION BOOK (ROMANIAN)	1	PAVCCZ E
	50	TQB0E0603O	INSTRUCTION BOOK (LATVIAN)	1	PAVCCZ E
	50	TQB0E0603P	INSTRUCTION BOOK (POLISH)	1	PAVCCZ E
	50	TQB0E0603Q	INSTRUCTION BOOK (HUNGARIAN)	1	PAVCCZ E
	50	TQB0E0603R	INSTRUCTION BOOK (CZECH)	1	PAVCCZ E
	50	TQB0E0603S	INSTRUCTION BOOK (GREEK)	1	PAVCCZ E
	50	TQB0E0603T	INSTRUCTION BOOK (TURKISH)	1	PAVCCZ E
	50	TQB0E0603U	INSTRUCTION BOOK (ENGLISH)	1	PAVCCZ E
	50	TQB0E0603W	INSTRUCTION BOOK (SLOVAKIAN)	1	PAVCCZ E
	50	TQB0E0603X	INSTRUCTION BOOK (CD-ROM)	1	PAVCCZ E
	50	TQB0E0603Z	INSTRUCTION BOOK (ESTONIAN)	1	PAVCCZ E
	50	TQB0E0604A	INSTRUCTION BOOK (GERMAN)	1	PAVCCZ P
	50	TQB0E0604B	INSTRUCTION BOOK (DUTCH)	1	PAVCCZ P
	50	TQB0E0604C	INSTRUCTION BOOK (ITALIAN)	1	PAVCCZ P
	50	TQB0E0604D	INSTRUCTION BOOK (FRENCH)	1	PAVCCZ P
	50	TQB0E0604E	INSTRUCTION BOOK (SPANISH)	1	PAVCCZ P
	50	TQB0E0604F	INSTRUCTION BOOK (SWEDISH)	1	PAVCCZ P
	50	TQB0E0604G	INSTRUCTION BOOK (NORWEGIAN)	1	PAVCCZ P
	50	TQB0E0604H	INSTRUCTION BOOK (FINNISH)	1	PAVCCZ P
	50	TQB0E0604I	INSTRUCTION BOOK (LITHUANIAN)	1	PAVCCZ P
	50	TQB0E0604J	INSTRUCTION BOOK (PORTUGUESE)	1	PAVCCZ P
	50	TQB0E0604K	INSTRUCTION BOOK (DANISH)	1	PAVCCZ P
	50	TQB0E0604M	INSTRUCTION BOOK (BULGARIAN)	1	PAVCCZ P
	50	TQB0E0604N	INSTRUCTION BOOK (ROMANIAN)	1	PAVCCZ P
	50	TQB0E0604O	INSTRUCTION BOOK (LATVIAN)	1	PAVCCZ P
	50	TQB0E0604P	INSTRUCTION BOOK (POLISH)	1	PAVCCZ P
	50	TQB0E0604Q	INSTRUCTION BOOK (HUNGARIAN)	1	PAVCCZ P
	50	TQB0E0604R	INSTRUCTION BOOK (CZECH)	1	PAVCCZ P
	50	TQB0E0604S	INSTRUCTION BOOK (GREEK)	1	PAVCCZ P
	50	TQB0E0604T	INSTRUCTION BOOK (TURKISH)	1	PAVCCZ P
	50	TQB0E0604U	INSTRUCTION BOOK (ENGLISH)	1	PAVCCZ P
	50	TQB0E0604V	INSTRUCTION BOOK (CROATIAN)	1	PAVCCZ P
	50	TQB0E0604W	INSTRUCTION BOOK (SLOVAKIAN)	1	PAVCCZ P
	50	TQB0E0604X	INSTRUCTION BOOK (CD-ROM)	1	PAVCCZ P
	50	TQB0E0604Z	INSTRUCTION BOOK (ESTONIAN)	1	PAVCCZ P
		TQFE224	CAUTION LABEL	1	PAVCCZ
		TQZH983	SCREW USE HANDBILL	1	
		TSXL519	CABLE (SU11-SD11)	1	
		TSXL597	CABLE (C10-C20)	1	

Safety	Ref. No.	Part No.	Part Name & Description	Q'ty	Remarks
		TSXL657	CABLE (D20-SC20)	1	
		TSXL660	CABLE (D31-C11/D32-C12/D33-C21)	3	
	52	TTU0E0279	REAR COVER	1	PAVCCZ B
	52	TTU0E0309	REAR COVER	1	PAVCCZ E
	52	TTU0E0310	REAR COVER	1	PAVCCZ P
	53	TXAJS01RLTB	AC INLET ASSY	1	PAVCCZ
	54	TXFAB01RHTB	WOOFER BOX ASSY (LEFT)	1	PAVCCZ
	55	TXFAB02RHTB	WOOFER BOX ASSY (RIGHT)	1	PAVCCZ
	56	TXFKP01RHTB	DOOR ASSY	1	PAVCCZ
	57	TXFKR01RHTU	GLASS FRAME TOP ASSY	1	PAVCCZ
	58	TXFKR02RHTJ	GLASS FRAME LEFT ASSY	1	
	59	TXFKR03RHTJ	GLASS FRAME RIGHT ASSY	1	
	60	TXFKR04RHTJ	GLASS FRAME BOTTOM ASSY	1	
	61	TXFKR05RHTB	CI COVER ASSY	1	PAVCCZ B/E
	62	TXFKY01RHTB	BOTTOM CABINET ASSY	1	PAVCCZ B
	62	TXFKY01RHTD	BOTTOM CABINET ASSY	1	PAVCCZ E
	62	TXFKY01RHTE	BOTTOM CABINET ASSY	1	PAVCCZ P
		TXFPE01RLTB	CLEANING CLOTH ASSY	1	PAVCCZ
		TXJH11RHTB	SPEAKER LEAD (H11-SP)	1	PAVCCZ
		TXJH12RHTB	SPEAKER LEAD (H12-SP)	1	PAVCCZ
		XSB3+6FJ	SCREW (LCD MTG)	3	
		XTB4+12GFJ	SCREW	22	
		XTB4+12GFJK	SCREW	19	
		XTB4+12GFN	TAPS CREW	8	
		XTB4+5FFN	SCREW	4	
		XTS4+12GFN	SCREW	6	
		XTV3+10JFJK	SCREW	4	
		XTW3+10TFJ	SCREW	4	
		XTWT4+Z15DFJ	SCREW (SP BOX)	4	
		XYN3+F8FJ	SCREW	32	
		XYN3+J12FJ	SCREW	45	
		XYN3+J8FJ	SCREW	4	
		XYN4+E8FJ	SCREW	1	
		XYN4+F10FJ	SCREW	16	
		XYN4+F14FJ	SCREW	6	
		XYN5+C15FJ	SCREW	6	
		XYN5+F18FN	SCREW (STAND POLE)	4	
	63	XZB17X19C03	POLY BAG (STAND POLE)	1	
	64	XZBT6506	POLY BAG (INSTRUCTION BOOK)	1	

13.2. Electrical Replacement Parts List

13.2.1. Replacement Parts List Notes

Important Safety Notice

Components identified by \triangle mark have special characteristics important for safety. When replacing any of these components, use only manufacturer's specified parts.

RTL (Retention Time Limited)

Note: The marking (RTL) indicates that the Retention Time is Limited for this item. After the discontinuation of this assembly in production, the item will continue to be available for a specific period of time. The retention period of availability is dependant on the type of assembly, and in accordance with the laws governing part and product retention. After the end of this period, the assembly will no longer be available.

Abbreviation of part name and description

1. Resistor

Example:

ERD25TJ104 \underline{C} 100KOHM, \underline{J} , 1/4W
 Type Allowance

2. Capacitor

Example:

ECKF1H103ZF \underline{C} 0.01UF, \underline{Z} , 50V
 Type Allowance

Type	Allowance
C : Carbon	F : $\pm 1\%$
F : Fuse	G : $\pm 2\%$
M : Metal Oxide Metal Film	J : $\pm 5\%$
S : Solid	K : $\pm 10\%$
W : Wire Wound	M : $\pm 20\%$

Type	Allowance
C : Ceramic	C : $\pm 0.25\text{pF}$
E : Electrolytic	D : $\pm 0.5\text{pF}$
P : Polyester	F : $\pm 1\text{pF}$
Polyprop	G : $\pm 3\text{pF}$
lene	J : $\pm 5\text{pF}$
T : Tantalum	K : $\pm 10\text{pF}$
	L : $\pm 15\text{pF}$
	M : $\pm 20\text{pF}$
	P : +100%, -0%
	Z : +80%, -20%

Safety	Ref. No.	Part No.	Part Name & Description	Pcs	Remarks
	C2204	FIH1C105A008	C 1UF, K, 16V	1	
	C2213	FIG1H102A730	C 1000UF, 50V	1	
	C2216	FIG1C104A116	C 0.10UF, K, 16V	1	
	C2244	FIG1C104A116	C 0.10UF, K, 16V	1	
	C2245	FIG1H102A730	C 1000UF, 50V	1	
	C2246	FIJ1A106A043	C 0.010UF, K, 10V	1	
	C2251	FIJ1A106A043	C 0.010UF, K, 10V	1	
	C2261	FIJ1A106A043	C 0.010UF, K, 10V	1	
	C2262	FIJ1A106A043	C 0.010UF, K, 10V	1	
	C2263	FIJ1A106A043	C 0.010UF, K, 10V	1	
	C2264	FIJ1A106A043	C 0.010UF, K, 10V	1	
	C2301	FIG1C104A116	C 0.10UF, K, 16V	1	
	C2302	FIG1C104A116	C 0.10UF, K, 16V	1	
	C2393	FIK1C1060004	C 0.010UF, 16V	1	
	C2394	FIJ1H474A757	C 0.47UF, 50V	1	
	C2395	FIJ1H474A757	C 0.47UF, 50V	1	
	C2400	FIG1C104A116	C 0.10UF, K, 16V	1	
	C2401	FIG1H181A731	C 180UF, 50V	1	
	C2402	FIG1C104A116	C 0.10UF, K, 16V	1	
	C2403	F2G1V220A020	E 22UF, 35V	1	
	C2404	FIG1H102A730	C 1000UF, 50V	1	
	C2407	F2H0J1010009	C 100UF, 6.3V	1	
	C2408	FIG1C104A116	C 0.10UF, K, 16V	1	
	C2409	F2G0J1020022	E 1100PF, J, 6.3V	1	
	C2410	FIH0J2250008	C 2.2UF, K, 16V	1	
	C2411	ECJ1VB1H104K	C 0.1UF, K, 50V	1	
	C2412	F2G1H100A031	E 10UF, 50V	1	
	C2413	FIH1A1050032	C 10UF, 50V	1	
	C2414	FIG1C104A116	C 0.10UF, K, 16V	1	
	C2415	FIG1C104A116	C 0.10UF, K, 16V	1	
	C2418	FIG1E103A123	C 0.010UF, K, 16V	1	
	C2419	FIG1H101A731	C 100PF, K, 50V	1	
	C2420	FIG1C104A116	C 0.10UF, K, 16V	1	
	C2427	FIH1A1050032	C 10UF, 50V	1	
	C2430	ECJ3YB1E106M	C 10 UF, K, 25V	1	
	C2431	FIG1H101A731	C 100PF, K, 50V	1	
	C2432	FIG1H471A731	C 470UF, 50V	1	
	C2433	FIG1H471A731	C 470UF, 50V	1	
	C2434	FIG1C104A116	C 0.10UF, K, 16V	1	
	C2437	FIG1C104A116	C 0.10UF, K, 16V	1	
	C2511	FIH1C104A143	C 0.1UF, K, 16V	1	
	C2512	FIJ1A106A043	C 0.010UF, K, 10V	1	
	C2515	FIH1H103A970	C 0.001UF, K, 50V	1	
	C2517	FIH1H103A970	C 0.001UF, K, 50V	1	B/E
	C2521	FIH1H103A970	C 0.001UF, K, 50V	1	
	C2525	ECJ1VB1H102K	C 1000PF, K, 50V	1	
	C2601	FIG1A104A012	C 0.01UF, K, 10V	1	
	C2602	FIG1A104A012	C 0.01UF, K, 10V	1	
	C2603	FIG1C103A116	C 0.010UF, K, 16V	1	
	C2604	FIG1A104A012	C 0.01UF, K, 10V	1	
	C2605	FIG1C103A116	C 0.010UF, K, 16V	1	
	C2608	FIG1A104A012	C 0.01UF, K, 10V	1	
	C2609	FIG1C103A116	C 0.010UF, K, 16V	1	
	C2610	FIG1C103A116	C 0.010UF, K, 16V	1	
	C2611	FIG1C103A116	C 0.010UF, K, 16V	1	
	C2612	FIG1A104A012	C 0.01UF, K, 10V	1	
	C2613	FIG1H180A731	C 18UF, 50V	1	
	C2614	FIG1H120A731	C 12UF, 50V	1	
	C2615	FIG1A104A012	C 0.01UF, K, 10V	1	

Safety	Ref. No.	Part No.	Part Name & Description	Pcs	Remarks
	C2616	FIG1A104A012	C 0.01UF, K, 10V	1	
	C2617	FIG1A104A012	C 0.01UF, K, 10V	1	
	C2618	FIG1A104A012	C 0.01UF, K, 10V	1	
	C2619	FIG1A104A012	C 0.01UF, K, 10V	1	
	C2620	FIG1A104A012	C 0.01UF, K, 10V	1	
	C2621	FIG1A104A012	C 0.01UF, K, 10V	1	
	C2622	FIG1A104A012	C 0.01UF, K, 10V	1	
	C2623	FIG1A104A012	C 0.01UF, K, 10V	1	
	C2624	FIG1A104A012	C 0.01UF, K, 10V	1	
	C2625	FIG1A104A012	C 0.01UF, K, 10V	1	
	C2626	FIG1A104A012	C 0.01UF, K, 10V	1	
	C2627	FIG1A104A012	C 0.01UF, K, 10V	1	
	C2628	FIG1C103A116	C 0.010UF, K, 16V	1	
	C2629	FIG1A104A012	C 0.01UF, K, 10V	1	
	C2630	FIG1A104A012	C 0.01UF, K, 10V	1	
	C2631	FIG1C103A116	C 0.010UF, K, 16V	1	
	C2632	FIG1A104A012	C 0.01UF, K, 10V	1	
	C2633	FIG1C103A116	C 0.010UF, K, 16V	1	
	C2634	FIG1A104A012	C 0.01UF, K, 10V	1	
	C2635	ECJ1VB1H473K	C 0.047UF, K, 50V	1	
	C2637	EEHBOG221P	C 220PF, J, 4V	1	
	C2638	EEHBOG470R	C 47PF, J, 4V	1	
	C2639	F2G1C2200036	E 22UF, 16V	1	
	C2640	F2G1C2200036	E 22UF, 16V	1	
	C2641	F2G1C2200036	E 22UF, 16V	1	
	C2642	FIG1A104A012	C 0.01UF, K, 10V	1	
	C2643	FIG1C103A116	C 0.010UF, K, 16V	1	
	C2644	FIG1C103A116	C 0.010UF, K, 16V	1	
	C2645	FIG1A104A012	C 0.01UF, K, 10V	1	
	C2646	FIG1A104A012	C 0.01UF, K, 10V	1	
	C2647	FIG1A104A012	C 0.01UF, K, 10V	1	
	C2648	FIG1A104A012	C 0.01UF, K, 10V	1	
	C2649	FIG1A104A012	C 0.01UF, K, 10V	1	
	C2650	F2G1C2200036	E 22UF, 16V	1	
	C2651	FIG1H100A565	C 100PF, K, 50V	1	
	C2652	ECGRLO6G80ER	C 68PF, J, 4V	1	
	C2657	FIG1C103A116	C 0.010UF, K, 16V	1	
	C2658	ECJ2VB1C104K	C 0.1UF, K, 16V	1	
	C2661	FIH1A1050032	C 10UF, 50V	1	
	C3099	F2G1C220A022	E 22UF, 16V	1	
	C3104	ECJ1VB1H104K	C 0.1UF, K, 50V	1	
	C3107	FIH1H470A971	C 47UF, K, 50V	1	PAVCCZ
	C3109	FIG1H222A730	C 2200UF, 50V	1	
	C3110	F2G1C1010034	E 100PF, J, 16V	1	
	C3115	FIG1H222A730	C 2200UF, 50V	1	
	C3116	ECJ1VB1C105K	C 0.01UF, K, 16V	1	
	C3117	FIH1H561A971	C 560UF, 50V	1	
	C3122	FIH1A1050032	C 10UF, 50V	1	
	C3123	FIH1A1050032	C 10UF, 50V	1	
	C3124	FIH1A1050032	C 10UF, 50V	1	
	C3128	FIH1H561A971	C 560UF, 50V	1	
	C3136	FIH1H561A971	C 560UF, 50V	1	
	C3137	FIH1H561A971	C 560UF, 50V	1	
	C3138	FIH1H561A971	C 560UF, 50V	1	
	C3139	FIH1H561A971	C 560UF, 50V	1	
	C3140	FIH1H561A971	C 560UF, 50V	1	
	C3141	FIH1H561A971	C 560UF, 50V	1	
	C3142	FIH1H561A971	C 560UF, 50V	1	
	C3143	FIH1H561A971	C 560UF, 50V	1	
	C3144	FIH1H561A971	C 560UF, 50V	1	
	C3145	FIH1H561A971	C 560UF, 50V	1	
	C3148	FIJ1A106A043	C 0.010UF, K, 10V	1	
	C3149	FIJ1A106A043	C 0.010UF, K, 10V	1	
	C3150	FIJ1A106A043	C 0.010UF, K, 10V	1	

Safety	Ref. No.	Part No.	Part Name & Description	Pcs	Remarks
	C3151	F1J1A106A043	C 0.010UF, K, 10V	1	
	C3152	ECJ1VB1C105K	C 0.01UF, K, 16V	1	
	C3154	ECJ1VB1C105K	C 0.01UF, K, 16V	1	
	C3172	ECJ1VB1C105K	C 0.01UF, K, 16V	1	
	C3173	ECJ1VB1C105K	C 0.01UF, K, 16V	1	
	C3180	F1J1A106A043	C 0.010UF, K, 10V	1	
	C3181	F1J1A106A043	C 0.010UF, K, 10V	1	
	C3221	F1J1A106A043	C 0.010UF, K, 10V	1	
	C3222	F1J1A106A043	C 0.010UF, K, 10V	1	
	C3223	ECJ1VB1C105K	C 0.01UF, K, 16V	1	
	C3225	ECJ1VB1H104K	C 0.1UF, K, 50V	1	
	C3226	ECJ1VB1C105K	C 0.01UF, K, 16V	1	
	C3245	ECJ1VB1C105K	C 0.01UF, K, 16V	1	
	C3246	ECJ1VB1C105K	C 0.01UF, K, 16V	1	
	C3247	ECJ1VB1C105K	C 0.01UF, K, 16V	1	
	C3248	ECJ1VB1C105K	C 0.01UF, K, 16V	1	
	C3249	ECJ1VB1C105K	C 0.01UF, K, 16V	1	
	C3250	ECJ1VB1C105K	C 0.01UF, K, 16V	1	
	C3253	F1H1A1050032	C 10UF, 50V	1	
	C3256	ECJ1VB1H102K	C 1000PF, K, 50V	1	
	C3257	ECJ1VB1H102K	C 1000PF, K, 50V	1	
	C3258	F1H1A1050032	C 10UF, 50V	1	B/E
	C3259	F1H1A1050032	C 10UF, 50V	1	
	C3260	F1H1A1050032	C 10UF, 50V	1	
	C3261	ECJ1VB1H104K	C 0.1UF, K, 50V	1	
	C3262	F1H1A1050032	C 10UF, 50V	1	
	C3263	F1H1A1050032	C 10UF, 50V	1	
	C3264	ECJ1VB1C105K	C 0.01UF, K, 16V	1	
	C3265	EEH1B1C221UP	C 220PF, J, 16V	1	
	C3266	ECJ1VB1H104K	C 0.1UF, K, 50V	1	
	C3267	F1H1A1050032	C 10UF, 50V	1	
	C3268	F1H1A1050032	C 10UF, 50V	1	
	C3269	F1H1A1050032	C 10UF, 50V	1	
	C3270	F1H1A1050032	C 10UF, 50V	1	
	C3271	F1H1A1050032	C 10UF, 50V	1	
	C3272	F1H1A1050032	C 10UF, 50V	1	
	C3273	F1H1A1050032	C 10UF, 50V	1	
	C3274	F1H1A1050032	C 10UF, 50V	1	
	C3275	F1H1A1050032	C 10UF, 50V	1	
	C3276	F1H1A1050032	C 10UF, 50V	1	
	C3277	ECJ1VB1H104K	C 0.1UF, K, 50V	1	
	C3278	F2G1A221A149	E 220UF, 10V	1	
	C3279	ECJ1VB1H104K	C 0.1UF, K, 50V	1	
	C3280	F2G1A221A149	E 220UF, 10V	1	
	C3284	ECJ1VB1H104K	C 0.1UF, K, 50V	1	
	C3297	F1J1A106A043	C 0.010UF, K, 10V	1	
	C3298	F1J1A106A043	C 0.010UF, K, 10V	1	
	C3299	F1J1A106A043	C 0.010UF, K, 10V	1	
	C3300	F1J1A106A043	C 0.010UF, K, 10V	1	
	C3302	EEH1B1C221UP	C 220PF, J, 16V	1	
	C3308	F2G1C100A022	C 10UF J 16V	1	
	C3310	ECJ1VB1H104K	C 0.1UF, K, 50V	1	
	C3311	ECJ1VB1H104K	C 0.1UF, K, 50V	1	
	C3319	ECJ1VB1H104K	C 0.1UF, K, 50V	1	
	C3320	F2G1C470A022	E 47UF, 16V	1	
	C3323	F1H1A1050032	C 10UF, 50V	1	
	C3701	ECJ2XC1H561K	C 560PF, K, 50V	1	
	C3703	ECJ2XC1H561K	C 560PF, K, 50V	1	
	C3711	ECJ2VF1H333Z	C 0.033UF, Z, 50V	1	
	C3712	ECJ2VF1H333Z	C 0.033UF, Z, 50V	1	
	C3750	F1J1H102A721	C 1000UF, 50V	1	
	C3801	F1G1C104A116	C 0.10UF, K, 16V	1	
	C3802	F1G1C104A116	C 0.10UF, K, 16V	1	
	C3803	F1H1A1050032	C 10UF, 50V	1	

Safety	Ref. No.	Part No.	Part Name & Description	Pcs	Remarks
	C3804	F1G1C104A116	C 0.10UF, K, 16V	1	
	C3806	F1G1C104A116	C 0.10UF, K, 16V	1	
	C3807	F1G1C104A116	C 0.10UF, K, 16V	1	
	C3808	F1G1C104A116	C 0.10UF, K, 16V	1	
	C3809	F1G1C104A116	C 0.10UF, K, 16V	1	
	C3810	F1G1C104A116	C 0.10UF, K, 16V	1	
	C3811	F1G1C104A116	C 0.10UF, K, 16V	1	
	C3812	F1G1C104A116	C 0.10UF, K, 16V	1	
	C3813	F1J0J106A004	C 0.010UF, K, 16V	1	
	C3814	F1G1C104A116	C 0.10UF, K, 16V	1	
	C3815	ECJ0EB1C103K	C 0.010UF, K, 16V	1	
	C3816	ECJ0EB1C103K	C 0.010UF, K, 16V	1	
	C3817	ECJ0EB1C103K	C 0.010UF, K, 16V	1	
	C3818	ECJ0EB1C103K	C 0.010UF, K, 16V	1	
	C3819	ECJ0EB1C103K	C 0.010UF, K, 16V	1	
	C3820	ECJ0EB1C103K	C 0.010UF, K, 16V	1	
	C3823	F1G1C104A116	C 0.10UF, K, 16V	1	
	C3827	F1J1A475A039	C 4.7UF, K, 10V	1	
	C3829	F1H1A1050032	C 10UF, 50V	1	
	C4005	F1G1C104A081	C 0.10UF, K, 16V	1	
	C4006	F1G1C104A081	C 0.10UF, K, 16V	1	
	C4008	F1G1C104A081	C 0.10UF, K, 16V	1	
	C4010	F1G1C104A081	C 0.10UF, K, 16V	1	
	C4011	F1G1C104A081	C 0.10UF, K, 16V	1	
	C4013	F1G1C104A081	C 0.10UF, K, 16V	1	
	C4014	F1G1C104A081	C 0.10UF, K, 16V	1	
	C4015	F1G1C104A081	C 0.10UF, K, 16V	1	
	C4016	F1J1C475A170	C 4.7UF, K, 16V	1	
	C4018	F1G1C104A081	C 0.10UF, K, 16V	1	
	C4019	F1J1H474A757	C 0.47UF, 50V	1	
	C4020	F1G1C104A081	C 0.10UF, K, 16V	1	
	C4021	F1G1C104A081	C 0.10UF, K, 16V	1	
	C4022	F1J1H474A757	C 0.47UF, 50V	1	
	C4023	F1G1C104A081	C 0.10UF, K, 16V	1	
	C4024	F1G1C104A081	C 0.10UF, K, 16V	1	
	C4025	F1G1C104A081	C 0.10UF, K, 16V	1	
	C4027	F1G1C104A081	C 0.10UF, K, 16V	1	
	C4028	F1G1C104A081	C 0.10UF, K, 16V	1	
	C4030	F1G1C104A081	C 0.10UF, K, 16V	1	
	C4032	F1G1C104A081	C 0.10UF, K, 16V	1	
	C4033	F1G1C104A081	C 0.10UF, K, 16V	1	
	C4034	F1G1C104A081	C 0.10UF, K, 16V	1	
	C4035	F1H1A1050032	C 10UF, 50V	1	
	C4036	F1H1A1050032	C 10UF, 50V	1	
	C4038	F1G1C104A081	C 0.10UF, K, 16V	1	
	C4039	F1G1E103A123	C 0.010UF, K, 16V	1	
	C4040	F1G1H150A731	C 15UF, 50V	1	
	C4045	F1G1C104A081	C 0.10UF, K, 16V	1	
	C4047	F1H1A1050032	C 10UF, 50V	1	
	C4049	F1G1C104A081	C 0.10UF, K, 16V	1	
	C4050	F1H1A1050032	C 10UF, 50V	1	
	C4051	F1G1C104A081	C 0.10UF, K, 16V	1	
	C4052	F1G1C104A081	C 0.10UF, K, 16V	1	
	C4053	F1G1C104A081	C 0.10UF, K, 16V	1	
	C4054	F1K1C1060004	C 0.010UF, 16V	1	
	C4055	F1G1C104A116	C 0.10UF, K, 16V	1	
	C4056	F2G1C470A022	E 47UF, 16V	1	
	C4101	F1G1C104A116	C 0.10UF, K, 16V	1	
	C4255	F1G1C104A116	C 0.10UF, K, 16V	1	
	C4256	F1G1C104A116	C 0.10UF, K, 16V	1	
	C4257	F1G1C104A116	C 0.10UF, K, 16V	1	
	C4258	F1G1C104A116	C 0.10UF, K, 16V	1	
	C4259	F1G1C104A116	C 0.10UF, K, 16V	1	
	C4260	F1G1C104A116	C 0.10UF, K, 16V	1	
	C4261	F1G1C104A116	C 0.10UF, K, 16V	1	
	C4262	F1G1C104A116	C 0.10UF, K, 16V	1	
	C4263	F1G1C104A116	C 0.10UF, K, 16V	1	

Safety	Ref. No.	Part No.	Part Name & Description	Pcs	Remarks
	C4264	FIG1C104A116	C 0.10UF, K, 16V	1	
	C4265	FIG1C104A116	C 0.10UF, K, 16V	1	
	C4266	FIH0J1050012	C 1UF, K, 16V	1	
	C4267	FIG1H1020008	C 1000UF, 50V	1	
	C4268	FIG1H1020008	C 1000UF, 50V	1	
	C4270	FIG1C104A116	C 0.10UF, K, 16V	1	
	C4271	FIG1C104A116	C 0.10UF, K, 16V	1	
	C4272	FIG1C104A116	C 0.10UF, K, 16V	1	
	C4273	FIG1C104A116	C 0.10UF, K, 16V	1	
	C4274	FIG1C104A116	C 0.10UF, K, 16V	1	
	C4275	FIG1C104A116	C 0.10UF, K, 16V	1	
	C4276	FIG1C104A116	C 0.10UF, K, 16V	1	
	C4277	FIG1C104A116	C 0.10UF, K, 16V	1	
	C4278	FIG1C104A116	C 0.10UF, K, 16V	1	
	C4279	FIG1C104A116	C 0.10UF, K, 16V	1	
	C4280	FIG1C104A116	C 0.10UF, K, 16V	1	
	C4281	FIG1C104A116	C 0.10UF, K, 16V	1	
	C4282	FIG1C104A116	C 0.10UF, K, 16V	1	
	C4283	FIG1C104A116	C 0.10UF, K, 16V	1	
	C4284	FIG1C104A116	C 0.10UF, K, 16V	1	
	C4285	FIG1C104A116	C 0.10UF, K, 16V	1	
	C4286	FIG1C104A116	C 0.10UF, K, 16V	1	
	C4287	FIG1C104A116	C 0.10UF, K, 16V	1	
	C4288	FIG1C104A116	C 0.10UF, K, 16V	1	
	C4289	FIG1C104A116	C 0.10UF, K, 16V	1	
	C4290	FIG1H1020008	C 1000UF, 50V	1	
	C4291	FIG1C104A116	C 0.10UF, K, 16V	1	
	C4292	FIG1H1020008	C 1000UF, 50V	1	
	C4293	FIG1C104A116	C 0.10UF, K, 16V	1	
	C4294	FIG1H1020008	C 1000UF, 50V	1	
	C4295	FIG1C104A116	C 0.10UF, K, 16V	1	
	C4296	FIG1H1020008	C 1000UF, 50V	1	
	C4297	FIG1C104A116	C 0.10UF, K, 16V	1	
	C4298	FIG1H1020008	C 1000UF, 50V	1	
	C4299	FIG1C104A116	C 0.10UF, K, 16V	1	
	C4300	F2G0J470A019	E 47UF 6.3V	1	
	C4301	FIG1C104A116	C 0.10UF, K, 16V	1	
	C4302	FIJ0J106A020	C 0.010UF, K, 16V	1	
	C4313	FIJ0J106A020	C 0.010UF, K, 16V	1	
	C4314	FIG1C104A116	C 0.10UF, K, 16V	1	
	C4315	FIG1C104A116	C 0.10UF, K, 16V	1	
	C4316	FIG1C104A116	C 0.10UF, K, 16V	1	
	C4317	FIJ0J106A020	C 0.010UF, K, 16V	1	
	C4318	FIG1C104A116	C 0.10UF, K, 16V	1	
	C4319	FIG1C104A116	C 0.10UF, K, 16V	1	
	C4320	FIG1C104A116	C 0.10UF, K, 16V	1	
	C4321	FIG1C104A116	C 0.10UF, K, 16V	1	
	C4323	FIG1C104A116	C 0.10UF, K, 16V	1	
	C4325	FIJ0J106A020	C 0.010UF, K, 16V	1	
	C4326	FIJ0J106A020	C 0.010UF, K, 16V	1	
	C4328	FIG1C104A116	C 0.10UF, K, 16V	1	
	C4329	FIG1C104A116	C 0.10UF, K, 16V	1	
	C4500	FIG1C104A116	C 0.10UF, K, 16V	1	
	C4501	FIG1C104A116	C 0.10UF, K, 16V	1	
	C4502	FIG1C104A116	C 0.10UF, K, 16V	1	
	C4503	FIG1C104A116	C 0.10UF, K, 16V	1	
	C4510	FIG1C104A116	C 0.10UF, K, 16V	1	
	C4511	FIG1C104A116	C 0.10UF, K, 16V	1	
	C4513	FIG1C104A081	C 0.10UF, K, 16V	1	
	C4514	FIG1C104A081	C 0.10UF, K, 16V	1	
	C4517	FIG1C104A081	C 0.10UF, K, 16V	1	
	C4520	FIJ1A106A043	C 0.010UF, K, 10V	1	
	C4521	FIG1C104A081	C 0.10UF, K, 16V	1	
	C4522	FIG1C104A116	C 0.10UF, K, 16V	1	
	C4523	FIG1C104A081	C 0.10UF, K, 16V	1	
	C4524	FIG1C104A116	C 0.10UF, K, 16V	1	
	C4525	FIG1C104A081	C 0.10UF, K, 16V	1	
	C4533	FIG1H680A731	C 68UF, 50V	1	

Safety	Ref. No.	Part No.	Part Name & Description	Pcs	Remarks
	C4534	FIG1C104A116	C 0.10UF, K, 16V	1	
	C4535	FIG1C104A116	C 0.10UF, K, 16V	1	
	C4537	FIG1C104A116	C 0.10UF, K, 16V	1	
	C4547	FIG1C104A116	C 0.10UF, K, 16V	1	
	C4548	FIG1C104A116	C 0.10UF, K, 16V	1	
	C4549	FIG1C104A116	C 0.10UF, K, 16V	1	
	C4550	FIG1C104A116	C 0.10UF, K, 16V	1	
	C4551	FIG1C104A116	C 0.10UF, K, 16V	1	
	C4552	FIG1C104A116	C 0.10UF, K, 16V	1	
	C4553	FIG1H102A730	C 1000UF, 50V	1	
	C4554	F2G1C470A022	E 47UF, 16V	1	
	C4555	FIJ1A106A043	C 0.010UF, K, 10V	1	
	C4567	FIG1C104A116	C 0.10UF, K, 16V	1	
	C4574	FIG1E103A123	C 0.010UF, K, 16V	1	
	C4575	FIH1A1050032	C 10UF, 50V	1	
	C4580	FIG1E103A123	C 0.010UF, K, 16V	1	
	C4585	FIH1A1050032	C 10UF, 50V	1	
	C4595	FIG1E103A123	C 0.010UF, K, 16V	1	
	C4596	FIG1C104A116	C 0.10UF, K, 16V	1	
	C4598	FIH1A1050032	C 10UF, 50V	1	
	C4599	F2G0J470A019	E 47UF 6.3V	1	
	C4600	FIG1C104A116	C 0.10UF, K, 16V	1	
	C4601	F2G0J470A019	E 47UF 6.3V	1	
	C4602	FIG1C104A116	C 0.10UF, K, 16V	1	
	C4603	FIH0J2250008	C 2.2UF, K, 16V	1	
	C4604	FIG1H471A730	C 470UF, 50V	1	
	C4605	FIH1A1050032	C 10UF, 50V	1	
	C4606	FIJ1A475A039	C 4.7UF, K, 10V	1	
	C4607	FIJ1A475A039	C 4.7UF, K, 10V	1	
	C4608	FIG1C104A116	C 0.10UF, K, 16V	1	
	C4609	FIG1C104A116	C 0.10UF, K, 16V	1	
	C4610	FIG1C104A116	C 0.10UF, K, 16V	1	
	C4611	FIG1C104A116	C 0.10UF, K, 16V	1	
	C4612	FIG1E103A123	C 0.010UF, K, 16V	1	
	C4613	FIH1A1050032	C 10UF, 50V	1	
	C4614	FIG1C104A116	C 0.10UF, K, 16V	1	
	C4615	FIG1C104A116	C 0.10UF, K, 16V	1	
	C4616	FIJ1A475A039	C 4.7UF, K, 10V	1	
	C4617	FIJ0G2260001	C 0.001UF, 6.3V	1	
	C4619	FIG1C104A116	C 0.10UF, K, 16V	1	
	C4624	FIG1C104A116	C 0.10UF, K, 16V	1	
	C4625	FIG1C104A116	C 0.10UF, K, 16V	1	
	C4628	FIG1C104A116	C 0.10UF, K, 16V	1	
	C4630	FIG1C104A116	C 0.10UF, K, 16V	1	
	C4632	FIH1A1050032	C 10UF, 50V	1	
	C4634	FIH1A1050032	C 10UF, 50V	1	
	C4636	FIH1A1050032	C 10UF, 50V	1	
	C4638	FIH1A1050032	C 10UF, 50V	1	
	C4640	FIH1A1050032	C 10UF, 50V	1	
	C4642	FIH1A1050032	C 10UF, 50V	1	
	C4643	FIG1C104A116	C 0.10UF, K, 16V	1	
	C4644	FIG1C104A116	C 0.10UF, K, 16V	1	
	C4645	FIG1C104A116	C 0.10UF, K, 16V	1	
	C4646	FIG1C104A116	C 0.10UF, K, 16V	1	
	C4647	FIK1C1060004	C 0.010UF, 16V	1	
	C5001	FIG1C104A116	C 0.10UF, K, 16V	1	
	C5002	FIG1C104A116	C 0.10UF, K, 16V	1	
	C5003	FIG1C104A116	C 0.10UF, K, 16V	1	
	C5004	FIG1C104A116	C 0.10UF, K, 16V	1	
	C5005	FIH0J1050012	C 1UF, K, 16V	1	
	C5006	FIH0J1050012	C 1UF, K, 16V	1	
	C5007	FIJ1A106A043	C 0.010UF, K, 10V	1	
	C5008	FIG1C104A116	C 0.10UF, K, 16V	1	
	C5009	FIG1C104A116	C 0.10UF, K, 16V	1	
	C5010	FIG1C104A116	C 0.10UF, K, 16V	1	
	C5011	FIG1C104A116	C 0.10UF, K, 16V	1	
	C5012	FIG1C104A116	C 0.10UF, K, 16V	1	

Safety	Ref. No.	Part No.	Part Name & Description	Pcs	Remarks
	C5013	F1J1A106A043	C 0.010UF, K, 10V	1	
	C5014	F1G1C104A116	C 0.10UF, K, 16V	1	
	C5015	F1G1C104A116	C 0.10UF, K, 16V	1	
	C5016	F1J1A106A043	C 0.010UF, K, 10V	1	
	C5017	F1G1C104A116	C 0.10UF, K, 16V	1	
	C5018	F1G1C104A116	C 0.10UF, K, 16V	1	
	C5019	F1G1C104A116	C 0.10UF, K, 16V	1	
	C5020	F1G1C104A116	C 0.10UF, K, 16V	1	
	C5021	F1H0J1050012	C 1UF, K, 16V	1	
	C5022	F1H0J1050012	C 1UF, K, 16V	1	
	C5023	F1H0J1050012	C 1UF, K, 16V	1	
	C5024	F1H0J1050012	C 1UF, K, 16V	1	
	C5025	F1J1A106A043	C 0.010UF, K, 10V	1	
	C5026	F1J1A106A043	C 0.010UF, K, 10V	1	
	C5027	F1G1C104A116	C 0.10UF, K, 16V	1	
	C5028	F1G1C104A116	C 0.10UF, K, 16V	1	
	C5029	F1G1C104A116	C 0.10UF, K, 16V	1	
	C5030	F1G1C104A116	C 0.10UF, K, 16V	1	
	C5031	F1G1C104A116	C 0.10UF, K, 16V	1	
	C5032	F1G1C104A116	C 0.10UF, K, 16V	1	
	C5033	F1H0J1050012	C 1UF, K, 16V	1	
	C5034	F1H0J1050012	C 1UF, K, 16V	1	
	C5035	F1H0J1050012	C 1UF, K, 16V	1	
	C5036	F1H0J1050012	C 1UF, K, 16V	1	
	C5037	F1H0J1050012	C 1UF, K, 16V	1	
	C5038	F1H0J1050012	C 1UF, K, 16V	1	
	C5039	F1J1A106A043	C 0.010UF, K, 10V	1	
	C5040	F1J1A106A043	C 0.010UF, K, 10V	1	
	C5041	F1J1A106A043	C 0.010UF, K, 10V	1	
	C5042	F1G1C104A116	C 0.10UF, K, 16V	1	
	C5043	F1G1C104A116	C 0.10UF, K, 16V	1	
	C5044	F1H0J1050012	C 1UF, K, 16V	1	
	C5045	F1H0J1050012	C 1UF, K, 16V	1	
	C5046	F1J1A106A043	C 0.010UF, K, 10V	1	
	C5047	F1H0J1050012	C 1UF, K, 16V	1	
	C5048	F1H0J2250008	C 2.2UF, K, 16V	1	
	C5049	F1G1C104A116	C 0.10UF, K, 16V	1	
	C5050	F1H0J1050012	C 1UF, K, 16V	1	
	C5051	F1J1A106A043	C 0.010UF, K, 10V	1	
	C5052	F1J1A106A043	C 0.010UF, K, 10V	1	
	C5053	F1G1C104A116	C 0.10UF, K, 16V	1	
	C5054	F1G1C104A116	C 0.10UF, K, 16V	1	
	C5055	F1G1C104A116	C 0.10UF, K, 16V	1	
	C5056	F1G1C104A116	C 0.10UF, K, 16V	1	
	C5057	F1G1C104A116	C 0.10UF, K, 16V	1	
	C5058	ECGRLOG680ER	C 68PF, J, 4V	1	
	C5059	F1G1C104A116	C 0.10UF, K, 16V	1	
	C5060	F1G1C104A116	C 0.10UF, K, 16V	1	
	C5061	F1G1C104A116	C 0.10UF, K, 16V	1	
	C5062	F1G1C104A116	C 0.10UF, K, 16V	1	
	C5063	F1G1C104A116	C 0.10UF, K, 16V	1	
	C5064	F1G1C104A116	C 0.10UF, K, 16V	1	
	C5065	F1G1C104A116	C 0.10UF, K, 16V	1	
	C5066	F1G1C104A116	C 0.10UF, K, 16V	1	
	C5067	F1G1C104A116	C 0.10UF, K, 16V	1	
	C5072	F1G1C104A116	C 0.10UF, K, 16V	1	
	C5073	F1H0J2250008	C 2.2UF, K, 16V	1	
	C5200	F1H1H180A971	C 18PF, K, 50V	1	
	C5201	F1H1H180A971	C 18PF, K, 50V	1	
	C5301	F1H1A1050032	C 10UF, 50V	1	
	C5302	F1G1C104A081	C 0.10UF, K, 16V	1	
	C5303	F1H1A1050032	C 10UF, 50V	1	
	C5311	ECJ3YB1E106M	C 10 UF, K, 25V	1	
	C5312	ECJ3YB1E106M	C 10 UF, K, 25V	1	
	C5316	F1G1A473A053	C 0.47UF, 10V	1	

Safety	Ref. No.	Part No.	Part Name & Description	Pcs	Remarks
	C5317	F1H1A1050032	C 10UF, 50V	1	
	C5320	F1H1E104A129	C 0.1UF, 25V	1	
	C5321	F1G1E103A123	C 0.010UF, K, 16V	1	
	C5322	F1J1A475A039	C 4.7UF, K, 10V	1	
	C5323	F1G1H471A730	C 470UF, 50V	1	
	C5324	F1G1H221A730	C 220UF, 50V	1	
	C5325	F1G1E103A123	C 0.010UF, K, 16V	1	
	C5326	F1G1C104A116	C 0.10UF, K, 16V	1	
	C5327	F1G1C104A116	C 0.10UF, K, 16V	1	
	C5328	ECGRLOG680ER	C 68PF, J, 4V	1	
	C5329	ECGRLOG680ER	C 68PF, J, 4V	1	
	C5341	F1G1C104A116	C 0.10UF, K, 16V	1	
	C5395	F1J1E105A171	C 1 UF 25V	1	
	C5396	EEHBE1E470P	C 47PF, J, 25V	1	
	C5397	ECJ3YB1E106M	C 10 UF, K, 25V	1	
	C5399	ECJ3YB1E106M	C 10 UF, K, 25V	1	
	C5432	ECJ3YB1E106M	C 10 UF, K, 25V	1	
	C5433	F1J1A106A043	C 0.010UF, K, 10V	1	
	C5434	F1J1A106A043	C 0.010UF, K, 10V	1	
	C5435	F1G1E103A123	C 0.010UF, K, 16V	1	
	C5436	F1H1E104A129	C 0.1UF, 25V	1	
	C5441	F1H1E104A129	C 0.1UF, 25V	1	
	C5442	F1H1H682A970	C 6800PF, K, 50V	1	PAVCCZ
	C5443	F2H0J2210005	C 220UF, 6.3V	1	
	C5452	ECJ3YB1E106M	C 10 UF, K, 25V	1	
	C5453	F1J1A106A043	C 0.010UF, K, 10V	1	
	C5454	F1J1A106A043	C 0.010UF, K, 10V	1	
	C5455	F1G1E103A123	C 0.010UF, K, 16V	1	
	C5456	F1H1E104A129	C 0.1UF, 25V	1	
	C5461	F1H1E104A129	C 0.1UF, 25V	1	
	C5462	F1H1H392A970	C 3900PF, K, 50V	1	
	C5463	F1G1C104A116	C 0.10UF, K, 16V	1	
	C5464	F1J1A106A043	C 0.010UF, K, 10V	1	
	C5465	F1J1A106A043	C 0.010UF, K, 10V	1	
	C5466	F1J1A106A043	C 0.010UF, K, 10V	1	
	C5467	F1G1C104A081	C 0.10UF, K, 16V	1	
	C5468	F2G0G101A007	E 100UF 6.3V	1	
	C5469	F2G0G101A007	E 100UF 6.3V	1	
	C5470	F1J0J106A020	C 0.010UF, K, 16V	1	
	C5471	F1J0J106A020	C 0.010UF, K, 16V	1	
	C5472	F1G1C104A116	C 0.10UF, K, 16V	1	
	C5473	F2H0J1010009	C 100UF, 6.3V	1	
	C5474	F1G1C104A116	C 0.10UF, K, 16V	1	
	C5475	F2G1C1010034	E 100PF, J, 16V	1	
	C5476	F1G1C104A116	C 0.10UF, K, 16V	1	
	C5477	F2H0J1010009	C 100UF, 6.3V	1	
	C5478	F1G1C104A116	C 0.10UF, K, 16V	1	
	C5501	F2A1C471A537	E 470UF, 16V	1	
	C5502	ECJ2VB1C104K	C 0.1UF, K, 16V	1	
	C5503	F2A1C471A537	E 470UF, 16V	1	
	C5504	ECJ2VB1C104K	C 0.1UF, K, 16V	1	
	C5505	F2A1E102A220	E 1000UF, 25V	1	
	C5506	ECJ2VB1E104K	C 0.1UF, K, 25V	1	
	C5521	F1G1C104A116	C 0.10UF, K, 16V	1	
	C5522	F1G1C104A116	C 0.10UF, K, 16V	1	
	C5531	F1H1A1050032	C 10UF, 50V	1	
	C5533	F1J1A106A043	C 0.010UF, K, 10V	1	
	C5541	F1H1E104A129	C 0.1UF, 25V	1	
	C5542	F1H1A1050032	C 10UF, 50V	1	
	C5543	F1G1H471A731	C 470UF, 50V	1	
	C5544	F1J0J106A020	C 0.010UF, K, 16V	1	

Safety	Ref. No.	Part No.	Part Name & Description	Pcs	Remarks
	C5545	FIG1A104A012	C 0.01UF, K, 10V	1	
	C5546	F2G0G101A007	E 100UF 6.3V	1	
	C5595	F2G1C2200036	E 22UF, 16V	1	
	C5600	FIH1A1050032	C 10UF, 50V	1	
	C5601	FIG1C104A116	C 0.10UF, K, 16V	1	
	C5602	ECGRLOG680ER	C 68PF, J, 4V	1	
	C5603	FIG1E103A123	C 0.010UF, K, 16V	1	
	C5604	FIG1C223A116	C 0.022UF, K, 16V	1	
	C5605	FIJ1A475A039	C 4.7UF, K, 10V	1	
	C5606	FIG1H471A730	C 470UF, 50V	1	
	C5607	FIG1H221A731	C 220UF, 50V	1	
	C5608	FIG1C104A116	C 0.10UF, K, 16V	1	
	C5611	ECJ3YB1E106M	C 10 UF, K, 25V	1	
	C5612	ECJ3YB1E106M	C 10 UF, K, 25V	1	
	C5615	ECJ3YB1E106M	C 10 UF, K, 25V	1	
	C5616	FIG1C223A116	C 0.022UF, K, 16V	1	
	C5617	FIH1A1050032	C 10UF, 50V	1	
	C5618	ECJ3YB1E106M	C 10 UF, K, 25V	1	
	C5619	ECJ3YB1E106M	C 10 UF, K, 25V	1	
	C5620	FIH1E104A129	C 0.1UF, 25V	1	
	C5621	FIG1A473A053	C 0.47UF, 10V	1	
	C5622	FIJ1A475A039	C 4.7UF, K, 10V	1	
	C5623	FIG1H221A730	C 220UF, 50V	1	
	C5624	FIG1H221A730	C 220UF, 50V	1	
	C5625	FIG1E103A123	C 0.010UF, K, 16V	1	
	C5626	FIG1C104A116	C 0.10UF, K, 16V	1	
	C5627	FIG1C104A116	C 0.10UF, K, 16V	1	
	C5628	ECGRLOG680ER	C 68PF, J, 4V	1	
	C5629	ECGRLOG680ER	C 68PF, J, 4V	1	
	C5631	EEHBE1E470P	C 47PF, J, 25V	1	
	C5632	FIJ1E105A171	C 1 UF 25V	1	
	C5636	FIG1C104A116	C 0.10UF, K, 16V	1	
	C5637	FIG1C104A116	C 0.10UF, K, 16V	1	
	C5638	FIG1C104A116	C 0.10UF, K, 16V	1	
	C5639	FIG1C104A116	C 0.10UF, K, 16V	1	
	C5640	FIG1C104A116	C 0.10UF, K, 16V	1	
	C5641	FIG1C104A116	C 0.10UF, K, 16V	1	
	C5642	ECJ3YB1E106M	C 10 UF, K, 25V	1	
	C5643	FIH1E104A129	C 0.1UF, 25V	1	
	C5644	FIG1E103A123	C 0.010UF, K, 16V	1	
	C5661	FIG1E103A123	C 0.010UF, K, 16V	1	
	C5662	FIG1A473A053	C 0.47UF, 10V	1	
	C5663	FIG1E103A123	C 0.010UF, K, 16V	1	
	C5688	FIH1A225A051	C 22UF, 50V	1	
	C5691	EEHBE1C220UR	C 22PF, J, 16V	1	
	C5695	F2G0J470A019	E 47UF 6.3V	1	
	C5730	FIG1E103A123	C 0.010UF, K, 16V	1	
	C5731	F2G0J470A019	E 47UF 6.3V	1	
	C7700	FIH1C104A143	C 0.1UF, K, 16V	1	
	C7701	FIH1A225A051	C 22UF, 50V	1	
	C7702	F2G0G101A007	E 100UF 6.3V	1	
	C7704	FIH1A1050032	C 10UF, 50V	1	
	C7705	FIH1C104A143	C 0.1UF, K, 16V	1	
	C7706	FIH1A1050032	C 10UF, 50V	1	
	C7708	FIH1A1050032	C 10UF, 50V	1	
	C7709	FIH1A225A051	C 22UF, 50V	1	
	C7710	FIJ0J106A020	C 0.010UF, K, 16V	1	
	C7711	FIJ0J106A020	C 0.010UF, K, 16V	1	
	C7712	FIH1C104A143	C 0.1UF, K, 16V	1	
	C7713	FIH1H150A971	C 15PF, K, 50V	1	
	C7714	FIH1C104A143	C 0.1UF, K, 16V	1	
	C7715	FIH1H220A971	C 22PF, K, 50V	1	PAVCCZ
	C7716	FIJ0J106A020	C 0.010UF, K, 16V	1	
	C7717	FIH1C104A143	C 0.1UF, K, 16V	1	

Safety	Ref. No.	Part No.	Part Name & Description	Pcs	Remarks
	C7718	FIJ0J106A020	C 0.010UF, K, 16V	1	
	C7719	FIH1C104A143	C 0.1UF, K, 16V	1	
	C7720	FIH1C104A143	C 0.1UF, K, 16V	1	
	C7721	FIJ0J106A020	C 0.010UF, K, 16V	1	
	C7724	FIH1H150A971	C 15PF, K, 50V	1	
	C7725	FIH1H150A971	C 15PF, K, 50V	1	
	C7729	FIH1H150A971	C 15PF, K, 50V	1	
	C7731	FIH1H150A971	C 15PF, K, 50V	1	
	C7732	FIH1C104A144	C 0.1UF, K, 16V	1	
	C7733	FIH1C104A144	C 0.1UF, K, 16V	1	
	C7736	FIH1C104A144	C 0.1UF, K, 16V	1	
	C7737	FIJ0J106A020	C 0.010UF, K, 16V	1	
	C7738	F2G0G101A007	E 100UF 6.3V	1	
	C7742	FIJ0J106A020	C 0.010UF, K, 16V	1	
	C8001	FIG1A104A012	C 0.01UF, K, 10V	1	
	C8002	FIG1A104A012	C 0.01UF, K, 10V	1	
	C8003	FIG1A104A012	C 0.01UF, K, 10V	1	
	C8004	FIG1A104A012	C 0.01UF, K, 10V	1	
	C8005	FIG1A104A012	C 0.01UF, K, 10V	1	
	C8006	FIG1A104A012	C 0.01UF, K, 10V	1	
	C8007	FIG1A104A012	C 0.01UF, K, 10V	1	
	C8008	FIG1A104A012	C 0.01UF, K, 10V	1	
	C8009	FIG1A104A012	C 0.01UF, K, 10V	1	
	C8010	FIG1A104A012	C 0.01UF, K, 10V	1	
	C8011	FIJ1A106A043	C 0.010UF, K, 10V	1	
	C8012	FIJ1A106A043	C 0.010UF, K, 10V	1	
	C8014	FIG1A104A012	C 0.01UF, K, 10V	1	
	C8015	FIG1A104A012	C 0.01UF, K, 10V	1	
	C8016	FIG1A104A012	C 0.01UF, K, 10V	1	
	C8017	FIG1A104A012	C 0.01UF, K, 10V	1	
	C8018	FIG1A104A012	C 0.01UF, K, 10V	1	
	C8019	FIG1A104A012	C 0.01UF, K, 10V	1	
	C8020	FIG1A104A012	C 0.01UF, K, 10V	1	
	C8021	FIG1A104A012	C 0.01UF, K, 10V	1	
	C8022	FIG1A104A012	C 0.01UF, K, 10V	1	
	C8023	FIG1A104A012	C 0.01UF, K, 10V	1	
	C8024	FIG1A104A012	C 0.01UF, K, 10V	1	
	C8025	FIJ1A106A043	C 0.010UF, K, 10V	1	
	C8026	FIJ1A106A043	C 0.010UF, K, 10V	1	
	C8027	FIG1A104A012	C 0.01UF, K, 10V	1	
	C8028	FIG1A104A012	C 0.01UF, K, 10V	1	
	C8029	FIG1A104A012	C 0.01UF, K, 10V	1	
	C8030	FIG1A104A012	C 0.01UF, K, 10V	1	
	C8031	FIG1A104A012	C 0.01UF, K, 10V	1	
	C8032	FIG1A104A012	C 0.01UF, K, 10V	1	
	C8033	FIJ1A106A043	C 0.010UF, K, 10V	1	
	C8034	FIG1A104A012	C 0.01UF, K, 10V	1	
	C8035	FIG1A104A012	C 0.01UF, K, 10V	1	
	C8036	FIG1A104A012	C 0.01UF, K, 10V	1	
	C8037	FIG1A104A012	C 0.01UF, K, 10V	1	
	C8038	FIG1A104A012	C 0.01UF, K, 10V	1	
	C8039	FIG1A104A012	C 0.01UF, K, 10V	1	
	C8040	FIG1A104A012	C 0.01UF, K, 10V	1	
	C8041	FIG1A104A012	C 0.01UF, K, 10V	1	
	C8042	FIG1A104A012	C 0.01UF, K, 10V	1	
	C8043	FIG1A104A012	C 0.01UF, K, 10V	1	
	C8044	FIG1A104A012	C 0.01UF, K, 10V	1	
	C8045	FIJ1A106A043	C 0.010UF, K, 10V	1	
	C8046	FIJ1A106A043	C 0.010UF, K, 10V	1	
	C8047	FIJ1A106A043	C 0.010UF, K, 10V	1	
	C8048	FIJ1A106A043	C 0.010UF, K, 10V	1	
	C8049	FIG1A104A012	C 0.01UF, K, 10V	1	
	C8050	FIG1A104A012	C 0.01UF, K, 10V	1	

Safety	Ref. No.	Part No.	Part Name & Description	Pcs	Remarks
	C8051	F1G1A104A012	C 0.01UF, K, 10V	1	
	C8052	F1G1A104A012	C 0.01UF, K, 10V	1	
	C8053	F1G1A104A012	C 0.01UF, K, 10V	1	
	C8054	F1G1A104A012	C 0.01UF, K, 10V	1	
	C8055	F1G1A104A012	C 0.01UF, K, 10V	1	
	C8056	F1G1A104A012	C 0.01UF, K, 10V	1	
	C8057	F1G1A104A012	C 0.01UF, K, 10V	1	
	C8058	F1G1A104A012	C 0.01UF, K, 10V	1	
	C8059	F1G1A104A012	C 0.01UF, K, 10V	1	
	C8060	F1H0J1050012	C 1UF, K, 16V	1	
	C8061	F1H0J1050012	C 1UF, K, 16V	1	
	C8062	F1G1A104A012	C 0.01UF, K, 10V	1	
	C8070	F1H0J1050012	C 1UF, K, 16V	1	
	C8071	F1H0J1050012	C 1UF, K, 16V	1	
	C8072	F1G1A104A012	C 0.01UF, K, 10V	1	
	C8073	F1H0J1050012	C 1UF, K, 16V	1	
	C8074	F1G1A104A012	C 0.01UF, K, 10V	1	
	C8075	F1H0J1050012	C 1UF, K, 16V	1	
	C8076	F1G1A104A012	C 0.01UF, K, 10V	1	
	C8077	F1G1A104A012	C 0.01UF, K, 10V	1	
	C8078	F1G1A104A012	C 0.01UF, K, 10V	1	
	C8079	F1G1A104A012	C 0.01UF, K, 10V	1	
	C8080	F1G1A104A012	C 0.01UF, K, 10V	1	
	C8081	F1G1A104A012	C 0.01UF, K, 10V	1	
	C8082	F1G1A104A012	C 0.01UF, K, 10V	1	
	C8083	F1G1A104A012	C 0.01UF, K, 10V	1	
	C8084	F1G1A104A012	C 0.01UF, K, 10V	1	
	C8085	F1G1A104A012	C 0.01UF, K, 10V	1	
	C8101	F1G1H180A731	C 18UF, 50V	1	
	C8102	F1G1H7R0A732	C 7.0UF, 50V	1	
	C8103	F1H0J1050012	C 1UF, K, 16V	1	
	C8104	F1G1C1030008	C 0.010UF, K, 16V	1	
	C8105	F1J1A106A043	C 0.010UF, K, 10V	1	
	C8106	F1G1A104A012	C 0.01UF, K, 10V	1	
	C8107	F1G1A104A012	C 0.01UF, K, 10V	1	
	C8201	F1G1A105A047	C 1UF, K, 10V	1	
	C8202	ECCMX0E101R	E 100UF, 10V	1	
	C8203	F1G1A105A047	C 1UF, K, 10V	1	
	C8204	F1G1A105A047	C 1UF, K, 10V	1	
	C8205	F1G1A105A047	C 1UF, K, 10V	1	
	C8206	F1G1A105A047	C 1UF, K, 10V	1	
	C8208	F1G1A104A012	C 0.01UF, K, 10V	1	
	C8209	F1G1A105A047	C 1UF, K, 10V	1	
	C8210	F1G1A105A047	C 1UF, K, 10V	1	
	C8211	F1G1A105A047	C 1UF, K, 10V	1	
	C8212	F1G1A105A047	C 1UF, K, 10V	1	
	C8213	F1G1A105A047	C 1UF, K, 10V	1	
	C8214	F1G1A104A012	C 0.01UF, K, 10V	1	
	C8215	F1G1A104A012	C 0.01UF, K, 10V	1	
	C8216	F1G1A104A012	C 0.01UF, K, 10V	1	
	C8217	F1G1A104A012	C 0.01UF, K, 10V	1	
	C8218	F1G1A104A012	C 0.01UF, K, 10V	1	
	C8219	F1G1A104A012	C 0.01UF, K, 10V	1	
	C8220	F1G1A104A012	C 0.01UF, K, 10V	1	
	C8221	F1G1A105A047	C 1UF, K, 10V	1	
	C8222	F1G1A105A047	C 1UF, K, 10V	1	
	C8223	F1G1A105A047	C 1UF, K, 10V	1	
	C8224	F1G1A105A047	C 1UF, K, 10V	1	
	C8225	F1G1A105A047	C 1UF, K, 10V	1	
	C8226	F1G1A104A012	C 0.01UF, K, 10V	1	
	C8227	F1G1A104A012	C 0.01UF, K, 10V	1	
	C8228	F1G1A104A012	C 0.01UF, K, 10V	1	
	C8229	F1G1A104A012	C 0.01UF, K, 10V	1	
	C8230	F1G1A105A047	C 1UF, K, 10V	1	
	C8231	ECCMX0E101R	E 100UF, 10V	1	
	C8232	F1G1A105A047	C 1UF, K, 10V	1	
	C8233	F1G1A105A047	C 1UF, K, 10V	1	
	C8234	F1G1A105A047	C 1UF, K, 10V	1	
	C8235	F1G1A105A047	C 1UF, K, 10V	1	
	C8306	F1G1H102A730	C 1000UF, 50V	1	B/E
	C8307	F1G1C104A116	C 0.10UF, K, 16V	1	B/E
	C8309	F1G1C104A116	C 0.10UF, K, 16V	1	B/E

Safety	Ref. No.	Part No.	Part Name & Description	Pcs	Remarks
	C8310	F2G0G101A007	E 100UF 6.3V	1	B/E
	C8311	F1G1H180A731	C 18UF, 50V	1	B/E
	C8312	F1G1H120A731	C 12UF, 50V	1	B/E
	C8313	F1G1E103A123	C 0.010UF, K, 16V	1	B/E
	C8314	F1G1E103A123	C 0.010UF, K, 16V	1	B/E
	C8319	F1G1E103A123	C 0.010UF, K, 16V	1	B/E
	C8320	F1G1E103A123	C 0.010UF, K, 16V	1	B/E
	C8321	F1G1E103A123	C 0.010UF, K, 16V	1	B/E
	C8327	F1H1A1050032	C 10UF, 50V	1	B/E
	C8328	F1H1A1050032	C 10UF, 50V	1	B/E
	C8329	F1G1E103A123	C 0.010UF, K, 16V	1	B/E
	C8330	F1G1E103A123	C 0.010UF, K, 16V	1	B/E
	C8331	F1G1E103A123	C 0.010UF, K, 16V	1	B/E
	C8332	F1G1E103A123	C 0.010UF, K, 16V	1	B/E
	C8333	F1G1E103A123	C 0.010UF, K, 16V	1	B/E
	C8334	F1G1E103A123	C 0.010UF, K, 16V	1	B/E
	C8335	F1G1E103A123	C 0.010UF, K, 16V	1	B/E
	C8336	F1G1E103A123	C 0.010UF, K, 16V	1	B/E
	C8338	F1G1H220A731	C 22UF, 50V	1	B/E
	C8339	F1G1H220A731	C 22UF, 50V	1	B/E
	C8340	F1G1E103A123	C 0.010UF, K, 16V	1	B/E
	C8402	F1G1C104A116	C 0.10UF, K, 16V	1	B/E
	C8404	F1G1C104A116	C 0.10UF, K, 16V	1	B/E
	C8408	F1G1C104A116	C 0.10UF, K, 16V	1	B/E
	C8410	F1G1C104A116	C 0.10UF, K, 16V	1	B/E
	C8411	F2G1A101A019	E 100UF, 10V	1	B/E
	C8412	F1G1C104A116	C 0.10UF, K, 16V	1	B/E
	C8413	F1G1C104A116	C 0.10UF, K, 16V	1	B/E
	C8414	F1G1C104A116	C 0.10UF, K, 16V	1	B/E
	C8416	F1G1E103A123	C 0.010UF, K, 16V	1	B/E
	C8417	F1G1E103A123	C 0.010UF, K, 16V	1	B/E
	C8418	F1G1C104A116	C 0.10UF, K, 16V	1	B/E
	C8419	F1G1C104A116	C 0.10UF, K, 16V	1	B/E
	C8420	F1G1C104A116	C 0.10UF, K, 16V	1	B/E
	C8421	F1G1C104A116	C 0.10UF, K, 16V	1	B/E
	C8422	F1G1C104A116	C 0.10UF, K, 16V	1	B/E
	C8423	F1G1C104A116	C 0.10UF, K, 16V	1	B/E
	C8424	F1G1C104A116	C 0.10UF, K, 16V	1	B/E
	C8426	F2G1A101A019	E 100UF, 10V	1	B/E
	C8501	F2G0J470A019	E 47UF 6.3V	1	
	C8580	F1G1C104A116	C 0.10UF, K, 16V	1	
	C8581	F1G1C104A116	C 0.10UF, K, 16V	1	
	C8601	F1G1C104A116	C 0.10UF, K, 16V	1	
	C8620	F1G1A104A012	C 0.01UF, K, 10V	1	
	C8621	F1G1A104A012	C 0.01UF, K, 10V	1	
	C8622	F1G1A104A012	C 0.01UF, K, 10V	1	
	C8623	F1J1A106A043	C 0.010UF, K, 10V	1	
	C8624	F1G1A104A012	C 0.01UF, K, 10V	1	
	C8625	F1G1H5R0A732	C 5.0PF, K, 50V	1	
	C8626	F1G1H5R0A732	C 5.0PF, K, 50V	1	
	C8627	F1G1A104A012	C 0.01UF, K, 10V	1	
	C8628	F1J1A106A043	C 0.010UF, K, 10V	1	
	C8629	F1J1A106A043	C 0.010UF, K, 10V	1	
	C8630	F1G1A104A012	C 0.01UF, K, 10V	1	
	C8631	F1G1A104A012	C 0.01UF, K, 10V	1	
	C8632	F1G1A104A012	C 0.01UF, K, 10V	1	
	C8633	F1J1A106A043	C 0.010UF, K, 10V	1	

Safety	Ref. No.	Part No.	Part Name & Description	Pcs	Remarks
	C8634	FIG1A104A012	C 0.01UF, K, 10V	1	
	C8635	FIG1A104A012	C 0.01UF, K, 10V	1	
	C8637	F2G0J101A019	E 100UF 6.3V	1	
	C8638	FIH0J1050012	C 1UF, K, 16V	1	
	C8639	FIG1A104A012	C 0.01UF, K, 10V	1	
	C8640	FIJ1A106A043	C 0.010UF, K, 10V	1	
	C8641	FIG1A104A012	C 0.01UF, K, 10V	1	
	C8642	FIJ1A106A043	C 0.010UF, K, 10V	1	
	C8643	ECUV1A335KBN	C 33UF 10V	1	
	C8644	FIG1A104A012	C 0.01UF, K, 10V	1	
	C8645	FIG1A104A012	C 0.01UF, K, 10V	1	
	C8646	FIG1A104A012	C 0.01UF, K, 10V	1	
	C8647	FIJ1A106A043	C 0.010UF, K, 10V	1	
	C8648	FIG1A104A012	C 0.01UF, K, 10V	1	
	C8649	FIG1A104A012	C 0.01UF, K, 10V	1	
	C8650	FIJ1A106A043	C 0.010UF, K, 10V	1	
	C8651	FIG1A104A012	C 0.01UF, K, 10V	1	
	C8652	FIG1A104A012	C 0.01UF, K, 10V	1	
	C8653	FIG1A104A012	C 0.01UF, K, 10V	1	
	C8654	FIG1A104A012	C 0.01UF, K, 10V	1	
	C8851	FIG1C1030008	C 0.010UF, K, 16V	1	
	C8852	FIG1H680A731	C 68UF, 50V	1	
	C8853	FIG1H680A731	C 68UF, 50V	1	
	C8854	FIG1H680A731	C 68UF, 50V	1	
	C8855	FIG1H680A731	C 68UF, 50V	1	
	C8856	FIG1C1030008	C 0.010UF, K, 16V	1	
	C8951	FIG1C104A116	C 0.10UF, K, 16V	1	B/E
	C8952	ECJ3YB1E106M	C 10 UF, K, 25V	1	B/E
	C8953	FIJ1A106A043	C 0.010UF, K, 10V	1	B/E
	C8954	FIG1C104A116	C 0.10UF, K, 16V	1	B/E
	C8955	FIG1C104A116	C 0.10UF, K, 16V	1	B/E
	C8956	ECJ3YB1E106M	C 10 UF, K, 25V	1	B/E
	C9001	ECJ1VB1H104K	C 0.1UF, K, 50V	1	
	C9033	FIG1C104A119	C 0.10UF, K, 16V	1	
	C9034	FIG1C104A119	C 0.10UF, K, 16V	1	
	C9035	FIJ1A106A043	C 0.010UF, K, 10V	1	
	C9036	FIJ1A106A043	C 0.010UF, K, 10V	1	
	C9037	FIG1E103A123	C 0.010UF, K, 16V	1	
	C9055	FIG1C104A119	C 0.10UF, K, 16V	1	
	C9056	FIG1C104A119	C 0.10UF, K, 16V	1	
	C9057	FIG1C104A119	C 0.10UF, K, 16V	1	
	C9058	FIJ1A106A043	C 0.010UF, K, 10V	1	
	C9067	FIG1E103A123	C 0.010UF, K, 16V	1	
	C9068	FIG1E103A123	C 0.010UF, K, 16V	1	
	C9069	FIG1E103A123	C 0.010UF, K, 16V	1	
	C9096	FIG1C104A116	C 0.10UF, K, 16V	1	
	C9097	FIG1C104A116	C 0.10UF, K, 16V	1	
	C9098	FIG1C104A116	C 0.10UF, K, 16V	1	
	C9099	FIG1C104A116	C 0.10UF, K, 16V	1	
	C9100	FIG1C104A116	C 0.10UF, K, 16V	1	
	C9101	FIG1C104A116	C 0.10UF, K, 16V	1	
	C9102	FIG1C104A116	C 0.10UF, K, 16V	1	
	C9103	FIG1C104A116	C 0.10UF, K, 16V	1	
	C9104	FIG1C104A116	C 0.10UF, K, 16V	1	
	C9105	FIG1C104A116	C 0.10UF, K, 16V	1	
	C9106	FIG1C104A116	C 0.10UF, K, 16V	1	
	C9107	FIG1C104A116	C 0.10UF, K, 16V	1	
	C9108	FIG1C104A116	C 0.10UF, K, 16V	1	
	C9109	FIG1C104A116	C 0.10UF, K, 16V	1	
	C9110	FIG1C104A116	C 0.10UF, K, 16V	1	
	C9111	FIG1C104A116	C 0.10UF, K, 16V	1	
	C9112	FIG1C104A116	C 0.10UF, K, 16V	1	

Safety	Ref. No.	Part No.	Part Name & Description	Pcs	Remarks
	C9113	FIG1C104A116	C 0.10UF, K, 16V	1	
	C9114	FIG1C104A116	C 0.10UF, K, 16V	1	
	C9115	FIG1C104A116	C 0.10UF, K, 16V	1	
	C9116	FIG1C104A116	C 0.10UF, K, 16V	1	
	C9117	FIG1C104A116	C 0.10UF, K, 16V	1	
	C9119	FIG1C104A116	C 0.10UF, K, 16V	1	
	C9120	FIG1C104A116	C 0.10UF, K, 16V	1	
	C9121	FIG1C104A116	C 0.10UF, K, 16V	1	
	C9122	FIG1C104A116	C 0.10UF, K, 16V	1	
	C9123	FIG1C104A116	C 0.10UF, K, 16V	1	
	C9124	FIG1C104A116	C 0.10UF, K, 16V	1	
	C9125	FIG1C104A116	C 0.10UF, K, 16V	1	
	C9126	FIG1C104A116	C 0.10UF, K, 16V	1	
	C9127	FIG1C104A116	C 0.10UF, K, 16V	1	
	C9128	FIG1C104A116	C 0.10UF, K, 16V	1	
	C9129	FIG1C104A116	C 0.10UF, K, 16V	1	
	C9130	FIG1C104A116	C 0.10UF, K, 16V	1	
	C9131	FIG1C104A116	C 0.10UF, K, 16V	1	
	C9132	FIG1C104A116	C 0.10UF, K, 16V	1	
	C9133	FIG1C104A116	C 0.10UF, K, 16V	1	
	C9135	FIJ1A106A043	C 0.010UF, K, 10V	1	
	C9136	FIG1C104A119	C 0.10UF, K, 16V	1	
	C9142	FIG1C104A116	C 0.10UF, K, 16V	1	
	C9143	FIG1C104A119	C 0.10UF, K, 16V	1	
	C9144	FIG1C104A116	C 0.10UF, K, 16V	1	
	C9145	FIG1C104A116	C 0.10UF, K, 16V	1	
	C9146	FIG1C104A116	C 0.10UF, K, 16V	1	
	C9147	FIG1C104A116	C 0.10UF, K, 16V	1	
	C9148	FIG1C104A116	C 0.10UF, K, 16V	1	
	C9149	FIG1C104A116	C 0.10UF, K, 16V	1	
	C9150	FIG1C104A116	C 0.10UF, K, 16V	1	
	C9152	FIJ0J475A035	C 4.7UF, K, 16V	1	
	C9153	FIG1C104A119	C 0.10UF, K, 16V	1	
	C9154	FIG1C104A119	C 0.10UF, K, 16V	1	
	C9155	FIG1C104A119	C 0.10UF, K, 16V	1	
	C9156	FIG1C104A119	C 0.10UF, K, 16V	1	
	C9157	FIG1C104A119	C 0.10UF, K, 16V	1	
	C9158	FIG1C104A119	C 0.10UF, K, 16V	1	
	C9159	FIG1C104A119	C 0.10UF, K, 16V	1	
	C9160	FIG1C104A119	C 0.10UF, K, 16V	1	
	C9161	FIG1C104A119	C 0.10UF, K, 16V	1	
	C9162	FIG1C104A119	C 0.10UF, K, 16V	1	
	C9163	FIJ0J475A035	C 4.7UF, K, 16V	1	
	C9164	FIG1C104A119	C 0.10UF, K, 16V	1	
	C9165	FIG1C104A119	C 0.10UF, K, 16V	1	
	C9168	FIG1C104A119	C 0.10UF, K, 16V	1	
	C9169	FIG1C104A116	C 0.10UF, K, 16V	1	
	C9170	FIG1C104A116	C 0.10UF, K, 16V	1	
	C9171	FIG1C104A116	C 0.10UF, K, 16V	1	
	C9172	FIG1C104A116	C 0.10UF, K, 16V	1	
	C9173	FIG1C104A116	C 0.10UF, K, 16V	1	
	C9174	FIG1C104A116	C 0.10UF, K, 16V	1	
	C9175	FIG1C104A116	C 0.10UF, K, 16V	1	
	C9176	FIG1C104A116	C 0.10UF, K, 16V	1	
	C9177	FIG1C104A116	C 0.10UF, K, 16V	1	
	C9178	FIG1C104A116	C 0.10UF, K, 16V	1	
	C9179	FIG1C104A116	C 0.10UF, K, 16V	1	
	C9180	FIG1C104A116	C 0.10UF, K, 16V	1	
	C9181	FIG1C104A116	C 0.10UF, K, 16V	1	
	C9182	FIG1C104A116	C 0.10UF, K, 16V	1	
	C9183	FIG1C104A116	C 0.10UF, K, 16V	1	
	C9184	FIG1C104A116	C 0.10UF, K, 16V	1	
	C9185	FIG1C104A116	C 0.10UF, K, 16V	1	
	C9186	FIG1C104A116	C 0.10UF, K, 16V	1	
	C9187	FIG1C104A116	C 0.10UF, K, 16V	1	
	C9188	FIG1C104A116	C 0.10UF, K, 16V	1	
	C9189	FIG1C104A116	C 0.10UF, K, 16V	1	
	C9190	FIG1C104A116	C 0.10UF, K, 16V	1	
	C9191	FIG1C104A116	C 0.10UF, K, 16V	1	
	C9192	FIG1C104A116	C 0.10UF, K, 16V	1	
	C9193	FIG1C104A116	C 0.10UF, K, 16V	1	
	C9194	FIG1C104A116	C 0.10UF, K, 16V	1	

Safety	Ref. No.	Part No.	Part Name & Description	Pcs	Remarks
	C9195	F1G1C104A116	C 0.10UF, K, 16V	1	
	C9196	F1G1C104A116	C 0.10UF, K, 16V	1	
	C9198	F1G1C104A116	C 0.10UF, K, 16V	1	
	C9199	F1G1C104A116	C 0.10UF, K, 16V	1	
	C9200	F1G1C104A116	C 0.10UF, K, 16V	1	
	C9201	F1G1C104A116	C 0.10UF, K, 16V	1	
	C9202	F1G1C104A116	C 0.10UF, K, 16V	1	
	C9203	F1G1C104A116	C 0.10UF, K, 16V	1	
	C9204	F1G1C104A116	C 0.10UF, K, 16V	1	
	C9205	F1G1C104A116	C 0.10UF, K, 16V	1	
	C9206	F1G1C104A116	C 0.10UF, K, 16V	1	
	C9207	F1G1C104A116	C 0.10UF, K, 16V	1	
	C9208	F1G1C104A116	C 0.10UF, K, 16V	1	
	C9209	F1G1C104A116	C 0.10UF, K, 16V	1	
	C9210	F1J1A106A043	C 0.010UF, K, 10V	1	
	C9211	F1G1C104A116	C 0.10UF, K, 16V	1	
	C9212	F1J1A106A043	C 0.010UF, K, 10V	1	
	C9213	F1G1C104A116	C 0.10UF, K, 16V	1	
	C9214	F1G1C104A116	C 0.10UF, K, 16V	1	
	C9215	F1G1C104A116	C 0.10UF, K, 16V	1	
	C9216	F1G1C104A116	C 0.10UF, K, 16V	1	
	C9217	F1G1C104A116	C 0.10UF, K, 16V	1	
	C9218	F1G1C104A116	C 0.10UF, K, 16V	1	
	C9219	F1G1C104A116	C 0.10UF, K, 16V	1	
	C9220	F1G1C104A116	C 0.10UF, K, 16V	1	
	C9221	F1G1C104A116	C 0.10UF, K, 16V	1	
	C9222	F1G1C104A116	C 0.10UF, K, 16V	1	
	C9223	F1G1C104A116	C 0.10UF, K, 16V	1	
	C9224	F1G1C104A116	C 0.10UF, K, 16V	1	
	C9226	F1G1C104A116	C 0.10UF, K, 16V	1	
	C9227	F1G1C104A116	C 0.10UF, K, 16V	1	
	C9228	F1G1C104A116	C 0.10UF, K, 16V	1	
	C9230	F1G1C104A116	C 0.10UF, K, 16V	1	
	C9231	F1G1C104A116	C 0.10UF, K, 16V	1	
	C9232	F1G1C104A116	C 0.10UF, K, 16V	1	
	C9233	F1G1C104A116	C 0.10UF, K, 16V	1	
	C9234	F1G1C104A116	C 0.10UF, K, 16V	1	
	C9235	F1G1C104A116	C 0.10UF, K, 16V	1	
	C9236	F1G1C104A116	C 0.10UF, K, 16V	1	
	C9237	F1J1A106A043	C 0.010UF, K, 10V	1	
	C9239	F1G1C104A116	C 0.10UF, K, 16V	1	
	C9240	F1G1C104A116	C 0.10UF, K, 16V	1	
	C9241	F1G1C104A116	C 0.10UF, K, 16V	1	
	C9242	F1G1C104A116	C 0.10UF, K, 16V	1	
	C9243	F1G1C104A116	C 0.10UF, K, 16V	1	
	C9244	F1G1C104A116	C 0.10UF, K, 16V	1	
	C9245	F1J1A106A043	C 0.010UF, K, 10V	1	
	C9246	F1G1C104A116	C 0.10UF, K, 16V	1	
	C9247	F1J1A106A043	C 0.010UF, K, 10V	1	
	C9248	F1G1C104A116	C 0.10UF, K, 16V	1	
	C9249	F1G1C104A116	C 0.10UF, K, 16V	1	
	C9250	F1G1C104A116	C 0.10UF, K, 16V	1	
	C9303	F1J1E105A171	C 1 UF 25V	1	
	C9304	F1J1E105A171	C 1 UF 25V	1	
	C9305	F1J1E105A171	C 1 UF 25V	1	
	C9306	F1J1E105A171	C 1 UF 25V	1	
	C9307	F1J1E105A171	C 1 UF 25V	1	
	C9308	F1J1E105A171	C 1 UF 25V	1	
	C9309	F1J1E105A171	C 1 UF 25V	1	
	C9310	F1J1E105A171	C 1 UF 25V	1	
	C9313	F1H1A1050032	C 10UF, 50V	1	
	C9314	F1H1A1050032	C 10UF, 50V	1	
	C9317	ECJ1VB1H104K	C 0.1UF, K, 50V	1	
	C9318	ECJ1VB1H104K	C 0.1UF, K, 50V	1	
	C9319	ECJ1VB1H104K	C 0.1UF, K, 50V	1	
	C9320	ECJ1VB1H104K	C 0.1UF, K, 50V	1	
	C9321	ECJ1VB1H104K	C 0.1UF, K, 50V	1	
	C9322	ECJ1VB1H104K	C 0.1UF, K, 50V	1	
	C9323	ECJ1VB1H104K	C 0.1UF, K, 50V	1	

Safety	Ref. No.	Part No.	Part Name & Description	Pcs	Remarks
	C9324	ECJ1VB1H104K	C 0.1UF, K, 50V	1	
	C9333	F1J1E3340003	C 0.33UF, Z, 25V	1	
	C9334	F1J1E3340003	C 0.33UF, Z, 25V	1	
	C9335	F1J1E3340003	C 0.33UF, Z, 25V	1	
	C9336	F1J1E3340003	C 0.33UF, Z, 25V	1	
	C9337	F1H1H223A970	C 0.22UF, K, 50V	1	
	C9338	F1H1H223A970	C 0.22UF, K, 50V	1	
	C9339	F1H1H223A970	C 0.22UF, K, 50V	1	
	C9340	F1H1H223A970	C 0.22UF, K, 50V	1	
	C9341	F1J1E3340003	C 0.33UF, Z, 25V	1	
	C9342	F1J1E3340003	C 0.33UF, Z, 25V	1	
	C9343	F1J1E3340003	C 0.33UF, Z, 25V	1	
	C9344	F1J1E3340003	C 0.33UF, Z, 25V	1	
	C9345	F1H1H223A970	C 0.22UF, K, 50V	1	
	C9346	F1H1H223A970	C 0.22UF, K, 50V	1	
	C9347	F1H1H223A970	C 0.22UF, K, 50V	1	
	C9348	F1H1H223A970	C 0.22UF, K, 50V	1	
	C9353	ECJ1VB1H104K	C 0.1UF, K, 50V	1	
	C9354	ECJ1VB1H104K	C 0.1UF, K, 50V	1	
	C9359	ECJ1VB1H104K	C 0.1UF, K, 50V	1	
	C9360	ECJ1VB1H104K	C 0.1UF, K, 50V	1	
	C9361	EEFEG1E471P	E 470UF, 25V	1	
	C9362	EEFEG1E471P	E 470UF, 25V	1	
	C9363	ECJ3YB1E106M	C 10 UF, K, 25V	1	
	C9364	ECJ3YB1E106M	C 10 UF, K, 25V	1	
	C9375	F1H1H223A970	C 0.22UF, K, 50V	1	
	C9376	F1H1H223A970	C 0.22UF, K, 50V	1	
	C9377	F1H1H223A970	C 0.22UF, K, 50V	1	
	C9378	F1H1H223A970	C 0.22UF, K, 50V	1	
	C9379	F1H1H223A970	C 0.22UF, K, 50V	1	
	C9380	F1H1H223A970	C 0.22UF, K, 50V	1	
	C9381	F1H1H223A970	C 0.22UF, K, 50V	1	
	C9382	F1H1H223A970	C 0.22UF, K, 50V	1	
	C9383	ECJ1VC1H102K	C 1000PF, K, 50V	1	
	C9384	ECJ1VC1H102K	C 1000PF, K, 50V	1	
	C9385	ECJ1VC1H102K	C 1000PF, K, 50V	1	
	C9386	ECJ1VC1H102K	C 1000PF, K, 50V	1	
	C9387	ECJ1VC1H102K	C 1000PF, K, 50V	1	
	C9388	ECJ1VC1H102K	C 1000PF, K, 50V	1	
	C9389	ECJ1VC1H102K	C 1000PF, K, 50V	1	
	C9390	ECJ1VC1H102K	C 1000PF, K, 50V	1	
	C9406	EEHBE1E470P	C 47PF, J, 25V	1	
	C9407	F1H1C104A143	C 0.1UF, K, 16V	1	
	C9408	F1J1E105A171	C 1 UF 25V	1	
	C9469	F1G1C104A119	C 0.10UF, K, 16V	1	
	C9535	F1G1C104A116	C 0.10UF, K, 16V	1	
	C9536	F1G1C104A116	C 0.10UF, K, 16V	1	
	C9537	F1G1C104A116	C 0.10UF, K, 16V	1	
	C9538	F1G1C104A116	C 0.10UF, K, 16V	1	
	C9539	F1G1C104A116	C 0.10UF, K, 16V	1	
	C9540	F1G1C104A116	C 0.10UF, K, 16V	1	
	C9541	F1G1C104A116	C 0.10UF, K, 16V	1	
	C9542	F1G1C104A116	C 0.10UF, K, 16V	1	
	C9543	F1G1C104A116	C 0.10UF, K, 16V	1	
	C9544	F1G1C104A116	C 0.10UF, K, 16V	1	
	C9545	F1G1C104A116	C 0.10UF, K, 16V	1	
	C9546	F1G1C104A116	C 0.10UF, K, 16V	1	
	C9547	F1G1C104A116	C 0.10UF, K, 16V	1	
	C9548	F1G1C104A116	C 0.10UF, K, 16V	1	
	C9549	F1G1C104A116	C 0.10UF, K, 16V	1	
	C9550	F1G1C104A116	C 0.10UF, K, 16V	1	
	C9551	F1J1A106A043	C 0.010UF, K, 10V	1	
	C9552	F1J1A106A043	C 0.010UF, K, 10V	1	
	C9553	F1J1A106A043	C 0.010UF, K, 10V	1	
	C9823	ECJ3YB1E106M	C 10 UF, K, 25V	1	
	C9825	F1G1H101A731	C 100PF, K, 50V	1	
	C9832	F1J1A106A043	C 0.010UF, K, 10V	1	
	C9837	F1J1A106A043	C 0.010UF, K, 10V	1	

Safety	Ref. No.	Part No.	Part Name & Description	Pcs	Remarks
	C9840	FIG1E103A123	C 0.010UF, K, 16V	1	
	C9841	FIG1C104A119	C 0.10UF, K, 16V	1	
	C9842	FIG1C104A119	C 0.10UF, K, 16V	1	
	C9844	FIG1E103A123	C 0.010UF, K, 16V	1	
	C9845	FIG1C104A119	C 0.10UF, K, 16V	1	
	C9846	FIG1C104A119	C 0.10UF, K, 16V	1	
	C9858	ECJ3YB1E106M	C 10 UF, K, 25V	1	
	C9859	FIG1E103A123	C 0.010UF, K, 16V	1	
	C9860	FLJ0J475A035	C 4.7UF, K, 16V	1	
	C9861	FIH1E104A129	C 0.1UF, 25V	1	
	C9862	FIH1E104A129	C 0.1UF, 25V	1	
	C9863	FLJ0J475A035	C 4.7UF, K, 16V	1	
	C9864	FIH1E104A129	C 0.1UF, 25V	1	
	C9865	ECGRLOG680ER	C 68PF, J, 4V	1	
	C9866	ECGRLOG680ER	C 68PF, J, 4V	1	
	C9867	ECJ3YB1E106M	C 10 UF, K, 25V	1	
	C9868	ECJ3YB1E106M	C 10 UF, K, 25V	1	
	C9869	ECJ3YB1E106M	C 10 UF, K, 25V	1	
	C9870	ECJ3YB1E106M	C 10 UF, K, 25V	1	
	C9871	ECJ3YB1E106M	C 10 UF, K, 25V	1	
	C9872	ECJ3YB1E106M	C 10 UF, K, 25V	1	
	C9873	ECGRLOG680ER	C 68PF, J, 4V	1	
	C9874	FIG1H680A731	C 68UF, 50V	1	
	C9877	FIG1H680A731	C 68UF, 50V	1	
	C9878	FIG1E103A123	C 0.010UF, K, 16V	1	
	C9879	FIG1C153A116	C 0.015UF, K, 16V	1	
	C9880	FIG1A563A032	C 0.56UF, 10V	1	
	C9881	FIG1E103A123	C 0.010UF, K, 16V	1	
	C9882	FIG1C822A116	C 8200UF, K, 16V	1	
	C9883	FIG1H101A731	C 100PF, K, 50V	1	
	C9884	FIG1H102A730	C 1000UF, 50V	1	
	C9885	FIG1H102A730	C 1000UF, 50V	1	
	C9886	FIH1E104A129	C 0.1UF, 25V	1	
	C9887	FIH1E104A129	C 0.1UF, 25V	1	
	C9888	FIG1H361A731	C 360UF, 50V	1	
	C9927	FIG1C104A116	C 0.10UF, K, 16V	1	
	C9928	FIG1C104A116	C 0.10UF, K, 16V	1	
	C9929	FIG1C104A116	C 0.10UF, K, 16V	1	
	C9930	FIG1C104A116	C 0.10UF, K, 16V	1	
	C9931	FIG1C104A116	C 0.10UF, K, 16V	1	
	C9932	FIG1C104A116	C 0.10UF, K, 16V	1	
	C9933	FIG1C104A116	C 0.10UF, K, 16V	1	
	C9934	FIG1C104A116	C 0.10UF, K, 16V	1	
	C9935	FIG1C104A116	C 0.10UF, K, 16V	1	
	C9936	FIG1C104A116	C 0.10UF, K, 16V	1	
	C9937	FIG1C104A116	C 0.10UF, K, 16V	1	
	C9938	FIG1C104A116	C 0.10UF, K, 16V	1	
	C9939	FIG1C104A116	C 0.10UF, K, 16V	1	
	C9940	FIG1C104A116	C 0.10UF, K, 16V	1	
	C9941	FIG1C104A116	C 0.10UF, K, 16V	1	
	C9942	FIG1C104A116	C 0.10UF, K, 16V	1	
	C9943	FIG1C104A116	C 0.10UF, K, 16V	1	
	C9944	FIG1C104A116	C 0.10UF, K, 16V	1	
	C9945	FIG1C104A116	C 0.10UF, K, 16V	1	
	C9946	FIG1C104A116	C 0.10UF, K, 16V	1	
	C9947	FIG1C104A116	C 0.10UF, K, 16V	1	
	C9948	FIG1C104A116	C 0.10UF, K, 16V	1	
	C9951	FIG1C104A116	C 0.10UF, K, 16V	1	
	C9961	FIJ1A106A043	C 0.010UF, K, 10V	1	
	C9966	FIG1C104A116	C 0.10UF, K, 16V	1	
	C9971	FIG1H180A731	C 18UF, 50V	1	
	C9972	FIG1H150A731	C 15UF, 50V	1	
	C14352	FIJ1C1050030	C 1UF, Z, 16V	1	
	C14356	FIJ1C1050030	C 1UF, Z, 16V	1	
	C14360	FIL2E104A028	E 1000UF, 25V	1	
	C14361	FIL2E104A028	E 1000UF, 25V	1	
	C14364	FIJ1C1050030	C 1UF, Z, 16V	1	

Safety	Ref. No.	Part No.	Part Name & Description	Pcs	Remarks
	C14368	FIJ1C1050030	C 1UF, Z, 16V	1	
	C14373	FIJ1H102A834	C 1000UF, 50V	1	
	C14901	FIJ1H102A834	C 1000UF, 50V	1	
	C14902	FIJ1C1050030	C 1UF, Z, 16V	1	
	C14904	FIJ1C1050030	C 1UF, Z, 16V	1	
	C14906	FIJ1C1050030	C 1UF, Z, 16V	1	
	C14908	FIJ1C1050030	C 1UF, Z, 16V	1	
	C14910	FIJ1C1050030	C 1UF, Z, 16V	1	
	C14912	FIJ1C1050030	C 1UF, Z, 16V	1	
	C14920	FIL2E104A028	E 1000UF, 25V	1	
	C14921	FIL2E104A028	E 1000UF, 25V	1	
	C14922	FIL2E104A028	E 1000UF, 25V	1	
	C14923	FIL2E104A028	E 1000UF, 25V	1	
	C14928	FIL2E104A028	E 1000UF, 25V	1	
	C14930	FIL2E104A028	E 1000UF, 25V	1	
	C14931	FIJ1H102A834	C 1000UF, 50V	1	
	C14932	FIL2E104A028	E 1000UF, 25V	1	
	C14934	FIL2E104A028	E 1000UF, 25V	1	
	C14936	FIJ1H471A721	C 470UF, 50V	1	
	C14937	FIJ1H471A721	C 470UF, 50V	1	
	C14938	FIJ1H471A721	C 470UF, 50V	1	
	C14939	FIJ1H471A721	C 470UF, 50V	1	
	C14940	FIJ1H102A834	C 1000UF, 50V	1	
	C14941	FIJ1H471A721	C 470UF, 50V	1	
	C14942	FIJ1H471A721	C 470UF, 50V	1	
	C14943	FIL1E4750012	C 4.7UF, 25V	1	
	C14944	FIJ1H102A836	C 1000UF, 50V	1	
	C14945	FIJ1H101A836	C 100PF, K, 50V	1	
	C14950	FIJ1H471A721	C 470UF, 50V	1	
	C14952	FIJ1C1050030	C 1UF, Z, 16V	1	
	C14955	FIJ1C1050030	C 1UF, Z, 16V	1	
	C14957	FIJ1C1050030	C 1UF, Z, 16V	1	
	C14958	FIJ1C1050030	C 1UF, Z, 16V	1	
	C14961	FIJ1C1050030	C 1UF, Z, 16V	1	
	C14963	FIJ1C1050030	C 1UF, Z, 16V	1	
	C14969	FIJ1H104A835	C 0.10UF, 50V	1	
	C14970	FIJ1H471A721	C 470UF, 50V	1	
	C14971	FIJ1H471A721	C 470UF, 50V	1	
	C14972	FIJ1H471A721	C 470UF, 50V	1	
	C14973	FIJ1H102A834	C 1000UF, 50V	1	
	C14974	FIL2E104A028	E 1000UF, 25V	1	
	C14975	FIL2E104A028	E 1000UF, 25V	1	
	C14976	FIJ1H102A834	C 1000UF, 50V	1	
	C14981	FIJ1H471A721	C 470UF, 50V	1	
	C14982	FIL2E104A028	E 1000UF, 25V	1	
	C14983	FIL2E104A028	E 1000UF, 25V	1	
	C14984	FIL2E104A028	E 1000UF, 25V	1	
	C14985	FIL2E104A028	E 1000UF, 25V	1	
	C14987	FIJ1H104A835	C 0.10UF, 50V	1	
	C14988	FIJ1H104A835	C 0.10UF, 50V	1	
	C14989	FIJ1H471A721	C 470UF, 50V	1	
	C14990	FIJ1H104A835	C 0.10UF, 50V	1	
	C14992	FIH1C105A008	C 1UF, K, 16V	1	
	C16003	FIL2J562A022	C 5600UF, K, 6.3V	1	
	C16011	F2A2E221A183	E 220UF, 250V	1	
	C16013	FOC2E225A230	E 0.022UF, 250V	1	
	C16014	F2A2E221A183	E 220UF, 250V	1	
	C16016	F2A2E221A183	E 220UF, 250V	1	
	C16023	FIL2J562A022	C 5600UF, K, 6.3V	1	
	C16042	FIH1H392A970	C 3900PF, K, 50V	1	
	C16071	FIL2J1020001	C 1000UF, K, 6.3V	1	
	C16092	FIL2J1020001	C 1000UF, K, 6.3V	1	
	C16131	FIL1E4750012	C 4.7UF, 25V	1	
	C16133	FIL1E4750012	C 4.7UF, 25V	1	
	C16135	FIK1E105A029	C 1UF, Z, 25V	1	
	C16151	FIK1E105A029	C 1UF, Z, 25V	1	
	C16152	FIL1E4750012	C 4.7UF, 25V	1	
	C16153	FIL1E4750012	C 4.7UF, 25V	1	
	C16154	FIL1E4750012	C 4.7UF, 25V	1	
	C16192	FIL1E4750012	C 4.7UF, 25V	1	
	C16194	FIL1E4750012	C 4.7UF, 25V	1	
	C16195	FIL1E4750012	C 4.7UF, 25V	1	
	C16197	FIL1E4750012	C 4.7UF, 25V	1	

Safety	Ref. No.	Part No.	Part Name & Description	Pcs	Remarks
	C16201	F0C2E405A232	E 0.040UF, 250V	1	
	C16202	F0C2E405A232	E 0.040UF, 250V	1	
	C16203	F0C2E405A232	E 0.040UF, 250V	1	
	C16241	F2A1A101A106	E 100UF, 10V	1	
	C16242	F1H1C105A008	C 1UF, K, 16V	1	
	C16243	F1J1H103A834	C 0.01UF, K, 50V	1	
	C16251	F1H1C105A008	C 1UF, K, 16V	1	
	C16252	F1K1E105A029	C 1UF, Z, 25V	1	
	C16262	F2A2A471A072	E 470UF, 100V	1	
	C16263	F2A2A471A072	E 470UF, 100V	1	
	C16264	F2A2A471A072	E 470UF, 100V	1	
	C16265	F2A2A471A072	E 470UF, 100V	1	
	C16266	F2A2A471A072	E 470UF, 100V	1	
	C16267	F2A2A471A072	E 470UF, 100V	1	
	C16272	F2A1E471A487	E 470UF, 25V	1	
	C16280	F1K1E105A029	C 1UF, Z, 25V	1	
	C16284	ECJ1VB1H104K	C 0.1UF, K, 50V	1	
	C16285	ECJ1VB1H104K	C 0.1UF, K, 50V	1	
	C16286	ECJ1VB1H104K	C 0.1UF, K, 50V	1	
	C16287	ECJ1VB1H104K	C 0.1UF, K, 50V	1	
	C16301	F2A1E470A454	E 47UF, 25V	1	
	C16302	F1H1H471A219	C 470UF, 50V	1	
	C16310	F2A2E221A183	E 220UF, 250V	1	
	C16311	F1H1A1050032	C 10UF, 50V	1	
	C16312	F1H1H472A970	C 4700PF, K, 50V	1	
	C16313	F1H1C105A008	C 1UF, K, 16V	1	
	C16321	F1L2E224A028	E 2200UF, 25V	1	
	C16322	F1L2E224A028	E 2200UF, 25V	1	
	C16323	F2A1E470A454	E 47UF, 25V	1	
	C16324	F2A1E471A487	E 470UF, 25V	1	
	C16325	F1L1E4750012	C 4.7UF, 25V	1	
	C16326	F1L1E4750012	C 4.7UF, 25V	1	
	C16327	F0C2E225A231	E 0.022UF, 250V	1	
	C16328	F2A2D221A092	E 220UF, 200V	1	
	C16329	F2A2D221A092	E 220UF, 200V	1	
	C16336	F1H1H102A970	C 1000PF, K, 50V	1	
	C16337	ECJ1VB1H104K	C 0.1UF, K, 50V	1	
	C16403	F1L2J562A022	C 5600UF, K, 6.3V	1	
	C16413	F2A2E221A183	E 220UF, 250V	1	
	C16414	F2A2E221A183	E 220UF, 250V	1	
	C16416	F0C2E225A230	E 0.022UF, 250V	1	
	C16418	F2A2E221A183	E 220UF, 250V	1	
	C16419	F2A2E221A183	E 220UF, 250V	1	
	C16424	F1L2J562A022	C 5600UF, K, 6.3V	1	
	C16442	F1H1H392A970	C 3900PF, K, 50V	1	
	C16471	F1L2J1020001	C 1000UF, K, 6.3V	1	
	C16472	F1K1E105A029	C 1UF, Z, 25V	1	
	C16480	F1J1H104A835	C 0.10UF, 50V	1	
	C16491	F1L2J1020001	C 1000UF, K, 6.3V	1	
	C16502	F1L1E4750012	C 4.7UF, 25V	1	
	C16504	F1L1E4750012	C 4.7UF, 25V	1	
	C16505	F1K1E105A029	C 1UF, Z, 25V	1	
	C16521	F1K1E105A029	C 1UF, Z, 25V	1	
	C16522	F1L1E4750012	C 4.7UF, 25V	1	
	C16524	F1L1E4750012	C 4.7UF, 25V	1	
	C16525	F1L1E4750012	C 4.7UF, 25V	1	
	C16562	F1H1C105A008	C 1UF, K, 16V	1	
	C16563	F2A1A101A106	E 100UF, 10V	1	
	C16564	F1H1C105A008	C 1UF, K, 16V	1	
	C16565	F1J1H103A834	C 0.01UF, K, 50V	1	
	C16566	F1J1H103A834	C 0.01UF, K, 50V	1	
	C16581	F1K1E105A029	C 1UF, Z, 25V	1	
	C16582	F1H1C105A008	C 1UF, K, 16V	1	
	C16593	F1J1H102A836	C 1000UF, 50V	1	
	C16603	F1K2J102A014	C 1000UF, K, 6.3V	1	
	C16604	F1K2J102A014	C 1000UF, K, 6.3V	1	
	C16605	F1L2J562A022	C 5600UF, K, 6.3V	1	
	C16606	F1L2J562A022	C 5600UF, K, 6.3V	1	
	C16608	F1H1H221A971	C 220UF, K, 50V	1	
	C16632	F0C2E405A232	E 0.040UF, 250V	1	
	C16633	F0C2E405A232	E 0.040UF, 250V	1	
	C16634	F0C2E405A232	E 0.040UF, 250V	1	
	C16641	ECQE2105RKB	P 1UF, 250V	1	

Safety	Ref. No.	Part No.	Part Name & Description	Pcs	Remarks
	C16661	F1K2J102A014	C 1000UF, K, 6.3V	1	
	C16662	F1K2J102A014	C 1000UF, K, 6.3V	1	
	C16664	F1J1H820A836	C 82UF, 50V	1	
	C16665	F1J1H820A836	C 82UF, 50V	1	
	C16666	F1J1H820A836	C 82UF, 50V	1	
	C16691	ECA2CM101	E 100UF, 160V	1	
	C16708	F1J1H104A835	C 0.10UF, 50V	1	
	C16721	F2A1H101A493	E 100UF, 50V	1	
	C16723	F1L1E4750012	C 4.7UF, 25V	1	
	C16724	F1L1E4750012	C 4.7UF, 25V	1	
	C16725	F1L1E4750012	C 4.7UF, 25V	1	
	C16752	F1K1E105A029	C 1UF, Z, 25V	1	
	C16753	F1L1E4750012	C 4.7UF, 25V	1	
	C16755	F1L1E4750012	C 4.7UF, 25V	1	
	C16756	F1L1E4750012	C 4.7UF, 25V	1	
	C16773	F1L1E4750012	C 4.7UF, 25V	1	
	C16775	F1L1E4750012	C 4.7UF, 25V	1	
	C16791	F2A1E221A487	E 220UF, 25V	1	
	C16795	F2A1E471A487	E 470UF, 25V	1	
	C16797	F1J1H104A835	C 0.10UF, 50V	1	
	C16798	F1L2E1040002	E 1000UF, 25V	1	
	C16806	ECA2CM101	E 100UF, 160V	1	
	C16811	ECJ3VC1H472J	C 4700PF, J, 50V	1	
	C16813	ECA2CM101	E 100UF, 160V	1	
	C16821	F1J1H104A835	C 0.10UF, 50V	1	
	C16822	F2A2G470A018	E 470UF, 400V	1	
	C16823	F1L2J562A022	C 5600UF, K, 6.3V	1	
	C16832	F1J1H392A834	C 3900UF, 50V	1	
	C16842	ECA2CM101	E 100UF, 160V	1	
	C16843	F1J1H104A835	C 0.10UF, 50V	1	
	C16844	F1J1H104A835	C 0.10UF, 50V	1	
	C16855	F1H1C105A008	C 1UF, K, 16V	1	
	C16856	F1H1A1050032	C 10UF, 50V	1	
	C16857	F1H1H472A970	C 4700PF, K, 50V	1	
	C16858	F1H1C104A143	C 0.1UF, K, 16V	1	
	C16860	F1H1A1050032	C 10UF, 50V	1	
	C16861	F1H1H472A970	C 4700PF, K, 50V	1	
	C16862	F1H1C104A143	C 0.1UF, K, 16V	1	
	C16864	F1J1H104A835	C 0.10UF, 50V	1	
	C16866	F1H1A1050032	C 10UF, 50V	1	
	C16867	F1H1H472A970	C 4700PF, K, 50V	1	
	C16868	F1H1C104A143	C 0.1UF, K, 16V	1	
	C16869	F1J1H104A835	C 0.10UF, 50V	1	
	C17103	F1H1A1050032	C 10UF, 50V	1	
	C17106	F1H1A1050032	C 10UF, 50V	1	
	C17109	F1H1A1050032	C 10UF, 50V	1	
	C17112	F1H1A1050032	C 10UF, 50V	1	
	C17115	F1H1A1050032	C 10UF, 50V	1	
	C17118	F1H1A1050032	C 10UF, 50V	1	
	C17121	F1L2E154A009	E 1500UF, 25V	1	
	C17122	F1L2E154A009	E 1500UF, 25V	1	
	C17123	F1H1A1050032	C 10UF, 50V	1	
	C17124	F1H1C104A143	C 0.1UF, K, 16V	1	
	C17125	F1H1C104A143	C 0.1UF, K, 16V	1	
	C17126	F1H1C104A143	C 0.1UF, K, 16V	1	
	C17127	F1H1A1050032	C 10UF, 50V	1	
	C17130	F1L2E154A009	E 1500UF, 25V	1	
	C17131	F1L2E154A009	E 1500UF, 25V	1	
	C17132	F1H1A1050032	C 10UF, 50V	1	
	C17133	F1H1A1050032	C 10UF, 50V	1	
	C17134	F1L2E154A009	E 1500UF, 25V	1	
	C17135	F1L2E154A009	E 1500UF, 25V	1	
	C17136	F1H1A1050032	C 10UF, 50V	1	
	C17137	F1L2E154A009	E 1500UF, 25V	1	
	C17138	F1L2E154A009	E 1500UF, 25V	1	
	C17139	F1H1A1050032	C 10UF, 50V	1	
	C17140	F1L2E154A009	E 1500UF, 25V	1	
	C17141	F1L2E154A009	E 1500UF, 25V	1	
	C17142	F1H1A1050032	C 10UF, 50V	1	
	C17143	F1L2E154A009	E 1500UF, 25V	1	
	C17144	F1L2E154A009	E 1500UF, 25V	1	
	C17145	F1H1A1050032	C 10UF, 50V	1	
	C17146	F1L2E154A009	E 1500UF, 25V	1	

Safety	Ref. No.	Part No.	Part Name & Description	Pcs	Remarks
	C17147	F1L2E154A009	E 1500UF, 25V	1	
	C17148	F1H1A1050032	C 10UF, 50V	1	
	C17149	F1L2E154A009	E 1500UF, 25V	1	
	C17150	F1L2E154A009	E 1500UF, 25V	1	
	C17151	F1H1A1050032	C 10UF, 50V	1	
	C17201	F1H1A1050032	C 10UF, 50V	1	
	C17204	F1L2E154A009	E 1500UF, 25V	1	
	C17205	F1L2E154A009	E 1500UF, 25V	1	
	C17206	F1H1A1050032	C 10UF, 50V	1	
	C17207	F1H1A1050032	C 10UF, 50V	1	
	C17210	F1L2E154A009	E 1500UF, 25V	1	
	C17211	F1L2E154A009	E 1500UF, 25V	1	
	C17212	F1H1A1050032	C 10UF, 50V	1	
	C17213	F1H1A1050032	C 10UF, 50V	1	
	C17216	F1L2E154A009	E 1500UF, 25V	1	
	C17217	F1L2E154A009	E 1500UF, 25V	1	
	C17218	F1H1A1050032	C 10UF, 50V	1	
	C17219	F1H1A1050032	C 10UF, 50V	1	
	C17222	F1L2E154A009	E 1500UF, 25V	1	
	C17223	F1L2E154A009	E 1500UF, 25V	1	
	C17224	F1H1A1050032	C 10UF, 50V	1	
	C17225	F1H1A1050032	C 10UF, 50V	1	
	C17228	F1L2E154A009	E 1500UF, 25V	1	
	C17229	F1L2E154A009	E 1500UF, 25V	1	
	C17230	F1H1A1050032	C 10UF, 50V	1	
	C17231	F1H1A1050032	C 10UF, 50V	1	
	C17234	F1L2E154A009	E 1500UF, 25V	1	
	C17235	F1L2E154A009	E 1500UF, 25V	1	
	C17236	F1H1A1050032	C 10UF, 50V	1	
	C17237	F1H1A1050032	C 10UF, 50V	1	
	C17240	F1L2E154A009	E 1500UF, 25V	1	
	C17241	F1L2E154A009	E 1500UF, 25V	1	
	C17242	F1H1A1050032	C 10UF, 50V	1	
	C17243	F1K2A105A006	C 1UF, 100V	1	
	C17244	F1H1C104A143	C 0.1UF, K, 16V	1	
	C17245	F1H1C104A143	C 0.1UF, K, 16V	1	
	C17246	F1H1C104A143	C 0.1UF, K, 16V	1	
	C17247	F1H1C104A143	C 0.1UF, K, 16V	1	
	CB1	K1MN68BA0052	68P CONNECTOR	1	
	CB2	K1MN68BA0052	68P CONNECTOR	1	
	CB3	K1MN68BA0052	68P CONNECTOR	1	
	CB4	K1MN68BA0052	68P CONNECTOR	1	
	CB5	K1MN68BA0052	68P CONNECTOR	1	
	CB6	K1MN68BA0052	68P CONNECTOR	1	
	CB7	K1MN68BA0052	68P CONNECTOR	1	
	CB8	K1MN68BA0052	68P CONNECTOR	1	
	CB9	K1MN68BA0052	68P CONNECTOR	1	
	CB10	K1MN68BA0052	68P CONNECTOR	1	
	CB11	K1MN68BA0052	68P CONNECTOR	1	
	CB12	K1MN68BA0052	68P CONNECTOR	1	
	CB13	K1MN68BA0052	68P CONNECTOR	1	
	CB14	K1MN68BA0052	68P CONNECTOR	1	
	CB15	K1MN68BA0052	68P CONNECTOR	1	
	D3	K1KA14B00129	14P CONNECTOR	1	
	D5	K1KB31BA0064	31P CONNECTOR	1	
	D6	K1KA20AA0009	20P CONNECTOR	1	
	D20	K1MN35BA0266	35P CONNECTOR	1	
	D25	K1KA13B00069	13P CONNECTOR	1	
	D31	K1MN68BA0266	68P CONNECTOR	1	
	D32	K1MN68BA0266	68P CONNECTOR	1	
	D33	K1MN68BA0266	68P CONNECTOR	1	
	D853	MA2J11100L	DIODE	1	
	D855	MA2J11100L	DIODE	1	
	D856	MA2J11100L	DIODE	1	
	D857	MA2J11100L	DIODE	1	
	D859	BOJCM000037	DIODE	1	
	D860	MAZ81100ML	ZENER DIODE	1	
	D861	MA2J11100L	DIODE	1	
	D862	MAZ80330LL	ZENER DIODE	1	
	D1107	MA704A	DIODE	1	
	D1112	MA2J72800L	ZENER DIODE	1	

Safety	Ref. No.	Part No.	Part Name & Description	Pcs	Remarks
	D2004	MA2J11100L	DIODE	1	
	D2005	MA2J11100L	DIODE	1	
	D2006	MA2J11100L	DIODE	1	
	D2007	MA2J11100L	DIODE	1	
	D2009	MA2J11100L	DIODE	1	
	D2010	MA2J11100L	DIODE	1	
	D2013	MA2J11100L	DIODE	1	
	D2020	MA3X78900L	ZENER DIODE	1	
	D2024	BOBC03900015	ZENER DIODE	1	
	D2201	MA704A	DIODE	1	
	D2300	MA2J11100L	DIODE	1	
	D2301	BOHCMM000014	DIODE	1	
	D2302	BOHCMM000014	DIODE	1	
	D2512	MAZ80560ML	ZENER DIODE	1	
	D2520	LNJ107W5PRW	LED	1	
	D2524	MAZ80560ML	ZENER DIODE	1	
	D2526	MAZ80560ML	ZENER DIODE	1	B/E
	D2530	MAZ80560ML	ZENER DIODE	1	
	D3057	BOBC01100001	ZENER DIODE	1	
	D3068	MAZ81400ML	ZENER DIODE	1	
	D3069	MAZ81400ML	ZENER DIODE	1	
	D3077	MAZ81400ML	ZENER DIODE	1	
	D3078	MAZ81400ML	ZENER DIODE	1	
	D3082	BOBC01100001	ZENER DIODE	1	
	D3095	MA704A	DIODE	1	
	D3096	MA704A	DIODE	1	
	D3702	MAZ81400ML	ZENER DIODE	1	
	D3703	MAZ81400ML	ZENER DIODE	1	
	D3704	MAZ81400ML	ZENER DIODE	1	
	D3705	MAZ81400ML	ZENER DIODE	1	
	D3706	MAZ81400ML	ZENER DIODE	1	
	D3801	EZAEG2A50AX	DIODE	1	
	D3802	EZAEG2A50AX	DIODE	1	
	D3803	EZAEG2A50AX	DIODE	1	
	D3804	EZAEG2A50AX	DIODE	1	
	D3805	EZAEG2A50AX	DIODE	1	
	D3806	EZAEG2A50AX	DIODE	1	
	D3807	EZJZOV80008B	VARISTOR	1	
	D3808	EZJZOV80008B	VARISTOR	1	
	D3809	EZAEG2A50AX	DIODE	1	
	D3810	EZAEG2A50AX	DIODE	1	
	D3811	EZJZOV80008B	VARISTOR	1	
	D3813	BOHCMM000014	DIODE	1	
	D3814	BOHCMM000014	DIODE	1	
	D3815	EZJZOV120JA	VARISTOR	1	
	D4502	EZAEG2A50AX	DIODE	1	
	D4503	EZAEG2A50AX	DIODE	1	
	D4504	EZAEG2A50AX	DIODE	1	
	D4505	EZAEG2A50AX	DIODE	1	
	D4506	EZAEG2A50AX	DIODE	1	
	D4507	EZAEG2A50AX	DIODE	1	
	D4508	EZAEG2A50AX	DIODE	1	
	D4509	EZAEG2A50AX	DIODE	1	
	D4510	EZAEG2A50AX	DIODE	1	
	D4511	EZAEG2A50AX	DIODE	1	
	D4512	EZAEG2A50AX	DIODE	1	
	D4513	BOBC5R6A0275	DIODE	1	
	D4514	EZAEG2A50AX	DIODE	1	
	D4515	BOBC5R6A0275	DIODE	1	
	D4516	EZAEG2A50AX	DIODE	1	
	D4517	EZAEG2A50AX	DIODE	1	
	D4518	EZAEG2A50AX	DIODE	1	
	D4519	EZAEG2A50AX	DIODE	1	
	D4520	EZAEG2A50AX	DIODE	1	
	D4521	EZAEG2A50AX	DIODE	1	
	D4522	EZAEG2A50AX	DIODE	1	
	D4523	EZAEG2A50AX	DIODE	1	
	D4541	MA2J11100L	DIODE	1	
	D4542	MA2J11100L	DIODE	1	
	D4544	EZAEG2A50AX	DIODE	1	
	D4545	EZAEG2A50AX	DIODE	1	
	D4546	EZAEG2A50AX	DIODE	1	
	D4547	EZAEG2A50AX	DIODE	1	

Safety	Ref. No.	Part No.	Part Name & Description	Pcs	Remarks
	D4548	EZAEG2A50AX	DIODE	1	
	D4549	EZAEG2A50AX	DIODE	1	
	D4550	B0BC5R6A0275	DIODE	1	
	D4551	EZAEG2A50AX	DIODE	1	
	D4552	EZAEG2A50AX	DIODE	1	
	D4553	EZAEG2A50AX	DIODE	1	
	D4554	EZAEG2A50AX	DIODE	1	
	D4560	MA2J11100L	DIODE	1	
	D4561	MA2J11100L	DIODE	1	
	D4562	MA2J11100L	DIODE	1	
	D4563	MA2J11100L	DIODE	1	
	D4564	MA2J11100L	DIODE	1	
	D4565	MA2J11100L	DIODE	1	
	D4566	B0HCMM000014	DIODE	1	
	D5201	MA2J72800L	ZENER DIODE	1	
	D5301	MA22D3900L	DIODE	1	
	D5302	MA22D3900L	DIODE	1	
	D5303	B0JCDD000002	DIODE	1	
	D5304	B0JCDD000002	DIODE	1	
	D5307	B0BC4R000002	ZENER DIODE	1	
	D5308	B0BC4R000002	ZENER DIODE	1	
	D5406	B0JCME000037	DIODE	1	
	D5407	B0BC4R700007	ZENER DIODE	1	
	D5408	B0BC4R700007	ZENER DIODE	1	
	D5409	B0JCME000037	DIODE	1	
	D5410	B0BC4R700007	ZENER DIODE	1	
	D5411	B0BC4R700007	ZENER DIODE	1	
	D5502	B0BC01000035	ZENER DIODE	1	
	D5503	B0BC01100001	ZENER DIODE	1	
	D5504	B0BC6R600005	ZENER DIODE	1	
	D5521	B0ADEJ000035	ZENER DIODE	1	
	D5522	B0ADEJ000035	ZENER DIODE	1	
	D5574	B0BC3R700006	ZENER DIODE	1	
	D5575	B0BC3R700006	ZENER DIODE	1	
	D5576	MA3X152E0L	ZENER DIODE	1	
	D5577	MAZ80680LL	ZENER DIODE	1	
	D5578	MA8120M	ZENER DIODE	1	
	D5579	MAZ80680LL	ZENER DIODE	1	
	D5580	MA2J11100L	DIODE	1	
	D5600	B0BC4R700007	ZENER DIODE	1	
	D5601	MA22D3900L	DIODE	1	
	D5602	MA22D3900L	DIODE	1	
	D5603	B0JCDD000002	DIODE	1	
	D5604	B0JCDD000002	DIODE	1	
	D5605	MA22D3900L	DIODE	1	
	D5606	B0JCDD000002	DIODE	1	
	D5607	B0BC4R700007	ZENER DIODE	1	
	D5608	B0BC4R700007	ZENER DIODE	1	
	D5691	B0BC6R600005	ZENER DIODE	1	
	D5692	MAZ80560LL	ZENER DIODE	1	
	D7800	B3AEB0000107	LED	1	
	D8901	MA2J72800L	ZENER DIODE	1	
	D8952	MA2J72800L	ZENER DIODE	1	
	D9002	K7AAAY000003	PHOTO LINK	1	
	D9014	MA2J11100L	DIODE	1	
	D9017	MA2J11100L	DIODE	1	
	D9024	B0JCCE000008	DIODE	1	
	D9025	B0JCCE000008	DIODE	1	
	D9026	B0JCCE000008	DIODE	1	
	D9027	B0BC3R3A0273	ZENER DIODE	1	
	D9028	B0BC3R3A0273	ZENER DIODE	1	
	D9029	B0BC3R3A0273	ZENER DIODE	1	
	D9110	B0JCGD000002	DIODE	1	
	D9807	B0JCCE000008	DIODE	1	
	D9808	B0JCCE000008	DIODE	1	
	D9812	MA22D3900L	DIODE	1	
	D9813	B0JCGD000002	DIODE	1	
	D9814	B0JCGD000002	DIODE	1	
	D9815	B0JCGD000002	DIODE	1	
	D9816	MA22D3900L	DIODE	1	
	D9817	MA22D3900L	DIODE	1	
	D14903	B0HCMM000013	DIODE	1	
	D14904	B0HCMM000013	DIODE	1	

Safety	Ref. No.	Part No.	Part Name & Description	Pcs	Remarks
	D14905	B0HCMM000013	DIODE	1	
	D14906	B0HCMM000013	DIODE	1	
	D14907	B0HCMM000013	DIODE	1	
	D14908	B0HCMM000013	DIODE	1	
	D14909	MA3X152E0L	ZENER DIODE	1	
	D14910	MA2J11100L	DIODE	1	
	D14911	B0HCMM000013	DIODE	1	
	D14912	B0HCMM000013	DIODE	1	
	D14953	B0HCMM000013	DIODE	1	
	D14954	B0HCMM000013	DIODE	1	
	D14955	B0HCMM000013	DIODE	1	
	D14956	B0HCMM000013	DIODE	1	
	D14957	B0HCMM000013	DIODE	1	
	D14958	B0HCMM000013	DIODE	1	
	D14961	MA8056H	ZENER DIODE	1	
	D14974	MA3X152E0L	ZENER DIODE	1	
	D14975	MA2J11100L	DIODE	1	
	D14976	MA2J11100L	DIODE	1	
	D14977	B0HCMM000013	DIODE	1	
	D14978	B0HCMM000013	DIODE	1	
	D14979	MA2J11100L	DIODE	1	
	D16001	B0FBCN000005	DIODE	1	
	D16002	B0FBCN000005	DIODE	1	
	D16021	MA3DF30000LW	ZENER DIODE	1	
	D16022	MA3DF30000LW	ZENER DIODE	1	
	D16032	MA2J11100L	DIODE	1	
	D16041	MA3DF46000LW	ZENER DIODE	1	
	D16043	MA3DF46000LW	ZENER DIODE	1	
	D16050	B0ECKP000047	DIODE	1	
	D16051	B0FBCN000005	DIODE	1	
	D16053	B0FBCN000005	DIODE	1	
	D16102	MA22D3900L	DIODE	1	
	D16104	MA22D3900L	DIODE	1	
	D16131	B0ECHP000003	DIODE	1	
	D16132	B0ECKP000047	DIODE	1	
	D16151	B0ECHP000003	DIODE	1	
	D16152	B0ECKP000047	DIODE	1	
	D16153	B0ECKP000047	DIODE	1	
	D16191	B0ECKP000047	DIODE	1	
	D16192	B0ECKP000047	DIODE	1	
	D16253	LNJ301MPUJA	LED	1	
	D16255	MA2J11100L	DIODE	1	
	D16280	MA2J11100L	DIODE	1	
	D16281	MAZ80510LL	ZENER DIODE	1	
	D16282	MAZ80680ML	ZENER DIODE	1	
	D16284	MA3X152D0L	DIODE	1	
	D16285	MA3X152D0L	DIODE	1	
	D16300	B0ECKP000047	DIODE	1	
	D16301	MA3X152E0L	ZENER DIODE	1	
	D16302	MA2J11100L	DIODE	1	
	D16311	MAZ81500ML	ZENER DIODE	1	
	D16313	B0ECKP000047	DIODE	1	
	D16321	B0ECKP000047	DIODE	1	
	D16324	MA3X152D0L	DIODE	1	
	D16331	B0ECHP000003	DIODE	1	
	D16335	B0ECLM000006	DIODE	1	
	D16336	B0ECLM000006	DIODE	1	
	D16401	B0FBCN000005	DIODE	1	
	D16402	B0FBCN000005	DIODE	1	
	D16407	MA22D3900L	DIODE	1	
	D16408	MA22D3900L	DIODE	1	
	D16421	MA3DF47000LW	ZENER DIODE	1	
	D16422	MA3DF47000LW	ZENER DIODE	1	
	D16451	B0ECKP000047	DIODE	1	
	D16461	MA3DF46000LW	ZENER DIODE	1	
	D16462	MA3DF46000LW	ZENER DIODE	1	
	D16466	MA2J11100L	DIODE	1	
	D16473	MA3X152D0L	DIODE	1	
	D16475	MAZ80510LL	ZENER DIODE	1	
	D16477	MA2J11100L	DIODE	1	
	D16478	B0HCKS000002	DIODE	1	
	D16480	MA2J11100L	DIODE	1	
	D16481	B0FBCN000005	DIODE	1	

Safety	Ref. No.	Part No.	Part Name & Description	Pcs	Remarks
	D16482	BOFBCN000005	DIODE	1	
	D16497	BOECKP000047	DIODE	1	
	D16501	BOEHP000003	DIODE	1	
	D16503	BOECKP000047	DIODE	1	
	D16521	BOEHP000003	DIODE	1	
	D16522	BOECKP000047	DIODE	1	
	D16523	BOECKP000047	DIODE	1	
	D16583	LNJ301MPUJA	LED	1	
	D16585	MA2J11100L	DIODE	1	
	D16602	MAZ81500ML	ZENER DIODE	1	
	D16604	MA2J11100L	DIODE	1	
	D16605	MAZ80510LL	ZENER DIODE	1	
	D16606	BOECKM000038	DIODE	1	
	D16607	MA2J11100L	DIODE	1	
	D16608	MA8120M	ZENER DIODE	1	
	D16609	MA2J11100L	DIODE	1	
	D16610	MA2J11100L	DIODE	1	
	D16618	BOECKP000047	DIODE	1	
	D16619	BOECKP000047	DIODE	1	
	D16631	MAZ81300ML	ZENER DIODE	1	
	D16632	MAZ81300ML	ZENER DIODE	1	
	D16633	MAZ81300ML	ZENER DIODE	1	
	D16634	MAZ81300ML	ZENER DIODE	1	
	D16635	MAZ81300ML	ZENER DIODE	1	
	D16642	BOHCKS000002	DIODE	1	
	D16643	MA2J11100L	DIODE	1	
	D16645	MA2J11100L	DIODE	1	
	D16659	BOHCM000014	DIODE	1	
	D16661	MA2J11100L	DIODE	1	
	D16662	MAZ81500ML	ZENER DIODE	1	
	D16663	MAZ81500ML	ZENER DIODE	1	
	D16664	MAZ81500ML	ZENER DIODE	1	
	D16665	MAZ80510LL	ZENER DIODE	1	
	D16667	MA2J11100L	DIODE	1	
	D16668	MA3X152D0L	DIODE	1	
	D16669	MA2J11100L	DIODE	1	
	D16671	MA2J11100L	DIODE	1	
	D16710	MAZ81500ML	ZENER DIODE	1	
	D16711	BOHCMR000002	DIODE	1	
	D16712	MAZ81500ML	ZENER DIODE	1	
	D16713	BOHCMR000002	DIODE	1	
	D16714	MAZ81500ML	ZENER DIODE	1	
	D16715	BOHCMR000002	DIODE	1	
	D16717	MA8330M	ZENER DIODE	1	
	D16718	MA2J11100L	DIODE	1	
	D16719	BOECKP000047	DIODE	1	
	D16720	BOECKP000047	DIODE	1	
	D16721	BOHCKS000002	DIODE	1	
	D16722	MA2J11100L	DIODE	1	
	D16725	MA2J11100L	DIODE	1	
	D16761	MA2J11100L	DIODE	1	
	D16762	MA2J11100L	DIODE	1	
	D16763	BOECKP000047	DIODE	1	
	D16764	BOHCKS000002	DIODE	1	
	D16765	BOECKP000047	DIODE	1	
	D16766	BOECKP000047	DIODE	1	
	D16771	MAZ80510LL	ZENER DIODE	1	
	D16791	MAZ82000ML	ZENER DIODE	1	
	D16792	MA2J11100L	DIODE	1	
	D16793	BOHCKS000002	DIODE	1	
	D16794	MA2J11100L	DIODE	1	
	D16820	MA3X152E0L	ZENER DIODE	1	
	D16821	MAZ82000ML	ZENER DIODE	1	
	D16822	MA2J11100L	DIODE	1	
	D16824	MA8330M	ZENER DIODE	1	
	D16825	MA8330M	ZENER DIODE	1	
	D16830	MA8056H	ZENER DIODE	1	
	D16836	MAZ81500ML	ZENER DIODE	1	
	D16837	MA2J11100L	DIODE	1	
	D16838	BOBC027A0234	ZENER DIODE	1	
	D16839	BOECKP000047	DIODE	1	
	D16859	BOHCKS000002	DIODE	1	
	D16860	BOHCKS000002	DIODE	1	

Safety	Ref. No.	Part No.	Part Name & Description	Pcs	Remarks
	D16861	MA8330M	ZENER DIODE	1	
	D16862	MA8330M	ZENER DIODE	1	
	D16871	MAZ82000ML	ZENER DIODE	1	
	D16872	MA2J11100L	DIODE	1	
	D16873	MAZ82000ML	ZENER DIODE	1	
	D16874	MAZ80510LL	ZENER DIODE	1	
	D16875	MA2J11100L	DIODE	1	
	D2525B	LN1471YTR	LED	1	B/E
	FL3710	JOZZA0000091	FILTER	1	
	FL3711	JOZZA0000091	FILTER	1	
	FL3712	JOZZA0000091	FILTER	1	
	FL3713	JOZZA0000091	FILTER	1	
	FL3714	JOZZA0000091	FILTER	1	
	FL4206	ECJ1VB0J474K	C 0.47UF, K, 6.3V	1	
	FL5015	JOJAD0000028	CHIP INDUCTOR	1	
	FL5016	JOJAD0000028	CHIP INDUCTOR	1	
	FL5017	JOJAD0000028	CHIP INDUCTOR	1	
	FL5018	JOJAD0000028	CHIP INDUCTOR	1	
	FL5019	JOJAD0000028	CHIP INDUCTOR	1	
	FL5020	JOJAD0000028	CHIP INDUCTOR	1	
	FL5731	JOHABH000013	LC FILTER	1	
	FL5732	JOHABH000013	LC FILTER	1	
	FL5733	JOHABH000013	LC FILTER	1	
	FL5734	JOHABH000013	LC FILTER	1	
	FL9001	JOHABB000003	LC FILTER	1	
	FL9002	JOHABB000003	LC FILTER	1	
	FL9003	JOHABB000004	LC FILTER	1	
	FL9004	JOHABB000004	LC FILTER	1	
	FL9005	JOHABB000004	LC FILTER	1	
	FL9803	FLJ1E104A148	C 0.10UF, Z, 25V	1	
	FL9805	FLJ1E104A148	C 0.10UF, Z, 25V	1	
	FL9806	FLJ1E104A148	C 0.10UF, Z, 25V	1	
	G51	K1KY16BA0192	16P CONNECTOR	1	
	GH10	K1FY121E0001	CONNECTOR	1	
	GH11	K1KA30AA0009	30P CONNECTOR	1	
	GL02	K1KA02B00294	2P CONNECTOR	1	PAVCCZ
	GS02	K1KA02A00787	2P CONNECTOR	1	
	GS09	K1KA06A00508	6P CONNECTOR	1	
	H11	K1KA05AA0190	5P CONNECTOR	1	
	H12	K1KA04AA0190	4P CONNECTOR	1	
	HC12	K1KY15AA0606	15P CONNECTOR	1	
	HC13	K1KY23AA0606	23P CONNECTOR	1	
	HC14	K1KY23AA0606	23P CONNECTOR	1	
	HC15	K1KA11AA0715	11P CONNECTOR	1	
	HC16	K1KA20AA0009	20P CONNECTOR	1	
	IC850	C0DBAZF00003	IC	1	
	IC1100	MN103SG3FPA1	IC	1	
	IC1101	TVRP987-1	IC	1	PAVCCZ
	IC2008	C0CBCE00001	IC	1	
	IC2012	C1BB00000947	IC	1	
	IC2013	C0DBGY00281	IC	1	
	IC2106	C1AB00002909	IC	1	
	IC2107	C0DBFFD00003	IC	1	
	IC2109	C0DBGHF00001	IC	1	
	IC2110	C0DBGHF00001	IC	1	
	IC2403	C1AB00002877	IC	1	
	IC2602	C3ABRY000037	IC	1	
	IC2603	C0DBEFH00002	IC	1	
	IC2604	C1AB00002930	IC	1	
	IC3007	AN15876A-VT	IC	1	
	IC3009	AN15862A-VT	IC	1	
	IC3801	C1AB00002835	IC	1	
	IC3802	TVRP636	IC	1	PAVCCZ
	IC4001	C1AB00002687	IC	1	

Safety	Ref. No.	Part No.	Part Name & Description	Pcs	Remarks
	JK3701	K4AK18B00007	TERMINAL	1	
	JK4500	K1FY119D0003	CONNECTOR	1	
	JK4501	K1FY119D0003	CONNECTOR	1	
	JK4502	K1FY119D0003	CONNECTOR	1	
	JK7702	K1NA09E00080	9P CONNECTOR	1	
	JK8401	K1NA68B00051	68P CONNECTOR	1	PAVCCZ B/E
	JK9001	K1FB315A0006	CONNECTOR	1	
	JS851	DOGDR00Z0002	M 0 OHM, 1/10W	1	
	JS852	DOGDR00Z0002	M 0 OHM, 1/10W	1	
	JS1100	DOYAR0000007	M 0 OHM 1/4W	1	
	JS1102	DOYAR0000007	M 0 OHM 1/4W	1	B
	JS1103	DOYAR0000007	M 0 OHM 1/4W	1	P
	JS1106	DOYAR0000007	M 0 OHM 1/4W	1	E
	JS2059	DOYAR0000007	M 0 OHM 1/4W	1	
	JS2060	DOYAR0000007	M 0 OHM 1/4W	1	
	JS2061	DOYAR0000007	M 0 OHM 1/4W	1	
	JS2320	DOYAR0000007	M 0 OHM 1/4W	1	
	JS3039	DOYAR0000007	M 0 OHM 1/4W	1	
	JS3704	DOGDR00Z0002	M 0 OHM, 1/10W	1	
	JS3705	DOGDR00Z0002	M 0 OHM, 1/10W	1	
	JS3707	DOGDR00Z0002	M 0 OHM, 1/10W	1	
	JS3708	DOGDR00Z0002	M 0 OHM, 1/10W	1	
	JS4002	DOYAR0000007	M 0 OHM 1/4W	1	
	JS7700	DOGBR00Z0002	M 0 OHM J 1/16W	1	
	JS9323	DOGBR00Z0002	M 0 OHM J 1/16W	1	
	JS9324	DOGBR00Z0002	M 0 OHM J 1/16W	1	
	JS9325	DOGBR00Z0002	M 0 OHM J 1/16W	1	
	JS9326	DOGBR00Z0002	M 0 OHM J 1/16W	1	
	K1	K1KY12B00001	12P CONNECTOR	1	
	L852	G0C150MA0056	PEAKING COIL	1	
	L1100	J0JYC0000068	CHIP INDUCTOR	1	
	L2001	G1C150KA0038	INDUCTION COIL	1	
	L2005	J0JCC0000284	CHIP INDUCTOR	1	
	L2006	J0JCC0000284	CHIP INDUCTOR	1	
	L2021	G1C470MA0291	INDUCTION COIL	1	
	L2022	G1C100MA0072	INDUCTION COIL	1	
	L2025	J0JCC0000059	CHIP INDUCTOR	1	
	L2026	J0JCC0000059	CHIP INDUCTOR	1	
	L2029	J0JCC0000059	CHIP INDUCTOR	1	
	L2030	J0JYC0000068	CHIP INDUCTOR	1	
	L2031	J0JYC0000068	CHIP INDUCTOR	1	
	L2032	J0JYC0000068	CHIP INDUCTOR	1	
	L2036	J0JYC0000068	CHIP INDUCTOR	1	
	L2300	J0JYC0000068	CHIP INDUCTOR	1	
	L3032	J0JCC0000100	CHIP INDUCTOR	1	
	L3033	J0JCC0000100	CHIP INDUCTOR	1	
	L3034	J0JCC0000100	CHIP INDUCTOR	1	
	L3035	J0JCC0000100	CHIP INDUCTOR	1	
	L3036	J0JCC0000100	CHIP INDUCTOR	1	
	L3037	J0JCC0000100	CHIP INDUCTOR	1	
	L3038	J0JCC0000100	CHIP INDUCTOR	1	
	L3039	J0JCC0000100	CHIP INDUCTOR	1	
	L3040	J0JCC0000100	CHIP INDUCTOR	1	
	L3041	J0JCC0000100	CHIP INDUCTOR	1	
	L3042	J0JCC0000100	CHIP INDUCTOR	1	
	L3043	J0JCC0000100	CHIP INDUCTOR	1	
	L3044	J0JCC0000100	CHIP INDUCTOR	1	
	L3045	J0JCC0000100	CHIP INDUCTOR	1	
△	L3049	G1C101M00018	INDUCTION COIL	1	
△	L3050	G1C101M00018	INDUCTION COIL	1	
	L3700	J0JCC0000364	CHIP INDUCTOR	1	
	L3701	J0JCC0000364	CHIP INDUCTOR	1	
	L3707	J0JCC0000100	CHIP INDUCTOR	1	
	L3708	J0JCC0000100	CHIP INDUCTOR	1	
	L3801	J0JHC0000078	CHIP INDUCTOR	1	
	L3804	J0JHC0000078	CHIP INDUCTOR	1	
	L3805	J0JHC0000078	CHIP INDUCTOR	1	
	L4002	J0JHC0000045	CHIP INDUCTOR	1	
	L4004	J0JYC0000068	CHIP INDUCTOR	1	

Safety	Ref. No.	Part No.	Part Name & Description	Pcs	Remarks
	L4006	J0JHC0000045	CHIP INDUCTOR	1	
	L4008	J0JYC0000068	CHIP INDUCTOR	1	
	L4009	J0JYC0000068	CHIP INDUCTOR	1	
	L4212	J0JYC0000068	CHIP INDUCTOR	1	
	L4216	J0JYC0000068	CHIP INDUCTOR	1	
	L4217	J0JYC0000068	CHIP INDUCTOR	1	
	L4219	J0JYC0000068	CHIP INDUCTOR	1	
	L4220	J0JYC0000068	CHIP INDUCTOR	1	
	L4502	J0JYC0000068	CHIP INDUCTOR	1	
	L4503	J0JYC0000068	CHIP INDUCTOR	1	
	L4504	J0JYC0000068	CHIP INDUCTOR	1	
	L4505	J0JYC0000068	CHIP INDUCTOR	1	
	L4506	J0JYC0000068	CHIP INDUCTOR	1	
	L4507	J0JYC0000068	CHIP INDUCTOR	1	
	L4508	J0JYC0000068	CHIP INDUCTOR	1	
	L4511	J0JYC0000068	CHIP INDUCTOR	1	
	L4512	J0JYC0000068	CHIP INDUCTOR	1	
	L4513	J0JYC0000068	CHIP INDUCTOR	1	
	L4514	J0JYC0000068	CHIP INDUCTOR	1	
	L4515	J0JYC0000068	CHIP INDUCTOR	1	
	L4516	J0JYC0000068	CHIP INDUCTOR	1	
	L4517	J0JYC0000068	CHIP INDUCTOR	1	
	L4518	J0JYC0000068	CHIP INDUCTOR	1	
	L4519	J0JYC0000068	CHIP INDUCTOR	1	
	L4521	J0JYC0000068	CHIP INDUCTOR	1	
	L4522	J0JYC0000068	CHIP INDUCTOR	1	
	L4523	J0JYC0000068	CHIP INDUCTOR	1	
	L5001	J0JHC0000045	CHIP INDUCTOR	1	
	L5002	J0JHC0000045	CHIP INDUCTOR	1	
	L5004	J0JHC0000045	CHIP INDUCTOR	1	
	L5005	J0JHC0000045	CHIP INDUCTOR	1	
	L5006	J0JHC0000045	CHIP INDUCTOR	1	
	L5300	G1C2R2Z00007	INDUCTION COIL	1	
	L5301	G1C2R2Z00007	INDUCTION COIL	1	
	L5302	J0JYC0000068	CHIP INDUCTOR	1	
	L5304	G1C100MA0203	INDUCTION COIL	1	
	L5305	J0JHC0000075	CHIP INDUCTOR	1	
	L5407	G1C330M00027	INDUCTION COIL	1	
	L5409	G1C100MA0291	INDUCTION COIL	1	
	L5410	G1C330M00027	INDUCTION COIL	1	
	L5412	J0JYC0000068	CHIP INDUCTOR	1	
	L5414	G1C100MA0291	INDUCTION COIL	1	
	L5415	J0JYC0000068	CHIP INDUCTOR	1	
	L5501	G0A2R7HA0011	CHOKE COIL	1	PAVCCZ
	L5502	G0C150MA0056	PEAKING COIL	1	
	L5503	G0C330MA0056	PEAKING COIL	1	
	L5504	G0A2R7HA0011	CHOKE COIL	1	PAVCCZ
	L5505	G0A2R7HA0011	CHOKE COIL	1	PAVCCZ
	L5600	G1C3R9Z00003	INDUCTION COIL	1	
	L5601	G1C3R9Z00003	INDUCTION COIL	1	
	L5602	G1C2R2Z00007	INDUCTION COIL	1	
	L5604	G1C100MA0203	INDUCTION COIL	1	
	L5605	J0JHC0000075	CHIP INDUCTOR	1	
	L5606	G1C100MA0203	INDUCTION COIL	1	
	L5610	J0JHC0000035	CHIP INDUCTOR	1	
	L5611	J0JHC0000035	CHIP INDUCTOR	1	
	L5690	J0JYC0000068	CHIP INDUCTOR	1	
	L5691	J0JYC0000068	CHIP INDUCTOR	1	
	L5735	J0JYC0000068	CHIP INDUCTOR	1	
	L7704	J0JHC0000045	CHIP INDUCTOR	1	
	L7705	J0JHC0000045	CHIP INDUCTOR	1	
	L8030	J0JHC0000045	CHIP INDUCTOR	1	
	L8031	J0JHC0000045	CHIP INDUCTOR	1	
	L8032	J0JHC0000045	CHIP INDUCTOR	1	
	L8034	J0JHC0000045	CHIP INDUCTOR	1	
	L8035	J0JHC0000045	CHIP INDUCTOR	1	
	L8036	J0JHC0000045	CHIP INDUCTOR	1	
	L8101	J0JHC0000045	CHIP INDUCTOR	1	
	L8201	J0JHC0000045	CHIP INDUCTOR	1	
	L8301	J0JHC0000045	CHIP INDUCTOR	1	B/E
	L8304	J0JHC0000045	CHIP INDUCTOR	1	B/E
	L8401	J0JHC0000075	CHIP INDUCTOR	1	B/E
	L8501	J0JHC0000045	CHIP INDUCTOR	1	

Safety	Ref. No.	Part No.	Part Name & Description	Pcs	Remarks
	L8580	J0JHC0000075	CHIP INDUCTOR	1	
	L8620	J0JHC0000045	CHIP INDUCTOR	1	
	L8621	J0JHC0000045	CHIP INDUCTOR	1	
	L8623	J0JHC0000045	CHIP INDUCTOR	1	
	L8950	J0JYC0000068	CHIP INDUCTOR	1	B/E
	L9000	J0JHC0000078	CHIP INDUCTOR	1	
	L9001	J0JHC0000078	CHIP INDUCTOR	1	
	L9002	J0JHC0000078	CHIP INDUCTOR	1	
	L9003	J0JHC0000078	CHIP INDUCTOR	1	
	L9004	J0JHC0000078	CHIP INDUCTOR	1	
	L9005	J0JHC0000078	CHIP INDUCTOR	1	
	L9006	J0JHC0000078	CHIP INDUCTOR	1	
	L9007	J0JHC0000078	CHIP INDUCTOR	1	
	L9010	G1C220MA0291	INDUCTION COIL	1	
	L9011	G1C220MA0291	INDUCTION COIL	1	
	L9012	G1C220MA0291	INDUCTION COIL	1	
	L9013	G1C220MA0291	INDUCTION COIL	1	
	L9014	G1C220MA0291	INDUCTION COIL	1	
	L9015	G1C220MA0291	INDUCTION COIL	1	
	L9016	G1C220MA0291	INDUCTION COIL	1	
	L9017	G1C220MA0291	INDUCTION COIL	1	
	L9018	J0JHC0000042	CHIP INDUCTOR	1	
	L9019	J0JHC0000042	CHIP INDUCTOR	1	
	L9023	G1C3R0ZA0156	INDUCTION COIL	1	
	L9800	G1C2R2Z00007	INDUCTION COIL	1	
	L9801	G1C1R5Z00006	INDUCTION COIL	1	
	L9802	G1C2R2Z00007	INDUCTION COIL	1	
	L16001	G0C2R1KA0190	PEAKING COIL	1	
	L16002	G0C2R1KA0190	PEAKING COIL	1	
	L16003	G0C2R1KA0190	PEAKING COIL	1	
	L16004	G0C2R1KA0190	PEAKING COIL	1	
	L16005	G0C2R1KA0190	PEAKING COIL	1	
	L16011	G0C2R1KA0190	PEAKING COIL	1	
	L16012	G0C2R1KA0190	PEAKING COIL	1	
	L16013	G0C2R1KA0190	PEAKING COIL	1	
	L16014	G0C2R1KA0190	PEAKING COIL	1	
	L16015	G0C2R1KA0190	PEAKING COIL	1	
	L16102	J0JJC0000015	CHIP INDUCTOR	1	
	L16103	G0ZZ00002183	PEAKING COIL	1	
	L16104	J0JJC0000015	CHIP INDUCTOR	1	
	L16221	G0ZZ00002183	PEAKING COIL	1	
	L16262	G0ZZ00002183	PEAKING COIL	1	
	L16271	G0ZZ00002183	PEAKING COIL	1	
	L16301	J0JHC0000031	CHIP INDUCTOR	1	
	L16398	J0JJC0000015	CHIP INDUCTOR	1	
	L16399	J0JJC0000015	CHIP INDUCTOR	1	
	L16401	G0C2R1KA0190	PEAKING COIL	1	
	L16403	G0C2R1KA0190	PEAKING COIL	1	
	L16404	G0C2R1KA0190	PEAKING COIL	1	
	L16405	G0C2R1KA0190	PEAKING COIL	1	
	L16406	G0C2R1KA0190	PEAKING COIL	1	
	L16411	G0C2R1KA0190	PEAKING COIL	1	
	L16413	G0C2R1KA0190	PEAKING COIL	1	
	L16414	G0C2R1KA0190	PEAKING COIL	1	
	L16415	G0C2R1KA0190	PEAKING COIL	1	
	L16416	G0C2R1KA0190	PEAKING COIL	1	
	L16472	G0ZZ00002183	PEAKING COIL	1	
	L16591	G0ZZ00002183	PEAKING COIL	1	
	L16697	G0C102KA0187	PEAKING COIL	1	
	L16698	G0C681KA0187	PEAKING COIL	1	
	L16699	G0C331KA0187	PEAKING COIL	1	
	L16801	G0ZZ00002183	PEAKING COIL	1	
	PA5	K1KA12AA0194	12P CONNECTOR	1	
	PA6	K1KA20AA0009	20P CONNECTOR	1	
	PA8	K1KA06A00452	6P CONNECTOR	1	
	PA33	K1KA04AA0192	4P CONNECTOR	1	
	PA35	K1KA03AA0192	3P CONNECTOR	1	
	PA36	K1KA04AA0192	4P CONNECTOR	1	
	PA37	K1KA03AA0192	3P CONNECTOR	1	
△	PA5200	K5H5022A0023	FUSE	1	
	PA5400	K5H5022A0023	FUSE	1	
△	PA5402	K5H1022A0031	FUSE	1	

Safety	Ref. No.	Part No.	Part Name & Description	Pcs	Remarks
△	PA5403	K5H1022A0031	FUSE	1	
△	PA5600	K5H5022A0023	FUSE	1	
	PA9800	K5H4022A0031	FUSE	1	
	PA9900	K5H5022A0031	FUSE	1	
	PC2511	B3JB00000046	IC	1	
	PC14951	B3PBA0000457	IC	1	
	PC14952	B3PBA0000457	IC	1	
	PC14953	B3PBA0000456	IC	1	
	PC16480	B3PBA0000223	IC	1	
	PC16601	B3PBA0000243	IC	1	
	PC16602	B3PBA0000443	IC	1	
	PC16603	B3PBA0000223	IC	1	
	PC16705	B3PBA0000456	IC	1	
	PC16710	B3PBA0000223	IC	1	
	PC16896	B3PBA0000223	IC	1	
	PC16897	B3PBA0000223	IC	1	
△	PCB	TXN/A1RHTD	CIRCUIT BOARD A	1	PAVCCZ E
△	PCB	TXN/A1RHTB	CIRCUIT BOARD A	1	PAVCCZ B
△	PCB	TXN/A1RHTE	CIRCUIT BOARD A	1	PAVCCZ P
△	PCB	TXNHC1RHTB	CIRCUIT BOARD HC	1	PAVCCZ
△	PCB	TXNPA1RHTB	CIRCUIT BOARD PA	1	PAVCCZ
△	PCB	ETX2MM702MFH	CIRCUIT BOARD P	1	PAVCCZ
△	PCB	TNPA4446	CIRCUIT BOARD C1	1	
△	PCB	TNPA4447	CIRCUIT BOARD C2	1	
△	PCB	TZTNP01RLTB	CIRCUIT BOARD D	1	PAVCCZ
△	PCB	TNPA4410AC	CIRCUIT BOARD SC	1	
△	PCB	TNPA4413	CIRCUIT BOARD SD	1	
△	PCB	TNPA4411AC	CIRCUIT BOARD SS	1	
△	PCB	TNPA4412	CIRCUIT BOARD SU	1	
△	PCB	TNPA4535AB	CIRCUIT BOARD S	1	
△	PCB	TXN/G1RHTB	CIRCUIT BOARD G	1	PAVCCZ
△	PCB	TXNGH1RHTB	CIRCUIT BOARD GH	1	PAVCCZ
△	PCB	TXNGS1RHTB	CIRCUIT BOARD GS	1	PAVCCZ
△	PCB	TXN/K1RHTB	CIRCUIT BOARD K	1	PAVCCZ B/E
△	PCB	TXN/K1RHTE	CIRCUIT BOARD K	1	PAVCCZ P
△	PCB	TXNGL1RHTB	CIRCUIT BOARD GL	1	PAVCCZ
	Q2001	2SD0601ARL	TRANSISTOR	1	
	Q2022	2SB0709ARL	TRANSISTOR	1	
	Q2027	B1CFNG000001	FET	1	
	Q2028	B1CBHD000002	FET	1	
	Q2029	B1CBHD000002	FET	1	
	Q2030	2SB0709ARL	TRANSISTOR	1	
	Q2033	2SB0709ARL	TRANSISTOR	1	
	Q2510	2SD0601ARL	TRANSISTOR	1	
	Q2511	2SD0601ARL	TRANSISTOR	1	
	Q2513	2SD0601ARL	TRANSISTOR	1	
	Q2519	2SD0601ARL	TRANSISTOR	1	B/E
	Q3022	2SD0601ARL	TRANSISTOR	1	
	Q3023	2SD0601ARL	TRANSISTOR	1	
	Q3024	2SD0601ARL	TRANSISTOR	1	
	Q3025	2SD0601ARL	TRANSISTOR	1	
	Q3026	2SD0601ARL	TRANSISTOR	1	
	Q3027	2SD0601ARL	TRANSISTOR	1	
	Q3028	2SB0709ARL	TRANSISTOR	1	
	Q3029	2SB0709ARL	TRANSISTOR	1	
	Q3801	2SD0601ARL	TRANSISTOR	1	
	Q3802	2SD0601ARL	TRANSISTOR	1	
	Q3804	2SD0601ARL	TRANSISTOR	1	
	Q4000	2SA207700L	TRANSISTOR	1	
	Q4001	2SA207700L	TRANSISTOR	1	
	Q4002	2SA207700L	TRANSISTOR	1	
	Q4017	2SD0601ASL	TRANSISTOR	1	
	Q4500	2SD0601ASL	TRANSISTOR	1	
	Q4501	2SD0601ASL	TRANSISTOR	1	

Safety	Ref. No.	Part No.	Part Name & Description	Pcs	Remarks
	Q4502	2SD0601ARL	TRANSISTOR	1	
	Q4503	2SD0601ARL	TRANSISTOR	1	
	Q4514	2SB0709ARL	TRANSISTOR	1	
	Q4515	2SB0709ARL	TRANSISTOR	1	
	Q4516	2SB0709ARL	TRANSISTOR	1	
	Q4517	2SB0709ARL	TRANSISTOR	1	
	Q4519	2SB0709ARL	TRANSISTOR	1	
	Q4520	2SD0601ARL	TRANSISTOR	1	
	Q4522	2SD0601ARL	TRANSISTOR	1	
	Q4523	2SD0601ASL	TRANSISTOR	1	
	Q4524	2SD0601ASL	TRANSISTOR	1	
	Q4528	2SB0709ARL	TRANSISTOR	1	
	Q4529	2SB0709ARL	TRANSISTOR	1	
	Q4530	2SB0709ARL	TRANSISTOR	1	
	Q4531	2SB0709ARL	TRANSISTOR	1	
	Q4801	2SD0601ASL	TRANSISTOR	1	
	Q4802	2SD0601ASL	TRANSISTOR	1	
	Q4803	2SD0601ASL	TRANSISTOR	1	
	Q4831	2SD0601ASL	TRANSISTOR	1	
	Q4832	2SD0601ASL	TRANSISTOR	1	
	Q5301	B1MBEDA00015	FET	1	
	Q5302	B1MBEDA00015	FET	1	
	Q5501	2SD0601ASL	TRANSISTOR	1	
	Q5522	2SB0709ARL	TRANSISTOR	1	
	Q5531	2SD0601ARL	TRANSISTOR	1	
	Q5532	2SD0601ARL	TRANSISTOR	1	
	Q5533	2SD0601ARL	TRANSISTOR	1	
	Q5534	2SD0601ARL	TRANSISTOR	1	
	Q5561	B1DHDC000028	FET	1	
	Q5562	2SD0601ARL	TRANSISTOR	1	
	Q5563	2SD0601ARL	TRANSISTOR	1	
	Q5564	2SD0601ARL	TRANSISTOR	1	
	Q5565	2SD0601ASL	TRANSISTOR	1	
	Q5600	B1MBEDA00015	FET	1	
	Q5601	B1MBDDA00003	FET	1	
	Q5602	B1MBDDA00003	FET	1	
	Q5603	2SD0601ARL	TRANSISTOR	1	
	Q5604	2SD0601ARL	TRANSISTOR	1	
	Q5691	2SD0601ARL	TRANSISTOR	1	
	Q5693	B1DHDC000028	FET	1	
	Q7700	2SB0709ARL	TRANSISTOR	1	
	Q7701	2SD0601ARL	TRANSISTOR	1	
	Q8401	2SD0601ASL	TRANSISTOR	1	B/E
	Q8402	2SD0601ASL	TRANSISTOR	1	B/E
	Q8850	2SD0601ARL	TRANSISTOR	1	
	Q8852	2SD0601ARL	TRANSISTOR	1	
	Q8853	2SD0601ASL	TRANSISTOR	1	
	Q9010	2SD0601ARL	TRANSISTOR	1	
	Q9058	2SD0601ARL	TRANSISTOR	1	
	Q9059	2SD0601ARL	TRANSISTOR	1	
	Q9060	2SD0601ARL	TRANSISTOR	1	
	Q9061	2SD0601ARL	TRANSISTOR	1	
	Q9805	2SD0601ARL	TRANSISTOR	1	
	Q9806	2SD0601ARL	TRANSISTOR	1	
	Q9807	B1MBDDA00003	FET	1	
	Q9808	B1MBDDA00015	FET	1	
	Q9809	B1MBDDA00003	FET	1	
	Q16002	2PG0060000RP	TRANSISTOR	1	
	Q16003	2PG0060000RP	TRANSISTOR	1	
	Q16004	2PG0060000RP	TRANSISTOR	1	
	Q16021	B1JAEP000002	TRANSISTOR	1	
	Q16022	B1JAEP000002	TRANSISTOR	1	
	Q16023	B1JAEP000002	TRANSISTOR	1	
	Q16024	B1JAEP000002	TRANSISTOR	1	
	Q16042	B1JAEN000003	TRANSISTOR	1	
	Q16051	B1JAEN000003	TRANSISTOR	1	
	Q16102	2SK399800L	FET	1	
	Q16104	2SK399800L	FET	1	
	Q16141	B1HFFFA00001	TRANSISTOR	1	
	Q16161	B1HFFFA00001	TRANSISTOR	1	
	Q16171	B1ABRD000003	TRANSISTOR	1	
	Q16172	B1ADRD000001	TRANSISTOR	1	
	Q16181	B1ABRD000003	TRANSISTOR	1	

Safety	Ref. No.	Part No.	Part Name & Description	Pcs	Remarks
	Q16182	B1ADRD000001	TRANSISTOR	1	
	Q16191	B1HFFFA00001	TRANSISTOR	1	
	Q16251	2SD0601ARL	TRANSISTOR	1	
	Q16280	2SD0601ARL	TRANSISTOR	1	
	Q16301	B1CBGD000001	FET	1	
	Q16302	B1CFNG000001	FET	1	
	Q16304	2SB0709ARL	TRANSISTOR	1	
	Q16331	B1CERL000012	FET	1	
	Q16335	B1CERL000012	FET	1	
	Q16339	2SK399500L	FET	1	
	Q16401	B1JAEN000002	TRANSISTOR	1	
	Q16403	B1JAEN000002	TRANSISTOR	1	
	Q16404	B1JAEN000002	TRANSISTOR	1	
	Q16421	2PG0060A00RP	TRANSISTOR	1	
	Q16423	2PG0060A00RP	TRANSISTOR	1	
	Q16424	2PG0060A00RP	TRANSISTOR	1	
	Q16442	B1JAEN000003	TRANSISTOR	1	
	Q16452	B1JAEP000003	TRANSISTOR	1	
	Q16471	B1ABCF000231	TRANSISTOR	1	
	Q16501	B1HFFFA00001	TRANSISTOR	1	
	Q16521	B1HFFFA00001	TRANSISTOR	1	
	Q16531	B1ABRD000003	TRANSISTOR	1	
	Q16532	B1ADRD000001	TRANSISTOR	1	
	Q16551	B1ABRD000003	TRANSISTOR	1	
	Q16552	B1ADRD000001	TRANSISTOR	1	
	Q16581	B1ABCF000231	TRANSISTOR	1	
	Q16601	B1DEET000002	FET	1	
	Q16602	2SD0601AQL	TRANSISTOR	1	
	Q16603	2SB0709ARL	TRANSISTOR	1	
	Q16604	B1CHPM000001	FET	1	
	Q16605	2SB0709ARL	TRANSISTOR	1	
	Q16606	2SD0601AQL	TRANSISTOR	1	
	Q16607	B1CBGD000001	FET	1	
	Q16608	B1ABCF000231	TRANSISTOR	1	
	Q16622	B1CFRM000008	FET	1	
	Q16623	B1CFRM000008	FET	1	
	Q16624	B1CFRM000008	FET	1	
	Q16625	B1CFRM000008	FET	1	
	Q16627	B1CFRM000008	FET	1	
	Q16628	B1CFRM000008	FET	1	
	Q16629	B1CFRM000008	FET	1	
	Q16634	B1CFRM000008	FET	1	
	Q16641	2SK4175000LZ	FET	1	
	Q16642	2SK4175000LZ	FET	1	
	Q16643	2SK4175000LZ	FET	1	
	Q16644	2SK4175000LZ	FET	1	
	Q16647	2SK4175000LZ	FET	1	
	Q16648	2SK4175000LZ	FET	1	
	Q16649	2SK4175000LZ	FET	1	
	Q16650	2SK4175000LZ	FET	1	
	Q16661	B1JAER000004	TRANSISTOR	1	
	Q16662	2SD0601AQL	TRANSISTOR	1	
	Q16663	2SB0709ARL	TRANSISTOR	1	
	Q16664	B1HFFFA00001	TRANSISTOR	1	
	Q16665	B1ABCF000231	TRANSISTOR	1	
	Q16743	2SD0601ARL	TRANSISTOR	1	
	Q16762	B1ADNF000006	TRANSISTOR	1	
	Q16763	B1ADNF000006	TRANSISTOR	1	
	Q16781	B1HFFFA00001	TRANSISTOR	1	
	Q16783	B1HFFFA00001	TRANSISTOR	1	
	Q16791	2SD0814A	TRANSISTOR	1	
	Q16794	B1ADCE000022	TRANSISTOR	1	
	Q16795	2SD0601ARL	TRANSISTOR	1	
	Q16796	2SC1473A	TRANSISTOR	1	
	Q16801	B1ADCN000007	TRANSISTOR	1	
	Q16802	B1ADCN000007	TRANSISTOR	1	
	Q16805	2SC3063000RL	TRANSISTOR	1	
	Q16806	2SC1473AEA	TRANSISTOR	1	
	Q16810	B1ABCF000231	TRANSISTOR	1	
	Q16811	B1ABCF000231	TRANSISTOR	1	
	Q16812	B1ABCF000231	TRANSISTOR	1	
	Q16814	B1ABCN000007	TRANSISTOR	1	
	Q16815	B1ABCN000007	TRANSISTOR	1	

Safety	Ref. No.	Part No.	Part Name & Description	Pcs	Remarks
	Q16816	2SD0601AQL	TRANSISTOR	1	
	Q16817	2SD0601AQL	TRANSISTOR	1	
	Q16872	2SB0709ARL	TRANSISTOR	1	
	Q16873	B1ABCF000231	TRANSISTOR	1	
	Q16874	B1CBGD000001	FET	1	
	Q16875	B1ABCF000231	TRANSISTOR	1	
	Q16876	B1ABCF000231	TRANSISTOR	1	
	Q16879	B1ABCF000231	TRANSISTOR	1	
	R853	ERJ6GEYJ472V	M 4.7K OHM J 1/10W	1	
	R855	ERJ6GEYJ472V	M 4.7K OHM J 1/10W	1	
	R856	ERJ6GEYJ472V	M 4.7K OHM J 1/10W	1	
	R857	ERJ6GEYJ472V	M 4.7K OHM J 1/10W	1	
	R859	ERJ6ENF2101	M2.10KOHM, 1/10W	1	
	R861	ERJ6GEYJ472V	M 4.7K OHM J 1/10W	1	
	R864	DOGDR00Z0002	M 0 OHM, 1/10W	1	
	R869	ERJ6GEYJ102V	M 1K OHM J 1/10W	1	
	R871	ERJ6ENF1302	M 13KOHM, 1/10W	1	
	R872	ERJ6ENF4990	M 499 OHM, 1/10W	1	
	R874	ERJ6GEYJ471	M 470 OHM,J,1/10W	1	
	R880	DOGDR00Z0002	M 0 OHM, 1/10W	1	
	R883	DOGDR00Z0002	M 0 OHM, 1/10W	1	
	R884	DOGDR00Z0002	M 0 OHM, 1/10W	1	
	R885	ERJ6GEY0R00V	M 0 OHM J 1/10W	1	
	R1100	ERJ2GEJ101	M 100 OHM, J,0.063W	1	
	R1101	DOYAR0000007	M 0 OHM 1/4W	1	
	R1102	ERJ2GEJ101	M 100 OHM, J,0.063W	1	
	R1103	ERJ2RKD330	M 33 OHM, J, 2W	1	
	R1104	ERJ2GEJ473	M 47KOHM, J,0.063W	1	
	R1105	ERJ2GEJ101	M 100 OHM, J,0.063W	1	
	R1106	ERJ2GEJ101	M 100 OHM, J,0.063W	1	
	R1107	ERJ2GEJ101	M 100 OHM, J,0.063W	1	
	R1108	ERJ2GEJ101	M 100 OHM, J,0.063W	1	
	R1109	ERJ2GEJ101	M 100 OHM, J,0.063W	1	
	R1110	ERJ2GEJ473	M 47KOHM, J,0.063W	1	
	R1124	ERJ2GEJ220	M 22 OHM, J,0.063W	1	
	R1125	ERJ2GEJ220	M 22 OHM, J,0.063W	1	
	R1134	ERJ2GEJ101	M 100 OHM, J,0.063W	1	
	R1139	ERJ2GEJ473	M 47KOHM, J,0.063W	1	
	R1146	ERJ2GEJ102X	M 1K OHM J 1/4W	1	
	R1147	ERJ2GEJ103	M 10KOHM, J,0.063W	1	
	R1148	ERJ2GEJ473	M 47KOHM, J,0.063W	1	
	R1153	ERJ2GEJ821	M 820 OHM, J,0.063W	1	
	R1157	ERJ2GEJ473	M 47KOHM, J,0.063W	1	
	R1162	ERJ2GEJ101	M 100 OHM, J,0.063W	1	
	R1164	ERJ2GEJ103	M 10KOHM, J,0.063W	1	
	R1166	ERJ2GEJ104	M 100KOHM, J,0.063W	1	
	R1169	ERJ2GEJ683	M 68KOHM, J,0.063W	1	
	R1170	ERJ2GEJ333	M 33KOHM, J,0.063W	1	
	R1171	ERJ2GEJ683	M 68KOHM, J,0.063W	1	

Safety	Ref. No.	Part No.	Part Name & Description	Pcs	Remarks
	R1172	ERJ2GEJ333	M 33KOHM, J,0.063W	1	
	R1173	ERJ2GEJ331	M 330 OHM, J,0.063W	1	
	R1174	DOYAR0000007	M 0 OHM 1/4W	1	
	R1175	DOYAR0000007	M 0 OHM 1/4W	1	
	R1179	ERJ2GEJ101	M 100 OHM, J,0.063W	1	
	R1181	ERJ2GEJ101	M 100 OHM, J,0.063W	1	
	R1182	ERJ2GED273X	M 27KOHM, J,0.063W	1	
	R1183	ERJ2GEJ220	M 22 OHM, J,0.063W	1	
	R1184	ERJ2GEJ220	M 22 OHM, J,0.063W	1	
	R1194	ERJ2GEJ683	M 68KOHM, J,0.063W	1	
	R1196	ERJ2GEJ473	M 47KOHM, J,0.063W	1	
	R1197	ERJ2GEJ103	M 10KOHM, J,0.063W	1	
	R1200	ERJ2GEJ472	M 4.7KOHM, J,0.063W	1	
	R1201	ERJ2GEJ472	M 4.7KOHM, J,0.063W	1	
	R1203	ERJ2GEJ473	M 47KOHM, J,0.063W	1	
	R1205	ERJ2GEJ220	M 22 OHM, J,0.063W	1	
	R1206	ERJ2GEJ220	M 22 OHM, J,0.063W	1	
	R1208	ERJ2GEJ103	M 10KOHM, J,0.063W	1	
	R1209	ERJ2GEJ472	M 4.7KOHM, J,0.063W	1	
	R1210	ERJ2GEJ473	M 47KOHM, J,0.063W	1	
	R1211	ERJ2GEJ473	M 47KOHM, J,0.063W	1	
	R1216	ERJ2GEJ103	M 10KOHM, J,0.063W	1	
	R1217	ERJ2GEJ104	M 100KOHM, J,0.063W	1	
	R1218	ERJ2GEJ103	M 10KOHM, J,0.063W	1	
	R1219	ERJ2GEJ103	M 10KOHM, J,0.063W	1	
	R1220	ERJ2GEJ103	M 10KOHM, J,0.063W	1	
	R1221	D1BB7151A055	M7.15KOHM, 1/10W	1	
	R1222	ERJ2GEJ473	M 47KOHM, J,0.063W	1	
	R1229	ERJ2GEJ101	M 100 OHM, J,0.063W	1	
	R1236	ERJ2GEJ473	M 47KOHM, J,0.063W	1	
	R1237	ERJ2GEJ102X	M 1K OHM J 1/4W	1	
	R1238	ERJ2GEJ473	M 47KOHM, J,0.063W	1	
	R1239	DOYAR0000007	M 0 OHM 1/4W	1	
	R1243	ERJ2GEJ473	M 47KOHM, J,0.063W	1	
	R1251	ERJ2GEJ473	M 47KOHM, J,0.063W	1	
	R1255	ERJ2GEJ102X	M 1K OHM J 1/4W	1	
	R2000	DOYAR0000007	M 0 OHM 1/4W	1	
	R2001	DOYAR0000007	M 0 OHM 1/4W	1	
	R2002	ERJ2GEJ681	M 680 OHM, J,0.063W	1	
	R2003	ERJ2GEJ105	M 1MOHM, J,0.063W	1	
	R2006	ERJ2GEJ471	M 470 OHM, J,0.063W	1	
	R2007	ERJ2GEJ221	M 220 OHM, J,0.063W	1	
	R2008	ERJ2GEJ471	M 470 OHM, J,0.063W	1	
	R2015	ERJ2GEJ103	M 10KOHM, J,0.063W	1	

Safety	Ref. No.	Part No.	Part Name & Description	Pcs	Remarks
	R2016	ERJ2GEJ103	M 10KOHM, J, 0.063W	1	
	R2017	ERJ2GEJ103	M 10KOHM, J, 0.063W	1	
	R2018	ERJ2GEJ103	M 10KOHM, J, 0.063W	1	
	R2019	D1BB2002A055	M 20KOHM, 1/10W	1	
	R2020	D1BB2001A055	M 2KOHM, 1/10W	1	
	R2023	ERJ2GEJ103	M 10KOHM, J, 0.063W	1	
	R2026	D1BB1203A055	M 120KOHM, 1/10W	1	
	R2027	D1BB7502A055	M 75KOHM, 1/10W	1	
	R2047	D1BB2002A055	M 20KOHM, 1/10W	1	
	R2048	D1BB2002A055	M 20KOHM, 1/10W	1	
	R2050	D1BB2002A055	M 20KOHM, 1/10W	1	
	R2051	D1BB2002A055	M 20KOHM, 1/10W	1	
	R2052	ERJ6GEYJ331V	M 330 OHM J 1/10W	1	
	R2053	DOYAR0000007	M 0 OHM 1/4W	1	
	R2057	ERJ2GEJ102X	M 1K OHM J 1/4W	1	
	R2058	ERJ2GEJ103	M 10KOHM, J, 0.063W	1	
	R2063	ERJ2GEJ101	M 100 OHM, J, 0.063W	1	
	R2064	ERJ2GEJ101	M 100 OHM, J, 0.063W	1	
	R2065	ERJ2GEJ823	M 82KOHM, J, 0.063W	1	
	R2068	DOYAR0000007	M 0 OHM 1/4W	1	
	R2071	ERJ2GEJ104	M 100KOHM, J, 0.063W	1	
	R2072	ERJ2GEJ104	M 100KOHM, J, 0.063W	1	
	R2073	ERJ6GEYG681	M 680 OHM, J, 1/10W	1	
	R2074	D1BB6802A055	M 68KOHM, 1/10W	1	
	R2075	D1BB1583A055	M 158KOHM, 1/10W	1	
	R2089	ERJ2GEJ153	M 15KOHM, J, 0.063W	1	
	R2090	ERJ2GEJ153	M 15KOHM, J, 0.063W	1	
	R2092	ERJ2GEJ103	M 10KOHM, J, 0.063W	1	
	R2093	ERJ2GEJ103	M 10KOHM, J, 0.063W	1	
	R2095	ERJ2GEJ473	M 47KOHM, J, 0.063W	1	
	R2096	ERJ2GEJ473	M 47KOHM, J, 0.063W	1	
	R2097	ERJ2GEJ105	M 1MOHM, J, 0.063W	1	
	R2098	ERJ2GEJ103	M 10KOHM, J, 0.063W	1	
	R2108	ERJ6GEYJ150V	M 15 OHM, J, 1/10W	1	
	R2111	ERJ2GEJ103	M 10KOHM, J, 0.063W	1	
	R2114	ERJ2GEJ222	M 2.2KOHM, J, 0.063W	1	
	R2115	ERJ2GEJ222	M 2.2KOHM, J, 0.063W	1	
	R2119	DOGBR00Z0002	M 0 OHM J 1/16W	1	P
	R2120	DOGBR00Z0002	M 0 OHM J 1/16W	1	P
	R2132	ERJ2GEJ471	M 470 OHM, J, 0.063W	1	
	R2141	ERJ2GEJ102X	M 1K OHM J 1/4W	1	
	R2142	ERJ2GEJ222	M 2.2KOHM, J, 0.063W	1	
	R2148	ERJ2RHD682X	M 22KOHM, J, 2W	1	
	R2149	ERJ2RHD682X	M 22KOHM, J, 2W	1	
	R2164	D1BB1003A055	M 100KOHM, 1/10W	1	
	R2165	D1BB3401A055	M 3.4KOHM, 1/10W	1	
	R2166	ERJ6GEYJ153V	M 15KOHM, J, 1/10W	1	
	R2172	ERJ2GEJ680	M 68 OHM, J, 0.063W	1	
	R2174	ERJ2GEJ221	M 220 OHM, J, 0.063W	1	
	R2175	D1BB5600A055	M 600 OHM, 1/10W	1	PAVCCZ

Safety	Ref. No.	Part No.	Part Name & Description	Pcs	Remarks
	R2176	ERJ6GEYJ271V	M 270 OHM J 1/10W	1	
	R2179	ERJ2GEJ221	M 220 OHM, J, 0.063W	1	
	R2191	DOGBR00Z0002	M 0 OHM J 1/16W	1	
	R2193	DOGBR00Z0002	M 0 OHM J 1/16W	1	B/E
	R2194	DOGBR00Z0002	M 0 OHM J 1/16W	1	B/E
	R2204	DOGBR00Z0002	M 0 OHM J 1/16W	1	
	R2205	DOGBR00Z0002	M 0 OHM J 1/16W	1	
	R2206	DOGBR00Z0002	M 0 OHM J 1/16W	1	
	R2208	ERJ2GEJ103	M 10KOHM, J, 0.063W	1	
	R2209	ERJ2GEJ103	M 10KOHM, J, 0.063W	1	
	R2211	ERJ2GEJ102X	M 1K OHM J 1/4W	1	
	R2270	EXB28V220J	RESISTOR ARRAY	1	
	R2271	EXB28V220J	RESISTOR ARRAY	1	
	R2300	D1BB4701A055	M 4.7KOHM, 1/10W	1	
	R2506	DOGDR00Z0002	M 0 OHM, 1/10W	1	
	R2507	DOGDR00Z0002	M 0 OHM, 1/10W	1	
	R2516	ERJ3GEYJ223	M 22KOHM, J, 1/16W	1	
	R2517	ERJ3GEYJ470	M 47 OHM, J, 1/16W	1	
	R2520	ERJ3GEYJ224	M 220KOHM, J, 1/16W	1	
	R2524	DOGB473JA057	M 47KOHM, J, 1/16W	1	
	R2525	D1BB60400001	M 604 OHM, 1/10W	1	
	R2530	DOGB473JA057	M 47KOHM, J, 1/16W	1	
	R2531	D1BB2700A055	M 270 OHM, 1/10W	1	
	R2542	DOGB473JA057	M 47KOHM, J, 1/16W	1	
	R2556	DOGB103JA041	M 10K OHM J 1/16W	1	
	R2557	ERJ3GEYJ223	M 22KOHM, J, 1/16W	1	
	R2561	ERJ3GEYJ223	M 22KOHM, J, 1/16W	1	B/E
	R2562	DOGB473JA057	M 47KOHM, J, 1/16W	1	B/E
	R2565	ERJ3EKF75R0	M 0.75HM, 1/16W	1	B/E
	R2581	DOGDR00Z0002	M 0 OHM, 1/10W	1	B/E
	R2601	ERJ2GEJ560X	M 56 OHM, J, 0.063W	1	
	R2602	ERJ2GEJ560X	M 56 OHM, J, 0.063W	1	
	R2603	ERJ2GEJ560X	M 56 OHM, J, 0.063W	1	
	R2605	ERJ2GEJ560X	M 56 OHM, J, 0.063W	1	
	R2606	ERJ2GEJ560X	M 56 OHM, J, 0.063W	1	
	R2607	EXB2HV560JV	RESISTOR ARRAY	1	
	R2608	EXB2HV560JV	RESISTOR ARRAY	1	
	R2609	ERJ2GEJ560X	M 56 OHM, J, 0.063W	1	
	R2610	ERJ2GEJ560X	M 56 OHM, J, 0.063W	1	
	R2611	EXB2HV560JV	RESISTOR ARRAY	1	
	R2612	ERJ2GEJ560X	M 56 OHM, J, 0.063W	1	
	R2613	ERJ2GEJ560X	M 56 OHM, J, 0.063W	1	
	R2614	ERJ2GEJ103	M 10KOHM, J, 0.063W	1	
	R2619	ERJ2GEJ680	M 68 OHM, J, 0.063W	1	
	R2620	DOYAR0000007	M 0 OHM 1/4W	1	
	R2621	DOYAR0000007	M 0 OHM 1/4W	1	
	R2622	ERJ2GEJ103	M 10KOHM, J, 0.063W	1	
	R2623	ERJ2GEJ103	M 10KOHM, J, 0.063W	1	
	R2624	ERJ2RKD330	M 33 OHM, J, 2W	1	
	R2625	ERJ2RKD330	M 33 OHM, J, 2W	1	
	R2626	EXB2HV330JV	RESISTOR ARRAY	1	
	R2631	ERJ2RKD330	M 33 OHM, J, 2W	1	
	R2632	ERJ2RKD330	M 33 OHM, J, 2W	1	
	R2633	EXB2HV330JV	RESISTOR ARRAY	1	
	R2634	ERJ2GEJ221	M 220 OHM, J, 0.063W	1	
	R2635	ERJ2GEJ221	M 220 OHM, J, 0.063W	1	

Safety	Ref. No.	Part No.	Part Name & Description	Pcs	Remarks
	R2636	ERJ2RKD330	M 33 OHM, J, 2W	1	
	R2637	ERJ2RKD330	M 33 OHM, J, 2W	1	
	R2638	EXB2HV330JV	RESISTOR ARRAY	1	
	R2644	ERJ2RKD330	M 33 OHM, J, 2W	1	
	R2645	ERJ2RKD330	M 33 OHM, J, 2W	1	
	R2646	EXB28V470JX	RESISTOR ARRAY	1	
	R2647	EXB28V470JX	RESISTOR ARRAY	1	
	R2648	EXB28V470JX	RESISTOR ARRAY	1	
	R2649	EXB28V470JX	RESISTOR ARRAY	1	
	R2650	ERJ2GEJ470	M 47 OHM, J, 0.063W	1	
	R2651	ERJ2GEJ470	M 47 OHM, J, 0.063W	1	
	R2652	ERJ2GEJ680	M 68 OHM, J, 0.063W	1	
	R2653	ERJ2GEJ240	M 24 OHM, J, 0.063W	1	
	R2654	ERJ2GEJ240	M 24 OHM, J, 0.063W	1	
	R2655	ERJ2GEJ470	M 47 OHM, J, 0.063W	1	
	R2656	ERJ2GEJ220	M 22 OHM, J, 0.063W	1	
	R2657	ERJ2GEJ680	M 68 OHM, J, 0.063W	1	
	R2658	EXB28V330J	RESISTOR ARRAY	1	
	R2659	EXB28V330J	RESISTOR ARRAY	1	
	R2660	EXB28V330J	RESISTOR ARRAY	1	
	R2661	EXB28V330J	RESISTOR ARRAY	1	
	R2662	ERJ2GEJ680	M 68 OHM, J, 0.063W	1	
	R2663	EXB28V680JX	RESISTOR ARRAY	1	
	R2664	EXB28V680JX	RESISTOR ARRAY	1	
	R2665	ERJ2GEJ680	M 68 OHM, J, 0.063W	1	
	R2666	EXB28V680JX	RESISTOR ARRAY	1	
	R2667	ERJ2GEJ680	M 68 OHM, J, 0.063W	1	
	R2669	EXB28V680JX	RESISTOR ARRAY	1	
	R2670	ERJ2GEJ680	M 68 OHM, J, 0.063W	1	
	R2671	ERJ2GEJ680	M 68 OHM, J, 0.063W	1	
	R2672	EXB28V680JX	RESISTOR ARRAY	1	
	R2673	EXB28V680JX	RESISTOR ARRAY	1	
	R2674	EXB28V680JX	RESISTOR ARRAY	1	
	R2675	EXB28V680JX	RESISTOR ARRAY	1	
	R2676	ERJ2GEJ101	M 100 OHM, J, 0.063W	1	
	R2677	ERJ2GEJ101	M 100 OHM, J, 0.063W	1	
	R2703	D1BB5R10A068	M 5.1 OHM, 1/10W	1	PAVCCZ
	R2704	ERJ2GEJ680	M 68 OHM, J, 0.063W	1	
	R2705	ERJ2GEJ101	M 100 OHM, J, 0.063W	1	
	R2709	ERJ2GEJ103	M 10KOHM, J, 0.063W	1	
	R2710	ERJ2GEJ680	M 68 OHM, J, 0.063W	1	
	R2711	ERJ2GEJ680	M 68 OHM, J, 0.063W	1	
	R2712	ERJ2GEJ103	M 10KOHM, J, 0.063W	1	
	R2715	DOGBR00Z0002	M 0 OHM J 1/16W	1	
	R2733	DOYAR0000007	M 0 OHM 1/4W	1	
	R3099	ERJ2GEJ473	M 47KOHM, J, 0.063W	1	
	R3100	ERJ2GEJ473	M 47KOHM, J, 0.063W	1	
	R3103	EXB28VR000X	RESISTOR ARRAY	1	
	R3104	EXB28VR000X	RESISTOR ARRAY	1	
	R3105	DOYAR0000007	M 0 OHM 1/4W	1	
	R3106	DOYAR0000007	M 0 OHM 1/4W	1	
	R3107	DOYAR0000007	M 0 OHM 1/4W	1	
	R3108	DOYAR0000007	M 0 OHM 1/4W	1	
	R3110	ERJ6GEYJ223	M 22KOHM, J, 1/10W	1	

Safety	Ref. No.	Part No.	Part Name & Description	Pcs	Remarks
	R3111	ERJ6GEYJ223	M 22KOHM, J, 1/10W	1	
	R3112	ERJ6GEYJ223	M 22KOHM, J, 1/10W	1	
	R3113	ERJ6GEYJ223	M 22KOHM, J, 1/10W	1	
	R3114	ERJ6GEYJ223	M 22KOHM, J, 1/10W	1	
	R3115	ERJ6GEYJ223	M 22KOHM, J, 1/10W	1	
	R3116	ERJ2GEJ104	M 100KOHM, J, 0.063W	1	
	R3117	ERJ2GEJ104	M 100KOHM, J, 0.063W	1	
	R3118	ERJ2GEJ222	M 2.2KOHM, J, 0.063W	1	
	R3119	ERJ2GEJ222	M 2.2KOHM, J, 0.063W	1	
	R3120	ERJ2GEJ104	M 100KOHM, J, 0.063W	1	
	R3121	ERJ2GEJ104	M 100KOHM, J, 0.063W	1	
	R3122	ERJ2GEJ222	M 2.2KOHM, J, 0.063W	1	
	R3123	ERJ2GEJ222	M 2.2KOHM, J, 0.063W	1	
	R3124	ERJ6RED750	M 75 OHM, 1/10W	1	
	R3125	ERJ2GEJ222	M 2.2KOHM, J, 0.063W	1	
	R3126	ERJ6RED750	M 75 OHM, 1/10W	1	
	R3127	ERJ2GEJ222	M 2.2KOHM, J, 0.063W	1	
	R3130	ERJ2GEJ104	M 100KOHM, J, 0.063W	1	
	R3131	ERJ2GEJ104	M 100KOHM, J, 0.063W	1	
	R3133	DOYAR0000007	M 0 OHM 1/4W	1	
	R3134	ERJ2GEJ331	M 330 OHM, J, 0.063W	1	
	R3135	ERJ2GEJ331	M 330 OHM, J, 0.063W	1	
	R3136	DOYAR0000007	M 0 OHM 1/4W	1	
	R3137	ERJ2GEJ473	M 47KOHM, J, 0.063W	1	
	R3138	ERJ2GEJ221	M 220 OHM, J, 0.063W	1	
	R3139	ERJ2GEJ221	M 220 OHM, J, 0.063W	1	
	R3140	ERJ2GEJ221	M 220 OHM, J, 0.063W	1	
	R3141	ERJ2GEJ221	M 220 OHM, J, 0.063W	1	
	R3142	ERJ2GEJ331	M 330 OHM, J, 0.063W	1	
	R3143	ERJ2GEJ331	M 330 OHM, J, 0.063W	1	
	R3144	ERJ2GEJ221	M 220 OHM, J, 0.063W	1	
	R3145	ERJ2GEJ221	M 220 OHM, J, 0.063W	1	
	R3146	ERJ2GEJ221	M 220 OHM, J, 0.063W	1	
	R3147	DOYAR0000007	M 0 OHM 1/4W	1	
	R3148	DOYAR0000007	M 0 OHM 1/4W	1	
	R3150	ERJ2GEJ221	M 220 OHM, J, 0.063W	1	
	R3151	ERJ2GEJ221	M 220 OHM, J, 0.063W	1	
	R3152	ERJ2GEJ221	M 220 OHM, J, 0.063W	1	
	R3154	ERJ2GEJ221	M 220 OHM, J, 0.063W	1	
	R3155	ERJ2GEJ221	M 220 OHM, J, 0.063W	1	
	R3170	ERJ2GED273X	M 27KOHM, J, 0.063W	1	
	R3171	ERJ2GED273X	M 27KOHM, J, 0.063W	1	
	R3175	ERJ2GEJ473	M 47KOHM, J, 0.063W	1	
	R3176	ERJ6RED750	M 75 OHM, 1/10W	1	
	R3187	ERJ2GEJ104	M 100KOHM, J, 0.063W	1	

Safety	Ref. No.	Part No.	Part Name & Description	Pcs	Remarks
	R3189	ERJ2GEJ104	M 100KOHM, J,0.063W	1	
	R3208	ERJ6ENF1500	M 150 OHM, 1/10W	1	
	R3212	ERJ6ENF1500	M 150 OHM, 1/10W	1	
	R3213	ERJ6ENF1500	M 150 OHM, 1/10W	1	
	R3217	ERJ6ENF1500	M 150 OHM, 1/10W	1	
	R3218	ERJ6ENF1500	M 150 OHM, 1/10W	1	
	R3219	ERJ6ENF1500	M 150 OHM, 1/10W	1	
	R3223	ERJ6ENF1500	M 150 OHM, 1/10W	1	
	R3225	ERJ6ENF1500	M 150 OHM, 1/10W	1	
	R3236	ERJ6ENF1500	M 150 OHM, 1/10W	1	
	R3237	ERJ6ENF1500	M 150 OHM, 1/10W	1	
	R3238	ERJ6RED750	M 75 OHM, 1/10W	1	
	R3239	ERJ6RED750	M 75 OHM, 1/10W	1	
	R3240	ERJ6RED750	M 75 OHM, 1/10W	1	
	R3245	ERJ6ENF1500	M 150 OHM, 1/10W	1	
	R3255	ERJ6GEYJ680V	M 68 OHM,J,1/10W	1	
	R3256	ERJ6ENF2152	M21.5KOHM, 1/10W	1	
	R3262	ERJ6ENF2152	M21.5KOHM, 1/10W	1	
	R3265	ERJ6ENF1302	M 13KOHM, 1/10W	1	
	R3343	ERJ6ENF1500	M 150 OHM, 1/10W	1	
	R3344	ERJ6ENF1500	M 150 OHM, 1/10W	1	
	R3364	ERJ2GEJ221	M 220 OHM, J,0.063W	1	
	R3366	ERJ2GEJ104	M 100KOHM, J,0.063W	1	
	R3369	ERJ6ENF1500	M 150 OHM, 1/10W	1	
	R3371	ERJ6ENF1500	M 150 OHM, 1/10W	1	
	R3377	DOYAR0000007	M 0 OHM 1/4W	1	
	R3383	DOYAR0000007	M 0 OHM 1/4W	1	
	R3384	ERJ2GEJ473	M 47KOHM, J,0.063W	1	
	R3385	ERJ2GEJ473	M 47KOHM, J,0.063W	1	
	R3387	ERJ2GEJ221	M 220 OHM, J,0.063W	1	
	R3388	ERJ2GEJ221	M 220 OHM, J,0.063W	1	
	R3389	ERJ2GEJ221	M 220 OHM, J,0.063W	1	
	R3390	ERJ2GEJ221	M 220 OHM, J,0.063W	1	
	R3391	ERJ2GEJ221	M 220 OHM, J,0.063W	1	
	R3392	ERJ2GEJ331	M 330 OHM, J,0.063W	1	
	R3393	ERJ6RED750	M 75 OHM, 1/10W	1	
	R3395	ERJ2GEJ221	M 220 OHM, J,0.063W	1	
	R3397	ERJ2GEJ221	M 220 OHM, J,0.063W	1	
	R3400	ERJ2GEJ221	M 220 OHM, J,0.063W	1	
	R3401	ERJ2GEJ221	M 220 OHM, J,0.063W	1	B/E
	R3402	ERJ2GEJ331	M 330 OHM, J,0.063W	1	
	R3403	DOYAR0000007	M 0 OHM 1/4W	1	
	R3404	ERJ2GEJ680	M 68 OHM, J,0.063W	1	
	R3405	ERJ2GEJ680	M 68 OHM, J,0.063W	1	
	R3406	ERJ2GEJ680	M 68 OHM, J,0.063W	1	
	R3407	ERJ2GEJ221	M 220 OHM, J,0.063W	1	
	R3408	ERJ2GEJ221	M 220 OHM, J,0.063W	1	
	R3409	ERJ2GEJ221	M 220 OHM, J,0.063W	1	
	R3410	ERJ2GEJ473	M 47KOHM, J,0.063W	1	
	R3411	ERJ2GEJ221	M 220 OHM, J,0.063W	1	
	R3412	ERJ2GEJ221	M 220 OHM, J,0.063W	1	
	R3413	ERJ2GEJ102X	M 1K OHM J 1/4W	1	

Safety	Ref. No.	Part No.	Part Name & Description	Pcs	Remarks
	R3414	ERJ2GEJ274	M 270KOHM, J,0.063W	1	
	R3415	ERJ2GEJ473	M 47KOHM, J,0.063W	1	
	R3418	ERJ2GEJ331	M 330 OHM, J,0.063W	1	
	R3425	ERJ6GEYJ680V	M 68 OHM,J,1/10W	1	
	R3439	ERJ6RED750	M 75 OHM, 1/10W	1	
	R3440	ERJ2GEJ221	M 220 OHM, J,0.063W	1	
	R3441	ERJ2GEJ104	M 100KOHM, J,0.063W	1	
	R3442	ERJ3RBD361	M 360 OHM,J,1/16W	1	
	R3443	ERJ3RBD361	M 360 OHM,J,1/16W	1	
	R3444	ERJ6RED750	M 75 OHM, 1/10W	1	
	R3445	ERJ2GEJ221	M 220 OHM, J,0.063W	1	
	R3446	ERJ2GEJ104	M 100KOHM, J,0.063W	1	
	R3447	ERJ3RBD361	M 360 OHM,J,1/16W	1	
	R3448	ERJ3RBD361	M 360 OHM,J,1/16W	1	
	R3449	DOYAR0000007	M 0 OHM 1/4W	1	
	R3450	DOYAR0000007	M 0 OHM 1/4W	1	
	R3451	ERJ2GEJ473	M 47KOHM, J,0.063W	1	
	R3452	ERJ2GEJ274	M 270KOHM, J,0.063W	1	
	R3454	ERJ6ENF1302	M 13KOHM, 1/10W	1	
	R3457	ERJ2GEJ473	M 47KOHM, J,0.063W	1	
	R3458	ERJ6ENF1500	M 150 OHM, 1/10W	1	
	R3459	ERJ6ENF1500	M 150 OHM, 1/10W	1	
	R3460	ERJ6ENF1500	M 150 OHM, 1/10W	1	
	R3461	ERJ2GEJ680	M 68 OHM, J,0.063W	1	
	R3462	ERJ2GEJ680	M 68 OHM, J,0.063W	1	
	R3463	ERJ2GEJ680	M 68 OHM, J,0.063W	1	
	R3465	ERJ6ENF1500	M 150 OHM, 1/10W	1	
	R3470	ERJ6ENF1500	M 150 OHM, 1/10W	1	
	R3475	DOYAR0000007	M 0 OHM 1/4W	1	
	R3476	ERJ6ENF1500	M 150 OHM, 1/10W	1	
	R3477	ERJ6ENF1500	M 150 OHM, 1/10W	1	
	R3480	DOYAR0000007	M 0 OHM 1/4W	1	
	R3481	DOYAR0000007	M 0 OHM 1/4W	1	
	R3482	DOYAR0000007	M 0 OHM 1/4W	1	
	R3484	ERJ6ENF1500	M 150 OHM, 1/10W	1	
	R3485	ERJ6ENF1500	M 150 OHM, 1/10W	1	
	R3489	DOYAR0000007	M 0 OHM 1/4W	1	
	R3490	DOYAR0000007	M 0 OHM 1/4W	1	
	R3491	DOYAR0000007	M 0 OHM 1/4W	1	
	R3492	DOYAR0000007	M 0 OHM 1/4W	1	
	R3495	ERJ2GEJ101	M 100 OHM, J,0.063W	1	
	R3497	ERJ2GEJ101	M 100 OHM, J,0.063W	1	
	R3508	ERJ2GEJ680	M 68 OHM, J,0.063W	1	
	R3509	ERJ2GEJ680	M 68 OHM, J,0.063W	1	
	R3510	ERJ2GEJ101	M 100 OHM, J,0.063W	1	
	R3511	ERJ2GEJ473	M 47KOHM, J,0.063W	1	
	R3512	ERJ2GEJ221	M 220 OHM, J,0.063W	1	
	R3513	ERJ2GEJ473	M 47KOHM, J,0.063W	1	
	R3514	DOYAR0000007	M 0 OHM 1/4W	1	
	R3515	DOYAR0000007	M 0 OHM 1/4W	1	
	R3518	DOYAR0000007	M 0 OHM 1/4W	1	
	R3520	DOYAR0000007	M 0 OHM 1/4W	1	

Safety	Ref. No.	Part No.	Part Name & Description	Pcs	Remarks
	R3716	ERJ6GEYJ184	M 180KOHM, J, 1/10W	1	
	R3717	ERJ6GEYJ184	M 180KOHM, J, 1/10W	1	
	R3721	DOGD103JA036	M 10KOHM, J, 0.25W	1	
	R3751	ERJ6ENF1432	M14.3KOHM, 1/10W	1	
	R3753	ERJ6ENF1741	M1.74KOHM, 1/10W	1	
	R3758	ERJ6ENF6651	M6.65KOHM, 1/10W	1	
	R3767	ERJ6ENF7151	M7.15KOHM, 1/10W	1	
	R3801	ERJ2GEJ103	M 10KOHM, J, 0.063W	1	
	R3802	ERJ2GEJ103	M 10KOHM, J, 0.063W	1	
	R3803	ERJ2GEJ332	M 3.3KOHM, J, 0.063W	1	
	R3804	ERJ2GEJ472	M 4.7KOHM, J, 0.063W	1	
	R3805	ERJ2GEJ472	M 4.7KOHM, J, 0.063W	1	
	R3806	ERJ2GEJ473	M 47KOHM, J, 0.063W	1	
	R3807	ERJ2GEJ100	M 10 OHM, J, 0.063W	1	
	R3808	ERJ2GEJ100	M 10 OHM, J, 0.063W	1	
	R3809	ERJ2GEJ102X	M 1K OHM J 1/4W	1	
	R3810	ERJ2GEJ102X	M 1K OHM J 1/4W	1	
	R3811	D1BB4701A055	M 4.7KOHM, 1/10W	1	
	R3812	ERJ2GEJ103	M 10KOHM, J, 0.063W	1	
	R3814	ERJ2GEJ472	M 4.7KOHM, J, 0.063W	1	
	R3815	D0YAR0000007	M 0 OHM 1/4W	1	
	R3818	ERJ2GEJ103	M 10KOHM, J, 0.063W	1	
	R3821	ERJ2RKD330	M 33 OHM, J, 2W	1	
	R3822	ERJ2GEJ102X	M 1K OHM J 1/4W	1	
	R3823	ERJ2GEJ103	M 10KOHM, J, 0.063W	1	
	R3824	D0GA2R7JA014	M 2.7OHM, J, 0.063W	1	
	R3825	D0GA2R7JA014	M 2.7OHM, J, 0.063W	1	
	R3826	D0GA2R7JA014	M 2.7OHM, J, 0.063W	1	
	R3827	D0GA2R7JA014	M 2.7OHM, J, 0.063W	1	
	R3828	D0GA2R7JA014	M 2.7OHM, J, 0.063W	1	
	R3829	D0GA2R7JA014	M 2.7OHM, J, 0.063W	1	
	R3830	D0GA2R7JA014	M 2.7OHM, J, 0.063W	1	
	R3831	D0GA2R7JA014	M 2.7OHM, J, 0.063W	1	
	R3832	ERJ2GEJ472	M 4.7KOHM, J, 0.063W	1	
	R3834	D1BB49R90002	M 49 OHM, 1/10W	1	
	R3840	ERJ2GEJ100	M 10 OHM, J, 0.063W	1	
	R3841	ERJ2GEJ100	M 10 OHM, J, 0.063W	1	
	R3845	ERJ2GEJ472	M 4.7KOHM, J, 0.063W	1	
	R3847	D0YAR0000007	M 0 OHM 1/4W	1	
	R4029	EXB2HV680J	RESISTOR ARRAY	1	
	R4030	EXB2HV680J	RESISTOR ARRAY	1	
	R4031	ERJ2GEJ680	M 68 OHM, J, 0.063W	1	
	R4032	ERJ2GEJ680	M 68 OHM, J, 0.063W	1	
	R4033	ERJ2GEJ680	M 68 OHM, J, 0.063W	1	
	R4034	D1BB7500A055	M 750 OHM, 1/10W	1	
	R4035	D1BB1241A055	M1.24KOHM, 1/10W	1	PAVCCZ
	R4036	D0YAR0000007	M 0 OHM 1/4W	1	
	R4037	D0YAR0000007	M 0 OHM 1/4W	1	
	R4038	ERJ2GEJ681	M 680 OHM, J, 0.063W	1	

Safety	Ref. No.	Part No.	Part Name & Description	Pcs	Remarks
	R4039	ERJ2GEJ102X	M 1K OHM J 1/4W	1	
	R4040	ERJ2GEJ681	M 680 OHM, J, 0.063W	1	
	R4041	ERJ2GEJ102X	M 1K OHM J 1/4W	1	
	R4042	ERJ2GEJ102X	M 1K OHM J 1/4W	1	
	R4043	DOGB202JA057	M 2KOHM, J, 1/16W	1	
	R4046	ERJ2GEJ101	M 100 OHM, J, 0.063W	1	
	R4047	ERJ2GEJ101	M 100 OHM, J, 0.063W	1	
	R4048	ERJ2GEJ103	M 10KOHM, J, 0.063W	1	
	R4049	ERJ2GEJ473	M 47KOHM, J, 0.063W	1	
	R4153	ERJ2GEJ473	M 47KOHM, J, 0.063W	1	
	R4154	ERJ2GEJ473	M 47KOHM, J, 0.063W	1	
	R4155	ERJ2GEJ103	M 10KOHM, J, 0.063W	1	
	R4158	D0YAR0000007	M 0 OHM 1/4W	1	
	R4274	ERJ2GEJ220	M 22 OHM, J, 0.063W	1	
	R4275	ERJ2GEJ680	M 68 OHM, J, 0.063W	1	
	R4277	ERJ2GEJ680	M 68 OHM, J, 0.063W	1	
	R4278	ERJ2GEJ680	M 68 OHM, J, 0.063W	1	
	R4279	ERJ2GEJ680	M 68 OHM, J, 0.063W	1	
	R4281	D0YAR0000007	M 0 OHM 1/4W	1	
	R4282	D0YAR0000007	M 0 OHM 1/4W	1	
	R4283	ERJ2GEJ680	M 68 OHM, J, 0.063W	1	
	R4303	ERJ2GEJ103	M 10KOHM, J, 0.063W	1	
	R4306	ERJ2GEJ101	M 100 OHM, J, 0.063W	1	
	R4335	ERJ2GEJ332	M 3.3KOHM, J, 0.063W	1	
	R4338	ERJ2GEJ473	M 47KOHM, J, 0.063W	1	
	R4500	ERJ2GEJ103	M 10KOHM, J, 0.063W	1	
	R4501	ERJ2GEJ103	M 10KOHM, J, 0.063W	1	
	R4502	ERJ2RKD330	M 33 OHM, J, 2W	1	
	R4503	ERJ2RKD330	M 33 OHM, J, 2W	1	
	R4506	ERJ2GEJ680	M 68 OHM, J, 0.063W	1	
	R4507	D0YAR0000007	M 0 OHM 1/4W	1	
	R4526	ERJ2GEJ102X	M 1K OHM J 1/4W	1	
	R4527	ERJ2GEJ102X	M 1K OHM J 1/4W	1	
	R4528	ERJ2GEJ103	M 10KOHM, J, 0.063W	1	
	R4530	ERJ2GEJ103	M 10KOHM, J, 0.063W	1	
	R4538	ERJ2GEJ473	M 47KOHM, J, 0.063W	1	
	R4540	ERJ2GEJ473	M 47KOHM, J, 0.063W	1	
	R4552	ERJ2GEJ220	M 22 OHM, J, 0.063W	1	
	R4567	D1BB4701A055	M 4.7KOHM, 1/10W	1	
	R4587	D1BB1241A055	M1.24KOHM, 1/10W	1	PAVCCZ
	R4588	D1BB7150A055	M 715 OHM, 1/10W	1	PAVCCZ
	R4589	D1BB7150A055	M 715 OHM, 1/10W	1	PAVCCZ
	R4592	D1BB7150A055	M 715 OHM, 1/10W	1	PAVCCZ
	R4593	D1BB8060A055	M 806 OHM, 1/10W	1	
	R4596	ERJ6GEYJ102V	M 1K OHM J 1/10W	1	
	R4597	ERJ6GEYJ102V	M 1K OHM J 1/10W	1	
	R4598	ERJ6GEYJ102V	M 1K OHM J 1/10W	1	
	R4600	ERJ2GEJ680	M 68 OHM, J, 0.063W	1	
	R4601	ERJ6GEYJ102V	M 1K OHM J 1/10W	1	
	R4603	ERJ2GEJ680	M 68 OHM, J, 0.063W	1	

Safety	Ref. No.	Part No.	Part Name & Description	Pcs	Remarks
	R4604	ERJ2GEJ680	M 68 OHM, J, 0.063W	1	
	R4605	D1BB8060A055	M 806 OHM, 1/10W	1	
	R4606	D1BB9101A055	M 9.1KOHM, 1/10W	1	
	R4608	ERJ6GEJ102V	M 1K OHM J 1/10W	1	
	R4609	ERJ2GEJ122	M 1.2KOHM, J, 0.063W	1	
	R4610	DOYAR0000007	M 0 OHM 1/4W	1	
	R4611	D1BB5601A055	M 5.6KOHM, 1/10W	1	
	R4613	ERJ2GEJ680	M 68 OHM, J, 0.063W	1	
	R4614	ERJ2GEJ103	M 10KOHM, J, 0.063W	1	
	R4615	ERJ2RKD330	M 33 OHM, J, 2W	1	
	R4619	DOYAR0000007	M 0 OHM 1/4W	1	
	R4621	DOYAR0000007	M 0 OHM 1/4W	1	
	R4622	ERJ2GEJ102X	M 1K OHM J 1/4W	1	
	R4626	ERJ3EKF3160	M 316 OHM, 1/16W	1	
	R4627	ERJ3EKF3160	M 316 OHM, 1/16W	1	
	R4628	ERJ2GEJ101	M 100 OHM, J, 0.063W	1	
	R4629	ERJ2GEJ101	M 100 OHM, J, 0.063W	1	
	R4631	D1BB4990A055	M 499 OHM, 1/10W	1	
	R4634	ERJ3EKF3160	M 316 OHM, 1/16W	1	
	R4635	EXB28V680JX	RESISTOR ARRAY	1	
	R4636	ERJ2GEJ680	M 68 OHM, J, 0.063W	1	
	R4637	ERJ2GEJ680	M 68 OHM, J, 0.063W	1	
	R4638	ERJ2GEJ680	M 68 OHM, J, 0.063W	1	
	R4639	EXB28V680JX	RESISTOR ARRAY	1	
	R4640	EXB28V680JX	RESISTOR ARRAY	1	
	R4641	ERJ2GEJ220	M 22 OHM, J, 0.063W	1	
	R4643	ERJ2GEJ220	M 22 OHM, J, 0.063W	1	
	R4644	ERJ2GEJ472	M 4.7KOHM, J, 0.063W	1	
	R4645	ERJ2GEJ680	M 68 OHM, J, 0.063W	1	
	R4646	ERJ2GEJ680	M 68 OHM, J, 0.063W	1	
	R4647	ERJ2GEJ680	M 68 OHM, J, 0.063W	1	
	R4648	EXB28V330J	RESISTOR ARRAY	1	
	R4650	ERJ2GEJ680	M 68 OHM, J, 0.063W	1	
	R4651	ERJ2GEJ680	M 68 OHM, J, 0.063W	1	
	R4652	ERJ2GEJ473	M 47KOHM, J, 0.063W	1	
	R4653	DOYAR0000007	M 0 OHM 1/4W	1	
	R4656	ERJ2GEJ222	M 2.2KOHM, J, 0.063W	1	
	R4657	DOYAR0000007	M 0 OHM 1/4W	1	
	R4658	DOYAR0000007	M 0 OHM 1/4W	1	
	R4661	DOYAR0000007	M 0 OHM 1/4W	1	
	R4663	DOYAR0000007	M 0 OHM 1/4W	1	
	R4664	D1BB1241A055	M 1.24KOHM, 1/10W	1	PAVCCZ
	R4665	ERJ2GEJ473	M 47KOHM, J, 0.063W	1	
	R4666	ERJ2GEJ473	M 47KOHM, J, 0.063W	1	
	R4673	DOYAR0000007	M 0 OHM 1/4W	1	
	R4678	ERJ2GEJ680	M 68 OHM, J, 0.063W	1	
	R4679	EXB28V680JX	RESISTOR ARRAY	1	
	R4680	ERJ2GEJ102X	M 1K OHM J 1/4W	1	
	R4681	ERJ2GEJ103	M 10KOHM, J, 0.063W	1	
	R4683	ERJ2GEJ472	M 4.7KOHM, J, 0.063W	1	
	R4685	ERJ2GEJ473	M 47KOHM, J, 0.063W	1	
	R4686	ERJ2GEJ680	M 68 OHM, J, 0.063W	1	

Safety	Ref. No.	Part No.	Part Name & Description	Pcs	Remarks
	R4687	ERJ2GEJ680	M 68 OHM, J, 0.063W	1	
	R4689	ERJ2GEJ103	M 10KOHM, J, 0.063W	1	
	R4690	ERJ2GEJ560X	M 56 OHM, J, 0.063W	1	
	R4691	ERJ2GEJ220	M 22 OHM, J, 0.063W	1	
	R4692	ERJ2GEJ680	M 68 OHM, J, 0.063W	1	
	R4693	ERJ2GEJ680	M 68 OHM, J, 0.063W	1	
	R4694	ERJ2GEJ680	M 68 OHM, J, 0.063W	1	
	R4696	ERJ2GEJ680	M 68 OHM, J, 0.063W	1	
	R4699	ERJ2GEJ680	M 68 OHM, J, 0.063W	1	
	R4700	EXB28V680JX	RESISTOR ARRAY	1	
	R4701	ERJ2GEJ680	M 68 OHM, J, 0.063W	1	
	R4704	ERJ2GEJ680	M 68 OHM, J, 0.063W	1	
	R4705	ERJ2GEJ680	M 68 OHM, J, 0.063W	1	
	R4706	ERJ2GEJ680	M 68 OHM, J, 0.063W	1	
	R4707	ERJ2GEJ680	M 68 OHM, J, 0.063W	1	
	R4708	ERJ2GEJ680	M 68 OHM, J, 0.063W	1	
	R4711	ERJ2GEJ220	M 22 OHM, J, 0.063W	1	
	R4712	ERJ2GEJ220	M 22 OHM, J, 0.063W	1	
	R4713	ERJ2GEJ220	M 22 OHM, J, 0.063W	1	
	R4714	ERJ2GEJ472	M 4.7KOHM, J, 0.063W	1	
	R4715	ERJ2GEJ472	M 4.7KOHM, J, 0.063W	1	
	R4716	ERJ2GEJ220	M 22 OHM, J, 0.063W	1	
	R4717	ERJ2GEJ220	M 22 OHM, J, 0.063W	1	
	R4720	ERJ2GEJ220	M 22 OHM, J, 0.063W	1	
	R4721	ERJ2GEJ473	M 47KOHM, J, 0.063W	1	
	R4722	ERJ2GEJ473	M 47KOHM, J, 0.063W	1	
	R4723	ERJ2GEJ220	M 22 OHM, J, 0.063W	1	
	R4724	ERJ2GEJ220	M 22 OHM, J, 0.063W	1	
	R4726	ERJ2GEJ103	M 10KOHM, J, 0.063W	1	
	R4727	ERJ2GEJ103	M 10KOHM, J, 0.063W	1	
	R4728	ERJ2GEJ103	M 10KOHM, J, 0.063W	1	
	R4729	ERJ2GEJ103	M 10KOHM, J, 0.063W	1	
	R4731	ERJ2GEJ103	M 10KOHM, J, 0.063W	1	
	R4732	ERJ2GEJ103	M 10KOHM, J, 0.063W	1	
	R4733	ERJ2GEJ103	M 10KOHM, J, 0.063W	1	
	R4736	ERJ2GEJ103	M 10KOHM, J, 0.063W	1	
	R4737	ERJ2GEJ103	M 10KOHM, J, 0.063W	1	
	R4742	DOYAR0000007	M 0 OHM 1/4W	1	
	R4743	DOYAR0000007	M 0 OHM 1/4W	1	
	R4749	DOYAR0000007	M 0 OHM 1/4W	1	
	R4750	DOYAR0000007	M 0 OHM 1/4W	1	
	R4755	ERJ2RHD272	M 27KOHM, J, 2W	1	
	R4756	ERJ2RHD272	M 27KOHM, J, 2W	1	

Safety	Ref. No.	Part No.	Part Name & Description	Pcs	Remarks
	R4757	ERJ2GEJ103	M 10KOHM, J, 0.063W	1	
	R4758	ERJ2GEJ104	M 100KOHM, J, 0.063W	1	
	R4759	ERJ2GEJ103	M 10KOHM, J, 0.063W	1	
	R4760	ERJ2GEJ104	M 100KOHM, J, 0.063W	1	
	R4761	ERJ2RHD272	M 27KOHM, J, 2W	1	
	R4762	ERJ2RHD272	M 27KOHM, J, 2W	1	
	R4763	ERJ2GEJ103	M 10KOHM, J, 0.063W	1	
	R4764	ERJ2GEJ104	M 100KOHM, J, 0.063W	1	
	R4765	ERJ2GEJ103	M 10KOHM, J, 0.063W	1	
	R4766	ERJ2GEJ104	M 100KOHM, J, 0.063W	1	
	R4810	ERJ2GEJ103	M 10KOHM, J, 0.063W	1	
	R4811	ERJ2GEJ473	M 47KOHM, J, 0.063W	1	
	R4812	ERJ2GEJ473	M 47KOHM, J, 0.063W	1	
	R4813	ERJ2GEJ103	M 10KOHM, J, 0.063W	1	
	R4814	ERJ2GEJ103	M 10KOHM, J, 0.063W	1	
	R4817	ERJ2GEJ220	M 22 OHM, J, 0.063W	1	
	R4832	ERJ2GEJ101	M 100 OHM, J, 0.063W	1	
	R4833	ERJ2GEJ104	M 100KOHM, J, 0.063W	1	
	R4834	ERJ2GEJ102X	M 1K OHM J 1/4W	1	
	R4841	ERJ2GEJ104	M 100KOHM, J, 0.063W	1	
	R4842	ERJ2GEJ102X	M 1K OHM J 1/4W	1	
	R4844	ERJ2GEJ101	M 100 OHM, J, 0.063W	1	
	R4853	ERJ2GEJ104	M 100KOHM, J, 0.063W	1	
	R4854	ERJ2GEJ104	M 100KOHM, J, 0.063W	1	
	R4856	ERJ2GEJ103	M 10KOHM, J, 0.063W	1	
	R4857	ERJ2GEJ473	M 47KOHM, J, 0.063W	1	
	R5024	ERJ2GEJ101	M 100 OHM, J, 0.063W	1	
	R5025	D1BB2700A055	M 270 OHM, 1/10W	1	
	R5026	D1BB2700A055	M 270 OHM, 1/10W	1	
	R5049	ERJ2GEJ470	M 47 OHM, J, 0.063W	1	
	R5050	ERJ2GEJ470	M 47 OHM, J, 0.063W	1	
	R5051	ERJ2GEJ470	M 47 OHM, J, 0.063W	1	
	R5052	ERJ2GEJ470	M 47 OHM, J, 0.063W	1	
	R5053	ERJ2GEJ470	M 47 OHM, J, 0.063W	1	
	R5054	ERJ2GEJ470	M 47 OHM, J, 0.063W	1	
	R5055	ERJ2GEJ470	M 47 OHM, J, 0.063W	1	
	R5056	ERJ2GEJ470	M 47 OHM, J, 0.063W	1	
	R5057	ERJ2GEJ470	M 47 OHM, J, 0.063W	1	
	R5058	ERJ2GEJ470	M 47 OHM, J, 0.063W	1	
	R5059	ERJ2GEJ470	M 47 OHM, J, 0.063W	1	
	R5060	ERJ2GEJ470	M 47 OHM, J, 0.063W	1	
	R5061	ERJ2GEJ470	M 47 OHM, J, 0.063W	1	
	R5062	ERJ2GEJ470	M 47 OHM, J, 0.063W	1	

Safety	Ref. No.	Part No.	Part Name & Description	Pcs	Remarks
	R5063	ERJ2GEJ470	M 47 OHM, J, 0.063W	1	
	R5064	ERJ2GEJ470	M 47 OHM, J, 0.063W	1	
	R5065	ERJ2GEJ470	M 47 OHM, J, 0.063W	1	
	R5066	ERJ2GEJ470	M 47 OHM, J, 0.063W	1	
	R5067	ERJ2GEJ221	M 220 OHM, J, 0.063W	1	
	R5068	ERJ2GEJ470	M 47 OHM, J, 0.063W	1	
	R5070	ERJ2GEJ470	M 47 OHM, J, 0.063W	1	
	R5071	ERJ2GEJ470	M 47 OHM, J, 0.063W	1	
	R5074	ERJ2GEJ103	M 10KOHM, J, 0.063W	1	
	R5075	D1BA75R0A014	M0.75KOHM, 1/10W	1	
	R5076	ERJ2GEJ301	M 300 OHM, J, 0.063W	1	
	R5077	D0YAR0000007	M 0 OHM 1/4W	1	
	R5078	ERJ2GEJ221	M 220 OHM, J, 0.063W	1	
	R5079	ERJ2GEJ103	M 10KOHM, J, 0.063W	1	
	R5080	ERJ2GEJ103	M 10KOHM, J, 0.063W	1	
	R5082	ERJ2GEJ103	M 10KOHM, J, 0.063W	1	
	R5088	ERJ3GEYJ680	M 68 OHM, J, 1/16W	1	
	R5092	D0GBR00Z0002	M 0 OHM J 1/16W	1	
	R5200	ERJ2GEJ680	M 68 OHM, J, 0.063W	1	
	R5201	ERJ2GEJ680	M 68 OHM, J, 0.063W	1	
	R5202	ERJ2GEJ680	M 68 OHM, J, 0.063W	1	
	R5203	ERJ2GEJ680	M 68 OHM, J, 0.063W	1	
	R5204	ERJ2GEJ472	M 4.7KOHM, J, 0.063W	1	
	R5205	ERJ2GEJ472	M 4.7KOHM, J, 0.063W	1	
	R5206	ERJ2GEJ472	M 4.7KOHM, J, 0.063W	1	
	R5207	ERJ2GEJ472	M 4.7KOHM, J, 0.063W	1	
	R5208	ERJ2GEJ105	M 1MOHM, J, 0.063W	1	
	R5209	D0YAR0000007	M 0 OHM 1/4W	1	
	R5210	ERJ2GEJ103	M 10KOHM, J, 0.063W	1	
	R5216	ERJ2GEJ472	M 4.7KOHM, J, 0.063W	1	
	R5217	ERJ2GEJ472	M 4.7KOHM, J, 0.063W	1	
	R5223	ERJ2GEJ101	M 100 OHM, J, 0.063W	1	
	R5225	ERJ2GEJ680	M 68 OHM, J, 0.063W	1	
	R5226	ERJ2GEJ332	M 3.3KOHM, J, 0.063W	1	
	R5227	D0GB103JA041	M 10K OHM J 1/16W	1	
	R5229	D0GB103JA041	M 10K OHM J 1/16W	1	
	R5231	EXB2HV680J	RESISTOR ARRAY	1	
	R5232	EXB2HV680J	RESISTOR ARRAY	1	
	R5314	D0GBR00Z0002	M 0 OHM J 1/16W	1	
	R5316	D0YAR0000007	M 0 OHM 1/4W	1	
	R5321	D1BB4702A055	M 47KOHM, 1/10W	1	
	R5322	ERJ2GEJ104	M 100KOHM, J, 0.063W	1	
	R5323	D1BB5602A055	M 56KOHM, 1/10W	1	
	R5324	ERJ2GEJ473	M 47KOHM, J, 0.063W	1	
	R5325	D0YAR0000007	M 0 OHM 1/4W	1	
	R5326	D0YAR0000007	M 0 OHM 1/4W	1	

Safety	Ref. No.	Part No.	Part Name & Description	Pcs	Remarks
	R5327	DOYAR0000007	M 0 OHM 1/4W	1	
	R5328	DOYAR0000007	M 0 OHM 1/4W	1	
	R5329	D1BB2802A055	M 28KOHM, 1/10W	1	
	R5330	D1BB4752A055	M47.5KOHM, 1/10W	1	
	R5331	D1BB3602A055	M 36KOHM, 1/10W	1	
	R5332	D1BB3002A055	M 30KOHM, 1/10W	1	
	R5333	D1BB2802A055	M 28KOHM, 1/10W	1	
	R5334	D1BB2402A055	M 24KOHM, 1/10W	1	
	R5335	ERJ2GEJ680	M 68 OHM, J,0.063W	1	
	R5337	DOYAR0000007	M 0 OHM 1/4W	1	
	R5431	DOYAR0000007	M 0 OHM 1/4W	1	
	R5433	D1BB1002A055	M 10KOHM, 1/10W	1	
	R5434	D1BB2702A055	M 27KOHM, 1/10W	1	
	R5435	ERJ2GEJ332	M 3.3KOHM, J,0.063W	1	
	R5441	DOYAR0000007	M 0 OHM 1/4W	1	
	R5443	D1BB1002A055	M 10KOHM, 1/10W	1	
	R5444	D1BB2201A055	M 2.2KOHM, 1/10W	1	
	R5445	ERJ2GEJ103	M 10KOHM, J,0.063W	1	
	R5451	D1BB5602A055	M 56KOHM, 1/10W	1	
	R5452	D1BB4702A055	M 47KOHM, 1/10W	1	
	R5453	D1BB3002A055	M 30KOHM, 1/10W	1	
	R5456	DOYAR0000007	M 0 OHM 1/4W	1	
	R5459	DOYAR0000007	M 0 OHM 1/4W	1	
	R5503	ERJ6ENF2611	M2.61KOHM, 1/10W	1	
	R5504	ERJ6ENF1271	M1.27KOHM, 1/10W	1	
	R5506	ERJ6GEYJ103V	M 10K OHM J 1/10W	1	
	R5507	ERJ6GEYJ103V	M 10K OHM J 1/10W	1	
	R5508	ERJ6GEYF473	M 47KOHM, J,1/10W	1	
	R5509	ERJ6GEYR00V	M 0 OHM J 1/10W	1	
	R5515	DOGBR0020002	M 0 OHM J 1/16W	1	
	R5516	DOGBR0020002	M 0 OHM J 1/16W	1	
	R5535	ERJ2GEJ222	M 2.2KOHM, J,0.063W	1	
	R5536	ERJ2GEJ472	M 4.7KOHM, J,0.063W	1	
	R5537	ERJ2GEJ681	M 680 OHM, J,0.063W	1	
	R5538	ERJ2GEJ122	M 1.2KOHM, J,0.063W	1	
	R5542	ERJ6GEYJ471	M 470 OHM, J,1/10W	1	
	R5544	ERJ6GEYJ221V	M 220 OHM, J,1/10W	1	
	R5550	ERJ6GEYJ102V	M 1K OHM J 1/10W	1	
	R5556	ERJ2GEJ472	M 4.7KOHM, J,0.063W	1	
	R5557	ERJ2GEJ473	M 47KOHM, J,0.063W	1	
	R5558	ERJ2GEJ473	M 47KOHM, J,0.063W	1	
	R5559	ERJ2GEJ333	M 33KOHM, J,0.063W	1	
	R5560	ERJ2GEJ103	M 10KOHM, J,0.063W	1	
	R5561	ERJ2GEJ103	M 10KOHM, J,0.063W	1	
	R5565	ERJ2GEJ103	M 10KOHM, J,0.063W	1	
	R5566	ERJ2GEJ103	M 10KOHM, J,0.063W	1	
	R5567	ERJ2GEJ473	M 47KOHM, J,0.063W	1	
	R5569	ERJ2GEJ103	M 10KOHM, J,0.063W	1	
	R5570	ERJ2GEJ103	M 10KOHM, J,0.063W	1	
	R5571	ERJ2GEJ473	M 47KOHM, J,0.063W	1	
	R5572	ERJ2GEJ222	M 2.2KOHM, J,0.063W	1	
	R5573	ERJ2GEJ472	M 4.7KOHM, J,0.063W	1	

Safety	Ref. No.	Part No.	Part Name & Description	Pcs	Remarks
	R5574	ERJ2GEJ103	M 10KOHM, J,0.063W	1	
	R5575	ERJ2GEJ473	M 47KOHM, J,0.063W	1	
	R5576	ERJ2GEJ473	M 47KOHM, J,0.063W	1	
	R5577	ERJ2GEJ333	M 33KOHM, J,0.063W	1	
	R5578	ERJ2GEJ473	M 47KOHM, J,0.063W	1	
	R5579	ERJ2GEJ473	M 47KOHM, J,0.063W	1	
	R5580	ERJ2GEJ102X	M 1K OHM J 1/4W	1	
	R5581	ERJ2GEJ473	M 47KOHM, J,0.063W	1	
	R5582	ERJ2GEJ473	M 47KOHM, J,0.063W	1	
	R5583	ERJ2GEJ473	M 47KOHM, J,0.063W	1	
	R5587	ERJ2GEJ560X	M 56 OHM, J,0.063W	1	
	R5588	ERJ6GEYJ102V	M 1K OHM J 1/10W	1	
	R5589	ERJ6GEYJ104V	M 100KOHM, J,1/10W	1	
	R5590	ERJ6GEYJ472V	M 4.7K OHM J 1/10W	1	
	R5591	ERJ6GEYJ472V	M 4.7K OHM J 1/10W	1	
	R5592	ERJ6GEYJ472V	M 4.7K OHM J 1/10W	1	
	R5600	ERJ2GEJ680	M 68 OHM, J,0.063W	1	
	R5601	DOGBR0020002	M 0 OHM J 1/16W	1	
	R5602	DOYAR0000007	M 0 OHM 1/4W	1	
	R5603	DOYAR0000007	M 0 OHM 1/4W	1	
	R5604	D1BB2802A055	M 28KOHM, 1/10W	1	
	R5605	D1BB3602A055	M 36KOHM, 1/10W	1	
	R5606	DOYAR0000007	M 0 OHM 1/4W	1	
	R5607	DOYAR0000007	M 0 OHM 1/4W	1	
	R5610	ERJ2GEJ104	M 100KOHM, J,0.063W	1	
	R5611	D1BB3602A055	M 36KOHM, 1/10W	1	
	R5612	D1BB2402A055	M 24KOHM, 1/10W	1	
	R5614	DOGBR0020002	M 0 OHM J 1/16W	1	
	R5616	DOYAR0000007	M 0 OHM 1/4W	1	
	R5620	ERJ2GEJ680	M 68 OHM, J,0.063W	1	
	R5621	D1BB3602A055	M 36KOHM, 1/10W	1	
	R5622	ERJ2GEJ104	M 100KOHM, J,0.063W	1	
	R5623	D1BB3602A055	M 36KOHM, 1/10W	1	
	R5625	DOYAR0000007	M 0 OHM 1/4W	1	
	R5626	DOYAR0000007	M 0 OHM 1/4W	1	
	R5627	DOYAR0000007	M 0 OHM 1/4W	1	
	R5628	DOYAR0000007	M 0 OHM 1/4W	1	
	R5629	D1BB4752A055	M47.5KOHM, 1/10W	1	
	R5630	D1BB4702A055	M 47KOHM, 1/10W	1	
	R5631	D1BB3002A055	M 30KOHM, 1/10W	1	
	R5632	D1BB1272A055	M12.7KOHM, 1/10W	1	
	R5633	D1BB4702A055	M 47KOHM, 1/10W	1	
	R5634	D1BB4702A055	M 47KOHM, 1/10W	1	
	R5635	ERJ2GEJ223	M 22KOHM, J,0.063W	1	
	R5636	ERJ2GEJ683	M 68KOHM, J,0.063W	1	
	R5637	DOYAR0000007	M 0 OHM 1/4W	1	
	R5638	ERJ2GEJ103	M 10KOHM, J,0.063W	1	
	R5641	ERJ2GEJ473	M 47KOHM, J,0.063W	1	
	R5644	ERJ2GEJ222	M 2.2KOHM, J,0.063W	1	
	R5646	ERJ2GEJ103	M 10KOHM, J,0.063W	1	
	R5647	ERJ2GEJ473	M 47KOHM, J,0.063W	1	
	R5660	ERJ2GEJ103	M 10KOHM, J,0.063W	1	

Safety	Ref. No.	Part No.	Part Name & Description	Pcs	Remarks
	R5661	ERJ2GEJ123	M 12KOHM ,J,0.063W	1	
	R5662	ERJ2GEJ473	M 47KOHM, J,0.063W	1	
	R5663	ERJ2GEJ101	M 100 OHM, J,0.063W	1	
	R5664	D0YAR0000007	M 0 OHM 1/4W	1	
	R5691	D0GB103JA041	M 10K OHM J 1/16W	1	
	R5693	D0GB473JA057	M 47KOHM,J,1/16W	1	
	R5695	D1BB2001A055	M 2KOHM, 1/10W	1	
	R5697	ERJ2GEJ472	M 4.7KOHM, J,0.063W	1	
	R5698	D0GDR00Z0002	M 0 OHM, 1/10W	1	
	R5699	D0GDR00Z0002	M 0 OHM, 1/10W	1	
	R5702	ERJ2GEJ222	M 2.2KOHM, J,0.063W	1	
	R5732	ERJ2GEJ153	M 15KOHM ,J,0.063W	1	
	R5733	ERJ2GEJ333	M 33KOHM, J,0.063W	1	
	R7701	D0GB103JA041	M 10K OHM J 1/16W	1	
	R7702	ERJ3EKF75R0	M 0.75HM, 1/16W	1	
	R7703	ERJ3GEYJ223	M 22KOHM,J,1/16W	1	
	R7704	D0GB102JA041	M 1KOHM,J,1/16W	1	
	R7705	D0GB103JA041	M 10K OHM J 1/16W	1	
	R7706	ERJ3GEYJ222	M 2.2KOHM,J,1/16W	1	
	R7708	D0GB104JA041	M 100KOHM J 1/16W	1	
	R7709	D0GB104JA041	M 100KOHM J 1/16W	1	
	R7710	D0GB102JA041	M 1KOHM,J,1/16W	1	
	R7711	ERJ3GEYJ472	M 4.7KOHM,J,1/16W	1	
	R7712	D0GB104JA041	M 100KOHM J 1/16W	1	
	R7713	ERJ3GEYJ222	M 2.2KOHM,J,1/16W	1	
	R7714	D1BB1202A055	M 12KOHM, 1/10W	1	
	R7715	ERJ3GEYJ222	M 2.2KOHM,J,1/16W	1	
	R7716	D0GB105JA041	M 1M OHM F 1/16W	1	
	R7717	D0GB103JA041	M 10K OHM J 1/16W	1	
	R7718	D0GB103JA041	M 10K OHM J 1/16W	1	
	R7719	D0GBR00Z0002	M 0 OHM J 1/16W	1	
	R7725	ERJ3GEYJ680	M 68 OHM,J,1/16W	1	
	R7726	D0GB103JA041	M 10K OHM J 1/16W	1	
	R7727	D0GB103JA041	M 10K OHM J 1/16W	1	
	R7733	ERJ3GEYJ680	M 68 OHM,J,1/16W	1	
	R7734	ERJ3GEYJ680	M 68 OHM,J,1/16W	1	
	R7735	ERJ3GEYJ680	M 68 OHM,J,1/16W	1	
	R7737	ERJ3GEYJ680	M 68 OHM,J,1/16W	1	
	R7738	ERJ3GEYJ680	M 68 OHM,J,1/16W	1	
	R7742	D0GB103JA041	M 10K OHM J 1/16W	1	
	R7744	D0GBR00Z0002	M 0 OHM J 1/16W	1	
	R7749	J0JCC0000241	CHIP INDUCTOR	1	
	R7750	J0JCC0000241	CHIP INDUCTOR	1	
	R7751	J0JCC0000241	CHIP INDUCTOR	1	
	R7754	D0GB103JA041	M 10K OHM J 1/16W	1	
	R7777	D1BB3402A055	M 34KOHM, 1/10W	1	
	R7778	D1BB1002A055	M 10KOHM, 1/10W	1	
	R7779	EXB38VR000V	RESISTOR ARRAY	1	
	R7781	D0GBR00Z0002	M 0 OHM J 1/16W	1	
	R7782	D0GBR00Z0002	M 0 OHM J 1/16W	1	
	R7800	D0GBR00Z0002	M 0 OHM J 1/16W	1	
	R8001	D1BB3901A055	M 3.9KOHM, 1/10W	1	
	R8002	D1BB2402A055	M 24KOHM, 1/10W	1	
	R8003	D1BB1002A055	M 10KOHM, 1/10W	1	

Safety	Ref. No.	Part No.	Part Name & Description	Pcs	Remarks
	R8004	D1BB5601A055	M 5.6KOHM, 1/10W	1	
	R8005	ERJ2GEJ181	M 180 OHM, J,0.063W	1	
	R8006	ERJ2GEJ820	M 82 OHM, J,0.063W	1	
	R8007	ERJ2GEJ181	M 180 OHM, J,0.063W	1	
	R8008	ERJ2GEJ820	M 82 OHM, J,0.063W	1	
	R8016	D0GDR00Z0002	M 0 OHM, 1/10W	1	
	R8017	D0GDR00Z0002	M 0 OHM, 1/10W	1	
	R8080	EXB2HV103JV	RESISTOR ARRAY	1	B/E
	R8081	EXB28V103JX	RESISTOR ARRAY	1	B/E
	R8082	ERJ2GEJ103	M 10KOHM, J,0.063W	1	B/E
	R8083	D0YAR0000007	M 0 OHM 1/4W	1	B/E
	R8084	D0YAR0000007	M 0 OHM 1/4W	1	B/E
	R8086	ERJ2GEJ104	M 100KOHM, J,0.063W	1	B/E
	R8087	ERJ2GEJ104	M 100KOHM, J,0.063W	1	B/E
	R8088	ERJ2GEJ104	M 100KOHM, J,0.063W	1	B/E
	R8089	ERJ2GEJ104	M 100KOHM, J,0.063W	1	B/E
	R8090	ERJ2GEJ104	M 100KOHM, J,0.063W	1	B/E
	R8091	ERJ2GEJ104	M 100KOHM, J,0.063W	1	B/E
	R8092	ERJ2GEJ104	M 100KOHM, J,0.063W	1	B/E
	R8093	ERJ2GEJ101	M 100 OHM, J,0.063W	1	B/E
	R8094	ERJ2GEJ680	M 68 OHM, J,0.063W	1	B/E
	R8098	ERJ2GEJ102X	M 1K OHM J 1/4W	1	B/E
	R8101	ERJ2GEJ103	M 10KOHM, J,0.063W	1	
	R8102	ERJ2GEJ103	M 10KOHM, J,0.063W	1	
	R8105	ERJ2GEJ104	M 100KOHM, J,0.063W	1	
	R8106	ERJ2GEJ680	M 68 OHM, J,0.063W	1	
	R8108	ERJ2GEJ820	M 82 OHM, J,0.063W	1	
	R8110	ERJ2GEJ680	M 68 OHM, J,0.063W	1	
	R8111	ERJ2GEJ820	M 82 OHM, J,0.063W	1	
	R8112	ERJ2GEJ103	M 10KOHM, J,0.063W	1	
	R8117	ERJ2GEJ103	M 10KOHM, J,0.063W	1	
	R8118	ERJ2RKD330	M 33 OHM, J, 2W	1	B/E
	R8126	ERJ2GEJ103	M 10KOHM, J,0.063W	1	
	R8132	D0YAR0000007	M 0 OHM 1/4W	1	
	R8133	D0YAR0000007	M 0 OHM 1/4W	1	
	R8134	ERJ2GEJ221	M 220 OHM, J,0.063W	1	
	R8135	ERJ2GEJ103	M 10KOHM, J,0.063W	1	
	R8136	ERJ2GEJ221	M 220 OHM, J,0.063W	1	
	R8139	D0YAR0000007	M 0 OHM 1/4W	1	
	R8140	D0YAR0000007	M 0 OHM 1/4W	1	
	R8141	D0YAR0000007	M 0 OHM 1/4W	1	
	R8142	D0YAR0000007	M 0 OHM 1/4W	1	
	R8143	D1BB2700A055	M 270 OHM, 1/10W	1	
	R8144	D1BB2700A055	M 270 OHM, 1/10W	1	
	R8145	ERJ2GEJ101	M 100 OHM, J,0.063W	1	
	R8149	D0YAR0000007	M 0 OHM 1/4W	1	
	R8150	D0YAR0000007	M 0 OHM 1/4W	1	
	R8151	D0YAR0000007	M 0 OHM 1/4W	1	
	R8152	D0YAR0000007	M 0 OHM 1/4W	1	
	R8153	D0YAR0000007	M 0 OHM 1/4W	1	

Safety	Ref. No.	Part No.	Part Name & Description	Pcs	Remarks
	R8154	DOYAR0000007	M 0 OHM 1/4W	1	
	R8155	DOYAR0000007	M 0 OHM 1/4W	1	
	R8156	DOYAR0000007	M 0 OHM 1/4W	1	
	R8157	DOYAR0000007	M 0 OHM 1/4W	1	
	R8158	DOYAR0000007	M 0 OHM 1/4W	1	
	R8159	DOYAR0000007	M 0 OHM 1/4W	1	
	R8160	DOYAR0000007	M 0 OHM 1/4W	1	
	R8161	DOYAR0000007	M 0 OHM 1/4W	1	
	R8162	DOYAR0000007	M 0 OHM 1/4W	1	
	R8163	DOYAR0000007	M 0 OHM 1/4W	1	
	R8164	DOYAR0000007	M 0 OHM 1/4W	1	
	R8165	DOYAR0000007	M 0 OHM 1/4W	1	
	R8166	DOYAR0000007	M 0 OHM 1/4W	1	
	R8167	DOYAR0000007	M 0 OHM 1/4W	1	
	R8168	DOYAR0000007	M 0 OHM 1/4W	1	
	R8169	DOYAR0000007	M 0 OHM 1/4W	1	
	R8170	DOYAR0000007	M 0 OHM 1/4W	1	
	R8171	DOYAR0000007	M 0 OHM 1/4W	1	
	R8172	DOYAR0000007	M 0 OHM 1/4W	1	
	R8173	DOYAR0000007	M 0 OHM 1/4W	1	
	R8174	DOYAR0000007	M 0 OHM 1/4W	1	
	R8175	DOYAR0000007	M 0 OHM 1/4W	1	
	R8176	DOYAR0000007	M 0 OHM 1/4W	1	
	R8177	DOYAR0000007	M 0 OHM 1/4W	1	
	R8178	DOYAR0000007	M 0 OHM 1/4W	1	
	R8179	D1BB75R0A055	M 75 OHM, 1/10W	1	
	R8180	ERJ3GEJ301	M 300 OHM, J, 1/16W	1	
	R8181	D1BB75R0A055	M 75 OHM, 1/10W	1	
	R8182	D1BB75R0A055	M 75 OHM, 1/10W	1	
	R8183	D1BB75R0A055	M 75 OHM, 1/10W	1	
	R8184	ERJ3GEJ301	M 300 OHM, J, 1/16W	1	
	R8185	D1BB75R0A055	M 75 OHM, 1/10W	1	
	R8186	D1BB75R0A055	M 75 OHM, 1/10W	1	
	R8187	ERJ2GEJ101	M 100 OHM, J, 0.063W	1	
	R8188	D1BB2700A055	M 270 OHM, 1/10W	1	
	R8189	D1BB2700A055	M 270 OHM, 1/10W	1	
	R8190	DOYAR0000007	M 0 OHM 1/4W	1	
	R8191	DOYAR0000007	M 0 OHM 1/4W	1	
	R8192	DOYAR0000007	M 0 OHM 1/4W	1	
	R8193	DOYAR0000007	M 0 OHM 1/4W	1	
	R8196	ERJ2GEJ221	M 220 OHM, J, 0.063W	1	
	R8197	ERJ2GEJ103	M 10KOHM, J, 0.063W	1	
	R8198	ERJ2GEJ221	M 220 OHM, J, 0.063W	1	
	R8199	DOYAR0000007	M 0 OHM 1/4W	1	
	R8201	ERJ2GEJ470	M 47 OHM, J, 0.063W	1	
	R8202	ERJ2GEJ470	M 47 OHM, J, 0.063W	1	
	R8203	ERJ2GEJ470	M 47 OHM, J, 0.063W	1	
	R8204	ERJ2GEJ470	M 47 OHM, J, 0.063W	1	
	R8205	ERJ2GEJ470	M 47 OHM, J, 0.063W	1	
	R8206	ERJ2GEJ470	M 47 OHM, J, 0.063W	1	
	R8207	ERJ2GEJ470	M 47 OHM, J, 0.063W	1	
	R8208	ERJ2GEJ470	M 47 OHM, J, 0.063W	1	
	R8209	ERJ2GEJ470	M 47 OHM, J, 0.063W	1	
	R8210	ERJ2GEJ470	M 47 OHM, J, 0.063W	1	
	R8211	ERJ2GEJ470	M 47 OHM, J, 0.063W	1	
	R8212	ERJ2GEJ470	M 47 OHM, J, 0.063W	1	
	R8213	ERJ2GEJ470	M 47 OHM, J, 0.063W	1	
	R8214	DOYAR0000007	M 0 OHM 1/4W	1	

Safety	Ref. No.	Part No.	Part Name & Description	Pcs	Remarks
	R8215	DOYAR0000007	M 0 OHM 1/4W	1	
	R8216	ERJ2GEJ470	M 47 OHM, J, 0.063W	1	
	R8217	ERJ2GEJ470	M 47 OHM, J, 0.063W	1	
	R8218	ERJ2GEJ470	M 47 OHM, J, 0.063W	1	
	R8219	ERJ2GEJ470	M 47 OHM, J, 0.063W	1	
	R8220	ERJ2GEJ470	M 47 OHM, J, 0.063W	1	
	R8221	ERJ2GEJ470	M 47 OHM, J, 0.063W	1	
	R8222	ERJ2GEJ470	M 47 OHM, J, 0.063W	1	
	R8223	ERJ2GEJ470	M 47 OHM, J, 0.063W	1	
	R8224	ERJ2GEJ470	M 47 OHM, J, 0.063W	1	
	R8225	ERJ2GEJ470	M 47 OHM, J, 0.063W	1	
	R8226	ERJ2GEJ470	M 47 OHM, J, 0.063W	1	
	R8227	ERJ2GEJ470	M 47 OHM, J, 0.063W	1	
	R8228	ERJ2GEJ470	M 47 OHM, J, 0.063W	1	
	R8229	ERJ2GEJ470	M 47 OHM, J, 0.063W	1	
	R8230	ERJ2GEJ470	M 47 OHM, J, 0.063W	1	
	R8231	ERJ2GEJ470	M 47 OHM, J, 0.063W	1	
	R8232	ERJ2GEJ470	M 47 OHM, J, 0.063W	1	
	R8233	ERJ2GEJ470	M 47 OHM, J, 0.063W	1	
	R8234	ERJ2GEJ470	M 47 OHM, J, 0.063W	1	
	R8235	ERJ2GEJ470	M 47 OHM, J, 0.063W	1	
	R8236	ERJ2GEJ470	M 47 OHM, J, 0.063W	1	
	R8237	ERJ2GEJ470	M 47 OHM, J, 0.063W	1	
	R8238	DOYAR0000007	M 0 OHM 1/4W	1	
	R8239	DOYAR0000007	M 0 OHM 1/4W	1	
	R8240	ERJ2GEJ470	M 47 OHM, J, 0.063W	1	
	R8241	ERJ2GEJ470	M 47 OHM, J, 0.063W	1	
	R8242	ERJ2GEJ470	M 47 OHM, J, 0.063W	1	
	R8243	ERJ2GEJ470	M 47 OHM, J, 0.063W	1	
	R8244	ERJ2GEJ470	M 47 OHM, J, 0.063W	1	
	R8245	ERJ2GEJ470	M 47 OHM, J, 0.063W	1	
	R8246	ERJ2GEJ470	M 47 OHM, J, 0.063W	1	
	R8247	ERJ2GEJ470	M 47 OHM, J, 0.063W	1	
	R8248	ERJ2GEJ470	M 47 OHM, J, 0.063W	1	
	R8249	DOYAR0000007	M 0 OHM 1/4W	1	
	R8250	DOYAR0000007	M 0 OHM 1/4W	1	
	R8251	DOYAR0000007	M 0 OHM 1/4W	1	
	R8252	DOYAR0000007	M 0 OHM 1/4W	1	
	R8253	DOYAR0000007	M 0 OHM 1/4W	1	
	R8254	DOYAR0000007	M 0 OHM 1/4W	1	
	R8255	DOYAR0000007	M 0 OHM 1/4W	1	
	R8256	DOYAR0000007	M 0 OHM 1/4W	1	
	R8257	DOYAR0000007	M 0 OHM 1/4W	1	
	R8258	DOYAR0000007	M 0 OHM 1/4W	1	
	R8259	DOYAR0000007	M 0 OHM 1/4W	1	
	R8260	DOYAR0000007	M 0 OHM 1/4W	1	
	R8261	DOYAR0000007	M 0 OHM 1/4W	1	
	R8262	DOYAR0000007	M 0 OHM 1/4W	1	

Safety	Ref. No.	Part No.	Part Name & Description	Pcs	Remarks
	R8263	DOYAR0000007	M 0 OHM 1/4W	1	
	R8264	DOYAR0000007	M 0 OHM 1/4W	1	
	R8265	DOYAR0000007	M 0 OHM 1/4W	1	
	R8266	DOYAR0000007	M 0 OHM 1/4W	1	
	R8267	DOYAR0000007	M 0 OHM 1/4W	1	
	R8268	DOYAR0000007	M 0 OHM 1/4W	1	
	R8269	DOYAR0000007	M 0 OHM 1/4W	1	
	R8270	DOYAR0000007	M 0 OHM 1/4W	1	
	R8271	DOYAR0000007	M 0 OHM 1/4W	1	
	R8272	DOYAR0000007	M 0 OHM 1/4W	1	
	R8273	DOYAR0000007	M 0 OHM 1/4W	1	
	R8274	DOYAR0000007	M 0 OHM 1/4W	1	
	R8275	DOYAR0000007	M 0 OHM 1/4W	1	
	R8276	DOYAR0000007	M 0 OHM 1/4W	1	
	R8277	DOYAR0000007	M 0 OHM 1/4W	1	
	R8278	DOYAR0000007	M 0 OHM 1/4W	1	
	R8279	DOYAR0000007	M 0 OHM 1/4W	1	
	R8280	DOYAR0000007	M 0 OHM 1/4W	1	
	R8281	DOYAR0000007	M 0 OHM 1/4W	1	
	R8282	DOYAR0000007	M 0 OHM 1/4W	1	
	R8283	DOYAR0000007	M 0 OHM 1/4W	1	
	R8284	DOYAR0000007	M 0 OHM 1/4W	1	
	R8285	DOYAR0000007	M 0 OHM 1/4W	1	
	R8286	DOYAR0000007	M 0 OHM 1/4W	1	
	R8287	DOYAR0000007	M 0 OHM 1/4W	1	
	R8288	DOYAR0000007	M 0 OHM 1/4W	1	
	R8289	DOYAR0000007	M 0 OHM 1/4W	1	
	R8290	DOYAR0000007	M 0 OHM 1/4W	1	
	R8291	DOYAR0000007	M 0 OHM 1/4W	1	
	R8292	DOYAR0000007	M 0 OHM 1/4W	1	
	R8293	DOYAR0000007	M 0 OHM 1/4W	1	
	R8294	DOYAR0000007	M 0 OHM 1/4W	1	
	R8295	DOYAR0000007	M 0 OHM 1/4W	1	
	R8296	DOYAR0000007	M 0 OHM 1/4W	1	
	R8297	DOYAR0000007	M 0 OHM 1/4W	1	
	R8298	DOYAR0000007	M 0 OHM 1/4W	1	
	R8299	DOYAR0000007	M 0 OHM 1/4W	1	
	R8305	ERJ2GEJ223	M 22KOHM, J,0.063W	1	B/E
	R8306	ERJ2GEJ472	M 4.7KOHM, J,0.063W	1	B/E
	R8307	ERJ2GEJ472	M 4.7KOHM, J,0.063W	1	B/E
	R8308	ERJ2GEJ103	M 10KOHM, J,0.063W	1	B/E
	R8310	DOYAR0000007	M 0 OHM 1/4W	1	B/E
	R8311	DOYAR0000007	M 0 OHM 1/4W	1	B/E
	R8314	DOYAR0000007	M 0 OHM 1/4W	1	B/E
	R8315	DOYAR0000007	M 0 OHM 1/4W	1	B/E
	R8318	ERJ2GEJ472	M 4.7KOHM, J,0.063W	1	B/E
	R8321	ERJ2GEJ103	M 10KOHM, J,0.063W	1	B/E
	R8322	ERJ2GEJ102X	M 1K OHM J 1/4W	1	B/E
	R8323	ERJ2GEJ473	M 47KOHM, J,0.063W	1	B/E
	R8324	ERJ2GEJ473	M 47KOHM, J,0.063W	1	B/E
	R8325	ERJ2GEJ680	M 68 OHM, J,0.063W	1	B/E
	R8326	ERJ2GEJ680	M 68 OHM, J,0.063W	1	B/E
	R8327	ERJ2GEJ680	M 68 OHM, J,0.063W	1	B/E
	R8328	ERJ2GEJ103	M 10KOHM, J,0.063W	1	
	R8329	ERJ2GEJ473	M 47KOHM, J,0.063W	1	B/E
	R8330	ERJ2GEJ680	M 68 OHM, J,0.063W	1	B/E
	R8353	ERJ2GEJ101	M 100 OHM, J,0.063W	1	B/E
	R8354	ERJ2GEJ101	M 100 OHM, J,0.063W	1	B/E
	R8356	DOYAR0000007	M 0 OHM 1/4W	1	B/E
	R8359	DOYAR0000007	M 0 OHM 1/4W	1	B/E

Safety	Ref. No.	Part No.	Part Name & Description	Pcs	Remarks
	R8370	ERJ2GEJ103	M 10KOHM, J,0.063W	1	
	R8385	ERJ2GEJ103	M 10KOHM, J,0.063W	1	
	R8396	ERJ2GEJ560X	M 56 OHM, J,0.063W	1	B/E
	R8401	ERJ8GEY0R00	M 0 OHM, 1/8W	1	B/E
	R8402	DOGDR00Z0002	M 0 OHM, 1/10W	1	B/E
	R8403	ERJ2GEJ680	M 68 OHM, J,0.063W	1	B/E
	R8404	ERJ2GEJ103	M 10KOHM, J,0.063W	1	B/E
	R8405	ERJ2GEJ103	M 10KOHM, J,0.063W	1	B/E
	R8406	DOGFR10JA020	M 1 OHM,J,0.33W	1	PAVCCZ B/E
	R8407	ERJ2GEJ473	M 47KOHM, J,0.063W	1	B/E
	R8409	DOYAR0000007	M 0 OHM 1/4W	1	B/E
	R8410	ERJ2GEJ223	M 22KOHM, J,0.063W	1	B/E
	R8411	ERJ2GEJ223	M 22KOHM, J,0.063W	1	B/E
	R8412	EXB2HV473JV	RESISTOR ARRAY	1	B/E
	R8413	ERJ2GEJ680	M 68 OHM, J,0.063W	1	B/E
	R8414	EXB2HV101J	RESISTOR ARRAY	1	B/E
	R8415	ERJ8GEY0R00	M 0 OHM, 1/8W	1	B/E
	R8416	ERJ2GEJ223	M 22KOHM, J,0.063W	1	B/E
	R8417	ERJ2GEJ104	M 100KOHM, J,0.063W	1	B/E
	R8418	ERJ2GEJ681	M 680 OHM, J,0.063W	1	B/E
	R8419	EXB2HV101J	RESISTOR ARRAY	1	B/E
	R8420	ERJ8GEY0R00	M 0 OHM, 1/8W	1	B/E
	R8421	ERJ2GEJ680	M 68 OHM, J,0.063W	1	B/E
	R8422	ERJ2GEJ680	M 68 OHM, J,0.063W	1	B/E
	R8423	ERJ2GEJ680	M 68 OHM, J,0.063W	1	B/E
	R8424	ERJ2GEJ680	M 68 OHM, J,0.063W	1	B/E
	R8425	ERJ2GEJ680	M 68 OHM, J,0.063W	1	B/E
	R8426	ERJ2GEJ223	M 22KOHM, J,0.063W	1	B/E
	R8427	ERJ2GEJ680	M 68 OHM, J,0.063W	1	B/E
	R8428	ERJ2GEJ680	M 68 OHM, J,0.063W	1	B/E
	R8429	ERJ2GEJ680	M 68 OHM, J,0.063W	1	B/E
	R8430	EXB2HV680J	RESISTOR ARRAY	1	B/E
	R8431	ERJ2GEJ223	M 22KOHM, J,0.063W	1	B/E
	R8432	ERJ2GEJ101	M 100 OHM, J,0.063W	1	B/E
	R8433	ERJ2GEJ223	M 22KOHM, J,0.063W	1	B/E
	R8434	ERJ2GEJ473	M 47KOHM, J,0.063W	1	B/E
	R8435	ERJ2GEJ103	M 10KOHM, J,0.063W	1	B/E
	R8436	ERJ2GEJ103	M 10KOHM, J,0.063W	1	B/E
	R8437	ERJ2GEJ104	M 100KOHM, J,0.063W	1	B/E
	R8438	ERJ2GEJ104	M 100KOHM, J,0.063W	1	B/E
	R8439	ERJ2GEJ680	M 68 OHM, J,0.063W	1	B/E
	R8440	ERJ2GEJ104	M 100KOHM, J,0.063W	1	B/E
	R8441	ERJ2GEJ680	M 68 OHM, J,0.063W	1	B/E
	R8442	ERJ2GEJ680	M 68 OHM, J,0.063W	1	B/E

Safety	Ref. No.	Part No.	Part Name & Description	Pcs	Remarks
	R8443	ERJ2GEJ223	M 22KOHM, J, 0.063W	1	B/E
	R8444	ERJ2GEJ223	M 22KOHM, J, 0.063W	1	B/E
	R8445	ERJ2GEJ104	M 100KOHM, J, 0.063W	1	B/E
	R8446	ERJ2GEJ103	M 10KOHM, J, 0.063W	1	
	R8447	ERJ2GEJ103	M 10KOHM, J, 0.063W	1	
	R8448	ERJ2GEJ103	M 10KOHM, J, 0.063W	1	
	R8449	EXB2HV103JV	RESISTOR ARRAY	1	
	R8450	ERJ2GEJ103	M 10KOHM, J, 0.063W	1	B/E
	R8454	DOYAR0000007	M 0 OHM 1/4W	1	B/E
	R8455	DOYAR0000007	M 0 OHM 1/4W	1	B/E
	R8456	ERJ2GEJ680	M 68 OHM, J, 0.063W	1	B/E
	R8457	ERJ2GEJ680	M 68 OHM, J, 0.063W	1	B/E
	R8458	ERJ2GEJ680	M 68 OHM, J, 0.063W	1	B/E
	R8459	ERJ2GEJ680	M 68 OHM, J, 0.063W	1	B/E
	R8460	ERJ2GEJ680	M 68 OHM, J, 0.063W	1	B/E
	R8461	ERJ2GEJ680	M 68 OHM, J, 0.063W	1	B/E
	R8462	DOYAR0000007	M 0 OHM 1/4W	1	B/E
	R8463	ERJ2GEJ101	M 100 OHM, J, 0.063W	1	B/E
	R8464	ERJ2GEJ101	M 100 OHM, J, 0.063W	1	B/E
	R8465	DOYAR0000007	M 0 OHM 1/4W	1	B/E
	R8466	DOYAR0000007	M 0 OHM 1/4W	1	B/E
	R8467	ERJ2GEJ101	M 100 OHM, J, 0.063W	1	B/E
	R8468	EXB2HV101J	RESISTOR ARRAY	1	B/E
	R8469	DOYAR0000007	M 0 OHM 1/4W	1	B/E
	R8470	DOYAR0000007	M 0 OHM 1/4W	1	B/E
	R8471	ERJ2GEJ103	M 10KOHM, J, 0.063W	1	B/E
	R8472	ERJ2GEJ221	M 220 OHM, J, 0.063W	1	B/E
	R8473	ERJ2GEJ221	M 220 OHM, J, 0.063W	1	B/E
	R8474	ERJ2GEJ221	M 220 OHM, J, 0.063W	1	B/E
	R8475	ERJ2GEJ221	M 220 OHM, J, 0.063W	1	B/E
	R8476	ERJ2GEJ221	M 220 OHM, J, 0.063W	1	B/E
	R8477	ERJ2GEJ221	M 220 OHM, J, 0.063W	1	B/E
	R8478	ERJ2GEJ221	M 220 OHM, J, 0.063W	1	B/E
	R8479	ERJ2GEJ221	M 220 OHM, J, 0.063W	1	B/E
	R8480	ERJ2GEJ680	M 68 OHM, J, 0.063W	1	B/E
	R8481	ERJ2GEJ151	M 150 OHM, J, 0.063W	1	B/E
	R8482	ERJ2GEJ151	M 150 OHM, J, 0.063W	1	B/E
	R8483	ERJ2GEJ101	M 100 OHM, J, 0.063W	1	B/E
	R8484	ERJ2GEJ680	M 68 OHM, J, 0.063W	1	B/E
	R8486	ERJ2GEJ680	M 68 OHM, J, 0.063W	1	B/E
	R8487	ERJ2GEJ680	M 68 OHM, J, 0.063W	1	B/E
	R8488	ERJ2GEJ680	M 68 OHM, J, 0.063W	1	B/E
	R8489	ERJ2GEJ680	M 68 OHM, J, 0.063W	1	B/E
	R8490	ERJ2GEJ680	M 68 OHM, J, 0.063W	1	B/E

Safety	Ref. No.	Part No.	Part Name & Description	Pcs	Remarks
	R8492	ERJ2GEJ680	M 68 OHM, J, 0.063W	1	B/E
	R8493	ERJ2GEJ221	M 220 OHM, J, 0.063W	1	B/E
	R8494	ERJ2GEJ221	M 220 OHM, J, 0.063W	1	B/E
	R8495	ERJ2GEJ221	M 220 OHM, J, 0.063W	1	B/E
	R8496	ERJ2GEJ221	M 220 OHM, J, 0.063W	1	B/E
	R8497	ERJ2GEJ221	M 220 OHM, J, 0.063W	1	B/E
	R8498	ERJ2GEJ221	M 220 OHM, J, 0.063W	1	B/E
	R8499	ERJ2GEJ221	M 220 OHM, J, 0.063W	1	B/E
	R8525	ERJ2GEJ103	M 10KOHM, J, 0.063W	1	B/E
	R8526	ERJ2GEJ560X	M 56 OHM, J, 0.063W	1	
	R8527	ERJ2GEJ560X	M 56 OHM, J, 0.063W	1	
	R8528	ERJ2GEJ560X	M 56 OHM, J, 0.063W	1	
	R8529	ERJ2GEJ103	M 10KOHM, J, 0.063W	1	
	R8530	ERJ2GEJ103	M 10KOHM, J, 0.063W	1	
	R8531	ERJ2GEJ560X	M 56 OHM, J, 0.063W	1	
	R8532	ERJ2GEJ560X	M 56 OHM, J, 0.063W	1	
	R8533	ERJ2GEJ121	M 120 OHM, J, 0.063W	1	
	R8534	ERJ2GEJ121	M 120 OHM, J, 0.063W	1	
	R8535	ERJ2GEJ121	M 120 OHM, J, 0.063W	1	
	R8536	ERJ2GEJ121	M 120 OHM, J, 0.063W	1	
	R8537	D1HG1218A002	NETWORK RESISTER	1	
	R8538	D1HG1218A002	NETWORK RESISTER	1	
	R8539	D1HG1218A002	NETWORK RESISTER	1	
	R8540	D1HG1218A002	NETWORK RESISTER	1	
	R8541	ERJ2GEJ121	M 120 OHM, J, 0.063W	1	
	R8542	ERJ2GEJ121	M 120 OHM, J, 0.063W	1	
	R8543	ERJ2GEJ121	M 120 OHM, J, 0.063W	1	
	R8544	ERJ2GEJ121	M 120 OHM, J, 0.063W	1	
	R8545	ERJ2GEJ121	M 120 OHM, J, 0.063W	1	
	R8546	ERJ2GEJ121	M 120 OHM, J, 0.063W	1	
	R8547	ERJ2GEJ121	M 120 OHM, J, 0.063W	1	
	R8548	ERJ2GEJ121	M 120 OHM, J, 0.063W	1	
	R8549	ERJ2GEJ103	M 10KOHM, J, 0.063W	1	
	R8550	ERJ2GEJ121	M 120 OHM, J, 0.063W	1	
	R8551	ERJ2GEJ560X	M 56 OHM, J, 0.063W	1	
	R8552	ERJ2GEJ103	M 10KOHM, J, 0.063W	1	
	R8553	ERJ2GEJ121	M 120 OHM, J, 0.063W	1	
	R8554	ERJ2GEJ560X	M 56 OHM, J, 0.063W	1	
	R8555	ERJ2GEJ560X	M 56 OHM, J, 0.063W	1	
	R8556	ERJ2GEJ560X	M 56 OHM, J, 0.063W	1	
	R8557	ERJ2GEJ103	M 10KOHM, J, 0.063W	1	
	R8558	ERJ2GEJ103	M 10KOHM, J, 0.063W	1	

Safety	Ref. No.	Part No.	Part Name & Description	Pcs	Remarks
	R8559	ERJ2GEJ102X	M 1K OHM J 1/4W	1	
	R8560	ERJ2GEJ332	M 3.3KOHM, J,0.063W	1	
	R8561	ERJ2GEJ332	M 3.3KOHM, J,0.063W	1	
	R8562	ERJ2GEJ332	M 3.3KOHM, J,0.063W	1	
	R8563	ERJ2GEJ332	M 3.3KOHM, J,0.063W	1	
	R8564	ERJ2GEJ332	M 3.3KOHM, J,0.063W	1	
	R8565	ERJ2GEJ332	M 3.3KOHM, J,0.063W	1	
	R8566	ERJ2GEJ103	M 10KOHM, J,0.063W	1	
	R8567	ERJ2GEJ103	M 10KOHM, J,0.063W	1	
	R8569	ERJ2GEJ103	M 10KOHM, J,0.063W	1	
	R8581	ERJ2GEJ103	M 10KOHM, J,0.063W	1	
	R8583	D0YAR0000007	M 0 OHM 1/4W	1	
	R8601	D0YAR0000007	M 0 OHM 1/4W	1	
	R8602	D0YAR0000007	M 0 OHM 1/4W	1	
	R8603	ERJ2GEJ473	M 47KOHM, J,0.063W	1	
	R8604	ERJ2GEJ220	M 22 OHM, J,0.063W	1	
	R8620	ERJ2GEJ101	M 100 OHM, J,0.063W	1	
	R8621	ERJ2GEJ153	M 15KOHM, J,0.063W	1	
	R8622	ERJ2GEJ103	M 10KOHM, J,0.063W	1	
	R8623	ERJ2GEJ473	M 47KOHM, J,0.063W	1	
	R8625	D1BA1601A026	M 1.6KOHM, 1/10W	1	
	R8626	ERJ2GEJ101	M 100 OHM, J,0.063W	1	
	R8627	ERJ2GEJ103	M 10KOHM, J,0.063W	1	
	R8628	ERJ2GEJ103	M 10KOHM, J,0.063W	1	
	R8629	ERJ2GEJ472	M 4.7KOHM, J,0.063W	1	
	R8630	ERJ2GEJ153	M 15KOHM, J,0.063W	1	
	R8631	ERJ2GEJ103	M 10KOHM, J,0.063W	1	
	R8632	D0YAR0000007	M 0 OHM 1/4W	1	
	R8650	ERJ2GEJ103	M 10KOHM, J,0.063W	1	
	R8651	ERJ2GEJ103	M 10KOHM, J,0.063W	1	
	R8661	ERJ2GEJ103	M 10KOHM, J,0.063W	1	
	R8663	ERJ2GEJ103	M 10KOHM, J,0.063W	1	
	R8701	EXB2HV680J	RESISTOR ARRAY	1	
	R8702	EXB2HV680J	RESISTOR ARRAY	1	
	R8703	EXB2HV101J	RESISTOR ARRAY	1	
	R8704	EXB2HV101J	RESISTOR ARRAY	1	
	R8705	EXB2HV101J	RESISTOR ARRAY	1	
	R8706	ERJ2GEJ101	M 100 OHM, J,0.063W	1	
	R8707	ERJ2GEJ101	M 100 OHM, J,0.063W	1	
	R8709	ERJ2GEJ103	M 10KOHM, J,0.063W	1	
	R8710	ERJ2GEJ222	M 2.2KOHM, J,0.063W	1	
	R8711	ERJ2GEJ103	M 10KOHM, J,0.063W	1	
	R8715	ERJ2GEJ103	M 10KOHM, J,0.063W	1	
	R8716	ERJ2GEJ103	M 10KOHM, J,0.063W	1	
	R8718	ERJ2GEJ101	M 100 OHM, J,0.063W	1	

Safety	Ref. No.	Part No.	Part Name & Description	Pcs	Remarks
	R8719	ERJ2GEJ101	M 100 OHM, J,0.063W	1	
	R8720	ERJ2GEJ101	M 100 OHM, J,0.063W	1	
	R8721	ERJ2GEJ101	M 100 OHM, J,0.063W	1	
	R8722	ERJ2GEJ101	M 100 OHM, J,0.063W	1	
	R8723	ERJ2GEJ101	M 100 OHM, J,0.063W	1	
	R8724	ERJ2GEJ101	M 100 OHM, J,0.063W	1	
	R8725	ERJ2GEJ101	M 100 OHM, J,0.063W	1	
	R8726	ERJ2GEJ101	M 100 OHM, J,0.063W	1	
	R8727	ERJ2GEJ101	M 100 OHM, J,0.063W	1	
	R8728	ERJ2GEJ101	M 100 OHM, J,0.063W	1	
	R8730	ERJ2GEJ222	M 2.2KOHM, J,0.063W	1	B/E
	R8732	ERJ2GEJ101	M 100 OHM, J,0.063W	1	
	R8733	ERJ2GEJ101	M 100 OHM, J,0.063W	1	
	R8734	ERJ2GEJ680	M 68 OHM, J,0.063W	1	
	R8735	ERJ2GEJ472	M 4.7KOHM, J,0.063W	1	
	R8736	ERJ2GEJ472	M 4.7KOHM, J,0.063W	1	
	R8737	ERJ2GEJ472	M 4.7KOHM, J,0.063W	1	
	R8738	ERJ2GEJ472	M 4.7KOHM, J,0.063W	1	
	R8739	ERJ2GEJ680	M 68 OHM, J,0.063W	1	
	R8740	ERJ2GEJ680	M 68 OHM, J,0.063W	1	
	R8741	ERJ2GEJ680	M 68 OHM, J,0.063W	1	
	R8742	ERJ2GEJ680	M 68 OHM, J,0.063W	1	
	R8743	EXB38V560JV	RESISTOR ARRAY	1	
	R8744	ERJ2GEJ680	M 68 OHM, J,0.063W	1	
	R8745	ERJ2GEJ560X	M 56 OHM, J,0.063W	1	
	R8746	ERJ2GEJ560X	M 56 OHM, J,0.063W	1	
	R8747	ERJ2GEJ560X	M 56 OHM, J,0.063W	1	
	R8748	ERJ2GEJ560X	M 56 OHM, J,0.063W	1	
	R8749	ERJ2GEJ560X	M 56 OHM, J,0.063W	1	
	R8750	ERJ2GEJ560X	M 56 OHM, J,0.063W	1	
	R8751	ERJ2GEJ560X	M 56 OHM, J,0.063W	1	
	R8752	ERJ2GEJ560X	M 56 OHM, J,0.063W	1	
	R8753	ERJ2GEJ560X	M 56 OHM, J,0.063W	1	
	R8754	ERJ2GEJ103	M 10KOHM, J,0.063W	1	
	R8757	ERJ2GEJ103	M 10KOHM, J,0.063W	1	
	R8758	ERJ2GEJ103	M 10KOHM, J,0.063W	1	
	R8759	ERJ2GEJ103	M 10KOHM, J,0.063W	1	
	R8760	ERJ2GEJ103	M 10KOHM, J,0.063W	1	
	R8761	ERJ2GEJ103	M 10KOHM, J,0.063W	1	
	R8762	ERJ2GEJ103	M 10KOHM, J,0.063W	1	
	R8764	ERJ2GEJ103	M 10KOHM, J,0.063W	1	

Safety	Ref. No.	Part No.	Part Name & Description	Pcs	Remarks
	R8765	ERJ2GEJ103	M 10KOHM, J, 0.063W	1	
	R8766	ERJ2GEJ680	M 68 OHM, J, 0.063W	1	
	R8767	ERJ2GEJ680	M 68 OHM, J, 0.063W	1	
	R8768	ERJ2GEJ680	M 68 OHM, J, 0.063W	1	
	R8769	ERJ2GEJ680	M 68 OHM, J, 0.063W	1	
	R8770	ERJ2GEJ680	M 68 OHM, J, 0.063W	1	
	R8771	ERJ2GEJ680	M 68 OHM, J, 0.063W	1	
	R8772	ERJ2GEJ680	M 68 OHM, J, 0.063W	1	
	R8773	ERJ2GEJ680	M 68 OHM, J, 0.063W	1	
	R8774	ERJ2GEJ680	M 68 OHM, J, 0.063W	1	
	R8775	ERJ2GEJ103	M 10KOHM, J, 0.063W	1	
	R8776	ERJ2GEJ103	M 10KOHM, J, 0.063W	1	
	R8777	ERJ2GEJ103	M 10KOHM, J, 0.063W	1	
	R8778	ERJ2GEJ103	M 10KOHM, J, 0.063W	1	
	R8779	ERJ2GEJ103	M 10KOHM, J, 0.063W	1	B/E
	R8781	ERJ2GEJ103	M 10KOHM, J, 0.063W	1	
	R8782	ERJ2GEJ103	M 10KOHM, J, 0.063W	1	
	R8783	ERJ2GEJ103	M 10KOHM, J, 0.063W	1	
	R8785	ERJ2GEJ560X	M 56 OHM, J, 0.063W	1	
	R8786	ERJ2GEJ560X	M 56 OHM, J, 0.063W	1	
	R8787	ERJ2GEJ560X	M 56 OHM, J, 0.063W	1	
	R8788	ERJ2GEJ560X	M 56 OHM, J, 0.063W	1	
	R8789	ERJ2GEJ103	M 10KOHM, J, 0.063W	1	
	R8790	ERJ2GEJ103	M 10KOHM, J, 0.063W	1	
	R8791	ERJ2GEJ103	M 10KOHM, J, 0.063W	1	
	R8792	ERJ2GEJ103	M 10KOHM, J, 0.063W	1	
	R8795	ERJ2GEJ103	M 10KOHM, J, 0.063W	1	
	R8796	ERJ2GEJ560X	M 56 OHM, J, 0.063W	1	
	R8798	ERJ2GEJ101	M 100 OHM, J, 0.063W	1	
	R8799	ERJ2GEJ103	M 10KOHM, J, 0.063W	1	
	R8806	ERJ2GEJ103	M 10KOHM, J, 0.063W	1	
	R8807	ERJ2GEJ103	M 10KOHM, J, 0.063W	1	
	R8809	ERJ2GEJ103	M 10KOHM, J, 0.063W	1	
	R8811	DOYAR0000007	M 0 OHM 1/4W	1	
	R8812	DOYAR0000007	M 0 OHM 1/4W	1	
	R8813	DOYAR0000007	M 0 OHM 1/4W	1	
	R8816	ERJ2GEJ223	M 22KOHM, J, 0.063W	1	
	R8817	ERJ2GEJ562	M 5.6KOHM, J, 0.063W	1	
	R8818	ERJ2GEJ104	M 100KOHM, J, 0.063W	1	
	R8821	ERJ8GEYJ472V	M 4.7KOHM, J, 1/8W	1	
	R8823	ERJ2GEJ103	M 10KOHM, J, 0.063W	1	

Safety	Ref. No.	Part No.	Part Name & Description	Pcs	Remarks
	R8824	ERJ2GEJ473	M 47KOHM, J, 0.063W	1	
	R8825	DOYAR0000007	M 0 OHM 1/4W	1	
	R8826	ERJ2GEJ101	M 100 OHM, J, 0.063W	1	
	R8829	ERJ2GEJ103	M 10KOHM, J, 0.063W	1	
	R8830	ERJ2GEJ103	M 10KOHM, J, 0.063W	1	
	R8831	ERJ2GEJ101	M 100 OHM, J, 0.063W	1	
	R8832	ERJ2GEJ101	M 100 OHM, J, 0.063W	1	
	R8833	DOYAR0000007	M 0 OHM 1/4W	1	
	R8834	DOYAR0000007	M 0 OHM 1/4W	1	
	R8835	DOYAR0000007	M 0 OHM 1/4W	1	
	R8837	ERJ2GEJ103	M 10KOHM, J, 0.063W	1	
	R8838	ERJ2GEJ103	M 10KOHM, J, 0.063W	1	
	R8839	ERJ2GEJ103	M 10KOHM, J, 0.063W	1	
	R8850	ERJ2GEJ101	M 100 OHM, J, 0.063W	1	
	R8851	EXB38V103JV	RESISTOR ARRAY	1	
	R8852	ERJ2GEJ103	M 10KOHM, J, 0.063W	1	
	R8853	ERJ2GEJ103	M 10KOHM, J, 0.063W	1	
	R8855	EXB38VR000V	RESISTOR ARRAY	1	
	R8856	ERJ2GEJ103	M 10KOHM, J, 0.063W	1	
	R8857	ERJ2GEJ103	M 10KOHM, J, 0.063W	1	
	R8859	ERJ2GEJ103	M 10KOHM, J, 0.063W	1	
	R8860	ERJ2GEJ103	M 10KOHM, J, 0.063W	1	
	R8861	ERJ2GEJ104	M 100KOHM, J, 0.063W	1	
	R8864	ERJ2GEJ103	M 10KOHM, J, 0.063W	1	
	R8865	EXB2HV103JV	RESISTOR ARRAY	1	
	R8866	ERJ3GEYJ471	M 470 OHM, J, 1/16W	1	
	R8869	DOGBR00Z0002	M 0 OHM J 1/16W	1	
	R8901	EXB2HV103JV	RESISTOR ARRAY	1	
	R8902	EXB2HV103JV	RESISTOR ARRAY	1	
	R8903	EXB2HV103JV	RESISTOR ARRAY	1	
	R8904	ERJ2GEJ103	M 10KOHM, J, 0.063W	1	
	R8905	ERJ2GEJ103	M 10KOHM, J, 0.063W	1	
	R8906	ERJ2GEJ103	M 10KOHM, J, 0.063W	1	
	R8907	ERJ2GEJ103	M 10KOHM, J, 0.063W	1	
	R8910	EXB2HV103JV	RESISTOR ARRAY	1	
	R8911	EXB2HV103JV	RESISTOR ARRAY	1	
	R8912	EXB2HV103JV	RESISTOR ARRAY	1	
	R8913	ERJ2RHD272	M 27KOHM, J, 2W	1	
	R8914	ERJ2GEJ103	M 10KOHM, J, 0.063W	1	
	R8915	ERJ2GEJ103	M 10KOHM, J, 0.063W	1	
	R8916	ERJ2GEJ103	M 10KOHM, J, 0.063W	1	
	R8917	ERJ2GEJ103	M 10KOHM, J, 0.063W	1	
	R8918	ERJ2GEJ103	M 10KOHM, J, 0.063W	1	
	R8920	ERJ2GEJ103	M 10KOHM, J, 0.063W	1	
	R8921	ERJ2GEJ103	M 10KOHM, J, 0.063W	1	
	R8922	ERJ2GEJ103	M 10KOHM, J, 0.063W	1	
	R8923	ERJ2GEJ103	M 10KOHM, J, 0.063W	1	

Safety	Ref. No.	Part No.	Part Name & Description	Pcs	Remarks
	R8924	ERJ2GEJ103	M 10KOHM, J, 0.063W	1	
	R8925	DOYAR0000007	M 0 OHM 1/4W	1	E/E
	R8926	DOYAR0000007	M 0 OHM 1/4W	1	
	R8927	DOYAR0000007	M 0 OHM 1/4W	1	
	R8928	DOYAR0000007	M 0 OHM 1/4W	1	
	R8929	DOYAR0000007	M 0 OHM 1/4W	1	
	R8930	ERJ2GEJ560X	M 56 OHM, J, 0.063W	1	
	R8931	ERJ2GEJ560X	M 56 OHM, J, 0.063W	1	
	R8932	ERJ2GEJ560X	M 56 OHM, J, 0.063W	1	
	R8933	EXB2HV560JV	RESISTOR ARRAY	1	
	R8934	EXB2HV560JV	RESISTOR ARRAY	1	
	R8940	D1BB91R0A055	M 91 OHM, 1/10W	1	
	R8941	D1BB91R0A055	M 91 OHM, 1/10W	1	
	R8942	D1BB91R0A055	M 91 OHM, 1/10W	1	
	R8950	ERJ2GEJ103	M 10KOHM, J, 0.063W	1	
	R8951	D1BB4702A055	M 47KOHM, 1/10W	1	E/E
	R8952	ERJ2GEJ102X	M 1K OHM J 1/4W	1	E/E
	R8954	ERJ2RKD330	M 33 OHM, J, 2W	1	
	R8955	ERJ2RKD330	M 33 OHM, J, 2W	1	
	R8956	ERJ2GEJ104	M 100KOHM, J, 0.063W	1	
	R8957	ERJ2GEJ104	M 100KOHM, J, 0.063W	1	
	R8959	ERJ2GEJ103	M 10KOHM, J, 0.063W	1	
	R8960	ERJ2GEJ104	M 100KOHM, J, 0.063W	1	
	R8961	EXB2HV330JV	RESISTOR ARRAY	1	
	R8962	EXB2HV330JV	RESISTOR ARRAY	1	
	R8963	ERJ3GEYJ471	M 470 OHM, J, 1/16W	1	
	R8964	ERJ2GEJ560X	M 56 OHM, J, 0.063W	1	
	R8965	ERJ2GEJ103	M 10KOHM, J, 0.063W	1	
	R8966	ERJ2GEJ103	M 10KOHM, J, 0.063W	1	
	R8967	D1BB1203A055	M 120KOHM, 1/10W	1	E/E
	R8968	D1BB2202A055	M 22KOHM, 1/10W	1	PAVCCZ E/E
	R8970	ERJ2GEJ560X	M 56 OHM, J, 0.063W	1	
	R8972	ERJ2GEJ560X	M 56 OHM, J, 0.063W	1	
	R8973	ERJ2GEJ560X	M 56 OHM, J, 0.063W	1	
	R8974	ERJ2GEJ560X	M 56 OHM, J, 0.063W	1	
	R8995	ERJ2GEJ560X	M 56 OHM, J, 0.063W	1	B
	R9001	DOGBR00Z0002	M 0 OHM J 1/16W	1	
	R9002	DOGBR00Z0002	M 0 OHM J 1/16W	1	
	R9007	DOGBR00Z0002	M 0 OHM J 1/16W	1	
	R9013	ERJ6GEYJ472V	M 4.7K OHM J 1/10W	1	
	R9014	ERJ6GEYJ472V	M 4.7K OHM J 1/10W	1	
	R9015	DOGDR00Z0002	M 0 OHM, 1/10W	1	
	R9016	DOGDR00Z0002	M 0 OHM, 1/10W	1	
	R9023	DOGBR00Z0002	M 0 OHM J 1/16W	1	
	R9027	DOGBR00Z0002	M 0 OHM J 1/16W	1	
	R9028	DOGBR00Z0002	M 0 OHM J 1/16W	1	
	R9029	DOGBR00Z0002	M 0 OHM J 1/16W	1	
	R9101	ERJ2GEJ102X	M 1K OHM J 1/4W	1	
	R9103	ERJ2GEJ103	M 10KOHM, J, 0.063W	1	
	R9105	ERJ2GEJ103	M 10KOHM, J, 0.063W	1	
	R9107	ERJ2GEJ332	M 3.3KOHM, J, 0.063W	1	
	R9110	ERJ2GEJ102X	M 1K OHM J 1/4W	1	
	R9112	ERJ2GEJ470	M 47 OHM, J, 0.063W	1	

Safety	Ref. No.	Part No.	Part Name & Description	Pcs	Remarks
	R9113	ERJ2GEJ470	M 47 OHM, J, 0.063W	1	
	R9114	ERJ2GEJ470	M 47 OHM, J, 0.063W	1	
	R9115	ERJ2GEJ101	M 100 OHM, J, 0.063W	1	
	R9116	ERJ2GEJ101	M 100 OHM, J, 0.063W	1	
	R9117	ERJ2GEJ472	M 4.7KOHM, J, 0.063W	1	
	R9118	DOGDR00Z0002	M 0 OHM, 1/10W	1	(D)
	R9118	ERJ3GEYJ471	M 470 OHM, J, 1/16W	1	(HC)
	R9119	EXB38V470J	RESISTOR ARRAY	1	
	R9120	EXB2HV103JV	RESISTOR ARRAY	1	
	R9121	ERJ2GEJ104	M 100KOHM, J, 0.063W	1	(D)
	R9121	ERJ8GEYJ3R3V	M 3.3 OHM, J, 1/8W	1	(HC)
	R9122	ERJ2GEJ332	M 3.3KOHM, J, 0.063W	1	(D)
	R9122	ERJ8GEYJ3R3V	M 3.3 OHM, J, 1/8W	1	(HC)
	R9123	ERJ8GEYJ3R3V	M 3.3 OHM, J, 1/8W	1	(HC)
	R9123	EXB2HV470JV	RESISTOR ARRAY	1	(D)
	R9124	DOGDR00Z0002	M 0 OHM, 1/10W	1	(D)
	R9124	ERJ8GEYJ3R3V	M 3.3 OHM, J, 1/8W	1	(HC)
	R9125	ERJ2GEJ472	M 4.7KOHM, J, 0.063W	1	(D)
	R9125	ERJ8GEYJ3R3V	M 3.3 OHM, J, 1/8W	1	(HC)
	R9126	ERJ2GEJ101	M 100 OHM, J, 0.063W	1	(D)
	R9126	ERJ8GEYJ3R3V	M 3.3 OHM, J, 1/8W	1	(HC)
	R9127	DOYAR0000007	M 0 OHM 1/4W	1	(D)
	R9127	ERJ8GEYJ3R3V	M 3.3 OHM, J, 1/8W	1	(HC)
	R9128	ERJ8GEYJ3R3V	M 3.3 OHM, J, 1/8W	1	
	R9129	DOGB100JA041	M 10 OHM J 1/16W	1	(HC)
	R9129	ERJ2GEJ683	M 68KOHM, J, 0.063W	1	(D)
	R9130	DOGB100JA041	M 10 OHM J 1/16W	1	(HC)
	R9130	ERJ2GEJ104	M 100KOHM, J, 0.063W	1	(D)
	R9131	ERJ2GEJ472	M 4.7KOHM, J, 0.063W	1	
	R9132	ERJ2GEJ472	M 4.7KOHM, J, 0.063W	1	
	R9133	DOGB100JA041	M 10 OHM J 1/16W	1	(HC)
	R9133	ERJ2GEJ680	M 68 OHM, J, 0.063W	1	(D)
	R9134	DOYAR0000007	M 0 OHM 1/4W	1	
	R9135	ERJ2GEJ472	M 4.7KOHM, J, 0.063W	1	
	R9136	ERJ2GEJ103	M 10KOHM, J, 0.063W	1	
	R9137	DOGB100JA041	M 10 OHM J 1/16W	1	(HC)
	R9137	EXB2HV220JV	RESISTOR ARRAY	1	(D)
	R9138	DOGB100JA041	M 10 OHM J 1/16W	1	(HC)
	R9138	EXB2HV220JV	RESISTOR ARRAY	1	(D)
	R9139	EXB2HV220JV	RESISTOR ARRAY	1	
	R9140	EXB2HV220JV	RESISTOR ARRAY	1	
	R9141	ERJ2GEJ101	M 100 OHM, J, 0.063W	1	
	R9142	ERJ2GEJ220	M 22 OHM, J, 0.063W	1	
	R9143	ERJ2GEJ220	M 22 OHM, J, 0.063W	1	
	R9145	ERJ2GEJ472	M 4.7KOHM, J, 0.063W	1	
	R9146	EXB2HV220JV	RESISTOR ARRAY	1	
	R9147	EXB2HV220JV	RESISTOR ARRAY	1	
	R9148	EXB38VR000V	RESISTOR ARRAY	1	
	R9149	ERJ2GEJ472	M 4.7KOHM, J, 0.063W	1	

Safety	Ref. No.	Part No.	Part Name & Description	Pcs	Remarks
	R9150	ERJ2GEJ103	M 10KOHM, J, 0.063W	1	
	R9151	ERJ2GEJ103	M 10KOHM, J, 0.063W	1	
	R9154	ERJ2GEJ470	M 47 OHM, J, 0.063W	1	
	R9155	ERJ2GEJ103	M 10KOHM, J, 0.063W	1	
	R9157	ERJ2GEJ472	M 4.7KOHM, J, 0.063W	1	
	R9158	ERJ2GEJ470	M 47 OHM, J, 0.063W	1	
	R9159	ERJ2GEJ393	M 39KOHM, J, 0.063W	1	
	R9160	ERJ2GEJ393	M 39KOHM, J, 0.063W	1	
	R9161	D0GB100JA041	M 10 OHM J 1/16W	1	(HC)
	R9161	ERJ2GEJ393	M 39KOHM, J, 0.063W	1	(D)
	R9162	ERJ2GEJ104	M 100KOHM, J, 0.063W	1	
	R9163	ERJ2GEJ103	M 10KOHM, J, 0.063W	1	
	R9164	ERJ2GEJ220	M 22 OHM, J, 0.063W	1	
	R9166	ERJ2GEJ220	M 22 OHM, J, 0.063W	1	
	R9167	ERJ2GEJ472	M 4.7KOHM, J, 0.063W	1	
	R9168	D0GDR00Z0002	M 0 OHM, 1/10W	1	
	R9170	ERJ2GEJ472	M 4.7KOHM, J, 0.063W	1	
	R9171	ERJ2GEJ103	M 10KOHM, J, 0.063W	1	
	R9172	DOYAR0000007	M 0 OHM 1/4W	1	
	R9174	ERJ2GEJ102X	M 1K OHM J 1/4W	1	
	R9175	ERJ2GEJ101	M 100 OHM, J, 0.063W	1	
	R9177	ERJ2GEJ220	M 22 OHM, J, 0.063W	1	
	R9178	ERJ2GEJ220	M 22 OHM, J, 0.063W	1	
	R9179	ERJ2GEJ220	M 22 OHM, J, 0.063W	1	
	R9180	ERJ2GEJ220	M 22 OHM, J, 0.063W	1	
	R9181	ERJ2GEJ220	M 22 OHM, J, 0.063W	1	
	R9182	ERJ2GEJ220	M 22 OHM, J, 0.063W	1	
	R9185	ERJ2GEJ223	M 22KOHM, J, 0.063W	1	
	R9186	ERJ2GEJ333	M 33KOHM, J, 0.063W	1	
	R9187	ERJ2GED563X	M 56KOHM, J, 0.063W	1	
	R9188	ERJ2GEJ243	M 24KOHM, J, 0.063W	1	
	R9189	ERJ2GEJ104	M 100KOHM, J, 0.063W	1	
	R9190	ERJ2GEJ472	M 4.7KOHM, J, 0.063W	1	
	R9191	ERJ2GEJ104	M 100KOHM, J, 0.063W	1	
	R9192	ERJ2GEJ103	M 10KOHM, J, 0.063W	1	
	R9193	EXB2HV220JV	RESISTOR ARRAY	1	
	R9194	DOYAR0000007	M 0 OHM 1/4W	1	
	R9195	EXB2HV220JV	RESISTOR ARRAY	1	
	R9196	DOYAR0000007	M 0 OHM 1/4W	1	
	R9197	ERJ2GEJ470	M 47 OHM, J, 0.063W	1	
	R9198	DOYAR0000007	M 0 OHM 1/4W	1	
	R9199	ERJ2GEJ470	M 47 OHM, J, 0.063W	1	
	R9200	ERJ2GEJ100	M 10 OHM, J, 0.063W	1	
	R9201	ERJ2GEJ100	M 10 OHM, J, 0.063W	1	

Safety	Ref. No.	Part No.	Part Name & Description	Pcs	Remarks
	R9202	ERJ2GEJ470	M 47 OHM, J, 0.063W	1	
	R9204	ERJ2GEJ223	M 22KOHM, J, 0.063W	1	
	R9205	ERJ2GEJ331	M 330 OHM, J, 0.063W	1	
	R9206	ERJ2GEJ102X	M 1K OHM J 1/4W	1	
	R9207	ERJ2GEJ470	M 47 OHM, J, 0.063W	1	
	R9208	EXB2HV220JV	RESISTOR ARRAY	1	
	R9209	EXB2HV220JV	RESISTOR ARRAY	1	
	R9210	EXB2HV220JV	RESISTOR ARRAY	1	
	R9211	EXB2HV220JV	RESISTOR ARRAY	1	
	R9212	EXB2HV470JV	RESISTOR ARRAY	1	
	R9213	ERJ2GEJ101	M 100 OHM, J, 0.063W	1	
	R9214	ERJ2GEJ104	M 100KOHM, J, 0.063W	1	
	R9215	ERJ2GEJ470	M 47 OHM, J, 0.063W	1	
	R9216	ERJ2GEJ220	M 22 OHM, J, 0.063W	1	
	R9217	ERJ2GEJ680	M 68 OHM, J, 0.063W	1	
	R9218	ERJ2GEJ470	M 47 OHM, J, 0.063W	1	
	R9219	ERJ2GEJ103	M 10KOHM, J, 0.063W	1	
	R9223	ERJ2RHD272	M 27KOHM, J, 2W	1	
	R9224	ERJ2GEJ220	M 22 OHM, J, 0.063W	1	
	R9225	ERJ2RHD272	M 27KOHM, J, 2W	1	
	R9226	ERJ2GEJ101	M 100 OHM, J, 0.063W	1	
	R9229	ERJ2GEJ101	M 100 OHM, J, 0.063W	1	
	R9230	EXB38V470J	RESISTOR ARRAY	1	
	R9231	DOYAR0000007	M 0 OHM 1/4W	1	
	R9232	ERJ2GEJ470	M 47 OHM, J, 0.063W	1	
	R9233	ERJ2GEJ472	M 4.7KOHM, J, 0.063W	1	
	R9234	EXB2HV470JV	RESISTOR ARRAY	1	
	R9235	EXB2HV470JV	RESISTOR ARRAY	1	
	R9236	ERJ2RKD330	M 33 OHM, J, 2W	1	
	R9237	EXB38V470J	RESISTOR ARRAY	1	
	R9238	ERJ2GEJ151	M 150 OHM, J, 0.063W	1	
	R9245	ERJ2GEJ102X	M 1K OHM J 1/4W	1	
	R9246	ERJ2GEJ103	M 10KOHM, J, 0.063W	1	
	R9247	ERJ2GEJ470	M 47 OHM, J, 0.063W	1	
	R9248	D1BB1001A055	M 1KOHM, 1/16W	1	
	R9249	D1BB1001A055	M 1KOHM, 1/16W	1	
	R9250	D1BB1001A055	M 1KOHM, 1/16W	1	
	R9251	D1BB1001A055	M 1KOHM, 1/16W	1	
	R9252	ERJ2RKD330	M 33 OHM, J, 2W	1	
	R9253	EXB2HV103JV	RESISTOR ARRAY	1	
	R9254	EXB2HV103JV	RESISTOR ARRAY	1	
	R9255	EXB2HV103JV	RESISTOR ARRAY	1	
	R9256	EXB38V470J	RESISTOR ARRAY	1	
	R9257	EXB38V470J	RESISTOR ARRAY	1	
	R9258	EXB38V470J	RESISTOR ARRAY	1	
	R9259	EXB38V470J	RESISTOR ARRAY	1	
	R9260	EXB38V470J	RESISTOR ARRAY	1	
	R9261	EXB38V470J	RESISTOR ARRAY	1	
	R9262	EXB38V470J	RESISTOR ARRAY	1	
	R9263	EXB38V470J	RESISTOR ARRAY	1	
	R9264	ERJ2GEJ470	M 47 OHM, J, 0.063W	1	
	R9265	ERJ2GEJ470	M 47 OHM, J, 0.063W	1	
	R9266	ERJ2GEJ470	M 47 OHM, J, 0.063W	1	
	R9267	ERJ2GEJ470	M 47 OHM, J, 0.063W	1	

Safety	Ref. No.	Part No.	Part Name & Description	Pcs	Remarks
	R9270	ERJ2GEJ470	M 47 OHM, J,0.063W	1	
	R9271	ERJ2GEJ470	M 47 OHM, J,0.063W	1	
	R9272	ERJ2GEJ101	M 100 OHM, J,0.063W	1	
	R9273	ERJ2GEJ470	M 47 OHM, J,0.063W	1	
	R9279	DOYAR0000007	M 0 OHM 1/4W	1	
	R9280	EXB2HV103JV	RESISTOR ARRAY	1	
	R9281	EXB2HV103JV	RESISTOR ARRAY	1	
	R9282	EXB2HV103JV	RESISTOR ARRAY	1	
	R9283	ERJ2GEJ103	M 10KOHM, J,0.063W	1	
	R9286	DOYAR0000007	M 0 OHM 1/4W	1	
	R9287	DOYAR0000007	M 0 OHM 1/4W	1	
	R9288	DOYAR0000007	M 0 OHM 1/4W	1	
	R9292	EXB2HVR000	RESISTOR ARRAY	1	
	R9293	EXB2HV470JV	RESISTOR ARRAY	1	
	R9295	ERJ2GEJ101	M 100 OHM, J,0.063W	1	
	R9296	ERJ2GEJ101	M 100 OHM, J,0.063W	1	
	R9297	ERJ2GEJ101	M 100 OHM, J,0.063W	1	
	R9298	ERJ2GEJ101	M 100 OHM, J,0.063W	1	
	R9299	ERJ2GEJ101	M 100 OHM, J,0.063W	1	
	R9300	ERJ2GEJ101	M 100 OHM, J,0.063W	1	
	R9301	ERJ2GEJ101	M 100 OHM, J,0.063W	1	
	R9302	ERJ2GEJ101	M 100 OHM, J,0.063W	1	
	R9303	ERJ2GEJ101	M 100 OHM, J,0.063W	1	
	R9304	ERJ2GEJ101	M 100 OHM, J,0.063W	1	
	R9308	ERJ2GEJ102X	M 1K OHM J 1/4W	1	
	R9309	ERJ2GEJ103	M 10KOHM, J,0.063W	1	
	R9310	EXB38V103JV	RESISTOR ARRAY	1	
	R9311	ERJ2GEJ102X	M 1K OHM J 1/4W	1	
	R9312	ERJ2GEJ332	M 3.3KOHM, J,0.063W	1	
	R9315	ERJ2GEJ103	M 10KOHM, J,0.063W	1	
	R9317	ERJ2GEJ220	M 22 OHM, J,0.063W	1	
	R9319	ERJ2GEJ220	M 22 OHM, J,0.063W	1	
	R9321	ERJ2GEJ220	M 22 OHM, J,0.063W	1	
	R9323	ERJ2GEJ220	M 22 OHM, J,0.063W	1	
	R9325	ERJ2GEJ103	M 10KOHM, J,0.063W	1	
	R9326	ERJ2GEJ470	M 47 OHM, J,0.063W	1	
	R9327	ERJ2GEJ103	M 10KOHM, J,0.063W	1	
	R9333	EXB38V103JV	RESISTOR ARRAY	1	
	R9334	ERJ2GEJ103	M 10KOHM, J,0.063W	1	
	R9335	EXB2HV103JV	RESISTOR ARRAY	1	
	R9337	ERJ2GEJ103	M 10KOHM, J,0.063W	1	
	R9341	ERJ2GEJ101	M 100 OHM, J,0.063W	1	
	R9342	ERJ2GEJ102X	M 1K OHM J 1/4W	1	
	R9343	ERJ2GEJ102X	M 1K OHM J 1/4W	1	
	R9344	ERJ2GEJ470	M 47 OHM, J,0.063W	1	
	R9345	ERJ2GEJ680	M 68 OHM, J,0.063W	1	
	R9348	ERJ2GEJ103	M 10KOHM, J,0.063W	1	

Safety	Ref. No.	Part No.	Part Name & Description	Pcs	Remarks
	R9350	ERJ2GEJ101	M 100 OHM, J,0.063W	1	
	R9351	ERJ2GEJ101	M 100 OHM, J,0.063W	1	
	R9352	EXB2HV470JV	RESISTOR ARRAY	1	
	R9353	EXB38V470J	RESISTOR ARRAY	1	
	R9354	EXB2HV103JV	RESISTOR ARRAY	1	
	R9355	ERJ2GEJ103	M 10KOHM, J,0.063W	1	
	R9358	ERJ2GEJ103	M 10KOHM, J,0.063W	1	
	R9362	ERJ2GEJ103	M 10KOHM, J,0.063W	1	
	R9385	ERJ2GEJ472	M 4.7KOHM, J,0.063W	1	
	R9419	ERJ3GEYJ220	M 22 OHM, J,1/16W	1	
	R9420	ERJ3GEYJ220	M 22 OHM, J,1/16W	1	
	R9421	D0GB103JA041	M 10K OHM J 1/16W	1	
	R9578	ERJ2GEJ472	M 4.7KOHM, J,0.063W	1	
	R9599	ERJ2GEJ680	M 68 OHM, J,0.063W	1	
	R9600	ERJ2GEJ680	M 68 OHM, J,0.063W	1	
	R9611	ERJ2GEJ680	M 68 OHM, J,0.063W	1	
	R9824	ERJ2GEJ101	M 100 OHM, J,0.063W	1	
	R9825	ERJ2GEJ101	M 100 OHM, J,0.063W	1	
	R9826	ERJ2GEJ101	M 100 OHM, J,0.063W	1	
	R9839	EXB38V101JV	RESISTOR ARRAY	1	
	R9840	ERJ2GEJ220	M 22 OHM, J,0.063W	1	
	R9846	EXB2HV103JV	RESISTOR ARRAY	1	
	R9847	EXB2HV103JV	RESISTOR ARRAY	1	
	R9848	EXB2HV470JV	RESISTOR ARRAY	1	
	R9849	EXB2HV470JV	RESISTOR ARRAY	1	
	R9854	ERJ2GEJ101	M 100 OHM, J,0.063W	1	
	R9859	EXB38V101JV	RESISTOR ARRAY	1	
	R9868	ERJ2GEJ104	M 100KOHM, J,0.063W	1	
	R9869	ERJ2GEJ103	M 10KOHM, J,0.063W	1	
	R9870	ERJ2GEJ103	M 10KOHM, J,0.063W	1	
	R9871	ERJ2GEJ103	M 10KOHM, J,0.063W	1	
	R9878	D1BB1502A055	M 15KOHM, 1/10W	1	
	R9879	D1BB1302A055	M 13KOHM, 1/10W	1	
	R9886	D1BB4702A055	M 47KOHM, 1/10W	1	
	R9887	D1BB5102A055	M 51KOHM, 1/10W	1	
	R9888	D1BB1502A055	M 15KOHM, 1/10W	1	
	R9889	D1BB1822A055	M18.2KOHM, 1/10W	1	
	R9890	D1BB4752A055	M47.5KOHM, 1/10W	1	
	R9891	D1BB1272A055	M12.7KOHM, 1/10W	1	
	R9892	ERJ2GEJ104	M 100KOHM, J,0.063W	1	
	R9893	D1BB4302A055	M 43KOHM, 1/10W	1	
	R9894	D1BB2002A055	M 20KOHM, 1/10W	1	
	R9895	ERJ2GEJ104	M 100KOHM, J,0.063W	1	
	R9896	D1BB1822A055	M18.2KOHM, 1/10W	1	
	R9897	D1BB4752A055	M47.5KOHM, 1/10W	1	
	R9901	DOYAR0000007	M 0 OHM 1/4W	1	
	R9905	ERJ2RKD330	M 33 OHM, J, 2W	1	
	R9907	ERJ2GEJ151	M 150 OHM, J,0.063W	1	
	R9936	D1BB1001A055	M 1KOHM, 1/16W	1	
	R9937	D1BB1001A055	M 1KOHM, 1/16W	1	
	R9938	D1BB1001A055	M 1KOHM, 1/16W	1	
	R9939	D1BB1001A055	M 1KOHM, 1/16W	1	
	R9940	ERJ2RKD330	M 33 OHM, J, 2W	1	
	R9944	EXB38V470J	RESISTOR ARRAY	1	

Safety	Ref. No.	Part No.	Part Name & Description	Pcs	Remarks
	R9945	EXB38V470J	RESISTOR ARRAY	1	
	R9946	EXB38V470J	RESISTOR ARRAY	1	
	R9947	EXB38V470J	RESISTOR ARRAY	1	
	R9948	EXB38V470J	RESISTOR ARRAY	1	
	R9949	EXB38V470J	RESISTOR ARRAY	1	
	R9950	EXB38V470J	RESISTOR ARRAY	1	
	R9951	EXB38V470J	RESISTOR ARRAY	1	
	R9952	ERJ2GEJ470	M 47 OHM, J,0.063W	1	
	R9953	ERJ2GEJ470	M 47 OHM, J,0.063W	1	
	R9954	ERJ2GEJ470	M 47 OHM, J,0.063W	1	
	R9955	ERJ2GEJ470	M 47 OHM, J,0.063W	1	
	R9966	ERJ2GEJ471	M 470 OHM, J,0.063W	1	
	R9969	ERJ2GEJ470	M 47 OHM, J,0.063W	1	
	R9972	ERJ2GEJ103	M 10KOHM, J,0.063W	1	
	R9973	ERJ2GEJ103	M 10KOHM, J,0.063W	1	
	R9974	ERJ2GEJ103	M 10KOHM, J,0.063W	1	
	R9975	ERJ2GEJ470	M 47 OHM, J,0.063W	1	
	R9980	DOYAR0000007	M 0 OHM 1/4W	1	
	R14349	DOGD103JA036	M 10KOHM,J,0.25W	1	
	R14350	DOGD101JA036	M 100 OHM, J,0.25W	1	
	R14351	DOGD103JA036	M 10KOHM,J,0.25W	1	
	R14353	DOGDR00Z0002	M 0 OHM, 1/10W	1	
	R14354	ERJ6GEYJ221V	M 220 OHM,J,1/ 10W	1	
	R14356	DOGDR00Z0002	M 0 OHM, 1/10W	1	
	R14357	ERJ6GEYJ221V	M 220 OHM,J,1/ 10W	1	
	R14359	DOGDR00Z0002	M 0 OHM, 1/10W	1	
	R14360	ERJ6GEYJ221V	M 220 OHM,J,1/ 10W	1	
	R14362	DOGDR00Z0002	M 0 OHM, 1/10W	1	
	R14363	ERJ6GEYJ221V	M 220 OHM,J,1/ 10W	1	
	R14365	DOGDR00Z0002	M 0 OHM, 1/10W	1	
	R14366	ERJ6GEYJ221V	M 220 OHM,J,1/ 10W	1	
	R14368	DOGDR00Z0002	M 0 OHM, 1/10W	1	
	R14369	ERJ6GEYJ221V	M 220 OHM,J,1/ 10W	1	
	R14371	DOGDR00Z0002	M 0 OHM, 1/10W	1	
	R14372	ERJ6GEYJ221V	M 220 OHM,J,1/ 10W	1	
	R14374	DOGDR00Z0002	M 0 OHM, 1/10W	1	
	R14375	DOGDR00Z0002	M 0 OHM, 1/10W	1	
	R14376	DOGDR00Z0002	M 0 OHM, 1/10W	1	
	R14378	DOGDR00Z0002	M 0 OHM, 1/10W	1	
	R14380	DOGDR00Z0002	M 0 OHM, 1/10W	1	
	R14381	DOGDR00Z0002	M 0 OHM, 1/10W	1	
	R14382	DOGDR00Z0002	M 0 OHM, 1/10W	1	
	R14384	DOGDR00Z0002	M 0 OHM, 1/10W	1	
	R14386	DOGDR00Z0002	M 0 OHM, 1/10W	1	
	R14387	DOGDR00Z0002	M 0 OHM, 1/10W	1	
	R14388	DOGDR00Z0002	M 0 OHM, 1/10W	1	
	R14390	DOGDR00Z0002	M 0 OHM, 1/10W	1	
	R14392	DOGDR00Z0002	M 0 OHM, 1/10W	1	
	R14393	DOGDR00Z0002	M 0 OHM, 1/10W	1	
	R14394	DOGDR00Z0002	M 0 OHM, 1/10W	1	
	R14398	DOGDR00Z0002	M 0 OHM, 1/10W	1	
	R14901	DOGD101JA036	M 100 OHM, J,0.25W	1	
	R14902	ERJ6GEYJ221V	M 220 OHM,J,1/ 10W	1	
	R14903	ERJ6GEYJ221V	M 220 OHM,J,1/ 10W	1	
	R14904	ERJ6GEYJ221V	M 220 OHM,J,1/ 10W	1	

Safety	Ref. No.	Part No.	Part Name & Description	Pcs	Remarks
	R14905	ERJ6GEYJ221V	M 220 OHM,J,1/ 10W	1	
	R14906	ERJ6GEYJ221V	M 220 OHM,J,1/ 10W	1	
	R14907	ERJ3GEYJ220	M 22 OHM,J,1/16W	1	
	R14908	ERJ3GEYJ220	M 22 OHM,J,1/16W	1	
	R14909	ERJ3GEYJ220	M 22 OHM,J,1/16W	1	
	R14910	ERJ3GEYJ220	M 22 OHM,J,1/16W	1	
	R14911	DOGD103JA036	M 10KOHM,J,0.25W	1	
	R14912	DOGD103JA036	M 10KOHM,J,0.25W	1	
	R14913	DOGD103JA036	M 10KOHM,J,0.25W	1	
	R14914	DOGD103JA036	M 10KOHM,J,0.25W	1	
	R14915	ERJ3GEYJ220	M 22 OHM,J,1/16W	1	
	R14916	DOGD103JA036	M 10KOHM,J,0.25W	1	
	R14917	ERJ3GEYJ220	M 22 OHM,J,1/16W	1	
	R14919	ERJ3GEYJ220	M 22 OHM,J,1/16W	1	
	R14920	ERJ3GEYJ220	M 22 OHM,J,1/16W	1	
	R14921	ERJ8GEYJ224V	M 220KOHM, J,1/ 8W	1	
	R14923	DOGD103JA036	M 10KOHM,J,0.25W	1	
	R14924	DOGD103JA036	M 10KOHM,J,0.25W	1	
	R14925	DOGD103JA036	M 10KOHM,J,0.25W	1	
	R14926	DOGD103JA036	M 10KOHM,J,0.25W	1	
	R14928	ERJ6GEYJ221V	M 220 OHM,J,1/ 10W	1	
	R14929	ERJ6GEYJ221V	M 220 OHM,J,1/ 10W	1	
	R14930	DOGDR00Z0002	M 0 OHM, 1/10W	1	
	R14931	ERJ6GEYJ220	M 22 OHM,J,1/10W	1	
	R14932	DOGDR00Z0002	M 0 OHM, 1/10W	1	
	R14934	ERJ3GEYJ470	M 47 OHM,J,1/16W	1	
	R14935	ERJ6GEYJ222V	M 2.2K OHM J 1/ 10W	1	
	R14936	ERJ6GEYJ472V	M 4.7K OHM J 1/ 10W	1	
	R14937	ERJ6GEYJ102V	M 1K OHM J 1/10W	1	
	R14939	DOGDR00Z0002	M 0 OHM, 1/10W	1	
	R14940	DOGDR00Z0002	M 0 OHM, 1/10W	1	
	R14942	DOGDR00Z0002	M 0 OHM, 1/10W	1	
	R14943	ERJ6GEYJ470V	M 47 OHM,J,1/10W	1	
	R14944	ERJ6GEYJ100V	M 10 OHM,J,1/10W	1	
	R14949	ERJ6GEYJ203	M 20KOHM,J,1/10W	1	
	R14950	DOGD103JA036	M 10KOHM,J,0.25W	1	
	R14951	DOGDR00Z0002	M 0 OHM, 1/10W	1	
	R14952	DOGDR00Z0002	M 0 OHM, 1/10W	1	
	R14953	DOGDR00Z0002	M 0 OHM, 1/10W	1	
	R14954	DOGDR00Z0002	M 0 OHM, 1/10W	1	
	R14955	DOGDR00Z0002	M 0 OHM, 1/10W	1	
	R14956	ERJ3GEYJ220	M 22 OHM,J,1/16W	1	
	R14957	ERJ3GEYJ220	M 22 OHM,J,1/16W	1	
	R14958	ERJ3GEYJ220	M 22 OHM,J,1/16W	1	
	R14959	ERJ3GEYJ220	M 22 OHM,J,1/16W	1	
	R14960	ERJ3GEYJ220	M 22 OHM,J,1/16W	1	
	R14961	ERJ6GEYJ331V	M 330 OHM J 1/ 10W	1	
	R14962	ERJ6GEYJ331V	M 330 OHM J 1/ 10W	1	
	R14963	ERJ6GEYJ331V	M 330 OHM J 1/ 10W	1	
	R14964	ERJ3GEYJ220	M 22 OHM,J,1/16W	1	
	R14965	ERJ6GEYJ331V	M 330 OHM J 1/ 10W	1	
	R14966	ERJ3GEYJ220	M 22 OHM,J,1/16W	1	
	R14967	ERJ3GEYJ220	M 22 OHM,J,1/16W	1	
	R14971	ERJ6GEYJ220	M 22 OHM,J,1/10W	1	
	R14973	ERJ3GEYJ470	M 47 OHM,J,1/16W	1	
	R14974	ERJ3GEYJ470	M 47 OHM,J,1/16W	1	
	R14975	ERJ3GEYJ470	M 47 OHM,J,1/16W	1	
	R14976	ERJ3GEYJ470	M 47 OHM,J,1/16W	1	
	R14977	ERJ6GEYJ222V	M 2.2K OHM J 1/ 10W	1	
	R14978	ERJ6GEYJ222V	M 2.2K OHM J 1/ 10W	1	
	R14979	ERJ6GEYJ222V	M 2.2K OHM J 1/ 10W	1	
	R14980	DOGDR00Z0002	M 0 OHM, 1/10W	1	

Safety	Ref. No.	Part No.	Part Name & Description	Pcs	Remarks
	R14981	D0GD103JA036	M 10KOHM,J,0.25W	1	
	R14982	D0GD103JA036	M 10KOHM,J,0.25W	1	
	R14984	D0GD103JA036	M 10KOHM,J,0.25W	1	
	R14986	ERJ8GEYJ224V	M 220KOHM, J,1/8W	1	
	R14987	ERJ3GEYJ470	M 47 OHM,J,1/16W	1	
	R14988	ERJ6GEYJ222V	M 2.2K OHM J 1/10W	1	
	R14990	D0GD103JA036	M 10KOHM,J,0.25W	1	
	R14991	ERJ3GEYJ220	M 22 OHM,J,1/16W	1	
	R14992	ERJ3GEYJ470	M 47 OHM,J,1/16W	1	
	R14993	ERJ3GEYJ470	M 47 OHM,J,1/16W	1	
	R14994	ERJ3GEYJ470	M 47 OHM,J,1/16W	1	
	R14995	D0GD103JA036	M 10KOHM,J,0.25W	1	
	R14996	D0GD103JA036	M 10KOHM,J,0.25W	1	
	R14997	D0GD103JA036	M 10KOHM,J,0.25W	1	
	R14998	D0GD103JA036	M 10KOHM,J,0.25W	1	
	R14999	ERJ6GEYJ331V	M 330 OHM J 1/10W	1	
	R16002	ERJT08J7R5V	M 7.5OHM,J,0.33W	1	
	R16003	ERJT08J7R5V	M 7.5OHM,J,0.33W	1	
	R16004	ERJT08J7R5V	M 7.5OHM,J,0.33W	1	
	R16021	ERJT08J7R5V	M 7.5OHM,J,0.33W	1	
	R16022	ERJT08J7R5V	M 7.5OHM,J,0.33W	1	
	R16023	ERJT08J7R5V	M 7.5OHM,J,0.33W	1	
	R16024	ERJT08J7R5V	M 7.5OHM,J,0.33W	1	
	R16031	ERJ6ENF8202	M 82KOHM, 1/10W	1	
	R16032	ERJ6ENF8202	M 82KOHM, 1/10W	1	
	R16033	ERJ6ENF5602	M 56KOHM, 1/10W	1	
	R16034	ERJ6ENF2702	M 27KOHM, 1/10W	1	
	R16042	ERJT08J5R6V	M 5.6 OHM,F,0.33W	1	
	R16051	ERJT08J5R6V	M 5.6 OHM,F,0.33W	1	
	R16102	ERJT06J221V	M 220 OHM,F,0.25W	1	
	R16104	ERJT06J221V	M 220 OHM,F,0.25W	1	
	R16109	ERJT06J100V	M 10 OHM,F,0.25W	1	
	R16110	ERJ6GEYF473	M 47KOHM,J,1/10W	1	
	R16116	ERJ6GEYF473	M 47KOHM,J,1/10W	1	
	R16131	D0GD101JA036	M 100 OHM,J,0.25W	1	
	R16132	D0GD101JA036	M 100 OHM,J,0.25W	1	
	R16134	ERJT06J750V	M 75 OHM,F,0.25W	1	
	R16137	ERJT08J1ROV	M 1.8OHM,J,0.33W	1	
	R16138	ERJT08J1ROV	M 1.8OHM,J,0.33W	1	
	R16139	ERJT08J1ROV	M 1.8OHM,J,0.33W	1	
	R16141	ERJT06J100V	M 10 OHM,F,0.25W	1	
	R16142	ERJ6GEYF473	M 47KOHM,J,1/10W	1	
	R16143	ERJ6GEYF473	M 47KOHM,J,1/10W	1	
	R16151	D0GD101JA036	M 100 OHM,J,0.25W	1	
	R16152	D0GD101JA036	M 100 OHM,J,0.25W	1	
	R16154	ERJT06J750V	M 75 OHM,F,0.25W	1	
	R16155	ERJT08J1ROV	M 1.8OHM,J,0.33W	1	
	R16159	ERJT08J1ROV	M 1.8OHM,J,0.33W	1	
	R16161	ERJT06J100V	M 10 OHM,F,0.25W	1	
	R16162	ERJ6GEYF473	M 47KOHM,J,1/10W	1	
	R16163	ERJ6GEYF473	M 47KOHM,J,1/10W	1	
	R16171	ERJT06J100V	M 10 OHM,F,0.25W	1	
	R16172	ERJ6GEYF473	M 47KOHM,J,1/10W	1	
	R16173	ERJ6GEYF473	M 47KOHM,J,1/10W	1	

Safety	Ref. No.	Part No.	Part Name & Description	Pcs	Remarks
	R16181	ERJT06J100V	M 10 OHM,F,0.25W	1	
	R16182	ERJ6GEYF473	M 47KOHM,J,1/10W	1	
	R16183	ERJ6GEYF473	M 47KOHM,J,1/10W	1	
	R16191	D0GD101JA036	M 100 OHM,J,0.25W	1	
	R16192	D0GD101JA036	M 100 OHM,J,0.25W	1	
	R16193	ERJT06J750V	M 75 OHM,F,0.25W	1	
	R16194	ERJT14J1ROU	M 1.0 OHM, J,1/4W	1	
	R16195	ERJT08J1ROV	M 1.8OHM,J,0.33W	1	
	R16220	ERJ6GEYJ470V	M 47 OHM,J,1/10W	1	
	R16221	ERJ6GEYJ472V	M 4.7K OHM J 1/10W	1	
	R16230	ERJ6GEYJ470V	M 47 OHM,J,1/10W	1	
	R16231	ERJ6GEYJ472V	M 4.7K OHM J 1/10W	1	
	R16241	EXB38V470J	RESISTOR ARRAY	1	
	R16242	EXB38V472JV	RESISTOR ARRAY	1	
	R16251	ERJ6ENF1401	M 1.4KOHM, 1/10W	1	
	R16252	ERJ6ENF3902	M 39KOHM, 1/10W	1	
	R16253	ERJ6ENF3902	M 39KOHM, 1/10W	1	
	R16254	ERJ6ENF6801	M 6.8KOHM, 1/10W	1	
	R16255	ERJ6ENF1201	M 1.2KOHM, 1/10W	1	
	R16256	ERJ6ENF1501	M 1.5KOHM, 1/10W	1	
	R16257	D0GD103JA036	M 10KOHM,J,0.25W	1	
	R16258	ERJ6GEYJ222V	M 2.2K OHM J 1/10W	1	
	R16260	ERJ6GEYJ222V	M 2.2K OHM J 1/10W	1	
	R16261	ERJ6GEYJ104V	M 100KOHM,J,1/10W	1	
	R16280	ERJ6GEYJ222V	M 2.2K OHM J 1/10W	1	
	R16281	D0GD103JA036	M 10KOHM,J,0.25W	1	
	R16282	ERJ6GEYJ221V	M 220 OHM,J,1/10W	1	
	R16283	ERJ6GEYF473	M 47KOHM,J,1/10W	1	
	R16284	ERJ6GEYJ224	M 220KOHM,J,1/10W	1	
	R16289	ERJ6GEYJ623V	M 62KOHM,J,1/10W	1	
	R16290	ERJT08J334V	M 330KOHM,F,0.33W	1	
	R16291	ERJ6GEYJ623V	M 62KOHM,J,1/10W	1	
	R16292	ERJT08J334V	M 330KOHM,F,0.33W	1	
	R16293	ERJ6GEYJ623V	M 62KOHM,J,1/10W	1	
	R16294	ERJT08J334V	M 330KOHM,F,0.33W	1	
	R16295	ERJ6GEYJ623V	M 62KOHM,J,1/10W	1	
	R16296	ERJT08J334V	M 330KOHM,F,0.33W	1	
	R16300	ERJT08J102V	M 1KOHM,J, 0.33W	1	
	R16301	ERJ6GEYJ472V	M 4.7K OHM J 1/10W	1	
	R16302	ERJ8GEYJ105V	M 1MOHM, J,1/8W	1	
	R16303	D0GD101JA036	M 100 OHM,J,0.25W	1	
	R16304	ERJT08J681V	M 680 OHM,F,0.33W	1	
	R16305	ERJ6GEYJ271V	M 270 OHM J 1/10W	1	
	R16306	D0GD101JA036	M 100 OHM,J,0.25W	1	
	R16307	D0GD101JA036	M 100 OHM,J,0.25W	1	
	R16308	D0GD101JA036	M 100 OHM,J,0.25W	1	
	R16309	ERJ6GEYJ472V	M 4.7K OHM J 1/10W	1	
	R16310	ERJ6GEYJ562V	M 5.6KOHM,J,1/10W	1	
	R16311	ERJ6GEYJ124V	M 120KOHM,J,1/10W	1	
	R16312	ERJ6GEYJ124V	M 120KOHM,J,1/10W	1	
	R16313	ERJ6ENF6492	M64.9KOHM, 1/10W	1	
	R16314	ERJ6ENF6652	M66.5KOHM, 1/10W	1	

Safety	Ref. No.	Part No.	Part Name & Description	Pcs	Remarks
	R16315	ERJ6ENF1241	M1.24KOHM, 1/10W	1	
	R16317	DOGDR00Z0002	M 0 OHM, 1/10W	1	
	R16321	ERJ6GEYF473	M 47KOHM, J, 1/10W	1	
	R16322	ERJ6GEYF561	M 560 OHM, F, 1/10W	1	
	R16323	ERJ6GEYJ223	M 22KOHM, J, 1/10W	1	
	R16324	DOGD103JA036	M 10KOHM, J, 0.25W	1	
	R16325	DOGDR00Z0002	M 0 OHM, 1/10W	1	
	R16331	ERJT06J101V	M 100 OHM, F, 0.25W	1	
	R16333	ERJ6ENF3303	M 330KOHM, 1/10W	1	
	R16334	ERJT06J101V	M 100 OHM, F, 0.25W	1	
	R16336	ERJT08J1R0V	M 1.8OHM, J, 0.33W	1	
	R16338	ERJT06J101V	M 100 OHM, F, 0.25W	1	
	R16339	ERJ6ENF3303	M 330KOHM, 1/10W	1	
	R16340	ERJT06J152V	M 1.5KOHM, F, 0.25W	1	
	R16401	ERJT08J7R5V	M 7.5OHM, J, 0.33W	1	
	R16403	ERJT08J7R5V	M 7.5OHM, J, 0.33W	1	
	R16404	ERJT08J7R5V	M 7.5OHM, J, 0.33W	1	
	R16421	ERJT08J7R5V	M 7.5OHM, J, 0.33W	1	
	R16423	ERJT08J7R5V	M 7.5OHM, J, 0.33W	1	
	R16424	ERJT08J7R5V	M 7.5OHM, J, 0.33W	1	
	R16442	ERJT08J5R6V	M 5.6 OHM, F, 0.33W	1	
	R16452	ERJT08J5R6V	M 5.6 OHM, F, 0.33W	1	
	R16465	ERJ6ENF2702	M 27KOHM, 1/10W	1	
	R16466	ERJ6ENF5602	M 56KOHM, 1/10W	1	
	R16467	ERJ6ENF8202	M 82KOHM, 1/10W	1	
	R16468	ERJ6ENF8202	M 82KOHM, 1/10W	1	
	R16471	ERJ6GEYG392	M 3.9KOHM, J, 1/10W	1	
	R16472	ERJ6GEYJ222V	M 2.2K OHM J 1/10W	1	
	R16473	ERJ6GEYF561	M 560 OHM, F, 1/10W	1	
	R16474	ERJ6GEYJ102V	M 1K OHM J 1/10W	1	
	R16475	ERJ6GEYJ472V	M 4.7K OHM J 1/10W	1	
	R16476	ERJ6GEYJ472V	M 4.7K OHM J 1/10W	1	
	R16477	DOGBR00Z0002	M 0 OHM J 1/16W	1	
	R16478	ERJ6GEYJ562V	M 5.6KOHM, J, 1/10W	1	
	R16479	DOGD103JA036	M 10KOHM, J, 0.25W	1	
	R16480	ERJ6GEYJ472V	M 4.7K OHM J 1/10W	1	
	R16501	DOGD101JA036	M 100 OHM, J, 0.25W	1	
	R16502	DOGD101JA036	M 100 OHM, J, 0.25W	1	
	R16503	ERJT06J100V	M 10 OHM, F, 0.25W	1	
	R16504	ERJT06J750V	M 75 OHM, F, 0.25W	1	
	R16506	ERJT06J100V	M 10 OHM, F, 0.25W	1	
	R16507	ERJT08J1R0V	M 1.8OHM, J, 0.33W	1	
	R16508	ERJT08J1R0V	M 1.8OHM, J, 0.33W	1	
	R16509	ERJT08J1R0V	M 1.8OHM, J, 0.33W	1	
	R16510	ERJT14J1R0U	C1.0 OHM, J, 1/4W	1	
	R16511	ERJ6GEYF473	M 47KOHM, J, 1/10W	1	
	R16512	ERJ6GEYF473	M 47KOHM, J, 1/10W	1	
	R16516	ERJ6GEYF473	M 47KOHM, J, 1/10W	1	
	R16517	ERJ6GEYF473	M 47KOHM, J, 1/10W	1	
	R16521	DOGD101JA036	M 100 OHM, J, 0.25W	1	

Safety	Ref. No.	Part No.	Part Name & Description	Pcs	Remarks
	R16522	DOGD101JA036	M 100 OHM, J, 0.25W	1	
	R16523	ERJT06J750V	M 75 OHM, F, 0.25W	1	
	R16531	ERJT06J100V	M 10 OHM, F, 0.25W	1	
	R16532	ERJ6GEYF473	M 47KOHM, J, 1/10W	1	
	R16533	ERJ6GEYF473	M 47KOHM, J, 1/10W	1	
	R16541	DOGDR00Z0002	M 0 OHM, 1/10W	1	
	R16543	DOGDR00Z0002	M 0 OHM, 1/10W	1	
	R16551	ERJT06J100V	M 10 OHM, F, 0.25W	1	
	R16552	ERJ6GEYF473	M 47KOHM, J, 1/10W	1	
	R16553	ERJ6GEYF473	M 47KOHM, J, 1/10W	1	
	R16561	EXB38V470J	RESISTOR ARRAY	1	
	R16562	EXB38V470J	RESISTOR ARRAY	1	
	R16563	EXB38V470J	RESISTOR ARRAY	1	
	R16564	EXB38V470J	RESISTOR ARRAY	1	
	R16565	EXB38V472JV	RESISTOR ARRAY	1	
	R16566	EXB38V472JV	RESISTOR ARRAY	1	
	R16567	EXB38V472JV	RESISTOR ARRAY	1	
	R16568	EXB38V472JV	RESISTOR ARRAY	1	
	R16570	EXB38V472JV	RESISTOR ARRAY	1	
	R16573	ERJ6GEYJ220	M 22 OHM, J, 1/10W	1	
	R16579	EXB38V470J	RESISTOR ARRAY	1	
	R16580	ERJ6GEYJ222V	M 2.2K OHM J 1/10W	1	
	R16582	ERJ6ENF3902	M 39KOHM, 1/10W	1	
	R16583	ERJ6ENF3902	M 39KOHM, 1/10W	1	
	R16584	ERJ6ENF6801	M 6.8KOHM, 1/10W	1	
	R16585	ERJ6ENF1201	M 1.2KOHM, 1/10W	1	
	R16586	ERJ6ENF1501	M 1.5KOHM, 1/10W	1	
	R16587	ERJ6GEYJ222V	M 2.2K OHM J 1/10W	1	
	R16588	DOGD103JA036	M 10KOHM, J, 0.25W	1	
	R16590	ERJ6GEYJ221V	M 220 OHM, J, 1/10W	1	
	R16591	EXB38V472JV	RESISTOR ARRAY	1	
	R16592	ERJ6GEYJ472V	M 4.7K OHM J 1/10W	1	
	R16593	ERJ6ENF1401	M 1.4KOHM, 1/10W	1	
	R16600	DOGD103JA036	M 10KOHM, J, 0.25W	1	
	R16601	ERJ6GEYJ472V	M 4.7K OHM J 1/10W	1	
	R16602	ERJ6GEYJ102V	M 1K OHM J 1/10W	1	
	R16603	ERJ6GEYJ331V	M 330 OHM J 1/10W	1	
	R16604	ERJ6GEYJ331V	M 330 OHM J 1/10W	1	
	R16605	ERJ6GEYG182	M 1.8KOHM, J, 1/10W	1	
	R16606	DOGD103JA036	M 10KOHM, J, 0.25W	1	
	R16607	ERJ6ENF7151	M7.15KOHM, 1/10W	1	
	R16608	ERJT08J102V	M 1KOHM, J, 0.33W	1	
	R16609	ERJT08J102V	M 1KOHM, J, 0.33W	1	
	R16610	ERJ6GEYJ104V	M 100KOHM, J, 1/10W	1	
	R16611	ERG2FJS104D	M 100KOHM, J, 2W	1	
	R16612	ERJT06J470V	M 47 OHM, F, 0.25W	1	
	R16613	ERJ8GEYJ473	M 47KOHM, J, 1/8W	1	
	R16615	ERJ6ENF1101	M 1.1KOHM, 1/10W	1	
	R16616	DOGDR00Z0002	M 0 OHM, 1/10W	1	
	R16617	ERJ6GEYJ222V	M 2.2K OHM J 1/10W	1	
	R16619	ERJ6GEYJ224	M 220KOHM, J, 1/10W	1	
	R16622	ERJ6GEYJ221V	M 220 OHM, J, 1/10W	1	
	R16623	ERJ6GEYJ221V	M 220 OHM, J, 1/10W	1	
	R16624	ERJ6GEYJ221V	M 220 OHM, J, 1/10W	1	
	R16625	ERJ6GEYJ221V	M 220 OHM, J, 1/10W	1	
	R16627	ERJ6GEYJ221V	M 220 OHM, J, 1/10W	1	
	R16628	ERJ6GEYJ221V	M 220 OHM, J, 1/10W	1	
	R16629	ERJ6GEYJ221V	M 220 OHM, J, 1/10W	1	

Safety	Ref. No.	Part No.	Part Name & Description	Pcs	Remarks
	R16630	ERJ6GEYJ221V	M 220 OHM, J, 1/10W	1	
	R16632	D0GD103JA036	M 10KOHM, J, 0.25W	1	
	R16633	ERJ6GEYJ223	M 22KOHM, J, 1/10W	1	
	R16634	ERJ6GEYJ471	M 470 OHM, J, 1/10W	1	
	R16635	D0GD103JA036	M 10KOHM, J, 0.25W	1	
	R16636	ERJ6GEYJ472V	M 4.7K OHM J 1/10W	1	
	R16638	ERJT08J1R0V	M 1.8OHM, J, 0.33W	1	
	R16639	ERJT14J1R0U	C1.0 OHM, J, 1/4W	1	
	R16641	ERJT06J330V	M 33 OHM, F, 0.25W	1	
	R16642	ERJT06J330V	M 33 OHM, F, 0.25W	1	
	R16643	ERJT06J330V	M 33 OHM, F, 0.25W	1	
	R16644	ERJT06J330V	M 33 OHM, F, 0.25W	1	
	R16647	ERJT06J330V	M 33 OHM, F, 0.25W	1	
	R16648	ERJT06J330V	M 33 OHM, F, 0.25W	1	
	R16649	ERJT06J330V	M 33 OHM, F, 0.25W	1	
	R16650	ERJT06J330V	M 33 OHM, F, 0.25W	1	
	R16657	ERJ6GEYJ682	M 6.8KOHM, J, 1/10W	1	
	R16658	D0D1101JA009	M 100 OHM, J, 1W	1	
	R16659	ERJ6GEYJ224	M 22KOHM, J, 1/10W	1	
	R16660	ERJ6GEYJ224	M 22KOHM, J, 1/10W	1	
	R16661	ERJ6GEYJ182	M 1.8KOHM, J, 1/10W	1	
	R16662	ERJ6ENF2201	M 2.2KOHM, 1/10W	1	
	R16663	ERJ6GEYJ562V	M 5.6KOHM, J, 1/10W	1	
	R16664	ERJT08J102V	M 1KOHM, J, 0.33W	1	
	R16665	ERJT06J330V	M 33 OHM, F, 0.25W	1	
	R16666	D0GD103JA036	M 10KOHM, J, 0.25W	1	
	R16667	ERJ6GEYJ471	M 470 OHM, J, 1/10W	1	
	R16668	ERJ6GEYF473	M 47KOHM, J, 1/10W	1	
	R16669	ERJ6GEYJ472V	M 4.7K OHM J 1/10W	1	
	R16670	ERJT06J470V	M 47 OHM, F, 0.25W	1	
	R16671	ERJ6GEYF473	M 47KOHM, J, 1/10W	1	
	R16672	ERJ6GEYJ102V	M 1K OHM J 1/10W	1	
	R16673	D0GBR00Z0002	M 0 OHM J 1/16W	1	
	R16675	ERJT08J102V	M 1KOHM, J, 0.33W	1	
	R16681	ERJT06J100V	M 10 OHM, F, 0.25W	1	
	R16682	ERJT06J100V	M 10 OHM, F, 0.25W	1	
	R16683	ERJT06J100V	M 10 OHM, F, 0.25W	1	
	R16684	ERJT06J100V	M 10 OHM, F, 0.25W	1	
	R16686	ERJT06J100V	M 10 OHM, F, 0.25W	1	
	R16687	ERJT06J100V	M 10 OHM, F, 0.25W	1	
	R16688	ERJT06J100V	M 10 OHM, F, 0.25W	1	
	R16689	ERJT06J100V	M 10 OHM, F, 0.25W	1	
	R16696	ERF5TK2R2	W 2.2 OHM, K, 5W	1	
	R16700	ERJ6GEYJ472V	M 4.7K OHM J 1/10W	1	
	R16701	D0GD103JA036	M 10KOHM, J, 0.25W	1	
	R16702	ERJ6GEYJ332V	M 3.3K OHM J 1/10W	1	
	R16703	D0GD103JA036	M 10KOHM, J, 0.25W	1	
	R16704	D0GD103JA036	M 10KOHM, J, 0.25W	1	
	R16705	D0GD101JA036	M 100 OHM, J, 0.25W	1	
	R16706	D0GD101JA036	M 100 OHM, J, 0.25W	1	
	R16707	ERJ6GEYJ471	M 470 OHM, J, 1/10W	1	
	R16717	ERJ6GEYJ222V	M 2.2K OHM J 1/10W	1	
	R16719	ERJ3GEYJ220	M 22 OHM, J, 1/16W	1	
	R16720	ERJ3GEYJ220	M 22 OHM, J, 1/16W	1	
	R16721	ERJ3GEYJ220	M 22 OHM, J, 1/16W	1	
	R16722	ERJ3GEYJ220	M 22 OHM, J, 1/16W	1	
	R16723	ERJ3GEYJ220	M 22 OHM, J, 1/16W	1	
	R16729	ERJ6GEYF473	M 47KOHM, J, 1/10W	1	
	R16730	ERJ6GEYF473	M 47KOHM, J, 1/10W	1	

Safety	Ref. No.	Part No.	Part Name & Description	Pcs	Remarks
	R16731	ERGLFJS823D	M 82KOHM, J, 1W	1	
	R16732	ERJ6GEYJ392	M 3.9KOHM, J, 1/10W	1	
	R16733	ERJ6GEYJ474	M 470KOHM, J, 1/10W	1	
	R16734	ERJ6ENF4991	M4.99KOHM, 1/10W	1	
	R16735	ERJ6ENF2213	M 221KOHM, 1/10W	1	
	R16736	ERJ6ENF2213	M 221KOHM, 1/10W	1	
	R16737	ERJ6ENF2213	M 221KOHM, 1/10W	1	
	R16738	ERGLFJS823D	M 82KOHM, J, 1W	1	
	R16740	ERJ6GEYJ104V	M 100KOHM, J, 1/10W	1	
	R16742	D0GD103JA036	M 10KOHM, J, 0.25W	1	
	R16744	ERJ6ENF2003	M 200KOHM, 1/10W	1	
	R16745	ERJ6ENF4701	M 4.7KOHM, 1/10W	1	
	R16746	ERJT06J103V	M 10KOHM, F, 0.25W	1	
	R16747	ERJT06J103V	M 10KOHM, F, 0.25W	1	
	R16749	D0GD103JA036	M 10KOHM, J, 0.25W	1	
	R16750	ERJT06J223V	M 22 KOHM, F, 0.25W	1	
	R16751	ERJT06J224V	M 220KOHM, F, 0.25W	1	
	R16752	ERJ6GEYJ472V	M 4.7K OHM J 1/10W	1	
	R16753	ERJ6GEYF473	M 47KOHM, J, 1/10W	1	
	R16756	ERJT06J223V	M 22 KOHM, F, 0.25W	1	
	R16757	D0GDR00Z0002	M 0 OHM, 1/10W	1	
	R16761	ERJT06J100V	M 10 OHM, F, 0.25W	1	
	R16762	ERJ6GEYF473	M 47KOHM, J, 1/10W	1	
	R16763	ERJT06J100V	M 10 OHM, F, 0.25W	1	
	R16764	ERJ6GEYF473	M 47KOHM, J, 1/10W	1	
	R16765	ERJT08J1R0V	M 1.8OHM, J, 0.33W	1	
	R16766	ERJT06J750V	M 75 OHM, F, 0.25W	1	
	R16768	ERJT08J1R0V	M 1.8OHM, J, 0.33W	1	
	R16769	ERJT06J750V	M 75 OHM, F, 0.25W	1	
	R16771	ERJ6GEYJ182	M 1.8KOHM, J, 1/10W	1	
	R16774	ERGLSJ683	M 68KOHM, J, 1W	1	
	R16775	ERJ6GEYJ472V	M 4.7K OHM J 1/10W	1	
	R16776	D0GD101JA036	M 100 OHM, J, 0.25W	1	
	R16777	ERJT06J151V	M 150 OHM, F, 0.25W	1	
	R16778	ERJ6GEYJ182	M 1.8KOHM, J, 1/10W	1	
	R16781	ERJT06J470V	M 47 OHM, F, 0.25W	1	
	R16782	ERJ6GEYF473	M 47KOHM, J, 1/10W	1	
	R16783	ERJT06J470V	M 47 OHM, F, 0.25W	1	
	R16784	ERJ6GEYF473	M 47KOHM, J, 1/10W	1	
	R16785	ERJ6ENF8202	M 82KOHM, 1/10W	1	
	R16786	ERJ6ENF8202	M 82KOHM, 1/10W	1	
	R16787	ERJ6ENF3302	M 33KOHM, 1/10W	1	
	R16788	ERJT06J154V	M 150KOHM, F, 0.25W	1	
	R16789	D0GD103JA036	M 10KOHM, J, 0.25W	1	
	R16791	ERJ6GEYJ102V	M 1K OHM J 1/10W	1	
	R16792	D0GD103JA036	M 10KOHM, J, 0.25W	1	
	R16794	ERJ6ENF2003	M 200KOHM, 1/10W	1	
	R16795	ERJ6ENF2003	M 200KOHM, 1/10W	1	
	R16796	ERJ6ENF5602	M 56KOHM, 1/10W	1	
	R16797	ERJ6GEYJ220	M 22 OHM, J, 1/10W	1	
	R16798	D0GD103JA036	M 10KOHM, J, 0.25W	1	
	R16799	ERJ6ENF3302	M 33KOHM, 1/10W	1	
	R16801	ERJ6GEYJ472V	M 4.7K OHM J 1/10W	1	
	R16802	ERJ6GEYJ472V	M 4.7K OHM J 1/10W	1	
	R16804	ERJ8GEYJ224V	M 220KOHM, J, 1/8W	1	
	R16805	ERJ8GEYJ224V	M 220KOHM, J, 1/8W	1	
	R16807	ERJ6GEYJ472V	M 4.7K OHM J 1/10W	1	

Safety	Ref. No.	Part No.	Part Name & Description	Pcs	Remarks
	R16808	ERJ6GEYJ472V	M 4.7K OHM J 1/10W	1	
	R16810	ERJ6ENF1742	M17.4KOHM, 1/10W	1	
	R16811	ERJ6ENF1742	M17.4KOHM, 1/10W	1	
	R16813	ERJ8GEYJ102V	M 1KOHM, J,1/8W	1	
	R16814	ERJ6ENF1432	M14.3KOHM, 1/10W	1	
	R16815	D1BD1002A044	M10.0KOHM, 1/10W	1	
	R16816	DOGDR00Z0002	M 0 OHM, 1/10W	1	
	R16818	ERJ6ENF6802	M 68KOHM, 1/10W	1	
	R16819	ERJ6ENF6802	M 68KOHM, 1/10W	1	
	R16820	ERJ6ENF7872	M78.7KOHM, 1/10W	1	
	R16821	ERJ6ENF1003	M 100KOHM, 1/10W	1	
	R16822	ERJ6ENF8202	M 82KOHM, 1/10W	1	
	R16823	ERJ6ENF8202	M 82KOHM, 1/10W	1	
	R16824	ERJ6ENF3302	M 33KOHM, 1/10W	1	
	R16825	ERJT06J154V	M 150KOHM,F,0.25W	1	
	R16826	DOGD103JA036	M 10KOHM,J,0.25W	1	
	R16827	DOGDR00Z0002	M 0 OHM, 1/10W	1	
	R16828	ERJ6GEYJ472V	M 4.7K OHM J 1/10W	1	
	R16831	ERJ6GEYJ104V	M 100KOHM,J,1/10W	1	
	R16832	ERJ6GEYJ104V	M 100KOHM,J,1/10W	1	
	R16833	DOGD103JA036	M 10KOHM,J,0.25W	1	
	R16834	DOGDR00Z0002	M 0 OHM, 1/10W	1	
	R16835	DOGDR00Z0002	M 0 OHM, 1/10W	1	
	R16838	ERJ14YJ563U	M 56KOHM, 1/2W	1	
	R16841	ERJ14YJ563U	M 56KOHM, 1/2W	1	
	R16844	ERJ6ENF1241	M1.24KOHM, 1/10W	1	
	R16845	ERJ6ENF5622	M5.62KOHM, 1/10W	1	
	R16846	ERJ6ENF5762	M57.6KOHM, 1/10W	1	
	R16850	ERJ6GEYJ472V	M 4.7K OHM J 1/10W	1	
	R16855	ERG1FJS103D	M 10KOHM, J, 1W	1	
	R16856	ERQ12AJW560E	F 56 OHM, J,1/2W	1	
	R16857	ERJ12YJ124U	M 120KOHM, 1/2W	1	
	R16860	DOD28R2JA021	M 8.2 OHM,J,2W	1	
	R16869	ERJ8GEYJ473	M 47KOHM, J,1/8W	1	
	R16870	ERG2FJS333D	M 33KOHM, J, 2W	1	
	R16873	ERJ6ENF1241	M1.24KOHM, 1/10W	1	
	R16874	ERJ6ENF7872	M78.7KOHM, 1/10W	1	
	R16875	ERJ6ENF4302	M 43KOHM, 1/10W	1	
	R16878	ERJ6GEYJ223	M 22KOHM,J,1/10W	1	
	R16879	ERJ6GEYJ472V	M 4.7K OHM J 1/10W	1	
	R16881	DOGBR00Z0002	M 0 OHM J 1/16W	1	
	R16882	DOGBR00Z0002	M 0 OHM J 1/16W	1	
	R16886	ERJ6GEYJ224	M 220KOHM,J,1/10W	1	
	R16887	ERJ6GEYJ224	M 220KOHM,J,1/10W	1	
	R16888	ERJ6GEYJ224	M 220KOHM,J,1/10W	1	
	R17101	EXB38V471J	RESISTOR ARRAY	1	
	R17102	EXB38V471J	RESISTOR ARRAY	1	
	R17104	ERJT14J6R8U	C6.8 OHM, J,1/4W	1	
	R17105	ERJT14J6R8U	C6.8 OHM, J,1/4W	1	
	R17107	DOGF472JA047	M 4.7KOHM,J,0.33W	1	
	R17108	EXB38V471J	RESISTOR ARRAY	1	
	R17109	EXB38V471J	RESISTOR ARRAY	1	
	R17111	ERJT14J6R8U	C6.8 OHM, J,1/4W	1	
	R17112	ERJT14J6R8U	C6.8 OHM, J,1/4W	1	
	R17114	EXB38V471J	RESISTOR ARRAY	1	
	R17115	EXB38V471J	RESISTOR ARRAY	1	
	R17117	ERJT14J6R8U	C6.8 OHM, J,1/4W	1	
	R17118	ERJT14J6R8U	C6.8 OHM, J,1/4W	1	
	R17120	EXB38V471J	RESISTOR ARRAY	1	
	R17121	EXB38V471J	RESISTOR ARRAY	1	
	R17123	ERJT14J6R8U	C6.8 OHM, J,1/4W	1	
	R17124	ERJT14J6R8U	C6.8 OHM, J,1/4W	1	
	R17126	EXB38V471J	RESISTOR ARRAY	1	
	R17127	EXB38V471J	RESISTOR ARRAY	1	

Safety	Ref. No.	Part No.	Part Name & Description	Pcs	Remarks
	R17129	ERJT14J6R8U	C6.8 OHM, J,1/4W	1	
	R17130	ERJT14J6R8U	C6.8 OHM, J,1/4W	1	
	R17132	EXB38V471J	RESISTOR ARRAY	1	
	R17133	EXB38V471J	RESISTOR ARRAY	1	
	R17135	ERJT14J6R8U	C6.8 OHM, J,1/4W	1	
	R17136	ERJT14J6R8U	C6.8 OHM, J,1/4W	1	
	R17138	EXB38V471J	RESISTOR ARRAY	1	
	R17139	EXB38V471J	RESISTOR ARRAY	1	
	R17141	ERJT14J6R8U	C6.8 OHM, J,1/4W	1	
	R17142	ERJT14J6R8U	C6.8 OHM, J,1/4W	1	
	R17144	EXB38V471J	RESISTOR ARRAY	1	
	R17145	EXB38V471J	RESISTOR ARRAY	1	
	R17146	EXB38V681J	RESISTOR ARRAY	1	
	R17147	EXB38V681J	RESISTOR ARRAY	1	
	R17148	DOGBR00Z0002	M 0 OHM J 1/16W	1	
	R17149	DOGBR00Z0002	M 0 OHM J 1/16W	1	
	R17150	EXB38V470J	RESISTOR ARRAY	1	
	R17151	EXB38V470J	RESISTOR ARRAY	1	
	R17152	EXB38V681J	RESISTOR ARRAY	1	
	R17153	ERJ6GEYJ223	M 22KOHM,J,1/10W	1	
	R17154	ERJ6GEYJ104V	M 100KOHM,J,1/10W	1	
	R17155	EXB38V220JV	RESISTOR ARRAY	1	
	R17156	EXB38V220JV	RESISTOR ARRAY	1	
	R17157	EXB38V220JV	RESISTOR ARRAY	1	
	R17158	EXB38V220JV	RESISTOR ARRAY	1	
	R17159	ERJ6GEYJ224	M 220KOHM,J,1/10W	1	
	R17160	EXB38V471J	RESISTOR ARRAY	1	
	R17161	EXB38V471J	RESISTOR ARRAY	1	
	R17163	ERJT14J6R8U	C6.8 OHM, J,1/4W	1	
	R17164	ERJT14J6R8U	C6.8 OHM, J,1/4W	1	
	R17166	DOGDR00Z0002	M 0 OHM, 1/10W	1	
	R17201	EXB38V471J	RESISTOR ARRAY	1	
	R17202	EXB38V471J	RESISTOR ARRAY	1	
	R17204	ERJT14J6R8U	C6.8 OHM, J,1/4W	1	
	R17205	ERJT14J6R8U	C6.8 OHM, J,1/4W	1	
	R17207	EXB38V471J	RESISTOR ARRAY	1	
	R17208	EXB38V471J	RESISTOR ARRAY	1	
	R17210	ERJT14J6R8U	C6.8 OHM, J,1/4W	1	
	R17211	ERJT14J6R8U	C6.8 OHM, J,1/4W	1	
	R17213	EXB38V471J	RESISTOR ARRAY	1	
	R17214	EXB38V471J	RESISTOR ARRAY	1	
	R17216	ERJT14J6R8U	C6.8 OHM, J,1/4W	1	
	R17217	ERJT14J6R8U	C6.8 OHM, J,1/4W	1	
	R17219	EXB38V471J	RESISTOR ARRAY	1	
	R17220	EXB38V471J	RESISTOR ARRAY	1	
	R17222	ERJT14J6R8U	C6.8 OHM, J,1/4W	1	
	R17223	ERJT14J6R8U	C6.8 OHM, J,1/4W	1	
	R17225	EXB38V471J	RESISTOR ARRAY	1	
	R17226	EXB38V471J	RESISTOR ARRAY	1	
	R17228	ERJT14J6R8U	C6.8 OHM, J,1/4W	1	
	R17229	ERJT14J6R8U	C6.8 OHM, J,1/4W	1	
	R17231	EXB38V471J	RESISTOR ARRAY	1	
	R17232	EXB38V471J	RESISTOR ARRAY	1	
	R17234	ERJT14J6R8U	C6.8 OHM, J,1/4W	1	
	R17235	ERJT14J6R8U	C6.8 OHM, J,1/4W	1	
	R17237	EXB38V471J	RESISTOR ARRAY	1	
	R17238	EXB38V471J	RESISTOR ARRAY	1	
	R17240	ERJT14J6R8U	C6.8 OHM, J,1/4W	1	
	R17241	ERJT14J6R8U	C6.8 OHM, J,1/4W	1	
	R17243	DOGF472JA047	M 4.7KOHM,J,0.33W	1	
	R17244	ERJ6GEYJ223	M 22KOHM,J,1/10W	1	
	R17245	ERJ6GEYJ104V	M 100KOHM,J,1/10W	1	
	R17246	ERJ6GEYJ224	M 220KOHM,J,1/10W	1	
	R17247	EXB38V470J	RESISTOR ARRAY	1	
	R17248	EXB38V470J	RESISTOR ARRAY	1	
	R17249	EXB38V681J	RESISTOR ARRAY	1	
	R17250	EXB38V470J	RESISTOR ARRAY	1	
	R17251	EXB38V470J	RESISTOR ARRAY	1	
	R17252	DOGBR00Z0002	M 0 OHM J 1/16W	1	

Safety	Ref. No.	Part No.	Part Name & Description	Pcs	Remarks
	R17253	DOGBR00Z0002	M 0 OHM J 1/16W	1	
	R17254	EXB38V681J	RESISTOR ARRAY	1	
	R17255	EXB38V681J	RESISTOR ARRAY	1	
	R17256	EXB38V220JV	RESISTOR ARRAY	1	
	R17257	EXB38V220JV	RESISTOR ARRAY	1	
	R17258	EXB38V220JV	RESISTOR ARRAY	1	
	R17259	EXB38V220JV	RESISTOR ARRAY	1	
	R17260	ERJ3GEYJ681	M 680 OHM,J,1/16W	1	
	R17261	ERJ3GEYJ681	M 680 OHM,J,1/16W	1	
	R17262	ERJ3GEYJ681	M 680 OHM,J,1/16W	1	
	R17263	ERJ3GEYJ681	M 680 OHM,J,1/16W	1	
	R17264	DOGDR00Z0002	M 0 OHM, 1/10W	1	
	R2582A	J0JCC0000241	CHIP INDUCTOR	1	
	R2583A	J0JCC0000241	CHIP INDUCTOR	1	
	R2585A	J0JCC0000241	CHIP INDUCTOR	1	B/E
	RM2501	B3RAD0000160	IC	1	
	S1	K1KA03AA0193	3P CONNECTOR	1	
	SC2	K1KA02A00676	2P CONNECTOR	1	
	SC20	K1MN35BA0266	35P CONNECTOR	1	
	SC30	K1KA08AA0190	8P CONNECTOR	1	
	SC41	K1KA23AA0733	23P CONNECTOR	1	
	SC42	K1KA23AA0733	23P CONNECTOR	1	
	SC46	K1KA09AA0239	9P CONNECTOR	1	
	SCMM1	TMME047	CLAMPER	1	
	SCMM4	TMME292	CLAMPER	1	
	SCMM5	TMME260	CLAMPER	1	
	SD1	K1MND6BA0264	6P CONNECTOR	1	
	SD2	K1MND6BA0264	6P CONNECTOR	1	
	SD3	K1MND6BA0264	6P CONNECTOR	1	
	SD4	K1MND6BA0264	6P CONNECTOR	1	
	SD11	K1MN20BA0231	20P CONNECTOR	1	
	SD42	K1KB23AA0234	23P CONNECTOR	1	
	SD46	K1KY09AA0607	9P CONNECTOR	1	
	SS11	K1KA02A00676	2P CONNECTOR	1	
	SS12	K1KA10AA0194	10P CONNECTOR	1	
	SS33	K1KA10A00416	10P CONNECTOR	1	
	SS34	K1KA03AA0193	3P CONNECTOR	1	
	SS35	K1KA04AA0193	4P CONNECTOR	1	
	SS61	K1MN13BA0258	13P CONNECTOR	1	
	SS63	K1MN13BA0258	13P CONNECTOR	1	
	SS64	K1MN13BA0258	13P CONNECTOR	1	
	SS66	K1MN13BA0258	13P CONNECTOR	1	
	SSMM3	TMME190	CLAMPER	1	
	SSMM4	TMME190	CLAMPER	1	
	SU1	K1MND6BA0264	6P CONNECTOR	1	
	SU2	K1MND6BA0264	6P CONNECTOR	1	
	SU3	K1MND6BA0264	6P CONNECTOR	1	
	SU4	K1MND6BA0264	6P CONNECTOR	1	
	SU11	K1MN20BA0266	20P CONNECTOR	1	
	SU41	K1KB23AA0234	23P CONNECTOR	1	
	△	SW2500	K0F162B00002	SWITCH	1
		SW3753	EVQPC105K	SWITCH	1
		SW3754	EVQPC105K	SWITCH	1
		SW3755	EVQPC105K	SWITCH	1
		SW3756	EVQPC105K	SWITCH	1
		SW3757	EVQPC105K	SWITCH	1
	T16301A	ETS19AB249AC	SWITCHING TRANS	1	
	△	TU8301	ENG37E09KF	TUNER	1

Safety	Ref. No.	Part No.	Part Name & Description	Pcs	Remarks
	VR16000	EVMEASA00B54	CONTROL 50KOHMB 0.3W	1	
	VR16600	EVMEASA00B54	CONTROL 50KOHMB 0.3W	1	
	VR16602	EVMEASA00B23	CONTROL 2KOHMB 0.3W	1	
	VR16841	EVMEASA00B54	CONTROL 50KOHMB 0.3W	1	
	X1100	H0J100500035	CRYSTAL	1	
	X2010	H0J245500089	CRYSTAL	1	
	X2601	H0J202500019	CRYSTAL	1	
	X5200	H0J270500113	CRYSTAL	1	
	X7700	H0J240500037	CRYSTAL	1	
	X8101	H0J270500061	CRYSTAL	1	
	X8301	H0J204500006	CRYSTAL	1	B/E
	X8620	H0J300500026	CRYSTAL	1	
	X9000	H2D100500004	CRYSTAL	1	
	X9200	H0J200500076	CRYSTAL	1	
	ZA0001	K4AZ01D00004	TERMINAL	1	
	ZA0002	K4AZ01D00004	TERMINAL	1	
	ZA0003	K4AZ01D00004	TERMINAL	1	
	ZA0004	K4AZ01D00004	TERMINAL	1	
	ZA0005	K4AZ01D00004	TERMINAL	1	
	ZA0006	K4AZ01D00004	TERMINAL	1	
	ZA0007	K4AZ01D00004	TERMINAL	1	
	ZA0008	K4AZ01D00004	TERMINAL	1	
	ZA0010	TESA169	SHIELD CLIP	1	
	ZA0011	TESA169	SHIELD CLIP	1	
	ZA851	K4CZ01000027	AV TERMINAL	1	
	ZA852	K4CZ01000027	AV TERMINAL	1	
	ZA3701	K4CZ01000027	AV TERMINAL	1	
	ZA3702	K4CZ01000027	AV TERMINAL	1	
	ZA3801	K4AD01D00005	TERMINAL	1	
	ZA3802	K4AD01D00005	TERMINAL	1	
	ZA9000	K4CD01000011	AV TERMINAL	1	
	ZA9001	K4AZ01D00004	TERMINAL	1	
	ZA9002	K4AZ01D00004	TERMINAL	1	
	ZA14901	K4AD01Z00003	TERMINAL	1	
	ZA14902	K4AD01Z00003	TERMINAL	1	
	ZA14951	K4AD01Z00003	TERMINAL	1	
	ZA14952	K4AD01Z00003	TERMINAL	1	
	ZA16001	K4CD01000011	AV TERMINAL	1	
	ZA16002	K4CD01000011	AV TERMINAL	1	
	ZA16003	K4CD01000011	AV TERMINAL	1	
	ZA16401	K4CD01000011	AV TERMINAL	1	
	ZA16402	K4CD01000011	AV TERMINAL	1	
	ZA16403	K4CD01000011	AV TERMINAL	1	
	ZA17101	K4AD01Z00001	TERMINAL	1	
	ZA17103	K4AD01Z00001	TERMINAL	1	
	ZA17104	K4AD01Z00001	TERMINAL	1	
	ZA17105	K4AD01Z00001	TERMINAL	1	
	ZA17201	K4AD01Z00001	TERMINAL	1	
	ZA17203	K4AD01Z00001	TERMINAL	1	
	ZA17204	K4AD01Z00001	TERMINAL	1	
	ZA17205	K4AD01Z00001	TERMINAL	1	
	△	A601	AYRA652MSV8T	ARRESTOR	1
	C201	ACKZE1H220T	ELECTROLYTIC CAPACITOR	1	
	C202	ACRR3DD101K7	CERAMIC CAPACITOR	1	
	C203	ACRR3DD101K7	CERAMIC CAPACITOR	1	
	C204	ACMPF12333H	PLASTIC FILM CAPACITOR	1	
	C205	ACMPF12393H	PLASTIC FILM CAPACITOR	1	
	△	C206	ECKENA101KBR	C 100P 250V	1
	C207	ACCK1B681KP	CERAMIC CAPACITOR	1	
	C208	ACCK1B681KP	CERAMIC CAPACITOR	1	

Safety	Ref. No.	Part No.	Part Name & Description	Pcs	Remarks
	C251	ECQV1H104JL	P 0.1UF, J, 50V	1	
	C252	ECQV1H224JL	P 0.22UF, J, 50V	1	
	C254	ECQE2223SKF	PLASTIC FILM CAPACITOR	1	
	C255	ECQE2223SKF	PLASTIC FILM CAPACITOR	1	
△	C256	EETHC2E821LX	ELECTROLYTIC CAPACITOR	1	
△	C257	EETHC2E821LX	ELECTROLYTIC CAPACITOR	1	
	C301	ACKZE1H220T	ELECTROLYTIC CAPACITOR	1	
	C302	ACRR3DD101K7	CERAMIC CAPACITOR	1	
	C303	ACRR3DD101K7	CERAMIC CAPACITOR	1	
	C304	ACMPF12473H	PLASTIC FILM CAPACITOR	1	
	C305	ACCK1B331KP	CERAMIC CAPACITOR	1	
	C306	ACCK1B331KP	CERAMIC CAPACITOR	1	
	C352	ACKZE1E182ST	ELECTROLYTIC CAPACITOR	1	
	C354	ECQV1H224JL	P 0.22UF, J, 50V	1	
	C355	ECQV1H154JL	P 0.15UF, J, 50V	1	
	C357	ACKZE1E471ST	ELECTROLYTIC CAPACITOR	1	
	C358	ACKZE1E471ST	ELECTROLYTIC CAPACITOR	1	
	C401	ECQE2104SKF	PLASTIC FILM CAPACITOR	1	
	C402	ECQE2104SKF	PLASTIC FILM CAPACITOR	1	
△	C403	EETHC2C471HX	ELECTROLYTIC CAPACITOR	1	
	C404	ACKZE1H101T	ELECTROLYTIC CAPACITOR	1	
△	C406	EETHC2A122JJ	ELECTROLYTIC CAPACITOR	1	
	C407	ACDE2R221KP	ELECTROLYTIC CAPACITOR	1	
	C409	ECQE2104SKF	PLASTIC FILM CAPACITOR	1	
	C451	ACKZE1A471C	ELECTROLYTIC CAPACITOR	1	
△	C501	ECQU2A103MLA	P 0.01UF, M, 250V	1	
△	C503	ACKMQ2W560T	ELECTROLYTIC CAPACITOR	1	
	C504	ACKZE1H220T	ELECTROLYTIC CAPACITOR	1	
	C505	ECQV1H224JL	P 0.22UF, J, 50V	1	
	C506	ACKZE1H100T	ELECTROLYTIC CAPACITOR	1	
	C507	ACKZE1H221T	ELECTROLYTIC CAPACITOR	1	
	C508	ACKZE1H220T	ELECTROLYTIC CAPACITOR	1	
	C551	ACKZE1A471C	ELECTROLYTIC CAPACITOR	1	
	C555	ACKZE1E470T	ELECTROLYTIC CAPACITOR	1	
	C557	ECQV1473JM2	PLASTIC FILM CAPACITOR	1	
	C558	ECQV1H224JL	P 0.22UF, J, 50V	1	
	C559	ECQV1H474JL	P 0.47UF, J, 50V	1	
	C560	ECQV1H224JL	P 0.22UF, J, 50V	1	
	C600	ACDE2R331KP	CERAMIC CAPACITOR	1	
△	C601	ECQU2A105MLA	PLASTIC FILM CAPACITOR	1	
△	C602	ECQU2A474MLA	P 0.47UF, 250V	1	
△	C603	ECKENA221KBR	C 221P 250V	1	
△	C604	ECKENA221KBR	C 221P 250V	1	
	C605	ACDE1R102K7	CERAMIC CAPACITOR	1	
	C606	AC4MPK105KA3	PLASTIC FILM CAPACITOR	1	
	C610	ECQV1H474JL	P 0.47UF, J, 50V	1	

Safety	Ref. No.	Part No.	Part Name & Description	Pcs	Remarks
	C611	ACKZE1H220T	ELECTROLYTIC CAPACITOR	1	
△	C612	ACKMQ2W221L	ELECTROLYTIC CAPACITOR	1	
△	C613	ACKMQ2W221L	ELECTROLYTIC CAPACITOR	1	
△	C615	ECKENA221KBR	C 221P 250V	1	
	C625	ACDE1R102K7	CERAMIC CAPACITOR	1	
	C701	ACKZE1A471C	ELECTROLYTIC CAPACITOR	1	
	C702	ECQV1H103JL2	P 0.01UF, J, 50V	1	
	C703	ECQV1H224JL	P 0.22UF, J, 50V	1	
	D251	MA165TAKU	DIODE	1	
	D254	VDD4SBL40	DIODE	1	
	D351	VDG865C08R	DIODE	1	
	D352	VDAG01AT	DIODE	1	
	D353	VDG865C08R	DIODE	1	
	D401	VDD6SBN20	DIODE	1	
	D402	VDAG01AT	DIODE	1	
	D403	VDYG901C3R	DIODE	1	
△	D501	VDS1WBA80	DIODE	1	
	D504	VXST3D82BL3	POWER CLAMPER	1	
	D505	VDAG01AT	DIODE	1	
	D506	VDAG01AT	DIODE	1	
	D551	VDRK39A5	DIODE	1	
	D556	VDRF101A2S	DIODE	1	
	D601	MA165TAKU	DIODE	1	
	D602	MA165TAKU	DIODE	1	
	D603	VDAP01CT	DIODE	1	
	D604	VDAP01CT	DIODE	1	
	D606	VDS3V60L1	DIODE	1	
	D702	VDERA83-004T	DIODE	1	
△	F201	HU216005BEP	CARTRIDGE FUSE (LEADTYPE)	1	
△	F301	HU216005BEP	CARTRIDGE FUSE (LEADTYPE)	1	
△	F501	HU215002BEP	CARTRIDGE FUSE (LEADTYPE)	1	
△	F601	HU215010BEP	CARTRIDGE FUSE (LEADTYPE)	1	
△	F602	HU215010BEP	CARTRIDGE FUSE (LEADTYPE)	1	
	IC251	AN1431TBTA	INTEGRATED CIRCUIT	1	
	IC352	AN1431TBTA	INTEGRATED CIRCUIT	1	
△	IC501	MIP3E30MPSCF	IC	1	
	IC555	AN1431TBTA	INTEGRATED CIRCUIT	1	
△	K601	ALKT329C93	RELAY	1	
△	K602	ALDJ5D2T8	RELAY	1	
	L401	AYLH8TB681K	CHOKE	1	
	L402	AYH221012HY	CHOKE	1	
	L501	EXCELSA35	BEAD CHOKE	1	
	L502	EXCELD35C	BEAD CHOKE	1	
	L503	EXCELD35C	BEAD CHOKE	1	
	L551	EXCELD35C	BEAD CHOKE	1	
△	L601	AYJ3112308Z	FILTER CHOKE	1	
△	L602	AYJ3112308Z	FILTER CHOKE	1	
	L603	ETB50CZ14GAD	CHOKE	1	
△	MC201	MDPPNB101	MODULE	1	
△	MC203	MP00R3A1	MODULE	1	
△	MC301	MDPPNB102	MODULE	1	
△	MC352	MDPJFB101	MODULE	1	
△	MC401	MDPPSA102	MODULE	1	
△	MC451	MDPLSB101	MODULE	1	
△	MC501	MDPTZA101	MODULE	1	

Safety	Ref. No.	Part No.	Part Name & Description	Pcs	Remarks
△	MC502	MDPHHA101	MODULE	1	
△	MC552	MDPPFC101	MODULE	1	
△	MC601	MDPLPB101	MODULE	1	
△	MC602	MP00P33	MODULE	1	
△	MC603	MP00P30	MODULE	1	
△	MC701	MDPZDA101	MODULE	1	
	P2	AKB2P3-VH-B	CONNECTOR	1	
	P6	AKB12B-EH-A	CONNECTOR	1	
	P7	AKB11B-EH-A	CONNECTOR	1	
△	P9	AKS02B-VT	CONNECTOR	1	
	P11	AKB2P3-VH-B	CONNECTOR	1	
	P12	AKB10B-PH-KS	CONNECTOR	1	
	P25	AKB13B-PH-KS	CONNECTOR	1	
△	PC201	VPS2581AL1VH	OPTOISOLATOR	1	
△	PC202	VPS2581AL1VH	OPTOISOLATOR	1	
△	PC301	VPS2581AL1VH	OPTOISOLATOR	1	
△	PC302	VPS2581AL1VH	OPTOISOLATOR	1	
△	PC401	VPS2581AL1VH	OPTOISOLATOR	1	
△	PC501	VPS2581AL1VH	OPTOISOLATOR	1	
△	PC502	VPS2581AL1VH	OPTOISOLATOR	1	
△	Q301	VKFMA16N55G	FIELD EFFECT TRANSISTOR	1	
△	Q302	VKFMA16N55G	FIELD EFFECT TRANSISTOR	1	
	Q351	2SK3704	FIELD EFFECT TRANSISTOR	1	
	Q401	2SK3607	FIELD EFFECT TRANSISTOR	1	
	Q402	2SA17670Q2TV	TRANSISTOR	1	
	Q403	2SA17670Q2TV	TRANSISTOR	1	
	R202	ERQ14AJ4R7J	F 4.7 OHM, J,1/4W	1	
	R203	ERDS2FJ334	CARBON FILM RESISTOR	1	
	R204	ERDS2FJ334	CARBON FILM RESISTOR	1	
	R208	ERG12SJ910J	METAL OXIDE FILM RESISTOR	1	
	R215	ERG12SJ270J	METAL OXIDE FILM RESISTOR	1	
	R216	ERG12SJ270J	METAL OXIDE FILM RESISTOR	1	
	R217	ERG12SJ910J	METAL OXIDE FILM RESISTOR	1	
	R251	ARRCR1F1303T	METAL GLAZE FIXED RESISTOR	1	
	R252	ARRCR1F1273T	METAL GLAZE FIXED RESISTOR	1	
	R253	ERDS2FJ151	CARBON FILM RESISTOR	1	
	R254	ERDS2FJ102	M 1KOHM,J,1/10W	1	
	R256	EROS2THD1002	METAL FILM RESISTOR	1	
	R257	ERDS2FJ472	CARBON FILM RESISTOR	1	
	R258	ERDS2FJ472	CARBON FILM RESISTOR	1	
	R259	ERDS2FJ472	CARBON FILM RESISTOR	1	
	R263	ERDS2FJ220	C 22 OHM, J,1/4W	1	
	R264	ERDS2FJ102	M 1KOHM,J,1/10W	1	
	R265	ARRCR1F2373T	METAL GLAZE FIXED RESISTOR	1	
	R266	ARRCR1F3743T	METAL GLAZE FIXED RESISTOR	1	
	R267	ARRCR1F3653T	METAL GLAZE FIXED RESISTOR	1	
	R302	ERQ14AJ4R7J	F 4.7 OHM, J,1/4W	1	
	R303	ERDS2FJ334	CARBON FILM RESISTOR	1	

Safety	Ref. No.	Part No.	Part Name & Description	Pcs	Remarks
	R304	ERDS2FJ334	CARBON FILM RESISTOR	1	
	R308	ERG12SJ910J	METAL OXIDE FILM RESISTOR	1	
	R309	ERG12SJ220J	METAL OXIDE FILM RESISTOR	1	
	R310	ERG12SJ220J	METAL OXIDE FILM RESISTOR	1	
	R311	ERG12SJ910J	METAL OXIDE FILM RESISTOR	1	
	R351	EROS2CHF8871	M8.87KOHM, F,1/4W	1	
	R352	ARRF5EJ30MB	METAL PLATE RESISTOR	1	
	R353	ERDS2FJ561	C 560 OHM, J,1/4W	1	
	R354	ERDS2FJ221	C 220 OHM, J,1/4W	1	
	R355	ERDS2FJ222	C 2.2KOHM, J,1/4W	1	
	R356	EROS2THD1021	METAL FILM RESISTOR	1	
	R359	EROS2THD5361	METAL FILM RESISTOR	1	
	R362	ERG12SJ332J	METAL OXIDE FILM RESISTOR	1	
	R366	EROS2THF6981	METAL FILM RESISTOR	1	
	R367	EROS2CHF8451	METAL FILM RESISTOR	1	
	R371	EROS2THF6981	METAL FILM RESISTOR	1	
	R372	EROS2THF33R0	METAL FILM RESISTOR	1	
	R373	ERX12SJ2R2J	METAL FILM RESISTOR	1	
	R403	ERG12SJ100J	METAL OXIDE FILM RESISTOR	1	
	R404	EROS2CKF6492	M64.9KOHM, F,1/4W	1	
	R405	ARRF2EJR10B	METAL PLATE RESISTOR	1	
	R409	ERDS2FJ473	C 47KOHM, J,1/4W	1	
	R411	EROS2CKF2001	METAL FILM RESISTOR	1	
	R412	EROS2CKF2001	METAL FILM RESISTOR	1	
	R413	EROS2THF3162	METAL FILM RESISTOR	1	
	R414	EROS2THF3162	METAL FILM RESISTOR	1	
	R417	EROS2THF4422	METAL FILM RESISTOR	1	
	R418	EROS2THF4422	METAL FILM RESISTOR	1	
	R420	EROS2THF5620	METAL FILM RESISTOR	1	
	R421	EROS2THF1652	METAL FILM RESISTOR	1	
	R456	EROS2CKF1332	M13.3KOHM, F,1/4W	1	
△	R502	ARRCR6J825M	METAL GLAZE FIXED RESISTOR	1	
	R505	ERDS2FJ561	C 560 OHM, J,1/4W	1	
	R506	ARRCR1F8253T	METAL GLAZE FIXED RESISTOR	1	
	R507	ARRCR1F8253T	METAL GLAZE FIXED RESISTOR	1	
	R509	ARRCR1F8253T	METAL GLAZE FIXED RESISTOR	1	
	R510	ARRCR1F8253T	METAL GLAZE FIXED RESISTOR	1	
	R522	ERDS2FJ180	CARBON FILM RESISTOR	1	
	R523	ARRCR1F8253T	METAL GLAZE FIXED RESISTOR	1	
	R524	ARRCR1F8253T	METAL GLAZE FIXED RESISTOR	1	
	R555	EROS2THF1022	METAL FILM RESISTOR	1	

Safety	Ref. No.	Part No.	Part Name & Description	Pcs	Remarks
	R557	ERDS2TJ392	C 3.9KOHM, J,1/4W	1	
	R558	ER0S2CKF1623	M 162KOHM, F,1/4W	1	
	R559	ER0S2CKF1623	M 162KOHM, F,1/4W	1	
	R560	ERDS2FJ222	C 2.2KOHM, J,1/4W	1	
	R561	ER0S2CHF2152	METAL FILM RESISTOR	1	
	R562	ERDS2FJ150	CARBON FILM RESISTOR	1	
	R563	ERDS2FJ121	CARBON FILM RESISTOR	1	
	R564	ER0S2THD1002	METAL FILM RESISTOR	1	
	R600	ARR5B100JC2	WIREWOUND RESISTOR	1	
△	R601	ARRCR5J624M	METAL GLAZE FIXED RESISTOR	1	
	R603	ARRCR1F3093T	METAL GLAZE FIXED RESISTOR	1	
	R604	ARRCR1F3093T	METAL GLAZE FIXED RESISTOR	1	
	R607	ARRCR1F4993T	METAL GLAZE FIXED RESISTOR	1	
	R608	ARRCR1F4993T	METAL GLAZE FIXED RESISTOR	1	
	R611	ER0S2THF5112	METAL FILM RESISTOR	1	
	R617	ARRF2EJR15B	METAL PLATE RESISTOR	1	
	R618	ARRF2EJR15B	METAL PLATE RESISTOR	1	
	R619	ARRF2EJR10B	METAL PLATE RESISTOR	1	
	R622	ERDS2FJ472	CARBON FILM RESISTOR	1	
	R623	ERG12SJ330J	METAL OXIDE FILM RESISTOR	1	
	R624	ERDS2FJ472	CARBON FILM RESISTOR	1	
	R625	ERG12SJ330J	METAL OXIDE FILM RESISTOR	1	
	R626	ERDS2FJ472	CARBON FILM RESISTOR	1	
	R627	ERG12SJ330J	METAL OXIDE FILM RESISTOR	1	
	R630	ARRCR1F2493T	METAL GLAZE FIXED RESISTOR	1	
	R631	ARRCR1F2493T	METAL GLAZE FIXED RESISTOR	1	
	R632	ARRCR1F2213T	METAL GLAZE FIXED RESISTOR	1	
	R633	ARRCR1F3093T	METAL GLAZE FIXED RESISTOR	1	
	R634	ARRCR1F4993T	METAL GLAZE FIXED RESISTOR	1	
	R701	ERDS2FJ221	C 220 OHM, J,1/4W	1	
	R702	ERDS2FJ222	C 2.2KOHM, J,1/4W	1	
	R703	ERDS2FJ221	C 220 OHM, J,1/4W	1	
	R704	ERDS2FJ222	C 2.2KOHM, J,1/4W	1	
	R706	ERDS2FJ221	C 220 OHM, J,1/4W	1	
	R707	ERDS2FJ222	C 2.2KOHM, J,1/4W	1	
	R712	ERDS2FJ221	C 220 OHM, J,1/4W	1	
	R713	ERDS2FJ222	C 2.2KOHM, J,1/4W	1	
△	RF601	HUA5MC100JP2	THERMAL CUTOFF WITH RESISTOR	1	
△	T201	ETB50LZ1AGAD	TRANSFORMER	1	
△	T301	ETB50LZ17GAD	TRANSFORMER	1	

Safety	Ref. No.	Part No.	Part Name & Description	Pcs	Remarks
△	T501	ETB25AH118BH	TRANSFORMER	1	
	VR251	EVMEASA01B55	VARIABLE RESISTOR	1	
	VR401	EVMEASA01B54	VARIABLE RESISTOR	1	
△	Z501	ERZVGAD471	VARISTOR	1	
△	Z601	ERZVGED751	VARISTOR	1	
△	Z603	ERZVGAD471	VARISTOR	1	
	ZD201	MA4270NMTA	ZENER DIODE	1	
	ZD203	MA4270NMTA	ZENER DIODE	1	
	ZD204	MA4270NMTA	ZENER DIODE	1	
	ZD251	MA4330NMTA	ZENER DIODE	1	
	ZD301	MA4270NMTA	ZENER DIODE	1	
	ZD302	MA4270NMTA	ZENER DIODE	1	
	ZD351	MA4300NMTA	ZENER DIODE	1	
	ZD451	MAZ4068NMF	ZENER DIODE	1	
	ZD501	MA4300NMTA	ZENER DIODE	1	
	ZD502	MA4300NMTA	ZENER DIODE	1	
	ZD503	MA4082NM	ZENER DIODE	1	
	ZD555	MA4300NMTA	ZENER DIODE	1	
	ZD601	MA4047NM	ZENER DIODE	1	