

SD-P1712SE CHASSIS ASSEMBLY

*Note: There are 10 picks between the side of Top Panel (1) and LCD Mask (3).
Damage to Top Panel and LCD Mask may occur if removing the picks by metal tool.
(i.e. screwdriver) Please use plastic tool of same strength to remove the picks.

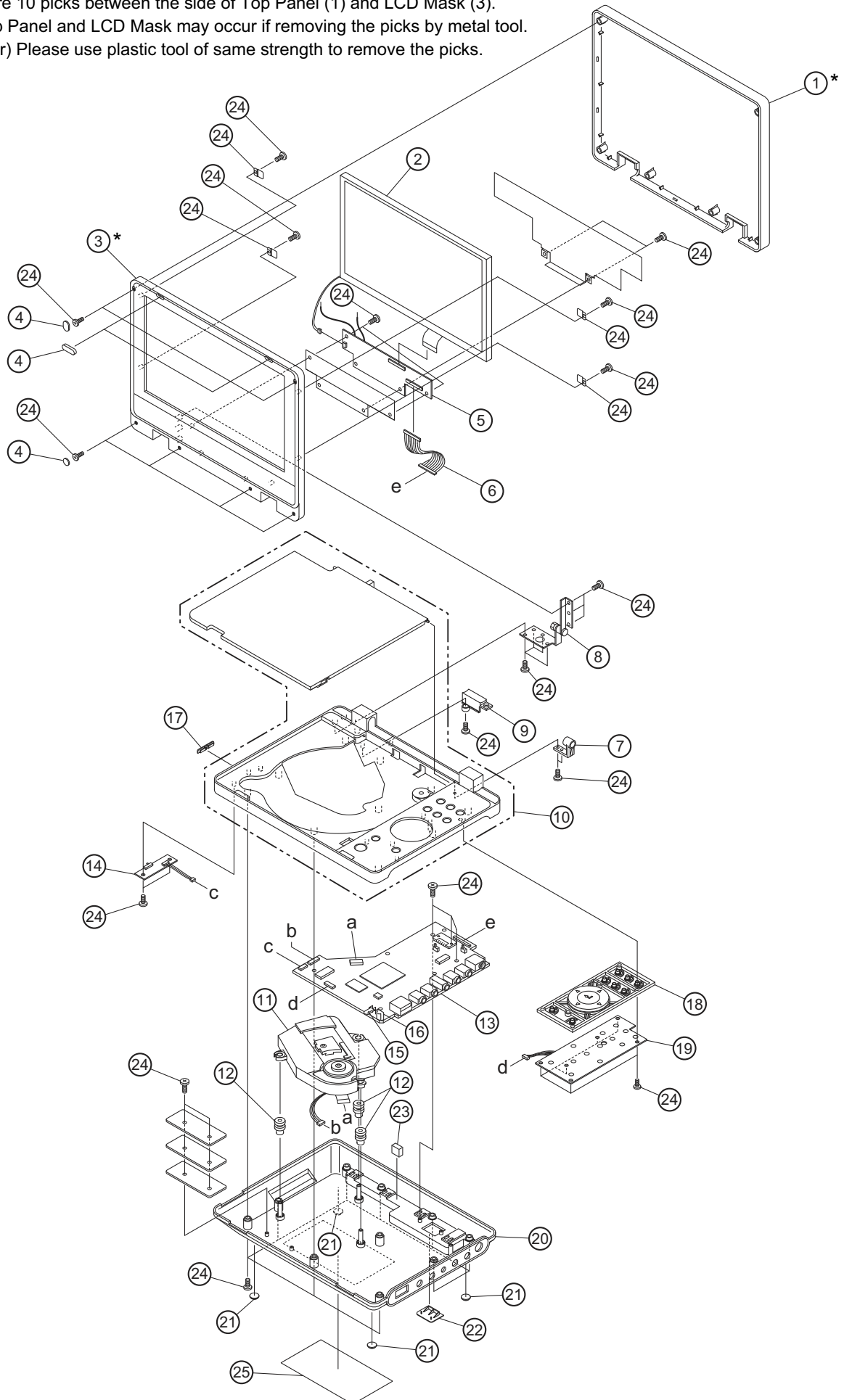

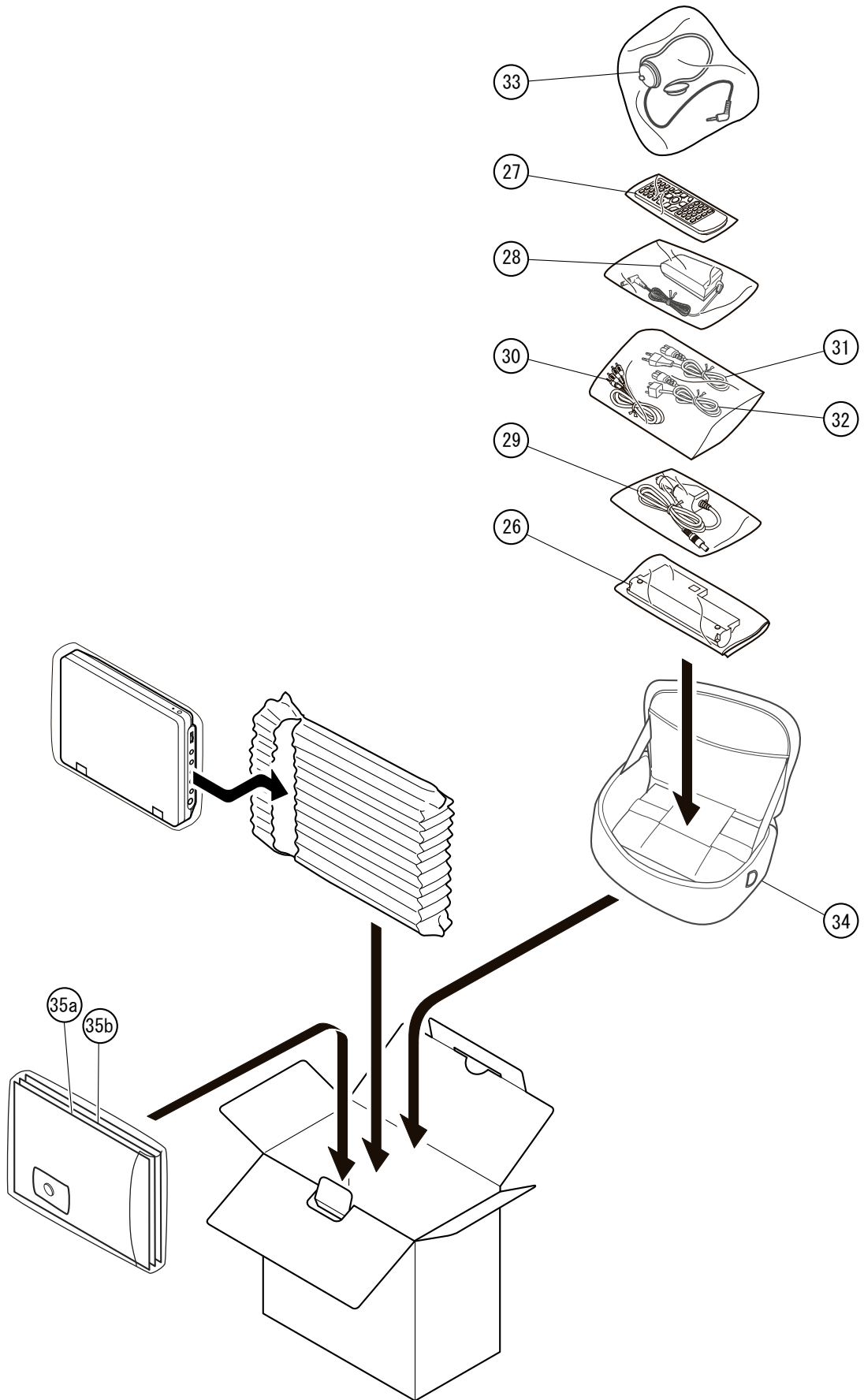











SD-P1712SE PACKING ASSEMBLY



PARTS LIST: SD-P1712SE

NOTE:

When the bottom cover (20) is replaced with a new one, put a new rating label (25) on the new bottom cover. Transcribe the following items (SERIAL NO., MANUFACTURED etc.) described on the old rating label to the new rating label by using a permanent maker.

	Loc. No.	TSB P/N	Ref. No.	Description
	1	AH302272	e27016	Top Cover Ass'y
	2	AH302382	ea7187t	LCD Unit
	3	AH302537	e25170	LCD Mask Ass'y
	4	AH302275	e27018	LCD Mask Pad
	5	AH302538	e25174	LCD PCB
	6	AH302277	e25109	Harness
	7	AH302384	eb45203	Harness Holder
	8	AH302278	eb45221	Hinge Ass'y
	9	AH302279	eb45201j	Hinge Cover
	10	AH302539	e25171	Sub Cover Ass'y
	11	AH302540	e25175	DVD Mecha Ass'y
	12	AH301644	eb8073	Damper
	13	AH302541	e23121	Main PCB Ass'y
	14	AH302542	e25177	Power Switch PCB Ass'y
	15	AH301266	ea1610	LED Lamp
	16	AH301927	ea6733d	IR Sensor
	17	AH302283	eb45200j	Power Switch Knob
	18	AH302284	e27020	Function Button
	19	AH302285	e22703	Function PCB
	20	AH302543	e25172	Bottom Cover Ass'y
	21	AH301467	eb5430	Bottom Cover Pads
	22	AH301728	eb43054h	Battery Slot Cover
	23	AH302483	ea8256	Gasket
	24	AH302544	e25173	Screw Kit
	25	AH302534	es13407	Rating Label without serial number
	26	AH302545	e25176	Battery Pack with the rating label, SD-PBP70E
	27	AH301378	es06054c	Remote Control
	28	AH302148	es9014c	AC Adaptor, ADPV16A
	29	AH302533	es8290r	Car Adaptor
	30	AH301124	es3468a	AV Cable
	31	AH301380	es2684	Power Cord, Euro (VDE)
	32	AH301379	es2678	Power Cord, UK (BS)
	33	AH302255	es4365c	Headphones, AT-H-SH306AE
	34	AH301733	es8682a	Carrying Case
	35a	AH302535	es15239gss	Owner's Manual, English
	35b	AH302536	es15239gssa	Owner's Manual, French

SAFETY PRECAUTION

The parts identified by  mark are critical for safety. Replace only with part number specified. The mounting position of replacement is to be identical with originals. The substitute replacement parts which do not have the same safety characteristics as specified in the parts list may create shock, fire or other hazards.

TOSHIBA CORPORATION
1-1, SHIBAURA 1-CHOME, MINATO-KU, TOKYO 105-8001, JAPAN