

S/M No:RFP341C001

Service Manual

Refrigerator

RF-420N..
RN-420N..



Factory No.
RFP-341...C
RFP-341...N

✓ Caution

In this manual, some parts can be changed for improving their performance without notice. So, If you need the latest parts information, please visit and refer to PPL (Parts Price List) in Service Information Center. (<http://svc.dwe.co.kr>)

1. Model Information

* is the Color

Buyer No.		RF-420N*	RN-420N*
Factory No.		RFP-341N....C	RFP-341N....N
Control Type		FCP Button Control	
Gross Vol. (ISO 15502)	Total	375	375
	Freezer	120	120
	Refrigerator	255	255
Storage Vol. (ISO 15502)	Total	332	332
	Freezer	90	90
	Refrigerator	242	242
Diemension	Width	595	595
	Depth	657	657
	Height	1898	1898
Cooling Cycle	Refrigerant Type	R-134a	R-600a
	Refrigerant Charge	0.095kg	0.040kg
	Evaporator Type	Fin Type	
	Condenser Type	Fan Cooling System	
	Dryer	Molecular Sieve xH-9	
	Capillary Tube	ID0.7 x T0.55 x L2320	
Heater	Defrost Type	Automatic Start & Stop	
	Defrost Heater	AC230V, 180W	AC230V, 160W
	Defrost Shape	Glass Type	Sheath Type
Electric Part	Freezer Fan Motor	AC 220V/50Hz, 2500RPM	
	Condenser Fan Motor	AC 230V/50Hz, 2400RPM	
	Refrigerator Lamp	25W x 1EA	
Weight		68	68
Blowing Agent		C-Pentane	

2. Interior Parts

- Features are model dependent
(Below is RF-420N model)

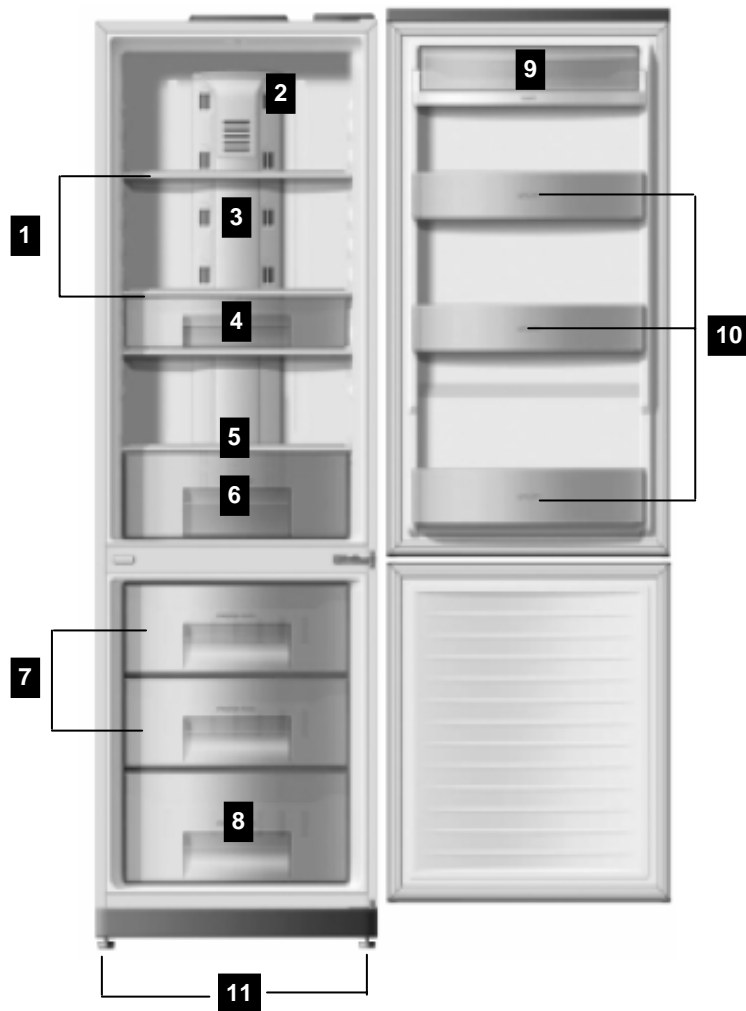

- 1. Refrigerator Shelves**
- 2. Lamp Window**
- 3. Multi Duct**
- 4. Basket Multiple (option)**
- 5. Cover Vegetable Case**
- 6. Vegetable Case**

- 7. Feezer Case B**
- 8. Freezer Case C**
- 9. Dairy Pocket As**
- 10. Refrigerator Pocket**
- 11. Adjustable Foot**

3. Machine (Compressor) Compartment View

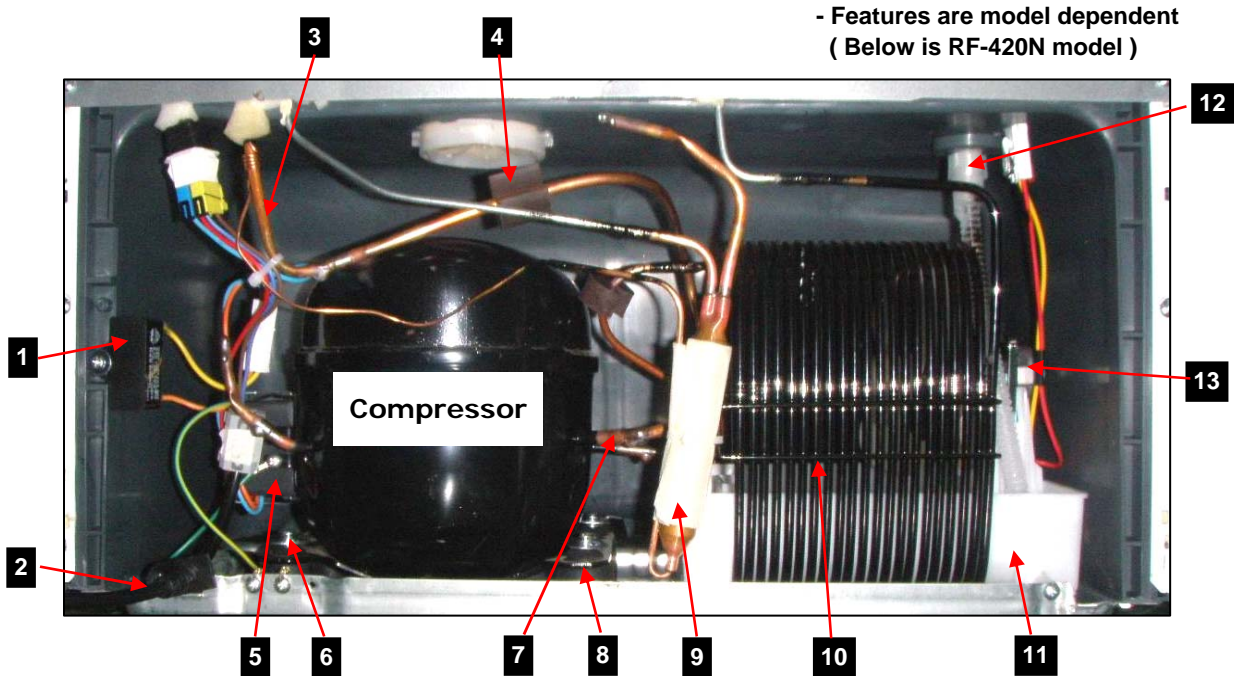

- | | |
|------------------------------|----------------------------|
| 1. Capacitor Run | 8. Compressor Absorber |
| 2. Power Cord | 9. Dryer As |
| 3. Suction Pipe As | 10. Pipe Wire Condensor As |
| 4. Pipe Absorber | 11. Case vaporization As |
| 5. Box Relay As | 12. Drain Hose |
| 6. Fixture Compress (Washer) | 13. Compressor Cooling Fan |
| 7. Pipe Connector B | |

4. Refrigerant Cycle

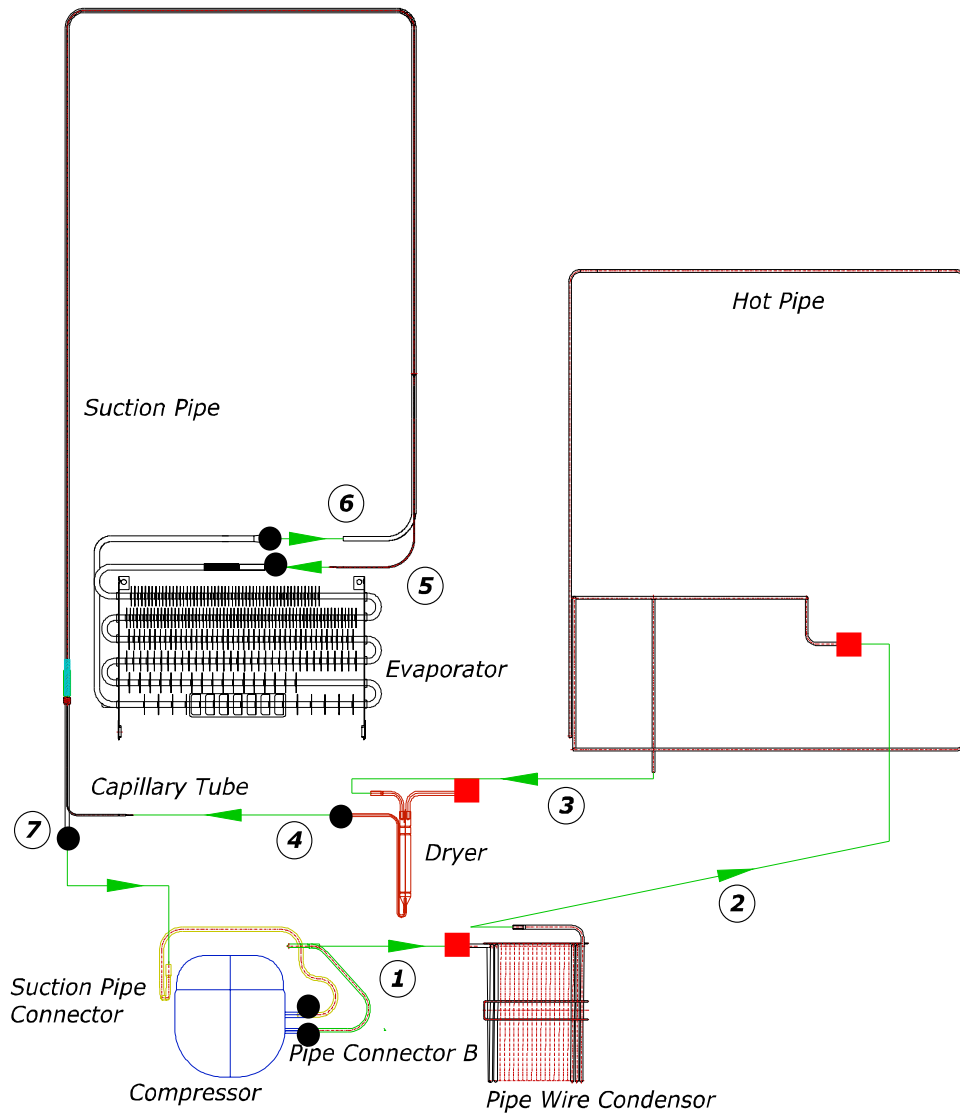

- Welding Point

●	Copper Welding (Ag 5%)	6 Point
■	Silver Welding (Ag 30%)	3 Point

5. Temperature Diagram

* Features are model dependent

(Below model is RF-420NT)

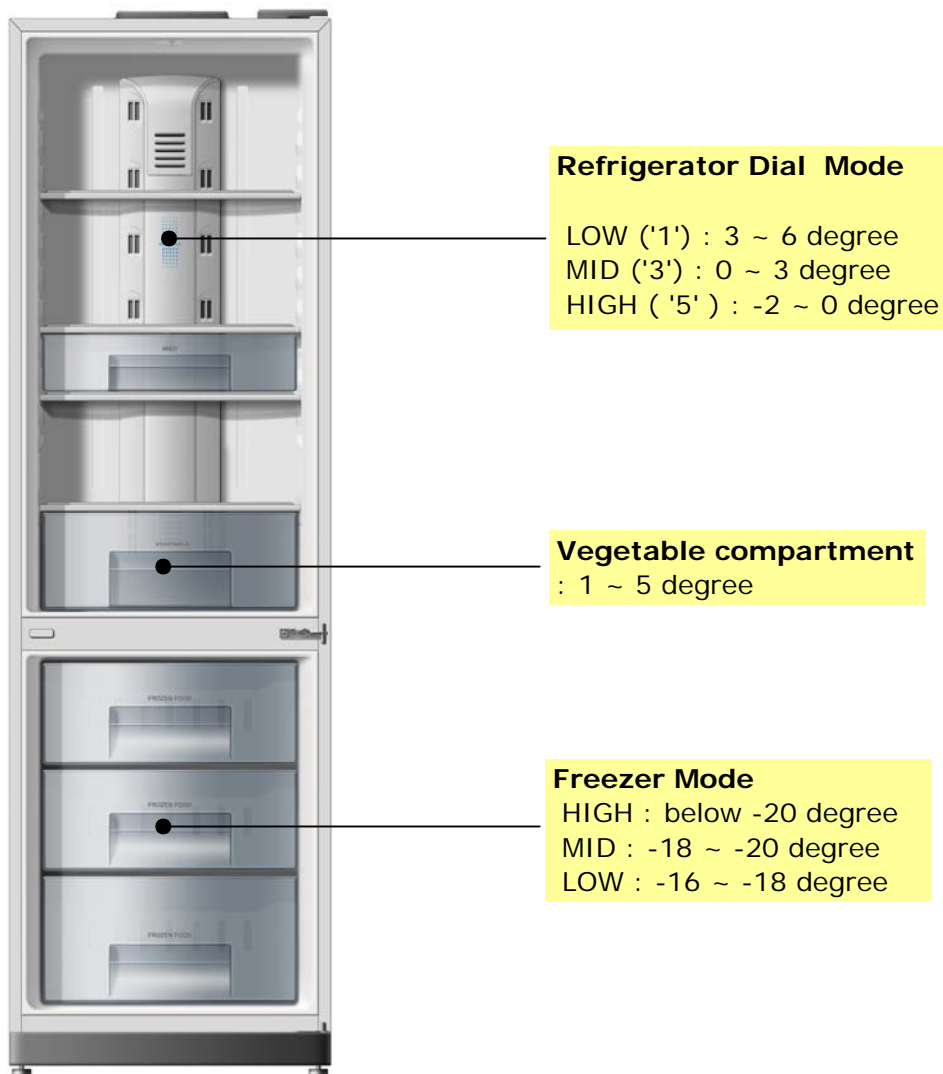

; The actual inner temperature varies depending on the food status, as the indicated setting temperature is a target temperature, not actual temperature within refrigerator.

; Refrigeration function is weak in the initial time.

Please adjust temperature as above after using refrigerator for minimum 1 ~ 2 days.

6. Wiring Diagram

6-1. For RF-420N Models

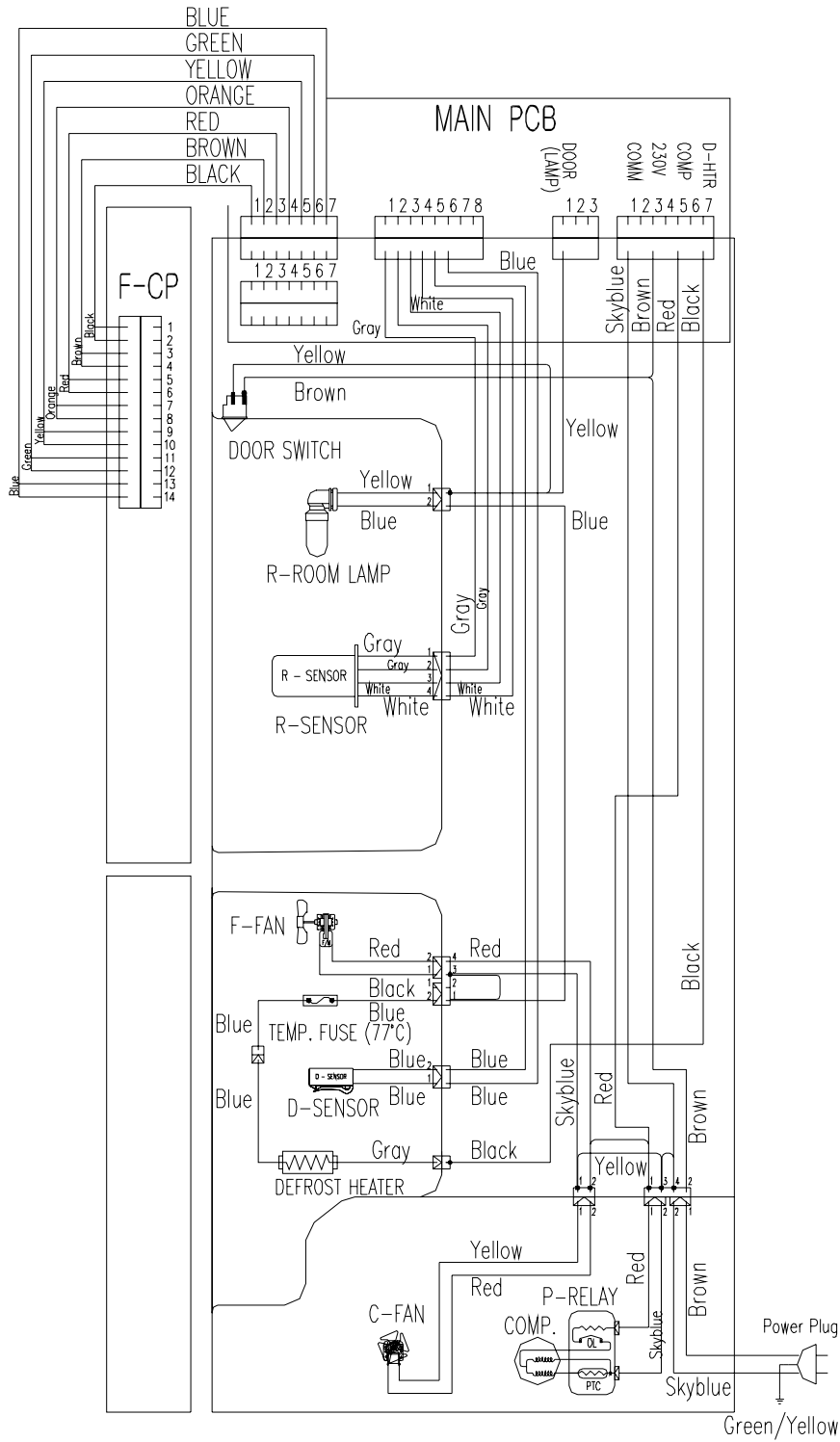

6. Wiring Diagram

6-2. For RN-420N (R-600a) Models

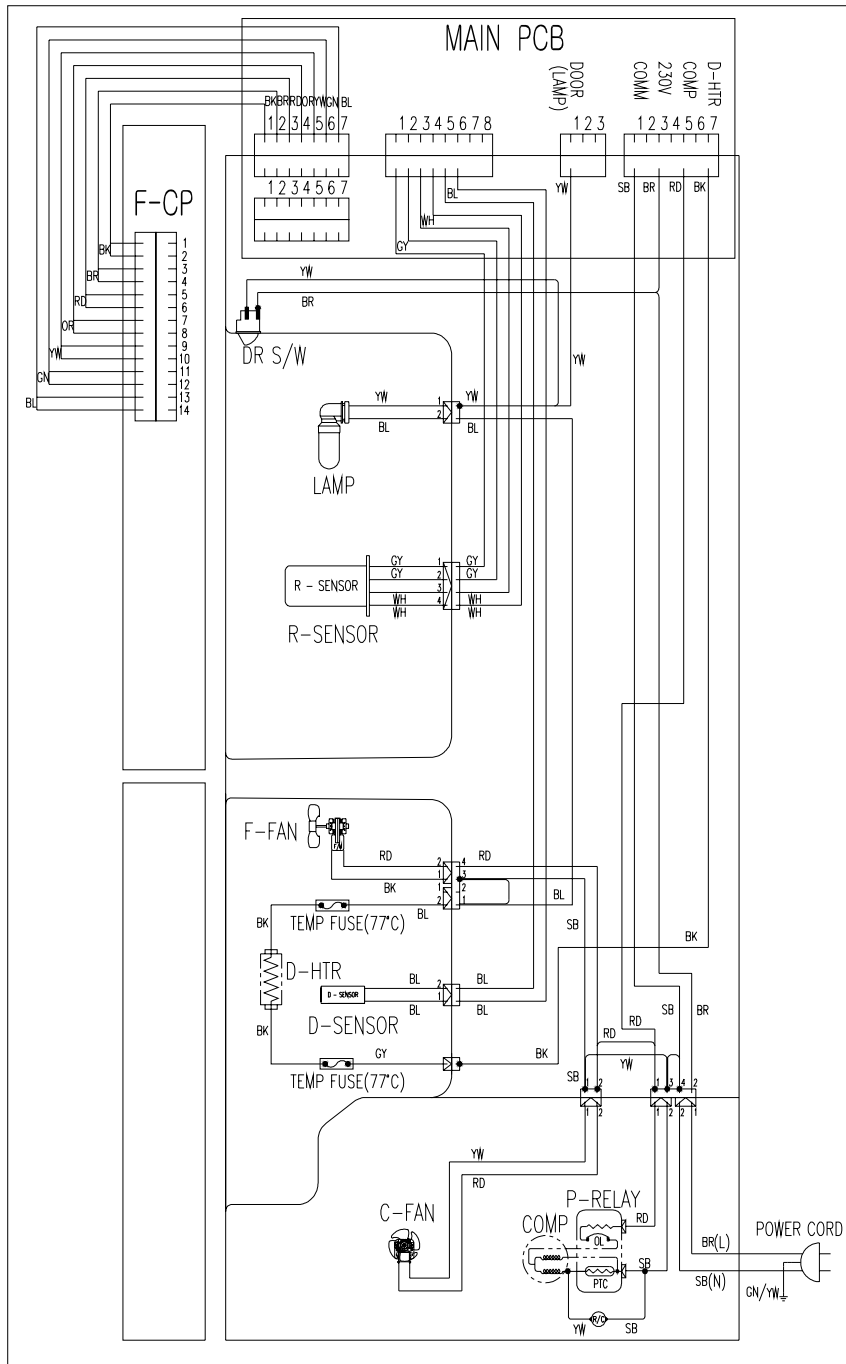

6. Main PCB Circuit Diagram (Only for RF-420N and RN-420N Models)

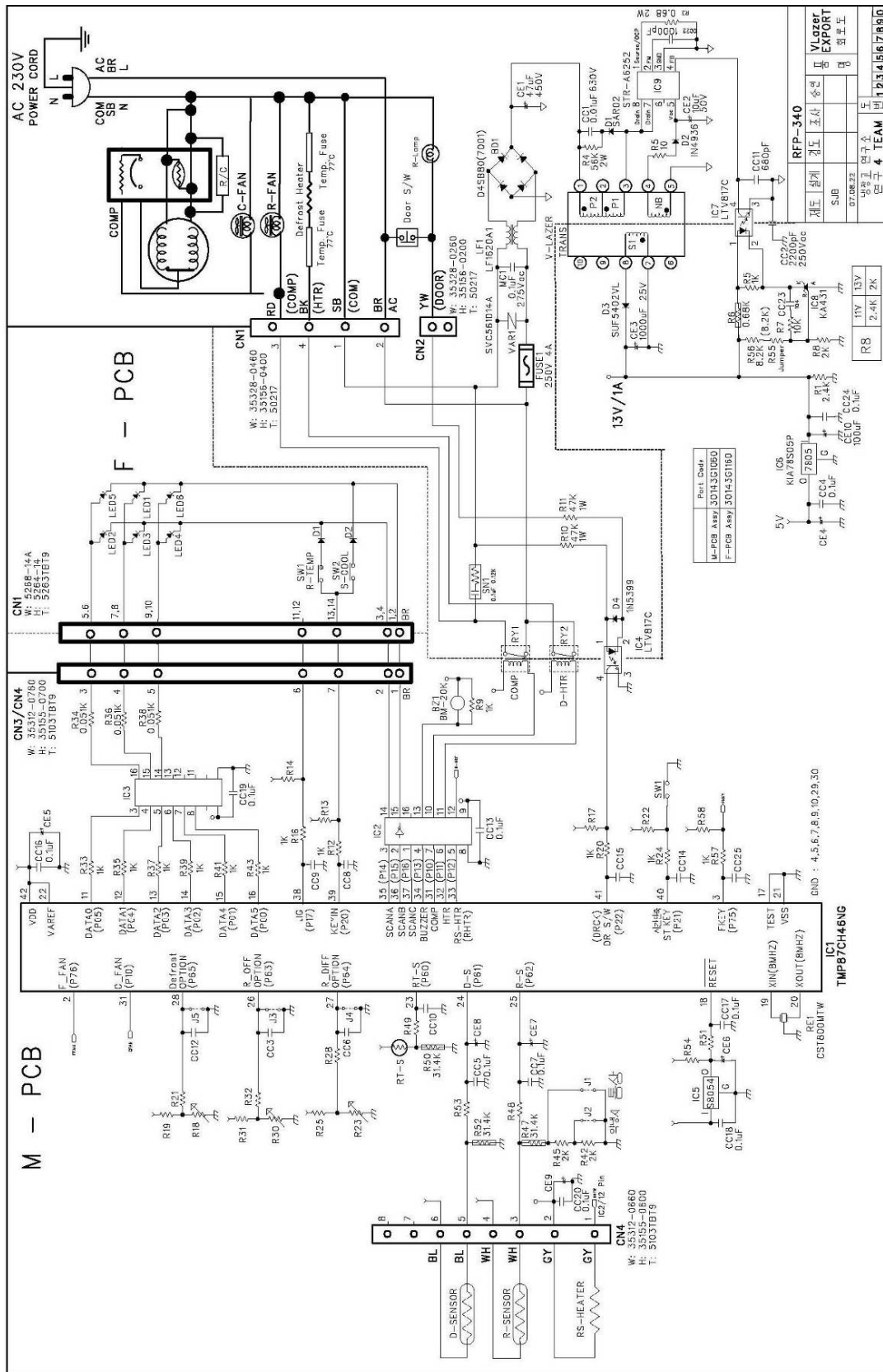

1. DISPLAY			
INPUT	CONTROL OBJECT		
PCB Control Panel Buttons	PCB Control Panel LED		
<p>Temperature adjustment button for refrigerator compartment.</p> <p>“Super Cool” button</p> <p>Reference Page No.</p>			
	LED DISPLAY	FUNCTION	OPERATION
10	LED “3” on	TEMP STEP “3”	Push “TEMP” button 1 time.
	LED “4” on	TEMP STEP “4”	Push “TEMP” button 2 times.
	LED “5” on	TEMP STEP “5”	Push “TEMP” button 3 times.
	LED “1” on	TEMP STEP “1”	Push “TEMP” button 4 times.
	LED “2” on	TEMP STEP “2”	Push “TEMP” button 5 times.
	LED “S-COOL” on	TEMP S-COOL	Push “S-COOL” button 1 time.
18	“3” flickeringly	ERROR “R SENSOR” (R1)	The Priorities of Error : R SENSOR> RT SENSOR> DR S/W> CYCLE> DEFROST
	“2” flickeringly	ERROR “RT SENSOR” (RT)	
	“1” flickeringly	ERROR “D SENSOR” (D1)	
	“2” & “3” flickeringly	ERROR “DOOR S/W” (DR)	
	“1” & “3” flickeringly	ERROR “CYCLE” (C1)	
	“1” & “2” flickeringly	ERROR “DEFROST” (F3)	
11	“3” & “S-COOL” on, “4” & “5” flickeringly	Forced Defrost Test	Push “TEMP” button for continuously and “S-COOL” button 5 times. And then, push “S-COOL” button for continuously and “TEMP” button 5 times.
	“1” & “S-COOL” on “4” & “5” flickeringly	Pull Down Test	Push “TEMP” button 30 times. And then, push “S-COOL” button for continuously and “TEMP” button 5 times.

2. Temperature Control of Refrigerator Compartment

INPUT	CONTROL OBJECT
PCB Control Panel "TEMP" Buttons R-sensor	PCB Control Panel LED COMPRESSOR, FAN

A. "TEMP" Button

1. Temperature control of Refrigerator compartment
2. 5 step mode of successive temperature mode
3. Initial mode by power input: step "3"
4. Temperature will be set if the button doesn't get pressed again within 5 sec.
 - Whenever pressing "TEMP" button, setting is repeated in the order of "3" → "4" → "5" → "1" → "2" (LED LAMP ON)

B. Temperature of Refrigerator Control

1. COMP and FAN will be controlled by the on/off condition of each mode.1
2. Temperature Difference of Refrigerator each step :

Temperature Step	"1"	"2"	"3"	"4"	"5"
Temp. Diff. of Each Step	2.0C	2.0C	2.0C	2.0C	2.0C

3. Temperature of Refrigerator at step "3" OFF point: is -1.4C
4. Refrigerator ON/OFF Temp. Difference: 1.7C

C. "S-COOL" MODE

1. Press S-COOL SWITCH and make S-COOL led lamp on.
2. COMP & FAN are on until R-sensor reaches to "Over Refrigeration OFF Point", -7C
3. After the reach of -7°C , STEP "5" mode continues.
4. When "S-COOL" MODE (Quick Refrigeration Mode) lasts for about 40 minutes, it returns to general operation mode.

D. Temperature of Freezer Control

-It will be only controlled by using "KNOB F LOUVER" in Freezer.

3. Defrost Mode																	
INPUT	CONTROL OBJECT																
Total COMP Work Time / COMP Working Rate Total Door Open Time / RT	Defrost Mode																
<p>Conditions of Defrost Mode</p> <p>A. When total operation time of compressor becomes: 6, 8, 10, 12 hours.</p> <ul style="list-style-type: none"> - any error mode-R1, D1, F3, C1, RT/S, Door SW error- happens. - or, running rate of COMP (per 2hrs of total operation time) is more than 80%. - or, total door open time is over 3 minutes. - or, ambient temperature (RT) is more than 40C. <p>B. Even if the above condition "A" is not satisfied,</p> <ul style="list-style-type: none"> - Defrost mode starts immediately when total operation time of COMP is 14hrs. - or, defrost mode starts immediately as long as total time (COMP on time + COMP off time) is 60 hrs. <p>Defrost Mode</p> <p>A. General Defrost Mode</p> <ul style="list-style-type: none"> - How to start: By conditions of defrost - Process : General operation- "PRE-COOL" - Defrost Heater on- Pause(10 min)-General operation ; PRE-COOL: When the defrost heater works, the temp. of freezer increases. So the COMP works for 25 min before defrost mode. - Limited Time of Defrost Heater ; 40 minutes: Heater turns off when "D SENSOR" is OPEN or SHORT. ; 60 minutes: Heater turns off after maximum 60 minutes. - Heater Off: When the temperature at "D SENSOR" is over 10C <table border="1" style="width: 100%; border-collapse: collapse; text-align: center;"> <thead> <tr> <th></th> <th>PRE-COOL</th> <th>Defrost</th> <th>Pause</th> </tr> </thead> <tbody> <tr> <td>Compressor</td> <td>ON</td> <td>OFF</td> <td>OFF</td> </tr> <tr> <td>Fan</td> <td>ON</td> <td>OFF</td> <td>OFF</td> </tr> <tr> <td>Defrost</td> <td>OFF</td> <td>ON</td> <td>OFF</td> </tr> </tbody> </table> <p>B. Forced Defrost Mode</p> <ul style="list-style-type: none"> - How to start: by press "TEMP" button for continuously and "S-COOL" button 5 times. - Process: same as General Defrost Mode except "PRE-COOL" ; Heater is supposed to be on Initial 30 seconds even though the temp. at "D SENSOR" is over 10C. (for TEST) - How to confirm: by press "S-COOL" button for continuously and "TEMP" button 5 times. And then, the mode displays. - Display : led lamps "3"& "S-COOL" on, "4" & "5" on/off continually 			PRE-COOL	Defrost	Pause	Compressor	ON	OFF	OFF	Fan	ON	OFF	OFF	Defrost	OFF	ON	OFF
	PRE-COOL	Defrost	Pause														
Compressor	ON	OFF	OFF														
Fan	ON	OFF	OFF														
Defrost	OFF	ON	OFF														

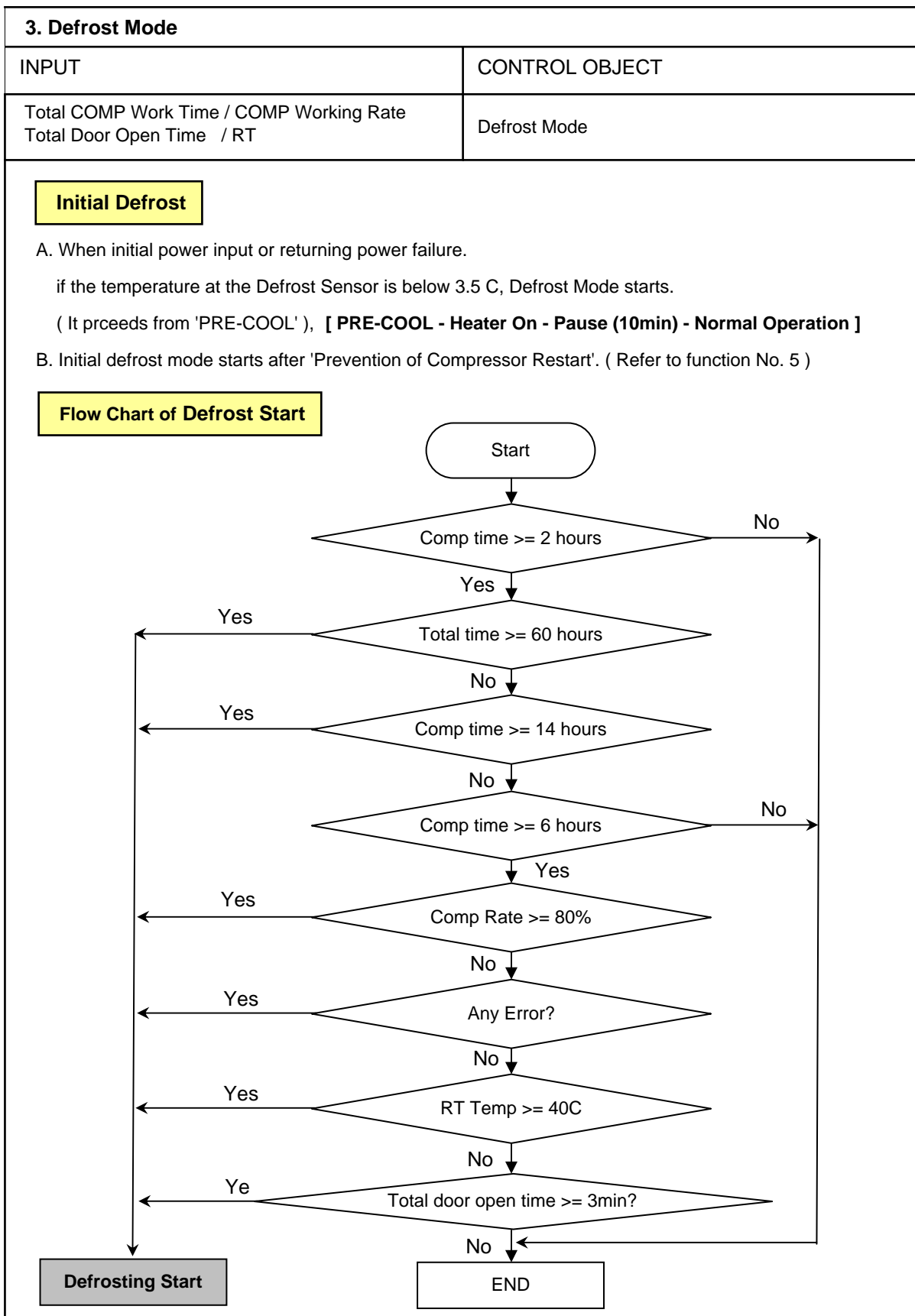

4. Function of Low Ambient Temperature (RT)	
INPUT	CONTROL OBJECT
RT	R-HTR COMP
<p>A. Condition of LOW RT</p> <ul style="list-style-type: none"> - LOW RT Period : RT sensor below 19C - When the temperature of RT sensor is over 20C, the system comes to be "General Operation Mode". - When the temp. of RT sensor is between 19°C to 20C, the system keeps the previous mode. <p>B. Control</p> <ul style="list-style-type: none"> - When Comp. is on, R-HTR is off. - When it passes 6 min after COMP is off, R- HTR is on. - COMP can't be on within 30 min after COMP is off. <ul style="list-style-type: none"> ; COMP doesn't work at the steps "Heater On" and "Pause" of "Defrost Mode". If COMP comes to be off for "Low Room Temp" in the steps, it seems to take over 30 minutes. - Change of "Prevention Time of COMP Restart" : <ul style="list-style-type: none"> If satisfy the following conditions simultaneously, the time changes 6 minutes. ; Accumulated running time of COMP passes 20 seconds after COMP is off. ; R-Sensor is more than 'ON' Point TEMP. - When it is not the mode of LOW ROOM TEMP <ul style="list-style-type: none"> or RT-Sensor is on ERROR (open or short), R-Sensor HTR is off. - Function of R-Heater Inspection: <ul style="list-style-type: none"> After initial power is on, R-HTR is on/off 5times for 10 seconds. - When Defrost Heater is on, R-Sensor Heater is on 	

5. Prevention of Compressor Restart	
INPUT	CONTROL OBJECT
	COMP
<p>COMP. doesn't work after COMP turns off even though R-sensor is on condition. (This is to protect comp.)</p> <p>A. General operation (Temp. at the RT sensor is over 20C): The COMP can't be on within 6 min.</p> <p>B. Operation of LOW RT (Temp. at the RT sensor is below 19C): The COMP can't be on within 30 min. (But the COMP can be on after 6min when the doors open more than 20 seconds.)</p>	

6. Buzzer Sound	
INPUT	CONTROL OBJECT
Control Buttons / Door Switch Initial Power Input	Buzzer
<p>A. Whenever "PCB Control Panel" button's pushed, the buzzer rings.</p> <p>B. After 2 minutes power's on, the buzzer rings 3 times.</p> <p>C. Time of Buzzer: Forced Defrost Mode (3 times), Short Circuit Test (1 time)</p> <p>D. When door opens, the buzzer rings every 1 minute for 5 minutes.</p>	

7. Time Reduction	
INPUT	CONTROL OBJECT
"FAST KEY"	Buzzer
<p>A. HOW TO REDUCE</p> <ul style="list-style-type: none"> - 1 min : Click FAST KEY one time on MAIN PCB. - 30 min : If you press FAST KEY continuously, you can reduce 30 minutes on each 2.5 seconds with buzzer. <p>B. Practice Use : Can be applied to reduce needless time on test. EX) function of stop for 6 min</p>	

8. Demonstration Function	
INPUT	CONTROL OBJECT
"TEMP" +"S-COOL" Buttons	Display Panel
<p>A. START : by pressing "TEMP" and "S-COOL" buttons for 5 seconds.</p> <p>B. CONTROL :</p> <ul style="list-style-type: none"> - All electronic compartments are off except "Display Panel". - When "DEMO" mode works, led lamps will be on as next steps. ["1" → "2" → "3" → "4" → "5" → "1"] <p>C. CANCEL :</p> <p>Push again "TEMP" and "S-COOL" buttons for 5 seconds at "DEMO", or turn off power and restart.</p>	

9. Control of R-sensor OFF Point	
INPUT	CONTROL OBJECT
"J1", "J2" On Main PCB	Control Resistance of R sensor OFF Point
<p>A. LOW COOLING OPTION (Weak Cooling)</p> <ul style="list-style-type: none"> - When the refrigeration of refrigerator is poor or weak though Fan and COMP are working continuously, the following actions are recommended for service. - Resistance (R47) : Default resistance (31.4Kohms) - Resistance (R45) : Cut the "J1" off to reduce basic resistance by 1.5°C. (2Kohms up) - Resistance (R42) : Cut the "J2" off additionally to reduce basic resistance by 1.5°C. (total 4Kohms up) <p>up)</p> <p>R47 = R-SENSOR OFF point R47 + R45 = R-SENSOR OFF point - 1.5C R47 + R45 + R42 = R-SENSOR OFF point - 3C</p>	

9. Control of R-sensor OFF Point

INPUT	CONTROL OBJECT
"J3" & "R30" On Main PCB	Input voltage of MICOM R-sensor ON/OFF Point

B. Prevention OPTION of EXCESSIVE OR LOW COOLING.

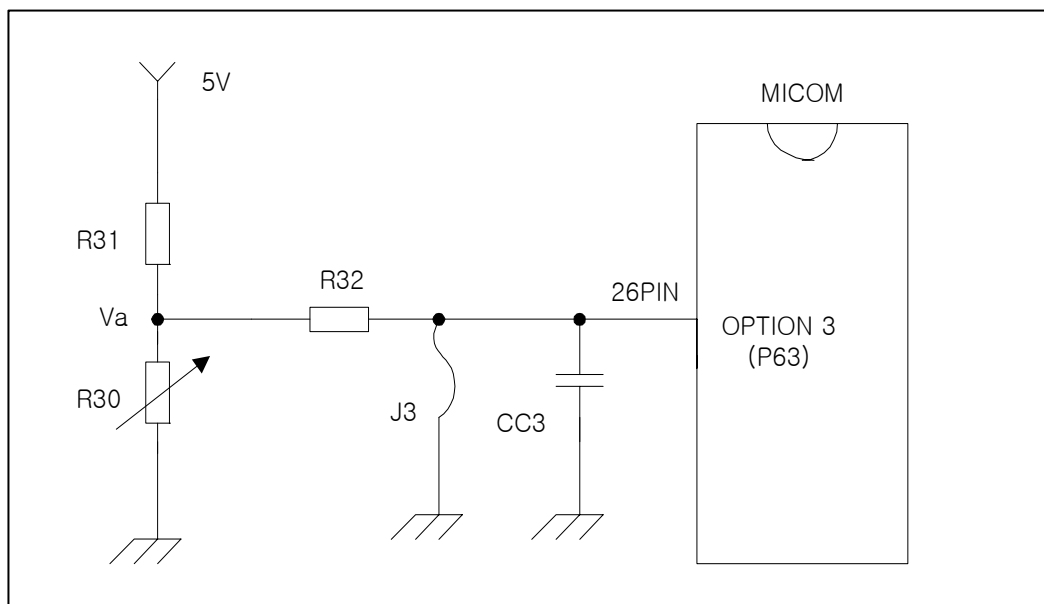

; The input voltage of MICOM and R-Sensor ON/OFF point by changing J3 & R30.

NO	TEMP. STEP "3"		APPLICATION (MAIN PCB)	MICOM INPUT VOL.	Compared to "STANDARD"
	ON	OFF			
1	0.3C	-1.4C	-	0V	STANDARD
2	-1.4C	-3.1C	J3(CUT), R30 (680ohm)	0.3V	-1.7C
3	-1.1C	-2.8C	J3(CUT), R30 (2kohm)	0.8V	-1.4C
4	-0.8C	-2.5C	J3(CUT), R30 (2.8kohm)	1.1V	-1.1C
5	-0.4C	-2.1C	J3(CUT), R30 (3.92kohm)	1.4V	-0.7C
6	-0.1C	-1.8C	J3(CUT), R30 (4.87kohm)	1.6V	-0.4C
7	0.7C	-1.0C	J3(CUT), R30 (6.65kohm)	2.0V	+0.4C
8	1.0C	-0.7C	J3(CUT), R30 (10kohm)	2.5V	+0.7C
9	1.4C	-0.3C	J3(CUT), R30 (19.6kohm)	3.3V	+1.1C
10	1.7C	0C	J3(CUT), R30 (40.2kohm)	4V	+1.4C
11	2.0C	0.3C	J3(CUT), R30(NO USE)	5V	+1.7C

9. Control of R-sensor OFF Point	
INPUT	CONTROL OBJECT
"J4" & "R23" On Main PCB	Input voltage of MICOM R-sensor ON/OFF Point

C. Changing Difference between R-sensor "On" point and "Off" point.

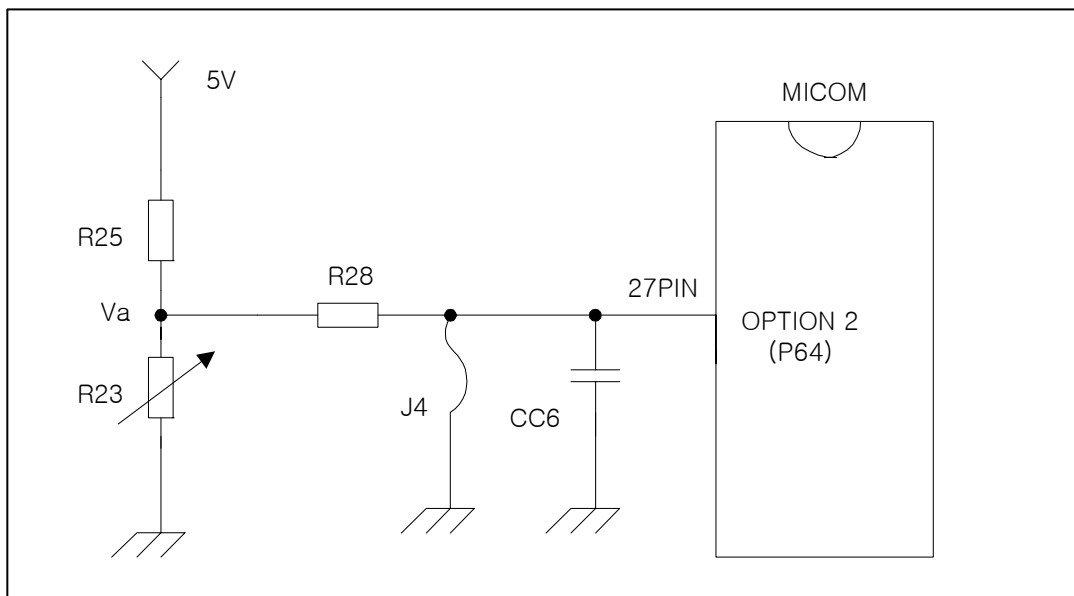

; The input voltage of MICOM and R-Sensor ON/OFF DIFF. by changing J4 & R23.

NO	TEMP. STEP "3"		APPLICATION (MAIN PCB)	MICOM INPUT VOL.	DIFFERENCE OF ON/OFF POINT
	ON	OFF			
1	0.3C	-1.4C	-	0V	1.7C
2	-1.0C	-1.4C	J4(CUT), R23 (680ohm)	0.3V	0.4C
3	-0.7C	-1.4C	J4(CUT), R23 (2kohm)	0.8V	0..7C
4	-0.3C	-1.4C	J4(CUT), R23 (2.8kohm)	1.1V	1.1C
5	0C	-1.C	J4(CUT), R23 (3.92kohm)	1.4V	1.4C
6	0.7C	-1.4C	J4(CUT), R23 (4.87kohm)	1.6V	2.1C
7	1.1C	-1.4C	J4(CUT), R23 (6.65kohm)	2.0V	2.5C
8	1.4C	-1.4C	J4(CUT), R23 (10kohm)	2.5V	2.8C
9	1.8C	-1.4C	J4(CUT), R23 (19.6kohm)	3.3V	3.2C
10	2.1C	-1.4C	J4(CUT), R23 (40.2kohm)	4V	3.5C
11	2.5C	-1.4C	J4(CUT), R23(NO USE)	5V	3.9C

10. Error Display											
INPUT	CONTROL OBJECT										
PCB Control Panel Buttons / Door	LED Lamp										
<p>- ERROR DISPLAY</p> <ul style="list-style-type: none"> - To confirm error happens or not, push "S-COOL" button for continuously and "TEMP" button 5 times. - To stop the Error Display Set, push "TEMP" button 1 times, or wait 4 minutes. - After operations back to normal, the displays come to be reset. <p>A. R1 ERROR (It happens when R-Sensor is OPEN or SHORT)</p> <ul style="list-style-type: none"> - DISPLAY : STEP "3" LED is on & off continually. - CONTROL : ; Controlled by the following condition of RT ; When "RT ERROR" happens at the same time, "COMP. ON/OFF Operating Time" is 16min/24min. (Unit : min) <table border="1"> <thead> <tr> <th>RT sensor TEMP</th> <th>~13C</th> <th>~19C</th> <th>~29C</th> <th>29C ~</th> </tr> </thead> <tbody> <tr> <td>COMP. Operating TIME (ON/OFF)</td> <td>6/34</td> <td>10/30</td> <td>16/24</td> <td>20/20</td> </tr> </tbody> </table> <ul style="list-style-type: none"> - CANCEL : when R-Sensor is working normally. <p>B. RT ERROR (It happens when RT-Sensor is OPEN or SHORT)</p> <ul style="list-style-type: none"> - DISPLAY : STEP "2" LED is on & off continually. - CONTROL : Delete the conditions of "RT-sensor Control" and operate normally. - CANCEL : when RT-Sensor is working normally. <p>C. D1 ERROR (It happens when D-Sensor is OPEN or SHORT)</p> <ul style="list-style-type: none"> - DISPLAY : STEP "1" LED is on & off continually. - CONTROL : Return to next limit defrost time (40 min) - CANCEL : when D-Sensor is working normally. <p>D. DR ERROR (It happens when the system senses door opens more than 1 hour.)</p> <ul style="list-style-type: none"> - DISPLAY : STEP "2", "3" LED Lamps are on & off continually. - CONTROL : Deletion of function related door switch sensing - If door switch (open & close) is sensed, the error is terminated automatically <p>E. C1 ERROR (When D-Sensor is more than -5C, Comp operates over 3 hrs)</p> <ul style="list-style-type: none"> - DISPLAY : STEP "1" & "3" LED Lamps are on & off continually. - CONTROL : The system is normally operating - CANCEL : When Comp is off, D-Sensor is less than -5C. <p>F. F3 ERROR Return to next step after max defrost time. (60 minutes)</p> <ol style="list-style-type: none"> 6.1- DISPLAY : STEP "1" & "2" LED Lamps are on & off continually. 6.2- CONTROL : At Defrost Mode, Deletion of "PRE-COOL" Mode. 6.3- CANCEL : Completion of defrost returned by D-Sensor. 		RT sensor TEMP	~13C	~19C	~29C	29C ~	COMP. Operating TIME (ON/OFF)	6/34	10/30	16/24	20/20
RT sensor TEMP	~13C	~19C	~29C	29C ~							
COMP. Operating TIME (ON/OFF)	6/34	10/30	16/24	20/20							
<p>- If the appliance is normal (no error), just '4' and '5' LED flicker in Error Mode.</p>											

CODE	LED	ERROR
R1	"3"	R sensor
RT	"2"	RT sensor
D1	"1"	D sensor
DR	"2", "3"	DR Switch
C1	"1", "3"	Cycle
F3	"1", "2"	Defrost
<p>- To Confirm Errors: Push "S-COOL" for continuously and "TEMP" button 5 times.</p> <p>- The Priorities of Error : R1→RT→D1→DR→C1→F3</p>		

flicker



11. Function Key Summary Table

MODE	Action	Button / Remark
Forced Defrost Mode	How to enter the Mode	Temp + S-Cool button 5 times
	How to terminate	After Mode ends (about 1 hour)
	Display	'3', 'S-Cool' LED ON (In Error Mode)
Pull Down Mode	How to enter the Mode	Temp button 30 times
	How to terminate	After Mode ends (about 30 hour)
	Display	'1', 'S-Cool' LED ON (In Error Mode)
Error Display	How to enter the Mode	S-Cool + Temp button 5 times
	How to terminate	emp button 1 time or after 4 minutes
	Display	'4', '5' LED flicker (When no error happens)
Demo Mode	How to enter the Mode	Temp + S-Cool button for 5 seconds
	How to terminate	Temp + S-Cool button for 5 seconds
	Display	LED Lamps will be on as next steps. ('1' - '2' - '3' - '4' - '5' - '1')



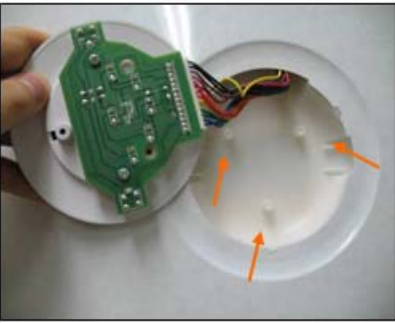

In Error Mode, you can find the current mode (What mode is operating) and what kinds of Error happen.

1. Front PCB





No	Procedure	No	Procedure
1	 <p><i>Inuput a cutter sleeve between Window FCP and Panel F control. (Be careful not to scratch the surface.)</i></p>	3	 <p><i>Unscrew Panel F Control.</i></p>
2	 <p><i>Lift up the Window FCP. (Input cutterr deeply to lift up easily.)</i></p>	4	 <p><i>Pull up the Panel and disconnect the wire connector.</i></p>

2. Door Switch

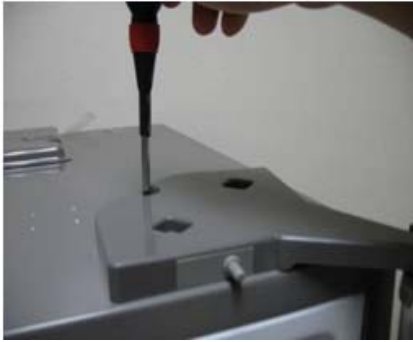

2-1. RF-420N.. Models

No	Procedure	No	Procedure
1	 <p><i>Inuput a thin driver in the right part as above picture. And lift up to remove.</i></p>	2	 <p><i>Move switch to left side. Disconnect the wire housing.</i></p>





2-2. RN-420N.. Models

No	Procedure	No	Procedure
1	 <p>Remove top cover hinge screw with (+) driver.</p>	3	 <p>Remove the Door Switch from the cover hinge.</p>
2	 <p>Separate the Cover hinge by using driver. Be careful not to scratch the cabinet surface.</p>	4	 <p>Disconnect door switch connector.</p>

3. Multi-Duct As (In Freshfood Compartment)

No	Procedure	No	Procedure
1	 <p>Remove screw cap with flat driver</p>	3	
2	 <p>Unscrew 2 points</p>		

4. Freezer Louver As

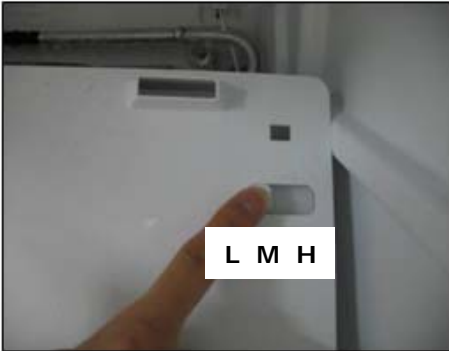
No	Procedure	No	Procedure
1	 <p>Unscrew the fixing screw to remove the Louver F As</p>	4	 <p>Remove 3 screws in order to disassemble Louver F As.</p>
2	 <p>Remove the Louver F As pulling the top side.</p>	5	 <p>When disassembling check the Knob position.</p>
3	 <p>Disconnect Fan motor wire housing.</p>	6	 <p>Default position is 'M'</p>









How to change Door opening Dircition (Reversible)

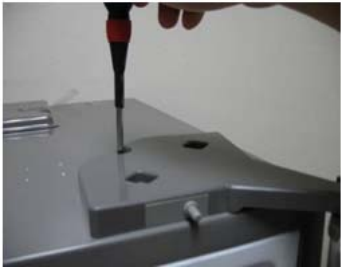
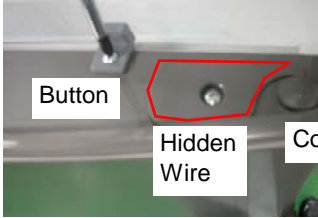





Below process is for RN-420N (Refrigerant type : R-600a) models.

Some parts are differ to RF-420N models. (Hinge Cover, Door Switch, Wire Harness and Button Door Switch.)

When you change door opening direction (RF-420N models), please refer page 20 (Door switch Disassemblby) and below.

No	Procedure	No	Procedure
1	 <p>Remove top cover hinge screw with (+) driver.</p>	6	 <p>Button Hidden Wire Cover Bushing</p> <p>After hiding door wire harness, remove the button Door Switch and Cover Bushing.</p>
2	 <p>Separate the Cover hinge by using driver.</p>	7	 <p>After unscrewing the Cover Hinge Harness *T *L, disclose the door wire harness.</p>
3	 <p>Remove the Door Switch from the cover hinge.</p>	8	 <p>Stopper</p> <p>Reassemble the cover and button door switch. And also assemble the door stopper to opposite side. (Which is located the Door under Cap.)</p>
4	 <p>Disconnect all wire connector and hinge.</p>	9	 <p>Freezer Door</p> <p>Remove the Middle Hinge. Assemble Cover Bushing & Stopper to the opposite.</p>
5	 <p>Refrigerator Door Cap</p> <p>Unscrew the Cover Hinge Harness *T *R and hide the door wire harness.</p>	10	 <p>a. Change the location (screw & division hinge cap)</p> <p>b. Change the unnder hinge location to the opposite.</p>

How to change Door opening Dircetion (Reversible)

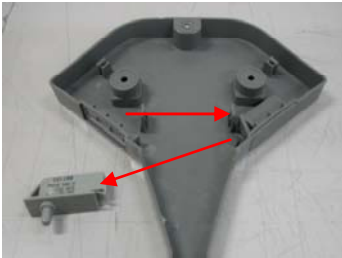
No	Procedure	No	Procedure
11	 <p>Screw the middle hinge to fix the Freezer Door. (Washer should be up.)</p>	14	 <p>Connect the wire harness to door switch. (Be careful the dircetion.)</p>
12	 <p>Also assemble wire cover on the top plate. (On the right)</p>	15	 <p>Assemble Door and hing cover.</p>
13	 <p>Change the plate position and separate door switch.</p>		

1. Safety Warning (R-600a Refrigerant Models Only, RN-420N..)











This appliance contains a certain amount of isobutane refrigerant (R600a) a natural gas with high environmental compatibility that is, however, also combustible.

When transporting and installing the appliance, care should be taken to ensure that no parts of the refrigerating circuit are damaged.

Refrigerant squirting out of the pipes could ignite or cause an eye injury. If a leak is detected, avoid any naked flames or potential sources of ignition and air the room in which appliance is standing for several minutes.

- In order to avoid the creation of a flammable gas-air mixture if a leak in the refrigerating circuit occurs, the size of the room in which the appliance may be sited depends on the amount of refrigerant used. The room must be 1m³ in size for every 8g of R600a refrigerant inside the appliance. The amount of refrigerant is shown on the identification plate inside the appliance.
- Never start up an appliance showing any signs of damage. If in doubt, consult your dealer.



2. Tools



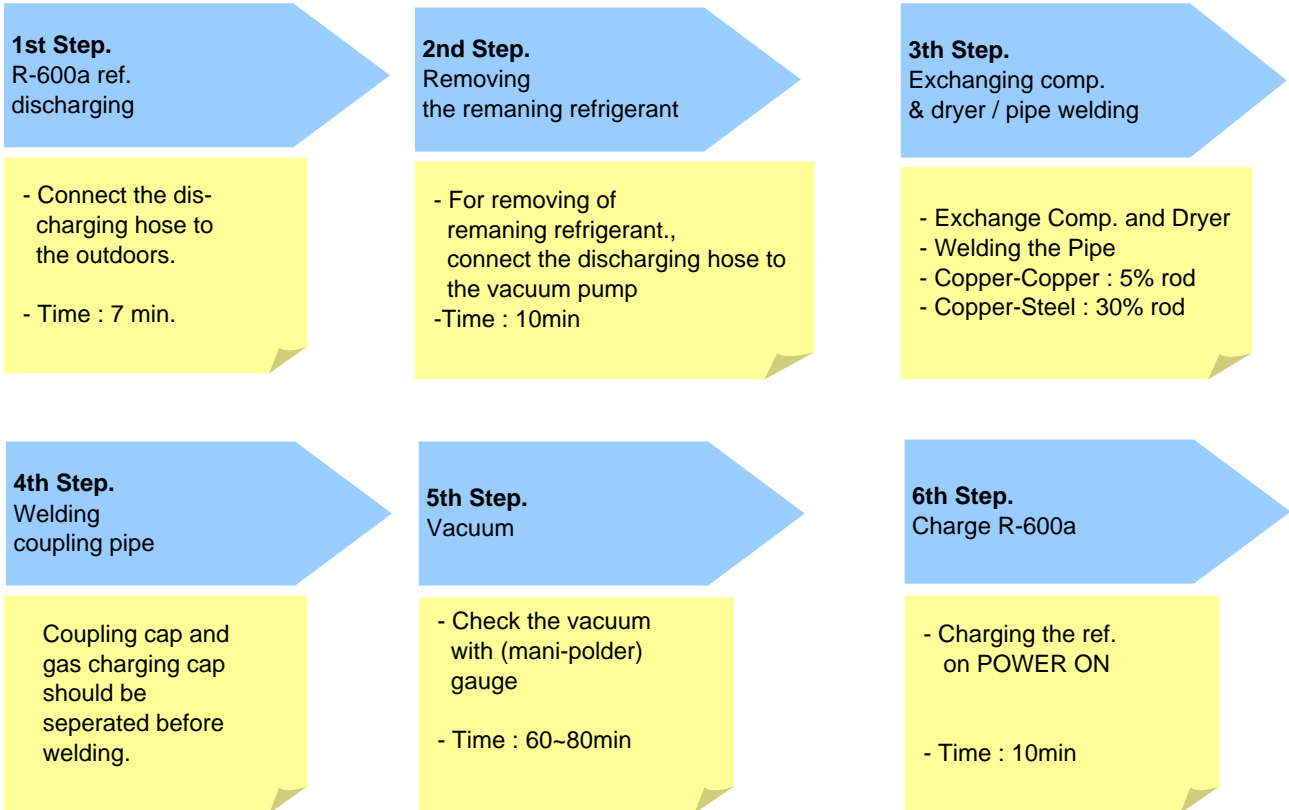

<p>1. R-600a ref. Can</p> 	<p>2. Can adapter</p> 	<p>3. Pinch Plier</p> 
<p>4. Ref. discharging hose</p> 	<p>5. Vacuum pump</p> 	<p>6. Welder</p> 
<p>7. Coupling Pipe</p> 	<p>8. Leakage Tester</p> 	<p>9. Electronic-scale</p> 



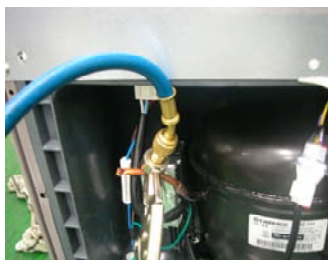

3. Process Summary

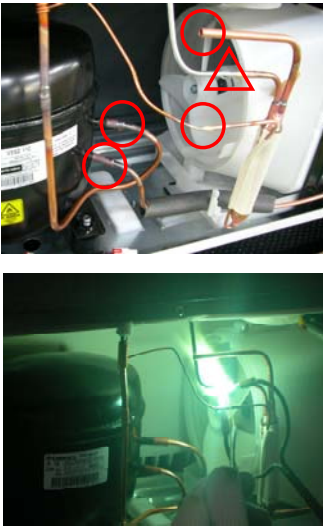





4. In Detail Precess

NO.	SVC process	Image	Details
1	Connecting the pinch-plier & discharging hose		<ol style="list-style-type: none"> 1. Connect the discharging hose to the pinch-plier 2. The outlet of discharging hose should be placed to the outdoor(window)
2	Fixing the pinch-plier & charging pipe		<ol style="list-style-type: none"> 1. Fix the pinch-plier to the compressor charging pipe. 2. Pinch-plier should not be moving freely. ※ If that is moving freely, it would cause fire/explosion as leakage gas in the room.
3	Discharging the R-600a ref.		<ol style="list-style-type: none"> 1. Discharge the R-600a ref. to outdoor. [Befor connecting the vacuum pump] ※ It should have enough time more than 7 minutes to discharge.

NO.	SVC process	Image	Details
4	Removing the remaining ref.		<p>1. And then, connect the vacuum pump to the outlet of discharging hose</p> <p>※ Vacuum pump should be placed at the outdoor where is able to clear air easily.</p> <p>※ It should have enough time more than 10 minutes to discharge.</p>
5	Removing the pinch-plier & pipe		<p>1. Disassemble the each pipe (Del-pipe, Suc-pipe, Capi-pipe, Dryer & Hot-pipe)</p> <p>※ Caution ; A part is easily damaged by flame so that disassembly should be done carefully.</p>
6	Exchanging comp & dryer		<p>1. Change the comp. & dryer.</p> <p>※ You should check the comp. spec. and assemble correctly.</p>
7	Welding		<p>1. Weld the each pipe.</p> <p>※ ○ Copper-Copper welding - 5% rod △ Copper-Steel welding - 30% rod</p>
8	Disassembly of charging valve (Coupling pipe)		<p>1. Decap the couplig pipe cap and disassemble the vlave ass'y.</p> <p>※ If you don't disassemble, the coupling rubber would be melted.</p>

NO.	SVC process	Image	Details
9	Coupling pipe welding		<p>1. Weld after inserting the coupling pipe to the compressor.</p> <p>※ Use the wet cloth for preventing the other part of machinery-room from damage.</p>
10	Valve reas's'y & guage connecting		<p>1. Reassemble the valve ass'y with coupling pipe to clockwise.</p> <p>2. Connect the blue hose of the guage to the coupling pipe and the yellow hose to the vacuum pump.</p> <p>3. Open the blue guage lever and start the vacuum pump</p>
11	Vacuum		<p>1. Be vacuumed the cycle with pump.</p> <p>※ Time : 60~80min</p> <p>=> If the vacuum time is less than 60min, ref. COP & air coolong would be weak.</p>
12	Check		<p>1. Check the guage : -76_{cm}Hg</p> <p>※ If the cycle is not vacuumed, it would be leak.</p>
13	Adjusting the amounts of refrigerants (R-600a can)		<p>1. Check the amounts of R-600a can with scale and discharge the surplus ref.</p> <p>※ Discharging is surely done at the outdoor where is able to clear air.</p> <p>※ Tip of adjusting.</p> <ul style="list-style-type: none"> - Can total weight :160g(Can 75g+Ref. 85g) - Adapter : 145g <p>=> Total : 305g</p> <ul style="list-style-type: none"> - The amounts of charging : 79g <p>=> Discharging : 6g => Total : 299g</p>

NO.	SVC process	Image	Details
14	Connecting of coupling pipe & adapta		<p>1. Conect can adapter to the coupling pipe. 2. Charge the ref. with open lever slowly.</p> <p>※ Refrigerant should never leak in the room.</p>
15	Charging		<p>1. On the power of refrigerator and then start to charge the ref. (10min)</p> <p>※ Charge the ref. until going out the water vapour condensing on the can outlet.</p>
16	Leakage Test		<p>1. Check the leakage.</p> <p>※ You must rework from Step.1 when the leakage is detected.</p>
17	Finish		<p>1. Clean and clear around the machinery room when the service is finished. 2. Assemble the machinery room cover.</p>

Cabinet / Evaporator / Compressor Compartment

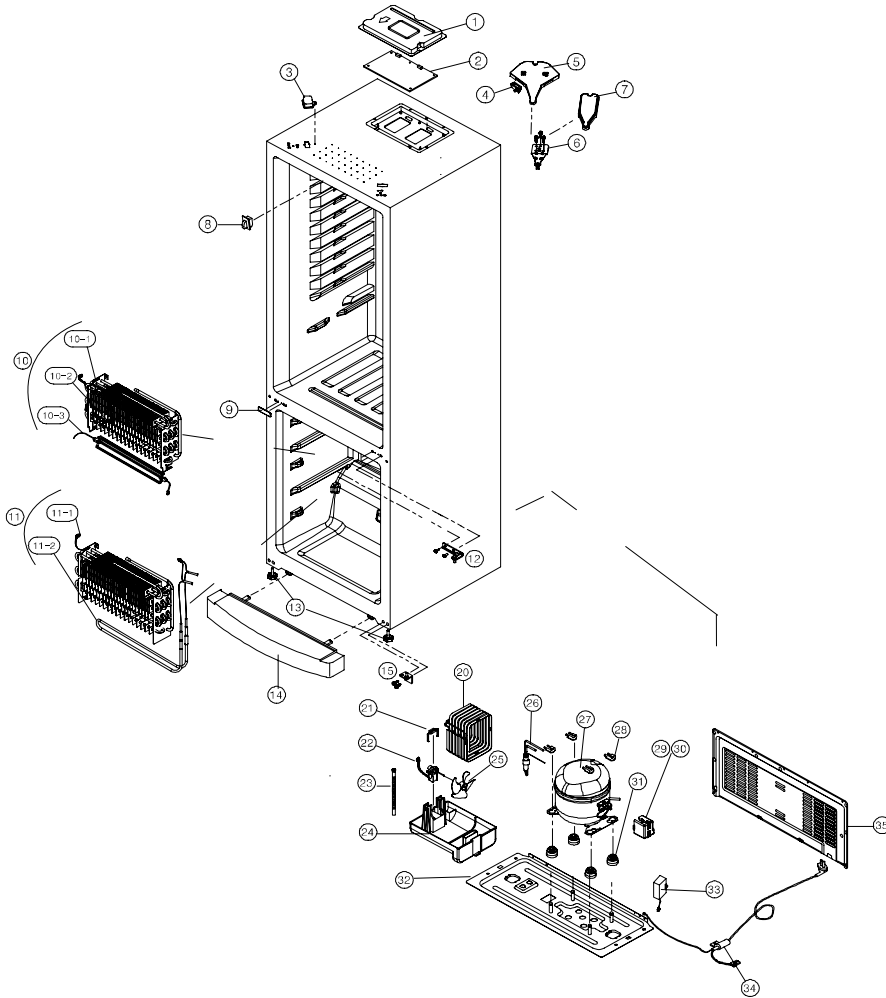

NO	PART-CODE	PART NAME	SPEC.	Q'ty	
				RF-430N	RN-430N
1	3001416620	COVER M/PCB BOX AS	COLOR DEPENDENT	1	1
2	30143G1060	PCB MAIN AS	V-LAZER (RFP-340)	1	x
2	30143G1070	PCB MAIN AS	V-LAZER (RFP-340 R600A)	x	1
3	3001412220	COVER CAB HRNS	COLOR DEPENDENT	1	1
4	3018125601	SWITCH H/BAR DR AS	COLOR DEPENDENT	x	1
5	3001427720	COVER *T HI AS	COLOR DEPENDENT	x	1
6	3012929000	HINGE *T AS	RFP-340	1	x
7	3001411920	COVER *T HI	COLOR DEPENDENT	1	x
8	3018120200	SWITCH DR AS	83430-109-19(NO.411260025)	1	x
9	3010937710	CAP DV HI HOLE *M	COLOR DEPENDENT	1	1
10	3017065200	EVA AS	RFP-340	1	x
10-1	3012764100	HARNES D SENS	RFP-340(NBC-K43-24)	1	x
10-2	3017202800	FUSE TEMP AS	SW-105T(77)	1	x
10-3	3012822000	HEATER D AS	AC230V, 180W	1	x
11	3017068200	EVA AS	RFP-341	x	1
11-1	3012769400	HARNES D SENS	PBN-43	x	1
11-2	3012823000	HEATER SHEATH AS	RFP-341	x	1
12	3012928900	HINGE *M AS	RFP-340	1	1
13	3012105101	FOOT ADJ AS	PP(BLACK)	2	2
14	3001415620	COVER CAB BRKT AS	COLOR DEPENDENT	1	1
15	3012929100	HINGE *U AS	RFP-340	1	1
20	3014469600	PIPE WICON AS	RFP-340	1	1
21	3010102100	ABSORBER C MOTR	NR FRB-5350NT	1	1
22	3015918110	MOTOR C FAN	S6112CEC01	1	1
23	3012532000	GUIDE DRN	GA, T0.4 AL	1	1
24	3011122800	CASE VAPORI AS	.	1	1
25	3011802700	FAN AS	FAN(OD110)+CLAMP	1	1
26	3016808900	DRYER AS	RFM-340 OD19.05 V-LAZER	1	1
27	3956158K50	COMPRESSOR	YX58LHP5 220V-50HZ	1	x
27	3956141250	COMPRESSOR	MD4A1Q-L1U 220/240V-50HZ	x	1
28	3016002500	SPECIAL WASHER	SK-5 T0.8	3	3
29	3018131810	SWITCH P RELAY AS	RFP-341	1	x
29	3018132900	SWITCH P RELAY AS	RFP-341 189PHB,S330	x	1
30	3811400503	COVER RELAY	PP(SW5101SW) 40*54*45*T2.0	1	x
30	3811402100	COVER RELAY	DS3-3NORYL S/S	x	1
31	3010101600	ABSORBER COMP	NBR	4	x
31	3010101480	ABSORBER COMP AS	FRU-541D	x	4
32	3010349301	BASE COMP AS	RFP-340(BASE COMP/T1.0)	1	1
33	3016401160	CAPACITOR RUN	350VAC 4UF(WIRE)	1	x
33	3016401920	CAPACITOR RUN	400VAC 5UF(WIRE)	x	1
34	3011349300	CORD POWER AS	16A , 250V	1	1
35	3001414000	COVER MACH RM AS	RFP-340	1	1

Please check the color, some parts code color dependent.

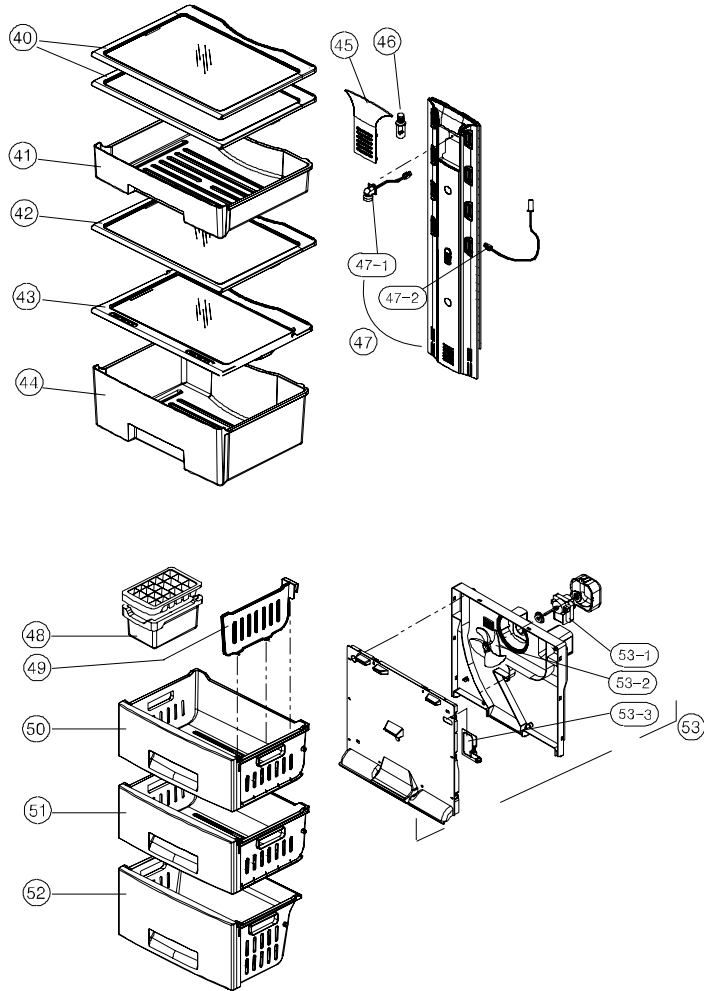

NO	PART-CODE	PART NAME	SPEC.	Q'ty	
				RF-430N	RN-430N
40	3017847100	SHELF R INSERT AS	.	2	2
41	3010669900	BRACKET MULTI	GPPS	1	1
42	3017847100	SHELF R INSERT AS	.	1	1
43	3001413300	COVER V/CASE AS	COVER+KNOB	1	1
44	3011197500	CASE VEGETB	GPPS	1	1
45	3015513100	WINDOW R	MIPS	1	1
46	3013603000	LAMP	240V,25W(BLUE)	1	1
47	3001413500	COVER MULTI DUCT AS	RFP-340	1	1
47-1	3017903900	SOCKET LAMP AS	AC250V	1	1
47-2	3012764600	HARNESS R SENS	RFP-340(NBC-K43-D21)	1	1
48	4010G56012	CASE ICING	PP(J-360)	1	1
49	3012535500	GUIDE F CASE	PP	1	1
50	3011197900	CASE F B AS	CASE+WINDOW	1	1
51	3011197900	CASE F B AS	CASE+WINDOW	1	1
52	3011198000	CASE F C AS	CASE+WINDOW	1	1
53	3018927900	LOUVER F AS	RFP-341	1	1
53-1	3015918210	MOTOR F FAN	S6112CDF03	1	1
53-2	3011835900	FAN	OD100,SHAFT OD3.17	1	1
53-3	3013413500	KNOB F CONTL	PP	1	1

Some parts can be changed for improving without notice.

Date	Note

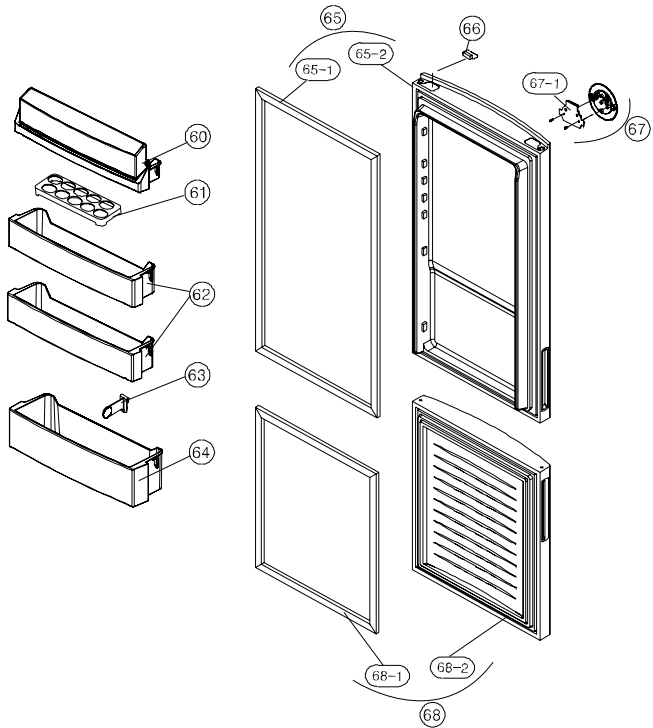

NO	PART-CODE	PART NAME	SPEC.	Q'ty	
				RF-430N	RN-430N
60	3019056100	POCKET DAIRY AS	RFP-341	1	1
61	3011190800	CASE EGG TRAY	GPPS	1	1
62	3019055900	POCKET BOTL	GPPS	2	2
63	3012532100	GUIDE BOTL POKT	PP	1	1
64	3019055800	POCKET JUMBO	GPPS	1	1
65	3000077800	ASSY R DR	RFP-341(WHITE)	1	1
	3000077820		RFP-341(SILVER)		
	3000077840		RFP-341(T/SILVER)		
65-1	3012321200	GASKET R DR AS	RFP-340	1	1
65-2	3011783300	DOOR R PRE AS	RFM-341(TWHITE)	1	1
	3011783320		RFM-341(SILVER)		
	3011783340		RFM-341(T/SILVER)		
66	3016307700	BUTTON DR SW	ABS	x	1
67	3014240140	PANEL F PCB AS	RFP-341(T/SILVER)	1	1
67-1	30143G1160	PCB FRONT AS	V-LAZER FRONT AS (RFP-340)	1	1
68	3000077500	ASSY F DR	RFP-341(TWHITE)	1	1
	3000077510		RFP-341(SILVER)		
	3000077520		RFP-341(T/SILVER)		
68-1	3011783220	DOOR F PRE AS	RFP-341(T/SILVER)	1	1
	3011783220		RFP-341(T/SILVER)		
	3011783220		RFP-341(T/SILVER)		
68-2	3012321100	GASKET F DR AS	RFP-340	1	1

Some parts can be changed for improving without notice.
Please check the color, some parts code color dependent.

Date	Note