

EXPLODED VIEWS

Cabinet

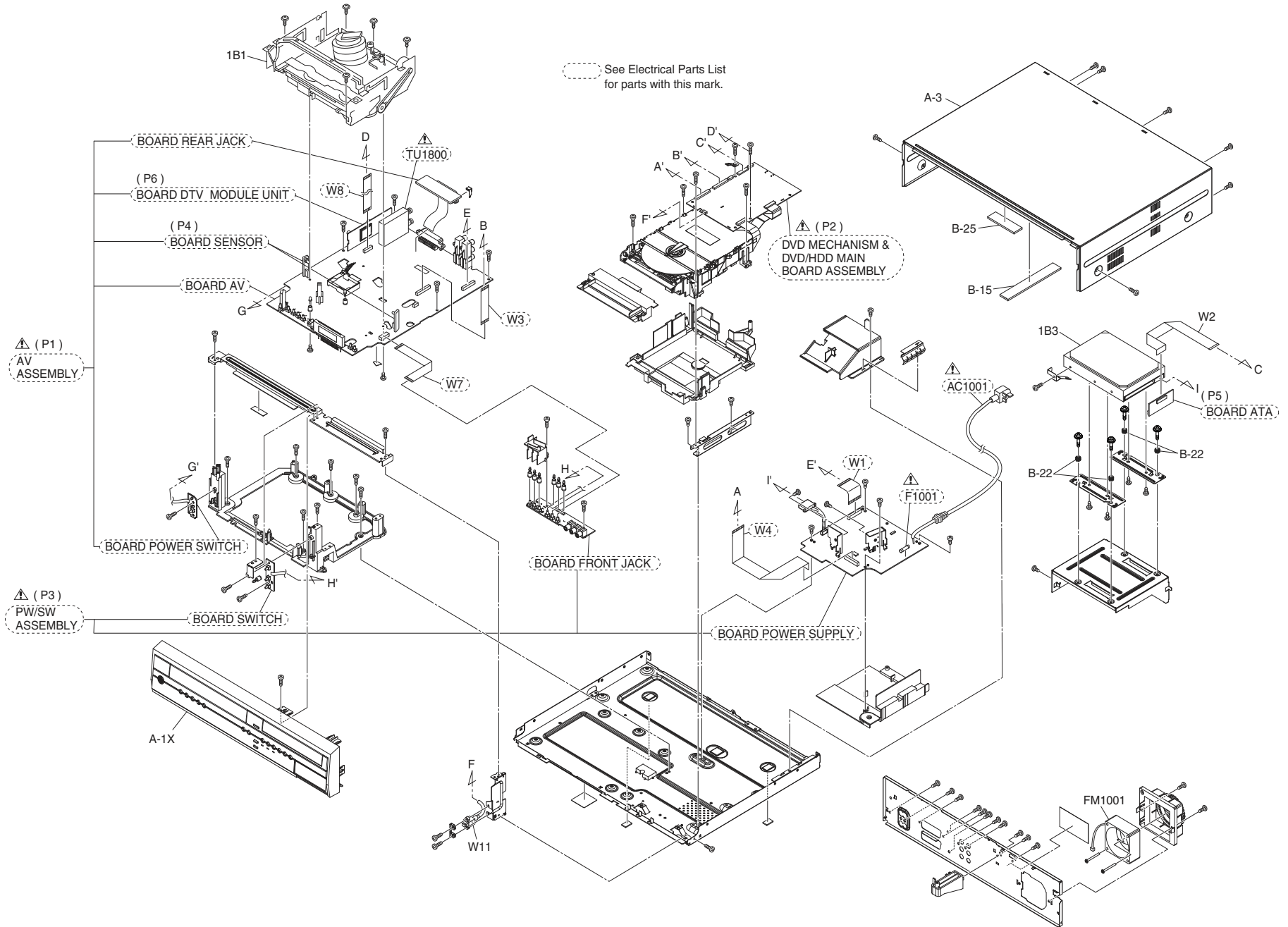

(P1) AV ASSEMBLY

(P4) BOARD SENSOR

(P6) BOARD DTV MODULE UNIT

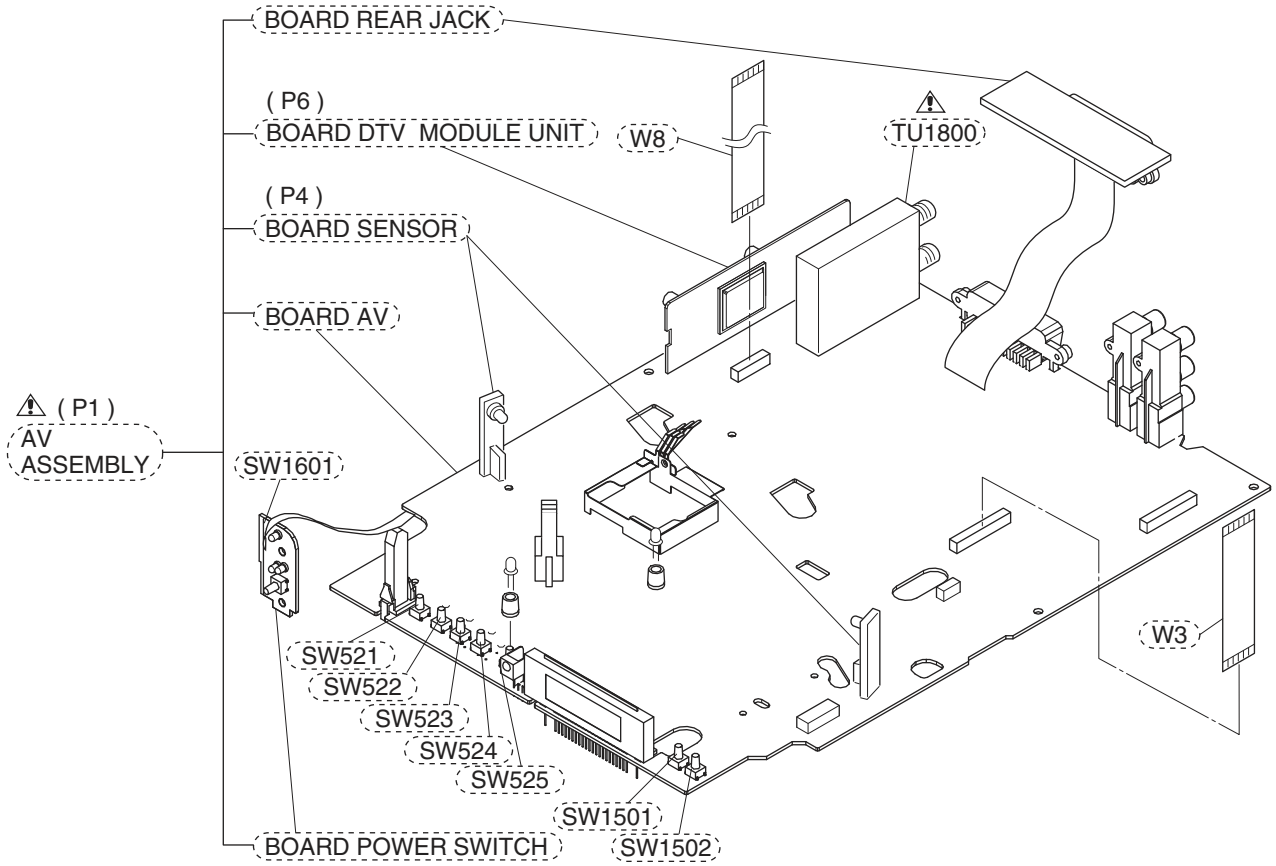

(P3) PW/SW ASSEMBLY

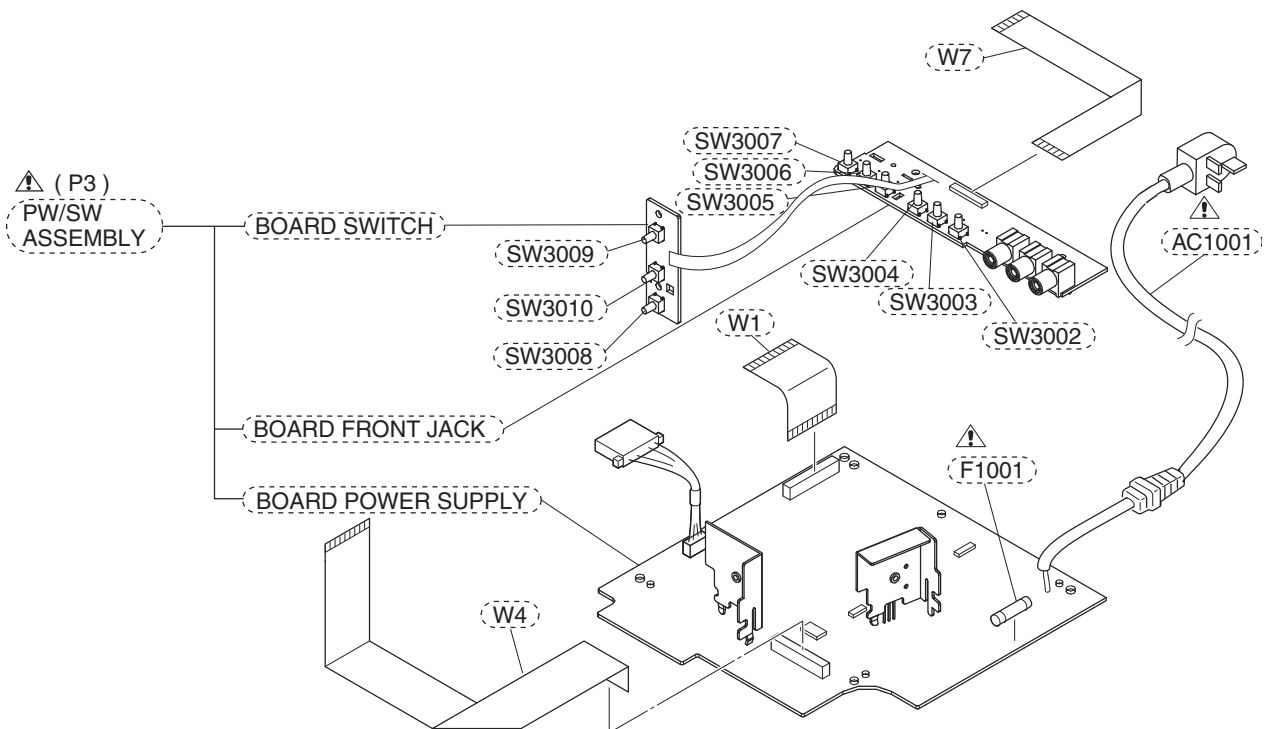

(P2) DVD MECHANISM & DVD/HDD MAIN BOARD ASSEMBLY

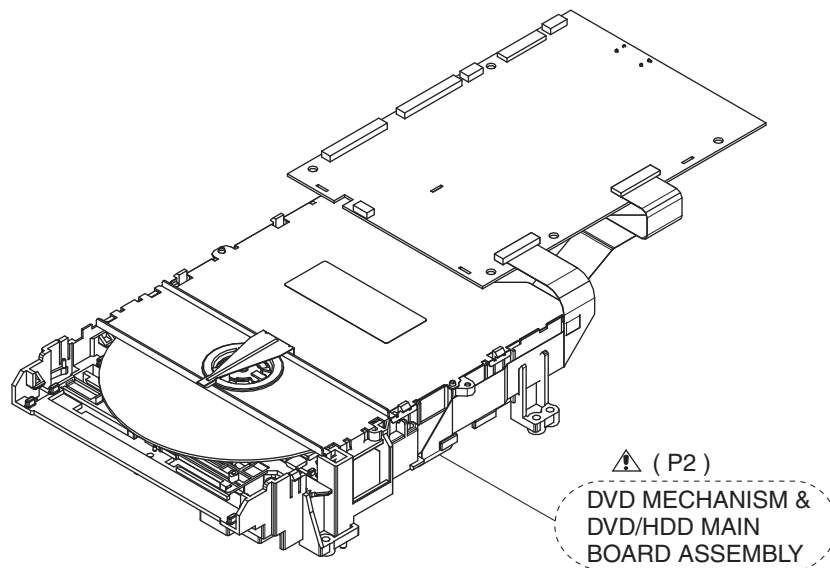

(P5) BOARD ATA

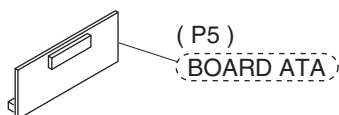

Packing

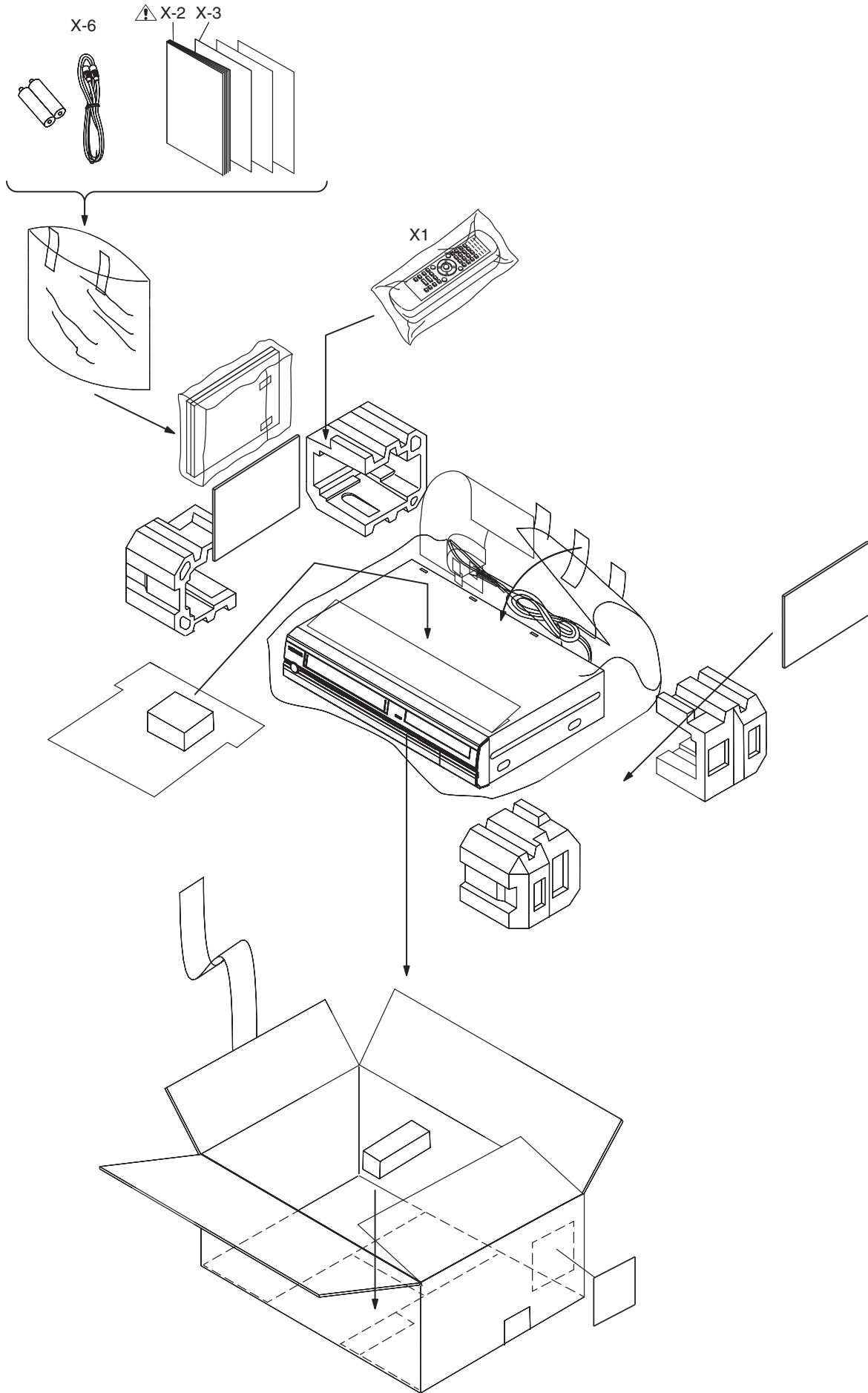

Lower Side

Upper Side



MECHANICAL PARTS LIST

PRODUCT SAFETY NOTE: Products marked with a  have special characteristics important to safety. Before replacing any of these components, read carefully the product safety notice in this service manual. Don't degrade the safety of the product through improper servicing.

	Location No.	TSB P/N	Reference No.	Description
	A-1X	79104033	1VM121779	PANEL FRONT E3NG1BD
	A-3	79103704	1VM323985	COVER TOP(H-BLACK) E3HE0JD
	1B1	79103354	N25E1FL	DECK ASSEMBLY CZD014/ VM25E0
	1B3	79103626	UHDD160WG003	HARD DISK DRIVE 160GB WD1600AVBB-63SYA0
	B-15	79103705	1VM427939	RUBBER CUSHION(TOP BOARD ASSEMBLY E3NG0FD)
	B-22	79103345	1VM422863	HDD RUBBER E4350JD
	B-25	79103702	0VM416664C	CUSHION RUBBER E9400UD
	FM1001	79103715	MMEZR12XNR04	MOTOR DC FAN 2D65BK100230
	W2	79103722	WX1E3N00-002	WIRE ASSEMBLY 40PIN FFC WX1E3N00-002
	W11	79103720	WPZ0331WJ001	IEEE1394 CABLE JE-1710-9
ACCESSORIES				
	X1	79104040	NB344BD	REMOTE CONTROL UNIT NB344BD
	X-2	79104034	1VMN25262	OWNERS MANUAL E3NG1BD
	X-3	79104035	1VMN25263	QUICK GUIDE E3NG1BD
	X-6	79103090	WPZ0122LG001	RF CORD PAL 1.2M

ELECTRICAL PARTS LIST

PRODUCT SAFETY NOTE: Products marked with a \triangle have special characteristics important to safety. Before replacing any of these components, read carefully the product safety notice in this service manual. Don't degrade the safety of the product through improper servicing.

NOTES:

- Parts that are not assigned part numbers (-----) are not available.
- Tolerance of Capacitors and Resistors are noted with the following symbols.

C..... \pm 0.25% D..... \pm 0.5% F..... \pm 1%
 G..... \pm 2% J..... \pm 5% K..... \pm 10%
 M..... \pm 20% N..... \pm 30% Z.....+80/-20%

DVD MECHANISM & DVD/HDD MAIN BOARD ASSEMBLY

\triangle	Location No.	TSB P/N	Reference No.	Description
\triangle	P2	79104039	N78EBEBN	DVD MECHANISM & DVD/HDD MAIN BOARD ASSEMBLY

AV ASSEMBLY

\triangle	Location No.	TSB P/N	Reference No.	Description
\triangle	P1	79104036	(Not Available)	AV ASSEMBLY Consists of the following
		-----	-----	BOARD AV
	P4	79103349	1VSA13519	BOARD POWER SWITCH
	P6	79104038	1VSA18504	BOARD SENSOR BOARD DTV MODULE UNIT BOARD REAR JACK

BOARD AV

\triangle	Location No.	TSB P/N	Reference No.	Description
		-----	-----	BOARD AV
Following parts are included in BOARD AV.				
	SW521	79102423	SST0101AL041	TACT SWITCH SKQSAF001A
	SW522	79102423	SST0101AL041	TACT SWITCH SKQSAF001A
	SW523	79102423	SST0101AL041	TACT SWITCH SKQSAF001A
	SW524	79102423	SST0101AL041	TACT SWITCH SKQSAF001A
	SW525	79102423	SST0101AL041	TACT SWITCH SKQSAF001A
	SW1501	79102423	SST0101AL041	TACT SWITCH SKQSAF001A
	SW1502	79102423	SST0101AL041	TACT SWITCH SKQSAF001A
\triangle	TU1800	79104042	UTUNDVTMS003	TUNER UNIT ENGF7709KF
	W3	79103723	WX1E3N00-003	WIRE ASSEMBLY 30PIN FFC WX1E3N00-003
	W8	79103725	WX1E3N00-006	WIRE ASSEMBLY 6PIN FFC WX1E3N00-006

BOARD POWER SWITCH

\triangle	Location No.	TSB P/N	Reference No.	Description
		-----	-----	BOARD POWER SWITCH
Following part is included in BOARD POWER SWITCH.				
	SW1601	79102423	SST0101AL041	TACT SWITCH SKQSAF001A

BOARD SENSOR

\triangle	Location No.	TSB P/N	Reference No.	Description
	P4	79103349	1VSA13519	BOARD SENSOR

BOARD DTV MODULE UNIT

\triangle	Location No.	TSB P/N	Reference No.	Description
	P6	79104038	1VSA18504	BOARD DTV MODULE UNIT

PW/SW ASSEMBLY

\triangle	Location No.	TSB P/N	Reference No.	Description
\triangle	P3	79104037	(Not Available)	PW/SW ASSEMBLY Consists of the following
		-----	-----	BOARD POWER SUPPLY
		-----	-----	BOARD FRONT JACK
		-----	-----	BOARD SWITCH

BOARD POWER SUPPLY

\triangle	Location No.	TSB P/N	Reference No.	Description
		-----	-----	BOARD POWER SUPPLY

Following parts are included in BOARD POWER SUPPLY.

\triangle	C1001	79102416	CT2E683DC016	ACROSS THE LINE CAP. 0.068 μ F/250V
\triangle	C1006	79103607	CCN2EMA0E222	SAFTY CAP. 2200PF/250V
\triangle	IC1001	79102400	QPEWPS2561A1	PHOTOCOUPLER PS2561A-1(W)
\triangle	L1003	79103713	LLEG0Z0Y2027	COIL LINE FILTER ST0710ET24-013
\triangle	Q1001	79103611	QFWZ2SK3798Q	MOS FET 2SK3798(Q)
\triangle	R1001	79103612	RXX2565MGL01	GLASS GLAZE RES. 1/2W J 5.6M Ω
\triangle	AC1001	79103616	WAB0182LW020	POWER CORD W/O A GND WIRE BS / 1860MM / BLACK
\triangle	F1001	79103718	PDGJBB0NG252	FUSE TIME RAG FIH 250V 2.5A
\triangle	SA1001	79102397	NVQZ10D471KB	SURGE ABSORBER 470V+- 10PER
\triangle	T1001	79103714	LTT3PEOKT042	TRANS POWER 8710
	W1	79103721	WX1E3N00-001	WIRE ASSEMBLY 34PIN FFC WX1E3N00-001
	W4	79103724	WX1E3N00-004	WIRE ASSEMBLY 30PIN FFC WX1E3N00-004
	W7	79103726	WX1E3N00-007	WIRE ASSEMBLY 20PIN FFC WX1E3N00-007

BOARD FRONT JACK

\triangle	Location No.	TSB P/N	Reference No.	Description
		-----	-----	BOARD FRONT JACK

Following parts are included in BOARD FRONT JACK.

	SW3002	79102423	SST0101AL041	TACT SWITCH SKQSAF001A
	SW3003	79102423	SST0101AL041	TACT SWITCH SKQSAF001A
	SW3004	79102423	SST0101AL041	TACT SWITCH SKQSAF001A
	SW3005	79102423	SST0101AL041	TACT SWITCH SKQSAF001A
	SW3006	79102423	SST0101AL041	TACT SWITCH SKQSAF001A
	SW3007	79102423	SST0101AL041	TACT SWITCH SKQSAF001A

BOARD SWITCH

⚠	Location No.	TSB P/N	Reference No.	Description
		-----	-----	BOARD SWITCH
Following parts are included in BOARD SWITCH.				
	SW3008	79102423	SST0101AL041	TACT SWITCH SKQSAF001A
	SW3009	79102423	SST0101AL041	TACT SWITCH SKQSAF001A
	SW3010	79102423	SST0101AL041	TACT SWITCH SKQSAF001A

BOARD ATA

⚠	Location No.	TSB P/N	Reference No.	Description
	P5	79103606	1VSA16180	BOARD ATA