

Matr. 20318.0001

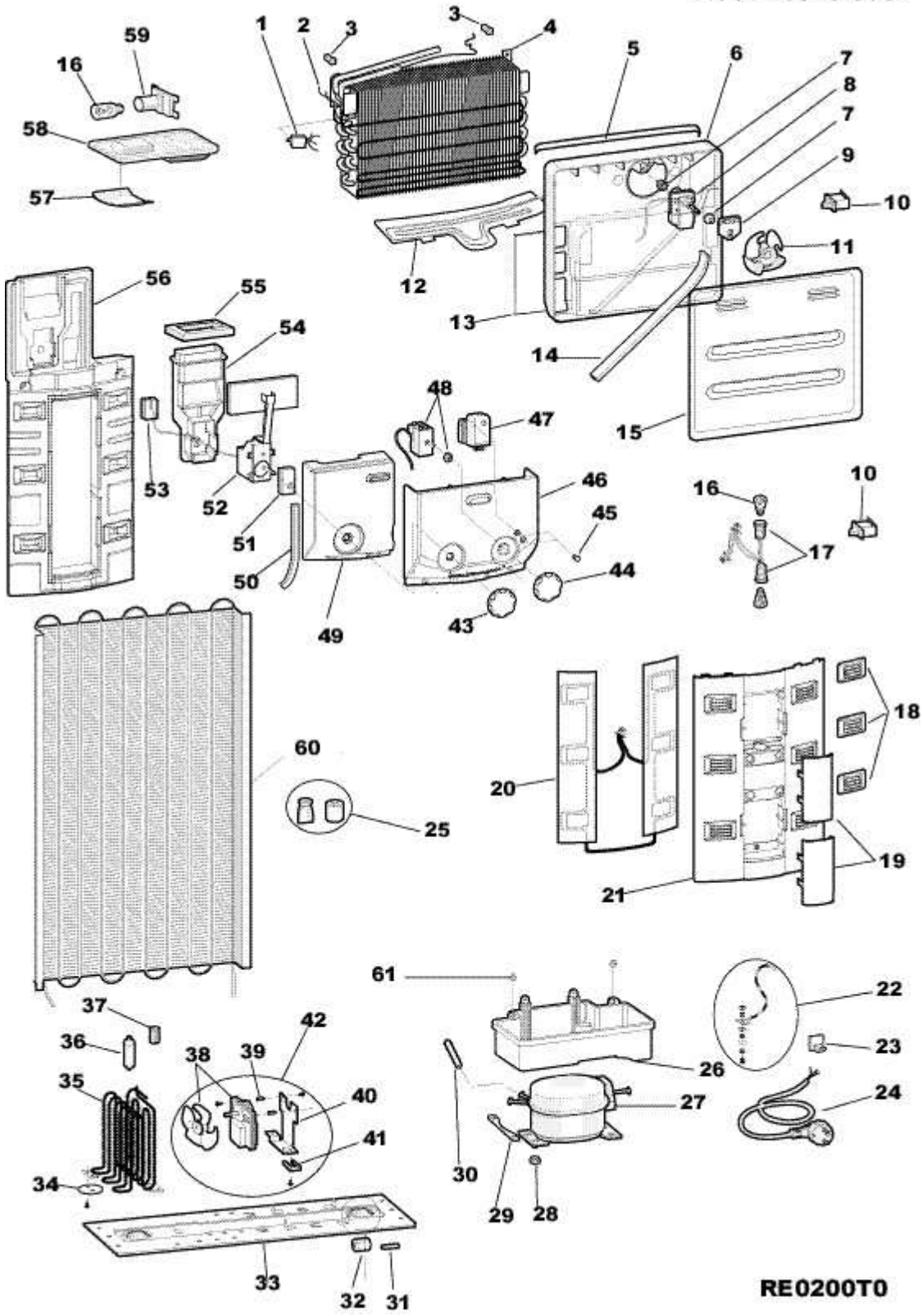

RE0200T0