

Matr. 20318.0002

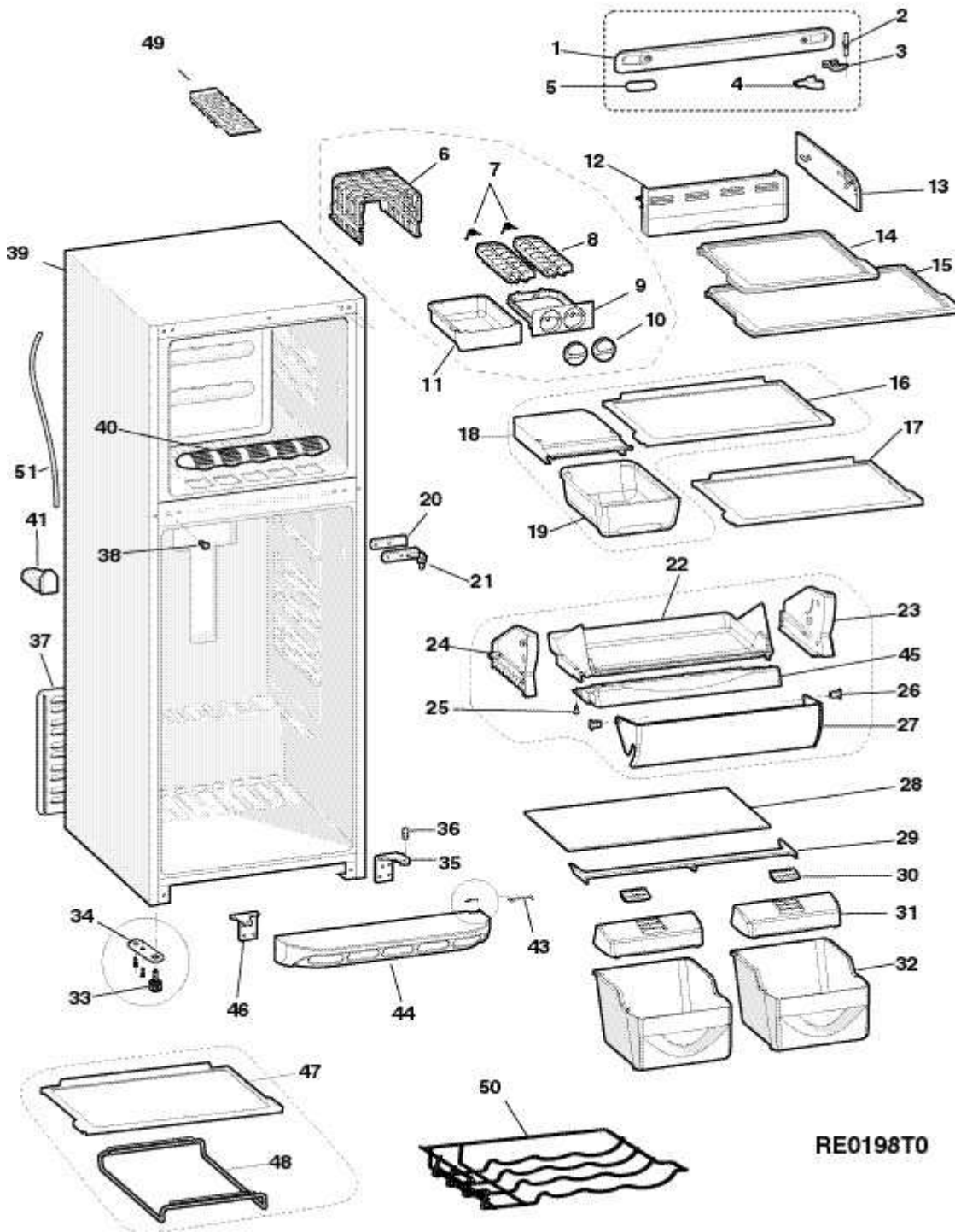

RE0198T0