

SHARP PARTS GUIDE

No. S87O8LC46X20E

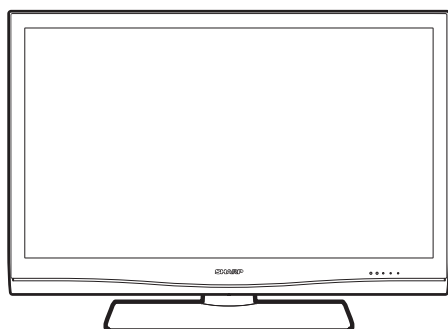

LCD COLOUR TELEVISION

MODELS LC-42X20E/S/RU

CONTENTS

- | | |
|---|-----------------------------------|
| [1] PRINTED WIRING BOARD ASSEMBLIES | [5] DUNTKE264FM01 (R/C, LED Unit) |
| [2] LCD PANEL AND TUNER (NOTE: THE PARTS HERE SHOWN ARE SUPPLIED AS AN ASSEMBLY BUT NOT INDEPENDENTLY.) | [6] DUNTKE266FM01 (KEY Unit) |
| [3] DUNTKE186FM02 (MAIN Unit) | [7] DUNTKE188FM01 (MINI AV Unit) |
| [4] DUNTKE187FM02 (TERMINAL Unit) | [8] CABINET PARTS |
| | [9] SUPPLIED ACCESSORIES |
| | [10] PACKING PARTS |
| | [11] SERVICE JIGS |

Parts marked with "▲" are important for maintaining the safety of the set. Be sure to replace these parts with specified ones for maintaining the safety and performance of the set.

NO.	PARTS CODE	PRICE RANK	NEW MARK	PART DELIVERY	DESCRIPTION
[1] PRINTED WIRING BOARD ASSEMBLIES					
N	DUNTKE186FM02	CT	N	R	MAIN Unit
N	DUNTKE187FM02	BY	N	R	TERMINAL Unit
N	DUNTKE264FM01	AS	N	R	R/C, LED Unit
N	DUNTKE266FM01	AR	N	R	KEY Unit
N	DUNTKE188FM01	BD	N	R	MIN IAV Unit
N	RDENCA231WJQZ	BZ	N	J	POWER Unit (Unit Replacement Item)
N	RUNTKA311WJQZ	BA	N	J	AC INLET Unit (Unit Replacement Item)
[2] LCD PANEL AND TUNER (NOTE: THE PARTS HERE SHOWN ARE SUPPLIED AS AN ASSEMBLY BUT NOT INDEPENDENTLY.)					
N	R1LK420D3LZ50Y	FK	N	J	42" Full HD LCD Panel Module
TU7501	RTUDAA014WJQZ	AX	N	S	Tuner
[3] DUNTKE186FM02(MAIN Unit)					
C1112	RC-KZA510WJPZY	AB		J	Capacitor 10 16V Ceramic
C1117	VCCCCZ1HH3R0CY	AA		J	Capacitor 30p 50V Ceramic
C1118	VCCCCZ1HH3R0CY	AA		J	Capacitor 30p 50V Ceramic
C1119	VCCCCZ1HH3R0CY	AA		J	Capacitor 30p 50V Ceramic
C1120	VCCCCZ1HH390JY	AB		J	Capacitor 39p 50V Ceramic
C1121	VCCCCZ1HH390JY	AB		J	Capacitor 39p 50V Ceramic
C1122	VCCCCZ1HH390JY	AB		J	Capacitor 39p 50V Ceramic
C1123	VCCCCZ1HH150JY	AB		J	Capacitor 15p 50V Ceramic
C1124	VCCCCZ1HH181JY	AB		J	Capacitor 180p 50V Ceramic
C1125	VCCCCZ1HH101JY	AB		J	Capacitor 100p 50V Ceramic
C1126	VCCCCZ1HH471JY	AA		J	Capacitor 470p 50V Ceramic
C1128	VCAAPE1CJ686MY	AE		J	Capacitor 68 16V Electrolytic
C1129	VCCCCZ1HH150JY	AB		J	Capacitor 15p 50V Ceramic
C1130	VCCCCZ1HH150JY	AB		J	Capacitor 15p 50V Ceramic
C1137	VCKYCZ1HB221KY	AA		J	Capacitor 220p 50V Ceramic
C1138	VCKYCZ1HB221KY	AA		J	Capacitor 220p 50V Ceramic
C1501	VCKYCZ1CF104ZY	AA		J	Capacitor 0.1 16V Ceramic
C1502	VCKYCZ1CF104ZY	AA		J	Capacitor 0.1 16V Ceramic
C1503	VCKYCZ1HB221KY	AA		J	Capacitor 220p 50V Ceramic
C1504	VCKYCZ1CF104ZY	AA		J	Capacitor 0.1 16V Ceramic
C1505	VCKYCZ1HB221KY	AA		J	Capacitor 220p 50V Ceramic
C1506	VCKYCZ1HB221KY	AA		J	Capacitor 220p 50V Ceramic
C1507	RC-KZA195WJZZY	AB		J	Capacitor 10 10V Ceramic
C1508	RC-KZA195WJZZY	AB		J	Capacitor 10 10V Ceramic
C1509	VCKYCZ1HB221KY	AA		J	Capacitor 220p 50V Ceramic
C1510	VCKYCZ1HB102KY	AB		J	Capacitor 1000p 50V Ceramic
C1511	VCKYCZ1HB102KY	AB		J	Capacitor 1000p 50V Ceramic
C1512	VCKYTV1CB105KY	AC		J	Capacitor 1 16V Ceramic
C1513	VCKYTV1CB105KY	AC		J	Capacitor 1 16V Ceramic
C1514	VCERML1CN106MY	AC		J	Capacitor 10 16V Electrolytic
C1515	VCKYCZ1CF104ZY	AA		J	Capacitor 0.1 16V Ceramic
C1516	VCKYCZ1HB102KY	AB		J	Capacitor 1000p 50V Ceramic
C1517	RC-KZA195WJZZY	AB		J	Capacitor 10 10V Ceramic
C1521	VCKYCZ1HB102KY	AB		J	Capacitor 1000p 50V Ceramic
C1522	RC-KZA510WJPZY	AB		J	Capacitor 10 16V Ceramic
C1523	VCKYTV1CB105KY	AC		J	Capacitor 1 16V Ceramic
C1524	VCKYTV1CB105KY	AC		J	Capacitor 1 16V Ceramic
C1525	VCKYTV1CB105KY	AC		J	Capacitor 1 16V Ceramic
C1526	VCKYTV1CB105KY	AC		J	Capacitor 1 16V Ceramic
C1531	VCKYCZ1CF104ZY	AA		J	Capacitor 0.1 16V Ceramic
C1532	VCKYCZ1HB102KY	AB		J	Capacitor 1000p 50V Ceramic
C1534	VCKYCZ1CF104ZY	AA		J	Capacitor 0.1 16V Ceramic
C1538	VCKYCZ1CF104ZY	AA		J	Capacitor 0.1 16V Ceramic
C1540	VCAAPE0JJ227MY	AE		J	Capacitor 220 6.3V Electrolytic
C1543	VCKYCZ1CF104ZY	AA		J	Capacitor 0.1 16V Ceramic
C1544	VCKYCZ1HB102KY	AB		J	Capacitor 1000p 50V Ceramic
C1545	VCKYCZ1CF104ZY	AA		J	Capacitor 0.1 16V Ceramic
C1546	VCKYCZ1HB102KY	AB		J	Capacitor 1000p 50V Ceramic
C1547	VCKYCZ1CF104ZY	AA		J	Capacitor 0.1 16V Ceramic
C1548	VCKYCZ1HB102KY	AB		J	Capacitor 1000p 50V Ceramic
C1551	RC-KZA195WJZZY	AB		J	Capacitor 10 10V Ceramic
C1578	VCKYCZ1CF104ZY	AA		J	Capacitor 0.1 16V Ceramic
C1579	VCKYCZ1HB102KY	AB		J	Capacitor 1000p 50V Ceramic
C1582	VCKYCZ1CF104ZY	AA		J	Capacitor 0.1 16V Ceramic
C1583	VCKYCZ1HB102KY	AB		J	Capacitor 1000p 50V Ceramic
C1586	VCKYCZ1CF104ZY	AA		J	Capacitor 0.1 16V Ceramic
C1587	VCKYCZ1HB102KY	AB		J	Capacitor 1000p 50V Ceramic
C1589	VCKYCZ1CF104ZY	AA		J	Capacitor 0.1 16V Ceramic
C1591	VCKYCZ1HB102KY	AB		J	Capacitor 1000p 50V Ceramic
C1592	VCKYCZ1CF104ZY	AA		J	Capacitor 0.1 16V Ceramic
C1596	VCKYCZ1CF104ZY	AA		J	Capacitor 0.1 16V Ceramic
C1597	VCKYCZ1HB102KY	AB		J	Capacitor 1000p 50V Ceramic
C1599	VCKYCZ1HB102KY	AB		J	Capacitor 1000p 50V Ceramic
C1608	RC-KZA195WJZZY	AB		J	Capacitor 10 10V Ceramic
C1613	VCKYCZ1CF104ZY	AA		J	Capacitor 0.1 16V Ceramic
C1614	VCKYCZ1HB102KY	AB		J	Capacitor 1000p 50V Ceramic
C1615	VCKYCZ1CF104ZY	AA		J	Capacitor 0.1 16V Ceramic
C1616	VCKYCZ1HB102KY	AB		J	Capacitor 1000p 50V Ceramic
C1801	VCKYCZ1HB222KY	AB		J	Capacitor 2200p 50V Ceramic
C1802	RC-KZA114WJZZY	AB		J	Capacitor 1 25V Ceramic

NO.	PARTS CODE	PRICE RANK	NEW MARK	PART DELIVERY	DESCRIPTION
[3] DUNTKE186FM02(MAIN Unit)					
C1813	RC-KZA114WJZZY	AB		J	Capacitor 1 25V Ceramic
C1816	RC-KZA067WJZZY	AB		J	Capacitor 4.7 10V Ceramic
C2001	VCKYCZ1CF104ZY	AA		J	Capacitor 0.1 16V Ceramic
C2002	VCKYCZ1HB152KY	AB		J	Capacitor 1500p 50V Ceramic
C2003	VCKYCZ1CF104ZY	AA		J	Capacitor 0.1 16V Ceramic
C2009	VCCCCZ1HH120JY	AB		J	Capacitor 12p 50V Ceramic
C2011	VCCCCZ1HH120JY	AB		J	Capacitor 12p 50V Ceramic
C2012	VCKYCZ1CF104ZY	AA		J	Capacitor 0.1 16V Ceramic
C2016	VCKYCZ1CF104ZY	AA		J	Capacitor 0.1 16V Ceramic
C2019	RC-KZA195WJZZY	AB		J	Capacitor 10 10V Ceramic
C2020	VCKYCZ1HB102KY	AB		J	Capacitor 1000p 50V Ceramic
C2021	VCKYCZ1CF104ZY	AA		J	Capacitor 0.1 16V Ceramic
C2023	VCKYCZ1CF104ZY	AA		J	Capacitor 0.1 16V Ceramic
C2026	VCKYCZ1CF104ZY	AA		J	Capacitor 0.1 16V Ceramic
C2027	VCKYCZ1CF104ZY	AA		J	Capacitor 0.1 16V Ceramic
C2030	VCKYCZ1CB103KY	AB		J	Capacitor 0.01 16V Ceramic
C2034	VCKYCZ1CF104ZY	AA		J	Capacitor 0.1 16V Ceramic
C2401	VCKYCZ1CF104ZY	AA		J	Capacitor 0.1 16V Ceramic
C2402	VCKYCZ1CF104ZY	AA		J	Capacitor 0.1 16V Ceramic
C2403	RC-KZA195WJZZY	AB		J	Capacitor 10 10V Ceramic
C2404	VCKYCZ1CF104ZY	AA		J	Capacitor 0.1 16V Ceramic
C2405	VCKYCZ1CF104ZY	AA		J	Capacitor 0.1 16V Ceramic
C2406	VCKYCZ1CF104ZY	AA		J	Capacitor 0.1 16V Ceramic
C2407	VCKYCZ1CF104ZY	AA		J	Capacitor 0.1 16V Ceramic
C2408	VCKYCZ1CF104ZY	AA		J	Capacitor 0.1 16V Ceramic
C2410	VCKYCZ1CF104ZY	AA		J	Capacitor 0.1 16V Ceramic
C2606	VCCCCZ1HH101JY	AB		J	Capacitor 100p 50V Ceramic
C2607	VCCCCZ1HH101JY	AB		J	Capacitor 100p 50V Ceramic
C2608	VCCCCZ1HH101JY	AB		J	Capacitor 100p 50V Ceramic
C3301	VCKYCZ1CF104ZY	AA		J	Capacitor 0.1 16V Ceramic
C3302	VCKYCZ1CF104ZY	AA		J	Capacitor 0.1 16V Ceramic
C3303	VCKYCZ1CF104ZY	AA		J	Capacitor 0.1 16V Ceramic
C3304	VCKYCZ1CF104ZY	AA		J	Capacitor 0.1 16V Ceramic
C3305	VCKYCZ1CF104ZY	AA		J	Capacitor 0.1 16V Ceramic
C3306	VCKYCZ1CF104ZY	AA		J	Capacitor 0.1 16V Ceramic
C3307	VCKYCZ1CF104ZY	AA		J	Capacitor 0.1 16V Ceramic
C3308	VCKYCZ1CF104ZY	AA		J	Capacitor 0.1 16V Ceramic
C3309	VCKYCZ1CF104ZY	AA		J	Capacitor 0.1 16V Ceramic
C3310	VCKYCZ1CF104ZY	AA		J	Capacitor 0.1 16V Ceramic
C3311	VCKYCZ1CF104ZY	AA		J	Capacitor 0.1 16V Ceramic
C3312	VCKYCZ1CF104ZY	AA		J	Capacitor 0.1 16V Ceramic
C3313	VCCCCZ1HH3R0CY	AA		J	Capacitor 30p 50V Ceramic
C3314	VCCCCZ1HH3R0CY	AA		J	Capacitor 30p 50V Ceramic
C3315	VCKYCZ1CF104ZY	AA		J	Capacitor 0.1 16V Ceramic
C3316	VCKYCZ1CF104ZY	AA		J	Capacitor 0.1 16V Ceramic
C3317	VCKYCZ1CF104ZY	AA		J	Capacitor 0.1 16V Ceramic
C3318	VCKYCZ1CF104ZY	AA		J	Capacitor 0.1 16V Ceramic
C3319	VCKYCZ1CF104ZY	AA		J	Capacitor 0.1 16V Ceramic
C3320	VCKYCZ1CF104ZY	AA		J	Capacitor 0.1 16V Ceramic
C3321	VCKYCZ1CF104ZY	AA		J	Capacitor 0.1 16V Ceramic
C3322	VCKYCZ1CF104ZY	AA		J	Capacitor 0.1 16V Ceramic
C3323	VCKYCZ1CF104ZY	AA		J	Capacitor 0.1 16V Ceramic
C3324	VCKYCZ1CF104ZY	AA		J	Capacitor 0.1 16V Ceramic
C3325	RC-KZA195WJZZY	AB		J	Capacitor 10 10V Ceramic
C3326	RC-KZA195WJZZY	AB		J	Capacitor 10 10V Ceramic
C3327	RC-KZA195WJZZY	AB		J	Capacitor 10 10V Ceramic
C3328	VCKYCZ1CF104ZY	AA		J	Capacitor 0.1 16V Ceramic
C3329	RC-KZA195WJZZY	AB		J	Capacitor 10 10V Ceramic
C3330	VCKYCZ1CF104ZY	AA		J	Capacitor 0.1 16V Ceramic
C3331	RC-KZA195WJZZY	AB		J	Capacitor 10 10V Ceramic
C3332	VCKYCZ1CF104ZY	AA		J	Capacitor 0.1 16V Ceramic
C3333	RC-KZA195WJZZY	AB		J	Capacitor 10 10V Ceramic
C3334	VCKYCZ1CF104ZY	AA		J	Capacitor 0.1 16V Ceramic
C3335	RC-KZA195WJZZY	AB		J	Capacitor 10 10V Ceramic
C3336	VCKYCZ1CF104ZY	AA		J	Capacitor 0.1 16V Ceramic
C3337	RC-KZA195WJZZY	AB		J	Capacitor 10 10V Ceramic
C3338	VCKYCZ1CF104ZY	AA		J	Capacitor 0.1 16V Ceramic
C3339	RC-KZA195WJZZY	AB		J	Capacitor 10 10V Ceramic
C3340	VCKYCZ1CF104ZY	AA		J	Capacitor 0.1 16V Ceramic
C3341	RC-KZA195WJZZY	AB		J	Capacitor 10 10V Ceramic
C3342	VCKYCZ1CF104ZY	AA		J	Capacitor 0.1 16V Ceramic
C3343	RC-KZA195WJZZY	AB		J	Capacitor 10 10V Ceramic
C3344	VCKYCZ1CF104ZY	AA		J	Capacitor 0.1 16V Ceramic
C3345	VCKYCZ1CF104ZY	AA		J	Capacitor 0.1 16V Ceramic
C3346	RC-KZA195WJZZY	AB		J	Capacitor 10 10V Ceramic
C3347	VCKYCZ1CF104ZY	AA		J	Capacitor 0.1 16V Ceramic
C3348	RC-KZA195WJZZY	AB		J	Capacitor 10 10V Ceramic
C3349	VCKYCZ1CF104ZY	AA		J	Capacitor 0.1 16V Ceramic
C3350	VCKYCZ1CF104ZY	AA		J	Capacitor 0.1 16V Ceramic
C3351	VCKYCZ1CF104ZY	AA		J	Capacitor 0.1 16V Ceramic
C3352	VCKYCZ1CF104ZY	AA		J	Capacitor 0.1 16V Ceramic
C3353	VCKYCZ1HB102KY	AB		J	Capacitor 1000p 50V Ceramic
C3354	VCKYCZ1HB102KY	AB		J	Capacitor 1000p 50V Ceramic
C3355	VCKYCZ1HB102KY	AB		J	Capacitor 1000p 50V Ceramic
C3356	VCKYCZ1HB102KY	AB		J	Capacitor 1000p 50V Ceramic

LC-42X20E/S/RU

NO.	PARTS CODE	PRICE RANK	NEW MARK	PART DELIVERY	DESCRIPTION
[3] DUNTKE186FM02(MAIN Unit)					
C3357	RC-KZA195WJZZY	AB		J	Capacitor 10 10V Ceramic
C3358	VCKYCZ1CF104ZY	AA		J	Capacitor 0.1 16V Ceramic
C3359	VCKYCZ1CF104ZY	AA		J	Capacitor 0.1 16V Ceramic
C3360	VCKYCZ1CF104ZY	AA		J	Capacitor 0.1 16V Ceramic
C3361	VCKYCZ1CF104ZY	AA		J	Capacitor 0.1 16V Ceramic
C3362	VCKYCZ1HB102KY	AB		J	Capacitor 1000p 50V Ceramic
C3363	VCKYCZ1HB102KY	AB		J	Capacitor 1000p 50V Ceramic
C3364	VCKYCZ1HB102KY	AB		J	Capacitor 1000p 50V Ceramic
C3365	VCKYCZ1HB102KY	AB		J	Capacitor 1000p 50V Ceramic
C3366	RC-KZA195WJZZY	AB		J	Capacitor 10 10V Ceramic
C3367	VCKYCZ1CF104ZY	AA		J	Capacitor 0.1 16V Ceramic
C3368	VCKYCZ1CF104ZY	AA		J	Capacitor 0.1 16V Ceramic
C3369	VCKYCZ1CF104ZY	AA		J	Capacitor 0.1 16V Ceramic
C3370	VCKYCZ1CF104ZY	AA		J	Capacitor 0.1 16V Ceramic
C3371	VCKYCZ1HB102KY	AB		J	Capacitor 1000p 50V Ceramic
C3372	VCKYCZ1HB102KY	AB		J	Capacitor 1000p 50V Ceramic
C3373	VCKYCZ1HB102KY	AB		J	Capacitor 1000p 50V Ceramic
C3374	VCAAPE0JJ107MY	AE		J	Capacitor 100 6.3V Electrolytic
C3375	VCKYCZ1HB102KY	AB		J	Capacitor 1000p 50V Ceramic
C3376	RC-KZA195WJZZY	AB		J	Capacitor 10 10V Ceramic
C3377	VCAAPE0JJ107MY	AE		J	Capacitor 100 6.3V Electrolytic
C3378	VCAAPE0JJ107MY	AE		J	Capacitor 100 6.3V Electrolytic
C3379	VCKYCZ1CF104ZY	AA		J	Capacitor 0.1 16V Ceramic
C3380	VCKYCZ1CF104ZY	AA		J	Capacitor 0.1 16V Ceramic
C3381	VCKYCZ1CF104ZY	AA		J	Capacitor 0.1 16V Ceramic
C3382	VCKYCZ1CF104ZY	AA		J	Capacitor 0.1 16V Ceramic
C3383	VCKYCZ1CF104ZY	AA		J	Capacitor 0.1 16V Ceramic
C3384	RC-KZA195WJZZY	AB		J	Capacitor 10 10V Ceramic
C3385	RC-KZA195WJZZY	AB		J	Capacitor 10 10V Ceramic
C3386	VCKYCZ1CF104ZY	AA		J	Capacitor 0.1 16V Ceramic
C3387	VCKYCZ1CF104ZY	AA		J	Capacitor 0.1 16V Ceramic
C3388	RC-KZA195WJZZY	AB		J	Capacitor 10 10V Ceramic
C3389	RC-KZA195WJZZY	AB		J	Capacitor 10 10V Ceramic
C3390	RC-KZA195WJZZY	AB		J	Capacitor 10 10V Ceramic
C3391	VCKYCZ1HB272KY	AA		J	Capacitor 2700p 50V Ceramic
C3393	VCKYCZ1HB272KY	AA		J	Capacitor 2700p 50V Ceramic
C3395	VCKYCZ1CF104ZY	AA		J	Capacitor 0.1 16V Ceramic
C3396	RC-KZA195WJZZY	AB		J	Capacitor 10 10V Ceramic
C3397	VCKYCZ1CF104ZY	AA		J	Capacitor 0.1 16V Ceramic
C3398	RC-KZA195WJZZY	AB		J	Capacitor 10 10V Ceramic
C3502	RC-KZA195WJZZY	AB		J	Capacitor 10 10V Ceramic
C3503	VCKYCZ1CF104ZY	AA		J	Capacitor 0.1 16V Ceramic
C3504	VCKYCZ1CF104ZY	AA		J	Capacitor 0.1 16V Ceramic
C3505	VCKYCZ1HB102KY	AB		J	Capacitor 1000p 50V Ceramic
C3506	VCKYCZ1HB102KY	AB		J	Capacitor 1000p 50V Ceramic
C3507	VCKYCZ1HB102KY	AB		J	Capacitor 1000p 50V Ceramic
C3508	VCKYCZ1HB102KY	AB		J	Capacitor 1000p 50V Ceramic
C3513	RC-KZA195WJZZY	AB		J	Capacitor 10 10V Ceramic
C3514	VCKYCZ1CF104ZY	AA		J	Capacitor 0.1 16V Ceramic
C3515	VCKYCZ1CF104ZY	AA		J	Capacitor 0.1 16V Ceramic
C3516	VCKYCZ1HB102KY	AB		J	Capacitor 1000p 50V Ceramic
C3517	VCKYCZ1HB102KY	AB		J	Capacitor 1000p 50V Ceramic
C3518	VCKYCZ1EB103KY	AA		J	Capacitor 0.01 25V Ceramic
C3520	RC-KZA195WJZZY	AB		J	Capacitor 10 10V Ceramic
C3521	VCKYCZ1CF104ZY	AA		J	Capacitor 0.1 16V Ceramic
C3522	VCKYCZ1CF104ZY	AA		J	Capacitor 0.1 16V Ceramic
C3523	VCKYCZ1HB102KY	AB		J	Capacitor 1000p 50V Ceramic
C3524	VCKYCZ1HB102KY	AB		J	Capacitor 1000p 50V Ceramic
C3525	VCKYCZ1HB102KY	AB		J	Capacitor 1000p 50V Ceramic
C3526	VCKYCZ1HB102KY	AB		J	Capacitor 1000p 50V Ceramic
C3531	RC-KZA195WJZZY	AB		J	Capacitor 10 10V Ceramic
C3532	VCKYCZ1CF104ZY	AA		J	Capacitor 0.1 16V Ceramic
C3533	VCKYCZ1CF104ZY	AA		J	Capacitor 0.1 16V Ceramic
C3534	VCKYCZ1HB102KY	AB		J	Capacitor 1000p 50V Ceramic
C3535	VCKYCZ1HB102KY	AB		J	Capacitor 1000p 50V Ceramic
C3537	VCKYCZ1CF104ZY	AA		J	Capacitor 0.1 16V Ceramic
C3538	VCKYCZ1CF104ZY	AA		J	Capacitor 0.1 16V Ceramic
C3539	VCAAPE0JJ107MY	AE		J	Capacitor 100 6.3V Electrolytic
C3540	VCKYCZ1CF104ZY	AA		J	Capacitor 0.1 16V Ceramic
C3541	VCKYCZ1CF104ZY	AA		J	Capacitor 0.1 16V Ceramic
C3542	VCKYCZ1HB102KY	AB		J	Capacitor 1000p 50V Ceramic
C3543	VCKYCZ1HB102KY	AB		J	Capacitor 1000p 50V Ceramic
C3544	VCKYCZ1CF104ZY	AA		J	Capacitor 0.1 16V Ceramic
C3545	VCKYCZ1CF104ZY	AA		J	Capacitor 0.1 16V Ceramic
C3546	VCKYCZ1HB102KY	AB		J	Capacitor 1000p 50V Ceramic
C3547	VCKYCZ1HB102KY	AB		J	Capacitor 1000p 50V Ceramic
C4404	VCKYCZ1CF104ZY	AA		J	Capacitor 0.1 16V Ceramic
C4405	VCKYCZ1CF104ZY	AA		J	Capacitor 0.1 16V Ceramic
C4406	VCKYCZ1CF104ZY	AA		J	Capacitor 0.1 16V Ceramic
C4408	VCKYCZ1CF104ZY	AA		J	Capacitor 0.1 16V Ceramic
C4410	VCKYCZ1CF104ZY	AA		J	Capacitor 0.1 16V Ceramic
C4411	VCKYCZ1CF104ZY	AA		J	Capacitor 0.1 16V Ceramic
C4417	VCKYCZ1EF104ZY	AA		J	Capacitor 0.1 25V Ceramic
C4420	VCAAPE1CJ686MY	AE		J	Capacitor 68 16V Electrolytic
C8101	VCKYCZ1CF104ZY	AA		J	Capacitor 0.1 16V Ceramic

NO.	PARTS CODE	PRICE RANK	NEW MARK	PART DELIVERY	DESCRIPTION
[3] DUNTKE186FM02(MAIN Unit)					
C8102	VCKYCZ1CF104ZY	AA		J	Capacitor 0.1 16V Ceramic
C8103	VCKYCZ1CF104ZY	AA		J	Capacitor 0.1 16V Ceramic
C8104	VCCCCZ1HH2R0CY	AA		J	Capacitor 20p 50V Ceramic
C8105	VCCCCZ1HH1R0CY	AB		J	Capacitor 10p 50V Ceramic
C8106	VCCCCZ1HH120JY	AB		J	Capacitor 12p 50V Ceramic
C8107	VCCCCZ1HH120JY	AB		J	Capacitor 12p 50V Ceramic
C8108	RC-KZA195WJZZY	AB		J	Capacitor 10 10V Ceramic
C8109	VCKYCZ1CF104ZY	AA		J	Capacitor 0.1 16V Ceramic
C8110	RC-KZA195WJZZY	AB		J	Capacitor 10 10V Ceramic
C8111	VCKYCZ1CF104ZY	AA		J	Capacitor 0.1 16V Ceramic
C8112	RC-KZA195WJZZY	AB		J	Capacitor 10 10V Ceramic
C8113	VCKYCZ1CF104ZY	AA		J	Capacitor 0.1 16V Ceramic
C8114	RC-KZA195WJZZY	AB		J	Capacitor 10 10V Ceramic
C8115	VCKYCZ1CF104ZY	AA		J	Capacitor 0.1 16V Ceramic
C8116	VCKYCZ1CF104ZY	AA		J	Capacitor 0.1 16V Ceramic
C8117	VCKYCZ1CF104ZY	AA		J	Capacitor 0.1 16V Ceramic
C8118	VCKYCZ1CF104ZY	AA		J	Capacitor 0.1 16V Ceramic
C8119	VCKYCZ1CF104ZY	AA		J	Capacitor 0.1 16V Ceramic
C8120	RC-KZA195WJZZY	AB		J	Capacitor 10 10V Ceramic
C8121	RC-KZA195WJZZY	AB		J	Capacitor 10 10V Ceramic
C8122	RC-KZA195WJZZY	AB		J	Capacitor 10 10V Ceramic
C8123	RC-KZA195WJZZY	AB		J	Capacitor 10 10V Ceramic
C8124	VCKYCZ1CF104ZY	AA		J	Capacitor 0.1 16V Ceramic
C8125	VCKYCZ1CF104ZY	AA		J	Capacitor 0.1 16V Ceramic
C8126	VCKYCZ1CF104ZY	AA		J	Capacitor 0.1 16V Ceramic
C8127	VCKYCZ1CF104ZY	AA		J	Capacitor 0.1 16V Ceramic
C8128	VCKYCZ1CF104ZY	AA		J	Capacitor 0.1 16V Ceramic
C8129	RC-KZA195WJZZY	AB		J	Capacitor 10 10V Ceramic
C8130	RC-KZA195WJZZY	AB		J	Capacitor 10 10V Ceramic
C8131	RC-KZA195WJZZY	AB		J	Capacitor 10 10V Ceramic
C8132	RC-KZA195WJZZY	AB		J	Capacitor 10 10V Ceramic
C8133	RC-KZA195WJZZY	AB		J	Capacitor 10 10V Ceramic
C8134	VCKYCZ1CF104ZY	AA		J	Capacitor 0.1 16V Ceramic
C8135	VCKYCZ1CF104ZY	AA		J	Capacitor 0.1 16V Ceramic
C8136	VCKYCZ1CF104ZY	AA		J	Capacitor 0.1 16V Ceramic
C8137	VCKYCZ1CF104ZY	AA		J	Capacitor 0.1 16V Ceramic
C8138	RC-KZA195WJZZY	AB		J	Capacitor 10 10V Ceramic
C8139	RC-KZA195WJZZY	AB		J	Capacitor 10 10V Ceramic
C8140	RC-KZA195WJZZY	AB		J	Capacitor 10 10V Ceramic
C8141	RC-KZA195WJZZY	AB		J	Capacitor 10 10V Ceramic
C8142	RC-KZA195WJZZY	AB		J	Capacitor 10 10V Ceramic
C8143	VCKYCZ1CF104ZY	AA		J	Capacitor 0.1 16V Ceramic
C8144	VCKYCZ1CF104ZY	AA		J	Capacitor 0.1 16V Ceramic
C8145	VCKYCZ1CF104ZY	AA		J	Capacitor 0.1 16V Ceramic
C8146	VCKYCZ1CF104ZY	AA		J	Capacitor 0.1 16V Ceramic
C8147	RC-KZA195WJZZY	AB		J	Capacitor 10 10V Ceramic
C8148	RC-KZA195WJZZY	AB		J	Capacitor 10 10V Ceramic
C8149	RC-KZA195WJZZY	AB		J	Capacitor 10 10V Ceramic
C8150	VCAAPE0JJ107MY	AE		J	Capacitor 100 6.3V Electrolytic
C8151	VCAAPE0JJ107MY	AE		J	Capacitor 100 6.3V Electrolytic
C8152	VCKYCZ1CF104ZY	AA		J	Capacitor 0.1 16V Ceramic
C8153	VCKYCZ1CF104ZY	AA		J	Capacitor 0.1 16V Ceramic
C8154	VCKYCZ1CF104ZY	AA		J	Capacitor 0.1 16V Ceramic
C8155	VCKYCZ1CF104ZY	AA		J	Capacitor 0.1 16V Ceramic
C8156	VCKYCZ1CF104ZY	AA		J	Capacitor 0.1 16V Ceramic
C8157	VCKYCZ1CF104ZY	AA		J	Capacitor 0.1 16V Ceramic
C8158	VCKYCZ1HB102KY	AB		J	Capacitor 1000p 50V Ceramic
C8159	VCKYCZ1HB102KY	AB		J	Capacitor 1000p 50V Ceramic
C8160	VCKYCZ1HB102KY	AB		J	Capacitor 1000p 50V Ceramic
C8161	VCKYCZ1HB102KY	AB		J	Capacitor 1000p 50V Ceramic
C8162	VCKYCZ1HB102KY	AB		J	Capacitor 1000p 50V Ceramic
C8163	VCKYCZ1HB102KY	AB		J	Capacitor 1000p 50V Ceramic
C8164	RC-KZA195WJZZY	AB		J	Capacitor 10 10V Ceramic
C8165	RC-KZA195WJZZY	AB		J	Capacitor 10 10V Ceramic
C8166	VCKYCZ1CF104ZY	AA		J	Capacitor 0.1 16V Ceramic
C8167	VCKYCZ1CF104ZY	AA		J	Capacitor 0.1 16V Ceramic
C8168	VCKYCZ1CF104ZY	AA		J	Capacitor 0.1 16V Ceramic
C8169	VCKYCZ1CF104ZY	AA		J	Capacitor 0.1 16V Ceramic
C8170	VCKYCZ1HB102KY	AB		J	Capacitor 1000p 50V Ceramic
C8171	VCKYCZ1HB102KY	AB		J	Capacitor 1000p 50V Ceramic
C8172	VCKYCZ1HB102KY	AB		J	Capacitor 1000p 50V Ceramic
C8173	VCKYCZ1HB102KY	AB		J	Capacitor 1000p 50V Ceramic
C8174	RC-KZA195WJZZY	AB		J	Capacitor 10 10V Ceramic
C8175	RC-KZA195WJZZY	AB		J	Capacitor 10 10V Ceramic
C8176	VCKYCZ1HB272KY	AA		J	Capacitor 2700p 50V Ceramic
C8177	VCKYCZ1HB272KY	AA		J	Capacitor 2700p 50V Ceramic
C8178	VCKYCZ1HB272KY	AA		J	Capacitor 2700p 50V Ceramic
C8179	VCKYCZ1HB272KY	AA		J	Capacitor 2700p 50V Ceramic
C8180	VCKYCZ1HB272KY	AA		J	Capacitor 2700p 50V Ceramic
C8181	VCKYCZ1HB272KY	AA		J	Capacitor 2700p 50V Ceramic
C8182	VCKYCZ1HB272KY	AA		J	Capacitor 2700p 50V Ceramic
C8183	VCKYCZ1HB102KY	AB		J	Capacitor 1000p 50V Ceramic
C8184	RC-KZA195WJZZY	AB		J	Capacitor 10 10V Ceramic
C8185	RC-KZA195WJZZY	AB		J	Capacitor 10 10V Ceramic
C8186	VCKYCZ1CF104ZY	AA		J	Capacitor 0.1 16V Ceramic

NO.	PARTS CODE	PRICE RANK	NEW MARK	PART DELIVERY	DESCRIPTION
[3] DUNTKE186FM02(MAIN Unit)					
C8187	VCKYCZ1CF104ZY	AA		J	Capacitor 0.1 16V Ceramic
C8188	VCKYCZ1CF104ZY	AA		J	Capacitor 0.1 16V Ceramic
C8189	VCKYCZ1CF104ZY	AA		J	Capacitor 0.1 16V Ceramic
C8190	VCKYCZ1HB102KY	AB		J	Capacitor 1000p 50V Ceramic
C8191	VCKYCZ1HB102KY	AB		J	Capacitor 1000p 50V Ceramic
C8192	VCKYCZ1HB102KY	AB		J	Capacitor 1000p 50V Ceramic
C8193	VCKYCZ1HB102KY	AB		J	Capacitor 1000p 50V Ceramic
C8194	RC-KZA388WJZZY	AC		J	Capacitor 10 6.3V Ceramic
C8195	VCKYCZ1AB104KY	AB		J	Capacitor 0.1 10V Ceramic
C8196	VCKYCZ1AB104KY	AB		J	Capacitor 0.1 10V Ceramic
C8197	VCKYCZ1HB102KY	AB		J	Capacitor 1000p 50V Ceramic
C8198	VCKYCZ1HB102KY	AB		J	Capacitor 1000p 50V Ceramic
C8199	RC-KZA388WJZZY	AC		J	Capacitor 10 6.3V Ceramic
C8200	VCKYCZ1AB104KY	AB		J	Capacitor 0.1 10V Ceramic
C8201	VCKYCZ1AB104KY	AB		J	Capacitor 0.1 10V Ceramic
C8202	VCKYCZ1HB102KY	AB		J	Capacitor 1000p 50V Ceramic
C8203	VCKYCZ1HB102KY	AB		J	Capacitor 1000p 50V Ceramic
C8204	RC-KZA388WJZZY	AC		J	Capacitor 10 6.3V Ceramic
C8205	VCKYCZ1AB104KY	AB		J	Capacitor 0.1 10V Ceramic
C8206	VCKYCZ1AB104KY	AB		J	Capacitor 0.1 10V Ceramic
C8207	VCKYCZ1AB104KY	AB		J	Capacitor 0.1 10V Ceramic
C8208	VCKYCZ1AB104KY	AB		J	Capacitor 0.1 10V Ceramic
C8209	VCKYCZ1HB102KY	AB		J	Capacitor 1000p 50V Ceramic
C8210	VCKYCZ1HB102KY	AB		J	Capacitor 1000p 50V Ceramic
C8211	VCKYCZ1HB102KY	AB		J	Capacitor 1000p 50V Ceramic
C8212	VCKYCZ1HB102KY	AB		J	Capacitor 1000p 50V Ceramic
C8213	VCKYCZ1AB104KY	AB		J	Capacitor 0.1 10V Ceramic
C8214	RC-KZA388WJZZY	AC		J	Capacitor 10 6.3V Ceramic
C8215	RC-KZA388WJZZY	AC		J	Capacitor 10 6.3V Ceramic
C8216	VCKYCZ1AB104KY	AB		J	Capacitor 0.1 10V Ceramic
C8217	VCKYCZ1AB104KY	AB		J	Capacitor 0.1 10V Ceramic
C8218	VCKYCZ1HB102KY	AB		J	Capacitor 1000p 50V Ceramic
C8219	VCKYCZ1HB102KY	AB		J	Capacitor 1000p 50V Ceramic
C8220	RC-KZA388WJZZY	AC		J	Capacitor 10 6.3V Ceramic
C8221	VCKYCZ1AB104KY	AB		J	Capacitor 0.1 10V Ceramic
C8222	VCKYCZ1AB104KY	AB		J	Capacitor 0.1 10V Ceramic
C8223	VCKYCZ1HB102KY	AB		J	Capacitor 1000p 50V Ceramic
C8224	VCKYCZ1HB102KY	AB		J	Capacitor 1000p 50V Ceramic
C8225	VCKYCZ1AB104KY	AB		J	Capacitor 0.1 10V Ceramic
C8226	VCKYCZ1HB102KY	AB		J	Capacitor 1000p 50V Ceramic
C8227	VCKYCZ1HB102KY	AB		J	Capacitor 1000p 50V Ceramic
C8228	VCKYCZ1HB102KY	AB		J	Capacitor 1000p 50V Ceramic
C8229	VCKYCZ1HB102KY	AB		J	Capacitor 1000p 50V Ceramic
C8230	RC-KZA195WJZZY	AB		J	Capacitor 10 10V Ceramic
C8301	VCKYCZ1EB103KY	AA		J	Capacitor 0.01 25V Ceramic
C8302	VCKYCZ1EB103KY	AA		J	Capacitor 0.01 25V Ceramic
C8303	VCKYCZ1CF104ZY	AA		J	Capacitor 0.1 16V Ceramic
C8304	VCKYCZ1CF104ZY	AA		J	Capacitor 0.1 16V Ceramic
C8314	VCKYCZ1CF104ZY	AA		J	Capacitor 0.1 16V Ceramic
C8315	VCKYCZ1CF104ZY	AA		J	Capacitor 0.1 16V Ceramic
C8316	VCKYCZ1CF104ZY	AA		J	Capacitor 0.1 16V Ceramic
C8317	VCKYCZ1CF104ZY	AA		J	Capacitor 0.1 16V Ceramic
C8318	RC-KZA195WJZZY	AB		J	Capacitor 10 10V Ceramic
C8319	RC-KZA195WJZZY	AB		J	Capacitor 10 10V Ceramic
C8320	RC-KZA195WJZZY	AB		J	Capacitor 10 10V Ceramic
C8321	RC-KZA195WJZZY	AB		J	Capacitor 10 10V Ceramic
C8322	RC-KZA195WJZZY	AB		J	Capacitor 10 10V Ceramic
C8327	VCKYCZ1CF104ZY	AA		J	Capacitor 0.1 16V Ceramic
C8328	VCKYCZ1CF104ZY	AA		J	Capacitor 0.1 16V Ceramic
C8329	VCKYCZ1CF104ZY	AA		J	Capacitor 0.1 16V Ceramic
C8330	VCKYCZ1CF104ZY	AA		J	Capacitor 0.1 16V Ceramic
C8331	VCKYCZ1CF104ZY	AA		J	Capacitor 0.1 16V Ceramic
C8332	VCKYCZ1CF104ZY	AA		J	Capacitor 0.1 16V Ceramic
C8333	VCKYCZ1CF104ZY	AA		J	Capacitor 0.1 16V Ceramic
C8334	VCKYCZ1CF104ZY	AA		J	Capacitor 0.1 16V Ceramic
C8335	VCKYCZ1CF104ZY	AA		J	Capacitor 0.1 16V Ceramic
C8336	VCKYCZ1CF104ZY	AA		J	Capacitor 0.1 16V Ceramic
C8337	VCKYCZ1CF104ZY	AA		J	Capacitor 0.1 16V Ceramic
C8338	VCKYCZ1CF104ZY	AA		J	Capacitor 0.1 16V Ceramic
C8339	VCKYCZ1CF104ZY	AA		J	Capacitor 0.1 16V Ceramic
C8340	VCKYCZ1CF104ZY	AA		J	Capacitor 0.1 16V Ceramic
C8341	VCKYCZ1CF104ZY	AA		J	Capacitor 0.1 16V Ceramic
C8342	VCKYCZ1CF104ZY	AA		J	Capacitor 0.1 16V Ceramic
C8343	VCKYCZ1CF104ZY	AA		J	Capacitor 0.1 16V Ceramic
C8344	VCKYCZ1CF104ZY	AA		J	Capacitor 0.1 16V Ceramic
C8345	RC-KZA195WJZZY	AB		J	Capacitor 10 10V Ceramic
C8346	RC-KZA195WJZZY	AB		J	Capacitor 10 10V Ceramic
C8347	VCKYCZ1CF104ZY	AA		J	Capacitor 0.1 16V Ceramic
C8348	VCKYCZ1CF104ZY	AA		J	Capacitor 0.1 16V Ceramic
C8349	VCKYCZ1CF104ZY	AA		J	Capacitor 0.1 16V Ceramic
C8350	VCKYCZ1CF104ZY	AA		J	Capacitor 0.1 16V Ceramic
C8351	VCKYCZ1CF104ZY	AA		J	Capacitor 0.1 16V Ceramic
C8352	VCKYCZ1CF104ZY	AA		J	Capacitor 0.1 16V Ceramic
C8353	VCKYCZ1CF104ZY	AA		J	Capacitor 0.1 16V Ceramic
C8354	VCKYCZ1CF104ZY	AA		J	Capacitor 0.1 16V Ceramic

NO.	PARTS CODE	PRICE RANK	NEW MARK	PART DELIVERY	DESCRIPTION
[3] DUNTKE186FM02(MAIN Unit)					
C8355	VCKYCZ1CF104ZY	AA		J	Capacitor 0.1 16V Ceramic
C8356	VCKYCZ1CF104ZY	AA		J	Capacitor 0.1 16V Ceramic
C8357	VCKYCZ1CF104ZY	AA		J	Capacitor 0.1 16V Ceramic
C8358	VCKYCZ1CF104ZY	AA		J	Capacitor 0.1 16V Ceramic
C8359	VCKYCZ1CF104ZY	AA		J	Capacitor 0.1 16V Ceramic
C8360	VCKYCZ1CF104ZY	AA		J	Capacitor 0.1 16V Ceramic
C8361	VCKYCZ1CF104ZY	AA		J	Capacitor 0.1 16V Ceramic
C8362	VCKYCZ1CF104ZY	AA		J	Capacitor 0.1 16V Ceramic
C8363	VCKYCZ1CF104ZY	AA		J	Capacitor 0.1 16V Ceramic
C8364	VCKYCZ1CF104ZY	AA		J	Capacitor 0.1 16V Ceramic
C8365	VCKYCZ1CF104ZY	AA		J	Capacitor 0.1 16V Ceramic
C8366	VCKYCZ1CF104ZY	AA		J	Capacitor 0.1 16V Ceramic
C8367	VCKYCZ1CF104ZY	AA		J	Capacitor 0.1 16V Ceramic
C8368	VCKYCZ1CF104ZY	AA		J	Capacitor 0.1 16V Ceramic
C8369	VCKYCZ1CF104ZY	AA		J	Capacitor 0.1 16V Ceramic
C8370	VCKYCZ1CF104ZY	AA		J	Capacitor 0.1 16V Ceramic
C8371	VCKYCZ1CF104ZY	AA		J	Capacitor 0.1 16V Ceramic
C8372	VCKYCZ1CF104ZY	AA		J	Capacitor 0.1 16V Ceramic
C8373	VCKYCZ1CF104ZY	AA		J	Capacitor 0.1 16V Ceramic
C8374	VCKYCZ1CF104ZY	AA		J	Capacitor 0.1 16V Ceramic
C8375	VCKYCZ1CF104ZY	AA		J	Capacitor 0.1 16V Ceramic
C8376	VCKYCZ1CF104ZY	AA		J	Capacitor 0.1 16V Ceramic
C8377	VCKYCZ1CF104ZY	AA		J	Capacitor 0.1 16V Ceramic
C8378	VCKYCZ1CF104ZY	AA		J	Capacitor 0.1 16V Ceramic
C8379	RC-KZA195WJZZY	AB		J	Capacitor 10 10V Ceramic
C8380	RC-KZA195WJZZY	AB		J	Capacitor 10 10V Ceramic
C8381	VCKYCZ1CF104ZY	AA		J	Capacitor 0.1 16V Ceramic
C8382	VCKYCZ1CF104ZY	AA		J	Capacitor 0.1 16V Ceramic
C8383	VCKYCZ1CF104ZY	AA		J	Capacitor 0.1 16V Ceramic
C8384	VCKYCZ1CF104ZY	AA		J	Capacitor 0.1 16V Ceramic
C8385	VCKYCZ1CF104ZY	AA		J	Capacitor 0.1 16V Ceramic
C8386	VCKYCZ1CF104ZY	AA		J	Capacitor 0.1 16V Ceramic
C8387	VCKYCZ1CF104ZY	AA		J	Capacitor 0.1 16V Ceramic
C8388	VCKYCZ1CF104ZY	AA		J	Capacitor 0.1 16V Ceramic
C8389	VCKYCZ1CF104ZY	AA		J	Capacitor 0.1 16V Ceramic
C8390	VCKYCZ1CF104ZY	AA		J	Capacitor 0.1 16V Ceramic
C8391	VCKYCZ1CF104ZY	AA		J	Capacitor 0.1 16V Ceramic
C8392	VCKYCZ1CF104ZY	AA		J	Capacitor 0.1 16V Ceramic
C8393	VCKYCZ1CF104ZY	AA		J	Capacitor 0.1 16V Ceramic
C8394	VCKYCZ1CF104ZY	AA		J	Capacitor 0.1 16V Ceramic
C8395	VCKYCZ1CF104ZY	AA		J	Capacitor 0.1 16V Ceramic
C8397	VCAAPE0JJ107MY	AE		J	Capacitor 100 6.3V Electrolytic
C8702	VCKYCZ1CF104ZY	AA		J	Capacitor 0.1 16V Ceramic
C8703	VCKYCZ1CF104ZY	AA		J	Capacitor 0.1 16V Ceramic
C8704	VGCCZ1HH1R0CY	AB		J	Capacitor 10p 50V Ceramic
C8705	VGCCZ1HH1R0CY	AB		J	Capacitor 10p 50V Ceramic
C8707	VCKYCZ1CF104ZY	AA		J	Capacitor 0.1 16V Ceramic
C8709	VCKYCZ1CF104ZY	AA		J	Capacitor 0.1 16V Ceramic
C8715	RC-KZA195WJZZY	AB		J	Capacitor 10 10V Ceramic
C8717	VGCCZ1HH680JY	AB		J	Capacitor 68p 50V Ceramic
C8718	RC-KZA114WJZZY	AB		J	Capacitor 1 25V Ceramic
C9101	VCKYCZ1CF104ZY	AA		J	Capacitor 0.1 16V Ceramic
C9104	VCKYCZ1CF104ZY	AA		J	Capacitor 0.1 16V Ceramic
C9105	VCKYCZ1CF104ZY	AA		J	Capacitor 0.1 16V Ceramic
C9106	VCKYCZ1CF104ZY	AA		J	Capacitor 0.1 16V Ceramic
C9107	VCKYCZ1CF104ZY	AA		J	Capacitor 0.1 16V Ceramic
C9108	VCKYCZ1CF104ZY	AA		J	Capacitor 0.1 16V Ceramic
C9109	VCKYCZ1CF104ZY	AA		J	Capacitor 0.1 16V Ceramic
C9110	VCKYCZ1CF104ZY	AA		J	Capacitor 0.1 16V Ceramic
C9111	VCKYCZ1CF104ZY	AA		J	Capacitor 0.1 16V Ceramic
C9112	VCKYCZ1CF104ZY	AA		J	Capacitor 0.1 16V Ceramic
C9113	VCKYCZ1CF104ZY	AA		J	Capacitor 0.1 16V Ceramic
C9114	VCKYCZ1CF104ZY	AA		J	Capacitor 0.1 16V Ceramic
C9115	VCKYCZ1HB102KY	AB		J	Capacitor 1000p 50V Ceramic
C9117	VCKYCZ1CF104ZY	AA		J	Capacitor 0.1 16V Ceramic
C9301	VCKYCZ1CF104ZY	AA		J	Capacitor 0.1 16V Ceramic
C9601	VCKYCZ1EB822KY	AA		J	Capacitor 8200p 25V Ceramic
C9602	VCKYCZ1EB682KY	AB		J	Capacitor 6800p 25V Ceramic
C9603	VCKYCZ1HB221KY	AA		J	Capacitor 220p 50V Ceramic
C9604	VCKYCZ1CF104ZY	AA		J	Capacitor 0.1 16V Ceramic
C9605	VCKYCZ1EB822KY	AA		J	Capacitor 8200p 25V Ceramic
C9606	VCKYCZ1EB103KY	AA		J	Capacitor 0.01 25V Ceramic
C9607	VCKYCZ1CB153KY	AB		J	Capacitor 0.015 16V Ceramic
C9608	VCKYCZ1CF104ZY	AA		J	Capacitor 0.1 16V Ceramic
C9609	VCKYCZ1HB332KY	AA		J	Capacitor 3300p 50V Ceramic
C9610	VGCCZ1HH101JY	AB		J	Capacitor 100p 50V Ceramic
C9611	RC-KZA114WJZZY	AB		J	Capacitor 1 25V Ceramic
C9612	VCKYCZ1HB332KY	AA		J	Capacitor 3300p 50V Ceramic
C9613	VCKYCZ1EB682KY	AB		J	Capacitor 6800p 25V Ceramic
C9614	VGCCZ1HH101JY	AB		J	Capacitor 100p 50V Ceramic
C9615	VCKYCZ1CF104ZY	AA		J	Capacitor 0.1 16V Ceramic
C9616	VCKYCZ1HB472KY	AA		J	Capacitor 4700p 50V Ceramic
C9617	RC-KZA383WJZZY	AC		J	Capacitor 10 25V Ceramic
C9618	VCAAPD1DJ476MY	AF		J	Capacitor 47 20V Electrolytic
C9619	RC-KZA383WJZZY	AC		J	Capacitor 10 25V Ceramic

NO.	PARTS CODE	PRICE RANK	NEW MARK	PART DELIVERY	DESCRIPTION
[3] DUNTKE186FM02(MAIN Unit)					
C9620	RC-KZA383WJZZY	AC		J	Capacitor 10 25V Ceramic
C9621	RC-KZA195WJZZY	AB		J	Capacitor 10 10V Ceramic
C9622	VCKYCZ1CF104ZY	AA		J	Capacitor 0.1 16V Ceramic
C9623	RC-KZA195WJZZY	AB		J	Capacitor 10 10V Ceramic
C9624	RC-KZA195WJZZY	AB		J	Capacitor 10 10V Ceramic
C9625	RC-KZA114WJZZY	AB		J	Capacitor 1 25V Ceramic
C9626	VCCCCZ1HH101JY	AB		J	Capacitor 100p 50V Ceramic
C9627	RC-KZA383WJZZY	AC		J	Capacitor 10 25V Ceramic
C9629	RC-KZA195WJZZY	AB		J	Capacitor 10 10V Ceramic
C9630	RC-KZA383WJZZY	AC		J	Capacitor 10 25V Ceramic
C9631	VCKYCZ1HB222KY	AB		J	Capacitor 2200p 50V Ceramic
C9633	VCKYCZ1HB222KY	AB		J	Capacitor 2200p 50V Ceramic
C9634	RC-KZA195WJZZY	AB		J	Capacitor 10 10V Ceramic
C9636	RC-KZA195WJZZY	AB		J	Capacitor 10 10V Ceramic
C9638	RC-KZA195WJZZY	AB		J	Capacitor 10 10V Ceramic
C9640	VCKYCZ1HB332KY	AA		J	Capacitor 3300p 50V Ceramic
C9641	VCKYCZ1EB822KY	AA		J	Capacitor 8200p 25V Ceramic
C9642	RC-KZA195WJZZY	AB		J	Capacitor 10 10V Ceramic
C9643	VCKYCZ1EB682KY	AB		J	Capacitor 6800p 25V Ceramic
C9644	RC-KZA195WJZZY	AB		J	Capacitor 10 10V Ceramic
C9647	RC-KZA195WJZZY	AB		J	Capacitor 10 10V Ceramic
C9648	VCKYCZ1HB221KY	AA		J	Capacitor 220p 50V Ceramic
C9649	RC-KZA195WJZZY	AB		J	Capacitor 10 10V Ceramic
C9650	VCKYCZ1CF104ZY	AA		J	Capacitor 0.1 16V Ceramic
C9651	VCKYCZ1EB682KY	AB		J	Capacitor 6800p 25V Ceramic
C9652	VCCCCZ1HH101JY	AB		J	Capacitor 100p 50V Ceramic
C9653	VCKYCZ1EB822KY	AA		J	Capacitor 8200p 25V Ceramic
C9654	VCKYCZ1CF104ZY	AA		J	Capacitor 0.1 16V Ceramic
C9655	VCKYCZ1EB103KY	AA		J	Capacitor 0.01 25V Ceramic
C9656	VCKYCZ1CF104ZY	AA		J	Capacitor 0.1 16V Ceramic
C9657	RC-KZA114WJZZY	AB		J	Capacitor 1 25V Ceramic
C9658	VCCCCZ1HH101JY	AB		J	Capacitor 100p 50V Ceramic
C9659	VCCCCZ1HH101JY	AB		J	Capacitor 100p 50V Ceramic
C9660	VCKYCZ1CF104ZY	AA		J	Capacitor 0.1 16V Ceramic
C9661	RC-KZA383WJZZY	AC		J	Capacitor 10 25V Ceramic
C9662	VCAAPD1DJ476MY	AF		J	Capacitor 47 20V Electrolytic
C9663	RC-KZA383WJZZY	AC		J	Capacitor 10 25V Ceramic
C9664	RC-KZA114WJZZY	AB		J	Capacitor 1 25V Ceramic
C9665	RC-KZA383WJZZY	AC		J	Capacitor 10 25V Ceramic
C9666	VCKYCZ1HB222KY	AB		J	Capacitor 2200p 50V Ceramic
C9668	RC-KZA383WJZZY	AC		J	Capacitor 10 25V Ceramic
C9669	VCKYCZ1HB222KY	AB		J	Capacitor 2200p 50V Ceramic
C9671	VCAAPE0JJ227MY	AE		J	Capacitor 220 6.3V Electrolytic
C9672	VCAAPE0JJ227MY	AE		J	Capacitor 220 6.3V Electrolytic
C9673	VCAAPE0JJ227MY	AE		J	Capacitor 220 6.3V Electrolytic
C9674	VCAAPE0JJ107MY	AE		J	Capacitor 100 6.3V Electrolytic
C9675	VCAAPE0JJ227MY	AE		J	Capacitor 220 6.3V Electrolytic
D1101	VHD1SS355//--1Y	AB		J	Diode 1SS355TE-17
D1102	VHD1SS355//--1Y	AB		J	Diode 1SS355TE-17
D1502	VHDDAN222//--1Y	AA		J	Diode DAN222TL
D1503	VHDDAN222//--1Y	AA		J	Diode DAN222TL
D1504	RH-EXA523WJZZY	AB	N	R	Zener Diode MAZ8056GML
D1506	RH-EXA523WJZZY	AB	N	R	Zener Diode MAZ8056GML
D1507	RH-EXA523WJZZY	AB	N	R	Zener Diode MAZ8056GML
D1508	RH-EXA523WJZZY	AB	N	R	Zener Diode MAZ8056GML
D1509	VHDRB520S30-1Y	AC		J	Diode RB520S-30TE61
D1512	VHDDAN222//--1Y	AA		J	Diode DAN222TL
D1513	VHD1SS355//--1Y	AB		J	Diode 1SS355TE-17
D1515	VHD1SS355//--1Y	AB		J	Diode 1SS355TE-17
D1519	RH-EX0259TAZZY	AB		J	Zener Diode PDZ5.6B,115
D1802	VHD1SS355//--1Y	AB		J	Diode 1SS355TE-17
D2003	RH-PXA037WJZZY	AB		J	Diode SML-310MTT86
D2401	VHDMA3120WA-1Y	AD		J	Diode MAZ3120D0L
D2402	VHDMA3120WA-1Y	AD		J	Diode MAZ3120D0L
D2403	RH-EX0259TAZZY	AB		J	Zener Diode PDZ5.6B,115
D2404	VHD1PS184++-1Y	AB		J	Diode 1PS184,115
D2405	VHD1PS184++-1Y	AB		J	Diode 1PS184,115
D3301	VHDDAN217U+-1Y	AB		J	Diode DAN217UT106
D3302	VHDDAN217U+-1Y	AB		J	Diode DAN217UT106
D3303	VHDDAN217U+-1Y	AB		J	Diode DAN217UT106
D8101	RH-PXA037WJZZY	AB		J	Diode SML-310MTT86
D8102	RH-PXA037WJZZY	AB		J	Diode SML-310MTT86
D8103	RH-EXA523WJZZY	AB	N	R	Zener Diode MAZ8056GML
D8104	RH-EXA523WJZZY	AB	N	R	Zener Diode MAZ8056GML
D9601	VHDDAN217U+-1Y	AB		J	Diode DAN217UT106
D9602	VHD1SS355//--1Y	AB		J	Diode 1SS355TE-17
D9604	VHDD1FH3+++1Y	AD		J	Diode D1FH3
D9605	VHD1SS355//--1Y	AB		J	Diode 1SS355TE-17
D9606	RH-EX1395CEZZY	AC		J	Zener Diode UDZSNPTE-176.2B
D9607	VHD1SS355//--1Y	AB		J	Diode 1SS355TE-17
D9608	VHD1SS355//--1Y	AB		J	Diode 1SS355TE-17
D9609	RH-EX1227CEZZY	AB		J	Zener Diode HZU2.7B1TRF-E
D9610	VHDDAN217U+-1Y	AB		J	Diode DAN217UT106
D9611	VHD1SS355//--1Y	AB		J	Diode 1SS355TE-17
D9612	RH-EXA089WJZZY	AB		J	Zener Diode UDZSNPTE-174.3B

NO.	PARTS CODE	PRICE RANK	NEW MARK	PART DELIVERY	DESCRIPTION
[3] DUNTKE186FM02(MAIN Unit)					
FB1101	RBLN-A204WJZZY	AA		J	Balun BLN-A204WJ
FB1102	RBLN-A204WJZZY	AA		J	Balun BLN-A204WJ
FB1103	RBLN-A204WJZZY	AA		J	Balun BLN-A204WJ
FB1104	RBLN-A204WJZZY	AA		J	Balun BLN-A204WJ
FB1105	RBLN-A204WJZZY	AA		J	Balun BLN-A204WJ
FB1501	RBLN-0061TAZZY	AD		J	Balun BLN-0061TA
FB1502	RBLN-0061TAZZY	AD		J	Balun BLN-0061TA
FB1503	RBLN-0061TAZZY	AD		J	Balun BLN-0061TA
FB1504	RBLN-0061TAZZY	AD		J	Balun BLN-0061TA
FB1505	RBLN-0077TAZZY	AB		J	Balun BLN-0077TA
FB1506	RBLN-0077TAZZY	AB		J	Balun BLN-0077TA
FB1507	RBLN-0077TAZZY	AB		J	Balun BLN-0077TA
FB1508	RBLN-0077TAZZY	AB		J	Balun BLN-0077TA
FB1509	RBLN-A274WJZZY	AB		J	Balun BLN-A274WJ
FB1510	RBLN-A274WJZZY	AB		J	Balun BLN-A274WJ
FB1515	RBLN-A274WJZZY	AB		J	Balun BLN-A274WJ
FB2001	RBLN-0061TAZZY	AD		J	Balun BLN-0061TA
FB2002	RBLN-A188WJZZY	AA		J	Balun BLN-A188WJ
FB2003	RBLN-0061TAZZY	AD		J	Balun BLN-0061TA
FB2004	RBLN-0061TAZZY	AD		J	Balun BLN-0061TA
FB2005	RBLN-0061TAZZY	AD		J	Balun BLN-0061TA
FB2006	RBLN-A188WJZZY	AA		J	Balun BLN-A188WJ
FB2007	RBLN-0061TAZZY	AD		J	Balun BLN-0061TA
FB2008	RBLN-0061TAZZY	AD		J	Balun BLN-0061TA
FB2009	RBLN-0061TAZZY	AD		J	Balun BLN-0061TA
FB2010	RBLN-0061TAZZY	AD		J	Balun BLN-0061TA
FB2011	RBLN-0061TAZZY	AD		J	Balun BLN-0061TA
FB2402	RBLN-0061TAZZY	AD		J	Balun BLN-0061TA
FB2403	RBLN-0061TAZZY	AD		J	Balun BLN-0061TA
FB2404	RBLN-0061TAZZY	AD		J	Balun BLN-0061TA
FB3303	RBLN-A021WJZZY	AA		J	Balun BLN-A021WJ
FB3304	RBLN-A021WJZZY	AA		J	Balun BLN-A021WJ
FB3305	RBLN-A021WJZZY	AA		J	Balun BLN-A021WJ
FB3306	RBLN-A021WJZZY	AA		J	Balun BLN-A021WJ
FB3307	RBLN-A274WJZZY	AB		J	Balun BLN-A274WJ
FB3308	RBLN-A274WJZZY	AB		J	Balun BLN-A274WJ
FB3309	RBLN-A274WJZZY	AB		J	Balun BLN-A274WJ
FB3310	RBLN-A274WJZZY	AB		J	Balun BLN-A274WJ
FB3311	RBLN-A274WJZZY	AB		J	Balun BLN-A274WJ
FB3312	RBLN-A021WJZZY	AA		J	Balun BLN-A021WJ
FB3313	RBLN-A274WJZZY	AB		J	Balun BLN-A274WJ
FB3314	RBLN-A274WJZZY	AB		J	Balun BLN-A274WJ
FB3315	RBLN-A274WJZZY	AB		J	Balun BLN-A274WJ
FB3501	RBLN-A274WJZZY	AB		J	Balun BLN-A274WJ
FB4402	RBLN-0210TAZZY	AB		J	Balun BLN-0210TA
FB8101	RBLN-A188WJZZY	AA		J	Balun BLN-A188WJ
FB8102	RBLN-A188WJZZY	AA		J	Balun BLN-A188WJ
FB8103	RBLN-A188WJZZY	AA		J	Balun BLN-A188WJ
FB8104	RBLN-A188WJZZY	AA		J	Balun BLN-A188WJ
FB8105	RBLN-A188WJZZY	AA		J	Balun BLN-A188WJ
FB8106	RBLN-A188WJZZY	AA		J	Balun BLN-A188WJ
FB8107	RBLN-A188WJZZY	AA		J	Balun BLN-A188WJ
FB8108	RBLN-A188WJZZY	AA		J	Balun BLN-A188WJ
FB8109	RBLN-A188WJZZY	AA		J	Balun BLN-A188WJ
FB8110	RBLN-A188WJZZY	AA		J	Balun BLN-A188WJ
FB8111	RBLN-A188WJZZY	AA		J	Balun BLN-A188WJ
FB8112	RBLN-A188WJZZY	AA		J	Balun BLN-A188WJ
FB8113	RBLN-A188WJZZY	AA		J	Balun BLN-A188WJ
FB8114	RBLN-A188WJZZY	AA		J	Balun BLN-A188WJ
FB8115	RBLN-A188WJZZY	AA		J	Balun BLN-A188WJ
FB8116	RBLN-A188WJZZY	AA		J	Balun BLN-A188WJ
FB8117	RBLN-A188WJZZY	AA		J	Balun BLN-A188WJ
FB8118	RBLN-A188WJZZY	AA		J	Balun BLN-A188WJ
FB8119	RBLN-A188WJZZY	AA		J	Balun BLN-A188WJ
FB8120	RBLN-A188WJZZY	AA		J	Balun BLN-A188WJ
FB8121	RBLN-A188WJZZY	AA		J	Balun BLN-A188WJ
FB8701	RBLN-A274WJZZY	AB		J	Balun BLN-A274WJ
FB9603	RBLN-0207TAZZY	AB		J	Balun BLN-0207TA
FL1501	RF iLN0003TAZZY	AD		J	Filter
FL1502	RF iLN0003TAZZY	AD		J	Filter
FL1503	RF iLN0003TAZZY	AD		J	Filter
FL2001	RF iLZA023WJQZY	AD		J	Filter
IC1501	RH-iXC285WJQZS	AL		J	IC IC HDMI EXT5
IC1502	RH-iXC286WJQZS	AL		J	IC IC HDMI EXT6
IC1503	RH-iXC287WJQZS	AH		J	IC IC RGB (PC) EXT7
IC1504	VH iNJM2750M-1Y	AH		J	IC NJM2750M(TE2)
IC1506	VH iTC7W08U/-1Y	AD		J	IC TC7W08FU(TE12L,F)
IC1507	VH iSi i9185+-1Q	AP	N	J	IC SiI9185CTU
IC1805	VH iBH33FB1G-1Y	AD		J	IC BH33FB1WG-TR
IC2001	VH iBD5224G+-1Y	AD		J	IC BD5224G-TR
IC2002	RH-iXB986WJN8Q	AW	N	J	IC IC MONITOR MICON
IC2004	VH iBR24L08F-1Y	AE		J	IC BR24L08F-WE2
IC2006	VH iTCVHC32T-1Y	AE		J	IC TC74VHC32FT(EL)
IC2008	VH i7WH126FU-1Y	AE		J	IC TC7WH126FU(TE12L,F)
IC2009	VH iLCX125FT-1Y	AD		J	IC TC74LCX125FT(EL,K)

LC-42X20E/S/RU

NO.	PARTS CODE	PRICE RANK	NEW MARK	PART DELIVERY	DESCRIPTION
[3] DUNTKE186FM02(MAIN Unit)					
IC2010	VHiTC7W00U/-1Y	AE		J	IC TC7W00FU(TE12L,F)
IC2011	VHiTC7W08U/-1Y	AD		J	IC TC7W08FU(TE12L,F)
IC2401	VHi7WH126FU-1Y	AE		J	IC TC7WH126FU(TE12L,F)
IC2402	VHiLCX157FT-1Y	AD		J	IC TC74LCX157FT(EKJ)
IC2403	VHiSL83220-1Y	AQ		J	IC ISL83220ECVZ-T
IC2601	VHiTC7W66U/-1Y	AE		J	IC TC7W66FU(TE12L,F)
IC2602	VHiM62332FP-1Y	AL		J	IC M62332FPCF5J
IC3301	RH-iXC010WJQZQ	BU	N	R	IC SVP-WX68(7568W-LF)
IC3501	RH-iXC163WJQZQ	AZ	N	R	IC K4D263238-VC40
IC3502	RH-iXC163WJQZQ	AZ	N	R	IC K4D263238-VC40
IC4401	VHiLCX245FT-1Y	AD		J	IC TC74LCX245FT(EKJ)
IC4402	VHiLCX573FT-1Y	AF		J	IC TC74LCX573FT(EKJ)
IC4403	VHiTC7SH08U-1Y	AF		J	IC TC7SH08FU(TE85L,JF)
IC4404	VHiLCX244FT-1Y	AE		J	IC TC74LCX244FT(EL,K)
IC4405	VHiLCX573FT-1Y	AF		J	IC TC74LCX573FT(EKJ)
IC4406	VHiAHC1G32W-1Y	AD		J	IC 74AHC1G32GW,125
IC4408	VHiAHC1G02W-1Y	AD		J	IC 74AHC1G02GW,125
IC8101	RH-iXC011WJQZQ	BU	N	R	IC HiDTVPro-LX66(8166LF)
IC8301	RH-iXC154WJQZQ	AZ	N	R	IC K4N56163QI-ZC2A
IC8302	RH-iXC154WJQZQ	AZ	N	R	IC K4N56163QI-ZC2A
IC8303	RH-iXC154WJQZQ	AZ	N	R	IC K4N56163QI-ZC2A
IC8304	RH-iXC154WJQZQ	AZ	N	R	IC K4N56163QI-ZC2A
IC8701	VHiS29GL128-1Q	AZ		J	IC S29GL128N90TFIR20H
IC8702	RH-iXC150WJQZY	AQ	N	R	IC ICS475GI-14LFT
IC8704	VHiS24CS64A-1Y	AF		R	IC S-24CS64AOI-J8T1G
IC9101	RH-iXC121WJQZQ	AX	N	R	IC XC95288XL-10TQG144C
IC9104	VHiTCLCX08FT1Y	AD		J	IC TC74LCX08FT(EL,K)
IC9105	VHi74VHC541-1Y	AE		J	IC TC74VHC541FT(EKJ)
IC9106	VHi74VHC04T-1Y	AD	N	R	IC TC74VHC04FT(EL,K)
IC9301	VHiLTC1694C-1Y	AM		J	IC LTC1694CS5#TRPBF
IC9601	VHiTPS40055-1Y	AN		J	IC TPS40055PWPR
IC9602	VHiMP2367DN-1Y	AH		J	IC MP2367DN-LF-Z
IC9603	VHiTPS40055-1Y	AN		J	IC TPS40055PWPR
IC9604	VHiTPS40055-1Y	AN		J	IC TPS40055PWPR
IC9605	VHiPQ025ENA-1Y	AE		J	IC PQ025ENA1ZPH
IC9606	VHiTPS40055-1Y	AN		J	IC TPS40055PWPR
J1501	QJAKEA073WJZZ	AD		J	Jack HDMI Input
J1502	QJAKEA073WJZZ	AD		J	Jack HDMI Input
L1103	VPCBN100J1R2NY	AB		R	Coil Peaking 10uH
L1104	VPCNN120J1R9NY	AB		J	Coil Peaking 12uH
L1105	VPCNN120J1R9NY	AB		J	Coil Peaking 12uH
L1106	VPCNN120J1R9NY	AB		J	Coil Peaking 12uH
L1506	RCiLFA116WJZZY	AE		J	Coil
L1507	RCiLFA116WJZZY	AE		J	Coil
L1508	RCiLFA116WJZZY	AE		J	Coil
L1509	RCiLFA116WJZZY	AE		J	Coil
L1510	RCiLFA116WJZZY	AE		J	Coil
L1511	RCiLFA116WJZZY	AE		J	Coil
L1512	RCiLFA116WJZZY	AE		J	Coil
L1513	RCiLFA116WJZZY	AE		J	Coil
L2601	RCiLFA154WJZZY	AC		J	Coil
L2602	RCiLFA154WJZZY	AC		J	Coil
L2603	RCiLFA154WJZZY	AC		J	Coil
L2604	RCiLFA154WJZZY	AC		J	Coil
L2605	RCiLFA154WJZZY	AC		J	Coil
L2606	RCiLFA154WJZZY	AC		J	Coil
L2607	RCiLFA154WJZZY	AC		J	Coil
L2608	RCiLFA154WJZZY	AC		J	Coil
L2609	RCiLFA154WJZZY	AC		J	Coil
L2610	RCiLFA154WJZZY	AC		J	Coil
L2611	RCiLFA154WJZZY	AC		J	Coil
L2612	RCiLFA154WJZZY	AC		J	Coil
L3301	VPCWM2R2MR10NY	AC		R	Coil Peaking 2.2uH
L3302	VPCWM2R2MR10NY	AC		R	Coil Peaking 2.2uH
L3303	VPCWM2R2MR10NY	AC		R	Coil Peaking 2.2uH
L3304	VPCWM2R2MR10NY	AC		R	Coil Peaking 2.2uH
L3305	VPCWM2R2MR10NY	AC		R	Coil Peaking 2.2uH
L3306	VPCWM2R2MR10NY	AC		R	Coil Peaking 2.2uH
L9601	RCiLPA086WJZZY	AE		J	Coil
L9602	RCiLPA084WJZZY	AE		J	Coil
L9603	RCiLPA084WJZZY	AE		J	Coil
L9604	RCiLPA084WJZZY	AE		J	Coil
L9605	RCiLPA086WJZZY	AE		J	Coil
L9606	RCiLPA765WJQZY	AE	N	R	Coil
LUG1010	QEARBA014WJFN	AE		R	Lug
LUG1101	QLUGHA006WJZZY	AC		J	Lug
LUG1102	QLUGHA006WJZZY	AC		J	Lug
LUG1103	QLUGHA006WJZZY	AC		J	Lug
LUG1104	QLUGHA006WJZZY	AC		J	Lug
LUG1105	QLUGHA006WJZZY	AC		J	Lug
P1101	QPLGNA348WJZZY	AE		J	Plug 14Pin(US)
P1102	QPLGNA337WJZZY	AC		J	Plug 3PIN(U2)
P1103	QPLGNA342WJZZY	AD		J	Plug 8Pin(FE)
P2002	QPLGNA338WJZZY	AD		J	Plug 4Pin(KM)
P2003	QPLGNA349WJZZY	AE		J	Plug 15Pin(RA)

NO.	PARTS CODE	PRICE RANK	NEW MARK	PART DELIVERY	DESCRIPTION
[3] DUNTKE186FM02(MAIN Unit)					
P2401	QPLGNA144WJZZY	AF		J	Plug 20Pin
P2601	QCNCWA507WJQZY	AM		J	Connector 41Pin(LW)
P2602	QPLGNA331WJZZY	AD		J	Plug 11Pin(LP)
P2603	QPLGNA343WJZZY	AD		J	Plug 9Pin(LB)
P9101	QPLGN0056CEZZY	AD		J	Plug 6Pin(Program Port)
P9601	QPLGNA168WJZZY	AF		J	Plug 12Pin(PD)
Q1104	VS2SC3928AR-1Y	AA		J	Transistor 2SC3928A-T112-1R
Q1105	VS2SC3928AR-1Y	AA		J	Transistor 2SC3928A-T112-1R
Q1106	VS2SC3928AR-1Y	AA		J	Transistor 2SC3928A-T112-1R
Q1115	VS2SC3928AR-1Y	AA		J	Transistor 2SC3928A-T112-1R
Q1116	VS2SC3928AR-1Y	AA		J	Transistor 2SC3928A-T112-1R
Q1117	VS2SC3928AR-1Y	AA		J	Transistor 2SC3928A-T112-1R
Q1118	VSDTC144EE/-1Y	AA		J	Transistor DTC144EETL
Q1119	VSDTC144EE/-1Y	AA		J	Transistor DTC144EETL
Q1120	VSDTC144EE/-1Y	AA		J	Transistor DTC144EETL
Q1122	VSDTC144EE/-1Y	AA		J	Transistor DTC144EETL
Q1501	VSIMD2A///-1Y	AC		J	Transistor IMD2AT108
Q1509	VSKTA1535T+-1Y	AC		J	Transistor KTA1535T-RTK/P
Q1510	VSRT1N141U/-1Y	AB		J	Transistor RT1N141U-T111-1
Q1516	VSIMD2A///-1Y	AC		J	Transistor IMD2AT108
Q1802	VSDTC144EE/-1Y	AA		J	Transistor DTC144EETL
Q1803	VSDTA124EKA-1Y	AB		J	Transistor DTA124EKAT146
Q1808	VSRT1N144U/-1Y	AB		J	Transistor RT1N144U-T111-1
Q1809	VS2SA1530AR-1Y	AB		J	Transistor 2SA1530A-T112-1R
Q2004	VSRN1102///-1Y	AB		J	Transistor RN1102(TE85L,F)
Q2601	VSUM6K1NTN+-1Y	AC		J	Transistor UM6K1N TN
Q4401	RH-TXA026WJZZY	AD		J	Transistor PBL52001D,115
Q8703	VS2SC3928AR-1Y	AA		J	Transistor 2SC3928A-T112-1R
Q9101	VSDTC144EE/-1Y	AA		J	Transistor DTC144EETL
Q9102	VSDTC144EE/-1Y	AA		J	Transistor DTC144EETL
Q9601	VS2SC3928AR-1Y	AA		J	Transistor 2SC3928A-T112-1R
Q9603	VSRT1N144U/-1Y	AB		J	Transistor RT1N144U-T111-1
Q9604	VS2SC3928AR-1Y	AA		J	Transistor 2SC3928A-T112-1R
Q9605	VS2SC3928AR-1Y	AA		J	Transistor 2SC3928A-T112-1R
Q9606	VSSP8K4++++-1Y	AF		J	Transistor SP8K4TB
Q9607	VSSP8K4++++-1Y	AF		J	Transistor SP8K4TB
Q9608	VS2SC3928AR-1Y	AA		J	Transistor 2SC3928A-T112-1R
Q9609	VSSP8K4++++-1Y	AF		J	Transistor SP8K4TB
Q9610	VSSP8K4++++-1Y	AF		J	Transistor SP8K4TB
R1101	VRS-CZ1JF470JY	AA		J	Resistor 47 1/16W Metal Oxide
R1103	VRS-CZ1JF000JY	AA		J	Resistor 0 1/16W Metal Oxide
R1104	VRS-CZ1JF000JY	AA		J	Resistor 0 1/16W Metal Oxide
R1105	VRS-CZ1JF750JY	AA		J	Resistor 75 1/16W Metal Oxide
R1106	VRS-CZ1JF750JY	AA		J	Resistor 75 1/16W Metal Oxide
R1112	VRS-CZ1JF101JY	AA		J	Resistor 100 1/16W Metal Oxide
R1113	VRS-CZ1JF101JY	AA		J	Resistor 100 1/16W Metal Oxide
R1114	VRS-CZ1JF101JY	AA		J	Resistor 100 1/16W Metal Oxide
R1116	VRS-CZ1JF471JY	AA		J	Resistor 470 1/16W Metal Oxide
R1121	VRS-TV1JD102JY	AA		J	Resistor 1k 1/16W Metal Oxide
R1122	VRS-TV1JD102JY	AA		J	Resistor 1k 1/16W Metal Oxide
R1123	VRS-TV1JD102JY	AA		J	Resistor 1k 1/16W Metal Oxide
R1128	VRS-CZ1JF471JY	AA		J	Resistor 470 1/16W Metal Oxide
R1132	VRS-CZ1JF471JY	AA		J	Resistor 470 1/16W Metal Oxide
R1133	VRS-CZ1JF000JY	AA		J	Resistor 0 1/16W Metal Oxide
R1135	VRS-CZ1JF000JY	AA		J	Resistor 0 1/16W Metal Oxide
R1142	VRS-CZ1JF102JY	AA		J	Resistor 1k 1/16W Metal Oxide
R1151	VRS-CZ1JF101JY	AA		J	Resistor 100 1/16W Metal Oxide
R1152	VRS-CZ1JF563JY	AA		J	Resistor 56k 1/16W Metal Oxide
R1153	VRS-CZ1JF123JY	AA		J	Resistor 12k 1/16W Metal Oxide
R1154	VRS-CZ1JF333JY	AA		J	Resistor 33k 1/16W Metal Oxide
R1155	VRS-CZ1JF104JY	AA		J	Resistor 100k 1/16W Metal Oxide
R1156	VRS-CZ1JF393JY	AA		J	Resistor 39k 1/16W Metal Oxide
R1157	VRS-CZ1JF272JY	AA		J	Resistor 2.7k 1/16W Metal Oxide
R1158	VRS-CZ1JF223JY	AA		J	Resistor 22k 1/16W Metal Oxide
R1159	VRS-CZ1JF473JY	AA		J	Resistor 47k 1/16W Metal Oxide
R1160	VRS-CZ1JF822JY	AA		J	Resistor 8.2k 1/16W Metal Oxide
R1162	VRS-CZ1JF103JY	AA		J	Resistor 10k 1/16W Metal Oxide
R1164	VRS-CZ1JF103JY	AA		J	Resistor 10k 1/16W Metal Oxide
R1166	VRS-TV1JD000JY	AA		J	Resistor 0 1/16W Metal Oxide
R1503	VRS-CZ1JF102JY	AA		J	Resistor 1k 1/16W Metal Oxide
R1504	VRS-CZ1JF102JY	AA		J	Resistor 1k 1/16W Metal Oxide
R1506	VRS-CZ1JF000JY	AA		J	Resistor 0 1/16W Metal Oxide
R1508	VRS-CZ1JF101JY	AA		J	Resistor 100 1/16W Metal Oxide
R1509	VRS-CZ1JF473JY	AA		J	Resistor 47k 1/16W Metal Oxide
R1510	VRS-CZ1JF473JY	AA		J	Resistor 47k 1/16W Metal Oxide
R1511	VRK-SA1JF100JY	AB		J	Resistor 10 1/16W Metal Composition
R1513	VRK-SB1FF101JY	AA		J	Resistor 100 1/32W Metal Composition
R1515	VRS-CZ1JF000JY	AA		J	Resistor 0 1/16W Metal Oxide
R1516	VRS-CZ1JF000JY	AA		J	Resistor 0 1/16W Metal Oxide
R1517	VRS-CZ1JF000JY	AA		J	Resistor 0 1/16W Metal Oxide
R1519	VRS-CZ1JF273JY	AA		J	Resistor 27k 1/16W Metal Oxide
R1520	VRS-CZ1JF000JY	AA		J	Resistor 0 1/16W Metal Oxide
R1521	VRS-CZ1JF000JY	AA		J	Resistor 0 1/16W Metal Oxide
R1522	VRS-CZ1JF473JY	AA		J	Resistor 47k 1/16W Metal Oxide
R1523	VRK-SA1JF100JY	AB		J	Resistor 10 1/16W Metal Composition

NO.	PARTS CODE	PRICE RANK	NEW MARK	PART DELIVERY	DESCRIPTION
[3] DUNTKE186FM02(MAIN Unit)					
R1524	VRS-CZ1JF103JY	AA		J	Resistor 10k 1/16W Metal Oxide
R1526	VRS-CZ1JF102JY	AA		J	Resistor 1k 1/16W Metal Oxide
R1527	VRS-CZ1JF473JY	AA		J	Resistor 47k 1/16W Metal Oxide
R1528	VRS-CZ1JF102JY	AA		J	Resistor 1k 1/16W Metal Oxide
R1529	VRS-CZ1JF104JY	AA		J	Resistor 100k 1/16W Metal Oxide
R1532	VRS-CZ1JF104JY	AA		J	Resistor 100k 1/16W Metal Oxide
R1533	VRS-CZ1JF102JY	AA		J	Resistor 1k 1/16W Metal Oxide
R1534	VRS-CZ1JF102JY	AA		J	Resistor 1k 1/16W Metal Oxide
R1535	VRK-SA1JF473JY	AC		J	Resistor 47k 1/16W Metal Composition
R1536	VRS-CZ1JF102JY	AA		J	Resistor 1k 1/16W Metal Oxide
R1537	VRK-SA1JF473JY	AC		J	Resistor 47k 1/16W Metal Composition
R1538	VRS-CZ1JF102JY	AA		J	Resistor 1k 1/16W Metal Oxide
R1540	VRS-CZ1JF104JY	AA		J	Resistor 100k 1/16W Metal Oxide
R1541	VRS-CZ1JF104JY	AA		J	Resistor 100k 1/16W Metal Oxide
R1542	VRS-CZ1JF331JY	AA		J	Resistor 330 1/16W Metal Oxide
R1543	VRS-CZ1JF102JY	AA		J	Resistor 1k 1/16W Metal Oxide
R1544	VRS-CZ1JF102JY	AA		J	Resistor 1k 1/16W Metal Oxide
R1552	VRS-TV1JD750JY	AA		J	Resistor 75 1/16W Metal Oxide
R1553	VRS-TV1JD750JY	AA		J	Resistor 75 1/16W Metal Oxide
R1554	VRS-TV1JD750JY	AA		J	Resistor 75 1/16W Metal Oxide
R1560	VRS-CZ1JF102JY	AA		J	Resistor 1k 1/16W Metal Oxide
R1561	VRS-CZ1JF102JY	AA		J	Resistor 1k 1/16W Metal Oxide
R1562	VRS-CZ1JF221JY	AA		J	Resistor 220 1/16W Metal Oxide
R1563	VRS-CZ1JF221JY	AA		J	Resistor 220 1/16W Metal Oxide
R1565	VRS-CZ1JF102JY	AA		J	Resistor 1k 1/16W Metal Oxide
R1568	VRS-CZ1JF103JY	AA		J	Resistor 10k 1/16W Metal Oxide
R1570	VRS-CZ1JF152JY	AA		J	Resistor 1.5k 1/16W Metal Oxide
R1575	VRK-SA1JF100JY	AB		J	Resistor 10 1/16W Metal Composition
R1579	VRS-CZ1JF000JY	AA		J	Resistor 0 1/16W Metal Oxide
R1593	VRK-SA1JF100JY	AB		J	Resistor 10 1/16W Metal Composition
R1595	VRK-SA1JF100JY	AB		J	Resistor 10 1/16W Metal Composition
R1601	VRK-SA1JF472JY	AA		R	Resistor 4.7k 1/16W Metal Composition
R1604	VRK-SA1JF100JY	AB		J	Resistor 10 1/16W Metal Composition
R1606	VRS-CZ1JF152JY	AA		J	Resistor 1.5k 1/16W Metal Oxide
R1607	VRK-SA1JF100JY	AB		J	Resistor 10 1/16W Metal Composition
R1609	VRK-SA1JF472JY	AA		R	Resistor 4.7k 1/16W Metal Composition
R1622	VRS-CZ1JF102JY	AA		J	Resistor 1k 1/16W Metal Oxide
R1801	VRS-CZ1JF472JY	AA		J	Resistor 4.7k 1/16W Metal Oxide
R1817	VRS-CZ1JF223JY	AA		J	Resistor 22k 1/16W Metal Oxide
R1819	VRS-CZ1JF473JY	AA		J	Resistor 47k 1/16W Metal Oxide
R1820	VRS-CZ1JF222JY	AA		J	Resistor 2.2k 1/16W Metal Oxide
R2001	VRS-CZ1JF101JY	AA		J	Resistor 100 1/16W Metal Oxide
R2003	VRS-CZ1JF100JY	AA		J	Resistor 10 1/16W Metal Oxide
R2004	VRS-CZ1JF103JY	AA		J	Resistor 10k 1/16W Metal Oxide
R2005	VRS-CZ1JF103JY	AA		J	Resistor 10k 1/16W Metal Oxide
R2007	VRS-CZ1JF472JY	AA		J	Resistor 4.7k 1/16W Metal Oxide
R2008	VRS-CJ1JF102JY	AA		J	Resistor 1k 1/16W Metal Oxide
R2010	VRS-CJ1JF333JY	AA		J	Resistor 33k 1/16W Metal Oxide
R2011	VRS-CZ1JF472JY	AA		J	Resistor 4.7k 1/16W Metal Oxide
R2012	VRK-SA1JF100JY	AB		J	Resistor 10 1/16W Metal Composition
R2013	VRS-CZ1JF470JY	AA		J	Resistor 47 1/16W Metal Oxide
R2016	VRS-CZ1JF103JY	AA		J	Resistor 10k 1/16W Metal Oxide
R2018	VRS-CZ1JF473JY	AA		J	Resistor 47k 1/16W Metal Oxide
R2019	VRS-CZ1JF103FY	AB		J	Resistor 10k 1/16W Metal Oxide
R2023	VRS-CZ1JF473JY	AA		J	Resistor 47k 1/16W Metal Oxide
R2024	VRS-CZ1JF102JY	AA		J	Resistor 1k 1/16W Metal Oxide
R2025	VRS-CZ1JF223JY	AA		J	Resistor 22k 1/16W Metal Oxide
R2026	VRS-CZ1JF103JY	AA		J	Resistor 10k 1/16W Metal Oxide
R2027	VRS-CZ1JF394JY	AA		J	Resistor 390k 1/16W Metal Oxide
R2028	VRS-CZ1JF106JY	AA		J	Resistor 10M 1/16W Metal Oxide
R2030	VRS-CZ1JF473JY	AA		J	Resistor 47k 1/16W Metal Oxide
R2032	VRS-CZ1JF223JY	AA		J	Resistor 22k 1/16W Metal Oxide
R2033	VRS-CZ1JF101JY	AA		J	Resistor 100 1/16W Metal Oxide
R2035	VRS-CZ1JF223JY	AA		J	Resistor 22k 1/16W Metal Oxide
R2036	VRK-SB1FF223JY	AA		J	Resistor 22k 1/32W Metal Composition
R2038	VRS-CZ1JF104JY	AA		J	Resistor 100k 1/16W Metal Oxide
R2039	VRS-CZ1JF103JY	AA		J	Resistor 10k 1/16W Metal Oxide
R2040	VRS-CZ1JF103JY	AA		J	Resistor 10k 1/16W Metal Oxide
R2041	VRS-CZ1JF152JY	AA		J	Resistor 1.5k 1/16W Metal Oxide
R2042	VRK-SB1FF101JY	AA		J	Resistor 100 1/32W Metal Composition
R2043	VRS-CZ1JF103JY	AA		J	Resistor 10k 1/16W Metal Oxide
R2044	VRS-CZ1JF100JY	AA		J	Resistor 10 1/16W Metal Oxide
R2045	VRS-CZ1JF102JY	AA		J	Resistor 1k 1/16W Metal Oxide
R2047	VRS-CZ1JF101JY	AA		J	Resistor 100 1/16W Metal Oxide
R2048	VRS-CZ1JF000JY	AA		J	Resistor 0 1/16W Metal Oxide
R2049	VRS-CZ1JF272JY	AA		J	Resistor 2.7k 1/16W Metal Oxide
R2050	VRS-CZ1JF101JY	AA		J	Resistor 100 1/16W Metal Oxide
R2051	VRK-SA1JF100JY	AB		J	Resistor 10 1/16W Metal Composition
R2052	VRS-CZ1JF101JY	AA		J	Resistor 100 1/16W Metal Oxide
R2053	VRS-CZ1JF102JY	AA		J	Resistor 1k 1/16W Metal Oxide
R2054	VRS-CZ1JF103JY	AA		J	Resistor 10k 1/16W Metal Oxide
R2055	VRS-CZ1JF103JY	AA		J	Resistor 10k 1/16W Metal Oxide
R2057	VRS-CZ1JF103JY	AA		J	Resistor 10k 1/16W Metal Oxide
R2061	VRS-CZ1JF473JY	AA		J	Resistor 47k 1/16W Metal Oxide
R2062	VRS-CZ1JF103JY	AA		J	Resistor 10k 1/16W Metal Oxide

NO.	PARTS CODE	PRICE RANK	NEW MARK	PART DELIVERY	DESCRIPTION
[3] DUNTKE186FM02(MAIN Unit)					
R2063	VRS-CZ1JF103JY	AA		J	Resistor 10k 1/16W Metal Oxide
R2066	VRS-CZ1JF473JY	AA		J	Resistor 47k 1/16W Metal Oxide
R2067	VRS-CZ1JF473JY	AA		J	Resistor 47k 1/16W Metal Oxide
R2068	VRS-CZ1JF473JY	AA		J	Resistor 47k 1/16W Metal Oxide
R2070	VRS-CZ1JF473JY	AA		J	Resistor 47k 1/16W Metal Oxide
R2071	VRS-CZ1JF100JY	AA		J	Resistor 10 1/16W Metal Oxide
R2072	VRS-CZ1JF101JY	AA		J	Resistor 100 1/16W Metal Oxide
R2074	VRS-CZ1JF103JY	AA		J	Resistor 10k 1/16W Metal Oxide
R2075	VRS-CZ1JF103JY	AA		J	Resistor 10k 1/16W Metal Oxide
R2077	VRS-CZ1JF103JY	AA		J	Resistor 10k 1/16W Metal Oxide
R2079	VRS-CZ1JF103JY	AA		J	Resistor 10k 1/16W Metal Oxide
R2081	VRS-CZ1JF000JY	AA		J	Resistor 0 1/16W Metal Oxide
R2082	VRS-CZ1JF103JY	AA		J	Resistor 10k 1/16W Metal Oxide
R2088	VRS-CZ1JF393JY	AA		J	Resistor 39k 1/16W Metal Oxide
R2089	VRS-CZ1JF103JY	AA		J	Resistor 10k 1/16W Metal Oxide
R2091	VRS-CZ1JF101JY	AA		J	Resistor 100 1/16W Metal Oxide
R2092	VRS-CZ1JF104JY	AA		J	Resistor 100k 1/16W Metal Oxide
R2093	VRS-CZ1JF103JY	AA		J	Resistor 10k 1/16W Metal Oxide
R2094	VRS-CZ1JF100JY	AA		J	Resistor 10 1/16W Metal Oxide
R2096	VRS-CZ1JF473JY	AA		J	Resistor 47k 1/16W Metal Oxide
R2402	VRS-CZ1JF470JY	AA		J	Resistor 47 1/16W Metal Oxide
R2405	VRS-CZ1JF103JY	AA		J	Resistor 10k 1/16W Metal Oxide
R2406	VRS-CZ1JF473JY	AA		J	Resistor 47k 1/16W Metal Oxide
R2407	VRK-SB1FF472JY	AA		J	Resistor 4.7k 1/32W Metal Composition
R2408	VRS-TV1JD101JY	AA		J	Resistor 100 1/16W Metal Oxide
R2409	VRS-TV1JD101JY	AA		J	Resistor 100 1/16W Metal Oxide
R2410	VRS-TV1JD101JY	AA		J	Resistor 100 1/16W Metal Oxide
R2414	VRS-CZ1JF000JY	AA		J	Resistor 0 1/16W Metal Oxide
R2415	VRS-CZ1JF000JY	AA		J	Resistor 0 1/16W Metal Oxide
R2417	VRS-CZ1JF000JY	AA		J	Resistor 0 1/16W Metal Oxide
R2418	VRS-CZ1JF103JY	AA		J	Resistor 10k 1/16W Metal Oxide
R2420	VRS-CZ1JF103JY	AA		J	Resistor 10k 1/16W Metal Oxide
R2421	VRS-CZ1JF470JY	AA		J	Resistor 47 1/16W Metal Oxide
R2422	VRS-CZ1JF103JY	AA		J	Resistor 10k 1/16W Metal Oxide
R2423	VRS-CZ1JF000JY	AA		J	Resistor 0 1/16W Metal Oxide
R2425	VRS-CZ1JF470JY	AA		J	Resistor 47 1/16W Metal Oxide
R2426	VRS-CZ1JF103JY	AA		J	Resistor 10k 1/16W Metal Oxide
R2428	VRS-CZ1JF473JY	AA		J	Resistor 47k 1/16W Metal Oxide
R2429	VRS-CZ1JF473JY	AA		J	Resistor 47k 1/16W Metal Oxide
R2430	VRS-CZ1JF105JY	AA		J	Resistor 1.0M 1/16W Metal Oxide
R2432	VRS-CZ1JF105JY	AA		J	Resistor 1.0M 1/16W Metal Oxide
R2436	VRS-CJ1JF000JY	AA		J	Resistor 0 1/16W Metal Oxide
R2601	VRK-SB1FF223JY	AA		J	Resistor 22k 1/32W Metal Composition
R2602	VRK-SB1FF223JY	AA		J	Resistor 22k 1/32W Metal Composition
R2603	VRK-SA1JF103JY	AB		J	Resistor 10k 1/16W Metal Composition
R2604	VRS-CZ1JF000JY	AA		J	Resistor 0 1/16W Metal Oxide
R2605	VRS-CZ1JF000JY	AA		J	Resistor 0 1/16W Metal Oxide
R2606	VRS-CZ1JF000JY	AA		J	Resistor 0 1/16W Metal Oxide
R2607	VRS-CZ1JF000JY	AA		J	Resistor 0 1/16W Metal Oxide
R2608	VRS-CZ1JF000JY	AA		J	Resistor 0 1/16W Metal Oxide
R2609	VRS-CZ1JF000JY	AA		J	Resistor 0 1/16W Metal Oxide
R2610	VRS-CZ1JF000JY	AA		J	Resistor 0 1/16W Metal Oxide
R2611	VRS-CZ1JF470JY	AA		J	Resistor 47 1/16W Metal Oxide
R2612	VRS-CZ1JF000JY	AA		J	Resistor 0 1/16W Metal Oxide
R2613	VRS-CZ1JF000JY	AA		J	Resistor 0 1/16W Metal Oxide
R2614	VRS-CZ1JF000JY	AA		J	Resistor 0 1/16W Metal Oxide
R2617	VRS-CZ1JF000JY	AA		J	Resistor 0 1/16W Metal Oxide
R2618	VRS-CZ1JF000JY	AA		J	Resistor 0 1/16W Metal Oxide
R2619	VRS-CZ1JF000JY	AA		J	Resistor 0 1/16W Metal Oxide
R2620	VRS-CZ1JF000JY	AA		J	Resistor 0 1/16W Metal Oxide
R2623	VRS-CZ1JF000JY	AA		J	Resistor 0 1/16W Metal Oxide
R2628	VRS-CZ1JF000JY	AA		J	Resistor 0 1/16W Metal Oxide
R2629	VRS-CZ1JF223JY	AA		J	Resistor 22k 1/16W Metal Oxide
R3302	VRS-CZ1JF102JY	AA		J	Resistor 1k 1/16W Metal Oxide
R3303	VRS-CZ1JF102JY	AA		J	Resistor 1k 1/16W Metal Oxide
R3304	VRS-CZ1JF103JY	AA		J	Resistor 10k 1/16W Metal Oxide
R3305	VRS-CZ1JF103JY	AA		J	Resistor 10k 1/16W Metal Oxide
R3306	VRS-TW2ED750JY	AA		J	Resistor 75 1/4W Metal Oxide
R3307	VRS-TW2ED750JY	AA		J	Resistor 75 1/4W Metal Oxide
R3308	VRS-TW2ED750JY	AA		J	Resistor 75 1/4W Metal Oxide
R3309	VRS-CZ1JF470JY	AA		J	Resistor 47 1/16W Metal Oxide
R3311	VRK-SB1FF470JY	AA		J	Resistor 47 1/32W Metal Composition
R3314	VRS-CZ1JF330JY	AA		J	Resistor 33 1/16W Metal Oxide
R3315	VRS-CZ1JF105JY	AA		J	Resistor 1.0M 1/16W Metal Oxide
R3316	VRS-CZ1JF471JY	AA		J	Resistor 470 1/16W Metal Oxide
R3317	VRS-CZ1JF330JY	AA		J	Resistor 33 1/16W Metal Oxide
R3318	VRS-CZ1JF103JY	AA		J	Resistor 10k 1/16W Metal Oxide
R3319	VRS-CZ1JF330JY	AA		J	Resistor 33 1/16W Metal Oxide
R3320	VRS-CZ1JF470JY	AA		J	Resistor 47 1/16W Metal Oxide
R3321	VRS-CZ1JF470JY	AA		J	Resistor 47 1/16W Metal Oxide
R3322	VRS-CZ1JF470JY	AA		J	Resistor 47 1/16W Metal Oxide
R3323	VRS-CZ1JF330JY	AA		J	Resistor 33 1/16W Metal Oxide
R3327	VRS-CZ1JF102JY	AA		J	Resistor 1k 1/16W Metal Oxide
R3328	VRS-CZ1JF470JY	AA		J	Resistor 47 1/16W Metal Oxide
R3329	VRS-CZ1JF103JY	AA		J	Resistor 10k 1/16W Metal Oxide

NO.	PARTS CODE	PRICE RANK	NEW MARK	PART DELIVERY	DESCRIPTION
[3] DUNTKE186FM02(MAIN Unit)					
R3330	VRS-CZ1JF103JY	AA		J	Resistor 10k 1/16W Metal Oxide
R3331	VRS-CZ1JF472JY	AA		J	Resistor 4.7k 1/16W Metal Oxide
R3332	VRS-CZ1JF472JY	AA		J	Resistor 4.7k 1/16W Metal Oxide
R3333	VRS-CZ1JF472JY	AA		J	Resistor 4.7k 1/16W Metal Oxide
R3337	VRS-CZ1JF472JY	AA		J	Resistor 4.7k 1/16W Metal Oxide
R3338	VRS-CZ1JF472JY	AA		J	Resistor 4.7k 1/16W Metal Oxide
R3339	VRS-CZ1JF472JY	AA		J	Resistor 4.7k 1/16W Metal Oxide
R3340	VRS-CZ1JF472JY	AA		J	Resistor 4.7k 1/16W Metal Oxide
R3341	VRK-SB1FF470JY	AA		J	Resistor 47 1/32W Metal Composition
R3342	VRK-SB1FF680JY	AA		J	Resistor 68 1/32W Metal Composition
R3343	VRK-SB1FF680JY	AA		J	Resistor 68 1/32W Metal Composition
R3344	VRS-CZ1JF680JY	AB		J	Resistor 68 1/16W Metal Oxide
R3345	VRS-CZ1JF680JY	AB		J	Resistor 68 1/16W Metal Oxide
R3346	VRK-SB1FF680JY	AA		J	Resistor 68 1/32W Metal Composition
R3347	VRS-CZ1JF680JY	AB		J	Resistor 68 1/16W Metal Oxide
R3348	VRS-CZ1JF680JY	AB		J	Resistor 68 1/16W Metal Oxide
R3349	VRK-SB1FF680JY	AA		J	Resistor 68 1/32W Metal Composition
R3350	VRK-SB1FF680JY	AA		J	Resistor 68 1/32W Metal Composition
R3351	VRS-CZ1JF680JY	AB		J	Resistor 68 1/16W Metal Oxide
R3352	VRS-CZ1JF680JY	AB		J	Resistor 68 1/16W Metal Oxide
R3353	VRK-SB1FF680JY	AA		J	Resistor 68 1/32W Metal Composition
R3354	VRK-SB1FF680JY	AA		J	Resistor 68 1/32W Metal Composition
R3355	VRS-CZ1JF220JY	AA		J	Resistor 22 1/16W Metal Oxide
R3501	VRS-CZ1JF680JY	AB		J	Resistor 68 1/16W Metal Oxide
R3502	VRS-CZ1JF680JY	AB		J	Resistor 68 1/16W Metal Oxide
R3503	VRK-SB1FF680JY	AA		J	Resistor 68 1/32W Metal Composition
R3506	VRS-CZ1JF680JY	AB		J	Resistor 68 1/16W Metal Oxide
R3507	VRK-SB1FF330JY	AA		J	Resistor 33 1/32W Metal Composition
R3509	VRK-SB1FF330JY	AA		J	Resistor 33 1/32W Metal Composition
R3511	VRK-SB1FF680JY	AA		J	Resistor 68 1/32W Metal Composition
R3512	VRS-CZ1JF680JY	AB		J	Resistor 68 1/16W Metal Oxide
R3513	VRK-SB1FF680JY	AA		J	Resistor 68 1/32W Metal Composition
R3514	VRS-CZ1JF330JY	AA		J	Resistor 33 1/16W Metal Oxide
R3516	VRS-CZ1JF330JY	AA		J	Resistor 33 1/16W Metal Oxide
R3521	VRK-SB1FF330JY	AA		J	Resistor 33 1/32W Metal Composition
R3524	VRK-SB1FF330JY	AA		J	Resistor 33 1/32W Metal Composition
R3525	VRK-SB1FF330JY	AA		J	Resistor 33 1/32W Metal Composition
R3526	VRK-SB1FF330JY	AA		J	Resistor 33 1/32W Metal Composition
R3527	VRK-SB1FF330JY	AA		J	Resistor 33 1/32W Metal Composition
R3528	VRS-CZ1JF330JY	AA		J	Resistor 33 1/16W Metal Oxide
R3530	VRS-CZ1JF330JY	AA		J	Resistor 33 1/16W Metal Oxide
R3532	VRS-CZ1JF510JY	AA		J	Resistor 51 1/16W Metal Oxide
R3539	VRS-CZ1JF510JY	AA		J	Resistor 51 1/16W Metal Oxide
R3540	VRK-SB1FF330JY	AA		J	Resistor 33 1/32W Metal Composition
R3541	VRK-SB1FF330JY	AA		J	Resistor 33 1/32W Metal Composition
R3542	VRK-SB1FF330JY	AA		J	Resistor 33 1/32W Metal Composition
R3543	VRK-SB1FF330JY	AA		J	Resistor 33 1/32W Metal Composition
R3544	VRS-CZ1JF330JY	AA		J	Resistor 33 1/16W Metal Oxide
R3546	VRS-CZ1JF330JY	AA		J	Resistor 33 1/16W Metal Oxide
R3554	VRK-SB1FF330JY	AA		J	Resistor 33 1/32W Metal Composition
R3555	VRK-SB1FF330JY	AA		J	Resistor 33 1/32W Metal Composition
R3556	VRK-SB1FF330JY	AA		J	Resistor 33 1/32W Metal Composition
R3557	VRK-SB1FF330JY	AA		J	Resistor 33 1/32W Metal Composition
R3558	VRS-CZ1JF330JY	AA		J	Resistor 33 1/16W Metal Oxide
R3560	VRS-CZ1JF330JY	AA		J	Resistor 33 1/16W Metal Oxide
R3570	VRS-CZ1JF330JY	AA		J	Resistor 33 1/16W Metal Oxide
R3571	VRS-CZ1JF330JY	AA		J	Resistor 33 1/16W Metal Oxide
R3572	VRS-CZ1JF330JY	AA		J	Resistor 33 1/16W Metal Oxide
R3573	VRS-CZ1JF330JY	AA		J	Resistor 33 1/16W Metal Oxide
R3574	VRS-CZ1JF330JY	AA		J	Resistor 33 1/16W Metal Oxide
R3575	VRS-CZ1JF330JY	AA		J	Resistor 33 1/16W Metal Oxide
R3576	VRS-CZ1JF330JY	AA		J	Resistor 33 1/16W Metal Oxide
R3577	VRS-CZ1JF330JY	AA		J	Resistor 33 1/16W Metal Oxide
R3578	VRK-SB1FF330JY	AA		J	Resistor 33 1/32W Metal Composition
R3579	VRK-SB1FF680JY	AA		J	Resistor 68 1/32W Metal Composition
R4401	VRS-CZ1JF470JY	AA		J	Resistor 47 1/16W Metal Oxide
R4402	VRS-CZ1JF470JY	AA		J	Resistor 47 1/16W Metal Oxide
R4403	VRS-CZ1JF470JY	AA		J	Resistor 47 1/16W Metal Oxide
R4404	VRS-CZ1JF470JY	AA		J	Resistor 47 1/16W Metal Oxide
R4405	VRS-CZ1JF470JY	AA		J	Resistor 47 1/16W Metal Oxide
R4406	VRS-CZ1JF470JY	AA		J	Resistor 47 1/16W Metal Oxide
R4408	VRK-SB1FF470JY	AA		J	Resistor 47 1/32W Metal Composition
R4409	VRK-SB1FF470JY	AA		J	Resistor 47 1/32W Metal Composition
R4410	VRS-CZ1JF000JY	AA		J	Resistor 0 1/16W Metal Oxide
R4411	VRS-CZ1JF470JY	AA		J	Resistor 47 1/16W Metal Oxide
R4413	VRS-CJ1JF470JY	AA		J	Resistor 47 1/16W Metal Oxide
R4417	VRS-CZ1JF103JY	AA		J	Resistor 10k 1/16W Metal Oxide
R4419	VRS-CZ1JF103JY	AA		J	Resistor 10k 1/16W Metal Oxide
R4420	VRS-CZ1JF103JY	AA		J	Resistor 10k 1/16W Metal Oxide
R4421	VRS-CH1JF470JY	AA		J	Resistor 47 1/16W Metal Oxide
R4422	VRS-CH1JF470JY	AA		J	Resistor 47 1/16W Metal Oxide
R4423	VRS-CZ1JF103JY	AA		J	Resistor 10k 1/16W Metal Oxide
R4425	VRS-CZ1JF103JY	AA		J	Resistor 10k 1/16W Metal Oxide
R4426	VRS-CZ1JF103JY	AA		J	Resistor 10k 1/16W Metal Oxide
R4427	VRS-CH1JF470JY	AA		J	Resistor 47 1/16W Metal Oxide

NO.	PARTS CODE	PRICE RANK	NEW MARK	PART DELIVERY	DESCRIPTION
[3] DUNTKE186FM02(MAIN Unit)					
R4428	VRS-CH1JF470JY	AA		J	Resistor 47 1/16W Metal Oxide
R4429	VRS-CH1JF470JY	AA		J	Resistor 47 1/16W Metal Oxide
R4430	VRS-CZ1JF471JY	AA		J	Resistor 470 1/16W Metal Oxide
R4431	VRS-CZ1JF103JY	AA		J	Resistor 10k 1/16W Metal Oxide
R4432	VRS-CZ1JF103JY	AA		J	Resistor 10k 1/16W Metal Oxide
R4436	VRS-CZ1JF103JY	AA		J	Resistor 10k 1/16W Metal Oxide
R4437	VRS-CZ1JF103JY	AA		J	Resistor 10k 1/16W Metal Oxide
R4441	VRS-CZ1JF103JY	AA		J	Resistor 10k 1/16W Metal Oxide
R4447	VRS-CZ1JF102JY	AA		J	Resistor 1k 1/16W Metal Oxide
R8101	VRS-CZ1JF470JY	AA		J	Resistor 47 1/16W Metal Oxide
R8102	VRS-CZ1JF472JY	AA		J	Resistor 4.7k 1/16W Metal Oxide
R8103	VRS-CZ1JF472JY	AA		J	Resistor 4.7k 1/16W Metal Oxide
R8104	VRK-SB1FF472JY	AA		J	Resistor 4.7k 1/32W Metal Composition
R8105	VRS-CZ1JF100JY	AA		J	Resistor 10 1/16W Metal Oxide
R8106	VRS-CZ1JF220JY	AA		J	Resistor 22 1/16W Metal Oxide
R8107	VRS-CZ1JF220JY	AA		J	Resistor 22 1/16W Metal Oxide
R8108	VRS-CZ1JF220JY	AA		J	Resistor 22 1/16W Metal Oxide
R8109	VRS-CZ1JF220JY	AA		J	Resistor 22 1/16W Metal Oxide
R8111	VRS-CZ1JF103JY	AA		J	Resistor 10k 1/16W Metal Oxide
R8112	VRS-CZ1JF103JY	AA		J	Resistor 10k 1/16W Metal Oxide
R8113	VRS-CZ1JF201JY	AA		J	Resistor 200 1/16W Metal Oxide
R8114	VRS-CZ1JF4R7JY	AA		J	Resistor 4.7 1/16W Metal Oxide
R8115	VRS-CZ1JF102JY	AA		J	Resistor 1k 1/16W Metal Oxide
R8116	VRS-CZ1JF105JY	AA		J	Resistor 1.0M 1/16W Metal Oxide
R8118	VRK-SB1FF470JY	AA		J	Resistor 47 1/32W Metal Composition
R8119	VRK-SB1FF103JY	AA		J	Resistor 10k 1/32W Metal Composition
R8120	VRK-SB1FF103JY	AA		J	Resistor 10k 1/32W Metal Composition
R8121	VRK-SB1FF103JY	AA		J	Resistor 10k 1/32W Metal Composition
R8122	VRK-SB1FF103JY	AA		J	Resistor 10k 1/32W Metal Composition
R8123	VRK-SB1FF103JY	AA		J	Resistor 10k 1/32W Metal Composition
R8124	VRK-SB1FF103JY	AA		J	Resistor 10k 1/32W Metal Composition
R8125	VRK-SB1FF103JY	AA		J	Resistor 10k 1/32W Metal Composition
R8126	VRK-SB1FF470JY	AA		J	Resistor 47 1/32W Metal Composition
R8127	VRK-SB1FF103JY	AA		J	Resistor 10k 1/32W Metal Composition
R8128	VRS-CZ1JF470JY	AA		J	Resistor 47 1/16W Metal Oxide
R8129	VRS-CZ1JF470JY	AA		J	Resistor 47 1/16W Metal Oxide
R8130	VRK-SB1FF103JY	AA		J	Resistor 10k 1/32W Metal Composition
R8131	VRS-CZ1JF562JY	AA		J	Resistor 5.6k 1/16W Metal Oxide
R8132	VRS-CZ1JF431JY	AA		R	Resistor 430 1/16W Metal Oxide
R8133	VRS-CZ1JF331JY	AA		J	Resistor 330 1/16W Metal Oxide
R8135	VRS-CZ1JF330JY	AA		J	Resistor 33 1/16W Metal Oxide
R8136	VRS-CZ1JF330JY	AA		J	Resistor 33 1/16W Metal Oxide
R8137	VRS-CZ1JF330JY	AA		J	Resistor 33 1/16W Metal Oxide
R8140	VRS-CZ1JF472JY	AA		J	Resistor 4.7k 1/16W Metal Oxide
R8141	VRS-CZ1JF472JY	AA		J	Resistor 4.7k 1/16W Metal Oxide
R8147	VRS-CZ1JF182JY	AA		J	Resistor 1.8k 1/16W Metal Oxide
R8148	VRS-CZ1JF470JY	AA		J	Resistor 47 1/16W Metal Oxide
R8149	VRK-SB1FF472JY	AA		J	Resistor 4.7k 1/32W Metal Composition
R8150	VRS-CZ1JF683JY	AA		J	Resistor 68k 1/16W Metal Oxide
R8151	VRS-CZ1JF103JY	AA		J	Resistor 10k 1/16W Metal Oxide
R8152	VRK-SB1FF472JY	AA		J	Resistor 4.7k 1/32W Metal Composition
R8153	VRK-SB1FF472JY	AA		J	Resistor 4.7k 1/32W Metal Composition
R8154	VRS-CZ1JF470JY	AA		J	Resistor 47 1/16W Metal Oxide
R8155	VRS-CZ1JF470JY	AA		J	Resistor 47 1/16W Metal Oxide
R8156	VRS-CZ1JF470JY	AA		J	Resistor 47 1/16W Metal Oxide
R8159	VRS-CZ1JF473JY	AA		J	Resistor 47k 1/16W Metal Oxide
R8160	VRS-CZ1JF000JY	AA		J	Resistor 0 1/16W Metal Oxide
R8161	VRK-SB1FF472JY	AA		J	Resistor 4.7k 1/32W Metal Composition
R8162	VRK-SB1FF472JY	AA		J	Resistor 4.7k 1/32W Metal Composition
R8163	VRS-CZ1JF472JY	AA		J	Resistor 4.7k 1/16W Metal Oxide
R8165	VRS-CZ1JF472JY	AA		J	Resistor 4.7k 1/16W Metal Oxide
R8167	VRS-CZ1JF182JY	AA		J	Resistor 1.8k 1/16W Metal Oxide
R8169	VRS-CZ1JF470JY	AA		J	Resistor 47 1/16W Metal Oxide
R8174	VRK-SB1FF472JY	AA		J	Resistor 4.7k 1/32W Metal Composition
R8175	VRS-CZ1JF470JY	AA		J	Resistor 47 1/16W Metal Oxide
R8301	VRS-CZ1JF101JY	AA		J	Resistor 100 1/16W Metal Oxide
R8302	VRS-CZ1JF101JY	AA		J	Resistor 100 1/16W Metal Oxide
R8303	VRS-CZ1JF101JY	AA		J	Resistor 100 1/16W Metal Oxide
R8304	VRS-CZ1JF101JY	AA		J	Resistor 100 1/16W Metal Oxide
R8305	VRS-CZ1JF102JY	AA		J	Resistor 1k 1/16W Metal Oxide
R8306	VRS-CZ1JF102JY	AA		J	Resistor 1k 1/16W Metal Oxide
R8307	VRK-SB1FF100JY	AA		J	Resistor 10 1/32W Metal Composition
R8308	VRK-SB1FF100JY	AA		J	Resistor 10 1/32W Metal Composition
R8309	VRK-SB1FF100JY	AA		J	Resistor 10 1/32W Metal Composition
R8310	VRK-SB1FF100JY	AA		J	Resistor 10 1/32W Metal Composition
R8311	VRK-SB1FF100JY	AA		J	Resistor 10 1/32W Metal Composition
R8332	VRS-CZ1JF100JY	AA		J	Resistor 10 1/16W Metal Oxide
R8333	VRS-CZ1JF100JY	AA		J	Resistor 10 1/16W Metal Oxide
R8703	VRS-CZ1JF470JY	AA		J	Resistor 47 1/16W Metal Oxide
R8710	VRS-CZ1JF121JY	AA		J	Resistor 120 1/16W Metal Oxide
R8712	VRS-CZ1JF682JY	AA		J	Resistor 6.8k 1/16W Metal Oxide
R8713	VRS-CZ1JF103JY	AA		J	Resistor 10k 1/16W Metal Oxide
R8714	VRS-CZ1JF470JY	AA		J	Resistor 47 1/16W Metal Oxide
R8718	VRK-SA1JF100JY	AB		J	Resistor 10 1/16W Metal Composition
R8722	VRS-CZ1JF102JY	AA		J	Resistor 1k 1/16W Metal Oxide

NO.	PARTS CODE	PRICE RANK	NEW MARK	PART DELIVERY	DESCRIPTION
[3] DUNTKE186FM02(MAIN Unit)					
R8723	VRS-CZ1JF104JY	AA		J	Resistor 100k 1/16W Metal Oxide
R8729	VRS-CZ1JF470JY	AA		J	Resistor 47 1/16W Metal Oxide
R8730	VRK-SA1JF472JY	AA		R	Resistor 4.7k 1/16W Metal Composition
R9103	VRS-CZ1JF000JY	AA		J	Resistor 0 1/16W Metal Oxide
R9105	VRK-SB1FF472JY	AA		J	Resistor 4.7k 1/32W Metal Composition
R9110	VRS-CZ1JF222JY	AA		J	Resistor 2.2k 1/16W Metal Oxide
R9111	VRK-SB1FF470JY	AA		J	Resistor 47 1/32W Metal Composition
R9112	VRS-CZ1JF222JY	AA		J	Resistor 2.2k 1/16W Metal Oxide
R9115	VRS-CZ1JF222JY	AA		J	Resistor 2.2k 1/16W Metal Oxide
R9116	VRK-SB1FF472JY	AA		J	Resistor 4.7k 1/32W Metal Composition
R9117	VRS-CZ1JF102JY	AA		J	Resistor 1k 1/16W Metal Oxide
R9118	VRS-CZ1JF330JY	AA		J	Resistor 33 1/16W Metal Oxide
R9119	VRS-CZ1JF472JY	AA		J	Resistor 4.7k 1/16W Metal Oxide
R9120	VRK-SB1FF470JY	AA		J	Resistor 47 1/32W Metal Composition
R9122	VRS-CZ1JF472JY	AA		J	Resistor 4.7k 1/16W Metal Oxide
R9123	VRS-CZ1JF222JY	AA		J	Resistor 2.2k 1/16W Metal Oxide
R9124	VRS-CZ1JF222JY	AA		J	Resistor 2.2k 1/16W Metal Oxide
R9127	VRS-CZ1JF222JY	AA		J	Resistor 2.2k 1/16W Metal Oxide
R9130	VRS-CZ1JF222JY	AA		J	Resistor 2.2k 1/16W Metal Oxide
R9134	VRS-CZ1JF222JY	AA		J	Resistor 2.2k 1/16W Metal Oxide
R9135	VRS-CZ1JF222JY	AA		J	Resistor 2.2k 1/16W Metal Oxide
R9137	VRS-CZ1JF222JY	AA		J	Resistor 2.2k 1/16W Metal Oxide
R9138	VRK-SB1FF470JY	AA		J	Resistor 47 1/32W Metal Composition
R9139	VRK-SB1FF470JY	AA		J	Resistor 47 1/32W Metal Composition
R9140	VRS-CZ1JF222JY	AA		J	Resistor 2.2k 1/16W Metal Oxide
R9141	VRS-CZ1JF222JY	AA		J	Resistor 2.2k 1/16W Metal Oxide
R9142	VRS-CZ1JF222JY	AA		J	Resistor 2.2k 1/16W Metal Oxide
R9144	VRS-CZ1JF222JY	AA		J	Resistor 2.2k 1/16W Metal Oxide
R9145	VRS-CZ1JF222JY	AA		J	Resistor 2.2k 1/16W Metal Oxide
R9151	VRS-CZ1JF222JY	AA		J	Resistor 2.2k 1/16W Metal Oxide
R9152	VRS-CZ1JF222JY	AA		J	Resistor 2.2k 1/16W Metal Oxide
R9153	VRS-CZ1JF222JY	AA		J	Resistor 2.2k 1/16W Metal Oxide
R9154	VRS-CZ1JF222JY	AA		J	Resistor 2.2k 1/16W Metal Oxide
R9157	VRS-CZ1JF222JY	AA		J	Resistor 2.2k 1/16W Metal Oxide
R9158	VRS-CZ1JF222JY	AA		J	Resistor 2.2k 1/16W Metal Oxide
R9159	VRS-CZ1JF473JY	AA		J	Resistor 47k 1/16W Metal Oxide
R9162	VRS-CZ1JF472JY	AA		J	Resistor 4.7k 1/16W Metal Oxide
R9163	VRS-CZ1JF472JY	AA		J	Resistor 4.7k 1/16W Metal Oxide
R9164	VRS-CZ1JF330JY	AA		J	Resistor 33 1/16W Metal Oxide
R9181	VRS-CZ1JF473JY	AA		J	Resistor 47k 1/16W Metal Oxide
R9185	VRS-CZ1JF472JY	AA		J	Resistor 4.7k 1/16W Metal Oxide
R9186	VRS-CZ1JF472JY	AA		J	Resistor 4.7k 1/16W Metal Oxide
R9187	VRS-CZ1JF103JY	AA		J	Resistor 10k 1/16W Metal Oxide
R9188	VRS-CZ1JF220JY	AA		J	Resistor 22 1/16W Metal Oxide
R9301	VRK-SB1FF470JY	AA		J	Resistor 47 1/32W Metal Composition
R9302	VRK-SB1FF470JY	AA		J	Resistor 47 1/32W Metal Composition
R9303	VRK-SB1FF470JY	AA		J	Resistor 47 1/32W Metal Composition
R9304	VRK-SB1FF470JY	AA		J	Resistor 47 1/32W Metal Composition
R9305	VRK-SB1FF470JY	AA		J	Resistor 47 1/32W Metal Composition
R9308	VRK-SA1JF472JY	AA		R	Resistor 4.7k 1/16W Metal Composition
R9310	VRS-CZ1JF103JY	AA		J	Resistor 10k 1/16W Metal Oxide
R9311	VRS-CZ1JF472JY	AA		J	Resistor 4.7k 1/16W Metal Oxide
R9314	VRS-CZ1JF000JY	AA		J	Resistor 0 1/16W Metal Oxide
R9316	VRS-CZ1JF000JY	AA		J	Resistor 0 1/16W Metal Oxide
R9318	VRS-CZ1JF000JY	AA		J	Resistor 0 1/16W Metal Oxide
R9320	VRS-CZ1JF000JY	AA		J	Resistor 0 1/16W Metal Oxide
R9321	VRS-CZ1JF472JY	AA		J	Resistor 4.7k 1/16W Metal Oxide
R9323	VRS-CZ1JF470JY	AA		J	Resistor 47 1/16W Metal Oxide
R9324	VRS-CZ1JF470JY	AA		J	Resistor 47 1/16W Metal Oxide
R9325	VRS-CZ1JF472JY	AA		J	Resistor 4.7k 1/16W Metal Oxide
R9326	VRS-CZ1JF472JY	AA		J	Resistor 4.7k 1/16W Metal Oxide
R9327	VRS-CZ1JF472JY	AA		J	Resistor 4.7k 1/16W Metal Oxide
R9328	VRS-CZ1JF472JY	AA		J	Resistor 4.7k 1/16W Metal Oxide
R9329	VRS-CZ1JF472JY	AA		J	Resistor 4.7k 1/16W Metal Oxide
R9330	VRS-CZ1JF472JY	AA		J	Resistor 4.7k 1/16W Metal Oxide
R9331	VRK-SB1FF470JY	AA		J	Resistor 47 1/32W Metal Composition
R9332	VRK-SB1FF470JY	AA		J	Resistor 47 1/32W Metal Composition
R9333	VRK-SB1FF470JY	AA		J	Resistor 47 1/32W Metal Composition
R9334	VRK-SB1FF470JY	AA		J	Resistor 47 1/32W Metal Composition
R9335	VRK-SB1FF470JY	AA		J	Resistor 47 1/32W Metal Composition
R9601	VRS-CZ1JF103JY	AA		J	Resistor 10k 1/16W Metal Oxide
R9602	VRS-CZ1JF103JY	AA		J	Resistor 10k 1/16W Metal Oxide
R9603	VRS-CZ1JF682JY	AA		J	Resistor 6.8k 1/16W Metal Oxide
R9604	VRS-CZ1JF224JY	AA		J	Resistor 220k 1/16W Metal Oxide
R9605	VRS-CZ1JF103JY	AA		J	Resistor 10k 1/16W Metal Oxide
R9606	VRS-CZ1JF473JY	AA		J	Resistor 47k 1/16W Metal Oxide
R9607	VRS-CZ1JF103JY	AA		J	Resistor 10k 1/16W Metal Oxide
R9608	VRS-CZ1JF101JY	AA		J	Resistor 100 1/16W Metal Oxide
R9609	VRS-CZ1JF472JY	AA		J	Resistor 4.7k 1/16W Metal Oxide
R9610	VRS-CZ1JF101FY	AA		J	Resistor 100 1/16W Metal Oxide
R9612	VRS-CZ1JF103JY	AA		J	Resistor 10k 1/16W Metal Oxide
R9613	VRS-CZ1JF103JY	AA		J	Resistor 10k 1/16W Metal Oxide
R9614	VRS-CZ1JF103JY	AA		J	Resistor 10k 1/16W Metal Oxide
R9615	VRS-CZ1JF103JY	AA		J	Resistor 10k 1/16W Metal Oxide
R9616	VRS-CZ1JF103FY	AB		J	Resistor 10k 1/16W Metal Oxide

NO.	PARTS CODE	PRICE RANK	NEW MARK	PART DELIVERY	DESCRIPTION
[3] DUNTKE186FM02(MAIN Unit)					
R9617	VRS-CZ1JF822FY	AA		J	Resistor 8.2k 1/16W Metal Oxide
R9618	VRS-CZ1JF183FY	AA		J	Resistor 18k 1/16W Metal Oxide
R9619	VRS-CZ1JF103JY	AA		J	Resistor 10k 1/16W Metal Oxide
R9621	VRS-CZ1JF153JY	AA		J	Resistor 15k 1/16W Metal Oxide
R9622	VRS-CZ1JF822JY	AA		J	Resistor 8.2k 1/16W Metal Oxide
R9623	VRS-CZ1JF561FY	AA		J	Resistor 560 1/16W Metal Oxide
R9624	VRS-CZ1JF103JY	AA		J	Resistor 10k 1/16W Metal Oxide
R9625	VRS-CZ1JF433FY	AA		J	Resistor 43k 1/16W Metal Oxide
R9626	VRS-CZ1JF473JY	AA		J	Resistor 47k 1/16W Metal Oxide
R9628	VRS-CZ1JF3R3JY	AA		J	Resistor 3.3 1/16W Metal Oxide
R9629	VRS-CZ1JF184JY	AA		J	Resistor 180k 1/16W Metal Oxide
R9630	VRS-CZ1JF103JY	AA		J	Resistor 10k 1/16W Metal Oxide
R9631	VRS-CZ1JF3R3JY	AA		J	Resistor 3.3 1/16W Metal Oxide
R9632	VRS-CZ1JF103JY	AA		J	Resistor 10k 1/16W Metal Oxide
R9633	VRS-TW2HF101JY	AA		J	Resistor 100 1/2W Metal Oxide
R9634	VRS-CZ1JF103JY	AA		J	Resistor 10k 1/16W Metal Oxide
R9635	VRS-TW2HF101JY	AA		J	Resistor 100 1/2W Metal Oxide
R9636	VRS-CZ1JF303FY	AA		R	Resistor 30k 1/16W Metal Oxide
R9638	VRS-CZ1JF153JY	AA		J	Resistor 15k 1/16W Metal Oxide
R9639	VRS-CZ1JF101JY	AA		J	Resistor 100 1/16W Metal Oxide
R9640	VRS-CZ1JF331FY	AA		J	Resistor 330 1/16W Metal Oxide
R9641	VRS-CZ1JF473FY	AA		J	Resistor 47k 1/16W Metal Oxide
R9642	VRS-CZ1JF184JY	AA		J	Resistor 180k 1/16W Metal Oxide
R9643	VRS-CZ1JF101JY	AA		J	Resistor 100 1/16W Metal Oxide
R9644	VRS-CZ1JF101JY	AA		J	Resistor 100 1/16W Metal Oxide
R9645	VRS-TW2HF101JY	AA		J	Resistor 100 1/2W Metal Oxide
R9646	VRS-CZ1JF101JY	AA		J	Resistor 100 1/16W Metal Oxide
R9647	VRS-CZ1JF153FY	AA		J	Resistor 15k 1/16W Metal Oxide
R9649	VRS-CZ1JF682JY	AA		J	Resistor 6.8k 1/16W Metal Oxide
R9653	VRS-CZ1JF224JY	AA		J	Resistor 220k 1/16W Metal Oxide
R9654	VRS-CZ1JF103JY	AA		J	Resistor 10k 1/16W Metal Oxide
R9656	VRS-CZ1JF272FY	AA		J	Resistor 2.7k 1/16W Metal Oxide
R9657	VRS-CZ1JF473JY	AA		J	Resistor 47k 1/16W Metal Oxide
R9658	VRS-CZ1JF101FY	AA		J	Resistor 100 1/16W Metal Oxide
R9659	VRS-CZ1JF133FY	AA		R	Resistor 13k 1/16W Metal Oxide
R9660	VRS-CZ1JF3R3JY	AA		J	Resistor 3.3 1/16W Metal Oxide
R9661	VRS-CZ1JF103JY	AA		J	Resistor 10k 1/16W Metal Oxide
R9662	VRS-CZ1JF103JY	AA		J	Resistor 10k 1/16W Metal Oxide
R9663	VRS-CZ1JF473JY	AA		J	Resistor 47k 1/16W Metal Oxide
R9664	VRS-CZ1JF3R3JY	AA		J	Resistor 3.3 1/16W Metal Oxide
R9665	VRS-CZ1JF103JY	AA		J	Resistor 10k 1/16W Metal Oxide
R9666	VRS-CZ1JF133FY	AA		R	Resistor 13k 1/16W Metal Oxide
SC1101	QCNCWA673WJZZY	AF		J	Connector 82Pin
SC1501	QSOCZA072WJZZQ	AH		J	Socket 23Pin(TMDS Input 3)
SC1502	QSOCZA072WJZZQ	AH		J	Socket 23Pin(TMDS Input 2)
SC1503	QCNCWA661WJQZY	AG		J	Connector 21Pin(HM)
SC1504	QSOCNA229WJZZ	AH		J	Socket 17Pin(Black)
SC2401	QSOCNA706WJZZ	AF	N	R	Socket 11Pin
SC4602	QSOCNA003WJZZY	AM		J	Socket, 100Pin
SC9301	QCNCWA562WJQZY	AF		J	Connector 60Pin(To PC Card)
SLD3501	PSLDMB235WJFW	AD	N	R	Shield
TH2001	VHHM1103J03-1Y	AC		J	Thermistor
VA1501	RH-VXA187WJQZY	AB		J	Varistor EZAEG2A50AX
VA1502	RH-VXA187WJQZY	AB		J	Varistor EZAEG2A50AX
VA1503	RH-VXA187WJQZY	AB		J	Varistor EZAEG2A50AX
VA1504	RH-VXA187WJQZY	AB		J	Varistor EZAEG2A50AX
VA1505	RH-VXA187WJQZY	AB		J	Varistor EZAEG2A50AX
VA1506	RH-VXA187WJQZY	AB		J	Varistor EZAEG2A50AX
VA1507	RH-VXA187WJQZY	AB		J	Varistor EZAEG2A50AX
VA1508	RH-VXA187WJQZY	AB		J	Varistor EZAEG2A50AX
VA1509	RH-VXA187WJQZY	AB		J	Varistor EZAEG2A50AX
VA1510	RH-VXA187WJQZY	AB		J	Varistor EZAEG2A50AX
VA1511	RH-VXA187WJQZY	AB		J	Varistor EZAEG2A50AX
VA1512	RH-VXA187WJQZY	AB		J	Varistor EZAEG2A50AX
VA1513	RH-VXA187WJQZY	AB		J	Varistor EZAEG2A50AX
VA1514	RH-VXA187WJQZY	AB		J	Varistor EZAEG2A50AX
VA1515	RH-VXA187WJQZY	AB		J	Varistor EZAEG2A50AX
VA1516	RH-VXA187WJQZY	AB		J	Varistor EZAEG2A50AX
X2001	RCRSC0032TAZZY	AG		J	Crystal, 32.768kHz
X3301	RCRSCA174WJQZY	AG		R	Crystal
X8101	RCRSCA174WJQZY	AG		R	Crystal
X8102	RCRSC0032TAZZY	AG		J	Crystal 32.768kHz
X8701	RCRSCA086WJZZY	AG		J	Crystal 27MHz
N	PSHEPA540WJZZ	AD	N	R	Sheet
N	QCNCMA225WJSA	AY		J	Card Slot
N	QCNNWA883AWPZ	AD	N	R	Connecting Cord (DDR1 G G)
N	XBPSN20P14JS0	AB		J	Screw (Card Slot), x4

NO.	PARTS CODE	PRICE RANK	NEW MARK	PART DELIVERY	DESCRIPTION
[4] DUNTKE187FM02(TERMINAL Unit)					
C401	VCKYTV1CB105KY	AC		J	Capacitor 1 16V Ceramic
C402	VCCCCY1HH330JY	AA		J	Capacitor 33p 50V Ceramic
C403	VCKYCY1EF104ZY	AA		J	Capacitor 0.1 25V Ceramic
C405	VCKYCY1HB103KY	AA		J	Capacitor 0.01 50V Ceramic
C406	VCKYCY1HB103KY	AA		J	Capacitor 0.01 50V Ceramic
C408	VCCCCY1HH221JY	AA		J	Capacitor 220p 50V Ceramic
C411	VCKYCY1EF104ZY	AA		J	Capacitor 0.1 25V Ceramic
C414	RC-KZA383WJZZY	AC		J	Capacitor 10 25V Ceramic
C417	RC-KZA237WJZZY	AB		J	Capacitor 10 16V Ceramic
C420	RC-KZA237WJZZY	AB		J	Capacitor 10 16V Ceramic
C422	RC-KZA237WJZZY	AB		J	Capacitor 10 16V Ceramic
C423	RC-KZA178WJZZY	AC		J	Capacitor 4.7 25V Ceramic
C424	VCKYCY1EF104ZY	AA		J	Capacitor 0.1 25V Ceramic
C426	RC-KZA237WJZZY	AB		J	Capacitor 10 16V Ceramic
C428	VCKYCY1EF104ZY	AA		J	Capacitor 0.1 25V Ceramic
C429	RC-KZA237WJZZY	AB		J	Capacitor 10 16V Ceramic
C430	VCKYCY1EF104ZY	AA		J	Capacitor 0.1 25V Ceramic
C431	VCKYCY1HF103ZY	AA		J	Capacitor 0.01 50V Ceramic
C432	RC-KZA237WJZZY	AB		J	Capacitor 10 16V Ceramic
C433	RC-KZA237WJZZY	AB		J	Capacitor 10 16V Ceramic
C501	VCERMZ1CN107MY	AD		J	Capacitor 100 16V Electrolytic
C502	VCKYCY1EF104ZY	AA		J	Capacitor 0.1 25V Ceramic
C503	VCEASY1CN477MY	AD		J	Capacitor 470 16V Electrolytic
C504	RC-KZA237WJZZY	AB		J	Capacitor 10 16V Ceramic
C505	RC-KZA237WJZZY	AB		J	Capacitor 10 16V Ceramic
C506	RC-KZA237WJZZY	AB		J	Capacitor 10 16V Ceramic
C507	VCKYCY1HF103ZY	AA		J	Capacitor 0.01 50V Ceramic
C511	VCCCCY1HH101JY	AA		J	Capacitor 100p 50V Ceramic
C512	VCCCCY1HH101JY	AA		J	Capacitor 100p 50V Ceramic
C513	RC-KZA237WJZZY	AB		J	Capacitor 10 16V Ceramic
C514	RC-KZA237WJZZY	AB		J	Capacitor 10 16V Ceramic
C515	RC-KZA237WJZZY	AB		J	Capacitor 10 16V Ceramic
C516	VCKYTV1CB105KY	AC		J	Capacitor 1 16V Ceramic
C517	VCEASY1CN477MY	AD		J	Capacitor 470 16V Electrolytic
C518	RC-KZA237WJZZY	AB		J	Capacitor 10 16V Ceramic
C519	RC-KZA237WJZZY	AB		J	Capacitor 10 16V Ceramic
C524	RC-KZA237WJZZY	AB		J	Capacitor 10 16V Ceramic
C525	VCKYCY1EF104ZY	AA		J	Capacitor 0.1 25V Ceramic
C528	VCKYTV1CB105KY	AC		J	Capacitor 1 16V Ceramic
C531	RC-KZA237WJZZY	AB		J	Capacitor 10 16V Ceramic
C532	RC-KZA237WJZZY	AB		J	Capacitor 10 16V Ceramic
C533	RC-KZA237WJZZY	AB		J	Capacitor 10 16V Ceramic
C534	VCKYCY1HB103KY	AA		J	Capacitor 0.01 50V Ceramic
C538	VCKYCY1HB221KY	AA		J	Capacitor 220p 50V Ceramic
C540	VCKYCY1HF103ZY	AA		J	Capacitor 0.01 50V Ceramic
C541	VCKYCY1HB331KY	AA		J	Capacitor 330p 50V Ceramic
C542	VCKYCY1HB331KY	AA		J	Capacitor 330p 50V Ceramic
C543	VCKYCY1HB331KY	AA		J	Capacitor 330p 50V Ceramic
C544	VCKYCY1HB331KY	AA		J	Capacitor 330p 50V Ceramic
C545	VCKYCY1HB471KY	AA		J	Capacitor 470p 50V Ceramic
C546	VCKYCY1HB471KY	AA		J	Capacitor 470p 50V Ceramic
C547	VCKYCY1HB471KY	AA		J	Capacitor 470p 50V Ceramic
C548	VCKYCY1HB471KY	AA		J	Capacitor 470p 50V Ceramic
C549	VCCCCY1HH101JY	AA		J	Capacitor 100p 50V Ceramic
C550	VCCCCY1HH101JY	AA		J	Capacitor 100p 50V Ceramic
C551	VCCCCY1HH101JY	AA		J	Capacitor 100p 50V Ceramic
C552	VCCCCY1HH101JY	AA		J	Capacitor 100p 50V Ceramic
C553	VCKYCY1HB102KY	AA		J	Capacitor 1000p 50V Ceramic
C554	VCKYCY1HB102KY	AA		J	Capacitor 1000p 50V Ceramic
C555	RC-KZA237WJZZY	AB		J	Capacitor 10 16V Ceramic
C556	RC-KZA237WJZZY	AB		J	Capacitor 10 16V Ceramic
C557	RC-KZA237WJZZY	AB		J	Capacitor 10 16V Ceramic
C558	RC-KZA237WJZZY	AB		J	Capacitor 10 16V Ceramic
C559	VCKYCY1EF104ZY	AA		J	Capacitor 0.1 25V Ceramic
C560	VCKYCY1HB102KY	AA		J	Capacitor 1000p 50V Ceramic
C561	VCKYCY1HB102KY	AA		J	Capacitor 1000p 50V Ceramic
C562	VCKYTV1CB105KY	AC		J	Capacitor 1 16V Ceramic
C563	VCKYTV1CB105KY	AC		J	Capacitor 1 16V Ceramic
C564	RC-KZA237WJZZY	AB		J	Capacitor 10 16V Ceramic
C565	RC-KZA237WJZZY	AB		J	Capacitor 10 16V Ceramic
C566	RC-KZA237WJZZY	AB		J	Capacitor 10 16V Ceramic
C567	RC-KZA237WJZZY	AB		J	Capacitor 10 16V Ceramic
C568	VCKYTV1CB105KY	AC		J	Capacitor 1 16V Ceramic
C569	VCKYTV1CB105KY	AC		J	Capacitor 1 16V Ceramic
C571	VCKYCY1HB102KY	AA		J	Capacitor 1000p 50V Ceramic
C572	VCERMZ1CN107MY	AD		J	Capacitor 100 16V Electrolytic
C574	VCKYTV1CB105KY	AC		J	Capacitor 1 16V Ceramic
C575	VCKYCY1EF104ZY	AA		J	Capacitor 0.1 25V Ceramic
C577	VCKYTV1CB105KY	AC		J	Capacitor 1 16V Ceramic
C578	VCKYTV1CB105KY	AC		J	Capacitor 1 16V Ceramic
C579	VCERML1CN226MY	AC		J	Resistor 220 1/16W Metal Oxide
C580	VCKYTV1CB105KY	AC		J	Capacitor 1 16V Ceramic
C581	VCKYTV1CB105KY	AC		J	Capacitor 1 16V Ceramic
C582	VCCCCY1HH560JY	AB		J	Capacitor 56p 50V Ceramic
C583	VCKYCY1HB102KY	AA		J	Capacitor 1000p 50V Ceramic

NO.	PARTS CODE	PRICE RANK	NEW MARK	PART DELIVERY	DESCRIPTION
[4] DUNTKE187FM02(TERMINAL Unit)					
C584	VCKYTV1CB105KY	AC		J	Capacitor 1 16V Ceramic
C585	VGCCCY1HH560JY	AB		J	Capacitor 56p 50V Ceramic
C586	VCKYCY1HB102KY	AA		J	Capacitor 1000p 50V Ceramic
C587	VCEASX0JN227MY	AC		J	Capacitor 220 6.3V Electrolytic
C588	VCKYTV1CB105KY	AC		J	Capacitor 1 16V Ceramic
C589	VCKYCY1HB103KY	AA		J	Capacitor 0.01 50V Ceramic
C592	VCKYCY1EF104ZY	AA		J	Capacitor 0.1 25V Ceramic
C593	VCKYTV1CB105KY	AC		J	Capacitor 1 16V Ceramic
C600	VCKYTV1CB105KY	AC		J	Capacitor 1 16V Ceramic
C601	VCKYCY1EF104ZY	AA		J	Capacitor 0.1 25V Ceramic
C602	VCKYCY1EF104ZY	AA		J	Capacitor 0.1 25V Ceramic
C603	VGCCCY1HH330JY	AA		J	Capacitor 33p 50V Ceramic
C604	VGCCCY1HH330JY	AA		J	Capacitor 33p 50V Ceramic
C605	VCKYTV1CB105KY	AC		J	Capacitor 1 16V Ceramic
C606	RC-KZA154WJZZY	AB		J	Capacitor 4.7 16V Ceramic
C607	VGCCCY1HH101JY	AA		J	Capacitor 100p 50V Ceramic
C610	VCKYCY1EF104ZY	AA		J	Capacitor 0.1 25V Ceramic
C612	VCKYTV1CB105KY	AC		J	Capacitor 1 16V Ceramic
C613	RC-KZA154WJZZY	AB		J	Capacitor 4.7 16V Ceramic
C614	VGCCCY1HH101JY	AA		J	Capacitor 100p 50V Ceramic
C615	RC-KZA237WJZZY	AB		J	Capacitor 10 16V Ceramic
C617	VCKYCY1EF104ZY	AA		J	Capacitor 0.1 25V Ceramic
C620	RC-KZA237WJZZY	AB		J	Capacitor 10 16V Ceramic
C621	RC-KZA237WJZZY	AB		J	Capacitor 10 16V Ceramic
C622	RC-KZA237WJZZY	AB		J	Capacitor 10 16V Ceramic
C1301	RC-KZA030WJZZY	AA		J	Capacitor 2.2 10V Ceramic
C1302	RC-KZA030WJZZY	AA		J	Capacitor 2.2 10V Ceramic
C1306	VCKYCY1AB105KY	AB		J	Capacitor 1 10V Ceramic
C1307	VCKYCY1AB105KY	AB		J	Capacitor 1 10V Ceramic
C1308	VCKYCY1HB102KY	AA		J	Capacitor 1000p 50V Ceramic
C1309	VCKYCY1HB102KY	AA		J	Capacitor 1000p 50V Ceramic
C1311	VCKYCY1AB105KY	AB		J	Capacitor 1 10V Ceramic
C1312	VCKYCY1AB105KY	AB		J	Capacitor 1 10V Ceramic
C1313	VCKYCY1AB105KY	AB		J	Capacitor 1 10V Ceramic
C1314	VCERMZ1EN477MY	AE		J	Capacitor 470 25V Electrolytic
C1315	VCKYCY1EF104ZY	AA		J	Capacitor 0.1 25V Ceramic
C1316	RC-KZA114WJZZY	AB		J	Capacitor 1 25V Ceramic
C1317	RC-KZA114WJZZY	AB		J	Capacitor 1 25V Ceramic
C1318	RC-KZA046WJZZY	AC		J	Capacitor 1 50V Ceramic
C1319	RC-KZA046WJZZY	AC		J	Capacitor 1 50V Ceramic
C1320	RC-KZA046WJZZY	AC		J	Capacitor 1 50V Ceramic
C1321	RC-KZA046WJZZY	AC		J	Capacitor 1 50V Ceramic
C1328	VCKYCY1HB102KY	AA		J	Capacitor 1000p 50V Ceramic
C1329	RC-KZA114WJZZY	AB		J	Capacitor 1 25V Ceramic
C1330	RC-KZA114WJZZY	AB		J	Capacitor 1 25V Ceramic
C1402	VCEASX0JN476MY	AC		J	Capacitor 47 6.3V Electrolytic
C1404	VCKYCY1HB102KY	AA		J	Capacitor 1000p 50V Ceramic
C1405	VCKYCY1EF104ZY	AA		J	Capacitor 0.1 25V Ceramic
C1406	VCKYCY1EF104ZY	AA		J	Capacitor 0.1 25V Ceramic
C1407	VCKYCY1EF104ZY	AA		J	Capacitor 0.1 25V Ceramic
C1408	VGCCCY1HH7R0DY	AA		J	Capacitor 70p 50V Ceramic
C1409	VCKYCY1EF104ZY	AA		J	Capacitor 0.1 25V Ceramic
C1410	RC-KZA237WJZZY	AB		J	Capacitor 10 16V Ceramic
C1411	VGCCCY1HH7R0DY	AA		J	Capacitor 70p 50V Ceramic
C1412	VCKYCY1EF104ZY	AA		J	Capacitor 0.1 25V Ceramic
C1413	RC-KZA237WJZZY	AB		J	Capacitor 10 16V Ceramic
C1414	RC-KZA237WJZZY	AB		J	Capacitor 10 16V Ceramic
C1415	VCKYCY1EF104ZY	AA		J	Capacitor 0.1 25V Ceramic
C1416	RC-KZA237WJZZY	AB		J	Capacitor 10 16V Ceramic
C1417	VCKYCY1EF104ZY	AA		J	Capacitor 0.1 25V Ceramic
C1418	VCKYCY1HB103KY	AA		J	Capacitor 0.01 50V Ceramic
C1419	VGCCCY1HH270JY	AA		J	Capacitor 27p 50V Ceramic
C1420	VGCCCY1HH330JY	AA		J	Capacitor 33p 50V Ceramic
C1421	VCKYCY1EF104ZY	AA		J	Capacitor 0.1 25V Ceramic
C1422	RC-KZA237WJZZY	AB		J	Capacitor 10 16V Ceramic
C1423	VCKYTV1CB105KY	AC		J	Capacitor 1 16V Ceramic
C1424	VCKYCY1EF104ZY	AA		J	Capacitor 0.1 25V Ceramic
C1425	RC-KZA237WJZZY	AB		J	Capacitor 10 16V Ceramic
C1426	VCKYCY1EF104ZY	AA		J	Capacitor 0.1 25V Ceramic
C1427	VCKYTV1CB105KY	AC		J	Capacitor 1 16V Ceramic
C1428	VCKYTV1CB105KY	AC		J	Capacitor 1 16V Ceramic
C1429	VGCCCY1HH330JY	AA		J	Capacitor 33p 50V Ceramic
C1430	VCKYTV1CB105KY	AC		J	Capacitor 1 16V Ceramic
C1431	VGCCCY1HH330JY	AA		J	Capacitor 33p 50V Ceramic
C1432	VCKYCY1EF104ZY	AA		J	Capacitor 0.1 25V Ceramic
C1433	VCKYCY1EF104ZY	AA		J	Capacitor 0.1 25V Ceramic
C1434	RC-KZA237WJZZY	AB		J	Capacitor 10 16V Ceramic
C1435	RC-KZA154WJZZY	AB		J	Capacitor 4.7 16V Ceramic
C1436	VCKYTV1CB105KY	AC		J	Capacitor 1 16V Ceramic
C1437	VCKYCY1EF104ZY	AA		J	Capacitor 0.1 25V Ceramic
C1438	VCKYTV1CB105KY	AC		J	Capacitor 1 16V Ceramic
C1439	VCKYTV1CB105KY	AC		J	Capacitor 1 16V Ceramic
C1440	VCKYTV1CB105KY	AC		J	Capacitor 1 16V Ceramic
C1441	VCKYTV1CB105KY	AC		J	Capacitor 1 16V Ceramic
C1442	VCKYTV1CB105KY	AC		J	Capacitor 1 16V Ceramic

NO.	PARTS CODE	PRICE RANK	NEW MARK	PART DELIVERY	DESCRIPTION
[4] DUNTKE187FM02(TERMINAL Unit)					
C1443	RC-KZA237WJZZY	AB		J	Capacitor 10 16V Ceramic
C1444	VCKYCY1EF104ZY	AA		J	Capacitor 0.1 25V Ceramic
C1445	VCKYCY1EF104ZY	AA		J	Capacitor 0.1 25V Ceramic
C1446	VCKYCY1EF104ZY	AA		J	Capacitor 0.1 25V Ceramic
C1447	RC-KZA237WJZZY	AB		J	Capacitor 10 16V Ceramic
C1448	VCKYTV1CB105KY	AC		J	Capacitor 1 16V Ceramic
C1449	VCKYTV1CB105KY	AC		J	Capacitor 1 16V Ceramic
C1450	VCCCCY1HH100DY	AA		J	Capacitor 10p 50V Ceramic
C1451	VCKYCY1EF104ZY	AA		J	Capacitor 0.1 25V Ceramic
C1452	VCKYTV1CB105KY	AC		J	Capacitor 1 16V Ceramic
C1453	VCKYCY1EF104ZY	AA		J	Capacitor 0.1 25V Ceramic
C1454	RC-KZA237WJZZY	AB		J	Capacitor 10 16V Ceramic
C1455	RC-KZA009WJZZY	AB		R	Capacitor 2.2 6.3V Ceramic
C1456	VCERMZ1CN107MY	AD		J	Capacitor 100 16V Electrolytic
C1457	VCERMZ1CN107MY	AD		J	Capacitor 100 16V Electrolytic
C1458	VCKYCY1EF104ZY	AA		J	Capacitor 0.1 25V Ceramic
C1459	VCCCCY1HH101JY	AA		J	Capacitor 100p 50V Ceramic
C1460	VCERMZ1CN107MY	AD		J	Capacitor 100 16V Electrolytic
C1461	VCCCCY1HH101JY	AA		J	Capacitor 100p 50V Ceramic
C1462	VCKYCY1EF104ZY	AA		J	Capacitor 0.1 25V Ceramic
C1463	VCERMZ1CN107MY	AD		J	Capacitor 100 16V Electrolytic
C1464	VCKYTV1CB105KY	AC		J	Capacitor 1 16V Ceramic
C1465	VCKYTV1CB105KY	AC		J	Capacitor 1 16V Ceramic
C1466	VCKYTV1CB105KY	AC		J	Capacitor 1 16V Ceramic
C1467	VCKYTV1CB105KY	AC		J	Capacitor 1 16V Ceramic
C1468	VCKYCY1EF104ZY	AA		J	Capacitor 0.1 25V Ceramic
C7501	VCEASX1AN336MY	AC		J	Capacitor 33 10V Electrolytic
C7502	RC-KZA237WJZZY	AB		J	Capacitor 10 16V Ceramic
C7503	VCKYCY1EF104ZY	AA		J	Capacitor 0.1 25V Ceramic
C7504	VCKYCY1HB103KY	AA		J	Capacitor 0.01 50V Ceramic
C7507	VCEASX1CN477MY	AE		J	Capacitor 470 16V Electrolytic
C7508	VCKYCY1HB103KY	AA		J	Capacitor 0.01 50V Ceramic
C7509	VCKYCY1HB103KY	AA		J	Capacitor 0.01 50V Ceramic
C7510	VCKYCY1HB102KY	AA		J	Capacitor 1000p 50V Ceramic
C7511	VCEASX1CN107MY	AC		J	Capacitor 100 16V Electrolytic
C7514	VCCCCY1HH101JY	AA		J	Capacitor 100p 50V Ceramic
C7515	VCKYCY1EF104ZY	AA		J	Capacitor 0.1 25V Ceramic
C7516	VCKYCY1HB103KY	AA		J	Capacitor 0.01 50V Ceramic
C7517	RC-KZA237WJZZY	AB		J	Capacitor 10 16V Ceramic
C7518	VCKYCY1HB103KY	AA		J	Capacitor 0.01 50V Ceramic
C7519	VCKYCY1HB103KY	AA		J	Capacitor 0.01 50V Ceramic
C7520	VCKYCY1HB103KY	AA		J	Capacitor 0.01 50V Ceramic
C7521	VCKYCY1EF104ZY	AA		J	Capacitor 0.1 25V Ceramic
C7522	RC-KZA237WJZZY	AB		J	Capacitor 10 16V Ceramic
C7523	VCKYCY1HB103KY	AA		J	Capacitor 0.01 50V Ceramic
C7524	VCKYCY1HB103KY	AA		J	Capacitor 0.01 50V Ceramic
C7525	VCKYCY1EF104ZY	AA		J	Capacitor 0.1 25V Ceramic
C7526	VCKYCY1HB103KY	AA		J	Capacitor 0.01 50V Ceramic
C7527	VCCCCY1HH121JY	AA		J	Capacitor 120p 50V Ceramic
C7528	VCKYCY1HB103KY	AA		J	Capacitor 0.01 50V Ceramic
C7529	VCEASX1CN107MY	AC		J	Capacitor 100 16V Electrolytic
C7530	VCKYCY1EF104ZY	AA		J	Capacitor 0.1 25V Ceramic
C7532	VCKYTV1CB224KY	AB		J	Capacitor 0.22 16V Ceramic
C7533	VCCCCY1HH391JY	AB		J	Capacitor 390p 50V Ceramic
C7535	VCKYCY1HB152KY	AA		J	Capacitor 1500p 50V Ceramic
C7536	VCEASX1AN227MY	AD		J	Capacitor 220 10V Electrolytic
C7537	VCCCCY1HH180JY	AA		J	Capacitor 18p 50V Ceramic
C7538	VCKYTV1CB474KY	AC		J	Capacitor 0.47 16V Ceramic
C7540	VCKYCY1EF104ZY	AA		J	Capacitor 0.1 25V Ceramic
C7541	VCKYCY1HB102KY	AA		J	Capacitor 1000p 50V Ceramic
C7542	VCKYCY1HB103KY	AA		J	Capacitor 0.01 50V Ceramic
C7543	VCCCCY1HH4R0CY	AA		J	Capacitor 40p 50V Ceramic
C7544	VCEASX1CN106MY	AC		J	Capacitor 10 16V Electrolytic
C7547	VCKYCY1HB103KY	AA		J	Capacitor 0.01 50V Ceramic
C7548	VCEASX1CN106MY	AC		J	Capacitor 10 16V Electrolytic
C7550	RC-KZA237WJZZY	AB		J	Capacitor 10 16V Ceramic
C7552	VCKYCY1EF104ZY	AA		J	Capacitor 0.1 25V Ceramic
C7553	VCKYCY1EF104ZY	AA		J	Capacitor 0.1 25V Ceramic
C7554	VCKYCY1EF104ZY	AA		J	Capacitor 0.1 25V Ceramic
C7556	VCKYCY1EF104ZY	AA		J	Capacitor 0.1 25V Ceramic
C7560	VCCCCY1HH220JY	AA		J	Capacitor 22p 50V Ceramic
C7561	VCCCCY1HH270JY	AA		J	Capacitor 27p 50V Ceramic
C7564	VCKYCY1EF104ZY	AA		J	Capacitor 0.1 25V Ceramic
C7566	VCKYCY1EF104ZY	AA		J	Capacitor 0.1 25V Ceramic
C7568	VCKYCY1HB222KY	AA		J	Capacitor 2200p 50V Ceramic
C7572	VCKYCY1EF104ZY	AA		J	Capacitor 0.1 25V Ceramic
C7573	RC-KZA237WJZZY	AB		J	Capacitor 10 16V Ceramic
C7574	VCKYCY1EF104ZY	AA		J	Capacitor 0.1 25V Ceramic
C7575	RC-KZA237WJZZY	AB		J	Capacitor 10 16V Ceramic
C7576	VCKYCY1EF104ZY	AA		J	Capacitor 0.1 25V Ceramic
C7577	VCKYCY1EF104ZY	AA		J	Capacitor 0.1 25V Ceramic
C7580	RC-KZA237WJZZY	AB		J	Capacitor 10 16V Ceramic
D405	VHDB055L40-1Y	AC		J	Diode RB055L-40TE25
D408	VHD1SS390+-1Y	AB		J	Diode 1SS390TE61
D409	VHD1SS355/-1Y	AB		J	Diode 1SS355TE-17

NO.	PARTS CODE	PRICE RANK	NEW MARK	PART DELIVERY	DESCRIPTION
[4] DUNTKE187FM02(TERMINAL Unit)					
D411	RH-EX1395CEZZY	AC		J	Zener Diode UDZSNPTE-176.2B
D501	VHPGPFM513T-1	AH		J	PHOTODIODE
D502	RH-EXA512WJZZY	AB		R	Zener Diode MAZ8039GHL
D503	RH-EXA512WJZZY	AB		R	Zener Diode MAZ8039GHL
D504	RH-EXA512WJZZY	AB		R	Zener Diode MAZ8039GHL
D505	RH-EXA520WJZZY	AB		R	Zener Diode MAZ8051GML
D506	RH-EXA512WJZZY	AB		R	Zener Diode MAZ8039GHL
D507	RH-EXA512WJZZY	AB		R	Zener Diode MAZ8039GHL
D508	RH-EXA512WJZZY	AB		R	Zener Diode MAZ8039GHL
D509	RH-EXA520WJZZY	AB		R	Zener Diode MAZ8051GML
D511	RH-EXA520WJZZY	AB		R	Zener Diode MAZ8051GML
D512	RH-EX0265TAZZY	AB		J	Zener Diode PDZ10B,115
D513	RH-EXA554WJZZY	AB		R	Zener Diode MAZ8150GML
D517	RH-EXA512WJZZY	AB		R	Zener Diode MAZ8039GHL
D518	RH-EXA520WJZZY	AB		R	Zener Diode MAZ8051GML
D519	RH-EXA512WJZZY	AB		R	Zener Diode MAZ8039GHL
D520	RH-EXA554WJZZY	AB		R	Zener Diode MAZ8150GML
D521	VHDDAN222//--1Y	AA		J	Diode DAN222TL
D522	RH-EXA550WJZZY	AB		R	Zener Diode MAZ8130GML
D523	RH-EXA535WJZZY	AM		R	Zener Diode MAZ8082GML
D524	RH-EXA535WJZZY	AM		R	Zener Diode MAZ8082GML
D525	RH-EXA535WJZZY	AM		R	Zener Diode MAZ8082GML
D526	RH-EXA535WJZZY	AM		R	Zener Diode MAZ8082GML
D541	RH-EX0265TAZZY	AB		J	Zener Diode PDZ10B,115
D542	RH-EX0265TAZZY	AB		J	Zener Diode PDZ10B,115
D543	RH-EX0265TAZZY	AB		J	Zener Diode PDZ10B,115
D544	RH-EX0265TAZZY	AB		J	Zener Diode PDZ10B,115
D545	RH-EX0265TAZZY	AB		J	Zener Diode PDZ10B,115
D546	RH-EX0265TAZZY	AB		J	Zener Diode PDZ10B,115
D548	RH-EX0265TAZZY	AB		J	Zener Diode PDZ10B,115
D550	RH-EX0265TAZZY	AB		J	Zener Diode PDZ10B,115
D551	VHD1PS184+-1Y	AB		J	Diode 1PS184,115
D7501	VHD1SS390+-1Y	AB		J	Diode 1SS390TE61
D7503	VHD1SS390+-1Y	AB		J	Diode 1SS390TE61
D7504	VHD1SS390+-1Y	AB		J	Diode 1SS390TE61
D7505	VHD1SS390+-1Y	AB		J	Diode 1SS390TE61
D7506	VHD1SS390+-1Y	AB		J	Diode 1SS390TE61
FB401	RBLN-0253TAZZY	AA		J	Balun BLN-0253TA
FB402	RBLN-0207TAZZY	AB		J	Balun BLN-0207TA
FB404	RBLN-0253TAZZY	AA		J	Balun BLN-0253TA
FB406	RBLN-0207TAZZY	AB		J	Balun BLN-0207TA
FB501	RBLN-0077TAZZY	AB		J	Balun BLN-0077TA
FB502	RBLN-0077TAZZY	AB		J	Balun BLN-0077TA
FB503	RBLN-0077TAZZY	AB		J	Balun BLN-0077TA
FB504	RBLN-0077TAZZY	AB		J	Balun BLN-0077TA
FB505	RBLN-0077TAZZY	AB		J	Balun BLN-0077TA
FB506	RBLN-0077TAZZY	AB		J	Balun BLN-0077TA
FB507	RBLN-0077TAZZY	AB		J	Balun BLN-0077TA
FB508	RBLN-0077TAZZY	AB		J	Balun BLN-0077TA
FB509	RBLN-0065TAZZY	AA		J	Balun BLN-0065TA
FB510	RBLN-0077TAZZY	AB		J	Balun BLN-0077TA
FB511	RBLN-0077TAZZY	AB		J	Balun BLN-0077TA
FB512	RBLN-0077TAZZY	AB		J	Balun BLN-0077TA
FB513	RBLN-0077TAZZY	AB		J	Balun BLN-0077TA
FB514	RBLN-0077TAZZY	AB		J	Balun BLN-0077TA
FB515	RBLN-0077TAZZY	AB		J	Balun BLN-0077TA
FB516	RBLN-0077TAZZY	AB		J	Balun BLN-0077TA
FB517	RBLN-0077TAZZY	AB		J	Balun BLN-0077TA
FB518	RBLN-0065TAZZY	AA		J	Balun BLN-0065TA
FB519	RBLN-A188WJZZY	AA		J	Balun BLN-A188WJ
FB520	RBLN-A204WJZZY	AA		J	Balun BLN-A204WJ
FB521	RBLN-A204WJZZY	AA		J	Balun BLN-A204WJ
FB522	RBLN-A204WJZZY	AA		J	Balun BLN-A204WJ
FB523	RBLN-A204WJZZY	AA		J	Balun BLN-A204WJ
FB524	RBLN-A204WJZZY	AA		J	Balun BLN-A204WJ
FB1401	RBLN-0253TAZZY	AA		J	Balun BLN-0253TA
FB1403	RBLN-0253TAZZY	AA		J	Balun BLN-0253TA
FB7501	RBLN-0210TAZZY	AB		J	Balun BLN-0210TA
FL501	RFiLN0017TAZZY	AC		J	Filter
FL502	RFiLN0017TAZZY	AC		J	Filter
FL503	RFiLN0017TAZZY	AC		J	Filter
FL504	RFiLN0017TAZZY	AC		J	Filter
FL505	RFiLN0017TAZZY	AC		J	Filter
FL506	RFiLN0017TAZZY	AC		J	Filter
FL507	RFiLN0017TAZZY	AC		J	Filter
FL508	RFiLN0017TAZZY	AC		J	Filter
FL509	RFiLN0017TAZZY	AC		J	Filter
FL510	RFiLN0017TAZZY	AC		J	Filter
FL511	RFiLN0003TAZZY	AD		J	Filter
FL512	RFiLN0003TAZZY	AD		J	Filter
FL513	RFiLN0003TAZZY	AD		J	Filter
FL7501	RFiLC0294BMZZ	AA		J	Filter
FL7502	RFiLC0278BMZZ	AM		J	Filter
IC402	VHiBD9305AF-1Y	AK		R	IC BD9305AFVM-TR
IC403	VHiBH15LB1G-1Y	AD		J	IC BH15LB1WG-TR

LC-42X20E/S/RU

NO.	PARTS CODE	PRICE RANK	NEW MARK	PART DELIVERY	DESCRIPTION
[4] DUNTKE187FM02(TERMINAL Unit)					
IC404	VHiPQ200WNA-1Y	AG		J	IC PQ200WNA1ZPH
IC405	VHiPQ033DNA-1Y	AE		J	IC PQ033DNA1ZPH
IC406	VHiPQ1R50//--1Y	AF		J	IC PQ1R50J0000H
IC501	VHiMM1507XN-1Y	AD		J	IC MM1507XNRE
IC502	VHiT7SET08U1EY	AC		J	IC TC7SET08FU(5L,JF,T
IC503	VHiMM1506XN-1Y	AD		J	IC MM1506XNRE
IC505	VHiTC7W53U/-1Y	AF		J	IC TC7W53FU(TE12L,F)
IC506	VHiMM3151XQ-1Q	AT		J	IC MM3151XQ
IC1301	VHiYDA147SZ-1Y	AM		J	IC YDA147-SZE2
IC1401	RH-iXC201WJQZY	AQ	N	R	IC 24LC256-I/SN-G-GW1130T
IC1402	VHiR2S15500-1Y	AW	N	R	IC R2S15500SP
IC1403	VHiTAS3108D-1Y	AS		J	IC TAS3108DCPR
IC1404	VHiAK4683EQ-1Q	AR		J	IC AK4683EQ
IC1405	VHiNJM4565V-1Y	AF		J	IC NJM4565V-TE1
IC1406	VHiLVC1G66W-1Y	AC	N	R	IC 74LVC1G66GW.125
IC1407	VHiNJM2746V-1Y	AG	N	R	IC NJM2746V(TE1)
IC7501	VHiTC7W53U/-1Y	AF		J	IC TC7W53FU(TE12L,F)
IC7503	VHiPQ1M185M-1Y	AD		J	IC PQ1M185M2SPQ
IC7504	VHiTDA9886+-1Y	AQ		J	IC TDA9886TSV4
IC7506	VSSSM6J51TU-1Y	AF		J	IC Transistor IC SSM6J51TU
IC7507	VHiCE6353+-1Q	AY		R	IC WJCE6353 882206
IC7508	VHiBA7655AF-1Y	AG		J	IC BA7655AF-T1
IC7510	VHiTC4052BT-1Y	AF		J	IC TC4052BFT(EL,N,M)
J502	QJAKFA044WJZZ	AC		J	Jack
J503	QJAKFA044WJZZ	AC		J	Jack
J508	QJAKGA115WJQZ	AE		R	Jack
L402	RCiLPA154WJZZY	AE		J	Coil
L501	VPSBN100J1R2NY	AB		R	Coil Peaking 10uH
L502	VPSBN100J1R2NY	AB		R	Coil Peaking 10uH
L1303	RCiLPA897WJZZY	AD		R	Coil
L1304	RCiLPA897WJZZY	AD		R	Coil
L1305	RCiLPA897WJZZY	AD		R	Coil
L1306	RCiLPA897WJZZY	AD		R	Coil
L7502	VPCNN100J1R6NY	AB		J	Coil Peaking 10uH
L7503	VPCNN120J1R9NY	AB		J	Coil Peaking 12uH
L7504	VPSBN2R2JR54NY	AB		R	Coil Peaking 2.2uH
L7505	VPCNN330J4R2NY	AC		J	Coil Peaking 33uH
L7506	VPSBN2R2JR54NY	AB		R	Coil Peaking 2.2uH
L7509	VPSBN2R2JR54NY	AB		R	Coil Peaking 2.2uH
L7510	VPSBN2R2JR54NY	AB		R	Coil Peaking 2.2uH
L7511	VPSBN2R2JR54NY	AB		R	Coil Peaking 2.2uH
LUG501	QLUGHA009WJZZY	AC		J	Lug
LUG502	QLUGHA009WJZZY	AC		J	Lug
LUG503	QLUGHA009WJZZY	AC		J	Lug
LUG504	QLUGHA009WJZZY	AC		J	Lug
LUG505	QLUGHA009WJZZY	AC		J	Lug
LUG506	QLUGHA009WJZZY	AC		J	Lug
LUG510	QEARBA014WJFN	AE		R	Lug
LUG511	QEARBA014WJFN	AE		R	Lug
P401	QPLGNA175WJZZY	AE		J	Plug 6Pin(PE)
P501	QPLGNA349WJZZY	AE		J	Plug 15Pin(VD)
P1301	QPLGNA160WJZZY	AD		J	Plug 4Pin(SP)
P1401	QPLGN0055CEZZY	AD		J	Plug 5Pin
P7501	QPLGNA342WJZZY	AD		J	Plug 8Pin(FE)
Q402	VSRSS040P03-1Y	AE		J	Transistor RSS040P03 TB
Q407	VSDTC114EE/-1Y	AB		J	Transistor DTC114EETL
Q501	VSDTC314TK/-1Y	AC		J	Transistor DTC314TKT146
Q502	VSDTC314TK/-1Y	AC		J	Transistor DTC314TKT146
Q503	VSDTC314TK/-1Y	AC		J	Transistor DTC314TKT146
Q504	VSDTC314TK/-1Y	AC		J	Transistor DTC314TKT146
Q505	VS2SA1530AR-1Y	AB		J	Transistor 2SA1530A-T112-1R
Q506	VS2SA1530AR-1Y	AB		J	Transistor 2SA1530A-T112-1R
Q507	VS2SA1530AR-1Y	AB		J	Transistor 2SA1530A-T112-1R
Q508	VS2SA1530AR-1Y	AB		J	Transistor 2SA1530A-T112-1R
Q509	VS2SA1530AR-1Y	AB		J	Transistor 2SA1530A-T112-1R
Q510	VS2SA1530AR-1Y	AB		J	Transistor 2SA1530A-T112-1R
Q511	VSDTC314TK/-1Y	AC		J	Transistor DTC314TKT146
Q512	VSDTC314TK/-1Y	AC		J	Transistor DTC314TKT146
Q516	VS2SC2735//--1Y	AB		J	Transistor 2SC2735JC21TL
Q518	VS2SC2735//--1Y	AB		J	Transistor 2SC2735JC21TL
Q520	VS2SC2735//--1Y	AB		J	Transistor 2SC2735JC21TL
Q521	VSKRC404E+-1Y	AB		J	Transistor KRC404E
Q1302	VSDTC614TK+-1Y	AB		J	Transistor DTC614TKT146
Q1401	VSDTC614TK+-1Y	AB		J	Transistor DTC614TKT146
Q1402	VSDTC614TK+-1Y	AB		J	Transistor DTC614TKT146
Q7501	VS2SC3928AR-1Y	AA		J	Transistor 2SC3928A-T112-1R
Q7504	VS2SC3928AR-1Y	AA		J	Transistor 2SC3928A-T112-1R
Q7505	VS2SA1530AR-1Y	AB		J	Transistor 2SA1530A-T112-1R
Q7507	VSRN4904//--1Y	AB		J	Transistor RN4904
R402	VRS-CY1JF102JY	AA		J	Resistor 1k 1/16W Metal Oxide
R408	VRS-CY1JF000JY	AA		J	Resistor 0 1/16W Metal Oxide
R409	VRS-CY1JF333FY	AA		J	Resistor 33k 1/16W Metal Oxide
R410	VRS-CY1JF113FY	AA		J	Resistor 11k 1/16W Metal Oxide
R415	VRS-CY1JF512JY	AA		J	Resistor 5.1k 1/16W Metal Oxide
R420	VRS-CY1JF103JY	AA		J	Resistor 10k 1/16W Metal Oxide

NO.	PARTS CODE	PRICE RANK	NEW MARK	PART DELIVERY	DESCRIPTION
[4] DUNTKE187FM02(TERMINAL Unit)					
R423	VRS-CY1JF102JY	AA		J	Resistor 1k 1/16W Metal Oxide
R430	VRS-CY1JF432FY	AA		J	Resistor 4.3k 1/16W Metal Oxide
R431	VRS-CY1JF182FY	AA		J	Resistor 1.8k 1/16W Metal Oxide
R432	VRS-CY1JF101JY	AA		J	Resistor 100 1/16W Metal Oxide
R438	VRS-CY1JF333JY	AA		J	Resistor 33k 1/16W Metal Oxide
R501	VRS-CY1JF472JY	AA		J	Resistor 4.7k 1/16W Metal Oxide
R503	VRS-CY1JF101JY	AA		J	Resistor 100 1/16W Metal Oxide
R505	VRS-CY1JF682JY	AA		J	Resistor 6.8k 1/16W Metal Oxide
R507	VRS-CY1JF472JY	AA		J	Resistor 4.7k 1/16W Metal Oxide
R508	VRS-CY1JF000JY	AA		J	Resistor 0 1/16W Metal Oxide
R509	VRS-CY1JF000JY	AA		J	Resistor 0 1/16W Metal Oxide
R510	VRS-CY1JF000JY	AA		J	Resistor 0 1/16W Metal Oxide
R511	VRS-TQ2EF750JY	AA		R	Resistor 75 1/4W Metal Oxide
R512	VRS-TQ2EF680JY	AA		R	Resistor 68 1/4W Metal Oxide
R513	VRS-TQ2EF680JY	AA		R	Resistor 68 1/4W Metal Oxide
R514	VRS-TQ2EF750JY	AA		R	Resistor 75 1/4W Metal Oxide
R515	VRS-CY1JF682JY	AA		J	Resistor 6.8k 1/16W Metal Oxide
R516	VRS-TQ2EF750JY	AA		R	Resistor 75 1/4W Metal Oxide
R518	VRS-CY1JF000JY	AA		J	Resistor 0 1/16W Metal Oxide
R519	VRS-CY1JF000JY	AA		J	Resistor 0 1/16W Metal Oxide
R520	VRS-CY1JF000JY	AA		J	Resistor 0 1/16W Metal Oxide
R521	VRS-TQ2EF750JY	AA		R	Resistor 75 1/4W Metal Oxide
R522	VRS-TQ2EF750JY	AA		R	Resistor 75 1/4W Metal Oxide
R523	VRS-TQ2EF101JY	AA		J	Resistor 100 1/4W Metal Oxide
R524	VRS-CY1JF000JY	AA		J	Resistor 0 1/16W Metal Oxide
R526	VRS-TQ2EF750JY	AA		R	Resistor 75 1/4W Metal Oxide
R527	VRS-TQ2EF750JY	AA		R	Resistor 75 1/4W Metal Oxide
R528	VRS-CY1JF101JY	AA		J	Resistor 100 1/16W Metal Oxide
R529	VRS-CY1JF101JY	AA		J	Resistor 100 1/16W Metal Oxide
R530	VRS-TQ2EF750JY	AA		R	Resistor 75 1/4W Metal Oxide
R531	VRS-TQ2EF101JY	AA		J	Resistor 100 1/4W Metal Oxide
R532	VRS-TQ2EF750JY	AA		R	Resistor 75 1/4W Metal Oxide
R533	VRS-TQ2EF750JY	AA		R	Resistor 75 1/4W Metal Oxide
R534	VRS-CY1JF473JY	AA		J	Resistor 47k 1/16W Metal Oxide
R535	VRS-CY1JF000JY	AA		J	Resistor 0 1/16W Metal Oxide
R536	VRS-CY1JF221JY	AA		J	Resistor 220 1/16W Metal Oxide
R537	VRS-CY1JF000JY	AA		J	Resistor 0 1/16W Metal Oxide
R538	VRS-CY1JF000JY	AA		J	Resistor 0 1/16W Metal Oxide
R539	VRS-TV1JD221JY	AA		J	Resistor 220 1/16W Metal Oxide
R540	VRS-TV1JD221JY	AA		J	Resistor 220 1/16W Metal Oxide
R541	VRS-TV1JD221JY	AA		J	Resistor 220 1/16W Metal Oxide
R542	VRS-TV1JD221JY	AA		J	Resistor 220 1/16W Metal Oxide
R545	VRS-CY1JF104JY	AA		J	Resistor 100k 1/16W Metal Oxide
R546	VRS-CY1JF104JY	AA		J	Resistor 100k 1/16W Metal Oxide
R547	VRS-CJ1JF101JY	AA		J	Resistor 100 1/16W Metal Oxide
R548	VRS-CJ1JF101JY	AA		J	Resistor 100 1/16W Metal Oxide
R549	VRS-CY1JF102JY	AA		J	Resistor 1k 1/16W Metal Oxide
R550	VRS-CY1JF102JY	AA		J	Resistor 1k 1/16W Metal Oxide
R551	VRS-CY1JF104JY	AA		J	Resistor 100k 1/16W Metal Oxide
R552	VRS-CY1JF104JY	AA		J	Resistor 100k 1/16W Metal Oxide
R553	VRS-CY1JF102JY	AA		J	Resistor 1k 1/16W Metal Oxide
R554	VRS-CY1JF102JY	AA		J	Resistor 1k 1/16W Metal Oxide
R555	VRS-CY1JF564JY	AA		J	Resistor 560k 1/16W Metal Oxide
R556	VRS-CY1JF564JY	AA		J	Resistor 560k 1/16W Metal Oxide
R557	VRS-CJ1JF331JY	AA		J	Resistor 330 1/16W Metal Oxide
R558	VRS-CJ1JF331JY	AA		J	Resistor 330 1/16W Metal Oxide
R559	VRS-CY1JF104JY	AA		J	Resistor 100k 1/16W Metal Oxide
R560	VRS-CY1JF104JY	AA		J	Resistor 100k 1/16W Metal Oxide
R561	VRS-CY1JF564JY	AA		J	Resistor 560k 1/16W Metal Oxide
R562	VRS-CY1JF564JY	AA		J	Resistor 560k 1/16W Metal Oxide
R563	VRS-CJ1JF272JY	AA		J	Resistor 2.7k 1/16W Metal Oxide
R564	VRS-CJ1JF272JY	AA		J	Resistor 2.7k 1/16W Metal Oxide
R565	VRS-CY1JF104JY	AA		J	Resistor 100k 1/16W Metal Oxide
R566	VRS-CY1JF104JY	AA		J	Resistor 100k 1/16W Metal Oxide
R569	VRS-TQ2EF750JY	AA		R	Resistor 75 1/4W Metal Oxide
R570	VRS-CY1JF220JY	AA		J	Resistor 22 1/16W Metal Oxide
R571	VRS-CY1JF220JY	AA		J	Resistor 22 1/16W Metal Oxide
R572	VRS-CY1JF220JY	AA		J	Resistor 22 1/16W Metal Oxide
R573	VRS-TQ2EF750JY	AA		R	Resistor 75 1/4W Metal Oxide
R574	VRS-TQ2EF750JY	AA		R	Resistor 75 1/4W Metal Oxide
R575	VRS-TQ2EF750JY	AA		R	Resistor 75 1/4W Metal Oxide
R576	VRS-TQ2EF750JY	AA		R	Resistor 75 1/4W Metal Oxide
R577	VRS-TQ2EF750JY	AA		R	Resistor 75 1/4W Metal Oxide
R578	VRS-CY1JF102JY	AA		J	Resistor 1k 1/16W Metal Oxide
R579	VRS-CY1JF102JY	AA		J	Resistor 1k 1/16W Metal Oxide
R581	VRS-CY1JF104JY	AA		J	Resistor 100k 1/16W Metal Oxide
R582	VRS-CY1JF103JY	AA		J	Resistor 10k 1/16W Metal Oxide
R583	VRS-CY1JF102JY	AA		J	Resistor 1k 1/16W Metal Oxide
R584	VRS-CY1JF102JY	AA		J	Resistor 1k 1/16W Metal Oxide
R585	VRS-CY1JF104JY	AA		J	Resistor 100k 1/16W Metal Oxide
R586	VRS-CY1JF220JY	AA		J	Resistor 22 1/16W Metal Oxide
R587	VRS-CY1JF220JY	AA		J	Resistor 22 1/16W Metal Oxide
R588	VRS-CY1JF101JY	AA		J	Resistor 100 1/16W Metal Oxide
R589	VRS-CY1JF333JY	AA		J	Resistor 33k 1/16W Metal Oxide
R592	VRS-CY1JF220JY	AA		J	Resistor 22 1/16W Metal Oxide

NO.	PARTS CODE	PRICE RANK	NEW MARK	PART DELIVERY	DESCRIPTION
[4] DUNTKE187FM02(TERMINAL Unit)					
R595	VRS-CY1JF101JY	AA		J	Resistor 100 1/16W Metal Oxide
R596	VRS-CY1JF103JY	AA		J	Resistor 10k 1/16W Metal Oxide
R598	VRS-CY1JF333JY	AA		J	Resistor 33k 1/16W Metal Oxide
R599	VRS-CY1JF101JY	AA		J	Resistor 100 1/16W Metal Oxide
R600	VRS-CY1JF103JY	AA		J	Resistor 10k 1/16W Metal Oxide
R606	VRS-CY1JF103JY	AA		J	Resistor 10k 1/16W Metal Oxide
R608	VRS-CY1JF333JY	AA		J	Resistor 33k 1/16W Metal Oxide
R610	VRS-CY1JF101JY	AA		J	Resistor 100 1/16W Metal Oxide
R612	VRS-CY1JF101JY	AA		J	Resistor 100 1/16W Metal Oxide
R613	VRS-CY1JF103JY	AA		J	Resistor 10k 1/16W Metal Oxide
R616	VRS-CY1JF103JY	AA		J	Resistor 10k 1/16W Metal Oxide
R618	VRS-CY1JF103JY	AA		J	Resistor 10k 1/16W Metal Oxide
R620	VRS-CY1JF104JY	AA		J	Resistor 100k 1/16W Metal Oxide
R621	VRS-CY1JF750JY	AA		J	Resistor 75 1/16W Metal Oxide
R622	VRS-CY1JF750JY	AA		J	Resistor 75 1/16W Metal Oxide
R623	VRS-CY1JF750JY	AA		J	Resistor 75 1/16W Metal Oxide
R625	VRS-CY1JF750JY	AA		J	Resistor 75 1/16W Metal Oxide
R626	VRS-CY1JF221JY	AA		J	Resistor 220 1/16W Metal Oxide
R627	VRS-CY1JF561JY	AA		J	Resistor 560 1/16W Metal Oxide
R628	VRS-CJ1JF100JY	AA		J	Resistor 10 1/16W Metal Oxide
R629	VRS-CY1JF750JY	AA		J	Resistor 75 1/16W Metal Oxide
R630	VRS-CY1JF102JY	AA		J	Resistor 1k 1/16W Metal Oxide
R631	VRS-CY1JF104JY	AA		J	Resistor 100k 1/16W Metal Oxide
R632	VRS-CY1JF221JY	AA		J	Resistor 220 1/16W Metal Oxide
R633	VRS-CY1JF561JY	AA		J	Resistor 560 1/16W Metal Oxide
R634	VRS-CY1JF102JY	AA		J	Resistor 1k 1/16W Metal Oxide
R635	VRS-CY1JF564JY	AA		J	Resistor 560k 1/16W Metal Oxide
R636	VRS-CY1JF564JY	AA		J	Resistor 560k 1/16W Metal Oxide
R643	VRS-CY1JF103JY	AA		J	Resistor 10k 1/16W Metal Oxide
R644	VRS-CY1JF103JY	AA		J	Resistor 10k 1/16W Metal Oxide
R646	VRS-CY1JF103JY	AA		J	Resistor 10k 1/16W Metal Oxide
R649	VRS-CY1JF101JY	AA		J	Resistor 100 1/16W Metal Oxide
R650	VRS-CY1JF821JY	AA		J	Resistor 820 1/16W Metal Oxide
R652	VRS-CY1JF333JY	AA		J	Resistor 33k 1/16W Metal Oxide
R656	VRS-CY1JF103JY	AA		J	Resistor 10k 1/16W Metal Oxide
R657	VRS-CY1JF333JY	AA		J	Resistor 33k 1/16W Metal Oxide
R660	VRS-CY1JF101JY	AA		J	Resistor 100 1/16W Metal Oxide
R661	VRS-CY1JF821JY	AA		J	Resistor 820 1/16W Metal Oxide
R670	VRS-CY1JF101JY	AA		J	Resistor 100 1/16W Metal Oxide
R671	VRS-CY1JF821JY	AA		J	Resistor 820 1/16W Metal Oxide
R672	VRS-CY1JF000JY	AA		J	Resistor 0 1/16W Metal Oxide
R1302	VRS-CJ1JF182JY	AA		J	Resistor 1.8k 1/16W Metal Oxide
R1305	VRS-CJ1JF103JY	AA		J	Resistor 10k 1/16W Metal Oxide
R1311	VRS-CY1JF244FY	AA		J	Resistor 240k 1/16W Metal Oxide
R1312	VRS-CY1JF104FY	AA		J	Resistor 100k 1/16W Metal Oxide
R1316	VRS-CY1JF000JY	AA		J	Resistor 0 1/16W Metal Oxide
R1317	VRS-CY1JF000JY	AA		J	Resistor 0 1/16W Metal Oxide
R1318	VRS-CY1JF000JY	AA		J	Resistor 0 1/16W Metal Oxide
R1320	VRS-CY1JF000JY	AA		J	Resistor 0 1/16W Metal Oxide
R1321	VRS-CH1JF224JY	AA		R	Resistor 220k 1/16W Metal Oxide
R1323	VRS-TV1JD000JY	AA		J	Resistor 0 1/16W Metal Oxide
R1324	VRS-TV1JD000JY	AA		J	Resistor 0 1/16W Metal Oxide
R1326	VRS-CY1JF103JY	AA		J	Resistor 10k 1/16W Metal Oxide
R1327	VRS-CY1JF473JY	AA		J	Resistor 47k 1/16W Metal Oxide
R1328	VRS-CY1JF562JY	AA		J	Resistor 5.6k 1/16W Metal Oxide
R1332	VRS-TV1JD000JY	AA		J	Resistor 0 1/16W Metal Oxide
R1333	VRS-TV1JD000JY	AA		J	Resistor 0 1/16W Metal Oxide
R1401	VRS-CJ1JF101JY	AA		J	Resistor 100 1/16W Metal Oxide
R1403	VRS-CY1JF333JY	AA		J	Resistor 33k 1/16W Metal Oxide
R1404	VRS-CY1JF101JY	AA		J	Resistor 100 1/16W Metal Oxide
R1405	VRS-CY1JF223JY	AA		J	Resistor 22k 1/16W Metal Oxide
R1406	VRS-CY1JF473JY	AA		J	Resistor 47k 1/16W Metal Oxide
R1407	VRS-CY1JF473JY	AA		J	Resistor 47k 1/16W Metal Oxide
R1409	VRS-CY1JF101JY	AA		J	Resistor 100 1/16W Metal Oxide
R1410	VRS-CJ1JF472JY	AA		J	Resistor 4.7k 1/16W Metal Oxide
R1411	VRS-CY1JF101JY	AA		J	Resistor 100 1/16W Metal Oxide
R1412	VRS-CY1JF473JY	AA		J	Resistor 47k 1/16W Metal Oxide
R1413	VRS-CY1JF105JY	AA		J	Resistor 1M 1/16W Metal Oxide
R1414	VRS-CH1JF101JY	AA		J	Resistor 100 1/16W Metal Oxide
R1415	VRS-CY1JF000JY	AA		J	Resistor 0 1/16W Metal Oxide
R1416	VRS-CY1JF121JY	AA		J	Resistor 120 1/16W Metal Oxide
R1417	VRS-CY1JF102JY	AA		J	Resistor 1k 1/16W Metal Oxide
R1419	VRS-CH1JF101JY	AA		J	Resistor 100 1/16W Metal Oxide
R1420	VRS-CJ1JF473JY	AA		J	Resistor 47k 1/16W Metal Oxide
R1421	VRS-CY1JF000JY	AA		J	Resistor 0 1/16W Metal Oxide
R1422	VRS-CY1JF473JY	AA		J	Resistor 4.7 1/16W Metal Oxide
R1423	VRS-CJ1JF101JY	AA		J	Resistor 100 1/16W Metal Oxide
R1425	RBLN-0253TAZZY	AA		J	Balun BLN-0253TA
R1426	VRS-CY1JF123JY	AA		J	Resistor 12k 1/16W Metal Oxide
R1427	VRS-CY1JF101JY	AA		J	Resistor 100 1/16W Metal Oxide
R1428	VRS-CY1JF472JY	AA		J	Resistor 4.7k 1/16W Metal Oxide
R1429	VRS-CH1JF473JY	AA		J	Resistor 47k 1/16W Metal Oxide
R1430	VRS-CY1JF472JY	AA		J	Resistor 4.7k 1/16W Metal Oxide
R1431	VRS-CH1JF473JY	AA		J	Resistor 47k 1/16W Metal Oxide
R1433	VRS-CY1JF100JY	AA		J	Resistor 10 1/16W Metal Oxide

NO.	PARTS CODE	PRICE RANK	NEW MARK	PART DELIVERY	DESCRIPTION
[4] DUNTKE187FM02(TERMINAL Unit)					
R1434	VRS-CY1 JF 472 JY	AA		J	Resistor 4.7k 1/16W Metal Oxide
R1435	VRS-CY1 JF 472 JY	AA		J	Resistor 4.7k 1/16W Metal Oxide
R1436	VRS-CY1 JF 220 JY	AA		J	Resistor 22 1/16W Metal Oxide
R1437	VRS-CH1 JF 473 JY	AA		J	Resistor 47k 1/16W Metal Oxide
R1438	VRS-CY1 JF 101 JY	AA		J	Resistor 100 1/16W Metal Oxide
R1439	VRS-CY1 JF 222 JY	AA		J	Resistor 2.2k 1/16W Metal Oxide
R1440	VRS-CY1 JF 220 JY	AA		J	Resistor 22 1/16W Metal Oxide
R1442	VRS-CY1 JF 101 JY	AA		J	Resistor 100 1/16W Metal Oxide
R1443	VRS-CH1 JF 101 JY	AA		J	Resistor 100 1/16W Metal Oxide
R1445	VRS-CJ1 JF 470 JY	AA		J	Resistor 47 1/16W Metal Oxide
R1446	VRS-CJ1 JF 470 JY	AA		J	Resistor 47 1/16W Metal Oxide
R1450	VRS-CJ1 JF 220 JY	AA		J	Resistor 22 1/16W Metal Oxide
R1453	VRS-CY1 JF 4R7 JY	AA		J	Resistor 4.7 1/16W Metal Oxide
R1454	VRS-CY1 JF 101 JY	AA		J	Resistor 100 1/16W Metal Oxide
R1455	VRS-CY1 JF 243 FY	AA		J	Resistor 24k 1/16W Metal Oxide
R1456	VRS-CY1 JF 243 FY	AA		J	Resistor 24k 1/16W Metal Oxide
R1460	VRS-CY1 JF 473 JY	AA		J	Resistor 47k 1/16W Metal Oxide
R1461	VRS-CY1 JF 473 JY	AA		J	Resistor 47k 1/16W Metal Oxide
R1462	VRS-TQ2EF 220 JY	AA		J	Resistor 22 1/4W Metal Oxide
R1463	VRS-CY1 JF 102 JY	AA		J	Resistor 1k 1/16W Metal Oxide
R1464	VRS-TQ2EF 220 JY	AA		J	Resistor 22 1/4W Metal Oxide
R1465	VRS-CY1 JF 102 JY	AA		J	Resistor 1k 1/16W Metal Oxide
R1466	VRS-CY1 JF 223 JY	AA		J	Resistor 22k 1/16W Metal Oxide
R1467	VRS-CY1 JF 223 JY	AA		J	Resistor 22k 1/16W Metal Oxide
R1468	VRS-CY1 JF 473 JY	AA		J	Resistor 47k 1/16W Metal Oxide
R1469	VRS-CY1 JF 473 JY	AA		J	Resistor 47k 1/16W Metal Oxide
R1470	VRS-CJ1 JF 103 JY	AA		J	Resistor 10k 1/16W Metal Oxide
R1472	VRS-CY1 JF 102 JY	AA		J	Resistor 1k 1/16W Metal Oxide
R1473	VRS-CY1 JF 102 JY	AA		J	Resistor 1k 1/16W Metal Oxide
R1476	VRS-CY1 JF 104 JY	AA		J	Resistor 100k 1/16W Metal Oxide
R1477	VRS-CY1 JF 104 JY	AA		J	Resistor 100k 1/16W Metal Oxide
R1478	VRS-CY1 JF 104 JY	AA		J	Resistor 100k 1/16W Metal Oxide
R1479	VRS-CY1 JF 104 JY	AA		J	Resistor 100k 1/16W Metal Oxide
R1480	VRS-CY1 JF 223 JY	AA		J	Resistor 22k 1/16W Metal Oxide
R1481	VRS-CY1 JF 473 JY	AA		J	Resistor 47k 1/16W Metal Oxide
R1482	VRS-CY1 JF 223 JY	AA		J	Resistor 22k 1/16W Metal Oxide
R1483	VRS-CY1 JF 473 JY	AA		J	Resistor 47k 1/16W Metal Oxide
R7501	VRS-CY1 JF 103 JY	AA		J	Resistor 10k 1/16W Metal Oxide
R7502	VRS-CY1 JF 681 JY	AA		J	Resistor 680 1/16W Metal Oxide
R7503	VRS-CY1 JF 000 JY	AA		J	Resistor 0 1/16W Metal Oxide
R7504	VRS-CY1 JF 393 JY	AA		J	Resistor 39k 1/16W Metal Oxide
R7505	VRS-CY1 JF 333 JY	AA		J	Resistor 33k 1/16W Metal Oxide
R7506	VRS-CY1 JF 680 JY	AA		J	Resistor 68 1/16W Metal Oxide
R7508	VRS-CY1 JF 103 JY	AA		J	Resistor 10k 1/16W Metal Oxide
R7509	VRS-CY1 JF 822 JY	AA		J	Resistor 8.2k 1/16W Metal Oxide
R7512	VRS-CY1 JF 330 JY	AA		J	Resistor 33 1/16W Metal Oxide
R7516	VRS-CY1 JF 102 JY	AA		J	Resistor 1k 1/16W Metal Oxide
R7517	VRS-CY1 JF 222 JY	AA		J	Resistor 2.2k 1/16W Metal Oxide
R7518	VRS-CY1 JF 562 JY	AA		J	Resistor 5.6k 1/16W Metal Oxide
R7519	VRS-CY1 JF 562 JY	AA		J	Resistor 5.6k 1/16W Metal Oxide
R7520	VRS-CY1 JF 103 JY	AA		J	Resistor 10k 1/16W Metal Oxide
R7521	VRS-CY1 JF 103 JY	AA		J	Resistor 10k 1/16W Metal Oxide
R7524	VRS-CY1 JF 562 JY	AA		J	Resistor 5.6k 1/16W Metal Oxide
R7525	VRS-TQ2BD330 JY	AA		J	Resistor 33 1/8W Metal Oxide
R7526	VRS-CY1 JF 331 JY	AA		J	Resistor 330 1/16W Metal Oxide
R7527	VRS-CJ1 JF 472 JY	AA		J	Resistor 4.7k 1/16W Metal Oxide
R7528	VRS-CJ1 JF 101 JY	AA		J	Resistor 100 1/16W Metal Oxide
R7529	VRS-CY1 JF 471 JY	AA		J	Resistor 470 1/16W Metal Oxide
R7530	VRS-CY1 JF 000 JY	AA		J	Resistor 0 1/16W Metal Oxide
R7533	VRS-CY1 JF 392 JY	AA		J	Resistor 3.9k 1/16W Metal Oxide
R7534	VRS-CY1 JF 271 JY	AA		J	Resistor 270 1/16W Metal Oxide
R7535	VRS-CY1 JF 821 JY	AA		J	Resistor 820 1/16W Metal Oxide
R7536	VRS-CY1 JF 151 JY	AA		J	Resistor 0 1/16W Metal Oxide
R7537	VRS-CY1 JF 272 JY	AA		J	Resistor 2.7k 1/16W Metal Oxide
R7538	VRS-CY1 JF 101 JY	AA		J	Resistor 100 1/16W Metal Oxide
R7539	VRS-CY1 JF 103 JY	AA		J	Resistor 10k 1/16W Metal Oxide
R7540	VRS-CY1 JF 331 JY	AA		J	Resistor 330 1/16W Metal Oxide
R7541	VRS-CY1 JF 221 JY	AA		J	Resistor 220 1/16W Metal Oxide
R7545	VRS-CY1 JF 000 JY	AA		J	Resistor 0 1/16W Metal Oxide
R7547	VRS-CY1 JF 102 JY	AA		J	Resistor 1k 1/16W Metal Oxide
R7549	VRS-CY1 JF 102 JY	AA		J	Resistor 1k 1/16W Metal Oxide
R7550	VRS-CY1 JF 101 JY	AA		J	Resistor 100 1/16W Metal Oxide
R7551	VRS-CY1 JF 332 JY	AA		J	Resistor 3.3k 1/16W Metal Oxide
R7552	VRS-CY1 JF 102 JY	AA		J	Resistor 1k 1/16W Metal Oxide
R7567	VRS-CY1 JF 822 JY	AA		J	Resistor 8.2k 1/16W Metal Oxide
R7568	VRS-CJ1 JF 000 JY	AA		J	Resistor 0 1/16W Metal Oxide
R7569	VRS-CY1 JF 560 JY	AA		J	Resistor 56 1/16W Metal Oxide
R7570	VRS-CY1 JF 560 JY	AA		J	Resistor 56 1/16W Metal Oxide
SC501	QCNCWA673WJZZY	AF		J	Connector 82Pin
SC502	QSOCZA059WJZZ	AG		J	Socket 21Pin(INPUT1)
SC503	QSOCZA059WJZZ	AG		J	Socket 21Pin(INPUT2)
SLD7501	PSLDMA898WJFW	AD		J	Tuner If Shield
X1401	RCRSCA147WJZZY	AG		J	Crystal
X1402	RCRSCA045WJZZY	AG		J	Crystal
X1403	RCRSCA045WJZZY	AG		J	Crystal

NO.	PARTS CODE	PRICE RANK	NEW MARK	PART DELIVERY	DESCRIPTION
[4] DUNTKE187FM02(TERMINAL Unit)					
X7501	RCRSCA178WJZZY	AG		R	Crystal 4MHz
X7502	RCRSCA181WJZZY	AG		R	Crystal
[5] DUNTKE264FM01(R/C, LED Unit)					
C102	VCKYTV1CF225ZY	AB		J	Capacitor 2.2 16V Ceramic
C104	VCEASX1CN106MY	AC		J	Capacitor 10 16V Electrolytic
C105	VCKYCY1HF103ZY	AA		J	Capacitor 0.01 50V Ceramic
C107	VCEASY1CN107MY	AC		J	Capacitor 100 16V Electrolytic
D101	RH-EXA092WJZZY	AB		J	Zener Diode UDZSTE-1712B, 12V
D103	RH-PX0421CEZZY	AD		J	Diode CL-165HR/YG-D-T, YOYAKU
D114	RH-PX0421CEZZY	AD		J	Diode CL-165HR/YG-D-T, YOYAKU
D115	RH-PX0421CEZZY	AD		J	Diode CL-165HR/YG-D-T, YOYAKU
IC101	VHiGA1S100W-1Y	AE	N	R	IC GA1A1S100WP
P101	QPLGNA335WJZZY	AD		J	Plug 15Pin(RA)
P102	QPLGNA322WJZZY	AC		R	Plug 2Pin
Q102	VS2SC3928AR-1Y	AA		J	Transistor 2SC3928A-T112-1R
Q103	VS2SC3928AR-1Y	AA		J	Transistor 2SC3928A-T112-1R
Q104	VS2SC3928AR-1Y	AA		J	Transistor 2SC3928A-T112-1R
Q106	VS2SC3928AR-1Y	AA		J	Transistor 2SC3928A-T112-1R
Q107	VS2SC3928AR-1Y	AA		J	Transistor 2SC3928A-T112-1R
R101	VRS-CY1JF101JY	AA		J	Resistor 100 1/16W Metal Oxide
R104	VRS-CY1JF273JY	AA		J	Resistor 27k 1/16W Metal Oxide
R105	VRS-CY1JF393JY	AA		J	Resistor 39k 1/16W Metal Oxide
R108	VRS-CY1JF161JY	AA		J	Resistor 160 1/16W Metal Oxide
R109	VRS-CY1JF821JY	AA		J	Resistor 820 1/16W Metal Oxide
R117	VRS-CY1JF103JY	AA		J	Resistor 10k 1/16W Metal Oxide
R121	VRS-CY1JF821JY	AA		J	Resistor 820 1/16W Metal Oxide
R122	VRS-CY1JF161JY	AA		J	Resistor 160 1/16W Metal Oxide
R123	VRS-CJ1JF103JY	AA		J	Resistor 10k 1/16W Metal Oxide
R124	VRS-CJ1JF103JY	AA		J	Resistor 10k 1/16W Metal Oxide
R135	VRS-CY1JF000JY	AA		J	Resistor 0 1/16W Metal Oxide
R140	VRS-CY1JF000JY	AA		J	Resistor 0 1/16W Metal Oxide
RMC101	RRMCA053WJZZ	AE		J	Remote Receiver
SLD101	PSLDPA076WJFW	AD		J	Shield
[6] DUNTKE266FM01(KEY Unit)					
D151	RH-EX0646GEZZY	AA		J	Zener Diode MTZJT-7215B
D152	RH-EX0646GEZZY	AA		J	Zener Diode MTZJT-7215B
D155	RH-EX0646GEZZY	AA		J	Zener Diode MTZJT-7215B
P151	QPLGNA059WJZZ	AC		J	Plug 5Pin(KM)
R151	VRD-RA2BE822JY	AA		J	Resistor 8.2k 1/8W Carbon
R152	VRD-RA2BE123JY	AA		J	Resistor 12k 1/8W Carbon
R153	VRD-RA2BE822JY	AA		J	Resistor 8.2k 1/8W Carbon
R154	VRD-RA2BE123JY	AA		J	Resistor 12k 1/8W Carbon
S151	QSW-K0003AJZZ+	AA		J	Switch CH UP
S152	QSW-K0003AJZZ+	AA		J	Switch CH DOWN
S153	QSW-K0003AJZZ+	AA		J	Switch CH INPUT
S154	QSW-K0003AJZZ+	AA		J	Switch VOL UP
S155	QSW-K0003AJZZ+	AA		J	Switch VOL DOWN
S156	QSW-K0003AJZZ+	AA		J	Switch CH MENU
S157	QSW-K0003AJZZ+	AA		J	Switch CH POWER
[7] DUNTKE188FM01(MINI AV Unit)					
C801	RC-KZA067WJZZY	AB		J	Capacitor 4.7 10V Ceramic
C802	RC-KZA237WJZZY	AB		J	Capacitor 10 16V Ceramic
C803	VCKYCZ1EB103KY	AA		J	Capacitor 0.01 25V Ceramic
C804	RC-KZA237WJZZY	AB		J	Capacitor 10 16V Ceramic
C805	VCKYCZ1AB104KY	AB		J	Capacitor 0.1 10V Ceramic
C806	VCKYCZ1AB104KY	AB		J	Capacitor 0.1 10V Ceramic
C807	VCKYCZ1HB102KY	AB		J	Capacitor 1000p 50V Ceramic
C808	VCKYCZ1AB104KY	AB		J	Capacitor 0.1 10V Ceramic
C809	VCKYCZ1HB102KY	AB		J	Capacitor 1000p 50V Ceramic
C810	RC-KZA520WJQZY	AA		J	Capacitor 1 10V Ceramic
C811	VCKYCZ1AB104KY	AB		J	Capacitor 0.1 10V Ceramic
C812	VCKYCZ1HB102KY	AB		J	Capacitor 1000p 50V Ceramic
C813	RC-KZA237WJZZY	AB		J	Capacitor 10 16V Ceramic
C814	VCKYCZ1HB102KY	AB		J	Capacitor 1000p 50V Ceramic
C815	VCKYCZ1AB104KY	AB		J	Capacitor 0.1 10V Ceramic
C816	VCKYCY1HB223KY	AA		J	Capacitor 0.022 50V Ceramic
C817	VCKYCZ1HB102KY	AB		J	Capacitor 1000p 50V Ceramic
C818	VCKYCZ1HB102KY	AB		J	Capacitor 1000p 50V Ceramic
C819	RC-KZA237WJZZY	AB		J	Capacitor 10 16V Ceramic
C820	VCKYCZ1HB102KY	AB		J	Capacitor 1000p 50V Ceramic
C821	VCKYCZ1AB104KY	AB		J	Capacitor 0.1 10V Ceramic
C822	RC-KZA237WJZZY	AB		J	Capacitor 10 16V Ceramic
C823	RC-KZA520WJQZY	AA		J	Capacitor 1 10V Ceramic
C824	VCKYCZ1EB103KY	AA		J	Capacitor 0.01 25V Ceramic
C825	RC-KZA520WJQZY	AA		J	Capacitor 1 10V Ceramic
C826	VCKYCZ1EB103KY	AA		J	Capacitor 0.01 25V Ceramic
C827	VCKYCZ1HB102KY	AB		J	Capacitor 1000p 50V Ceramic
C828	VCKYCZ1HB102KY	AB		J	Capacitor 1000p 50V Ceramic
C829	VCKYCZ1AB104KY	AB		J	Capacitor 0.1 10V Ceramic
C830	VCKYCZ1AB104KY	AB		J	Capacitor 0.1 10V Ceramic
C831	VCKYCZ1HB102KY	AB		J	Capacitor 1000p 50V Ceramic

NO.	PARTS CODE	PRICE RANK	NEW MARK	PART DELIVERY	DESCRIPTION
[7] DUNTKE188FM01(MINI AV Unit)					
C832	VCKYCZ1HB102KY	AB		J	Capacitor 1000p 50V Ceramic
C903	VCKYCY1HB472KY	AA		J	Capacitor 4700p 50V Ceramic
C904	VCKYCY1HB472KY	AA		J	Capacitor 4700p 50V Ceramic
D801	VHDMA152WK/-1Y	AB		J	Diode MA152WK-(TX)
D804	VHD1PS226+-1Y	AB		J	Diode 1PS226,115
D805	VHD1PS226+-1Y	AB		J	Diode 1PS226,115
D806	VHD1PS226+-1Y	AB		J	Diode 1PS226,115
D810	VHDMA1111+-1Y	AB		J	Diode MA2J11100L
D903	RH-EX0265TAZZY	AB		J	Zener Diode PDZ10B,115
D904	RH-EX0265TAZZY	AB		J	Zener Diode PDZ10B,115
D905	RH-EX0265TAZZY	AB		J	Zener Diode PDZ10B,115
FB802	RBLN-0210TAZZY	AB		J	Balun BLN-0210TA
FB805	RBLN-A206WJZZY	AA		J	Balun BLN-A206WJ
FB902	RBLN-0077TAZZY	AB		J	Balun BLN-0077TA
FB903	RBLN-0077TAZZY	AB		J	Balun BLN-0077TA
FL901	RF iLN0017TAZZY	AC		J	Filter
FL902	RF iLN0017TAZZY	AC		J	Filter
FL903	RF iLN0017TAZZY	AC		J	Filter
IC801	VHiR5523N1B-1Y	AE	N	J	IC R5523N001B-TR-F
IC802	RH-iXC284WJQZS	AL		J	IC IC HDMI EXT4
IC803	VHiSi i9181+-1Q	AN	N	J	IC SiI9181CNU
IC804	VHiPST3615N-1Y	AC	N	J	IC PST3615NR
IC805	VHiPQ1LA185-1Y	AD		J	IC PQ1LA185MSPQ
IC806	VHiPQ1LA335-1Y	AD		R	IC PQ1LA335MSPQ
IC807	VHiAHC1G08W-1Y	AD		J	IC 74AHC1G08WG/G,125
J801	QSOCZA151WJQZ	AF		R	Socket 4Pin(USB)
J802	QJAKJ0047CEZZ	AG		J	Jack
J901	QJAKGA079WJZZ	AD		J	Jack
J902	QSOCD0456CEZZ	AE		J	Socket
L801	RC iLFA116WJZZY	AE		J	Coil
L802	RC iLFA116WJZZY	AE		J	Coil
L803	RC iLFA116WJZZY	AE		J	Coil
L804	RC iLFA116WJZZY	AE		J	Coil
L805	RC iLFA116WJZZY	AE		J	Coil
L806	RC iLFA116WJZZY	AE		J	Coil
L807	RC iLFA116WJZZY	AE		J	Coil
L808	RC iLFA116WJZZY	AE		J	Coil
L809	RC iLFA228WJZZY	AD		J	Coil
LUG901	QLUGHA006WJZZY	AC		J	Lug
LUG902	QLUGHA006WJZZY	AC		J	Lug
P801	QPLGNA334WJZZY	AD		J	Plug 14Pin(US)
P901	QPLGNA335WJZZY	AD		J	Plug 15Pin(VD)
Q803	VSKRC404E+-1Y	AB		J	Transistor KRC404E
Q804	VSKRC404E+-1Y	AB		J	Transistor KRC404E
Q805	VSKRC404E+-1Y	AB		J	Transistor KRC404E
Q806	VSKTA1535T+-1Y	AC		J	Transistor KTA1535T-RTK/P
Q807	VSRT1N141U/-1Y	AB		J	Transistor RT1N141U-T111-1
R802	VRS-CZ1JF473JY	AA		J	Resistor 47k 1/16W Metal Oxide
R804	VRS-CZ1JF103JY	AA		J	Resistor 10k 1/16W Metal Oxide
R807	VRS-CJ1JF100JY	AA		J	Resistor 10 1/16W Metal Oxide
R808	VRS-CZ1JF103JY	AA		J	Resistor 10k 1/16W Metal Oxide
R809	VRS-CZ1JF103JY	AA		J	Resistor 10k 1/16W Metal Oxide
R810	VRS-CJ1JF100JY	AA		J	Resistor 10 1/16W Metal Oxide
R812	VRS-CJ1JF473JY	AA		J	Resistor 47k 1/16W Metal Oxide
R815	VRS-CZ1JF000JY	AA		J	Resistor 0 1/16W Metal Oxide
R817	VRS-CZ1JF103JY	AA		J	Resistor 10k 1/16W Metal Oxide
R818	VRS-CZ1JF103JY	AA		J	Resistor 10k 1/16W Metal Oxide
R819	VRS-CZ1JF102JY	AA		J	Resistor 1k 1/16W Metal Oxide
R820	VRS-TW2ED100JY	AA		J	Resistor 10 1/4W Metal Oxide
R821	VRS-CZ1JF104JY	AA		J	Resistor 100k 1/16W Metal Oxide
R822	VRS-TW2ED100JY	AA		J	Resistor 10 1/4W Metal Oxide
R823	VRS-CZ1JF104JY	AA		J	Resistor 100k 1/16W Metal Oxide
R824	VRS-CZ1JF103JY	AA		J	Resistor 10k 1/16W Metal Oxide
R825	VRS-CZ1JF101JY	AA		J	Resistor 100 1/16W Metal Oxide
R826	VRS-CZ1JF103JY	AA		J	Resistor 10k 1/16W Metal Oxide
R827	VRS-CZ1JF751JY	AA		J	Resistor 750 1/16W Metal Oxide
R828	VRS-CZ1JF474JY	AA		J	Resistor 470k 1/16W Metal Oxide
R829	VRS-CJ1JF100JY	AA		J	Resistor 10 1/16W Metal Oxide
R830	VRS-CZ1JF102JY	AA		J	Resistor 1k 1/16W Metal Oxide
R831	VRS-CZ1JF103JY	AA		J	Resistor 10k 1/16W Metal Oxide
R832	VRS-CZ1JF103JY	AA		J	Resistor 10k 1/16W Metal Oxide
R834	VRS-CZ1JF102JY	AA		J	Resistor 1k 1/16W Metal Oxide
R838	VRS-CZ1JF472JY	AA		J	Resistor 4.7k 1/16W Metal Oxide
R839	VRS-CZ1JF101JY	AA		J	Resistor 100 1/16W Metal Oxide
R840	VRS-CZ1JF331JY	AA		J	Resistor 330 1/16W Metal Oxide
R907	VRS-CZ1JF104JY	AA		J	Resistor 100k 1/16W Metal Oxide
R908	VRS-CZ1JF104JY	AA		J	Resistor 100k 1/16W Metal Oxide
R909	VRS-CZ1JF000JY	AA		J	Resistor 0 1/16W Metal Oxide
R910	VRS-CZ1JF000JY	AA		J	Resistor 0 1/16W Metal Oxide
R914	VRS-CZ1JF000JY	AA		J	Resistor 0 1/16W Metal Oxide
R915	VRS-CZ1JF000JY	AA		J	Resistor 0 1/16W Metal Oxide
SC801	QSOCZA149WJQZY	AF		J	Socket 23Pin
SC802	QCNCWA657WJQZY	AG		J	Connector 21Pin(HM)
VA801	RH-VXA074WJZZY	AB		J	Varistor AVRL101A1R1NTB
VA802	RH-VXA074WJZZY	AB		J	Varistor AVRL101A1R1NTB

LC-42X20E/S/RU

NO.	PARTS CODE	PRICE RANK	NEW MARK	PART DELIVERY	DESCRIPTION
[7] DUNTKE188FM01(MINI AV Unit)					
VA803	RH-VXA187WJQZY	AB		J	Varistor EZAEG2A50AX
VA804	RH-VXA187WJQZY	AB		J	Varistor EZAEG2A50AX
VA805	RH-VXA187WJQZY	AB		J	Varistor EZAEG2A50AX
VA806	RH-VXA187WJQZY	AB		J	Varistor EZAEG2A50AX
VA807	RH-VXA187WJQZY	AB		J	Varistor EZAEG2A50AX
VA808	RH-VXA187WJQZY	AB		J	Varistor EZAEG2A50AX
VA809	RH-VXA187WJQZY	AB		J	Varistor EZAEG2A50AX
VA810	RH-VXA187WJQZY	AB		J	Varistor EZAEG2A50AX

[8] CABINET PARTS

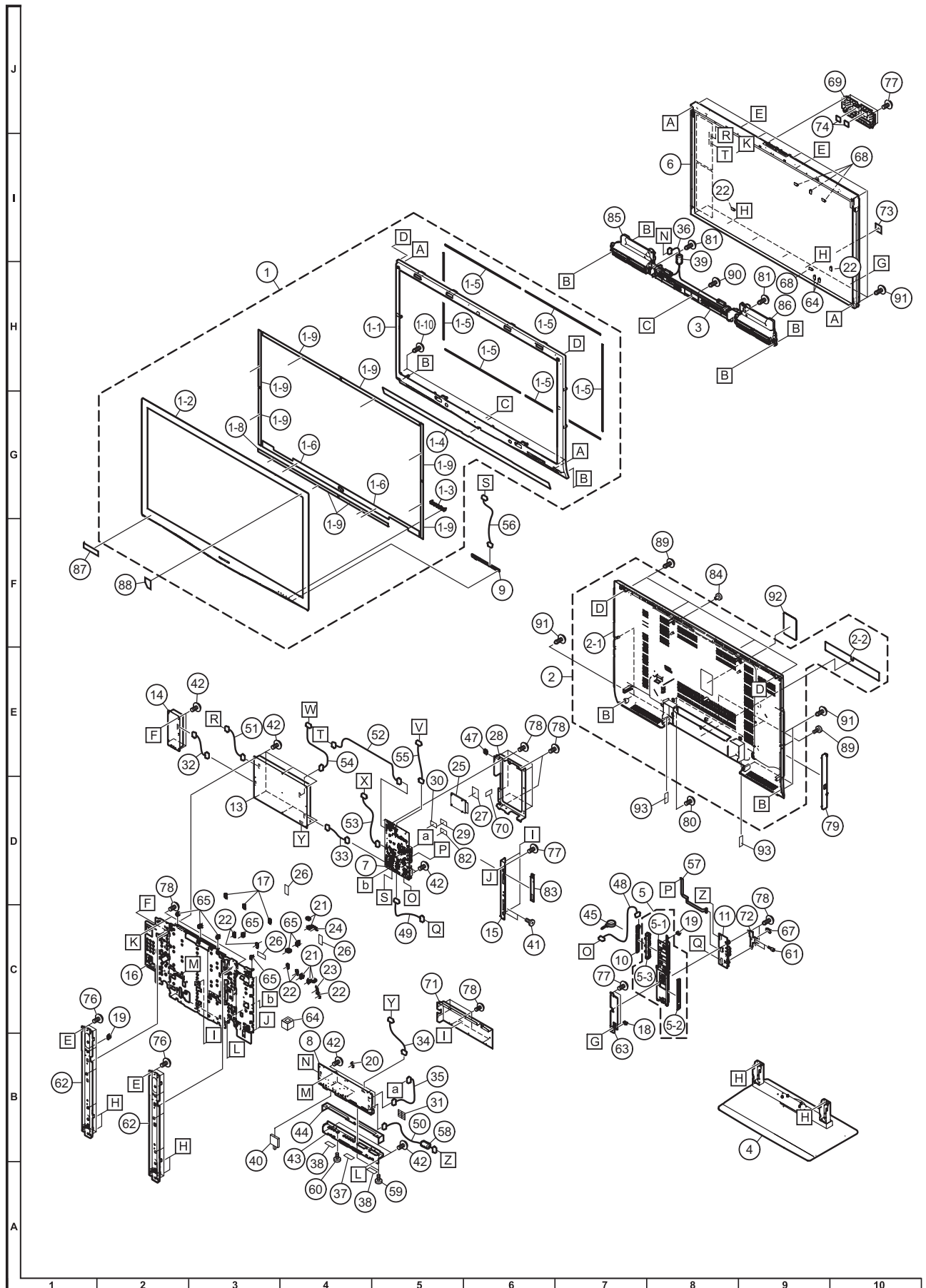

NO.	PARTS CODE	PRICE RANK	NEW MARK	PART DELIVERY	DESCRIPTION
[8] CABINET PARTS					
1	CCABAB823WJ11	BU	N	P	Front Cabinet Ass'y
1-1	Not Available	-	N	-	Front Cabinet
1-2	Not Available	-	N	-	Front Mask Ass'y
1-3	Not Available	-	N	-	LED Decoration
1-4	Not Available	-	N	-	Speaker Net
1-5	Not Available	-	N	-	Mask Himeron, x6
1-6	Not Available	-	N	-	Front Cover Tape B, x2
1-8	Not Available	-	N	-	Front Cover Tape D
1-9	Not Available	-	N	-	Front Cover Tape E, x6
1-10	XJPS730P08WS0	AA		J	Screw, x3 (Main Pow Termin)
2	CCABBB127WJ11	BS	N	P	Rear Cabinet Ass'y
2-1	Not Available	-	N	-	Rear Cabinet
2-2	Not Available	-	N	-	Terminal Label
3	CCOVAC336WJ11	AY	N	P	Bottom Cover Ass'y
4	CDAi-A378WJ12	BS	N	R	Stand Unit
5	CCOVAC392WJ12	AN	N	P	MINI AV Key Cover Ass'y
5-1	Not Available	-	N	-	MINI AV Key Cover
5-2	Not Available	-	N	-	MINI Terminal Label
5-3	Not Available	-	N	-	Control Button
6	R1LK420D3LZ50Y	FK	N	J	42" Full HD LCD Panel Module
7	DUNTKE186FM02	CT	N	R	MAIN Unit
8	DUNTKE187FM02	BY	N	R	SUB Unit
9	DUNTKE264FM01	AS	N	R	R/C, LED Unit
10	DUNTKE266FM01	AR	N	R	KEY Unit
11	DUNTKE188FM01	BD	N	R	MINIAV Unit
13	RDENCA231WJQZ	BZ	N	J	POWER Unit
14	RUNTKA311WJQZ	BA	N	J	AC INLET Unit
15	LANGKB173WJ1A	AN	N	R	Side Terminal Angle
16	LCHSMA386WJ1W	BB	N	R	Chassis Tray
17	LHLDFA036WJKZ	AB		J	Wire Holder (Tray), x3
18	LHLDWA133WJKZ	AC	N	J	Wire Holder (Tray)
19	LHLDWA143WJKZ	AC		J	Wire Holder (Tray), x5
20	LHLDWA144WJKZ	AC	N	R	Wire Holder (Terminal PWB)
21	LHLDWA151WJKZ	AB		J	Wire Holder (Tray), x5
22	LHLDWA163WJKZ	AC		J	Wire Holder (Tray), x5
23	LHLDWA172WJKZ	AD		R	Wire Holder (Tray)
24	PMLT-A487WJZZ	AD	N	R	Gasket (10x30x7)
25	PRDARA482WJ1W	AV	N	R	Main Radiator
26	PSLDMA702WJZZ	AD		R	Conductiv Shield (10x20), x3
27	PSLDMB154WJQZ	AD		J	13x30x10 Gasket
28	PSLDMB158WJ1W	AP	N	R	Main Shiled
29	PSPA3B312WJKZ	AD	N	J	Spacer (25*25 T2.0)
30	PSPA3B313WJKZ	AC		J	Spacer (20*20 T2.0)
31	QCNCMA673WJZZ	AG	N	J	Connector (B To B Plug 80)
32	QCNW-F946WJQZ	AH	N	R	Connecting Cord (AC:POWERAC)
33	QCNW-F947WJQZ	AL	N	R	Connecting Cord (PD:MAINPOWER)
34	QCNW-F948WJQZ	AK	N	R	Connecting Cord (PE:TERMINPOWER)
35	QCNW-G001WJQZ	AR	N	R	Connecting Cord (FE:MAINTERMINA)
36	QCNW-G025WJQZ	AH	N	R	Connecting Cord (SP:TERMINALSP)
37	QEARZA108WJFW	AE	N	R	Earth Plate(L)
38	QEARZA109WJFW	AD	N	R	Earth Plate(S), x2
39	RCORFA023WJZZ	AK		J	Core (for SP Wire)
40	RTUDAA014WJQZ	AX	N	S	Tuner
41	XBPS830P06000	AA		J	Screw, x2 (FOR HDMI)
42	XJPS730P08WS0	AA		J	Screw, x22 (Main Pow Termin)
43	LANGKB175WJ1A	AL	N	P	Terminal Angle Bottom
44	LANGKB248WJFW	AE	N	P	Scart Angle
45	LHLDW1033CE00	AA		R	Cable Tie
47	LHLDWA186WJKZ	AB	N	R	Wire Holder
48	QCNW-G020WJQZ	AG		R	Connecting Cord (KM:MAINKEY)
49	QCNW-G023WJQZ	AL	N	P	Connecting Cord (US:MAINMINI AV)
50	QCNW-G024WJQZ	AS		J	Connecting Cord (VD:SUBMINI AV)
51	QCNW-G026WJQZ	AH		R	Connecting Cord (LA1:POWERINV_R)
52	QCNW-G028WJQZ	AH		J	Connecting Cord (LB:MAININV)
53	QCNW-G181WJQZ	BD		R	Connecting Cord (LW:MAIN-LCDCTL)
54	QCNW-G182WJQZ	AF		R	Connecting Cord (PL:POWER-LCDCTL)
55	QCNW-G183WJQZ	AN		J	Connecting Cord (FR:MAIN-LCD)
56	QCNW-G237WJQZ	AL		R	Connecting Cord (RA:MAIN-LED)
57	QPWBHE321WJQZ	AX		J	FPC (HM:MAINMINI AV)
58	RCORFA012WJZZ	AG		R	Core (for US/RA, for DV)
59	XBBS830P08000	AA		J	Screw (for Scart), x2
60	XBBS930P04000	AA		J	Screw (for Tuner Fix), x1
61	XiPSN20P04000	AA		J	Screw (for HDMI), x2
62	LANGKB187WJ1W	AT	N	P	Panel Support Ang, x2
63	LANGKB216WJ1W	AF	N	P	MINI AV Angle
64	LHLDWA133WJKZ	AC	N	J	Wire Holder (Tray), x2
65	LHLDWA143WJKZ	AC		J	Wire Holder (Tray), x3
67	LHLDWA164WJKZ	AD		R	Wire Holder
68	LHLDWA175WJUJ	AC	N	R	Wire Holder, x6
69	PCOVP2609WJZZ	AH	N	S	Control Shield
70	PFLT-A079WJZZ	AE		P	Conductive Sheet (20x90)
71	PSLDMB159WJ1W	AH	N	P	AV Shield
72	PSLDMB179WJ1W	AD	N	P	MINI AV Shield
73	PSPA3B311WJZZ	AA	N	P	Spacer

NO.	PARTS CODE	PRICE RANK	NEW MARK	PART DELIVERY	DESCRIPTION
[8] CABINET PARTS					
74	PSPA ZB597WJKZ	AF		S	Cooling Sheet
76	XBBS740P08000	AA		J	Screw (for Center Ang), x14
77	XBBS830P06000	AA		J	Screw (Miniav,Tay,Ctl), x16
78	XJPS730P08WS0	AA		J	Screw, x11 (Main AV, Shield)
79	GCOVAC356WJ1A	AY	N	P	Side AV Cover
80	LX-BZA170WJF9	AC		S	Screw (for Rear Cabinet), x2
81	LX-HZA003WJFN	AC		J	Screw (for SP), x2
82	PCOVZA105WJKZ	AE	N	P	CI Card Cover (Spacer)
83	PSHEPA541WJZZ	AD	N	P	Terminal Sheet
84	PSHEPA543WJZZ	AA	N	P	Sheet for Boss, x2
85	RSP-ZA261WJZZ	AY	N	S	Speaker L
86	RSP-ZA262WJZZ	AY	N	S	Speaker R
87	TLABZB620WJZZ	AE	N	S	POP Label A (LC-42X20E/S)
87	TLABZB618WJZZ	AF	N	P	POP Label A (LC-42X20RU)
88	TLABZB672WJZZ	AE	N	P	POP Label 42
89	XBPS740P10JS0	AA	N	P	Screw (for Rear Cabinet), x8
90	XEBS930P10000	AA		J	Screw (for Bottom Cover), x1
91	XEBS940P16000	AB		J	Screw (for Rear Cabinet), x15
92	TLABNC117WJZZ	AC		S	Model Label
93	PSPAGA389WJZZ	AB	N	P	Spacer (Stand), x2

[9] SUPPLIED ACCESSORIES

X2 Remote control unit

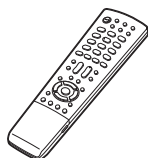

X1 AC cord

(For Europe, except U.K. and Eire)

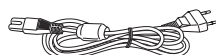

(For U.K. and Eire)



U.K. type 3-pin AC cord is only included with models for U.K. and Eire.

X3 Cable clamp

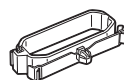

X11 Stand unit

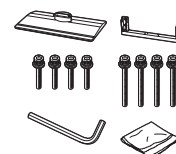

- X4 Guarrantee Card (R only)
- X5 Guarrantee Card (E only)
- X6 AQUOS Care Plan (E only)
- X7 Operation Manual (ENGLISH..)
- X8 Operation Manual (SWEDISH..)
- X9 Operation Manual (RUSSIAN..)
- X10 Operation Manual (POLISH..)

NO.	PARTS CODE	PRICE RANK	NEW MARK	PART DELIVERY	DESCRIPTION
[9] SUPPLIED ACCESSORIES					
X1	QACCBA073WJPZ	AV		J	AC Cord (for UK and Eire)
X1	QACCKA021WJPZ	AT		S	AC Cord (for Europe without UK and Eire)
X2	RRMCGA586WJSA	AT	N	S	Remote Control Unit
X3	LHLDWA173WJKZ	AE	N	R	Cable Clamp
X4	TGAN-A077WJZZ	AD		J	Guarantee Card (R only)
X5	TGAN-A801WJZZ	AB	N	P	Guarantee Card (E only)
X6	TGAN-A802WJZZ	AC	N	P	AQUOS Care PlanN (E only)
X7	TINS-D181WJZZ	AQ	N	P	Operation Manual (ENGLISH..) (for "E" and "S" models)
X8	TINS-D182WJZZ	AQ	N	P	Operation Manual (SWEDISH..) (for "E" and "S" models)
X9	TINS-D184WJZZ	AH	N	P	Operation Manual (RUSSIAN..) (for "RU" models)
X10	TINS-D183WJZZ	AS	N	P	Operation Manual (POLISH..) (for "E" models)
X11	CDAi-A378WJ12	BS	N	R	Stand Unit

[10] PACKING PARTS

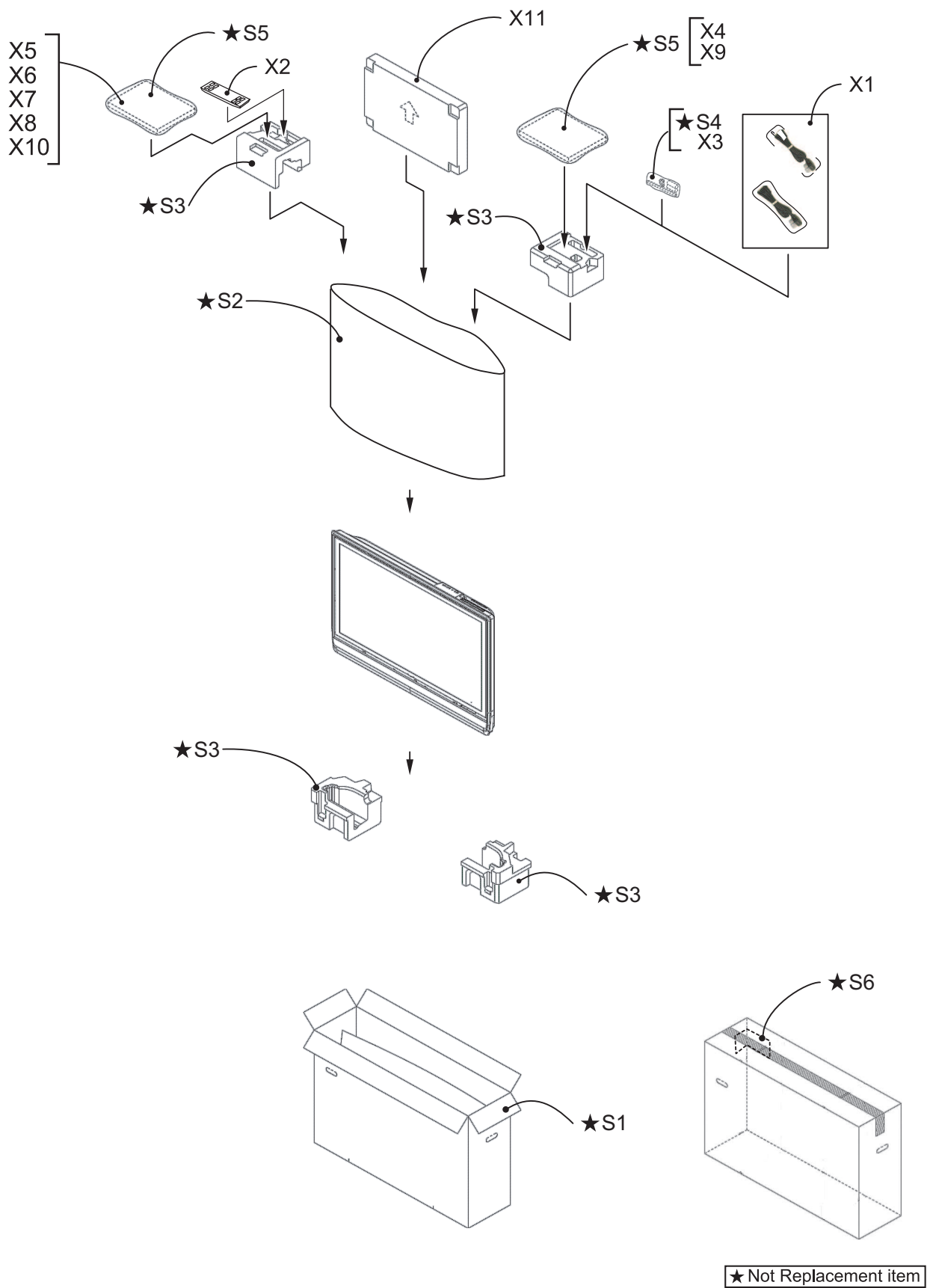

LC-42X20E/S/RU

NO.	PARTS CODE	PRICE RANK	NEW MARK	PART DELIVERY	DESCRIPTION
[10] PACKING PARTS					
S1	SPAKCD527WJZZ	-	N	-	Packing Case (LC-42X20E/S)
S1	SPAKCD536WJZZ	-		-	Packing Case (LC-42X20RU)
S2	SPAKPA758WJZZ	-		-	Wrapping Paper
S3	SPAKXB535WJZZ	-		-	Buffer Material
S4	SSAKAA009WJZZ	-		-	Polyethylene Bag
S5	SSAKAA010WJZZ	-		-	Polyethylene Bag
S6	TLABM5584BMZZ	-		-	Case Label
[11] SERVICE JIGS					
N	QCNW-G440WJQZ	AP	N	J	4-5pins L=1000mm, Main to Key
N	QCNW-G441WJQZ	AW	N	J	15pins L=1000mm, Main to R/C, LED
N	QCNW-G442WJQZ	AK	N	J	2pins L=1000mm, R/C, LED to ILLUMINATION
N	QCNW-G443WJPZ	AY	N	J	14-14/3pins L=1135mm, MiniAV to Main
N	QCNW-G444WJQZ	AY	N	J	15pins L=1000mm, MiniAV to Terminal
N	QCNW-G445WJQZ	AP	N	J	4-2/2pins L=1000mm, Terminal to Speaker
N	QCNW-G446WJQZ	AV	N	J	12pins L=1000mm, Main to Power
N	QCNW-G447WJQZ	AS	N	J	6pins L=1000mm, Terminal to Power
N	QCNW-G448WJQZ	AP	N	J	9pins L=1000mm, Main to Inverter
N	QCNW-G449WJQZ	AU	N	J	12-11/4pins L=1000mm, LCD Controller to Main/Power
N	QCNW-G616WJQZ	BK	N	J	41pins L=1000mm, Main to LCD Controller

SHARP

COPYRIGHT © 2008 BY SHARP CORPORATION

ALL RIGHTS RESERVED.

No Part of this publication may be reproduced, stored in a retrieval system, or transmitted in any form or by any means, electronic, mechanical, photocopying, recording, or otherwise, without prior written permission of the publisher.