

SHARP PARTS GUIDE



LCD COLOUR TELEVISION

MODELS **LC-42XD1E/RU**

CONTENTS

- | | |
|---|--|
| [1] PRINTED WIRING BOARD ASSEMBLIES (NOT REPLACEMENT ITEM) | [6] DUNTKD833FM06 (Digital Tuner Unit) |
| [2] LCD PANEL AND TUNER (NOTE: THE PARTS HERE SHOWN ARE SUPPLIED AS AN ASSEMBLY BUT NOT INDEPENDENTLY.) | [7] DUNTKD909FM05 (R/C LED Unit) |
| [3] DUNTKD604FM21 (AV Unit) | [8] DUNTKD910FM01 (KEY Unit) |
| [4] DUNTKD628FM12 (Digital Unit) | [9] DUNTKD915FM07 (Main Unit) |
| [5] DUNTKD787FM02 (Power Unit) | [10] CABINET PARTS |
| | [11] SUPPLIED ACCESSORIES |
| | [12] PACKING PARTS |
| | [13] SERVICE JIGS |

Parts marked with "▲" are important for maintaining the safety of the set. Be sure to replace these parts with specified ones for maintaining the safety and performance of the set.

NO.	PARTS CODE	PRICE RANK	NEW MARK	PART DELIVERY	DESCRIPTION
[1] PRINTED WIRING BOARD ASSEMBLIES (NOT REPLACEMENT ITEM)					
N	DUNTKD604FM21		N	R	AV Unit
N	DUNTKD628FM12		N	R	Digital Unit
N	DUNTKD787FM02		N	R	Power Unit
N	DUNTKD833FM06		N	S	Digital Tuner Unit
N	DUNTKD909FM05		N	R	R/C LED Unit
N	DUNTKD910FM01		N	R	KEY Unit
N	DUNTKD915FM07		N	R	Main Unit
[2] LCD PANEL AND TUNER (NOTE: THE PARTS HERE SHOWN ARE SUPPLIED AS AN ASSEMBLY BUT NOT INDEPENDENTLY.)					
N	R1LK370D3LZ1AB		N	J	37V Full-HD LCD Panel Module Unit
TU201	RTUNQA034WJZZ			R	U/V Tuner
[3] DUNTKD604FM21 (AV Unit)					
C301	VCKYCY1HB392KY	AA		R	Capacitor, 3900p 50V Ceramic
C302	VCKYCY1HB392KY	AA		R	Capacitor, 3900p 50V Ceramic
C303	VCKYCY1HF224ZY	AA		R	Capacitor, 0.22 50V Ceramic
C304	VCKYCY1HF224ZY	AA		R	Capacitor, 0.22 50V Ceramic
C305	VCKYCY1HB104KY	AA		R	Capacitor, 0.1 50V Ceramic
C306	VCEASX1HN225MY	AB		R	Capacitor, 2.2 50V Electrolytic
C307	VCEASX1HN225MY	AB		R	Capacitor, 2.2 50V Electrolytic
C308	VCKYCY1HB104KY	AA		R	Capacitor, 0.1 50V Ceramic
C309	VCKYCY1HB222KY	AA		R	Capacitor, 2200p 50V Ceramic
C310	VCKYCY1HB222KY	AA		R	Capacitor, 2200p 50V Ceramic
C311	VCEASX1CN226MY	AC		R	Capacitor, 22 16V Electrolytic
C312	VCKYCY1HB222KY	AA		R	Capacitor, 2200p 50V Ceramic
C313	VCKYCY1HB222KY	AA		R	Capacitor, 2200p 50V Ceramic
C314	VCKYCY1HB153KY	AA		R	Capacitor, 0.015 50V Ceramic
C315	VCKYCY1HB153KY	AA		R	Capacitor, 0.015 50V Ceramic
C316	VCCCCY1HH330JY	AA		R	Capacitor, 33p 50V Ceramic
C317	VCCCCY1HH330JY	AA		R	Capacitor, 33p 50V Ceramic
C318	VCCCCY1HH470JY	AA		R	Capacitor, 47p 50V Ceramic
C319	VCCCCY1HH470JY	AA		R	Capacitor, 47p 50V Ceramic
C320	VCEASX1HN225MY	AB		R	Capacitor, 2.2 50V Electrolytic
C321	VCEASX1HN225MY	AB		R	Capacitor, 2.2 50V Electrolytic
C322	VCKYCY1HF224ZY	AA		R	Capacitor, 0.22 50V Ceramic
C323	VCKYCY1HF224ZY	AA		R	Capacitor, 0.22 50V Ceramic
C324	VCEASX1HN106MY	AC		R	Capacitor, 10 50V Electrolytic
C325	VCEASX1HN106MY	AC		R	Capacitor, 10 50V Electrolytic
C326	VCKYCY1HB153KY	AA		R	Capacitor, 0.015 50V Ceramic
C327	VCKYCY1HB153KY	AA		R	Capacitor, 0.015 50V Ceramic
C328	VCEASX1HN225MY	AB		R	Capacitor, 2.2 50V Electrolytic
C329	VCEASX1HN225MY	AB		R	Capacitor, 2.2 50V Electrolytic
C330	VCESYA1VM477M+	AF		R	Capacitor, 470 35V Electrolytic
C331	VCESYA1VM477M+	AF		R	Capacitor, 470 35V Electrolytic
C332	VCKYCY1HB221KY	AA		R	Capacitor, 220p 50V Ceramic
C333	VCKYCY1HB221KY	AA		R	Capacitor, 220p 50V Ceramic
C334	VCKYCY1HB221KY	AA		R	Capacitor, 220p 50V Ceramic
C335	VCKYCY1HB221KY	AA		R	Capacitor, 220p 50V Ceramic
C338	RC-EZA513WJZZ	AH		R	Capacitor, 470 50V Electrolytic
C339	RC-EZA513WJZZ	AH		R	Capacitor, 470 50V Electrolytic
C340	VCKYTV1EB224KY	AA		R	Capacitor, 0.22 25V Ceramic
C341	VCKYTV1EB224KY	AA		R	Capacitor, 0.22 25V Ceramic
C342	VCFYFA1HA334J+	AB		R	Capacitor, 0.33 50V
C343	VCFYFA1HA334J+	AB		R	Capacitor, 0.33 50V
C346	VCEASX1HN105MY	AB		R	Capacitor, 1 50V Electrolytic
C347	VCEASX1HN105MY	AB		R	Capacitor, 1 50V Electrolytic
C348	VCEASX1VN226MY	AC		R	Capacitor, 22 35V Electrolytic
C349	VCEASX1VN226MY	AC		R	Capacitor, 22 35V Electrolytic
C350	VCKYCY1HB103KY	AA		R	Capacitor, 0.01 50V Ceramic
C351	VCKYCY1HB103KY	AA		R	Capacitor, 0.01 50V Ceramic
C352	VCKYCY1HB103KY	AA		R	Capacitor, 0.01 50V Ceramic
C353	VCKYCY1HB103KY	AA		R	Capacitor, 0.01 50V Ceramic
C354	VCKYCY1HB102KY	AA		R	Capacitor, 1000p 50V Ceramic
C355	VCKYCY1HB102KY	AA		R	Capacitor, 1000p 50V Ceramic
C356	VCEASY1HN476MY	AD		R	Capacitor, 47 50V Electrolytic
C357	VCEASY1HN476MY	AD		R	Capacitor, 47 50V Electrolytic
C358	VCEASX1HN106MY	AC		R	Capacitor, 10 50V Electrolytic
C359	VCEASX1HN106MY	AC		R	Capacitor, 10 50V Electrolytic
C360	VCEASY1CN476MY	AC		R	Capacitor, 47 16V Electrolytic
C361	RC-KZA073WJZZY	AD		R	Capacitor, 10 16V Ceramic
C362	VCKYTV1EB224KY	AA		R	Capacitor, 0.22 25V Ceramic
C363	VCKYTV1EB224KY	AA		R	Capacitor, 0.22 25V Ceramic
C364	VCEASY1CN477MY	AD		R	Capacitor, 470 16V Electrolytic
C365	VCKYCY1HB222KY	AA		R	Capacitor, 2200p 50V Ceramic
C366	VCKYCY1HB222KY	AA		R	Capacitor, 2200p 50V Ceramic
C1101	VCKYTV1EB104KY	AB		R	Capacitor, 0.1 25V Ceramic
C1102	VCKYTV1EB104KY	AB		R	Capacitor, 0.1 25V Ceramic
C1103	VCKYTV1EB104KY	AB		R	Capacitor, 0.1 25V Ceramic
C1104	VCCCCY1HH101JY	AA		R	Capacitor, 100p 50V Ceramic
C1105	VCKYTV1EB104KY	AB		R	Capacitor, 0.1 25V Ceramic
C1106	VCKYTV1EB104KY	AB		R	Capacitor, 0.1 25V Ceramic
C1107	VCKYTV1EB104KY	AB		R	Capacitor, 0.1 25V Ceramic
C1108	VCCCCY1HH101JY	AA		R	Capacitor, 100p 50V Ceramic

NO.	PARTS CODE	PRICE RANK	NEW MARK	PART DELIVERY	DESCRIPTION
[3] DUNTKD604FM21 (AV Unit)					
C1109	VCKYTQ1HB104KY	AD		R	Capacitor, 0.1 50V Ceramic
C1110	VCKYTQ1HB104KY	AD		R	Capacitor, 0.1 50V Ceramic
C1114	VCKYCY1HB221KY	AA		R	Capacitor, 220p 50V Ceramic
C1116	VCKYCY1HB221KY	AA		R	Capacitor, 220p 50V Ceramic
C1117	VGCCCY1HH101JY	AA		R	Capacitor, 100p 50V Ceramic
C1118	VGCCCY1HH101JY	AA		R	Capacitor, 100p 50V Ceramic
C1119	VCKYCY1HB102KY	AA		R	Capacitor, 1000p 50V Ceramic
C1120	VCKYCY1HB102KY	AA		R	Capacitor, 1000p 50V Ceramic
C1121	VCKYTV1CB105KY	AC		R	Capacitor, 1 16V Ceramic
C1122	VCKYCY1HB331KY	AA		R	Capacitor, 330p 50V Ceramic
C1123	VCKYCY1HB331KY	AA		R	Capacitor, 330p 50V Ceramic
C1124	VCKYTV1CB105KY	AC		R	Capacitor, 1 16V Ceramic
C1125	VCKYCY1HB471KY	AA		R	Capacitor, 470p 50V Ceramic
C1126	VCKYCY1HB471KY	AA		R	Capacitor, 470p 50V Ceramic
C1127	VGCCCY1HH101JY	AA		R	Capacitor, 100p 50V Ceramic
C1128	VGCCCY1HH101JY	AA		R	Capacitor, 100p 50V Ceramic
C1130	VCEASY1CN477MY	AD		R	Capacitor, 470 16V Electrolytic
C1131	VCKYCY1HF103ZY	AA		R	Capacitor, 0.01 50V Ceramic
C1132	RC-KZA073WJZZY	AD		R	Capacitor, 10 16V Ceramic
C1133	RC-KZA073WJZZY	AD		R	Capacitor, 10 16V Ceramic
C1134	VCKYCY1HB102KY	AA		R	Capacitor, 1000p 50V Ceramic
C1135	VCKYCY1HB102KY	AA		R	Capacitor, 1000p 50V Ceramic
C1136	RC-KZA073WJZZY	AD		R	Capacitor, 10 16V Ceramic
C1137	RC-KZA073WJZZY	AD		R	Capacitor, 10 16V Ceramic
C1138	VCKYTV1CB105KY	AC		R	Capacitor, 1 16V Ceramic
C1139	VCKYCY1HB331KY	AA		R	Capacitor, 330p 50V Ceramic
C1140	VCKYCY1HB331KY	AA		R	Capacitor, 330p 50V Ceramic
C1142	VCKYTV1CB105KY	AC		R	Capacitor, 1 16V Ceramic
C1143	VCKYCY1HB471KY	AA		R	Capacitor, 470p 50V Ceramic
C1144	VCKYCY1HB471KY	AA		R	Capacitor, 470p 50V Ceramic
C1145	RC-KZA073WJZZY	AD		R	Capacitor, 10 16V Ceramic
C1146	RC-KZA073WJZZY	AD		R	Capacitor, 10 16V Ceramic
C1147	VCKYCY1EF104ZY	AA		R	Capacitor, 0.1 25V Ceramic
C1148	RC-KZA073WJZZY	AD		R	Capacitor, 10 16V Ceramic
C1157	RC-KZA073WJZZY	AD		R	Capacitor, 10 16V Ceramic
C1158	RC-KZA073WJZZY	AD		R	Capacitor, 10 16V Ceramic
C1159	VCKYCY1HF103ZY	AA		R	Capacitor, 0.01 50V Ceramic
C1160	VCKYCY1EF104ZY	AA		R	Capacitor, 0.1 25V Ceramic
C1161	RC-KZA073WJZZY	AD		R	Capacitor, 10 16V Ceramic
C1162	VCEASY1CN477MY	AD		R	Capacitor, 470 16V Electrolytic
C1201	VCKYCY1HB102KY	AA		R	Capacitor, 1000p 50V Ceramic
C1202	VCKYCY1HF103ZY	AA		R	Capacitor, 0.01 50V Ceramic
C1203	VGCCCY1HH101JY	AA		R	Capacitor, 100p 50V Ceramic
C1204	VGCCCY1HH100DY	AA		R	Capacitor, 10p 50V Ceramic
C1205	RC-KZA073WJZZY	AD		R	Capacitor, 10 16V Ceramic
C1206	VGCCCY1HH101JY	AA		R	Capacitor, 100p 50V Ceramic
C1207	VGCCCY1HH100DY	AA		R	Capacitor, 10p 50V Ceramic
C1208	RC-KZA073WJZZY	AD		R	Capacitor, 10 16V Ceramic
C1210	VGCCCY1HH101JY	AA		R	Capacitor, 100p 50V Ceramic
C1211	VCKYCY1HB102KY	AA		R	Capacitor, 1000p 50V Ceramic
C1212	VCKYTV1CB105KY	AC		R	Capacitor, 1 16V Ceramic
C1216	VGCCCY1HH101JY	AA		R	Capacitor, 100p 50V Ceramic
C1217	VCKYCY1HB102KY	AA		R	Capacitor, 1000p 50V Ceramic
C1218	VCKYTV1CB105KY	AC		R	Capacitor, 1 16V Ceramic
C1219	VCEASY1CN476MY	AC		R	Capacitor, 47 16V Electrolytic
C1220	RC-KZA073WJZZY	AD		R	Capacitor, 10 16V Ceramic
C1221	RC-KZA073WJZZY	AD		R	Capacitor, 10 16V Ceramic
C1222	RC-KZA073WJZZY	AD		R	Capacitor, 10 16V Ceramic
C1223	RC-KZA073WJZZY	AD		R	Capacitor, 10 16V Ceramic
C1224	VGCCCY1HH101JY	AA		R	Capacitor, 100p 50V Ceramic
C1225	VGCCCY1HH101JY	AA		R	Capacitor, 100p 50V Ceramic
C1251	VCEASX1CN107MY	AC		R	Capacitor, 100 16V Electrolytic
C1252	VCKYTV1CB105KY	AC		R	Capacitor, 1 16V Ceramic
C1253	VCKYCY1EF104ZY	AA		R	Capacitor, 0.1 25V Ceramic
D306	VHD1SS390+-1Y	AB		R	Diode, 1SS390TE61
D307	VHD1SS390+-1Y	AB		R	Diode, 1SS390TE61
D308	VHD1SS390+-1Y	AB		R	Diode, 1SS390TE61
D309	VHD1SS390+-1Y	AB		R	Diode, 1SS390TE61
D310	VHD1SS390+-1Y	AB		R	Diode, 1SS390TE61
D311	RH-EXA103WJZZY	AB		R	Zener Diode, UDZSTE-1736B
D312	RH-EXA103WJZZY	AB		R	Zener Diode, UDZSTE-1736B
D313	RH-EX1026CEZZY	AB		R	Zener Diode, 3.9V
D314	RH-EX1295CEZZY	AB		R	Zener Diode, HZU30BTRF-E
D315	RH-EX1295CEZZY	AB		R	Zener Diode, HZU30BTRF-E
D316	RH-EX1295CEZZY	AB		R	Zener Diode, HZU30BTRF-E
D317	RH-EX1295CEZZY	AB		R	Zener Diode, HZU30BTRF-E
D318	VHD1SS390+-1Y	AB		R	Diode, 1SS390TE61
D1101	RH-EX1068CEZZY	AB		R	Zener Diode, EX1068CE
D1102	RH-EX1026CEZZY	AB		R	Zener Diode, 3.9V
D1103	RH-EX1026CEZZY	AB		R	Zener Diode, 3.9V
D1104	RH-EX1068CEZZY	AB		R	Zener Diode, EX1068CE
D1105	RH-EX1064CEZZY	AB		R	Zener Diode, EX1064CE
D1106	RH-EX1034CEZZY	AB		R	Zener Diode, EX1034CE
D1107	RH-EX1034CEZZY	AB		R	Zener Diode, EX1034CE
D1108	RH-EX1064CEZZY	AB		R	Zener Diode, EX1064CE

NO.	PARTS CODE	PRICE RANK	NEW MARK	PART DELIVERY	DESCRIPTION
[3] DUNTKD604FM21 (AV Unit)					
D1109	RH-EX1049CEZZY	AB		R	Zener Diode, EX1049CE
D1110	RH-EX1049CEZZY	AB		R	Zener Diode, EX1049CE
D1111	RH-EX1049CEZZY	AB		R	Zener Diode, EX1049CE
D1112	RH-EX1049CEZZY	AB		R	Zener Diode, EX1049CE
D1113	RH-EX1034CEZZY	AB		R	Zener Diode, EX1034CE
D1114	RH-EX1034CEZZY	AB		R	Zener Diode, EX1034CE
D1115	RH-EX1034CEZZY	AB		R	Zener Diode, EX1034CE
D1116	RH-EX1034CEZZY	AB		R	Zener Diode, EX1034CE
D1117	RH-EX1034CEZZY	AB		R	Zener Diode, EX1034CE
D1118	RH-EX1026CEZZY	AB		R	Zener Diode, 3.9V
D1119	RH-EX1026CEZZY	AB		R	Zener Diode, 3.9V
D1120	RH-EX1026CEZZY	AB		R	Zener Diode, 3.9V
D1121	RH-EX1026CEZZY	AB		R	Zener Diode, 3.9V
D1122	RH-EX1026CEZZY	AB		R	Zener Diode, 3.9V
D1123	RH-EX1026CEZZY	AB		R	Zener Diode, 3.9V
D1201	RH-EX1239CEZZY	AB		R	Zener Diode, , EX1239CE
FB1101	RBLN-0062TAZZY	AB		R	Balun, BLN-0062TA
FB1102	RBLN-0062TAZZY	AB		R	Balun, BLN-0062TA
FB1103	RBLN-0077TAZZY	AB		R	Balun, BLN-0077TA
FB1104	RBLN-0077TAZZY	AB		R	Balun, BLN-0077TA
FB1105	RBLN-0051TAZZY	AC		R	Balun, BLN-0051TA
FB1106	RBLN-0062TAZZY	AB		R	Balun, BLN-0062TA
FB1107	RBLN-0051TAZZY	AC		R	Balun, BLN-0051TA
FB1108	RBLN-0062TAZZY	AB		R	Balun, BLN-0062TA
FB1109	RBLN-0062TAZZY	AB		R	Balun, BLN-0062TA
FB1110	RBLN-0062TAZZY	AB		R	Balun, BLN-0062TA
FB1111	RBLN-0051TAZZY	AC		R	Balun, BLN-0051TA
FB1112	RBLN-0051TAZZY	AC		R	Balun, BLN-0051TA
FB1201	RBLN-0051TAZZY	AC		R	Balun, BLN-0051TA
FB1202	RBLN-0051TAZZY	AC		R	Balun, BLN-0051TA
FB1203	RBLN-0062TAZZY	AB		R	Balun, BLN-0062TA
FB1204	RBLN-0062TAZZY	AB		R	Balun, BLN-0062TA
FB1213	RBLN-0210TAZZY	AB		R	Balun, BLN-0210TA
FB1218	RBLN-0254TAZZY	AB		R	Balun, BLN-0254TA
FL1101	RFiLN0017TAZZY	AC		R	Filter
FL1102	RFiLN0017TAZZY	AC		R	Filter
FL1103	RFiLN0017TAZZY	AC		R	Filter
FL1104	RFiLN0017TAZZY	AC		R	Filter
FL1105	RFiLN0017TAZZY	AC		R	Filter
FL1106	RFiLN0017TAZZY	AC		R	Filter
FL1107	RFiLN0017TAZZY	AC		R	Filter
FL1108	RFiLN0017TAZZY	AC		R	Filter
FL1109	RFiLN0017TAZZY	AC		R	Filter
FL1110	RFiLN0017TAZZY	AC		R	Filter
FL1211	RFiLN0017TAZZY	AC		R	Filter
FL1212	RFiLN0017TAZZY	AC		R	Filter
IC301	VHiTDA8931T-1Y	AS		R	IC, TDA8931T/N1,118
IC302	VHiTDA8931T-1Y	AS		R	IC, TDA8931T/N1,118
IC303	VHiNJM4558M-1Y	AD		R	IC, NJM4558M-TE1
IC1101	VHiMM1506XN-1Y	AD		R	IC, MM1506XNRE
IC1102	VHiMM1506XN-1Y	AD		R	IC, MM1506XNRE
IC1201	VHiMM1507XN-1Y	AD		R	IC, MM1507XNRE
J1101	QSOCZA116WJZZ	AK		R	Socket, INPUT1/INPUT2
J1201	QJAKZA033WJZZ	AK		R	Jack, INPUT3
J1301	QJAKJA007WJZZ	AD		R	Jack, Headphone Out
L301	RCiLPA386WJZZ	AF		R	Coil
L302	RCiLPA386WJZZ	AF		R	Coil
LUG301	QLUGHA009WJZZY	AC		R	Lug
LUG302	QLUGHA009WJZZY	AC		R	Lug
LUG303	QLUGHA009WJZZY	AC		R	Lug
LUG304	QLUGHA009WJZZY	AC		R	Lug
P301	QPLGNA173WJZZY	AD		R	Plug, 4Pin (SP)
P1101	QCNCMA250WJZZ	AE		R	Connector, 23Pin
P1102	QCNCMA250WJZZ	AE		R	Connector, 23Pin
P1201	QCNCMA250WJZZ	AE		R	Connector, 23Pin
Q301	VS2SC3928AR-1Y	AB		R	Transistor, 2SC3928A-T112-1R
Q302	VS2SC3928AR-1Y	AB		R	Transistor, 2SC3928A-T112-1R
Q303	VSDTC314TK/-1Y	AC		R	Transistor, DTC314TKT146
Q304	VSDTC314TK/-1Y	AC		R	Transistor, DTC314TKT146
Q305	VSDTC314TK/-1Y	AC		R	Transistor, DTC314TKT146
Q306	VSDTC314TK/-1Y	AC		R	Transistor, DTC314TKT146
Q307	VS2SA1530AR-1Y	AB		R	Transistor, 2SA1530A-T112-1R
Q1101	VSDTC314TK/-1Y	AC		R	Transistor, DTC314TKT146
Q1102	VSDTC314TK/-1Y	AC		R	Transistor, DTC314TKT146
Q1103	VS2SA1530AR-1Y	AB		R	Transistor, 2SA1530A-T112-1R
Q1104	VS2SA1530AR-1Y	AB		R	Transistor, 2SA1530A-T112-1R
Q1105	VSDTC314TK/-1Y	AC		R	Transistor, DTC314TKT146
Q1106	VSDTC314TK/-1Y	AC		R	Transistor, DTC314TKT146
Q1107	VS2SA1530AR-1Y	AB		R	Transistor, 2SA1530A-T112-1R
Q1108	VS2SA1530AR-1Y	AB		R	Transistor, 2SA1530A-T112-1R
Q1201	VS2SA1530AR-1Y	AB		R	Transistor, 2SA1530A-T112-1R
Q1202	VS2SA1530AR-1Y	AB		R	Transistor, 2SA1530A-T112-1R
Q1203	VSDTC314TK/-1Y	AC		R	Transistor, DTC314TKT146
Q1204	VSDTC314TK/-1Y	AC		R	Transistor, DTC314TKT146
R301	VRS-CJ1JF102JY	AA		R	Resistor, 1k 1/16W Metal Oxide

NO.	PARTS CODE	PRICE RANK	NEW MARK	PART DELIVERY	DESCRIPTION
[3] DUNTKD604FM21 (AV Unit)					
R302	VRS-CJ1 JF 104 JY	AA		R	Resistor, 100k 1/16W Metal Oxide
R303	VRS-CY1 JF 222 JY	AA		R	Resistor, 2.2k 1/16W Metal Oxide
R304	VRS-CY1 JF 222 JY	AA		R	Resistor, 2.2k 1/16W Metal Oxide
R305	VRS-CY1 JF 222 JY	AA		R	Resistor, 2.2k 1/16W Metal Oxide
R306	VRS-CJ1 JF 472 JY	AA		R	Resistor, 4.7k 1/16W Metal Oxide
R307	VRS-CJ1 JF 104 JY	AA		R	Resistor, 100k 1/16W Metal Oxide
R308	VRS-CY1 JF 473 JY	AA		R	Resistor, 47k 1/16W Metal Oxide
R309	VRS-CY1 JF 473 JY	AA		R	Resistor, 47k 1/16W Metal Oxide
R310	VRS-CY1 JF 102 JY	AA		R	Resistor, 1k 1/16W Metal Oxide
R311	VRS-CY1 JF 102 JY	AA		R	Resistor, 1k 1/16W Metal Oxide
R312	VRS-CY1 JF 102 JY	AA		R	Resistor, 1k 1/16W Metal Oxide
R313	VRS-CY1 JF 102 JY	AA		R	Resistor, 1k 1/16W Metal Oxide
R314	VRS-CY1 JF 392 JY	AA		R	Resistor, 3.9k 1/16W Metal Oxide
R315	VRS-CY1 JF 474 JY	AA		R	Resistor, 470k 1/16W Metal Oxide
R316	VRS-CY1 JF 392 JY	AA		R	Resistor, 3.9k 1/16W Metal Oxide
R317	VRS-CY1 JF 474 JY	AA		R	Resistor, 470k 1/16W Metal Oxide
R318	VRS-TW2HF 820 JY	AB		R	Resistor, 82 1/2W Metal Oxide
R319	VRS-CY1 JF 122 JY	AA		R	Resistor, 1.2k 1/16W Metal Oxide
R320	VRS-CY1 JF 122 JY	AA		R	Resistor, 1.2k 1/16W Metal Oxide
R321	VRS-CY1 JF 103 JY	AA		R	Resistor, 10k 1/16W Metal Oxide
R322	VRS-CY1 JF 103 JY	AA		R	Resistor, 10k 1/16W Metal Oxide
R323	VRS-CY1 JF 473 JY	AA		R	Resistor, 47k 1/16W Metal Oxide
R324	VRS-CY1 JF 473 JY	AA		R	Resistor, 47k 1/16W Metal Oxide
R325	VRS-CY1 JF 152 JY	AA		R	Resistor, 1.5k 1/16W Metal Oxide
R326	VRS-CY1 JF 152 JY	AA		R	Resistor, 1.5k 1/16W Metal Oxide
R327	VRS-CJ1 JF 103 JY	AA		R	Resistor, 10k 1/16W Metal Oxide
R328	VRS-CJ1 JF 392 JY	AA		R	Resistor, 3.9k 1/16W Metal Oxide
R329	VRS-CY1 JF 682 JY	AA		R	Resistor, 6.8k 1/16W Metal Oxide
R330	VRS-CY1 JF 222 JY	AA		R	Resistor, 2.2k 1/16W Metal Oxide
R331	VRS-CY1 JF 222 JY	AA		R	Resistor, 2.2k 1/16W Metal Oxide
R333	VRS-CJ1 JF 103 JY	AA		R	Resistor, 10k 1/16W Metal Oxide
R334	VRS-CY1 JF 682 JY	AA		R	Resistor, 6.8k 1/16W Metal Oxide
R335	VRS-TW2ED100 JY	AA		R	Resistor, 10 1/4W Metal Oxide
R336	VRS-TW2ED100 JY	AA		R	Resistor, 10 1/4W Metal Oxide
R337	VRS-TW2ED100 JY	AA		R	Resistor, 10 1/4W Metal Oxide
R338	VRS-TW2ED100 JY	AA		R	Resistor, 10 1/4W Metal Oxide
R339	VRS-TW2ED220 JY	AB		R	Resistor, 22 1/4W Metal Oxide
R340	VRS-TW2ED220 JY	AB		R	Resistor, 22 1/4W Metal Oxide
R343	VRS-TW2ED000 JY	AB		R	Resistor, 0 1/4W Metal Oxide
R345	VRS-CJ1 JF 103 JY	AA		R	Resistor, 10k 1/16W Metal Oxide
R346	VRS-CY1 JF 560 JY	AA		R	Resistor, 56 1/16W Metal Oxide
R347	VRS-CY1 JF 560 JY	AA		R	Resistor, 56 1/16W Metal Oxide
R348	VRS-CJ1 JF 222 JY	AA		R	Resistor, 2.2k 1/16W Metal Oxide
R349	VRS-CY1 JF 221 JY	AA		R	Resistor, 220 1/16W Metal Oxide
R350	VRS-CY1 JF 221 JY	AA		R	Resistor, 220 1/16W Metal Oxide
R351	VRS-CY1 JF 103 JY	AA		R	Resistor, 10k 1/16W Metal Oxide
R352	VRS-CY1 JF 103 JY	AA		R	Resistor, 10k 1/16W Metal Oxide
R353	VRS-CY1 JF 102 JY	AA		R	Resistor, 1k 1/16W Metal Oxide
R354	VRS-CY1 JF 102 JY	AA		R	Resistor, 1k 1/16W Metal Oxide
R355	VRS-TW2ED2R7 JY	AB		R	Resistor, 2.7 1/4W Metal Oxide
R356	VRS-CY1 JF 103 JY	AA		R	Resistor, 10k 1/16W Metal Oxide
R358	VRS-CY1 JF 000 JY	AA		R	Resistor, 0 1/16W Metal Oxide
R360	VRS-CY1 JF 472 JY	AA		R	Resistor, 4.7k 1/16W Metal Oxide
R1101	VRS-CY1 JF 153FY	AA		R	Resistor, 15k 1/16W Metal Oxide
R1102	VRS-CY1 JF 153FY	AA		R	Resistor, 15k 1/16W Metal Oxide
R1103	VRS-CY1 JF 393FY	AA		R	Resistor, 39k 1/16W Metal Oxide
R1104	VRS-CY1 JF 000 JY	AA		R	Resistor, 0 1/16W Metal Oxide
R1105	VRS-CY1 JF 000 JY	AA		R	Resistor, 0 1/16W Metal Oxide
R1106	VRS-CY1 JF 000 JY	AA		R	Resistor, 0 1/16W Metal Oxide
R1107	VRS-TV1 JD221 JY	AA		R	Resistor, 220 1/16W Metal Oxide
R1108	VRS-CY1 JF 393FY	AA		R	Resistor, 39k 1/16W Metal Oxide
R1109	VRS-TV1 JD221 JY	AA		R	Resistor, 220 1/16W Metal Oxide
R1110	VRS-CY1 JF 000 JY	AA		R	Resistor, 0 1/16W Metal Oxide
R1111	VRS-TW2ED680 JY	AA		R	Resistor, 68 1/4W Metal Oxide
R1112	VRS-TW2ED680 JY	AA		R	Resistor, 68 1/4W Metal Oxide
R1113	VRS-TW2ED750 JY	AA		R	Resistor, 75 1/4W Metal Oxide
R1114	VRS-TW2ED750 JY	AA		R	Resistor, 75 1/4W Metal Oxide
R1115	VRS-CY1 JF 000 JY	AA		R	Resistor, 0 1/16W Metal Oxide
R1116	VRS-TW2ED750 JY	AA		R	Resistor, 75 1/4W Metal Oxide
R1117	VRS-TW2ED750 JY	AA		R	Resistor, 75 1/4W Metal Oxide
R1118	VRS-TW2ED750 JY	AA		R	Resistor, 75 1/4W Metal Oxide
R1119	VRS-TW2ED101 JY	AA		R	Resistor, 100 1/4W Metal Oxide
R1120	VRS-CY1 JF 000 JY	AA		R	Resistor, 0 1/16W Metal Oxide
R1121	VRS-TW2ED750 JY	AA		R	Resistor, 75 1/4W Metal Oxide
R1123	VRS-TW2ED750 JY	AA		R	Resistor, 75 1/4W Metal Oxide
R1125	VRS-TW2ED750 JY	AA		R	Resistor, 75 1/4W Metal Oxide
R1126	VRS-CY1 JF 000 JY	AA		R	Resistor, 0 1/16W Metal Oxide
R1127	VRS-TW2ED750 JY	AA		R	Resistor, 75 1/4W Metal Oxide
R1128	VRS-TW2ED101 JY	AA		R	Resistor, 100 1/4W Metal Oxide
R1129	VRS-TW2ED750 JY	AA		R	Resistor, 75 1/4W Metal Oxide
R1130	VRS-CY1 JF 000 JY	AA		R	Resistor, 0 1/16W Metal Oxide
R1131	VRS-CY1 JF 221 JY	AA		R	Resistor, 220 1/16W Metal Oxide
R1134	VRS-CY1 JF 102 JY	AA		R	Resistor, 1k 1/16W Metal Oxide
R1137	VRS-CY1 JF 000 JY	AA		R	Resistor, 0 1/16W Metal Oxide
R1138	VRS-CY1 JF 000 JY	AA		R	Resistor, 0 1/16W Metal Oxide

NO.	PARTS CODE	PRICE RANK	NEW MARK	PART DELIVERY	DESCRIPTION
[3] DUNTKD604FM21 (AV Unit)					
R1139	VRS-CJ1JF101JY	AA		R	Resistor, 100 1/16W Metal Oxide
R1140	VRS-CJ1JF331JY	AA		R	Resistor, 330 1/16W Metal Oxide
R1141	VRS-CY1JF564JY	AA		R	Resistor, 560k 1/16W Metal Oxide
R1142	VRS-CY1JF564JY	AA		R	Resistor, 560k 1/16W Metal Oxide
R1143	VRS-CJ1JF272JY	AA		R	Resistor, 2.7k 1/16W Metal Oxide
R1144	VRS-CY1JF102JY	AA		R	Resistor, 1k 1/16W Metal Oxide
R1145	VRS-CY1JF102JY	AA		R	Resistor, 1k 1/16W Metal Oxide
R1146	VRS-TV1JD221JY	AA		R	Resistor, 220 1/16W Metal Oxide
R1147	VRS-CY1JF102JY	AA		R	Resistor, 1k 1/16W Metal Oxide
R1148	VRS-TV1JD221JY	AA		R	Resistor, 220 1/16W Metal Oxide
R1150	VRS-CY1JF104JY	AA		R	Resistor, 100k 1/16W Metal Oxide
R1152	VRS-CJ1JF101JY	AA		R	Resistor, 100 1/16W Metal Oxide
R1153	VRS-CY1JF104JY	AA		R	Resistor, 100k 1/16W Metal Oxide
R1154	VRS-CY1JF104JY	AA		R	Resistor, 100k 1/16W Metal Oxide
R1155	VRS-CJ1JF331JY	AA		R	Resistor, 330 1/16W Metal Oxide
R1156	VRS-CY1JF564JY	AA		R	Resistor, 560k 1/16W Metal Oxide
R1157	VRS-CY1JF564JY	AA		R	Resistor, 560k 1/16W Metal Oxide
R1158	VRS-CJ1JF272JY	AA		R	Resistor, 2.7k 1/16W Metal Oxide
R1159	VRS-CY1JF102JY	AA		R	Resistor, 1k 1/16W Metal Oxide
R1160	VRS-CY1JF102JY	AA		R	Resistor, 1k 1/16W Metal Oxide
R1161	VRS-CY1JF221JY	AA		R	Resistor, 220 1/16W Metal Oxide
R1173	VRS-CY1JF104JY	AA		R	Resistor, 100k 1/16W Metal Oxide
R1177	VRS-CY1JF102JY	AA		R	Resistor, 1k 1/16W Metal Oxide
R1179	VRS-CY1JF102JY	AA		R	Resistor, 1k 1/16W Metal Oxide
R1201	VRS-CY1JF101JY	AA		R	Resistor, 100 1/16W Metal Oxide
R1202	VRS-CY1JF392JY	AA		R	Resistor, 3.9k 1/16W Metal Oxide
R1203	VRS-CY1JF682JY	AA		R	Resistor, 6.8k 1/16W Metal Oxide
R1204	VRS-CY1JF750JY	AA		R	Resistor, 75 1/16W Metal Oxide
R1206	VRS-TW2ED750JY	AA		R	Resistor, 75 1/4W Metal Oxide
R1209	VRS-TW2ED750JY	AA		R	Resistor, 75 1/4W Metal Oxide
R1210	VRS-CY1JF102JY	AA		R	Resistor, 1k 1/16W Metal Oxide
R1211	VRS-CY1JF102JY	AA		R	Resistor, 1k 1/16W Metal Oxide
R1212	VRS-CY1JF104JY	AA		R	Resistor, 100k 1/16W Metal Oxide
R1213	VRS-CY1JF102JY	AA		R	Resistor, 1k 1/16W Metal Oxide
R1214	VRS-CY1JF102JY	AA		R	Resistor, 1k 1/16W Metal Oxide
R1215	VRS-CY1JF104JY	AA		R	Resistor, 100k 1/16W Metal Oxide
R1216	VRS-CY1JF271JY	AA		R	Resistor, 270 1/16W Metal Oxide
R1217	VRS-CY1JF331JY	AA		R	Resistor, 330 1/16W Metal Oxide
R1218	VRS-CY1JF272JY	AA		R	Resistor, 2.7k 1/16W Metal Oxide
R1219	VRS-CY1JF271JY	AA		R	Resistor, 270 1/16W Metal Oxide
R1221	VRS-CY1JF331JY	AA		R	Resistor, 330 1/16W Metal Oxide
R1222	VRS-CY1JF272JY	AA		R	Resistor, 2.7k 1/16W Metal Oxide
R1224	VRS-CY1JF564JY	AA		R	Resistor, 560k 1/16W Metal Oxide
R1225	VRS-CY1JF564JY	AA		R	Resistor, 560k 1/16W Metal Oxide
R1226	VRS-CY1JF102JY	AA		R	Resistor, 1k 1/16W Metal Oxide
R1227	VRS-CY1JF102JY	AA		R	Resistor, 1k 1/16W Metal Oxide
R1228	VRS-CY1JF000JY	AA		R	Resistor, 0 1/16W Metal Oxide
SC301	QSOCZ0738CEZZ	AE		R	Socket, 7Pin
[4] DUNTKD628FM12 (Digital Unit)					
C4001	VCEASX1HN105MY	AB		R	Capacitor, 1 50V Electrolytic
C4002	VCKYCY1HB103KY	AA		R	Capacitor, 0.01 50V Ceramic
C4003	VCKYCY1EF104ZY	AA		R	Capacitor, 0.1 25V Ceramic
C4004	VCKYCY1EF104ZY	AA		R	Capacitor, 0.1 25V Ceramic
C4005	VCKYCY1HB103KY	AA		R	Capacitor, 0.01 50V Ceramic
C4006	VCCCCY1HH180JY	AA		R	Capacitor, 18p 50V Ceramic
C4007	VCCCCY1HH150JY	AA		R	Capacitor, 15p 50V Ceramic
C4008	VCEASX1CN106MY	AC		R	Capacitor, 10 16V Electrolytic
C4009	VCKYCY1HB103KY	AA		R	Capacitor, 0.01 50V Ceramic
C4010	VCKYCY1EF104ZY	AA		R	Capacitor, 0.1 25V Ceramic
C4011	VCKYCY1EF104ZY	AA		R	Capacitor, 0.1 25V Ceramic
C4012	VCKYCY1EF104ZY	AA		R	Capacitor, 0.1 25V Ceramic
C4013	VCKYCY1HB103KY	AA		R	Capacitor, 0.01 50V Ceramic
C4014	VCKYCY1EF104ZY	AA		R	Capacitor, 0.1 25V Ceramic
C4015	VCKYCY1EF104ZY	AA		R	Capacitor, 0.1 25V Ceramic
C4016	VCKYCY1HB103KY	AA		R	Capacitor, 0.01 50V Ceramic
C4017	VCKYCY1EF104ZY	AA		R	Capacitor, 0.1 25V Ceramic
C4018	VCKYCY1EF104ZY	AA		R	Capacitor, 0.1 25V Ceramic
C4019	VCEASX1CN106MY	AC		R	Capacitor, 10 16V Electrolytic
C4020	VCKYCY1EF104ZY	AA		R	Capacitor, 0.1 25V Ceramic
C4021	VCKYCY1EF104ZY	AA		R	Capacitor, 0.1 25V Ceramic
C4022	VCKYCY1EF104ZY	AA		R	Capacitor, 0.1 25V Ceramic
C4023	VCKYCY1EF104ZY	AA		R	Capacitor, 0.1 25V Ceramic
C4024	VCKYCY1EF104ZY	AA		R	Capacitor, 0.1 25V Ceramic
C4025	VCKYCY1EF104ZY	AA		R	Capacitor, 0.1 25V Ceramic
C4026	VCKYCY1EF104ZY	AA		R	Capacitor, 0.1 25V Ceramic
C4027	VCKYCY1EF104ZY	AA		R	Capacitor, 0.1 25V Ceramic
C4028	VCKYCY1EF104ZY	AA		R	Capacitor, 0.1 25V Ceramic
C4029	VCKYCY1HB103KY	AA		R	Capacitor, 0.01 50V Ceramic
C4030	VCEASX0JN476MY	AC		R	Capacitor, 47 6.3V Electrolytic
C4031	VCKYCY1EF104ZY	AA		R	Capacitor, 0.1 25V Ceramic
C4032	VCEASX1CN106MY	AC		R	Capacitor, 10 16V Electrolytic
C4033	VCKYCY1EF104ZY	AA		R	Capacitor, 0.1 25V Ceramic
C4201	VCEASX1CN106MY	AC		R	Capacitor, 10 16V Electrolytic
C4202	VCKYCY1EF104ZY	AA		R	Capacitor, 0.1 25V Ceramic

NO.	PARTS CODE	PRICE RANK	NEW MARK	PART DELIVERY	DESCRIPTION
[4] DUNTKD628FM12 (Digital Unit)					
C4203	VCEASX1CN106MY	AC		R	Capacitor, 10 16V Electrolytic
C4204	VCKYCY1HB103KY	AA		R	Capacitor, 0.01 50V Ceramic
C4205	VCKYCY1EF104ZY	AA		R	Capacitor, 0.1 25V Ceramic
C4206	VCKYCY1HB103KY	AA		R	Capacitor, 0.01 50V Ceramic
C4207	VCKYCY1EF104ZY	AA		R	Capacitor, 0.1 25V Ceramic
C4209	VCKYCY1EF104ZY	AA		R	Capacitor, 0.1 25V Ceramic
C4401	VCEASX1CN106MY	AC		R	Capacitor, 10 16V Electrolytic
C4402	VCKYCY1EF104ZY	AA		R	Capacitor, 0.1 25V Ceramic
C4403	VCKYCY1EF104ZY	AA		R	Capacitor, 0.1 25V Ceramic
C4404	VCKYCY1EF104ZY	AA		R	Capacitor, 0.1 25V Ceramic
C4405	VCKYCY1EF104ZY	AA		R	Capacitor, 0.1 25V Ceramic
C4406	VCKYCY1EF104ZY	AA		R	Capacitor, 0.1 25V Ceramic
C4407	VCKYCY1EF104ZY	AA		R	Capacitor, 0.1 25V Ceramic
C4408	VCKYCY1EF104ZY	AA		R	Capacitor, 0.1 25V Ceramic
C4409	VCKYCY1EF104ZY	AA		R	Capacitor, 0.1 25V Ceramic
C4410	VCKYCY1EF104ZY	AA		R	Capacitor, 0.1 25V Ceramic
C4411	VCKYCY1EF104ZY	AA		R	Capacitor, 0.1 25V Ceramic
C4412	VCEASX1CN106MY	AC		R	Capacitor, 10 16V Electrolytic
C4420	VGAAPD1AJ686MY	AE		R	Capacitor, 68 10V Electrolytic
C4606	VCEASX1CN106MY	AC		R	Capacitor, 10 16V Electrolytic
C4607	VCCCCY1HH470JY	AA		R	Capacitor, 47p 50V Ceramic
C4608	VCCCCY1HH100DY	AA		R	Capacitor, 10p 50V Ceramic
C4610	VCCCCY1HH470JY	AA		R	Capacitor, 47p 50V Ceramic
C4611	VCCCCY1HH330JY	AA		R	Capacitor, 33p 50V Ceramic
C4612	VCCCCY1HH330JY	AA		R	Capacitor, 33p 50V Ceramic
C4613	VCCCCY1HH330JY	AA		R	Capacitor, 33p 50V Ceramic
C4614	VCCCCY1HH6R0DY	AA		R	Capacitor, 6p 50V Electrolytic
C4615	VCCCCY1HH6R0DY	AA		R	Capacitor, 6p 50V Electrolytic
C4616	VCCCCY1HH6R0DY	AA		R	Capacitor, 6p 50V Electrolytic
C4617	VCCCCY1HH820JY	AA		R	Capacitor, 82p 50V Electrolytic
C4618	VCCCCY1HH820JY	AA		R	Capacitor, 82p 50V Electrolytic
C4619	VCCCCY1HH820JY	AA		R	Capacitor, 82p 50V Electrolytic
C4621	VCKYCY1EF104ZY	AA		R	Capacitor, 0.1 25V Ceramic
C4622	RC-KZA073WJZZY	AD		R	Capacitor, 10 16V Ceramic
C4623	VCEASX1CN106MY	AC		R	Capacitor, 10 16V Electrolytic
C4624	VCKYCY1EF104ZY	AA		R	Capacitor, 0.1 25V Ceramic
C4625	VCEASX1CN106MY	AC		R	Capacitor, 10 16V Electrolytic
C4626	VCKYCY1EF104ZY	AA		R	Capacitor, 0.1 25V Ceramic
C4627	VCKYCY1HB332KY	AA		R	Capacitor, 3300p 50V Ceramic
C4628	VCKYCY1HB332KY	AA		R	Capacitor, 3300p 50V Ceramic
C4629	VCKYCY1EF104ZY	AA		R	Capacitor, 0.1 25V Ceramic
C4632	VCKYCY1HB332KY	AA		R	Capacitor, 3300p 50V Ceramic
C4633	VCKYCY1HB332KY	AA		R	Capacitor, 3300p 50V Ceramic
C4634	VCEASX1CN106MY	AC		R	Capacitor, 10 16V Electrolytic
C4635	VCEASX1CN106MY	AC		R	Capacitor, 10 16V Electrolytic
C4636	VCKYCY1HB104KY	AA		R	Capacitor, 0.1 50V Ceramic
C4637	VCKYCY1HB104KY	AA		R	Capacitor, 0.1 50V Ceramic
C4638	VCKYCY1HB104KY	AA		R	Capacitor, 0.1 50V Ceramic
C4639	VCEASX1CN106MY	AC		R	Capacitor, 10 16V Electrolytic
C4640	VCEASX1CN106MY	AC		R	Capacitor, 10 16V Electrolytic
C4641	VCEASX1CN106MY	AC		R	Capacitor, 10 16V Electrolytic
C4701	RC-KZA070WJZZY	AD		R	Capacitor, 22 6.3V Ceramic
C4702	VCKYTV1CB105KY	AC		R	Capacitor, 1 16V Ceramic
C4703	VCKYCY1EF104ZY	AA		R	Capacitor, 0.1 25V Ceramic
C4705	VCKYCY1HB152KY	AA		R	Capacitor, 1500p 50V Ceramic
C4706	VCKYCY1EF104ZY	AA		R	Capacitor, 0.1 25V Ceramic
C4707	VGAAPD1AJ686MY	AE		R	Capacitor, 68 10V Electrolytic
C4708	VCKYCY1EF104ZY	AA		R	Capacitor, 0.1 25V Ceramic
C4709	RC-KZA073WJZZY	AD		R	Capacitor, 10 16V Ceramic
C4710	VCEASY1CN476MY	AC		R	Capacitor, 47 16V Electrolytic
C4711	RC-KZA073WJZZY	AD		R	Capacitor, 10 16V Ceramic
C4713	VCKYCY1EF104ZY	AA		R	Capacitor, 0.1 25V Ceramic
C4714	VCKYCY1EF104ZY	AA		R	Capacitor, 0.1 25V Ceramic
C4715	VCEASX0JN476MY	AC		R	Capacitor, 47 6.3V Electrolytic
C4716	VCKYCY1AB105KY	AB		R	Capacitor, 1 10V Ceramic
C4717	VCEASX0JN226MY	AB		R	Capacitor, 22 6.3V Electrolytic
D4701	RH-EX1234CEZZY	AE		R	Zener Diode, HZU3.6B2TRF
D4702	VHDSFPA73//2EY	AD		R	Diode, SFPA-73VL
D4703	VHD1SS352//1Y	AB		R	Diode, 1SS352(TPH3,F)
FB4001	RBLN-A215WJZZY	AB		R	Balun, BLN-A215WJ
FB4002	RBLN-A215WJZZY	AB		R	Balun, BLN-A215WJ
FB4003	RBLN-A215WJZZY	AB		R	Balun, BLN-A215WJ
FB4004	RBLN-A215WJZZY	AB		R	Balun, BLN-A215WJ
FB4005	RBLN-A215WJZZY	AB		R	Balun, BLN-A215WJ
FB4006	RBLN-A215WJZZY	AB		R	Balun, BLN-A215WJ
FB4007	RBLN-A215WJZZY	AB		R	Balun, BLN-A215WJ
FB4008	RBLN-A303WJZZY	AB		R	Balun, BLN-A303WJ
FB4009	RBLN-A303WJZZY	AB		R	Balun, BLN-A303WJ
FB4201	RBLN-A215WJZZY	AB		R	Balun, BLN-A215WJ
FB4202	RBLN-A215WJZZY	AB		R	Balun, BLN-A215WJ
FB4401	RBLN-A215WJZZY	AB		R	Balun, BLN-A215WJ
FB4402	RBLN-A215WJZZY	AB		R	Balun, BLN-A215WJ
FB4601	RBLN-A215WJZZY	AB		R	Balun, BLN-A215WJ
FB4602	RBLN-A215WJZZY	AB		R	Balun, BLN-A215WJ
FB4603	RBLN-A215WJZZY	AB		R	Balun, BLN-A215WJ

NO.	PARTS CODE	PRICE RANK	NEW MARK	PART DELIVERY	DESCRIPTION
[4] DUNTKD628FM12 (Digital Unit)					
FB4701	RBLN-0250TAZZY	AC		R	Balun, BLN-0250TA
IC4001	RH-iXB680WJZZQ	BH		R	IC, IXB680WJ
IC4002	VHiTC7SH08U-1Y	AF		R	IC, TC7SH08FU(TE85L,JF)
IC4003	VHiBU4228G+-1Y	AD		R	IC, BU4228G
IC4005	VHiTC7SHU04-1Y		N	R	IC, TC7SHU04FU(T5L,JF)
IC4201	RH-iXB742WJZZQ	AX		R	IC, IXB742WJ
IC4202	RH-iXB742WJZZQ	AX		R	IC, IXB742WJ
IC4203	RH-iXB921WJZZQ	AV		R	IC
IC4204	VHiBR24L64F-1Y	AK		R	IC, BR24L64F-WE2
IC4401	VHiTCLCX245-2Y	AE		R	IC, TCLCX245
IC4402	VHiLCX573FT-1Y	AF		R	IC, TC74LCX573FT(EKJ)
IC4403	VHiTC7SH08U-1Y	AF		R	IC, TC7SH08FU(TE85L,JF)
IC4404	VHiLCX244FT-1Y	AE		R	IC, TC74LCX244FT(EL,K)
IC4405	VHiLCX573FT-1Y	AF		R	IC, TC74LCX573FT(EKJ)
IC4406	VHiTC7SH32U1EY			R	IC, TC7SH32FU(TE85L,JF)
IC4407	VHiTC7SH32U1EY			R	IC, TC7SH32FU(TE85L,JF)
IC4408	VHiTC7SH02U1EY		N	R	IC, TC7SH02FU(T5L,JF,T
IC4604	VHiTSH73CPT-1Y	AL		R	IC, TSH73CPT
IC4701	VHiMP1583+-1Y	AH		R	IC, MP1583
IC4704	VHiPQ018ENA-1Y	AF		R	IC, PQ018ENA
L4601	VPD9M100J1R7NY	AC		R	Coil, Peaking 1.7µH
L4603	VPD9M5R6J1R6NY	AB		R	Coil, Peaking 1.6µH
L4604	VPD9M5R6J1R6NY	AB		R	Coil, Peaking 1.6µH
L4605	VPD9M5R6J1R6NY	AB		R	Coil, Peaking 1.6µH
L4701	RCiLPA214WJZZY	AG		R	Coil, Peaking 1.6µH
LUG4601	QLUGHA009WJZZY	AC		R	Lug
LUG4602	QLUGHA006WJZZY	AC		R	Lug
LUG4603	QLUGHA006WJZZY	AC		R	Lug
LUG4604	QLUGHA009WJZZY	AC		R	Lug
P4001	QPLGN0463TAZZY	AC		R	Plug, 4Pin(RS)
P4003	QPLGN0463TAZZY	AC		R	Plug, 4Pin(RS1)
Q4001	VS2SC3928AR-1Y	AB		R	Transistor, 2SC3928A-T112-1R
Q4002	VS2SC3928AR-1Y	AB		R	Transistor, 2SC3928A-T112-1R
Q4201	VS2SA1530AR-1Y	AB		R	Transistor, 2SA1530A-T112-1R
Q4401	RH-TXA026WJZZY	AD		R	Transistor, PBL52001D,115
Q4601	VS2SC3928AR-1Y	AB		R	Transistor, 2SC3928A-T112-1R
Q4602	VS2SC3928AR-1Y	AB		R	Transistor, 2SC3928A-T112-1R
Q4603	VS2SC3928AR-1Y	AB		R	Transistor, 2SC3928A-T112-1R
Q4604	VS2SC3928AR-1Y	AB		R	Transistor, 2SC3928A-T112-1R
Q4605	VS2SC3928AR-1Y	AB		R	Transistor, 2SC3928A-T112-1R
Q4606	VS2SC3928AR-1Y	AB		R	Transistor, 2SC3928A-T112-1R
Q4607	VS2SC3928AR-1Y	AB		R	Transistor, 2SC3928A-T112-1R
Q4701	VSDTC144EE/-1Y	AA		R	Transistor, DTC144EETL
Q4702	VSDTC144EE/-1Y	AA		R	Transistor, DTC144EETL
Q4703	VS2SC3928AR-1Y	AB		R	Transistor, 2SC3928A-T112-1R
Q4704	VSCPH6318+-1Y	AE		R	Transistor, CPH6318-TL-E
R4001	VRS-CY1JF000JY	AA		R	Resistor, 0 1/16W Metal Oxide
R4002	VRS-CY1JF201FY	AA		R	Resistor, 200 1/16W Metal Oxide
R4003	VRS-CY1JF103JY	AA		R	Resistor, 10k 1/16W Metal Oxide
R4004	VRS-CY1JF000JY	AA		R	Resistor, 0 1/16W Metal Oxide
R4005	VRS-CY1JF103JY	AA		R	Resistor, 10k 1/16W Metal Oxide
R4006	VRS-CY1JF103JY	AA		R	Resistor, 10k 1/16W Metal Oxide
R4007	VRS-CY1JF103JY	AA		R	Resistor, 10k 1/16W Metal Oxide
R4008	VRS-CY1JF103JY	AA		R	Resistor, 10k 1/16W Metal Oxide
R4009	VRS-CY1JF104JY	AA		R	Resistor, 100k 1/16W Metal Oxide
R4010	VRS-CY1JF000JY	AA		R	Resistor, 0 1/16W Metal Oxide
R4011	VRS-CY1JF103JY	AA		R	Resistor, 10k 1/16W Metal Oxide
R4012	VRS-CY1JF103JY	AA		R	Resistor, 10k 1/16W Metal Oxide
R4013	VRS-CY1JF103JY	AA		R	Resistor, 10k 1/16W Metal Oxide
R4015	VRS-CY1JF103JY	AA		R	Resistor, 10k 1/16W Metal Oxide
R4016	VRS-CY1JF101JY	AA		R	Resistor, 100 1/16W Metal Oxide
R4017	VRS-CY1JF103JY	AA		R	Resistor, 10k 1/16W Metal Oxide
R4018	VRS-CY1JF000JY	AA		R	Resistor, 0 1/16W Metal Oxide
R4019	VRS-CY1JF000JY	AA		R	Resistor, 0 1/16W Metal Oxide
R4020	VRS-CY1JF472JY	AA		R	Resistor, 4.7k 1/16W Metal Oxide
R4021	VRS-CY1JF222JY	AA		R	Resistor, 2.2k 1/16W Metal Oxide
R4024	VRS-CY1JF000JY	AA		R	Resistor, 0 1/16W Metal Oxide
R4025	VRS-CY1JF000JY	AA		R	Resistor, 0 1/16W Metal Oxide
R4026	VRS-CY1JF103JY	AA		R	Resistor, 10k 1/16W Metal Oxide
R4027	VRS-CH1JF000JY	AA		R	Resistor, 0 1/16W Metal Oxide
R4028	VRS-CY1JF103JY	AA		R	Resistor, 10k 1/16W Metal Oxide
R4029	VRS-CY1JF330JY	AA		R	Resistor, 33 1/16W Metal Oxide
R4030	VRS-CH1JF470JY	AA		R	Resistor, 47 1/16W Metal Oxide
R4031	VRS-CH1JF470JY	AA		R	Resistor, 47 1/16W Metal Oxide
R4032	VRS-CY1JF103JY	AA		R	Resistor, 10k 1/16W Metal Oxide
R4035	VRS-CY1JF103JY	AA		R	Resistor, 10k 1/16W Metal Oxide
R4036	VRS-CH1JF103JY	AA		R	Resistor, 10k 1/16W Metal Oxide
R4037	VRS-CY1JF103JY	AA		R	Resistor, 10k 1/16W Metal Oxide
R4038	VRS-CY1JF101JY	AA		R	Resistor, 100 1/16W Metal Oxide
R4039	VRS-CY1JF101JY	AA		R	Resistor, 100 1/16W Metal Oxide
R4190	VRS-CY1JF101JY	AA		R	Resistor, 100 1/16W Metal Oxide
R4191	VRS-CY1JF101JY	AA		R	Resistor, 100 1/16W Metal Oxide
R4192	VRS-CY1JF101JY	AA		R	Resistor, 100 1/16W Metal Oxide
R4193	VRS-CY1JF101JY	AA		R	Resistor, 100 1/16W Metal Oxide
R4194	VRS-CY1JF101JY	AA		R	Resistor, 100 1/16W Metal Oxide

NO.	PARTS CODE	PRICE RANK	NEW MARK	PART DELIVERY	DESCRIPTION
[4] DUNTKD628FM12 (Digital Unit)					
R4434	VRS-CY1JF470JY	AA		R	Resistor, 47 1/16W Metal Oxide
R4441	VRS-CY1JF103JY	AA		R	Resistor, 10k 1/16W Metal Oxide
R4447	VRS-CY1JF102JY	AA		R	Resistor, 1k 1/16W Metal Oxide
R4601	VRS-CY1JF470JY	AA		R	Resistor, 47 1/16W Metal Oxide
R4602	VRS-CY1JF470JY	AA		R	Resistor, 47 1/16W Metal Oxide
R4603	VRS-CY1JF470JY	AA		R	Resistor, 47 1/16W Metal Oxide
R4604	VRS-CY1JF470JY	AA		R	Resistor, 47 1/16W Metal Oxide
R4605	VRS-CY1JF470JY	AA		R	Resistor, 47 1/16W Metal Oxide
R4606	VRS-CY1JF470JY	AA		R	Resistor, 47 1/16W Metal Oxide
R4607	VRS-CY1JF470JY	AA		R	Resistor, 47 1/16W Metal Oxide
R4608	VRS-CY1JF470JY	AA		R	Resistor, 47 1/16W Metal Oxide
R4609	VRS-CY1JF470JY	AA		R	Resistor, 47 1/16W Metal Oxide
R4616	VRS-CY1JF470FY	AA		R	Resistor, 47 1/16W Metal Oxide
R4617	VRS-CY1JF331FY	AA		R	Resistor, 330 1/16W Metal Oxide
R4618	VRS-CY1JF331FY	AA		R	Resistor, 330 1/16W Metal Oxide
R4619	VRS-CY1JF271FY	AA		R	Resistor, 270 1/16W Metal Oxide
R4620	VRS-CY1JF271FY	AA		R	Resistor, 270 1/16W Metal Oxide
R4621	VRS-CY1JF271FY	AA		R	Resistor, 270 1/16W Metal Oxide
R4622	VRS-CY1JF271FY	AA		R	Resistor, 270 1/16W Metal Oxide
R4623	VRS-CY1JF271FY	AA		R	Resistor, 270 1/16W Metal Oxide
R4624	VRS-CY1JF271FY	AA		R	Resistor, 270 1/16W Metal Oxide
R4626	VRS-CY1JF000JY	AA		R	Resistor, 0 1/16W Metal Oxide
R4627	VRS-CY1JF272FY	AA		R	Resistor, 2.7k 1/16W Metal Oxide
R4628	VRS-CY1JF242FY	AA		R	Resistor, 2.4k 1/16W Metal Oxide
R4629	VRS-CY1JF470JY	AA		R	Resistor, 47 1/16W Metal Oxide
R4630	VRS-CY1JF470JY	AA		R	Resistor, 47 1/16W Metal Oxide
R4631	VRS-CY1JF471JY	AA		R	Resistor, 470 1/16W Metal Oxide
R4632	VRS-CY1JF471JY	AA		R	Resistor, 470 1/16W Metal Oxide
R4633	VRS-CY1JF472JY	AA		R	Resistor, 4.7k 1/16W Metal Oxide
R4634	VRS-CY1JF240JY	AA		R	Resistor, 24 1/16W Metal Oxide
R4635	VRS-CY1JF240JY	AA		R	Resistor, 24 1/16W Metal Oxide
R4636	VRS-CY1JF240JY	AA		R	Resistor, 24 1/16W Metal Oxide
R4637	VRS-CY1JF240JY	AA		R	Resistor, 24 1/16W Metal Oxide
R4638	VRS-CY1JF472JY	AA		R	Resistor, 4.7k 1/16W Metal Oxide
R4639	VRS-CY1JF471JY	AA		R	Resistor, 470 1/16W Metal Oxide
R4640	VRS-CY1JF471JY	AA		R	Resistor, 470 1/16W Metal Oxide
R4643	VRS-CY1JF470JY	AA		R	Resistor, 47 1/16W Metal Oxide
R4644	VRS-CY1JF470JY	AA		R	Resistor, 47 1/16W Metal Oxide
R4645	VRS-CY1JF470JY	AA		R	Resistor, 47 1/16W Metal Oxide
R4646	VRS-CY1JF470JY	AA		R	Resistor, 47 1/16W Metal Oxide
R4647	VRS-CY1JF470JY	AA		R	Resistor, 47 1/16W Metal Oxide
R4648	VRS-CY1JF470JY	AA		R	Resistor, 47 1/16W Metal Oxide
R4649	VRS-CY1JF470JY	AA		R	Resistor, 47 1/16W Metal Oxide
R4650	VRS-CY1JF470JY	AA		R	Resistor, 47 1/16W Metal Oxide
R4651	VRS-CY1JF183JY	AA		R	Resistor, 18k 1/16W Metal Oxide
R4652	VRS-CY1JF183JY	AA		R	Resistor, 18k 1/16W Metal Oxide
R4657	VRS-CY1JF101JY	AA		R	Resistor, 100 1/16W Metal Oxide
R4658	VRS-CY1JF101JY	AA		R	Resistor, 100 1/16W Metal Oxide
R4659	VRS-CY1JF331FY	AA		R	Resistor, 330 1/16W Metal Oxide
R4660	VRS-CY1JF473JY	AA		R	Resistor, 47k 1/16W Metal Oxide
R4661	VRS-CY1JF473JY	AA		R	Resistor, 47k 1/16W Metal Oxide
R4662	VRS-CY1JF271FY	AA		R	Resistor, 270 1/16W Metal Oxide
R4663	VRS-CY1JF271FY	AA		R	Resistor, 270 1/16W Metal Oxide
R4664	VRS-CY1JF271FY	AA		R	Resistor, 270 1/16W Metal Oxide
R4665	VRS-CY1JF161FY	AA		R	Resistor, 160 1/16W Metal Oxide
R4666	VRS-CY1JF103JY	AA		R	Resistor, 10k 1/16W Metal Oxide
R4667	VRS-CY1JF161FY	AA		R	Resistor, 160 1/16W Metal Oxide
R4668	VRS-CY1JF103JY	AA		R	Resistor, 10k 1/16W Metal Oxide
R4669	VRS-CY1JF161FY	AA		R	Resistor, 160 1/16W Metal Oxide
R4670	VRS-CY1JF103JY	AA		R	Resistor, 10k 1/16W Metal Oxide
R4672	VRS-CY1JF103JY	AA		R	Resistor, 10k 1/16W Metal Oxide
R4673	VRS-CY1JF103JY	AA		R	Resistor, 10k 1/16W Metal Oxide
R4674	VRS-CY1JF000JY	AA		R	Resistor, 0 1/16W Metal Oxide
R4675	VRS-CY1JF470JY	AA		R	Resistor, 47 1/16W Metal Oxide
R4701	VRS-CY1JF474FY	AA		R	Resistor, 470k 1/16W Metal Oxide
R4702	VRS-CY1JF273FY	AA		R	Resistor, 27k 1/16W Metal Oxide
R4703	VRS-CY1JF153FY	AA		R	Resistor, 15k 1/16W Metal Oxide
R4704	VRS-CY1JF562JY	AA		R	Resistor, 5.6k 1/16W Metal Oxide
R4705	VRS-CY1JF103JY	AA		R	Resistor, 10k 1/16W Metal Oxide
R4706	VRS-CY1JF103JY	AA		R	Resistor, 10k 1/16W Metal Oxide
R4707	VRS-CY1JF103JY	AA		R	Resistor, 10k 1/16W Metal Oxide
R4708	VRS-CY1JF332JY	AA		R	Resistor, 3.3k 1/16W Metal Oxide
R4709	VRS-TX2HF000JY	AB		R	Resistor, 0 1/2W Metal Oxide
R4710	VRS-CY1JF101JY	AA		R	Resistor, 100 1/16W Metal Oxide
R4711	VRS-TX2HF000JY	AB		R	Resistor, 0 1/2W Metal Oxide
R4712	VRS-CY1JF103JY	AA		R	Resistor, 10k 1/16W Metal Oxide
R4713	VRS-TX2HF1R0JY	AB		R	Resistor, 1 1/2W Metal Oxide
R4715	VRS-TX2HF000JY	AB		R	Resistor, 0 1/2W Metal Oxide
R4716	VRS-TX2HF000JY	AB		R	Resistor, 0 1/2W Metal Oxide
R4717	VRS-CY1JF101JY	AA		R	Resistor, 100 1/16W Metal Oxide
SC4601	QCNCWA202WJZZY	AK		R	Connector, 60Pin
SC4602	QSOCNA003WJZZY	AM		R	Socket, 100Pin
X4001	RCRSC0032TAZZY	AG		R	Crystal, 32.768kHz
X4002	RCRUAA075WJZZY	AQ		R	Crystal, 27MHz
N	PSLDMA688WJZZ	AE		R	Shield

NO.	PARTS CODE	PRICE RANK	NEW MARK	PART DELIVERY	DESCRIPTION
[4] DUNTKD628FM12 (Digital Unit)					
N	PSLDMA838WJZZ	AD		R	Shield
N	PSLDMA943WJFW	AK		R	Digital Shield
N	PSLDMB056WJFW			R	Digital Shield
N	QCNCMA199WJSA	AV		R	Cadr Slot
N	XBPSN20P14JS0	AB		R	Screw, x4
N	XJPS730P08WS0	AA		R	Screw, x4
N	XNESN20-16000			R	Nut, x4
[5] DUNTKD787FM02 (Power Unit)					
	C701 RC-FZA126WJZZ	AE		R	Capacitor, 0.1 450V Metallized Polyester Film
	C702 VCKYCY1HB333KY	AA		R	Capacitor, 0.033 50V Ceramic
	C703 VCKYTV1EB474KY	AC		R	Capacitor, 0.47 25V Ceramic
△	C704 RC-FZA026WJZZ	AE		R	Capacitor, 0.47 275V Metallized Polyester Film
	C705 VCKYCY1EB333KY	AA		R	Capacitor, 0.033 25V Ceramic
	C706 RC-FZA124WJZZ	AG		R	Capacitor, 2.2 450V Metallized Polyester Film
	C707 VCKYCY1HB222KY	AA		R	Capacitor, 2200p 50V Ceramic
△	C708 RC-KZ0105GEZZ	AD		R	Capacitor, 2200p 250V Ceramic
△	C709 RC-KZ0105GEZZ	AD		R	Capacitor, 2200p 250V Ceramic
	C710 VCKYTV1HB102KY	AA		R	Capacitor, 1000p 50V Ceramic
	C711 VCKYCY1HB102KY	AA		R	Capacitor, 1000p 50V Ceramic
△	C712 RC-FZA026WJZZ	AE		R	Capacitor, 0.47 275V Metallized Polyester Film
	C713 RC-KZA388WJZZY	AC		R	Capacitor, 10 6.3V Ceramic
	C714 RC-KZA304WJZZ	AD		R	Capacitor, 470p 2kV Ceramic
	C715 RC-EZA813WJZZ			R	Capacitor, 150 450V Electrolytic
	C716 VCKYCY1HB104KY	AA		R	Capacitor, 0.1 50V Ceramic
	C717 VCKYCY1HB104KY	AA		R	Capacitor, 0.1 50V Ceramic
	C719 RC-KZA304WJZZ	AD		R	Capacitor, 470p 2kV Ceramic
	C720 VCKYCY1HB104KY	AA		R	Capacitor, 0.1 50V Ceramic
	C721 VCKYCY1HB103KY	AA		R	Capacitor, 0.01 50V Ceramic
	C722 VCCCCY1HH101JY	AA		R	Capacitor, 100p 50V Ceramic
	C723 RC-EZA489WJZZ+	AC		R	Capacitor, 47 35V Electrolytic
	C724 VCFPVC3ZA822H	AE		R	Capacitor, 8200p 1800V Metallized Polyester Fil
	C726 VCCCCY1HH101JY	AA		R	Capacitor, 100p 50V Ceramic
	C728 VCKYCY1HB332KY	AA		R	Capacitor, 3300p 50V Ceramic
	C729 RC-EZA489WJZZ+	AC		R	Capacitor, 47 35V Electrolytic
	C730 VCKYCY1HB104KY	AA		R	Capacitor, 0.1 50V Ceramic
	C731 RC-EZA489WJZZ+	AC		R	Capacitor, 47 35V Electrolytic
	C732 VCKYCY1HB104KY	AA		R	Capacitor, 0.1 50V Ceramic
	C733 VCKYCY1HB222KY	AA		R	Capacitor, 2200p 50V Ceramic
	C734 RC-KZA304WJZZ	AD		R	Capacitor, 470p 2kV Ceramic
	C735 RC-EZA489WJZZ+	AC		R	Capacitor, 47 35V Electrolytic
	C736 RC-EZA489WJZZ+	AC		R	Capacitor, 47 35V Electrolytic
	C737 VCKYCY1CB104KY	AB		R	Capacitor, 0.1 16V Ceramic
	C738 VCESYA1HM476M			R	Capacitor, 47 50V Capacitor(AL)
	C739 VCCCCY1HH102JY	AB		R	Capacitor, 1000p 50V Ceramic
△	C741 RC-KZ0105GEZZ	AD		R	Capacitor, 2200p 250V Ceramic
	C743 RC-EZA513WJZZ	AH		R	Capacitor, 470 50V Electrolytic
	C744 RC-EZA499WJZZ	AH		R	Capacitor, 1200 35V Electrolytic
	C745 VCKYCY1HB472KY	AA		R	Capacitor, 4700p 50V Ceramic
	C749 VCKYTV1HB683KY	AB		R	Capacitor, 0.068 50V Ceramic
	C750 VCKYCY1HB104KY	AA		R	Capacitor, 0.1 50V Ceramic
	C751 RC-EZA499WJZZ	AH		R	Capacitor, 1200 35V Electrolytic
	C752 RC-EZA452WJZZ	AG		R	Capacitor, 2200 10V Electrolytic
	C753 VCKYTV1HB683KY	AB		R	Capacitor, 0.068 50V Ceramic
	C754 RC-EZA510WJZZ	AF		R	Capacitor, 220 50V Electrolytic
	C755 RC-EZA499WJZZ	AH		R	Capacitor, 1200 35V Electrolytic
	C756 RC-EZA452WJZZ	AG		R	Capacitor, 2200 10V Electrolytic
	C757 RC-EZA480WJZZ	AD		R	Capacitor, 680 25V Electrolytic
	C758 RC-EZA490WJZZ+	AD		R	Capacitor, 100 35V Electrolytic
	C762 RC-EZA513WJZZ	AH		R	Capacitor, 470 50V Electrolytic
	C763 VCKYCY1HB104KY	AA		R	Capacitor, 0.1 50V Ceramic
	C764 VCKYCY1HB104KY	AA		R	Capacitor, 0.1 50V Ceramic
	C765 VCKYCY1HB104KY	AA		R	Capacitor, 0.1 50V Ceramic
	C767 RC-EZA510WJZZ	AF		R	Capacitor, 220 50V Electrolytic
	C768 RC-EZA452WJZZ	AG		R	Capacitor, 2200 10V Electrolytic
	C771 VCKYCY1HB272KY	AA		R	Capacitor, 2700p 50V Ceramic
	C772 VCKYCY1HB104KY	AA		R	Capacitor, 0.1 50V Ceramic
	C774 RC-KZ0029CEZZ	AC		R	Capacitor, 0.01 250V Ceramic
	C775 VCKYCY1HB102KY	AA		R	Capacitor, 1000p 50V Ceramic
	C776 RC-KZA213WJZZY	AC		R	Capacitor, 4.7 25V Ceramic
△	C777 RC-KZ0103GEZZ	AD		R	Capacitor, 1000p 250V Ceramic
△	C778 RC-KZ0103GEZZ	AD		R	Capacitor, 1000p 250V Ceramic
△	C779 RC-KZ0103GEZZ	AD		R	Capacitor, 1000p 250V Ceramic
△	C780 RC-KZ0103GEZZ	AD		R	Capacitor, 1000p 250V Ceramic
	C783 RC-KZA213WJZZY	AC		R	Capacitor, 4.7 25V Ceramic
	C785 RC-KZ0029CEZZ	AC		R	Capacitor, 0.01 250V Ceramic
	C786 RC-KZA304WJZZ	AD		R	Capacitor, 470p 2kV Ceramic
	C789 VCKYCY1HB104KY	AA		R	Capacitor, 0.1 50V Ceramic
	C790 VCKYCY1HB104KY	AA		R	Capacitor, 0.1 50V Ceramic
	C791 RC-KZA450WJZZY	AD		R	Capacitor, 470p 1kV Ceramic
	C792 VCKYCY1AB105KY	AB		R	Capacitor, 1 10V Ceramic
	C793 VCKYCY1CB104KY	AB		R	Capacitor, 0.1 16V Ceramic
	C794 RC-KZA388WJZZY	AC		R	Capacitor, 10 6.3V Ceramic
	C795 VCKYCY1AB105KY	AB		R	Capacitor, 1 10V Ceramic

NO.	PARTS CODE	PRICE RANK	NEW MARK	PART DELIVERY	DESCRIPTION
[5] DUNTKD787FM02 (Power Unit)					
	C796	VCKYCY1AB105KY	AB		R Capacitor, 1 10V Ceramic
	C798	VCKYCY1CB104KY	AB		R Capacitor, 0.1 16V Ceramic
	C799	VCKYCY1CB104KY	AB		R Capacitor, 0.1 16V Ceramic
	C800	VCKYCY1CB104KY	AB		R Capacitor, 0.1 16V Ceramic
	C801	VCKYCY1CB104KY	AB		R Capacitor, 0.1 16V Ceramic
	C802	VCKYCY1CB104KY	AB		R Capacitor, 0.1 16V Ceramic
	C803	VCKYCY1HB223KY	AA		R Capacitor, 0.022 50V Ceramic
	C804	VCKYCY1CB104KY	AB		R Capacitor, 0.1 16V Ceramic
	C805	RC-KZA304WJZZ	AD		R Capacitor, 470p 2kV Ceramic
	C813	RC-FZ0010TAZZ	AC		R Capacitor, 0.01 630V Metallized Polyester
	C814	RC-EZA489WJZZ+	AC		R Capacitor, 47 35V Electrolytic
	C831	VCKYCY1HB104KY	AA		R Capacitor, 0.1 50V Ceramic
	C832	VCKYCY1HB104KY	AA		R Capacitor, 0.1 50V Ceramic
△	D701	RH-DX0477CEZZ	AF		R Diode, D5SB60
	D702	VHD1SS352//--1Y	AB		R Diode, 1SS352(TPH3,F)
	D703	VHD1SS352//--1Y	AB		R Diode, 1SS352(TPH3,F)
	D704	VHDLi114+++--1Y	AC		R Diode, Li114
	D705	VHDRB160M40-1Y	AC		R Diode, RB160M-40TR
	D706	RH-EXA100WJZZY			R Zener Diode, UDZS TE-17 27B
	D707	VHD1SS352//--1Y	AB		R Diode, 1SS352(TPH3,F)
	D708	VHDD1FL20U/-1Y	AC		R Diode, D1FL20U
	D709	RH-DXA073WJZZ	AM		R Diode, YG97S6R
	D710	RH-EXA094WJZZY	AB		R Zener Diode, UDZSTE-1715B
	D711	RH-EXA092WJZZY	AB		R Zener Diode, UDZSTE-1712B
	D712	VHDU05NU44+-1Y	AE		R Diode, U05NU44(TE12L,Q)
	D713	VHD1SS352//--1Y	AB		R Diode, 1SS352(TPH3,F)
	D714	RH-EXA092WJZZY	AB		R Zener Diode, UDZSTE-1712B
	D715	VHDD1FL20U/-1Y	AC		R Diode, D1FL20U
	D716	VHDU05NU44+-1Y	AE		R Diode, U05NU44(TE12L,Q)
	D717	VHDD1FL20U/-1Y	AC		R Diode, D1FL20U
	D718	RH-EXA091WJZZY	AB		R Zener Diode, UDZSTE-1711B
	D719	VHD1SS352//--1Y	AB		R Diode, 1SS352(TPH3,F)
	D720	VHDU05NU44+-1Y	AE		R Diode, U05NU44(TE12L,Q)
	D721	RH-EXA096WJZZY	AB		R Zener Diode, UDZSTE-1718B
	D722	VHD1SS352//--1Y	AB		R Diode, 1SS352(TPH3,F)
	D723	VHD1SS352//--1Y	AB		R Diode, 1SS352(TPH3,F)
	D724	VHDD1FL20U/-1Y	AC		R Diode, D1FL20U
	D725	VHDD1FL20U/-1Y	AC		R Diode, D1FL20U
	D726	VHDD1FL20U/-1Y	AC		R Diode, D1FL20U
	D728	VHD1SS355//--1Y	AB		R Diode, 1SS355TE-17
	D729	RH-DXA080WJZZ	AK		R Diode, SF20JC10-7100
△	D730	RH-FXA003WJZZ	AD		R Diode, PC123Y82
△	D731	RH-FXA003WJZZ	AD		R Diode, PC123Y82
△	D732	RH-FXA003WJZZ	AD		R Diode, PC123Y82
△	D733	RH-FXA003WJZZ	AD		R Diode, PC123Y82
△	D734	RH-FXA003WJZZ	AD		R Diode, PC123Y82
	D735	VHDSF6L20U+-1	AG		R Diode, SF6L20U
	D736	RH-DXA080WJZZ	AK		R Diode, SF20JC10-7100
	D737	RH-DXA081WJZZ	AH		R Diode, D15SCA4M-7000
	D738	RH-DXA088WJZZY	AD		R Diode, D1FL40-5063
	D739	RH-DXA085WJZZ	AK	N	R Diode, R D5S9M-7000
	D740	VHD1SS352//--1Y	AB		R Diode, 1SS352(TPH3,F)
	D741	RH-EX1398CEZZY	AB		R Zener Diode, UDZSTE-178.2B
	D742	VHD1SS352//--1Y	AB		R Diode, 1SS352(TPH3,F)
	D743	VHDU05NU44+-1Y	AE		R Diode, U05NU44(TE12L,Q)
	D744	VHDRB160M40-1Y	AC		R Diode, RB160M-40TR
	D746	RH-EXA102WJZZY	AB		R Zener Diode, UDZSTE-1733B
	D747	VHD1SS352//--1Y	AB		R Diode, 1SS352(TPH3,F)
	D748	RH-EXA094WJZZY	AB		R Zener Diode, UDZSTE-1715B
	D749	RH-EX1400CEZZY	AB		R Zener Diode, UDZSTE-1710B
	D751	RH-EX1398CEZZY	AB		R Zener Diode, UDZSTE-178.2B
	D752	VHD1SS352//--1Y	AB		R Diode, 1SS352(TPH3,F)
	D753	RH-EXA094WJZZY	AB		R Zener Diode, UDZSTE-1715B
	D754	RH-EXA101WJZZY	AB		R Zener Diode, UDZSTE-1730B
	D755	VHD1SS352//--1Y	AB		R Diode, 1SS352(TPH3,F)
	D756	RH-EXA101WJZZY	AB		R Zener Diode, UDZSTE-1730B
	D757	VHD1SS352//--1Y	AB		R Diode, 1SS352(TPH3,F)
	D758	RH-DX0466CEZZ	AE		R Diode, S3L60
	D759	RH-EXA101WJZZY	AB		R Zener Diode, UDZSTE-1730B
	D761	VHDD1FL20U/-1Y	AC		R Diode, D1FL20U
	D763	RH-EX1394CEZZY	AB		R Zener Diode, UDZSTE-175.6B
	D764	VHD1SS352//--1Y	AB		R Diode, 1SS352(TPH3,F)
	D765	VHD1SS352//--1Y	AB		R Diode, 1SS352(TPH3,F)
	D767	VHD1SS352//--1Y	AB		R Diode, 1SS352(TPH3,F)
	D768	VHDU05NU44+-1Y	AE		R Diode, U05NU44(TE12L,Q)
	D769	VHDU05NU44+-1Y	AE		R Diode, U05NU44(TE12L,Q)
	D770	RH-EX1234CEZZY	AE		R Zener Diode, HZU3.6B2TRF
	D771	VHD1SS352//--1Y	AB		R Diode, 1SS352(TPH3,F)
	D772	RH-EXA102WJZZY	AB		R Zener Diode, UDZSTE-1733B
	D773	VHD1SS352//--1Y	AB		R Diode, 1SS352(TPH3,F)
	D774	VHD1SS352//--1Y	AB		R Diode, 1SS352(TPH3,F)
	D775	VHD1SS352//--1Y	AB		R Diode, 1SS352(TPH3,F)
	D776	RH-EX1234CEZZY	AE		R Zener Diode, HZU3.6B2TRF
	D778	RH-EXA359WJZZY	AE		R Zener Diode, PTZTE2533B
	D779	VHD1SS352//--1Y	AB		R Diode, 1SS352(TPH3,F)

NO.	PARTS CODE	PRICE RANK	NEW MARK	PART DELIVERY	DESCRIPTION
[5] DUNTKD787FM02 (Power Unit)					
	D780	RH-EX1015GEZZY	AD		Zener Diode, PTZTE2516B
	D781	RH-EX1015GEZZY	AD		Zener Diode, PTZTE2516B
	D782	RH-EXA359WJZZY	AE		Zener Diode, PTZTE2533B
	D783	RH-EXA359WJZZY	AE		Zener Diode, PTZTE2533B
	D784	VHD1SS352//1Y	AB		Diode, 1SS352(TPH3,F)
	D793	RH-DXA070WJZZY	AE		Diode, SARS01V1
△	E701	LANGQA027WJFW	AE		Fixing Metal
△	F701	QFS-ZA007WJZZ	AC		Fuse, T4AL/250V
	F702	QFS-TA005WJZZ	AG	S	Fuse
	FB701	RBLN-A007WJZZY	AC		Balun, BLN-A007WJ
	FB702	RBLN-0020CEZZ+	AB		Balun, BLN-0020CE
	FB706	RBLN-0020CEZZ	AB		Balun, BLN-0020CE
	FB708	RBLN-0020CEZZ	AB		Balun, BLN-0020CE
	FB709	RBLN-0020CEZZ	AB		Balun, BLN-0020CE
	FB710	RBLN-0020CEZZ	AB		Balun, BLN-0020CE
	IC701	VHiFA5501AN-1Y	AQ		IC, FA5501AN-D1-TE1
	IC704	VHiMR4040+-1			IC, MR4040-7101
	IC705	VHiMR4020+-1	AQ		IC, MR4020-7101
	IC706	VHiHA17431G-1Y		N	IC, HA17431GUPTL-E
	IC707	VHiTA76431R-1Y	AE		IC, TA76431FR(TE12L,F)
	IC708	VHiNJM2902V-1Y	AD	S	IC, NJM2902V(TE1)
	IC709	VHiNJM2903M-1Y	AE		IC, NJM2903M-TE1
	IC710	VHiPST3646N-1Y	AE		IC, IC-PST3646NR
	IC713	VHiPQ12RDA2-1S		N	IC, PQ120RDA2SZH
△	L701	RcLFA225WJZZ			Coil
	L703	RcLPA546WJZZ	AH		Coil
△	L704	RcLCA133WJZZ			Coil
	L706	RcLFA225WJZZ			Coil
	L753	RcLPA642WJZZ	AE		Coil
	LUG701	QLUGHA002WJZZ	AB		Coil
	LUG702	QLUGHA002WJZZ	AB		Coil
	LUG703	QLUGHA002WJZZ	AB		Coil
	LUG704	QLUGHA002WJZZ	AB		Coil
	LUG705	QLUGHA002WJZZ	AB		Coil
	LUG706	QLUGHA002WJZZ	AB		Coil
	P701	QCNCMA250WJZZ	AE		Connector, 23Pin
	P702	QCNCMA247WJZZ	AD		Connector, 9Pin
	P703	QPLGZ0738CEZZ	AC		Plug, 7Pin
	P704	QPLGNA053WJZZ	AF		Plug, 14Pin (LA)
	P707	QPLGNA043WJZZ	AB		Plug, 4Pin
	Q701	VS2SK3525+-1	AM		Transistor, 2SK3525-01MR-F119
	Q702	VS2SC3928AR-1Y	AB		Transistor, 2SC3928A-T112-1R
	Q704	VS2SC3928AR-1Y	AB		Transistor, 2SC3928A-T112-1R
	Q708	VS2SC3928AR-1Y	AB		Transistor, 2SC3928A-T112-1R
	Q709	VS2SK3525+-1	AM		Transistor, 2SK3525-01MR-F119
	Q710	VS2SC3928AR-1Y	AB		Transistor, 2SC3928A-T112-1R
	Q712	VS2SC3928AR-1Y	AB		Transistor, 2SC3928A-T112-1R
	Q713	VS2SC3928AR-1Y	AB		Transistor, 2SC3928A-T112-1R
	Q721	VS2SC3928AR-1Y	AB		Transistor, 2SC3928A-T112-1R
	Q723	RH-TXA037WJZZY	AE		Transistor, PBL6003D,115
	Q724	RH-TXA037WJZZY	AE		Transistor, PBL6003D,115
	Q725	RH-TXA037WJZZY	AE		Transistor, PBL6003D,115
	Q726	VS2SC3928AR-1Y	AB		Transistor, 2SC3928A-T112-1R
	Q729	VS2SD2185R+-1Y	AF		Transistor, 2SD21850RL
	Q730	RH-TXA026WJZZY	AD		Transistor, PBL6003D,115
	Q731	RH-TXA026WJZZY	AD		Transistor, PBL6003D,115
	Q733	VS2SC3928AR-1Y	AB		Transistor, 2SC3928A-T112-1R
	Q734	VSDTC144EUA-1Y	AB		Transistor, DTC144EUAT106
△	R701	RR-HZ0008GEZZY	AE		Resistor
△	R702	RR-HZ0008GEZZY	AE		Resistor
	R703	VRS-CY1JF105JY	AA		Resistor, 1M 1/16W Metal Oxide
	R704	RR-HZ0008GEZZY	AE		Resistor
	R705	VRS-CY1JF332DY	AA		Resistor, 3.3k 1/16W Metal Oxide
	R706	VRS-TQ2EF124FY	AA		Resistor, 120k 1/4W Metal Oxide
	R707	VRS-TQ2EF124FY	AA		Resistor, 120k 1/4W Metal Oxide
	R708	VRS-TQ2EF124FY	AA		Resistor, 120k 1/4W Metal Oxide
	R709	VRS-CY1JF103JY	AA		Resistor, 10k 1/16W Metal Oxide
	R710	VRS-CY1JF681FY	AA		Resistor, 680 1/16W Metal Oxide
	R711	VRS-TV1JD390JY	AA		Resistor, 39 1/16W Metal Oxide
	R712	VRS-CY1JF183JY	AA		Resistor, 18k 1/16W Metal Oxide
	R713	VRS-TQ2EF393FY			Resistor, 39k 1/4W Metal Oxide
	R714	VRS-TQ2EF100JY	AA		Resistor, 10 1/4W Metal Oxide
	R715	VRS-TQ2EF101JY	AA		Resistor, 100 1/4W Metal Oxide
	R716	VRS-CY1JF682JY	AA		Resistor, 6.8k 1/16W Metal Oxide
	R717	VRS-TV1JD103JY	AA		Resistor, 10k 1/16W Metal Oxide
	R718	VRS-TQ2EF681JY	AA		Resistor, 680 1/4W Metal Oxide
	R719	RR-FZA006WJZZ			Resistor
	R720	VRS-TQ2EF394DY			Resistor, 390k 1/4W Metal Oxide
	R721	VRS-TQ2EF394DY			Resistor, 390k 1/4W Metal Oxide
	R722	VRS-TQ2EF394DY			Resistor, 390k 1/4W Metal Oxide
	R723	VRS-TQ2EF394DY			Resistor, 390k 1/4W Metal Oxide
	R724	VRS-TQ2EF394DY			Resistor, 390k 1/4W Metal Oxide
	R725	VRS-CY1JF822DY	AA		Resistor, 8.2k 1/16W Metal Oxide
	R726	VRS-TQ2EF681JY	AA		Resistor, 680 1/4W Metal Oxide
	R727	VRS-TV1JD563JY	AA		Resistor, 56k 1/16W Metal Oxide

NO.	PARTS CODE	PRICE RANK	NEW MARK	PART DELIVERY	DESCRIPTION
[5] DUNTKD787FM02 (Power Unit)					
R728	VRS-TQ2EF394FY			R	Resistor, 390k 1/4W Metal Oxide
R729	VRS-TQ2EF394FY			R	Resistor, 390k 1/4W Metal Oxide
R730	VRS-TQ2EF394FY			R	Resistor, 390k 1/4W Metal Oxide
R731	VRS-TQ2EF394FY			R	Resistor, 390k 1/4W Metal Oxide
R732	VRS-TQ2EF394FY			R	Resistor, 390k 1/4W Metal Oxide
R733	VRS-TV1JD103JY	AA		R	Resistor, 10k 1/16W Metal Oxide
R734	VRS-TV1JD103JY	AA		R	Resistor, 10k 1/16W Metal Oxide
R740	VRS-TV1JD564JY	AA		R	Resistor, 560k 1/16W Metal Oxide
R741	VRS-TV1JD103JY	AA		R	Resistor, 10k 1/16W Metal Oxide
R742	VRS-TV1JD103JY	AA		R	Resistor, 10k 1/16W Metal Oxide
R743	VRS-CY1JF224JY	AA		R	Resistor, 220k 1/16W Metal Oxide
R744	VRS-TQ2EF123FY			R	Resistor, 12k 1/4W Metal Oxide
R745	VRS-TV1JD103JY	AA		R	Resistor, 10k 1/16W Metal Oxide
R746	VRS-TV1JD103JY	AA		R	Resistor, 10k 1/16W Metal Oxide
R747	VRS-TV1JD153FY	AA		R	Resistor, 15k 1/16W Metal Oxide
R748	VRS-TV1JD103JY	AA		R	Resistor, 10k 1/16W Metal Oxide
R749	VRS-CY1JF104JY	AA		R	Resistor, 100k 1/16W Metal Oxide
R750	VRN-VV3DBR15J	AB		R	Resistor, 0.15 2W Metal Film
R751	VRN-VV3DBR15J	AB		R	Resistor, 0.15 2W Metal Film
R752	VRS-TV1JD000JY	AA		R	Resistor, 0 1/16W Metal Oxide
R753	VRS-TV1JD103JY	AA		R	Resistor, 10k 1/16W Metal Oxide
R754	VRS-CY1JF333JY	AA		R	Resistor, 33k 1/16W Metal Oxide
R755	VRS-TV1JD223FY			R	Resistor, 22k 1/16W Metal Oxide
R756	VRS-TV1JD273FY			R	Resistor, 27k 1/16W Metal Oxide
R757	VRS-TV1JD103JY	AA		R	Resistor, 10k 1/16W Metal Oxide
R758	VRS-TV1JD564JY	AA		R	Resistor, 560k 1/16W Metal Oxide
R759	VRS-TV1JD103JY	AA		R	Resistor, 10k 1/16W Metal Oxide
R760	VRN-VV3DBR18J	AD		R	Resistor, 0.18 2W Metal Film
R761	VRS-TV1JD103JY	AA		R	Resistor, 10k 1/16W Metal Oxide
R762	VRS-CY1JF472JY	AA		R	Resistor, 4.7k 1/16W Metal Oxide
R763	VRS-TQ2EF122JY	AA		R	Resistor, 1.2k 1/4W Metal Oxide
R764	VRS-TV1JD103JY	AA		R	Resistor, 10k 1/16W Metal Oxide
R765	VRS-TV1JD104JY	AA		R	Resistor, 100k 1/16W Metal Oxide
R766	VRS-TV1JD103JY	AA		R	Resistor, 10k 1/16W Metal Oxide
R767	VRS-TQ2EF391JY	AA		R	Resistor, 390 1/4W Metal Oxide
R768	VRS-TQ2EF122JY	AA		R	Resistor, 1.2k 1/4W Metal Oxide
R769	VRS-TQ2EF103JY			R	Resistor, 10k 1/4W Metal Oxide
R770	VRS-TQ2BD000JY	AA		R	Resistor, 0 1/8W Metal Oxide
R771	VRS-TQ2EF752FY			R	Resistor, 7.5k 1/4W Metal Oxide
R772	VRS-TQ2EF102JY	AA		R	Resistor, 1k 1/4W Metal Oxide
R773	VRS-TV1JD103JY	AA		R	Resistor, 10k 1/16W Metal Oxide
R774	VRS-TV1JD103JY	AA		R	Resistor, 10k 1/16W Metal Oxide
R775	VRS-TV1JD153FY	AA		R	Resistor, 15k 1/16W Metal Oxide
R776	VRS-TV1JD102JY	AA		R	Resistor, 1k 1/16W Metal Oxide
R777	VRS-CY1JF332DY	AA		R	Resistor, 3.3k 1/16W Metal Oxide
R778	VRS-TV1JD242FY	AA		R	Resistor, 2.4k 1/16W Metal Oxide
R779	VRS-TV1JD103JY	AA		R	Resistor, 10k 1/16W Metal Oxide
R780	VRS-TV1JD682JY	AA		R	Resistor, 6.8k 1/16W Metal Oxide
R781	VRS-TV1JD242FY	AA		R	Resistor, 2.4k 1/16W Metal Oxide
R782	VRS-TV1JD102JY	AA		R	Resistor, 1k 1/16W Metal Oxide
R783	VRS-TV1JD223JY	AA		R	Resistor, 22k 1/16W Metal Oxide
R784	VRS-TV1JD242JY	AA		R	Resistor, 2.4k 1/16W Metal Oxide
R785	VRS-TV1JD103JY	AA		R	Resistor, 10k 1/16W Metal Oxide
R786	VRS-TV1JD103JY	AA		R	Resistor, 10k 1/16W Metal Oxide
R787	VRS-TV1JD103JY	AA		R	Resistor, 10k 1/16W Metal Oxide
R788	VRS-CY1JF332DY	AA		R	Resistor, 3.3k 1/16W Metal Oxide
R789	VRS-CY1JF221JY	AA		R	Resistor, 220 1/16W Metal Oxide
R790	VRS-CY1JF103FY	AA		R	Resistor, 10k 1/16W Metal Oxide
R791	VRS-TV1JD103JY	AA		R	Resistor, 10k 1/16W Metal Oxide
R792	VRS-TV1JD272JY	AA		R	Resistor, 2.7k 1/16W Metal Oxide
R793	VRS-TV1JD103JY	AA		R	Resistor, 10k 1/16W Metal Oxide
R794	VRS-TV1JD821FY	AA		R	Resistor, 820 1/16W Metal Oxide
R795	VRS-TV1JD203FY	AA		R	Resistor, 20k 1/16W Metal Oxide
R796	VRS-TV1JD272JY	AA		R	Resistor, 2.7k 1/16W Metal Oxide
R797	VRS-TQ2EF333FY			R	Resistor, 33k 1/4W Metal Oxide
R798	VRS-CY1JF000JY	AA		R	Resistor, 0 1/16W Metal Oxide
R799	VRS-CY1JF000JY	AA		R	Resistor, 0 1/16W Metal Oxide
R800	VRS-TV1JD000JY	AA		R	Resistor, 0 1/16W Metal Oxide
R801	VRS-CY1JF122JY	AA		R	Resistor, 1.2k 1/16W Metal Oxide
R802	VRS-VV3AB273J	AA		R	Resistor, 27k 1W Metal Oxide
R803	VRS-VV3AB273J	AA		R	Resistor, 27k 1W Metal Oxide
R804	VRS-VV3LB220J	AB		R	Resistor, 22 3.0W Metal Oxide
R805	VRS-TV1JD224JY	AA		R	Resistor, 220k 1/16W Metal Oxide
R806	VRS-CY1JF103JY	AA		R	Resistor, 10k 1/16W Metal Oxide
R808	VRS-TQ2EF123FY			R	Resistor, 12k 1/4W Metal Oxide
R809	VRS-CY1JF122JY	AA		R	Resistor, 1.2k 1/16W Metal Oxide
R810	VRS-TQ2EF683JY	AA		R	Resistor, 68k 1/4W Metal Oxide
R811	VRS-CY1JF000JY	AA		R	Resistor, 0 1/16W Metal Oxide
R812	VRS-CY1JF122JY	AA		R	Resistor, 1.2k 1/16W Metal Oxide
R815	VRS-CY1JF000JY	AA		R	Resistor, 0 1/16W Metal Oxide
R816	VRS-CY1JF000JY	AA		R	Resistor, 0 1/16W Metal Oxide
R817	VRS-TQ2EF122JY	AA		R	Resistor, 1.2k 1/4W Metal Oxide
R820	VRS-CY1JF122JY	AA		R	Resistor, 1.2k 1/16W Metal Oxide
R822	VRS-TQ2EF124FY	AA		R	Resistor, 120k 1/4W Metal Oxide
R823	VRS-TV1JD103JY	AA		R	Resistor, 10k 1/16W Metal Oxide

NO.	PARTS CODE	PRICE RANK	NEW MARK	PART DELIVERY	DESCRIPTION
[5] DUNTKD787FM02 (Power Unit)					
R824	VRSTQ2EF332JY	AA		R	Resistor, 3.3k 1/4W Metal Oxide
R825	VRSTV1JD103JY	AA		R	Resistor, 10k 1/16W Metal Oxide
R826	VRSTQ2EF124FY	AA		R	Resistor, 120k 1/4W Metal Oxide
R828	VRSTQ2EF220JY	AA		R	Resistor, 22 1/4W Metal Oxide
R830	VRSTV1JD103JY	AA		R	Resistor, 10k 1/16W Metal Oxide
R831	VRSTV1JD103JY	AA		R	Resistor, 10k 1/16W Metal Oxide
R832	VRSCY1JF104JY	AA		R	Resistor, 100k 1/16W Metal Oxide
R834	VRSTV1JD103JY	AA		R	Resistor, 10k 1/16W Metal Oxide
R835	VRSTQ2BD000JY	AA		R	Resistor, 0 1/8W Metal Oxide
R836	VRSTV1JD103JY	AA		R	Resistor, 10k 1/16W Metal Oxide
R837	VRSCY1JF472DY	AA	S	R	Resistor, 4.7k 1/16W Metal Oxide
R839	VRSCY1JF105JY	AA		R	Resistor, 1M 1/16W Metal Oxide
R840	VRSCY1JF104JY	AA		R	Resistor, 100k 1/16W Metal Oxide
R847	VRSCY1JF152JY	AA		R	Resistor, 1.5k 1/16W Metal Oxide
R848	VRSCY1JF000JY	AA		R	Resistor, 0 1/16W Metal Oxide
R851	VRSTQ2EF221JY	AA		R	Resistor, 220 1/4W Metal Oxide
R852	VRSTQ2EF221JY	AA		R	Resistor, 220 1/4W Metal Oxide
R854	VRVV3DB102J	AA		R	Resistor, 1k 2W Metal Oxide
R857	VRSTQ2BD000JY	AA		R	Resistor, 0 1/8W Metal Oxide
R858	VRSTV1JD272JY	AA		R	Resistor, 2.7k 1/16W Metal Oxide
R859	VRSCY1JF123JY	AA		R	Resistor, 12k 1/16W Metal Oxide
R860	VRSCY1JF472JY	AA		R	Resistor, 4.7k 1/16W Metal Oxide
R861	VRSCY1JF272JY	AA		R	Resistor, 2.7k 1/16W Metal Oxide
R862	VRSCY1JF272JY	AA		R	Resistor, 2.7k 1/16W Metal Oxide
R863	VRSCY1JF472JY	AA		R	Resistor, 4.7k 1/16W Metal Oxide
R864	VRSCY1JF333JY	AA		R	Resistor, 33k 1/16W Metal Oxide
R865	VRSCY1JF333JY	AA		R	Resistor, 33k 1/16W Metal Oxide
R866	VRSCY1JF473JY	AA		R	Resistor, 47k 1/16W Metal Oxide
R867	VRSCY1JF123JY	AA		R	Resistor, 12k 1/16W Metal Oxide
R868	VRSCY1JF122JY	AA		R	Resistor, 1.2k 1/16W Metal Oxide
R869	VRSCY1JF332JY	AA		R	Resistor, 3.3k 1/16W Metal Oxide
R870	VRSCY1JF222JY	AA		R	Resistor, 2.2k 1/16W Metal Oxide
R871	VRSCY1JF122JY	AA		R	Resistor, 1.2k 1/16W Metal Oxide
R872	VRSCY1JF472JY	AA		R	Resistor, 4.7k 1/16W Metal Oxide
R873	VRSCY1JF122JY	AA		R	Resistor, 1.2k 1/16W Metal Oxide
R875	VRSCY1JF472JY	AA		R	Resistor, 4.7k 1/16W Metal Oxide
R876	VRSCY1JF472JY	AA		R	Resistor, 4.7k 1/16W Metal Oxide
R878	VRSCY1JF472JY	AA		R	Resistor, 4.7k 1/16W Metal Oxide
R879	VRSCY1JF682JY	AA		R	Resistor, 6.8k 1/16W Metal Oxide
R881	VRSTQ2EF681JY	AA		R	Resistor, 680 1/4W Metal Oxide
R882	VRSTQ2EF681JY	AA		R	Resistor, 680 1/4W Metal Oxide
R884	VRSCY1JF101JY	AA		R	Resistor, 100 1/16W Metal Oxide
R885	VRSCY1JF104JY	AA		R	Resistor, 100k 1/16W Metal Oxide
R886	VRSCY1JF563JY	AA		R	Resistor, 56k 1/16W Metal Oxide
RDA701	PRDARA336WJFW		N	R	Heat Sink
RDA702	PRDARA306WJFW	AG	N	R	Heat Sink
RDA703	PRDARA337WJFW		N	R	Heat Sink
RDA704	PRDARA308WJFW	AH	N	R	Heat Sink
RDA705	PRDARA367WJFW		N	R	Heat Sink
RDA706	PRDARA242WJFW		N	R	Heat Sink
RJ1	VRSCY1JF000JY	AA		R	Resistor, 0 1/16W Metal Oxide
RJ2	VRSCY1JF000JY	AA		R	Resistor, 0 1/16W Metal Oxide
RJ3	VRSCY1JF000JY	AA		R	Resistor, 0 1/16W Metal Oxide
RY701	RRLYDA008WJZZ	AG		R	Relay
SC701	QSOCAA008WJZZ	AE		R	Socket, 2Pin
T701	RTRNWA255WJZZ			R	Tranceformer
T702	RTRNWA244WJZZ			R	Tranceformer
TH701	RH-HXA033WJZZ	AG		R	Thermistor, 16D2-13LCS
VA701	RH-VXA071WJQZ	AD		R	Varistor, ERZV10D471CS
VA702	RH-VXA071WJQZ	AD		R	Varistor, ERZV10D471CS
N	LX-BZ3049GEF7	AA		R	Screw, x13
N	LX-BZA165WJZZ	AB		R	Screw, x2
[6] DUNTKD833FM06 (Digital Tuner Unit)					
C202	VCCCCY1HH220JY	AA		S	Capacitor, 22p 50V Ceramic
C203	VCCCCY1HH220JY	AA		S	Capacitor, 22p 50V Ceramic
C204	VCEASX0JN108MY	AE		S	Capacitor, 1000 6.3V Electrolytic
C205	VCKYCY1HF103ZY	AA		S	Capacitor, 0.01 50V Ceramic
C206	VCEASX1CN107MY	AC		S	Capacitor, 100 16V Electrolytic
C207	VCKYCY1HF103ZY	AA		S	Capacitor, 0.01 50V Ceramic
C208	VCKYCY1EF104ZY	AA		S	Capacitor, 0.1 25V Ceramic
C209	VCKYCY1HB102KY	AA		S	Capacitor, 1000p 50V Ceramic
C211	VCKYCY1HF103ZY	AA		S	Capacitor, 0.01 50V Ceramic
C212	VCEASX1HN106MY	AC		S	Capacitor, 10 50V Electrolytic
C222	VCKYCY1HF103ZY	AA		S	Capacitor, 0.01 50V Ceramic
C227	VCKYCY1HF103ZY	AA		S	Capacitor, 0.01 50V Ceramic
C230	VCEASX1HN106MY	AC		S	Capacitor, 10 50V Electrolytic
C233	VCKYCY1HB102KY	AA		S	Capacitor, 1000p 50V Ceramic
C235	VCCCCY1HH150JY	AA		S	Capacitor, 15p 50V Ceramic
C236	VCKYCY1HF103ZY	AA		S	Capacitor, 0.01 50V Ceramic
C237	VCEASX1HN225MY	AB		S	Capacitor, 2.2 50V Electrolytic
C241	VCEASX1AN336MY	AC		S	Capacitor, 33 10V Electrolytic
C242	VCEASX1CN106MY	AC		S	Capacitor, 10 16V Electrolytic
C243	VCKYCY1EF104ZY	AA		S	Capacitor, 0.1 25V Ceramic

NO.	PARTS CODE	PRICE RANK	NEW MARK	PART DELIVERY	DESCRIPTION
[6] DUNTKD833FM06 (Digital Tuner Unit)					
C244	VCEASX0JN226MY	AB		S	Capacitor, 22 6.3V Electrolytic
C245	VCKYCY1EF104ZY	AA		S	Capacitor, 0.1 25V Ceramic
C246	VCEASX1CN106MY	AC		S	Capacitor, 10 16V Electrolytic
C247	VCEASX1CN106MY	AC		S	Capacitor, 10 16V Electrolytic
C248	VCKYCY1HF103ZY	AA		S	Capacitor, 0.01 50V Ceramic
C249	VCEASX1CN106MY	AC		S	Capacitor, 10 16V Electrolytic
C250	VCKYCY1HF103ZY	AA		S	Capacitor, 0.01 50V Ceramic
C251	VCKYCY1HF103ZY	AA		S	Capacitor, 0.01 50V Ceramic
C252	VCEASX1CN106MY	AC		S	Capacitor, 10 16V Electrolytic
C253	VCKYCY1HF103ZY	AA		S	Capacitor, 0.01 50V Ceramic
C254	VCKYCY1HF103ZY	AA		S	Capacitor, 0.01 50V Ceramic
C256	VCKYCY1EF104ZY	AA		S	Capacitor, 0.1 25V Ceramic
C257	VCKYCY1HB103KY	AA		S	Capacitor, 0.01 50V Ceramic
C258	VCKYCY1HB103KY	AA		S	Capacitor, 0.01 50V Ceramic
C259	VCCCCY1HH2R0CY	AA		S	Capacitor, 2p 50V Electrolytic
C260	VCCCCY1HH150JY	AA		S	Capacitor, 15p 50V Ceramic
C261	VCEASX1CN106MY	AC		S	Capacitor, 10 16V Electrolytic
C262	VCKYCY1EF104ZY	AA		S	Capacitor, 0.1 25V Ceramic
C263	VCKYCY1EF104ZY	AA		S	Capacitor, 0.1 25V Ceramic
C266	VCKYCY1HF103ZY	AA		S	Capacitor, 0.01 50V Ceramic
C267	VCKYCY1HF103ZY	AA		S	Capacitor, 0.01 50V Ceramic
C268	VCKYCY1EB104KY	AB		S	Capacitor, 0.1 25V Electrolytic
C269	VCKYCY1EB104KY	AB		S	Capacitor, 0.1 25V Electrolytic
C270	VCAAPD0JJ227MY	AF		S	Capacitor, 220 6.3V Electrolytic
C271	VCKYCY1HF103ZY	AA		S	Capacitor, 0.01 50V Ceramic
C272	VCKYCY1HB102KY	AA		S	Capacitor, 1000p 50V Ceramic
C273	VCAAPD0JJ227MY	AF		S	Capacitor, 220 6.3V Electrolytic
C279	RC-KZA073WJZZY	AD		S	Capacitor, 10 16V Ceramic
D202	RH-EXA102WJZZY	AB		S	Zener Diode, UDZSTE-1733B
FB201	RBLN-0210TAZZY	AB		S	Balun, BLN-0210TA
FB202	RBLN-0065CEZZY	AC		S	Balun, BLN-0065CE
FB203	RBLN-0060TAZZY	AB		S	Balun, BLN-0060TA
IC201	VHiT7WB125A-1Y	AE		S	IC, TC7WBD125AFK(T5L,F)
IC202	RH-iXB682WJZZQ	AZ		S	IC, IXB682WJ
IC204	VHiLV4053FT-1Y	AE		S	IC, TC74LVX4053FT(EL)
IC205	VHiPQ1M185M-1Y	AD		S	IC, Q1M185M
IC206	VHiMM3033E+-1Y	AD		S	IC, MM3033E
L206	VPCUN1R5MR12NY	AC		S	Coil, Peaking 0.12μH
L207	VPCNN2R2JR77NY	AB		S	Coil, Peaking 0.77μH
L208	VPCNN2R2JR77NY	AB		S	Coil, Peaking 0.77μH
L209	VPCNN2R2JR77NY	AB		S	Coil, Peaking 0.77μH
L210	VPCNN2R2JR77NY	AB		S	Coil, Peaking 0.77μH
L213	VPCKM30J3R9NY	AB		S	Coil, Peaking 3.9μH
LUG201	QLUGHA009WJZZY	AC		S	Lug
LUG202	QLUGHA009WJZZY	AC		S	Lug
LUG203	QLUGHA009WJZZY	AC		S	Lug
P201	QCNCMA012WJZZ	AD		S	Connector, 15Pin
P202	QCNCMA250WJZZ	AE		S	Connector, 23Pin
Q203	VS2SC2735//1EY	AC		S	Transistor, 2SC2735JC21TL
Q209	VSRN4904//--1Y	AB		S	Transistor, RN4904(TE85L,F)
Q210	VS2SC2735//1EY	AC		S	Transistor, 2SC2735JC21TL
R201	VRS-CY1JF000JY	AA		S	Resistor, 0 1/16W Metal Oxide
R205	VRS-CY1JF750JY	AA		S	Resistor, 75 1/16W Metal Oxide
R207	VRS-CY1JF470JY	AA		S	Resistor, 47 1/16W Metal Oxide
R208	VRS-CY1JF470JY	AA		S	Resistor, 47 1/16W Metal Oxide
R209	VRS-CY1JF000JY	AA		S	Resistor, 0 1/16W Metal Oxide
R211	VRS-CY1JF000JY	AA		S	Resistor, 0 1/16W Metal Oxide
R213	VRS-CY1JF000JY	AA		S	Resistor, 0 1/16W Metal Oxide
R214	VRS-CY1JF100JY	AA		S	Resistor, 10 1/16W Metal Oxide
R215	VRS-CY1JF472JY	AA		S	Resistor, 4.7k 1/16W Metal Oxide
R216	VRS-CY1JF472JY	AA		S	Resistor, 4.7k 1/16W Metal Oxide
R217	VRS-CY1JF472JY	AA		S	Resistor, 4.7k 1/16W Metal Oxide
R218	VRS-CY1JF472JY	AA		S	Resistor, 4.7k 1/16W Metal Oxide
R220	VRS-CY1JF101JY	AA		S	Resistor, 100 1/16W Metal Oxide
R225	VRS-TW2ED561JY	AA		S	Resistor, 560 1/4W Metal Oxide
R226	VRS-CY1JF273JY	AA		S	Resistor, 27k 1/16W Metal Oxide
R227	VRS-CY1JF000JY	AA		S	Resistor, 0 1/16W Metal Oxide
R228	VRS-TQ2BD1R0JY	AA		S	Resistor, 1 1/8W Metal Oxide
R237	VRS-CY1JF331JY	AA		S	Resistor, 330 1/16W Metal Oxide
R238	VRS-CY1JF151JY	AA		S	Resistor, 150 1/16W Metal Oxide
R241	VRS-CY1JF103JY	AA		S	Resistor, 10k 1/16W Metal Oxide
R242	VRS-CY1JF392JY	AA		S	Resistor, 3.9k 1/16W Metal Oxide
R243	VRS-CY1JF101JY	AA		S	Resistor, 100 1/16W Metal Oxide
R245	VRS-CH1JF103JY	AA		S	Resistor, 10k 1/16W Metal Oxide
R247	VRS-CY1JF000JY	AA		S	Resistor, 0 1/16W Metal Oxide
R248	VRS-CY1JF153JY	AA		S	Resistor, 15k 1/16W Metal Oxide
R255	VRS-CY1JF470JY	AA		S	Resistor, 47 1/16W Metal Oxide
R256	VRS-CY1JF470JY	AA		S	Resistor, 47 1/16W Metal Oxide
R259	VRS-CY1JF151JY	AA		S	Resistor, 150 1/16W Metal Oxide
R264	VRS-CY1JF101JY	AA		S	Resistor, 100 1/16W Metal Oxide
R265	VRS-CY1JF101JY	AA		S	Resistor, 100 1/16W Metal Oxide
R266	VRS-CY1JF000JY	AA		S	Resistor, 0 1/16W Metal Oxide
R267	VRS-CY1JF000JY	AA		S	Resistor, 0 1/16W Metal Oxide
R268	VRS-CY1JF000JY	AA		S	Resistor, 0 1/16W Metal Oxide
R269	VRS-CY1JF000JY	AA		S	Resistor, 0 1/16W Metal Oxide

NO.	PARTS CODE	PRICE RANK	NEW MARK	PART DELIVERY	DESCRIPTION
[6] DUNTKD833FM06 (Digital Tuner Unit)					
R270	VRS-CY1JF514JY	AA		S	Resistor, 510k 1/16W Metal Oxide
R271	VRS-CY1JF102JY	AA		S	Resistor, 1k 1/16W Metal Oxide
R272	VRS-CH1JF000JY	AA		S	Resistor, 0 1/16W Metal Oxide
R273	VRS-CH1JF000JY	AA		S	Resistor, 0 1/16W Metal Oxide
R274	VRS-CY1JF000JY	AA		S	Resistor, 0 1/16W Metal Oxide
R275	VRS-TW2HF1R8JY	AA		S	Resistor, 1.8 1/2W Metal Oxide
R276	VRS-TW2HF1R8JY	AA		S	Resistor, 1.8 1/2W Metal Oxide
R277	VRS-TW2HF1R8JY	AA		S	Resistor, 1.8 1/2W Metal Oxide
R281	VRS-CY1JF000JY	AA		S	Resistor, 0 1/16W Metal Oxide
R282	VRS-CY1JF000JY	AA		S	Resistor, 0 1/16W Metal Oxide
R283	VRS-CY1JF000JY	AA		S	Resistor, 0 1/16W Metal Oxide
R284	VRS-CY1JF103JY	AA		S	Resistor, 10k 1/16W Metal Oxide
R285	VRS-CY1JF103JY	AA		S	Resistor, 10k 1/16W Metal Oxide
R286	VRS-CY1JF100JY	AA		S	Resistor, 10 1/16W Metal Oxide
R287	VRS-CY1JF272JY	AA		S	Resistor, 2.7k 1/16W Metal Oxide
R289	VRS-CY1JF103JY	AA		S	Resistor, 10k 1/16W Metal Oxide
R290	VRS-CY1JF181JY	AA		S	Resistor, 180 1/16W Metal Oxide
R293	VRS-CY1JF000JY	AA		S	Resistor, 0 1/16W Metal Oxide
R294	VRS-CY1JF000JY	AA		S	Resistor, 0 1/16W Metal Oxide
X202	RCRSCA039WJZZY	AG		S	Crystal
[7] DUNTKD909FM05 (R/C LED Unit)					
C102	VCKYTV1CF225ZY	AB		R	Capacitor, 2.2 16V Ceramic
C104	VCEASX1CN106MY	AC		R	Capacitor, 10 16V Electrolytic
C105	VCKYCY1HF103ZY	AA		R	Capacitor, 0.01 50V Ceramic
C107	VCEASY1CN107MY	AC		R	Capacitor, 100 16V Electrolytic
D101	RH-EXA092WJZZY	AB		R	Zener Diode, UDZSTE-1712B
D103	RH-PX0421CEZZY	AD		R	LED, CL-165HR/YG-D-T
D114	RH-PX0421CEZZY	AD		R	LED, CL-165HR/YG-D-T
D115	RH-PX0421CEZZY	AD		R	LED, CL-165HR/YG-D-T
IC101	VHiTPS850++-1Y	AG		R	IC, TPS850
P101	QPLGNA333WJZZY	AD		R	Plug, 13Pin(RA)
Q102	VS2SC3928AR-1Y	AB		R	Transistor, 2SC3928A-T112-1R
Q103	VS2SC3928AR-1Y	AB		R	Transistor, 2SC3928A-T112-1R
Q106	VS2SC3928AR-1Y	AB		R	Transistor, 2SC3928A-T112-1R
Q107	VS2SC3928AR-1Y	AB		R	Transistor, 2SC3928A-T112-1R
R101	VRS-CY1JF101JY	AA		R	Resistor, 100 1/16W Metal Oxide
R102	VRS-CY1JF103JY	AA		R	Resistor, 10k 1/16W Metal Oxide
R104	VRS-CY1JF273JY	AA		R	Resistor, 27k 1/16W Metal Oxide
R108	VRS-CY1JF161JY	AA		R	Resistor, 160 1/16W Metal Oxide
R109	VRS-CY1JF821JY	AA		R	Resistor, 820 1/16W Metal Oxide
R121	VRS-CY1JF821JY	AA		R	Resistor, 820 1/16W Metal Oxide
R122	VRS-CY1JF161JY	AA		R	Resistor, 160 1/16W Metal Oxide
R123	VRS-CJ1JF103JY	AA		R	Resistor, 10k 1/16W Metal Oxide
R124	VRS-CJ1JF103JY	AA		R	Resistor, 10k 1/16W Metal Oxide
R135	VRS-CY1JF000JY	AA		R	Resistor, 0 1/16W Metal Oxide
RMC101	RRMUA053WJZZ	AE		R	Remote Receiver
SLD101	PSLDM4646CEFW	AD		R	Shield
[8] DUNTKD910FM01 (KEY Unit)					
D151	RH-EX0646GEZZY	AA		R	Zener Diode, MTZJT-7215B
D152	RH-EX0646GEZZY	AA		R	Zener Diode, MTZJT-7215B
D155	RH-EX0646GEZZY	AA		R	Zener Diode, MTZJT-7215B
P151	QPLGNA058WJZZ	AC		R	Plug, 4Pin(KM)
R151	VRD-RA2BE822JY	AA		R	Resistor, 8.2k 1/8W Carbon
R152	VRD-RA2BE123JY	AA		R	Resistor, 12k 1/8W Carbon
R153	VRD-RA2BE822JY	AA		R	Resistor, 8.2k 1/8W Carbon
S151	QSW-K0003AJZZ+	AB		R	Switch, CH UP
S152	QSW-K0003AJZZ+	AB		R	Switch, CH DOWN
S153	QSW-K0003AJZZ+	AB		R	Switch, INPUT
S154	QSW-K0003AJZZ+	AB		R	Switch, VOL UP
S155	QSW-K0003AJZZ+	AB		R	Switch, VOL DOWN
S157	QSW-K0003AJZZ+	AB		R	Switch
[9] DUNTKD915FM07 (Main Unit)					
C1701	VCKYCY1EF104ZY	AA		R	Capacitor, 0.1 25V Ceramic
C1702	VCKYCY1HB103KY	AA		R	Capacitor, 0.01 50V Ceramic
C1703	VCKYCY1EF104ZY	AA		R	Capacitor, 0.1 25V Ceramic
C1704	VCAAPD1AJ686MY	AE		R	Capacitor, 68 10V Electrolytic
C1705	VCKYCY1EF104ZY	AA		R	Capacitor, 0.1 25V Ceramic
C1706	RC-KZA070WJZZY	AD		R	Capacitor, 22 6.3V Ceramic
C1707	VCKYCY1EF104ZY	AA		R	Capacitor, 0.1 25V Ceramic
C1708	VCKYTV1CB105KY	AC		R	Capacitor, 1 16V Ceramic
C1709	VCKYCY1EF104ZY	AA		R	Capacitor, 0.1 25V Ceramic
C1710	VCKYCY1EF104ZY	AA		R	Capacitor, 0.1 25V Ceramic
C1711	RC-KZA073WJZZY	AD		R	Capacitor, 10 16V Ceramic
C1712	VCKYCY1EF104ZY	AA		R	Capacitor, 0.1 25V Ceramic
C1713	VCKYCY1EF104ZY	AA		R	Capacitor, 0.1 25V Ceramic
C1715	VCEASX1VN226MY	AC		R	Capacitor, 22 35V Electrolytic
C1716	VCEASX1CN226MY	AC		R	Capacitor, 22 16V Electrolytic
C1717	VCKYCY1HB682KY	AA		R	Capacitor, 6800p 50V Ceramic
C1718	VCKYCY1EF104ZY	AA		R	Capacitor, 0.1 25V Ceramic
C1719	VCKYCY1EF104ZY	AA		R	Capacitor, 0.1 25V Ceramic
C1720	VCEASX1CN226MY	AC		R	Capacitor, 22 16V Electrolytic

NO.	PARTS CODE	PRICE RANK	NEW MARK	PART DELIVERY	DESCRIPTION
[9] DUNTKD915FM07 (Main Unit)					
C1721	VCAAPD1AJ686MY	AE		R	Capacitor, 68 10V Electrolytic
C1722	VCKYCY1EF104ZY	AA		R	Capacitor, 0.1 25V Ceramic
C1723	RC-KZA073WJZZY	AD		R	Capacitor, 10 16V Ceramic
C1724	RC-KZA073WJZZY	AD		R	Capacitor, 10 16V Ceramic
C1725	VCKYCY1EF104ZY	AA		R	Capacitor, 0.1 25V Ceramic
C1726	RC-KZA070WJZZY	AD		R	Capacitor, 22 6.3V Ceramic
C1727	VCKYCY1EF104ZY	AA		R	Capacitor, 0.1 25V Ceramic
C1728	VCKYTV1CB105KY	AC		R	Capacitor, 1 16V Ceramic
C1730	VCKYCY1HB332KY	AA		R	Capacitor, 3300p 50V Ceramic
C1731	VCKYCY1EF104ZY	AA		R	Capacitor, 0.1 25V Ceramic
C1732	VCKYCY1EF104ZY	AA		R	Capacitor, 0.1 25V Ceramic
C1733	VCEASX1CN226MY	AC		R	Capacitor, 22 16V Electrolytic
C1734	VCKYCY1EF104ZY	AA		R	Capacitor, 0.1 25V Ceramic
C1735	VCAAPD1AJ686MY	AE		R	Capacitor, 68 10V Electrolytic
C1736	VCKYCY1EF104ZY	AA		R	Capacitor, 0.1 25V Ceramic
C1737	RC-KZA073WJZZY	AD		R	Capacitor, 10 16V Ceramic
C1738	RC-KZA073WJZZY	AD		R	Capacitor, 10 16V Ceramic
C1739	VCKYCY1EF104ZY	AA		R	Capacitor, 0.1 25V Ceramic
C1740	RC-KZA070WJZZY	AD		R	Capacitor, 22 6.3V Ceramic
C1741	VCKYCY1EF104ZY	AA		R	Capacitor, 0.1 25V Ceramic
C1742	VCKYCY1EF104ZY	AA		R	Capacitor, 0.1 25V Ceramic
C1743	VCCCCY1HH220JY	AA		R	Capacitor, 22p 50V Ceramic
C1744	VCAAPD1AJ686MY	AE		R	Capacitor, 68 10V Electrolytic
C1745	VCCCCY1HH560JY	AB		R	Capacitor, 56p 50V Ceramic
C1746	VCEASX0JN476MY	AC		R	Capacitor, 47 6.3V Electrolytic
C1747	VCEASX0JN476MY	AC		R	Capacitor, 47 6.3V Electrolytic
C1748	VCKYTV1CB105KY	AC		R	Capacitor, 1 16V Ceramic
C1749	VCKYCY1EF104ZY	AA		R	Capacitor, 0.1 25V Ceramic
C1751	VCKYCY1HB222KY	AA		R	Capacitor, 2200p 50V Ceramic
C1752	VCKYCY1EF104ZY	AA		R	Capacitor, 0.1 25V Ceramic
C1753	VCAAPD1AJ686MY	AE		R	Capacitor, 68 10V Electrolytic
C1754	VCKYCY1EF104ZY	AA		R	Capacitor, 0.1 25V Ceramic
C1755	RC-KZA073WJZZY	AD		R	Capacitor, 10 16V Ceramic
C1756	RC-KZA073WJZZY	AD		R	Capacitor, 10 16V Ceramic
C1757	VCKYCY1EF104ZY	AA		R	Capacitor, 0.1 25V Ceramic
C1758	VCKYCY1EF104ZY	AA		R	Capacitor, 0.1 25V Ceramic
C1759	VCKYCY1EF104ZY	AA		R	Capacitor, 0.1 25V Ceramic
C1760	VCKYCY1EF104ZY	AA		R	Capacitor, 0.1 25V Ceramic
C1761	VCKYCY1EF104ZY	AA		R	Capacitor, 0.1 25V Ceramic
C1762	VCKYCY1EF104ZY	AA		R	Capacitor, 0.1 25V Ceramic
C1763	VCKYCY1EF104ZY	AA		R	Capacitor, 0.1 25V Ceramic
C1764	VCKYCY1EF104ZY	AA		R	Capacitor, 0.1 25V Ceramic
C1765	VCEASX1CN226MY	AC		R	Capacitor, 22 16V Electrolytic
C1766	VCEASX1CN226MY	AC		R	Capacitor, 22 16V Electrolytic
C1767	VCCCCY1HH560JY	AB		R	Capacitor, 56p 50V Ceramic
C1768	VCCCCY1HH560JY	AB		R	Capacitor, 56p 50V Ceramic
C1769	VCKYCY1HB103KY	AA		R	Capacitor, 0.01 50V Ceramic
C1770	VCKYCY1HB103KY	AA		R	Capacitor, 0.01 50V Ceramic
C1771	VCKYCY1HB103KY	AA		R	Capacitor, 0.01 50V Ceramic
C1772	VCKYCY1HB221KY	AA		R	Capacitor, 220p 50V Ceramic
C1773	VCCCCY1HH102JY	AB		R	Capacitor, 1000p 50V Ceramic
C1783	VCKYCY1HB103KY	AA		R	Capacitor, 0.01 50V Ceramic
C1784	RC-KZA073WJZZY	AD		R	Capacitor, 10 16V Ceramic
C1903	VCKYCY1EF104ZY	AA		R	Capacitor, 0.1 25V Ceramic
C1904	VCKYCY1EF104ZY	AA		R	Capacitor, 0.1 25V Ceramic
C1910	RC-KZA073WJZZY	AD		R	Capacitor, 10 16V Ceramic
C1912	VCKYCY1HB102KY	AA		R	Capacitor, 1000p 50V Ceramic
C1913	VCKYCY1HB102KY	AA		R	Capacitor, 1000p 50V Ceramic
C1916	VCKYCY1HB102KY	AA		R	Capacitor, 1000p 50V Ceramic
C1917	VCKYCY1HB102KY	AA		R	Capacitor, 1000p 50V Ceramic
C1918	RC-KZA073WJZZY	AD		R	Capacitor, 10 16V Ceramic
C1919	RC-KZA073WJZZY	AD		R	Capacitor, 10 16V Ceramic
C1921	RC-KZA073WJZZY	AD		R	Capacitor, 10 16V Ceramic
C1923	VCKYCY1HB102KY	AA		R	Capacitor, 1000p 50V Ceramic
C1924	VCKYCY1HB102KY	AA		R	Capacitor, 1000p 50V Ceramic
C1927	VCKYCY1HB102KY	AA		R	Capacitor, 1000p 50V Ceramic
C1928	VCKYCY1HB103KY	AA		R	Capacitor, 0.01 50V Ceramic
C1929	VCCCCY1HH120JY	AA		R	Capacitor, 12p 50V Ceramic
C1930	VCKYCY1HB102KY	AA		R	Capacitor, 1000p 50V Ceramic
C1931	RC-KZA073WJZZY	AD		R	Capacitor, 10 16V Ceramic
C1934	VCCCCY1HH120JY	AA		R	Capacitor, 12p 50V Ceramic
C1935	RC-KZA073WJZZY	AD		R	Capacitor, 10 16V Ceramic
C1936	VCKYCY1HB102KY	AA		R	Capacitor, 1000p 50V Ceramic
C1941	VCKYCY1HB102KY	AA		R	Capacitor, 1000p 50V Ceramic
C1943	VCKYCY1HB102KY	AA		R	Capacitor, 1000p 50V Ceramic
C1946	VCKYCY1HB102KY	AA		R	Capacitor, 1000p 50V Ceramic
C1947	VCKYCY1EF104ZY	AA		R	Capacitor, 0.1 25V Ceramic
C1948	VCKYCY1HB102KY	AA		R	Capacitor, 1000p 50V Ceramic
C1953	VCKYCY1EF104ZY	AA		R	Capacitor, 0.1 25V Ceramic
C1955	VCKYCY1HB102KY	AA		R	Capacitor, 1000p 50V Ceramic
C1956	VCKYCY1HB102KY	AA		R	Capacitor, 1000p 50V Ceramic
C1959	VCKYCY1EF104ZY	AA		R	Capacitor, 0.1 25V Ceramic
C1960	VCKYCY1HB102KY	AA		R	Capacitor, 1000p 50V Ceramic
C1965	VCKYCY1HB102KY	AA		R	Capacitor, 1000p 50V Ceramic
C1967	VCKYCY1HB102KY	AA		R	Capacitor, 1000p 50V Ceramic

NO.	PARTS CODE	PRICE RANK	NEW MARK	PART DELIVERY	DESCRIPTION
[9] DUNTKD915FM07 (Main Unit)					
C1968	VCKYCY1HB102KY	AA		R	Capacitor, 1000p 50V Ceramic
C1969	VCKYCY1HB102KY	AA		R	Capacitor, 1000p 50V Ceramic
C1971	VCKYCY1HB102KY	AA		R	Capacitor, 1000p 50V Ceramic
C1973	VCKYCY1HB102KY	AA		R	Capacitor, 1000p 50V Ceramic
C1974	VCKYCY1HB102KY	AA		R	Capacitor, 1000p 50V Ceramic
C1975	VCKYCY1HB102KY	AA		R	Capacitor, 1000p 50V Ceramic
C2301	VCKYCY1EF104ZY	AA		R	Capacitor, 0.1 25V Ceramic
C2302	VCKYCY1EF104ZY	AA		R	Capacitor, 0.1 25V Ceramic
C2303	VCKYCY1EF104ZY	AA		R	Capacitor, 0.1 25V Ceramic
C2304	VCKYCY1EF104ZY	AA		R	Capacitor, 0.1 25V Ceramic
C2305	VCKYCY1EF104ZY	AA		R	Capacitor, 0.1 25V Ceramic
C2306	VGEASX1CN106MY	AC		R	Capacitor, 10 16V Electrolytic
C2307	VCKYCY1EF104ZY	AA		R	Capacitor, 0.1 25V Ceramic
C2308	VCKYCY1HB104KY	AA		R	Capacitor, 0.1 50V Ceramic
C2309	VCKYCY1HB104KY	AA		R	Capacitor, 0.1 50V Ceramic
C2310	VCKYCY1HB104KY	AA		R	Capacitor, 0.1 50V Ceramic
C2311	VCKYCY1EF104ZY	AA		R	Capacitor, 0.1 25V Ceramic
C2312	VCCCCY1HH330JY	AA		R	Capacitor, 33p 50V Ceramic
C2313	VCKYCY1EF104ZY	AA		R	Capacitor, 0.1 25V Ceramic
C2314	VCKYCY1EF104ZY	AA		R	Capacitor, 0.1 25V Ceramic
C2315	VCCCCY1HH330JY	AA		R	Capacitor, 33p 50V Ceramic
C2316	VCKYCY1EF104ZY	AA		R	Capacitor, 0.1 25V Ceramic
C2317	VCKYCY1EF104ZY	AA		R	Capacitor, 0.1 25V Ceramic
C2318	VCCCCY1HH100DY	AA		R	Capacitor, 10p 50V Ceramic
C2320	VCKYCY1EF104ZY	AA		R	Capacitor, 0.1 25V Ceramic
C2321	RC-KZA073WJZZY	AD		R	Capacitor, 10 16V Ceramic
C2322	VCCCCY1HH471JY	AA		R	Capacitor, 470p 50V Ceramic
C2323	VCCCCY1HH471JY	AA		R	Capacitor, 470p 50V Ceramic
C2328	VCKYCY1EF104ZY	AA		R	Capacitor, 0.1 25V Ceramic
C2329	RC-KZA510WJPZY	AB		R	Capacitor
C2330	VCCCCY1HH471JY	AA		R	Capacitor, 470p 50V Ceramic
C2701	VCCCCY1HH470JY	AA		R	Capacitor, 47p 50V Ceramic
C2702	VCCCCY1HH101JY	AA		R	Capacitor, 100p 50V Ceramic
C2703	VCCCCY1HH101JY	AA		R	Capacitor, 100p 50V Ceramic
C2704	VCCCCY1HH101JY	AA		R	Capacitor, 100p 50V Ceramic
C2705	VCCCCY1HH101JY	AA		R	Capacitor, 100p 50V Ceramic
C2706	VGEASX1HN105MY	AB		R	Capacitor, 1 50V Electrolytic
C2707	VGEASX1HN105MY	AB		R	Capacitor, 1 50V Electrolytic
C2708	VGEASX1HN105MY	AB		R	Capacitor, 1 50V Electrolytic
C2709	VGEASX1HN105MY	AB		R	Capacitor, 1 50V Electrolytic
C2710	VCCCCY1HH181JY	AA		R	Capacitor, 180p 50V Ceramic
C2711	VCCCCY1HH471JY	AA		R	Capacitor, 470p 50V Ceramic
C2712	VCKYCY1EF104ZY	AA		R	Capacitor, 0.1 25V Ceramic
C2713	VCCCCY1HH101JY	AA		R	Capacitor, 100p 50V Ceramic
C2714	VGEASX1CN106MY	AC		R	Capacitor, 10 16V Electrolytic
C2715	VCKYCY1EF104ZY	AA		R	Capacitor, 0.1 25V Ceramic
C2718	VCKYCY1CF105ZY	AA		R	Capacitor, 1.0 16V Ceramic
C2719	VCKYCY1CF105ZY	AA		R	Capacitor, 1.0 16V Ceramic
C2722	VCKYCY1EF104ZY	AA		R	Capacitor, 0.1 25V Ceramic
C2723	VCKYCY1EF104ZY	AA		R	Capacitor, 0.1 25V Ceramic
C2724	VCKYCY1EF104ZY	AA		R	Capacitor, 0.1 25V Ceramic
C2725	VCKYCY1HB221KY	AA		R	Capacitor, 220p 50V Ceramic
C2726	VCKYTV1EB104KY	AB		R	Capacitor, 0.1 25V Ceramic
C2733	VCKYCY1EF104ZY	AA		R	Capacitor, 0.1 25V Ceramic
C2734	VCKYCY1EF104ZY	AA		R	Capacitor, 0.1 25V Ceramic
C2739	VCKYCY1EF104ZY	AA		R	Capacitor, 0.1 25V Ceramic
C2740	VCKYTV1HB103KY	AA		R	Capacitor, 0.01 50V Ceramic
C2741	RC-KZA073WJZZY	AD		R	Capacitor, 10 16V Ceramic
C3001	VCKYCY1EF104ZY	AA		R	Capacitor, 0.1 25V Ceramic
C3002	VCKYCY1HB103KY	AA		R	Capacitor, 0.01 50V Ceramic
C3003	VCKYCY1EF104ZY	AA		R	Capacitor, 0.1 25V Ceramic
C3004	RC-KZA073WJZZY	AD		R	Capacitor, 10 16V Ceramic
C3005	VCKYCY1EF104ZY	AA		R	Capacitor, 0.1 25V Ceramic
C3006	RC-KZA073WJZZY	AD		R	Capacitor, 10 16V Ceramic
C3008	VCKYCY1HB103KY	AA		R	Capacitor, 0.01 50V Ceramic
C3009	VCKYCY1EF104ZY	AA		R	Capacitor, 0.1 25V Ceramic
C3010	VCKYCY1EF104ZY	AA		R	Capacitor, 0.1 25V Ceramic
C3011	VCKYCY1EF104ZY	AA		R	Capacitor, 0.1 25V Ceramic
C3012	VCCCCY1HH101JY	AA		R	Capacitor, 100p 50V Ceramic
C3013	RC-KZA073WJZZY	AD		R	Capacitor, 10 16V Ceramic
C3014	VCKYCY1HB104KY	AA		R	Capacitor, 0.1 50V Ceramic
C3015	VCKYCY1EF104ZY	AA		R	Capacitor, 0.1 25V Ceramic
C3016	VCKYCY1EF104ZY	AA		R	Capacitor, 0.1 25V Ceramic
C3017	VCCCCY1HH101JY	AA		R	Capacitor, 100p 50V Ceramic
C3018	VCKYCY1HB102KY	AA		R	Capacitor, 1000p 50V Ceramic
C3019	RC-KZA073WJZZY	AD		R	Capacitor, 10 16V Ceramic
C3020	VCKYCY1EF104ZY	AA		R	Capacitor, 0.1 25V Ceramic
C3021	VCKYCY1EF104ZY	AA		R	Capacitor, 0.1 25V Ceramic
C3022	VCCCCY1HH101JY	AA		R	Capacitor, 100p 50V Ceramic
C3023	VCKYCY1HB102KY	AA		R	Capacitor, 1000p 50V Ceramic
C3024	RC-KZA073WJZZY	AD		R	Capacitor, 10 16V Ceramic
C3025	VCKYCY1EF104ZY	AA		R	Capacitor, 0.1 25V Ceramic
C3026	VCKYCY1EF104ZY	AA		R	Capacitor, 0.1 25V Ceramic
C3027	RC-KZA073WJZZY	AD		R	Capacitor, 10 16V Ceramic
C3028	VCKYCY1EF104ZY	AA		R	Capacitor, 0.1 25V Ceramic

NO.	PARTS CODE	PRICE RANK	NEW MARK	PART DELIVERY	DESCRIPTION
[9] DUNTKD915FM07 (Main Unit)					
C3029	VCKYCY1EF104ZY	AA		R	Capacitor, 0.1 25V Ceramic
C3030	VCKYCY1EF104ZY	AA		R	Capacitor, 0.1 25V Ceramic
C3031	VCKYCY1EF104ZY	AA		R	Capacitor, 0.1 25V Ceramic
C3032	RC-KZA073WJZZY	AD		R	Capacitor, 10 16V Ceramic
C3033	VCKYCY1EF104ZY	AA		R	Capacitor, 0.1 25V Ceramic
C3034	VCCCCY1HH150JY	AA		R	Capacitor, 15p 50V Ceramic
C3035	VCKYCY1EF104ZY	AA		R	Capacitor, 0.1 25V Ceramic
C3036	RC-KZA073WJZZY	AD		R	Capacitor, 10 16V Ceramic
C3037	VCKYCY1HB102KY	AA		R	Capacitor, 1000p 50V Ceramic
C3038	VCKYCY1HB102KY	AA		R	Capacitor, 1000p 50V Ceramic
C3039	VCCCCY1HH180JY	AA		R	Capacitor, 18p 50V Ceramic
C3040	VCCCCY1HH101JY	AA		R	Capacitor, 100p 50V Ceramic
C3041	RC-KZA073WJZZY	AD		R	Capacitor, 10 16V Ceramic
C3042	VCKYCY1HB102KY	AA		R	Capacitor, 1000p 50V Ceramic
C3043	VCKYCY1HB103KY	AA		R	Capacitor, 0.01 50V Ceramic
C3044	VCKYCY1HB103KY	AA		R	Capacitor, 0.01 50V Ceramic
C3045	VCKYCY1HB103KY	AA		R	Capacitor, 0.01 50V Ceramic
C3046	VCCCCY1HH101JY	AA		R	Capacitor, 100p 50V Ceramic
C3047	VCKYCY1HB102KY	AA		R	Capacitor, 1000p 50V Ceramic
C3048	VCCCCY1HH101JY	AA		R	Capacitor, 100p 50V Ceramic
C3049	VCKYCY1HB102KY	AA		R	Capacitor, 1000p 50V Ceramic
C3050	VCCCCY1HH101JY	AA		R	Capacitor, 100p 50V Ceramic
C3301	VCKYCY1EF104ZY	AA		R	Capacitor, 0.1 25V Ceramic
C3302	VCKYCY1EF104ZY	AA		R	Capacitor, 0.1 25V Ceramic
C3303	VCKYCY1EF104ZY	AA		R	Capacitor, 0.1 25V Ceramic
C3304	VCKYCY1EF104ZY	AA		R	Capacitor, 0.1 25V Ceramic
C3305	VCKYCY1EF104ZY	AA		R	Capacitor, 0.1 25V Ceramic
C3306	VCKYCY1EF104ZY	AA		R	Capacitor, 0.1 25V Ceramic
C3307	VCKYCY1EF104ZY	AA		R	Capacitor, 0.1 25V Ceramic
C3308	VCKYCY1EF104ZY	AA		R	Capacitor, 0.1 25V Ceramic
C3309	VCKYCY1EF104ZY	AA		R	Capacitor, 0.1 25V Ceramic
C3310	VCKYCY1EF104ZY	AA		R	Capacitor, 0.1 25V Ceramic
C3311	VCKYCY1EF104ZY	AA		R	Capacitor, 0.1 25V Ceramic
C3312	VCKYCY1EF104ZY	AA		R	Capacitor, 0.1 25V Ceramic
C3313	VCKYCY1EF104ZY	AA		R	Capacitor, 0.1 25V Ceramic
C3314	VCKYCY1EF104ZY	AA		R	Capacitor, 0.1 25V Ceramic
C3315	VCCCCY1HH220JY	AA		R	Capacitor, 22p 50V Ceramic
C3316	VCKYCY1EF104ZY	AA		R	Capacitor, 0.1 25V Ceramic
C3317	VCKYCY1EF104ZY	AA		R	Capacitor, 0.1 25V Ceramic
C3318	VCCCCY1HH220JY	AA		R	Capacitor, 22p 50V Ceramic
C3319	VCKYCY1EF104ZY	AA		R	Capacitor, 0.1 25V Ceramic
C3320	VCKYCY1EF104ZY	AA		R	Capacitor, 0.1 25V Ceramic
C3321	VCKYCY1EF104ZY	AA		R	Capacitor, 0.1 25V Ceramic
C3322	VCKYCY1EF104ZY	AA		R	Capacitor, 0.1 25V Ceramic
C3323	VCKYCY1EF104ZY	AA		R	Capacitor, 0.1 25V Ceramic
C3324	VCKYCY1EF104ZY	AA		R	Capacitor, 0.1 25V Ceramic
C3325	VCKYCY1EF104ZY	AA		R	Capacitor, 0.1 25V Ceramic
C3326	VCKYCY1EF104ZY	AA		R	Capacitor, 0.1 25V Ceramic
C3327	VCKYCY1EF104ZY	AA		R	Capacitor, 0.1 25V Ceramic
C3328	VCKYCY1EF104ZY	AA		R	Capacitor, 0.1 25V Ceramic
C3329	VCKYCY1EF104ZY	AA		R	Capacitor, 0.1 25V Ceramic
C3330	VCKYCY1EF104ZY	AA		R	Capacitor, 0.1 25V Ceramic
C3331	RC-KZA073WJZZY	AD		R	Capacitor, 10 16V Ceramic
C3332	RC-KZA073WJZZY	AD		R	Capacitor, 10 16V Ceramic
C3333	RC-KZA073WJZZY	AD		R	Capacitor, 10 16V Ceramic
C3334	RC-KZA073WJZZY	AD		R	Capacitor, 10 16V Ceramic
C3335	VCEASY1CN476MY	AC		R	Capacitor, 47 16V Electrolytic
C3336	VCEASY1CN476MY	AC		R	Capacitor, 47 16V Electrolytic
C3337	VCKYCY1HB102KY	AA		R	Capacitor, 1000p 50V Ceramic
C3338	VCKYCY1HB102KY	AA		R	Capacitor, 1000p 50V Ceramic
C3339	VCCCCY1HH101JY	AA		R	Capacitor, 100p 50V Ceramic
C3340	VCKYCY1HB102KY	AA		R	Capacitor, 1000p 50V Ceramic
C3341	VCCCCY1HH101JY	AA		R	Capacitor, 100p 50V Ceramic
C3342	VCKYCY1HB102KY	AA		R	Capacitor, 1000p 50V Ceramic
C3343	VCCCCY1HH101JY	AA		R	Capacitor, 100p 50V Ceramic
C3501	VCKYCY1CF104ZY	AA		R	Capacitor, 0.1 16V Ceramic
C3502	VCKYCY1CF104ZY	AA		R	Capacitor, 0.1 16V Ceramic
C3503	VCKYCY1CF104ZY	AA		R	Capacitor, 0.1 16V Ceramic
C3504	VCKYCY1CF104ZY	AA		R	Capacitor, 0.1 16V Ceramic
C3505	VCKYCY1CF104ZY	AA		R	Capacitor, 0.1 16V Ceramic
C3506	VCKYCY1CF104ZY	AA		R	Capacitor, 0.1 16V Ceramic
C3507	VCKYCY1CF104ZY	AA		R	Capacitor, 0.1 16V Ceramic
C3508	VCKYCY1CF104ZY	AA		R	Capacitor, 0.1 16V Ceramic
C3509	VCKYCY1CF104ZY	AA		R	Capacitor, 0.1 16V Ceramic
C3510	VCKYCY1CF104ZY	AA		R	Capacitor, 0.1 16V Ceramic
C3511	VCKYCY1CF104ZY	AA		R	Capacitor, 0.1 16V Ceramic
C3512	VCKYCY1CF104ZY	AA		R	Capacitor, 0.1 16V Ceramic
C3513	VCKYCY1CF104ZY	AA		R	Capacitor, 0.1 16V Ceramic
C3514	VCKYCY1CF104ZY	AA		R	Capacitor, 0.1 16V Ceramic
C3515	VCKYCY1CF104ZY	AA		R	Capacitor, 0.1 16V Ceramic
C3516	VCKYCY1CF104ZY	AA		R	Capacitor, 0.1 16V Ceramic
C3517	VCKYCY1CF104ZY	AA		R	Capacitor, 0.1 16V Ceramic
C3518	VCKYCY1CF104ZY	AA		R	Capacitor, 0.1 16V Ceramic
C3519	VCKYCY1CF104ZY	AA		R	Capacitor, 0.1 16V Ceramic
C3520	VCKYCY1CF104ZY	AA		R	Capacitor, 0.1 16V Ceramic

NO.	PARTS CODE	PRICE RANK	NEW MARK	PART DELIVERY	DESCRIPTION
[9] DUNTKD915FM07 (Main Unit)					
C3521	RC-KZA073WJZZY	AD		R	Capacitor, 10 16V Ceramic
C3522	VCKYCY1HB102KY	AA		R	Capacitor, 1000p 50V Ceramic
C3525	VCCCCY1HH101JY	AA		R	Capacitor, 100p 50V Ceramic
C3526	VCCCCY1HH101JY	AA		R	Capacitor, 100p 50V Ceramic
C3527	VCKYCY1HB102KY	AA		R	Capacitor, 1000p 50V Ceramic
C3528	VCCCCY1HH101JY	AA		R	Capacitor, 100p 50V Ceramic
C3529	RC-KZ0124TAZZY	AC		R	Capacitor
C3530	RC-KZ0124TAZZY	AC		R	Capacitor
C3531	VCCCCY1HH101JY	AA		R	Capacitor, 100p 50V Ceramic
C3532	VCEASX0JN227MY	AC		R	Capacitor, 220 6.3V Electrolytic
C3533	VCKYCY1CF104ZY	AA		R	Capacitor, 0.1 16V Ceramic
C3534	VCKYCY1CF104ZY	AA		R	Capacitor, 0.1 16V Ceramic
C3535	VCKYCY1CF104ZY	AA		R	Capacitor, 0.1 16V Ceramic
C3536	VCKYCY1CF104ZY	AA		R	Capacitor, 0.1 16V Ceramic
C3537	VCCCCY1HH101JY	AB		R	Capacitor, 100p 50V Ceramic
C3538	VCKYCY1CF104ZY	AA		R	Capacitor, 0.1 16V Ceramic
C3539	VCKYCY1CF104ZY	AA		R	Capacitor, 0.1 16V Ceramic
C3540	VCKYCY1CF104ZY	AA		R	Capacitor, 0.1 16V Ceramic
C3541	VCKYCY1CF104ZY	AA		R	Capacitor, 0.1 16V Ceramic
C3542	VCKYCY1CF104ZY	AA		R	Capacitor, 0.1 16V Ceramic
C3543	VCKYCY1CF104ZY	AA		R	Capacitor, 0.1 16V Ceramic
C3544	VCKYCY1CF104ZY	AA		R	Capacitor, 0.1 16V Ceramic
C3545	VCKYCY1CF104ZY	AA		R	Capacitor, 0.1 16V Ceramic
C3546	VCKYCY1CF104ZY	AA		R	Capacitor, 0.1 16V Ceramic
C3547	VCKYCY1CF104ZY	AA		R	Capacitor, 0.1 16V Ceramic
C3548	VCKYCY1CF104ZY	AA		R	Capacitor, 0.1 16V Ceramic
C3549	VCKYCY1CF104ZY	AA		R	Capacitor, 0.1 16V Ceramic
C3550	VCKYCY1CF104ZY	AA		R	Capacitor, 0.1 16V Ceramic
C3551	RC-KZ0124TAZZY	AC		R	Capacitor
C3552	VCKYCY1CF104ZY	AA		R	Capacitor, 0.1 16V Ceramic
C3553	VCKYCY1CF104ZY	AA		R	Capacitor, 0.1 16V Ceramic
C3554	VCKYCY1CF104ZY	AA		R	Capacitor, 0.1 16V Ceramic
C3555	VCKYCY1CF104ZY	AA		R	Capacitor, 0.1 16V Ceramic
C3556	VCKYCY1CF104ZY	AA		R	Capacitor, 0.1 16V Ceramic
C3557	VCKYCY1CF104ZY	AA		R	Capacitor, 0.1 16V Ceramic
C3558	VCKYCY1CF104ZY	AA		R	Capacitor, 0.1 16V Ceramic
C3559	VCKYCY1CF104ZY	AA		R	Capacitor, 0.1 16V Ceramic
C3560	RC-KZA067WJZZY	AB		R	Capacitor
C3563	VCKYCY1HB102KY	AA		R	Capacitor, 1000p 50V Ceramic
C3564	VCKYCY1HB102KY	AB		R	Capacitor, 1000p 50V Ceramic
C3567	RC-KZ0124TAZZY	AC		R	Capacitor
C3568	VCKYTV1CB105KY	AC		R	Capacitor, 1 16V Ceramic
C3569	RC-KZ0124TAZZY	AC		R	Capacitor
C3701	VCKYCY1EF104ZY	AA		R	Capacitor, 0.1 25V Ceramic
C3702	VCEASY1CN107MY	AC		R	Capacitor, 100 16V Electrolytic
C3703	VCKYCY1HB103KY	AA		R	Capacitor, 0.01 50V Ceramic
C3704	VCEASX1CN106MY	AC		R	Capacitor, 10 16V Electrolytic
C3705	VCEASX1CN106MY	AC		R	Capacitor, 10 16V Electrolytic
C3706	VCEASY1CN107MY	AC		R	Capacitor, 100 16V Electrolytic
C3707	VCKYCY1EF104ZY	AA		R	Capacitor, 0.1 25V Ceramic
C3708	VCEASX1HN335MY	AB		R	Capacitor, 3.3 50V Electrolytic
C3709	VCKYCY1EF104ZY	AA		R	Capacitor, 0.1 25V Ceramic
C3710	VCKYCY1EF104ZY	AA		R	Capacitor, 0.1 25V Ceramic
C3711	VCEASX1CN106MY	AC		R	Capacitor, 10 16V Electrolytic
C3712	VCCCCY1HH471JY	AA		R	Capacitor, 470p 50V Ceramic
C3713	VCEASY1CN107MY	AC		R	Capacitor, 100 16V Electrolytic
C3714	VCCCCY1HH560JY	AB		R	Capacitor, 56p 50V Ceramic
C3715	VCCCCY1HH560JY	AB		R	Capacitor, 56p 50V Ceramic
C3716	VCCCCY1HH560JY	AB		R	Capacitor, 56p 50V Ceramic
C3717	VCCCCY1HH5R0CY	AA		R	Capacitor, 50p 50V Ceramic
C3718	VCCCCY1HH6R0DY	AA		R	Capacitor, 6p 50V Electrolytic
C3719	VCCCCY1HH331JY	AA		R	Capacitor, 330p 50V Ceramic
C3720	VCCCCY1HH331JY	AA		R	Capacitor, 330p 50V Ceramic
C3721	VCCCCY1HH331JY	AA		R	Capacitor, 330p 50V Ceramic
C3722	VCCCCY1HH331JY	AA		R	Capacitor, 330p 50V Ceramic
C3723	VCCCCY1HH331JY	AA		R	Capacitor, 330p 50V Ceramic
C3724	VCCCCY1HH331JY	AA		R	Capacitor, 330p 50V Ceramic
C3725	VCCCCY1HH331JY	AA		R	Capacitor, 330p 50V Ceramic
C3726	VCCCCY1HH331JY	AA		R	Capacitor, 330p 50V Ceramic
C3727	VCCCCY1HH101JY	AA		R	Capacitor, 100p 50V Ceramic
C3728	VCCCCY1HH101JY	AA		R	Capacitor, 100p 50V Ceramic
C3729	VCCCCY1HH101JY	AA		R	Capacitor, 100p 50V Ceramic
C3730	VCCCCY1HH101JY	AA		R	Capacitor, 100p 50V Ceramic
C3731	VCCCCY1HH101JY	AA		R	Capacitor, 100p 50V Ceramic
C3732	VCCCCY1HH101JY	AA		R	Capacitor, 100p 50V Ceramic
C3733	VCCCCY1HH101JY	AA		R	Capacitor, 100p 50V Ceramic
C3734	VCCCCY1HH101JY	AA		R	Capacitor, 100p 50V Ceramic
C3735	VCKYCY1EF104ZY	AA		R	Capacitor, 0.1 25V Ceramic
C3736	VCKYCY1EF104ZY	AA		R	Capacitor, 0.1 25V Ceramic
C3737	VCKYCY1EF104ZY	AA		R	Capacitor, 0.1 25V Ceramic
C3738	RC-KZA073WJZZY	AD		R	Capacitor, 10 16V Ceramic
C3739	RC-KZA073WJZZY	AD		R	Capacitor, 10 16V Ceramic
C3740	VCKYCY1HF224ZY	AA		R	Capacitor, 0.22 50V Ceramic
C3741	RC-KZA073WJZZY	AD		R	Capacitor, 10 16V Ceramic
C3742	RC-KZA073WJZZY	AD		R	Capacitor, 10 16V Ceramic

NO.	PARTS CODE	PRICE RANK	NEW MARK	PART DELIVERY	DESCRIPTION
[9] DUNTKD915FM07 (Main Unit)					
C3743	VCCCCY1HH101JY	AA		R	Capacitor, 100p 50V Ceramic
C3744	VCCCCY1HH101JY	AA		R	Capacitor, 100p 50V Ceramic
D1702	RH-EX0487CEZZY	AC		R	Zener Diode, HZM2.0NBTL-E
D1703	VHD1SS352//--1Y	AB		R	Diode, 1SS352(TPH3,F)
D1704	VHDTCCMS01+-1Y	AE		R	Diode, CMSO1(TE12L,Q)
D1705	VHD1SS352//--1Y	AB		R	Diode, 1SS352(TPH3,F)
D1706	VHD1SS352//--1Y	AB		R	Diode, 1SS352(TPH3,F)
D1707	RH-EX0487CEZZY	AC		R	Zener Diode, HZM2.0NBTL-E
D1708	VHDTCCMS01+-1Y	AE		R	Diode, CMSO1(TE12L,Q)
D1709	VHDTCCMS01+-1Y	AE		R	Diode, CMSO1(TE12L,Q)
D1901	VHDDAN202K/--1Y	AB		R	Diode, DAN202KT146
D1902	VHDDAN202K/--1Y	AB		R	Diode, DAN202KT146
D1903	VHD1SS352//--1Y	AB		R	Diode, 1SS352(TPH3,F)
D1904	VHD1SS352//--1Y	AB		R	Diode, 1SS352(TPH3,F)
D1905	VHD1SS352//--1Y	AB		R	Diode, 1SS352(TPH3,F)
D1906	VHD1SS352//--1Y	AB		R	Diode, 1SS352(TPH3,F)
D1913	VHDRB520S30-1Y	AC		R	Diode, RB520S-30TE61
D2301	RH-EX1271CEZZY	AB		R	Zener Diode, HZU12B2TRF
D2302	RH-EX1271CEZZY	AB		R	Zener Diode, HZU12B2TRF
D2303	RH-EX1271CEZZY	AB		R	Zener Diode, HZU12B2TRF
D2304	RH-EX1271CEZZY	AB		R	Zener Diode, HZU12B2TRF
D2305	RH-EX1247CEZZY	AB		R	Zener Diode, HZU5.6B2TRF
D2306	RH-EX1247CEZZY	AB		R	Zener Diode, HZU5.6B2TRF
D2307	RH-EX1247CEZZY	AB		R	Zener Diode, HZU5.6B2TRF
D2308	RH-EX1247CEZZY	AB		R	Zener Diode, HZU5.6B2TRF
D2309	VHDDAN202K/--1Y	AB		R	Diode, DAN202KT146
D2310	VHD1SS226//--1Y	AC		R	Diode, 1SS226(T5L,F,T)
D2311	VHD1SS226//--1Y	AC		R	Diode, 1SS226(T5L,F,T)
D2312	VHD1SS226//--1Y	AC		R	Diode, 1SS226(T5L,F,T)
D2313	RH-EX1247CEZZY	AB		R	Zener Diode, HZU5.6B2TRF
D2314	RH-EX1271CEZZY	AB		R	Zener Diode, HZU12B2TRF
D2315	RH-EX1271CEZZY	AB		R	Zener Diode, HZU12B2TRF
D2707	VHD1SS390+--1Y	AB		R	Diode, 1SS390TE61
FB1701	RBLN-0250TAZZY	AC		R	Balun, BLN-0250TA
FB1702	RBLN-0250TAZZY	AC		R	Balun, BLN-0250TA
FB1703	RBLN-0061TAZZY	AD		R	Balun, BLN-0061TA
FB1704	RBLN-0061TAZZY	AD		R	Balun, BLN-0061TA
FB1705	RBLN-0250TAZZY	AC		R	Balun, BLN-0250TA
FB1706	RBLN-0250TAZZY	AC		R	Balun, BLN-0250TA
FB1707	RBLN-0250TAZZY	AC		R	Balun, BLN-0250TA
FB1901	RBLN-0060TAZZY	AB		R	Balun, BLN-0060TA
FB1902	RBLN-0060TAZZY	AB		R	Balun, BLN-0060TA
FB1903	RBLN-0060TAZZY	AB		R	Balun, BLN-0060TA
FB1904	RBLN-0060TAZZY	AB		R	Balun, BLN-0060TA
FB1905	RBLN-0060TAZZY	AB		R	Balun, BLN-0060TA
FB1906	RBLN-0060TAZZY	AB		R	Balun, BLN-0060TA
FB1907	RBLN-0210TAZZY	AB		R	Balun, BLN-0210TA
FB1908	RBLN-0060TAZZY	AB		R	Balun, BLN-0060TA
FB1909	RBLN-0210TAZZY	AB		R	Balun, BLN-0210TA
FB2301	RBLN-0061TAZZY	AD		R	Balun, BLN-0061TA
FB2302	RBLN-0061TAZZY	AD		R	Balun, BLN-0061TA
FB2303	RBLN-0210TAZZY	AB		R	Balun, BLN-0210TA
FB2305	RBLN-0061TAZZY	AD		R	Balun, BLN-0061TA
FB2306	RBLN-0061TAZZY	AD		R	Balun, BLN-0061TA
FB2307	RBLN-0061TAZZY	AD		R	Balun, BLN-0061TA
FB2308	RBLN-0061TAZZY	AD		R	Balun, BLN-0061TA
FB2309	RBLN-0061TAZZY	AD		R	Balun, BLN-0061TA
FB2310	RBLN-0210TAZZY	AB		R	Balun, BLN-0210TA
FB2701	RBLN-0254TAZZY	AB		R	Balun, BLN-0254TA
FB2702	RBLN-0254TAZZY	AB		R	Balun, BLN-0254TA
FB2703	RBLN-0254TAZZY	AB		R	Balun, BLN-0254TA
FB2705	RBLN-0061TAZZY	AD		R	Balun, BLN-0061TA
FB2706	RBLN-0061TAZZY	AD		R	Balun, BLN-0061TA
FB2707	RBLN-0061TAZZY	AD		R	Balun, BLN-0061TA
FB2708	RBLN-0061TAZZY	AD		R	Balun, BLN-0061TA
FB2709	RBLN-0061TAZZY	AD		R	Balun, BLN-0061TA
FB2710	RBLN-0061TAZZY	AD		R	Balun, BLN-0061TA
FB2711	RBLN-0061TAZZY	AD		R	Balun, BLN-0061TA
FB2713	RBLN-0254TAZZY	AB		R	Balun, BLN-0254TA
FB2714	RBLN-0254TAZZY	AB		R	Balun, BLN-0254TA
FB2715	RBLN-0210TAZZY	AB		R	Balun, BLN-0210TA
FB2716	RBLN-0210TAZZY	AB		R	Balun, BLN-0210TA
FB3001	RBLN-0254TAZZY	AB		R	Balun, BLN-0254TA
FB3002	RBLN-0254TAZZY	AB		R	Balun, BLN-0254TA
FB3004	RBLN-0254TAZZY	AB		R	Balun, BLN-0254TA
FB3005	RBLN-0254TAZZY	AB		R	Balun, BLN-0254TA
FB3006	RBLN-0254TAZZY	AB		R	Balun, BLN-0254TA
FB3007	RBLN-0254TAZZY	AB		R	Balun, BLN-0254TA
FB3008	RBLN-0254TAZZY	AB		R	Balun, BLN-0254TA
FB3009	RBLN-0254TAZZY	AB		R	Balun, BLN-0254TA
FB3010	RBLN-0254TAZZY	AB		R	Balun, BLN-0254TA
FB3014	RBLN-0254TAZZY	AB		R	Balun, BLN-0254TA
FB3301	RBLN-0254TAZZY	AB		R	Balun, BLN-0254TA
FB3302	RBLN-0254TAZZY	AB		R	Balun, BLN-0254TA
FB3303	RBLN-0254TAZZY	AB		R	Balun, BLN-0254TA

NO.	PARTS CODE	PRICE RANK	NEW MARK	PART DELIVERY	DESCRIPTION
[9] DUNTKD915FM07 (Main Unit)					
FB3304	RBLN-0254TAZZY	AB		R	Balun, BLN-0254TA
FB3305	RBLN-0254TAZZY	AB		R	Balun, BLN-0254TA
FB3306	RBLN-0254TAZZY	AB		R	Balun, BLN-0254TA
FB3501	RBLN-0250TAZZY	AC		R	Balun, BLN-0250TA
FB3502	RBLN-0250TAZZY	AC		R	Balun, BLN-0250TA
FB3503	RBLN-0250TAZZY	AC		R	Balun, BLN-0250TA
FB3701	RBLN-0254TAZZY	AB		R	Balun, BLN-0254TA
FB3702	RBLN-0254TAZZY	AB		R	Balun, BLN-0254TA
FB3703	RBLN-0254TAZZY	AB		R	Balun, BLN-0254TA
FB3705	RBLN-0254TAZZY	AB		R	Balun, BLN-0254TA
FL2301	RFiLN0003TAZZY	AD		R	Filter
FL2302	RFiLN0003TAZZY	AD		R	Filter
FL2303	RFiLN0003TAZZY	AD		R	Filter
FL2304	RCiLFA071WJZZY	AD		R	Coil
FL2305	RCiLFA071WJZZY	AD		R	Coil
FL2306	RCiLFA071WJZZY	AD		R	Coil
FL2307	RCiLFA071WJZZY	AD		R	Coil
FL2308	RCiLFA071WJZZY	AD		R	Coil
FL2309	RCiLFA071WJZZY	AD		R	Coil
FL2310	RCiLFA071WJZZY	AD		R	Coil
FL2311	RCiLFA071WJZZY	AD		R	Coil
FL2312	RCiLFA071WJZZY	AD		R	Coil
FL2313	RCiLFA071WJZZY	AD		R	Coil
IC1701	VHiBU4239G+-1Y	AE		R	IC, BU4239G-TR
IC1702	VHiPQ20WZ11-1Y	AF		R	IC, PQ20WZ1UJ00H
IC1703	VHiPQ20WZ11-1Y	AF		R	IC, PQ20WZ1UJ00H
IC1705	VHiPQ1R50/-1Y	AF		R	IC, PQ1R50J0000H
IC1706	VHiMP1583+-1Y	AH		R	IC, MP1583
IC1707	VHiPQ20WZ11-1Y	AF		R	IC, PQ20WZ1UJ00H
IC1708	VHiMP1410ES-1Y	AP		R	IC, MP1410ES-LF-Z
IC1709	VSSM6J51TU-1Y	AF		R	IC, SSM6J51TU
IC1710	RH-iXB946WJZZQ	AU		R	IC, EPM240T100C5N
IC1712	VHiMP1410ES-1Y	AP		R	IC, MP1410ES-LF-Z
IC1901	VHi24LC2BINQES			R	IC, HDMI EDID (EXT5)
IC1902	VHi24LC2BIN-1Y			R	IC, HDMI EDID (EXT6)
IC1905	VHiSii9023+-1Q	BD		R	IC, Sii9023CTU
IC2301	VHi iCL3225E-1Y	AN		R	IC, ICL3225ECAZ-T
IC2303	RH-iXB731WJZZS			R	IC, PC EDID
IC2304	VHiTL712CPW-1Y	AK		R	IC, TL712CPWR
IC2305	VHiTL712CPW-1Y	AK		R	IC, TL712CPWR
IC2306	VHiTC7W53U/-1Y	AF		R	IC, TC7W53FU(TE12L,F)
IC2307	VHiTC7W00U/-1Y	AE		R	IC, TC7W00FU(TE12L,F)
IC2701	VHiLCX125FT-1Y	AD		R	IC, TC74LCX125FT(EL,K)
IC2704	VHiTC4052BT-1Y	AF		R	IC, TC4052BFT(EL,N,M)
IC3001	RH-iXA992WJZZY	AM		R	IC, M24256-BWMN6TP
IC3002	RH-iXB755WJZZQ	BZ		R	IC, VGC5969B-AD-A3
IC3003	VHiT7WB125A-1Y	AE		R	IC, TC7WBD125AFK(T5L,F)
IC3004	VHiBU4228G+-1Y	AD		R	IC, BU4228G
IC3005	VHiBU4214G+-1Y	AE		R	IC, BU4214G-TR
IC3301	RH-iXB064WJN1Q	BR		R	IC, FRC9429A-XX-B2
IC3501	RH-iXB765WJQZQ	AW		R	IC, K4H561638H-UCB3
IC3502	RH-iXB765WJQZQ	AW		R	IC, K4H561638H-UCB3
IC3503	RH-iXB754WJZZQ	BF		R	IC, M29DW128F70NF6E
IC3504	RH-iXB753WJZZY	AN		R	IC, SN74LVCH16373ADGGR
IC3506	VHiBD3533F+-1Y	AG		R	IC, BD3533F-E2
IC3701	RH-iXB752WJZZQ	BH		R	IC, MSP4410K-QA-D6
IC3702	VHiAK4363VF-1Y	AQ		R	IC, AK4363VF
J2701	QJAKEA073WJZZ	AD		R	Jack, HDMI Input
J2702	QJAKEA073WJZZ	AD		R	Jack, HDMI Input
L1701	RCiLPA212WJZZY	AF		R	Coil
L1702	RCiLPA213WJZZY	AG		R	Coil, Peaking 15µH
L1703	RCiLPA213WJZZY	AG		R	Coil, Peaking 15µH
L1901	RCiLFA134WJZZY	AF		R	Coil
L1902	RCiLFA134WJZZY	AF		R	Coil
L1903	RCiLFA134WJZZY	AF		R	Coil
L1904	RCiLFA134WJZZY	AF		R	Coil
L1905	RCiLFA134WJZZY	AF		R	Coil
L1906	RCiLFA134WJZZY	AF		R	Coil
L1907	RCiLFA134WJZZY	AF		R	Coil
L1908	RCiLFA134WJZZY	AF		R	Coil
L2703	VPCUN1R5MR12NY	AC		R	Coil, Peaking 0.12µH
LUG1701	QLUGHA006WJZZY	AC		R	Lug
LUG1702	QLUGHA006WJZZY	AC		R	Lug
LUG1703	QLUGHA006WJZZY	AC		R	Lug
LUG1704	QLUGHA006WJZZY	AC		R	Lug
LUG1705	QLUGZA002WJZZY	AC		R	Lug
LUG1706	QLUGZA002WJZZY	AC		R	Lug
LUG1707	QLUGZA002WJZZY	AC		R	Lug
LUG1708	QLUGZA002WJZZY	AC		R	Lug
LUG1709	QLUGZA002WJZZY	AC		R	Lug
LUG1710	QLUGZA002WJZZY	AC		R	Lug
P1701	QPLGNA343WJZZY	AD		R	Plug, 9Pin(LB)
P1702	QPLGN1075TAZZY	AD		R	Plug, 10Pin
P2302	QPLGNA338WJZZY	AD		R	Plug, 4Pin(KM)
P2303	QPLGNA347WJZZY	AD		R	Plug, 13Pin(RA)

NO.	PARTS CODE	PRICE RANK	NEW MARK	PART DELIVERY	DESCRIPTION
[9] DUNTKD915FM07 (Main Unit)					
P2304	QSOCNA472WJZZY	AD		R	Connector, 20Pin
P2702	QCNCMA202WJZZY	AK		R	Connector
Q1701	VS2SC3928AR-1Y	AB		R	Transistor, 2SC3928A-T112-1R
Q1702	VS2SA1530AR-1Y	AB		R	Transistor, 2SA1530A-T112-1R
Q1703	VS2SC3928AR-1Y	AB		R	Transistor, 2SC3928A-T112-1R
Q1704	VS2SA1530AR-1Y	AB		R	Transistor, 2SA1530A-T112-1R
Q1706	VSCPH6318+-1Y	AE		R	Transistor, CPH6318-TL-E
Q1901	VS2SK536///-1Y	AE		R	Transistor, 2SK536-TB-E
Q1902	VS2SK536///-1Y	AE		R	Transistor, 2SK536-TB-E
Q1903	VS2SK536///-1Y	AE		R	Transistor, 2SK536-TB-E
Q1904	VS2SK536///-1Y	AE		R	Transistor, 2SK536-TB-E
Q1905	VSDTC144EE/-1Y	AA		R	Transistor, DTC144EETL
Q1906	VSDTC144EE/-1Y	AA		R	Transistor, DTC144EETL
Q1907	VSDTC144EE/-1Y	AA		R	Transistor, DTC144EETL
Q1908	VSDTC144EE/-1Y	AA		R	Transistor, DTC144EETL
Q1909	VSDTC144EE/-1Y	AA		R	Transistor, DTC144EETL
Q1910	VSDTC144EE/-1Y	AA		R	Transistor, DTC144EETL
Q2302	VSDTC144EE/-1Y	AB		R	Transistor, DTC144EETL
Q2303	VSDTC144EE/-1Y	AB		R	Transistor, DTC144EETL
Q2304	VSDTC144EE/-1Y	AA		R	Transistor, DTC144EETL
Q2305	VS2SC3928AR-1Y	AB		R	Transistor, 2SC3928A-T112-1R
Q2306	VS2SA1530AR-1Y	AB		R	Transistor, 2SA1530A-T112-1R
Q2307	VS2SC3928AR-1Y	AB		R	Transistor, 2SC3928A-T112-1R
Q2312	VS2SA1530AR-1Y	AB		R	Transistor, 2SA1530A-T112-1R
Q2313	VS2SA1530AR-1Y	AB		R	Transistor, 2SA1530A-T112-1R
Q2314	VS2SA1530AR-1Y	AB		R	Transistor, 2SA1530A-T112-1R
Q2315	VS2SA1530AR-1Y	AB		R	Transistor, 2SA1530A-T112-1R
Q2701	VS2SC3928AR-1Y	AB		R	Transistor, 2SC3928A-T112-1R
Q2702	VS2SC3928AR-1Y	AB		R	Transistor, 2SC3928A-T112-1R
Q2703	VS2SC3928AR-1Y	AB		R	Transistor, 2SC3928A-T112-1R
Q2704	VS2SC3928AR-1Y	AB		R	Transistor, 2SC3928A-T112-1R
Q2705	VS2SC3928AR-1Y	AB		R	Transistor, 2SC3928A-T112-1R
Q2706	VS2SC3928AR-1Y	AB		R	Transistor, 2SC3928A-T112-1R
Q2707	VSDTC144EE/-1Y	AA		R	Transistor, DTC144EETL
Q2708	VSDTC144EE/-1Y	AA		R	Transistor, DTC144EETL
Q2709	VSSSM3K15FS-1Y	AC		R	Transistor, SSM3K15FS(TE85L,F)
Q2710	VSSSM3K15FS-1Y	AC		R	Transistor, SSM3K15FS(TE85L,F)
Q2711	VS2SC3928AR-1Y	AB		R	Transistor, 2SC3928A-T112-1R
Q2715	VSDTC144EE/-1Y	AA		R	Transistor, DTC144EETL
Q2717	VSDTC144EE/-1Y	AA		R	Transistor, DTC144EETL
Q3001	VSDTC144EE/-1Y	AA		R	Transistor, DTC144EETL
Q3003	VSSSM3K15FS-1Y	AC		R	Transistor, SSM3K15FS(TE85L,F)
Q3004	VSSSM3K15FS-1Y	AC		R	Transistor, SSM3K15FS(TE85L,F)
Q3501	VSDTC144EE/-1Y	AA		R	Transistor, DTC144EETL
Q3702	VSDTC144EE/-1Y	AA		R	Transistor, DTC144EETL
Q3703	VSDTC144EE/-1Y	AA		R	Transistor, DTC144EETL
R1700	VRS-CY1JF101JY	AA		R	Resistor, 100 1/16W Metal Oxide
R1701	VRS-CY1JF562JY	AA		R	Resistor, 5.6k 1/16W Metal Oxide
R1702	VRS-CY1JF103JY	AA		R	Resistor, 10k 1/16W Metal Oxide
R1703	VRS-TW2ED000JY	AB		R	Resistor, 0 1/4W Metal Oxide
R1704	VRS-CY1JF000JY	AA		R	Resistor, 0 1/16W Metal Oxide
R1705	VRS-CY1JF000JY	AA		R	Resistor, 0 1/16W Metal Oxide
R1706	VRS-CZ1JF333JY	AA		R	Resistor, 33k 1/16W Metal Oxide
R1707	VRS-CY1JF000JY	AA		R	Resistor, 0 1/16W Metal Oxide
R1709	VRS-CY1JF103JY	AA		R	Resistor, 10k 1/16W Metal Oxide
R1711	VRS-CY1JF101JY	AA		R	Resistor, 100 1/16W Metal Oxide
R1712	VRS-CY1JF103JY	AA		R	Resistor, 10k 1/16W Metal Oxide
R1714	VRS-CY1JF000JY	AA		R	Resistor, 0 1/16W Metal Oxide
R1715	VRS-CY1JF470JY	AA		R	Resistor, 47 1/16W Metal Oxide
R1716	VRS-CY1JF101JY	AA		R	Resistor, 100 1/16W Metal Oxide
R1717	VRS-CY1JF470JY	AA		R	Resistor, 47 1/16W Metal Oxide
R1718	VRS-CY1JF470JY	AA		R	Resistor, 47 1/16W Metal Oxide
R1719	VRS-CY1JF622FY	AA		R	Resistor, 6.2k 1/16W Metal Oxide
R1720	VRS-CY1JF103JY	AA		R	Resistor, 10k 1/16W Metal Oxide
R1721	VRS-CY1JF203FY	AA		R	Resistor, 20k 1/16W Metal Oxide
R1722	VRS-CY1JF101JY	AA		R	Resistor, 100 1/16W Metal Oxide
R1723	VRS-CY1JF103FY	AA		R	Resistor, 10k 1/16W Metal Oxide
R1725	VRS-CY1JF103JY	AA		R	Resistor, 10k 1/16W Metal Oxide
R1726	VRS-CY1JF511FY	AA		R	Resistor, 510 1/16W Metal Oxide
R1727	VRS-CY1JF101JY	AA		R	Resistor, 100 1/16W Metal Oxide
R1728	VRS-CY1JF332JY	AA		R	Resistor, 3.3k 1/16W Metal Oxide
R1729	VRS-CY1JF202FY	AA		R	Resistor, 2k 1/16W Metal Oxide
R1730	VRS-CY1JF470JY	AA		R	Resistor, 47 1/16W Metal Oxide
R1731	VRS-CY1JF102JY	AA		R	Resistor, 1k 1/16W Metal Oxide
R1732	VRS-CY1JF202FY	AA		R	Resistor, 2k 1/16W Metal Oxide
R1733	VRS-CY1JF104JY	AA		R	Resistor, 100k 1/16W Metal Oxide
R1734	VRS-CY1JF222FY	AA		R	Resistor, 2.2k 1/16W Metal Oxide
R1735	VRS-CY1JF202FY	AA		R	Resistor, 2k 1/16W Metal Oxide
R1736	VRS-CY1JF102JY	AA		R	Resistor, 1k 1/16W Metal Oxide
R1737	VRS-CY1JF272JY	AA		R	Resistor, 2.7k 1/16W Metal Oxide
R1738	VRS-CY1JF104JY	AA		R	Resistor, 100k 1/16W Metal Oxide
R1739	VRS-TW2HF1R0JY	AA		R	Resistor, 1 1/2W Metal Oxide
R1740	VRS-TW2HF1R0JY	AA		R	Resistor, 1 1/2W Metal Oxide
R1741	VRS-TW2HF1R0JY	AA		R	Resistor, 1 1/2W Metal Oxide
R1742	VRS-TW2HF1R0JY	AA		R	Resistor, 1 1/2W Metal Oxide

NO.	PARTS CODE	PRICE RANK	NEW MARK	PART DELIVERY	DESCRIPTION
[9] DUNTKD915FM07 (Main Unit)					
R1743	VRS-CY1 JF 104 JY	AA		R	Resistor, 100k 1/16W Metal Oxide
R1744	VRS-CY1 JF 203 FY	AA		R	Resistor, 20k 1/16W Metal Oxide
R1745	VRS-CY1 JF 132 JY	AG		R	Resistor, 1.3k 1/16W Metal Oxide
R1746	VRS-CY1 JF 202 JY	AA		R	Resistor, 2k 1/16W Metal Oxide
R1747	VRS-CY1 JF 511 FY	AA		R	Resistor, 510 1/16W Metal Oxide
R1748	VRS-CY1 JF 202 FY	AA		R	Resistor, 2k 1/16W Metal Oxide
R1749	VRS-CY1 JF 104 JY	AA		R	Resistor, 100k 1/16W Metal Oxide
R1750	VRS-CY1 JF 470 JY	AA		R	Resistor, 47 1/16W Metal Oxide
R1751	VRS-CY1 JF 104 JY	AA		R	Resistor, 100k 1/16W Metal Oxide
R1753	VRS-CY1 JF 103 FY	AA		R	Resistor, 10k 1/16W Metal Oxide
R1754	VRS-CY1 JF 622 FY	AA		R	Resistor, 6.2k 1/16W Metal Oxide
R1755	VRS-CY1 JF 562 JY	AA		R	Resistor, 5.6k 1/16W Metal Oxide
R1756	VRS-CY1 JF 103 JY	AA		R	Resistor, 10k 1/16W Metal Oxide
R1757	VRS-TW2HF 1R0 JY	AA		R	Resistor, 1 1/2W Metal Oxide
R1758	VRS-TW2HF 1R0 JY	AA		R	Resistor, 1 1/2W Metal Oxide
R1759	VRS-TW2HF 1R0 JY	AA		R	Resistor, 1 1/2W Metal Oxide
R1760	VRS-TW2HF 1R0 JY	AA		R	Resistor, 1 1/2W Metal Oxide
R1761	VRS-CY1 JF 101 JY	AA		R	Resistor, 100 1/16W Metal Oxide
R1762	VRS-CZ1 JF 220 JY	AA		R	Resistor, 22 1/16W Metal Oxide
R1763	VRS-CY1 JF 101 JY	AA		R	Resistor, 100 1/16W Metal Oxide
R1764	VRS-CY1 JF 101 JY	AA		R	Resistor, 100 1/16W Metal Oxide
R1767	VRS-CY1 JF 823 FY	AA		R	Resistor, 82k 1/16W Metal Oxide
R1768	VRS-CY1 JF 103 FY	AA		R	Resistor, 10k 1/16W Metal Oxide
R1769	VRS-CY1 JF 104 JY	AA		R	Resistor, 100k 1/16W Metal Oxide
R1770	VRS-CY1 JF 752 JY	AA		R	Resistor, 7.5k 1/16W Metal Oxide
R1771	VRS-TW2HF 1R0 JY	AA		R	Resistor, 1 1/2W Metal Oxide
R1772	VRS-TW2HF 1R0 JY	AA		R	Resistor, 1 1/2W Metal Oxide
R1773	VRS-CY1 JF 104 JY	AA		R	Resistor, 100k 1/16W Metal Oxide
R1774	VRS-CY1 JF 103 JY	AA		R	Resistor, 10k 1/16W Metal Oxide
R1775	VRS-CY1 JF 104 JY	AA		R	Resistor, 100k 1/16W Metal Oxide
R1776	VRS-CZ1 JF 220 JY	AA		R	Resistor, 22 1/16W Metal Oxide
R1777	VRS-CZ1 JF 220 JY	AA		R	Resistor, 22 1/16W Metal Oxide
R1779	VRS-CY1 JF 123 FY	AA		R	Resistor, 12k 1/16W Metal Oxide
R1780	VRS-CY1 JF 103 JY	AA		R	Resistor, 10k 1/16W Metal Oxide
R1781	VRS-CY1 JF 101 JY	AA		R	Resistor, 100 1/16W Metal Oxide
R1782	VRS-CY1 JF 101 JY	AA		R	Resistor, 100 1/16W Metal Oxide
R1783	VRS-CY1 JF 101 JY	AA		R	Resistor, 100 1/16W Metal Oxide
R1784	VRS-CY1 JF 101 JY	AA		R	Resistor, 100 1/16W Metal Oxide
R1785	VRS-CY1 JF 101 JY	AA		R	Resistor, 100 1/16W Metal Oxide
R1786	VRS-CY1 JF 563 JY	AA		R	Resistor, 56k 1/16W Metal Oxide
R1787	VRS-CY1 JF 101 JY	AA		R	Resistor, 100 1/16W Metal Oxide
R1788	VRS-CY1 JF 101 JY	AA		R	Resistor, 100 1/16W Metal Oxide
R1789	VRS-CY1 JF 101 JY	AA		R	Resistor, 100 1/16W Metal Oxide
R1790	VRS-CY1 JF 101 JY	AA		R	Resistor, 100 1/16W Metal Oxide
R1791	VRS-CY1 JF 101 JY	AA		R	Resistor, 100 1/16W Metal Oxide
R1792	VRS-CY1 JF 101 JY	AA		R	Resistor, 100 1/16W Metal Oxide
R1793	VRS-CY1 JF 101 JY	AA		R	Resistor, 100 1/16W Metal Oxide
R1794	VRS-CY1 JF 101 JY	AA		R	Resistor, 100 1/16W Metal Oxide
R1795	VRS-CY1 JF 101 JY	AA		R	Resistor, 100 1/16W Metal Oxide
R1796	VRS-CY1 JF 101 JY	AA		R	Resistor, 100 1/16W Metal Oxide
R1797	VRS-CY1 JF 101 JY	AA		R	Resistor, 100 1/16W Metal Oxide
R1798	VRS-CY1 JF 101 JY	AA		R	Resistor, 100 1/16W Metal Oxide
R1800	VRS-CZ1 JF 220 JY	AA		R	Resistor, 22 1/16W Metal Oxide
R1804	VRS-CY1 JF 104 JY	AA		R	Resistor, 100k 1/16W Metal Oxide
R1805	VRS-CY1 JF 101 JY	AA		R	Resistor, 100 1/16W Metal Oxide
R1806	VRS-CY1 JF 222 JY	AA		R	Resistor, 2.2k 1/16W Metal Oxide
R1831	VRS-CY1 JF 000 JY	AA		R	Resistor, 0 1/16W Metal Oxide
R1832	VRS-CY1 JF 000 JY	AA		R	Resistor, 0 1/16W Metal Oxide
R1833	VRS-CY1 JF 000 JY	AA		R	Resistor, 0 1/16W Metal Oxide
R1834	VRS-CY1 JF 000 JY	AA		R	Resistor, 0 1/16W Metal Oxide
R1835	VRS-CY1 JF 000 JY	AA		R	Resistor, 0 1/16W Metal Oxide
R1836	VRS-CY1 JF 000 JY	AA		R	Resistor, 0 1/16W Metal Oxide
R1837	VRS-CY1 JF 000 JY	AA		R	Resistor, 0 1/16W Metal Oxide
R1838	VRS-CY1 JF 000 JY	AA		R	Resistor, 0 1/16W Metal Oxide
R1841	VRS-CY1 JF 000 JY	AA		R	Resistor, 0 1/16W Metal Oxide
R1842	VRS-CY1 JF 101 JY	AA		R	Resistor, 100 1/16W Metal Oxide
R1845	VRS-CY1 JF 103 JY	AA		R	Resistor, 10k 1/16W Metal Oxide
R1846	VRS-CY1 JF 104 JY	AA		R	Resistor, 100k 1/16W Metal Oxide
R1847	VRS-CY1 JF 103 JY	AA		R	Resistor, 10k 1/16W Metal Oxide
R1848	VRS-CY1 JF 103 JY	AA		R	Resistor, 10k 1/16W Metal Oxide
R1851	VRS-CY1 JF 000 JY	AA		R	Resistor, 0 1/16W Metal Oxide
R1854	VRS-CY1 JF 562 JY	AA		R	Resistor, 5.6k 1/16W Metal Oxide
R1855	VRS-CY1 JF 000 JY	AA		R	Resistor, 0 1/16W Metal Oxide
R1901	VRS-CY1 JF 272 JY	AA		R	Resistor, 2.7k 1/16W Metal Oxide
R1902	VRS-CY1 JF 272 JY	AA		R	Resistor, 2.7k 1/16W Metal Oxide
R1903	VRS-CY1 JF 152 JY	AA		R	Resistor, 1.5k 1/16W Metal Oxide
R1904	VRS-CY1 JF 152 JY	AA		R	Resistor, 1.5k 1/16W Metal Oxide
R1906	VRS-CY1 JF 473 JY	AA		R	Resistor, 47k 1/16W Metal Oxide
R1908	VRS-CY1 JF 103 JY	AA		R	Resistor, 10k 1/16W Metal Oxide
R1909	VRS-CY1 JF 473 JY	AA		R	Resistor, 47k 1/16W Metal Oxide
R1910	VRS-CY1 JF 103 JY	AA		R	Resistor, 10k 1/16W Metal Oxide
R1911	VRS-CJ1 JF 474 JY	AA		R	Resistor, 470k 1/16W Metal Oxide
R1912	VRS-CJ1 JF 474 JY	AA		R	Resistor, 470k 1/16W Metal Oxide
R1913	VRS-CJ1 JF 473 JY	AB		R	Resistor, 47k 1/16W Metal Oxide
R1914	VRS-CJ1 JF 100 JY	AA		R	Resistor, 10 1/16W Metal Oxide

NO.	PARTS CODE	PRICE RANK	NEW MARK	PART DELIVERY	DESCRIPTION
[9] DUNTKD915FM07 (Main Unit)					
R1915	VRS-CJ1JF473JY	AB		R	Resistor, 47k 1/16W Metal Oxide
R1916	VRS-CJ1JF100JY	AA		R	Resistor, 10 1/16W Metal Oxide
R1917	VRS-CY1JF103JY	AA		R	Resistor, 10k 1/16W Metal Oxide
R1918	VRS-CY1JF103JY	AA		R	Resistor, 10k 1/16W Metal Oxide
R1919	VRS-CY1JF100JY	AA		R	Resistor, 10 1/16W Metal Oxide
R1920	VRS-CH1JF100JY	AA		R	Resistor, 10 1/16W Metal Oxide
R1921	VRS-CH1JF100JY	AA		R	Resistor, 10 1/16W Metal Oxide
R1922	VRS-CH1JF100JY	AA		R	Resistor, 10 1/16W Metal Oxide
R1923	VRS-CH1JF100JY	AA		R	Resistor, 10 1/16W Metal Oxide
R1924	VRS-CH1JF100JY	AA		R	Resistor, 10 1/16W Metal Oxide
R1925	VRS-CH1JF100JY	AA		R	Resistor, 10 1/16W Metal Oxide
R1926	VRS-CY1JF472JY	AA		R	Resistor, 4.7k 1/16W Metal Oxide
R1927	VRS-CH1JF100JY	AA		R	Resistor, 10 1/16W Metal Oxide
R1928	VRS-CY1JF223JY	AA		R	Resistor, 22k 1/16W Metal Oxide
R1929	VRS-CY1JF472JY	AA		R	Resistor, 4.7k 1/16W Metal Oxide
R1930	VRS-CY1JF910FY	AA		R	Resistor, 91 1/16W Metal Oxide
R1931	VRS-CY1JF910FY	AA		R	Resistor, 91 1/16W Metal Oxide
R1932	VRS-CY1JF105JY	AA		R	Resistor, 1M 1/16W Metal Oxide
R1933	VRS-CY1JF152JY	AA		R	Resistor, 1.5k 1/16W Metal Oxide
R1934	VRS-CJ1JF101JY	AA		R	Resistor, 100 1/16W Metal Oxide
R1935	VRS-CZ1JF330JY	AA		R	Resistor, 33 1/16W Metal Oxide
R1937	VRS-CY1JF103JY	AA		R	Resistor, 10k 1/16W Metal Oxide
R1938	VRS-CZ1JF220JY	AA		R	Resistor, 22 1/16W Metal Oxide
R1939	VRS-CZ1JF220JY	AA		R	Resistor, 22 1/16W Metal Oxide
R1940	VRS-CZ1JF220JY	AA		R	Resistor, 22 1/16W Metal Oxide
R1941	VRS-CZ1JF220JY	AA		R	Resistor, 22 1/16W Metal Oxide
R1942	VRS-CZ1JF220JY	AA		R	Resistor, 22 1/16W Metal Oxide
R1943	VRS-CY1JF000JY	AA		R	Resistor, 0 1/16W Metal Oxide
R1944	VRS-CY1JF000JY	AA		R	Resistor, 0 1/16W Metal Oxide
R1945	VRS-CY1JF273JY	AA		R	Resistor, 27k 1/16W Metal Oxide
R2301	VRS-CY1JF000JY	AA		R	Resistor, 0 1/16W Metal Oxide
R2303	VRS-CY1JF000JY	AA		R	Resistor, 0 1/16W Metal Oxide
R2305	VRS-CH1JF103JY	AA		R	Resistor, 10k 1/16W Metal Oxide
R2306	VRS-CY1JF103JY	AA		R	Resistor, 10k 1/16W Metal Oxide
R2307	VRS-CJ1JF101JY	AA		R	Resistor, 100 1/16W Metal Oxide
R2308	VRS-CY1JF104JY	AA		R	Resistor, 100k 1/16W Metal Oxide
R2309	VRS-CZ1JF333JY	AA		R	Resistor, 33k 1/16W Metal Oxide
R2310	VRS-CY1JF103JY	AA		R	Resistor, 10k 1/16W Metal Oxide
R2311	VRS-CY1JF103JY	AA		R	Resistor, 10k 1/16W Metal Oxide
R2315	VRS-CY1JF103JY	AA		R	Resistor, 10k 1/16W Metal Oxide
R2317	VRS-CZ1JF333JY	AA		R	Resistor, 33k 1/16W Metal Oxide
R2318	VRS-CZ1JF333JY	AA		R	Resistor, 33k 1/16W Metal Oxide
R2319	VRS-CY1JF103JY	AA		R	Resistor, 10k 1/16W Metal Oxide
R2320	VRS-CY1JF104JY	AA		R	Resistor, 100k 1/16W Metal Oxide
R2321	VRS-CY1JF101JY	AA		R	Resistor, 100 1/16W Metal Oxide
R2322	VRS-TW2ED750JY	AA		R	Resistor, 75 1/4W Metal Oxide
R2324	VRS-TW2ED750JY	AA		R	Resistor, 75 1/4W Metal Oxide
R2325	VRS-TW2ED750JY	AA		R	Resistor, 75 1/4W Metal Oxide
R2326	VRS-CY1JF102JY	AA		R	Resistor, 1k 1/16W Metal Oxide
R2329	VRS-CY1JF103JY	AA		R	Resistor, 10k 1/16W Metal Oxide
R2330	VRS-CY1JF101JY	AA		R	Resistor, 100 1/16W Metal Oxide
R2331	VRS-CH1JF104JY	AA		R	Resistor, 100k 1/16W Metal Oxide
R2332	VRS-CY1JF473JY	AA		R	Resistor, 47k 1/16W Metal Oxide
R2333	VRS-CH1JF101JY	AA		R	Resistor, 100 1/16W Metal Oxide
R2334	VRS-CY1JF103JY	AA		R	Resistor, 10k 1/16W Metal Oxide
R2335	VRS-CY1JF102JY	AA		R	Resistor, 1k 1/16W Metal Oxide
R2336	VRS-CY1JF222JY	AA		R	Resistor, 2.2k 1/16W Metal Oxide
R2337	VRS-CY1JF103JY	AA		R	Resistor, 10k 1/16W Metal Oxide
R2338	VRS-CY1JF102JY	AA		R	Resistor, 1k 1/16W Metal Oxide
R2339	VRS-CY1JF102FY	AA		R	Resistor, 1k 1/16W Metal Oxide
R2340	VRS-CY1JF392JY	AA		R	Resistor, 3.9k 1/16W Metal Oxide
R2341	VRS-CY1JF393FY	AA		R	Resistor, 39k 1/16W Metal Oxide
R2342	VRS-CY1JF103JY	AA		R	Resistor, 10k 1/16W Metal Oxide
R2343	VRS-CY1JF333JY	AA		R	Resistor, 33k 1/16W Metal Oxide
R2347	VRS-CY1JF222JY	AA		R	Resistor, 2.2k 1/16W Metal Oxide
R2349	VRS-CY1JF271JY	AA		R	Resistor, 270 1/16W Metal Oxide
R2350	VRS-CY1JF561JY	AA		R	Resistor, 560 1/16W Metal Oxide
R2351	VRS-CY1JF222JY	AA		R	Resistor, 2.2k 1/16W Metal Oxide
R2352	VRS-CY1JF102JY	AA		R	Resistor, 1k 1/16W Metal Oxide
R2353	VRS-CY1JF392JY	AA		R	Resistor, 3.9k 1/16W Metal Oxide
R2354	VRS-CY1JF102JY	AA		R	Resistor, 1k 1/16W Metal Oxide
R2355	VRS-CY1JF271JY	AA		R	Resistor, 270 1/16W Metal Oxide
R2356	VRS-CY1JF822JY	AA		R	Resistor, 8.2k 1/16W Metal Oxide
R2357	VRS-CY1JF473JY	AA		R	Resistor, 47k 1/16W Metal Oxide
R2358	VRS-CY1JF221JY	AA		R	Resistor, 220 1/16W Metal Oxide
R2359	VRS-CY1JF151JY	AA		R	Resistor, 150 1/16W Metal Oxide
R2360	VRS-CY1JF473JY	AA		R	Resistor, 47k 1/16W Metal Oxide
R2362	VRS-CY1JF102JY	AA		R	Resistor, 1k 1/16W Metal Oxide
R2363	VRS-CY1JF102JY	AA		R	Resistor, 1k 1/16W Metal Oxide
R2364	VRS-CY1JF101JY	AA		R	Resistor, 100 1/16W Metal Oxide
R2365	VRS-CY1JF470JY	AA		R	Resistor, 47 1/16W Metal Oxide
R2366	VRS-CY1JF221JY	AA		R	Resistor, 220 1/16W Metal Oxide
R2367	VRS-CY1JF000JY	AA		R	Resistor, 0 1/16W Metal Oxide
R2368	VRS-CY1JF221JY	AA		R	Resistor, 220 1/16W Metal Oxide
R2370	VRS-CY1JF000JY	AA		R	Resistor, 0 1/16W Metal Oxide

NO.	PARTS CODE	PRICE RANK	NEW MARK	PART DELIVERY	DESCRIPTION
[9] DUNTKD915FM07 (Main Unit)					
R2371	VRS-CZ1 JF 330 JY	AA		R	Resistor, j33 1/16W Metal Oxide
R2372	VRS-CY1 JF 102 JY	AA		R	Resistor, 1k 1/16W Metal Oxide
R2373	VRS-CY1 JF 000 JY	AA		R	Resistor, 0 1/16W Metal Oxide
R2374	VRS-CY1 JF 102 JY	AA		R	Resistor, 1k 1/16W Metal Oxide
R2375	VRS-CY1 JF 000 JY	AA		R	Resistor, 0 1/16W Metal Oxide
R2376	VRS-CY1 JF 333 JY	AA		R	Resistor, 33k 1/16W Metal Oxide
R2377	VRS-CY1 JF 000 JY	AA		R	Resistor, 0 1/16W Metal Oxide
R2378	VRS-CY1 JF 000 JY	AA		R	Resistor, 0 1/16W Metal Oxide
R2379	VRS-CY1 JF 000 JY	AA		R	Resistor, 0 1/16W Metal Oxide
R2380	VRS-CY1 JF 000 JY	AA		R	Resistor, 0 1/16W Metal Oxide
R2381	VRS-CY1 JF 000 JY	AA		R	Resistor, 0 1/16W Metal Oxide
R2382	VRS-CY1 JF 000 JY	AA		R	Resistor, 0 1/16W Metal Oxide
R2386	VRS-CY1 JF 000 JY	AA		R	Resistor, 0 1/16W Metal Oxide
R2387	VRS-CY1 JF 000 JY	AA		R	Resistor, 0 1/16W Metal Oxide
R2388	VRS-CY1 JF 000 JY	AA		R	Resistor, 0 1/16W Metal Oxide
R2389	VRS-CY1 JF 000 JY	AA		R	Resistor, 0 1/16W Metal Oxide
R2390	VRS-CY1 JF 000 JY	AA		R	Resistor, 0 1/16W Metal Oxide
R2391	VRS-CY1 JF 000 JY	AA		R	Resistor, 0 1/16W Metal Oxide
R2392	VRS-CY1 JF 000 JY	AA		R	Resistor, 0 1/16W Metal Oxide
R2393	VRS-CY1 JF 000 JY	AA		R	Resistor, 0 1/16W Metal Oxide
R2394	VRS-CY1 JF 000 JY	AA		R	Resistor, 0 1/16W Metal Oxide
R2395	VRS-CY1 JF 000 JY	AA		R	Resistor, 0 1/16W Metal Oxide
R2396	VRS-CY1 JF 102 JY	AA		R	Resistor, 1k 1/16W Metal Oxide
R2397	VRS-CY1 JF 102 JY	AA		R	Resistor, 1k 1/16W Metal Oxide
R2398	VRS-CY1 JF 000 JY	AA		R	Resistor, 0 1/16W Metal Oxide
R2415	VRS-CY1 JF 102 JY	AA		R	Resistor, 1k 1/16W Metal Oxide
R2416	VRS-CY1 JF 102 JY	AA		R	Resistor, 1k 1/16W Metal Oxide
R2417	VRS-CY1 JF 102 JY	AA		R	Resistor, 1k 1/16W Metal Oxide
R2702	VRS-CJ1 JF 101 JY	AA		R	Resistor, 100 1/16W Metal Oxide
R2703	VRS-CY1 JF 563 JY	AA		R	Resistor, 56k 1/16W Metal Oxide
R2704	VRS-CY1 JF 470 FY	AA		R	Resistor, 47 1/16W Metal Oxide
R2705	VRS-CY1 JF 101 JY	AA		R	Resistor, 100 1/16W Metal Oxide
R2706	VRS-CJ1 JF 224 JY	AA		R	Resistor, 220k 1/16W Metal Oxide
R2707	VRS-CJ1 JF 224 JY	AA		R	Resistor, 220k 1/16W Metal Oxide
R2708	VRS-CH1 JF 104 JY	AA		R	Resistor, 100k 1/16W Metal Oxide
R2709	VRS-CH1 JF 104 JY	AA		R	Resistor, 100k 1/16W Metal Oxide
R2710	VRS-CJ1 JF 103 JY	AA		R	Resistor, 10k 1/16W Metal Oxide
R2711	VRS-CJ1 JF 103 JY	AA		R	Resistor, 10k 1/16W Metal Oxide
R2712	VRS-CJ1 JF 472 JY	AA		R	Resistor, 4.7k 1/16W Metal Oxide
R2713	VRS-CJ1 JF 472 JY	AA		R	Resistor, 4.7k 1/16W Metal Oxide
R2714	VRS-CY1 JF 123 JY	AA		R	Resistor, 12k 1/16W Metal Oxide
R2715	VRS-CY1 JF 102 JY	AA		R	Resistor, 1k 1/16W Metal Oxide
R2716	VRS-CJ1 JF 103 JY	AA		R	Resistor, 10k 1/16W Metal Oxide
R2717	VRS-CZ1 JF 333 JY	AA		R	Resistor, 33k 1/16W Metal Oxide
R2718	VRS-CY1 JF 000 JY	AA		R	Resistor, 0 1/16W Metal Oxide
R2719	VRS-CY1 JF 102 JY	AA		R	Resistor, 1k 1/16W Metal Oxide
R2720	VRS-CY1 JF 104 JY	AA		R	Resistor, 100k 1/16W Metal Oxide
R2721	VRS-CY1 JF 104 JY	AA		R	Resistor, 100k 1/16W Metal Oxide
R2722	VRS-CY1 JF 000 JY	AA		R	Resistor, 0 1/16W Metal Oxide
R2723	VRS-CY1 JF 000 JY	AA		R	Resistor, 0 1/16W Metal Oxide
R2724	VRS-CY1 JF 000 JY	AA		R	Resistor, 0 1/16W Metal Oxide
R2725	VRS-CY1 JF 000 JY	AA		R	Resistor, 0 1/16W Metal Oxide
R2727	VRS-CY1 JF 000 JY	AA		R	Resistor, 0 1/16W Metal Oxide
R2728	VRS-CY1 JF 000 JY	AA		R	Resistor, 0 1/16W Metal Oxide
R2729	VRS-CY1 JF 000 JY	AA		R	Resistor, 0 1/16W Metal Oxide
R2730	VRS-CY1 JF 000 JY	AA		R	Resistor, 0 1/16W Metal Oxide
R2731	VRS-CY1 JF 000 JY	AA		R	Resistor, 0 1/16W Metal Oxide
R2732	VRS-CY1 JF 000 JY	AA		R	Resistor, 0 1/16W Metal Oxide
R2733	VRS-CY1 JF 000 JY	AA		R	Resistor, 0 1/16W Metal Oxide
R2734	VRS-CY1 JF 000 JY	AA		R	Resistor, 0 1/16W Metal Oxide
R2735	VRS-CY1 JF 000 JY	AA		R	Resistor, 0 1/16W Metal Oxide
R2737	VRS-CY1 JF 104 JY	AA		R	Resistor, 100k 1/16W Metal Oxide
R2738	VRS-CY1 JF 473 JY	AA		R	Resistor, 47k 1/16W Metal Oxide
R2739	VRS-CY1 JF 272 JY	AA		R	Resistor, 2.7k 1/16W Metal Oxide
R2740	VRS-CY1 JF 822 JY	AA		R	Resistor, 8.2k 1/16W Metal Oxide
R2741	VRS-CY1 JF 393 JY	AA		R	Resistor, 39k 1/16W Metal Oxide
R2752	VRS-CY1 JF 472 JY	AA		R	Resistor, 4.7k 1/16W Metal Oxide
R2753	VRS-CY1 JF 472 JY	AA		R	Resistor, 4.7k 1/16W Metal Oxide
R2754	VRS-CY1 JF 103 JY	AA		R	Resistor, 10k 1/16W Metal Oxide
R2755	VRS-CY1 JF 000 JY	AA		R	Resistor, 0 1/16W Metal Oxide
R2756	VRS-CY1 JF 000 JY	AA		R	Resistor, 0 1/16W Metal Oxide
R2758	VRS-CY1 JF 000 JY	AA		R	Resistor, 0 1/16W Metal Oxide
R2771	VRS-CY1 JF 000 JY	AA		R	Resistor, 0 1/16W Metal Oxide
R2776	VRS-CY1 JF 4R7 JY	AA		R	Resistor, 4.7 1/16W Metal Oxide
R3001	VRS-CY1 JF 103 JY	AA		R	Resistor, 10k 1/16W Metal Oxide
R3002	VRS-CZ1 JF 220 JY	AA		R	Resistor, 22 1/16W Metal Oxide
R3003	VRS-CY1 JF 103 JY	AA		R	Resistor, 10k 1/16W Metal Oxide
R3004	VRS-CJ1 JF 101 JY	AA		R	Resistor, 100 1/16W Metal Oxide
R3005	VRS-CJ1 JF 472 JY	AA		R	Resistor, 4.7k 1/16W Metal Oxide
R3006	VRS-CY1 JF 472 JY	AA		R	Resistor, 4.7k 1/16W Metal Oxide
R3007	VRS-CY1 JF 622 FY	AA		R	Resistor, 6.2k 1/16W Metal Oxide
R3008	VRS-CJ1 JF 472 JY	AA		R	Resistor, 4.7k 1/16W Metal Oxide
R3009	VRS-CY1 JF 103 JY	AA		R	Resistor, 10k 1/16W Metal Oxide
R3010	VRS-CY1 JF 472 JY	AA		R	Resistor, 4.7k 1/16W Metal Oxide
R3011	VRS-CY1 JF 104 JY	AA		R	Resistor, 100k 1/16W Metal Oxide

NO.	PARTS CODE	PRICE RANK	NEW MARK	PART DELIVERY	DESCRIPTION
[9] DUNTKD915FM07 (Main Unit)					
R3012	VRS-CY1JF472JY	AA		R	Resistor, 4.7k 1/16W Metal Oxide
R3013	VRS-CY1JF000JY	AA		R	Resistor, 0 1/16W Metal Oxide
R3014	VRS-CY1JF000JY	AA		R	Resistor, 0 1/16W Metal Oxide
R3015	VRS-CY1JF000JY	AA		R	Resistor, 0 1/16W Metal Oxide
R3016	VRS-CY1JF000JY	AA		R	Resistor, 0 1/16W Metal Oxide
R3017	VRS-CY1JF000JY	AA		R	Resistor, 0 1/16W Metal Oxide
R3018	VRS-CY1JF104JY	AA		R	Resistor, 100k 1/16W Metal Oxide
R3019	VRS-CY1JF101JY	AA		R	Resistor, 100 1/16W Metal Oxide
R3021	VRS-CY1JF000JY	AA		R	Resistor, 0 1/16W Metal Oxide
R3022	VRS-CY1JF000JY	AA		R	Resistor, 0 1/16W Metal Oxide
R3024	VRS-CY1JF104JY	AA		R	Resistor, 100k 1/16W Metal Oxide
R3028	VRS-CY1JF104JY	AA		R	Resistor, 100k 1/16W Metal Oxide
R3029	VRS-CY1JF104JY	AA		R	Resistor, 100k 1/16W Metal Oxide
R3030	VRS-CY1JF104JY	AA		R	Resistor, 100k 1/16W Metal Oxide
R3031	VRS-CY1JF104JY	AA		R	Resistor, 100k 1/16W Metal Oxide
R3032	VRS-CY1JF104JY	AA		R	Resistor, 100k 1/16W Metal Oxide
R3033	VRS-CY1JF104JY	AA		R	Resistor, 100k 1/16W Metal Oxide
R3034	VRS-CY1JF000JY	AA		R	Resistor, 0 1/16W Metal Oxide
R3039	VRS-CY1JF473JY	AA		R	Resistor, 47k 1/16W Metal Oxide
R3040	VRS-CY1JF103JY	AA		R	Resistor, 10k 1/16W Metal Oxide
R3041	VRS-CY1JF000JY	AA		R	Resistor, 0 1/16W Metal Oxide
R3044	VRS-CY1JF000JY	AA		R	Resistor, 0 1/16W Metal Oxide
R3045	VRS-CZ1JF680JY	AB		R	Resistor, 68 1/16W Metal Oxide
R3046	VRS-CZ1JF680JY	AB		R	Resistor, 68 1/16W Metal Oxide
R3047	VRS-CZ1JF680JY	AB		R	Resistor, 68 1/16W Metal Oxide
R3048	VRS-CZ1JF680JY	AB		R	Resistor, 68 1/16W Metal Oxide
R3049	VRS-CZ1JF680JY	AB		R	Resistor, 68 1/16W Metal Oxide
R3050	VRS-CZ1JF680JY	AB		R	Resistor, 68 1/16W Metal Oxide
R3051	VRS-CZ1JF680JY	AB		R	Resistor, 68 1/16W Metal Oxide
R3052	VRS-CZ1JF680JY	AB		R	Resistor, 68 1/16W Metal Oxide
R3053	VRS-CZ1JF680JY	AB		R	Resistor, 68 1/16W Metal Oxide
R3054	VRS-CY1JF000JY	AA		R	Resistor, 0 1/16W Metal Oxide
R3055	VRS-CZ1JF101JY	AA		R	Resistor, 100 1/16W Metal Oxide
R3056	VRS-CZ1JF101JY	AA		R	Resistor, 100 1/16W Metal Oxide
R3057	VRS-CZ1JF101JY	AA		R	Resistor, 100 1/16W Metal Oxide
R3058	VRS-CZ1JF101JY	AA		R	Resistor, 100 1/16W Metal Oxide
R3059	VRS-CZ1JF101JY	AA		R	Resistor, 100 1/16W Metal Oxide
R3060	VRS-CZ1JF101JY	AA		R	Resistor, 100 1/16W Metal Oxide
R3061	VRS-CZ1JF101JY	AA		R	Resistor, 100 1/16W Metal Oxide
R3062	VRS-CZ1JF101JY	AA		R	Resistor, 100 1/16W Metal Oxide
R3063	VRS-CZ1JF101JY	AA		R	Resistor, 100 1/16W Metal Oxide
R3064	VRS-CY1JF000JY	AA		R	Resistor, 0 1/16W Metal Oxide
R3069	VRS-CZ1JF000JY	AA		R	Resistor, 0 1/16W Metal Oxide
R3070	VRS-CY1JF000JY	AA		R	Resistor, 0 1/16W Metal Oxide
R3301	VRS-CJ1JF101JY	AA		R	Resistor, 100 1/16W Metal Oxide
R3302	VRS-CY1JF103JY	AA		R	Resistor, 10k 1/16W Metal Oxide
R3303	VRS-CY1JF103JY	AA		R	Resistor, 10k 1/16W Metal Oxide
R3304	VRS-CY1JF103JY	AA		R	Resistor, 10k 1/16W Metal Oxide
R3305	VRS-CY1JF103JY	AA		R	Resistor, 10k 1/16W Metal Oxide
R3306	VRS-CY1JF000JY	AA		R	Resistor, 0 1/16W Metal Oxide
R3307	VRS-CY1JF103JY	AA		R	Resistor, 10k 1/16W Metal Oxide
R3308	VRS-CY1JF103JY	AA		R	Resistor, 10k 1/16W Metal Oxide
R3312	VRS-CY1JF102JY	AA		R	Resistor, 1k 1/16W Metal Oxide
R3313	VRS-CZ1JF101JY	AA		R	Resistor, 100 1/16W Metal Oxide
R3314	VRS-CZ1JF101JY	AA		R	Resistor, 100 1/16W Metal Oxide
R3315	VRS-CZ1JF101JY	AA		R	Resistor, 100 1/16W Metal Oxide
R3316	VRS-CZ1JF101JY	AA		R	Resistor, 100 1/16W Metal Oxide
R3317	VRS-CZ1JF101JY	AA		R	Resistor, 100 1/16W Metal Oxide
R3318	VRS-CZ1JF101JY	AA		R	Resistor, 100 1/16W Metal Oxide
R3319	VRS-CZ1JF101JY	AA		R	Resistor, 100 1/16W Metal Oxide
R3320	VRS-CZ1JF101JY	AA		R	Resistor, 100 1/16W Metal Oxide
R3321	VRS-CZ1JF101JY	AA		R	Resistor, 100 1/16W Metal Oxide
R3501	VRK-CD1J680JY	AC		R	Resistor, 68 1/16W Metal Composition
R3502	VRS-CY1JF470JY	AA		R	Resistor, 47 1/16W Metal Oxide
R3503	VRS-CH1JF220JY	AA		R	Resistor, 22 1/16W Metal Oxide
R3504	VRS-CZ1JF220JY	AA		R	Resistor, 22 1/16W Metal Oxide
R3505	VRS-CZ1JF333JY	AA		R	Resistor, 33k 1/16W Metal Oxide
R3506	VRS-CZ1JF220JY	AA		R	Resistor, 22 1/16W Metal Oxide
R3507	VRS-CZ1JF102JY	AA		R	Resistor, 1k 1/16W Metal Oxide
R3508	VRS-CZ1JF102JY	AA		R	Resistor, 1k 1/16W Metal Oxide
R3509	VRK-CD1J220JY	AC		R	Resistor, 22 1/16W Metal Composition
R3510	VRS-CZ1JF220JY	AA		R	Resistor, 22 1/16W Metal Oxide
R3511	VRS-CZ1JF220JY	AA		R	Resistor, 22 1/16W Metal Oxide
R3512	VRS-CY1JF104JY	AA		R	Resistor, 100k 1/16W Metal Oxide
R3513	VRS-CZ1JF680JY	AB		R	Resistor, 68 1/16W Metal Oxide
R3514	VRS-CY1JF103JY	AA		R	Resistor, 10k 1/16W Metal Oxide
R3515	VRS-CZ1JF680JY	AB		R	Resistor, 68 1/16W Metal Oxide
R3517	VRS-CZ1JF220JY	AA		R	Resistor, 22 1/16W Metal Oxide
R3518	VRK-CD1J680JY	AC		R	Resistor, 68 1/16W Metal Composition
R3519	VRS-CZ1JF220JY	AA		R	Resistor, 22 1/16W Metal Oxide
R3520	VRS-CZ1JF220JY	AA		R	Resistor, 22 1/16W Metal Oxide
R3521	VRS-CY1JF102JY	AA		R	Resistor, 1k 1/16W Metal Oxide
R3524	VRK-CD1J330JY	AC		R	Resistor, 33 1/16W Metal Composition
R3525	VRK-CD1J330JY	AC		R	Resistor, 33 1/16W Metal Composition
R3526	VRK-CD1J330JY	AC		R	Resistor, 33 1/16W Metal Composition

NO.	PARTS CODE	PRICE RANK	NEW MARK	PART DELIVERY	DESCRIPTION
[9] DUNTKD915FM07 (Main Unit)					
R3527	VRK-CD1JJ330JY	AC		R	Resistor, 33 1/16W Metal Composition
R3532	VRS-CZ1JF220JY	AA		R	Resistor, 22 1/16W Metal Oxide
R3533	VRK-CD1JJ151JY	AC		R	Resistor, 150 1/16W Metal Composition
R3534	VRK-CD1JJ151JY	AC		R	Resistor, 150 1/16W Metal Composition
R3535	VRK-CD1JJ151JY	AC		R	Resistor, 150 1/16W Metal Composition
R3536	VRK-CD1JJ151JY	AC		R	Resistor, 150 1/16W Metal Composition
R3537	VRS-CZ1JF333JY	AA		R	Resistor, 33k 1/16W Metal Oxide
R3540	VRS-CZ1JF333JY	AA		R	Resistor, 33k 1/16W Metal Oxide
R3541	VRS-CZ1JF220JY	AA		R	Resistor, 22 1/16W Metal Oxide
R3542	VRK-CD1JJ330JY	AC		R	Resistor, 33 1/16W Metal Composition
R3543	VRK-CD1JJ330JY	AC		R	Resistor, 33 1/16W Metal Composition
R3544	VRK-CD1JJ330JY	AC		R	Resistor, 33 1/16W Metal Composition
R3545	VRK-CD1JJ330JY	AC		R	Resistor, 33 1/16W Metal Composition
R3550	VRS-CZ1JF220JY	AA		R	Resistor, 22 1/16W Metal Oxide
R3551	VRS-CZ1JF330JY	AA		R	Resistor, j33 1/16W Metal Oxide
R3552	VRS-CZ1JF330JY	AA		R	Resistor, j33 1/16W Metal Oxide
R3553	VRS-CZ1JF330JY	AA		R	Resistor, j33 1/16W Metal Oxide
R3554	VRS-CZ1JF330JY	AA		R	Resistor, j33 1/16W Metal Oxide
R3557	VRS-CZ1JF333JY	AA		R	Resistor, 33k 1/16W Metal Oxide
R3559	VRS-CZ1JF333JY	AA		R	Resistor, 33k 1/16W Metal Oxide
R3560	VRS-CY1JF221JY	AA		R	Resistor, 220 1/16W Metal Oxide
R3561	VRS-CY1JF000JY	AA		R	Resistor, 0 1/16W Metal Oxide
R3562	VRS-CZ1JF333JY	AA		R	Resistor, 33k 1/16W Metal Oxide
R3563	VRS-CZ1JF333JY	AA		R	Resistor, 33k 1/16W Metal Oxide
R3564	VRS-CZ1JF333JY	AA		R	Resistor, 33k 1/16W Metal Oxide
R3567	VRS-CY1JF151JY	AA		R	Resistor, 150 1/16W Metal Oxide
R3568	VRS-CY1JF151JY	AA		R	Resistor, 150 1/16W Metal Oxide
R3569	VRS-CY1JF151JY	AA		R	Resistor, 150 1/16W Metal Oxide
R3570	VRS-CY1JF151JY	AA		R	Resistor, 150 1/16W Metal Oxide
R3571	VRS-CZ1JF000JY	AA		R	Resistor, 0 1/16W Metal Oxide
R3575	VRS-CH1JF680JY	AA		R	Resistor, 68 1/16W Metal Oxide
R3580	VRS-CZ1JF330JY	AA		R	Resistor, j33 1/16W Metal Oxide
R3581	VRS-CZ1JF330JY	AA		R	Resistor, j33 1/16W Metal Oxide
R3582	VRS-CZ1JF330JY	AA		R	Resistor, j33 1/16W Metal Oxide
R3583	VRS-CZ1JF330JY	AA		R	Resistor, j33 1/16W Metal Oxide
R3588	VRS-CY1JF151JY	AA		R	Resistor, 150 1/16W Metal Oxide
R3589	VRS-CY1JF151JY	AA		R	Resistor, 150 1/16W Metal Oxide
R3590	VRS-CY1JF151JY	AA		R	Resistor, 150 1/16W Metal Oxide
R3591	VRS-CY1JF151JY	AA		R	Resistor, 150 1/16W Metal Oxide
R3592	VRS-CZ1JF330JY	AA		R	Resistor, j33 1/16W Metal Oxide
R3593	VRS-CZ1JF330JY	AA		R	Resistor, j33 1/16W Metal Oxide
R3594	VRS-CZ1JF330JY	AA		R	Resistor, j33 1/16W Metal Oxide
R3595	VRS-CZ1JF330JY	AA		R	Resistor, j33 1/16W Metal Oxide
R3596	VRS-CY1JF000JY	AA		R	Resistor, 0 1/16W Metal Oxide
R3597	VRS-CY1JF333JY	AA		R	Resistor, 33k 1/16W Metal Oxide
R3701	VRS-CY1JF101JY	AA		R	Resistor, 100 1/16W Metal Oxide
R3702	VRS-CY1JF101JY	AA		R	Resistor, 100 1/16W Metal Oxide
R3703	VRS-CY1JF101JY	AA		R	Resistor, 100 1/16W Metal Oxide
R3704	VRS-CY1JF182JY	AA		R	Resistor, 1.8k 1/16W Metal Oxide
R3705	VRS-CY1JF182JY	AA		R	Resistor, 1.8k 1/16W Metal Oxide
R3706	VRS-CY1JF182JY	AA		R	Resistor, 1.8k 1/16W Metal Oxide
R3708	VRS-CY1JF105JY	AA		R	Resistor, 1M 1/16W Metal Oxide
R3712	VRS-CY1JF000JY	AA		R	Resistor, 0 1/16W Metal Oxide
R3713	VRS-CY1JF000JY	AA		R	Resistor, 0 1/16W Metal Oxide
R3714	VRS-CY1JF000JY	AA		R	Resistor, 0 1/16W Metal Oxide
R3715	VRS-CY1JF000JY	AA		R	Resistor, 0 1/16W Metal Oxide
R3716	VRS-CY1JF101JY	AA		R	Resistor, 100 1/16W Metal Oxide
R3717	VRS-CY1JF101JY	AA		R	Resistor, 100 1/16W Metal Oxide
R3718	VRS-CY1JF101JY	AA		R	Resistor, 100 1/16W Metal Oxide
R3719	VRS-CY1JF101JY	AA		R	Resistor, 100 1/16W Metal Oxide
R3720	VRS-CY1JF101JY	AA		R	Resistor, 100 1/16W Metal Oxide
R3721	VRS-CY1JF101JY	AA		R	Resistor, 100 1/16W Metal Oxide
R3722	VRS-CY1JF101JY	AA		R	Resistor, 100 1/16W Metal Oxide
R3723	VRS-CY1JF101JY	AA		R	Resistor, 100 1/16W Metal Oxide
R3724	VRS-CY1JF101JY	AA		R	Resistor, 100 1/16W Metal Oxide
R3725	VRS-CY1JF101JY	AA		R	Resistor, 100 1/16W Metal Oxide
R3726	VRS-CY1JF101JY	AA		R	Resistor, 100 1/16W Metal Oxide
R3727	VRS-CY1JF101JY	AA		R	Resistor, 100 1/16W Metal Oxide
R3728	VRS-CY1JF101JY	AA		R	Resistor, 100 1/16W Metal Oxide
R3729	VRS-CY1JF101JY	AA		R	Resistor, 100 1/16W Metal Oxide
R3730	VRS-CY1JF101JY	AA		R	Resistor, 100 1/16W Metal Oxide
R3731	VRS-CY1JF101JY	AA		R	Resistor, 100 1/16W Metal Oxide
R3735	VRS-CY1JF332JY	AA		R	Resistor, 3.3k 1/16W Metal Oxide
R3736	VRS-CY1JF332JY	AA		R	Resistor, 3.3k 1/16W Metal Oxide
R3737	VRS-CY1JF332JY	AA		R	Resistor, 3.3k 1/16W Metal Oxide
R3738	VRS-CY1JF103JY	AA		R	Resistor, 10k 1/16W Metal Oxide
R3739	VRS-CY1JF103JY	AA		R	Resistor, 10k 1/16W Metal Oxide
R3740	VRS-CY1JF103JY	AA		R	Resistor, 10k 1/16W Metal Oxide
R3741	VRS-CY1JF000JY	AA		R	Resistor, 0 1/16W Metal Oxide
R3742	VRS-CY1JF101JY	AA		R	Resistor, 100 1/16W Metal Oxide
R3743	VRS-CY1JF470JY	AA		R	Resistor, 47 1/16W Metal Oxide
R3744	VRS-CY1JF470JY	AA		R	Resistor, 47 1/16W Metal Oxide
R3745	VRS-CY1JF512JY	AA		R	Resistor, 5.1k 1/16W Metal Oxide
R3746	VRS-CY1JF101JY	AA		R	Resistor, 100 1/16W Metal Oxide
R3747	VRS-CY1JF101JY	AA		R	Resistor, 100 1/16W Metal Oxide

LC-37XD1E/RU

NO.	PARTS CODE	PRICE RANK	NEW MARK	PART DELIVERY	DESCRIPTION
[9] DUNTKD915FM07 (Main Unit)					
R3748	VRS-CY1 JF000JY	AA		R	Resistor, 0 1/16W Metal Oxide
R3749	VRS-CY1 JF000JY	AA		R	Resistor, 0 1/16W Metal Oxide
R3750	VRS-CY1 JF000JY	AA		R	Resistor, 0 1/16W Metal Oxide
R3751	VRS-CY1 JF103JY	AA		R	Resistor, 10k 1/16W Metal Oxide
R3752	VRS-CY1 JF000JY	AA		R	Resistor, 0 1/16W Metal Oxide
S3001	QSW-K0095CEZZ	AB		R	Switch
S3501	QSW-SA020WJZZY	AE		R	Boot Switch
SC1701	QCNCWA251WJZZY	AH		R	Connector, 23Pin
SC1702	QCNCWA248WJZZY	AD		R	Connector, 9Pin
SC1901	QSOCZA072WJZZQ	AH		R	Socket
SC1902	QSOCZA072WJZZQ	AH		R	Socket
SC2301	QSOCDA036WJZZ	AF		R	Socket, 12Pin
SC2302	QCNCWA507WJQZY	AM		R	Connector, 41Pin
SC2303	QSOCNA229WJZZ	AH		R	Socket, 17Pin
SC2702	QCNCWA251WJZZY	AH		R	Connector, 23Pin
SC2703	QCNCWA251WJZZY	AH		R	Connector, 23Pin
SC2704	QCNCWA251WJZZY	AH		R	Connector, 23Pin
SC2705	QCNCWA010WJZZY	AE		R	Connector, 15Pin
SC2707	QCNCWA251WJZZY	AH		R	Connector, 23Pin
TH3001	VHMH1103J03-1Y	AC		R	Thermistor
TH3003	VRS-CY1 JF000JY	AA		R	Resistor, 0 1/16W Metal Oxide
X1901	RCRSCA108WJZZY	AF		R	Crystal, 28.322MHz
X3001	RCRSC0012CEZZY	AH		R	Crystal, 20.25MHz
X3301	RCRSC0012CEZZY	AH		R	Crystal, 20.25MHz
X3701	RCRSB0250GEZZ+	AG		R	Crystal

NO.	PARTS CODE	PRICE RANK	NEW MARK	PART DELIVERY	DESCRIPTION
[10] CABINET PARTS					
1	CCABAB582WJ01		N	R	Top Cabinet Ass'y
1-1	GCABAB582WJKA		N	R	Top Cabinet
1-2	GCOVAB883WJKA		N	R	Front Cover
1-3	HBDGBA060WJSA			R	SHARP Badge
1-4	HDECQA667WJSA			R	LED Cover
1-5	HDECSA004WJKA		N	R	Shine Trim
1-6	HPNLSA097WJSA		N	R	Speaker Sheet
1-7	PSPAHA933WJZZ		N	R	Mask Spacer (T-B)
1-8	PSPAHA934WJZZ		N	R	Mask Spacer (Side)
1-9	PSPA2B264WJZZ		N	R	Spacer
1-10	QCNW-F099WJQZ		N	R	Connecting Cord (RA:MAIN-RC)
1-11	RCORF0103CEZZ	AK		R	Core (RA Wire)
1-12	XEBS930P10000	AA		R	Screw, x6
1-13	PSPAHB085WJZZ		N	R	Spacer, x2 (for LED-COV) (LC-37XD1F)
2	CCABBA933WJ01		N	R	Rear Cabinet Ass'y
2-1	GCABBA933WJKA		N	R	Rear Cabinet
2-2	PSPAHA850WJZZ			R	Spacer (L), x2
2-3	PSPAHB086WJZZ		N	R	Spacer (S), x2
3	GCOVAB923WJ01			R	Top Control Cover Ass'y
3-1	GCOVAB923WJKA		N	R	Top Control Cover
3-2	JBTN-A615WJKA		N	R	Button, Control
3-3	XEBS930P10000	AA		R	Screw, x2
4	CDAi-A327WJ06			R	Stand Ass'y
4-1	CDAi-A327WJ01			R	Stand Base Ass'y
4-1-1	GDAi-A327WJKA		N	R	Base Cover
4-1-2	LANGKA888WJFW		N	R	Base Angle
4-1-3	PSPAZA949WJZZ			R	Leg Cushion A, x4
4-1-4	PSPAZA950WJZZ			R	Leg Cushion B, x2
4-1-5	XEBS740P10000			R	Screw, x6
4-2	CDAi-A328WJ01			R	Stand Support Ass'y
4-2-1	GCOVAB940WJKA		N	R	Stand Support
4-2-2	GDAi-A328WJSA		N	R	Support Cover
4-2-3	HDECQA600WJKA			R	Screw Guide, x4
4-3	LX-BZA146WJF7	AC		R	Screw, x4 (for Stand)
4-4	LX-BZA147WJF8	AE		R	Screw, x4 (to Set)
5	R1LK370D3LZ1AB		N	J	37" LCD Panel Module Unit
6	DUNTKD604WE21		N	R	AV Unit
7	DUNTKD628WE12		N	R	Digital Unit
8	DUNTKD787WE02		N	R	Power unit
9	DUNTKD833WE06		N	S	Digital Tuner Unit
10	DUNTKD909WE05		N	R	R/C, LED Unit
11	DUNTKD910WE01		N	R	KEY Unit
12	DUNTKD915WE07		N	R	MAIN Unit
13	GCOVAB586WJKA			R	PC Card Cover
14	GCOVAB907WJKA		N	R	Bottom Cover
15	HINDPB972WJSA		N	R	Model Label (LC-37XD1E)
16	LANGFA327WJSA		N	R	Chassis Plate
17	LANGFA330WJFW		N	R	Support Angle
18	LANGKA862WJFW		N	R	LCD Angle (S)
19	LANGKA865WJFW		N	R	LCD Angle (L)
20	LANGTA403WJFW		N	R	Center Angle
21	LANGTA421WJFW		N	R	Stand Angle
22	LCHSMA312WJZZ			R	Chassis Tray
23	LHLDW1033CEKZ	AA		R	Wire Holder
24	LHLDW1173CEZZ	AD		R	Wire Holder for LED/SP, x4
25	LHLDWA043WJKZ	AB		R	Wire Holder for Chassis Tray, x6
26	LHLDWA137WJZZ	AB		R	Wire Holder for LA/RA, x3
27	LHLDWA157WJKZ			R	Rivet, x3
28	LX-BZA052WJFN	AA		R	Screw, x4 (for AV Shield)
29	LX-HZA003WJFN	AC		R	Screw, x4 (for Speaker)
30	PCUSGA023WJKZ		N	R	Cushion
31	PFLT-A048WJZZ		N	R	Gasket, x2
32	PFLT-A072WJZZ			R	Gasket
33	PFLT-A073WJZZ			R	Gasket, x2
34	PFLT-A080WJZZ		N	R	Gasket, x2
35	PMLT-A165WJZZ	AF		R	Absorber
36	PMLT-A360WJZZ			R	Absorber
37	PMLT-A362WJZZ			R	Absorber
38	PMLT-A365WJZZ			R	Absorber
39	PMLT-A385WJZZ			R	Absorber
40	PSLDM685WJZZ			R	Shield
41	PSLDM838WJZZ	AD		R	Shield
42	PSLDMB053WJFW			R	AV Shield Case
43	PSLDMB055WJFW			R	Main Shield
44	PSPAGA344WJZZ	AC		R	Spacer
45	PSPAHB047WJKZ			R	Spacer
46	PSPAZA872WJKZ	AN		R	Spacer
47	QCNW-E599WJQZ			R	Connecting Cord (PL:POW-TCON)
48	QCNW-E601WJQZ			R	Connecting Cord (LA:POW-INV)
49	QCNW-F089WJQZ			R	Connecting Cord (LB:MAIN-INV)
50	QCNW-F102WJQZ		N	R	Connecting Cord (SP:AV-SPR/SPL)
51	QCNW-F164WJQZ		N	R	Connecting Cord (KM:KEY-MAIN)
52	QEARPA212WJFW	AE		R	Earth Plate A
53	RCORF0103CEZZ	AK		R	Core (SP Wire)
54	RCORFA023WJZZ	AK		R	Core (KM Wire)

NO.	PARTS CODE	PRICE RANK	NEW MARK	PART DELIVERY	DESCRIPTION
[10] CABINET PARTS					
55	RSP-ZA203WJZZ		N	S	Speaker (L)
56	RSP-ZA204WJZZ		N	S	Speaker (R)
57	XBBS930P06000	AA		R	Screw, x10
58	XBBS940P06000	AB		R	Screw, x4 (Center Angle)
59	XBPS730P06WS0	AA		R	Screw, x23 (LCD Angle)
60	XBPS830P06000	AA		R	Screw, x2 (HDMI)
61	XEBS930P08000	AA		R	Screw, x3 (SKIRT-RCA FIX)
62	XEBS930P10000	AA		R	Screw, x7 (ANG4 CTR2 CAB1)
63	XEBS940P16000	AB		R	Screw, x13 (Cabinet)
64	XJPS730P04WS0			R	Screw, x3 (TRAYI/PLATE-FIX)
65	XJPS730P08WS0	AA		R	Screw, x25 (PWB)
66	TLABNB415WJZZ			R	No. Label

[11] SUPPLIED ACCESSORIES

Supplied accessories

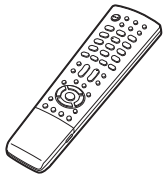
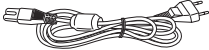
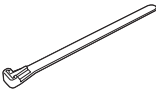
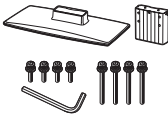
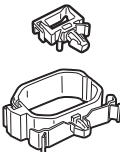
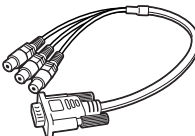
X2 Remote control Unit	X1 AC cord	X5 Cable tie	X16 Stand unit	X4, X6 Cable clamp (Small x 1, Large x 1)	X3 3 RCA to 15-pin D-sub adapter
	 Product shape varies in some countries.				
X9, X10, X11, X12 Operation manual	X13, X15 Guarantee Card	X14 AQUOS Care Plan			

NO.	PARTS CODE	PRICE RANK	NEW MARK	PART DELIVERY	DESCRIPTION
[11] SUPPLIED ACCESSORIES					
X1	QACCKA021WJPZ			R	AC Cord for EUROPE without U.K.
X2	RRMCGA538WJSA		N	S	Remote Control Unit
X3	QCNWGA075WJPZ	AU		R	3 RCA to 15-pin D-sub Adaptor
X4	LHLDWA012WJKZ	AC		R	Wire Holder
X5	LHLDWA083WJ00	AD		R	Cable tie
X6	LHLDWA131WJKZ	AE		R	Cable Clamp
X7	SSAKAA009WJZZ			R	Polyethylene Bag
X8	SSAKAA010WJZZ			R	Polyethylene Bag
X9	TiNS-C723WJZZ		N	R	Operation Manual (English) (LC-37XD1E/K/I/F)
X10	TiNS-C724WJZZ		N	R	Operation Manual (Swedish) (LC-37XD1E)
X11	TiNS-C725WJZZ		N	R	Operation Manual (Polish) (LC-37XD1E)
X12	TiNS-C726WJZZ			R	Operation Manual (Russian) (LC-37XD1RU)
X13	TGAN-A342WJZZ			R	Guarantee Card (LC-37XD1K)
X14	TGAN-A512WJZZ			R	AQUOS Care Plan (LC-37XD1K)
X15	TGAN-A077WJZZ			R	Guarantee Card (LC-37XD1RU)
X16	CDAi-A327WJ06			R	Stand Ass'y

[12] PACKING PARTS

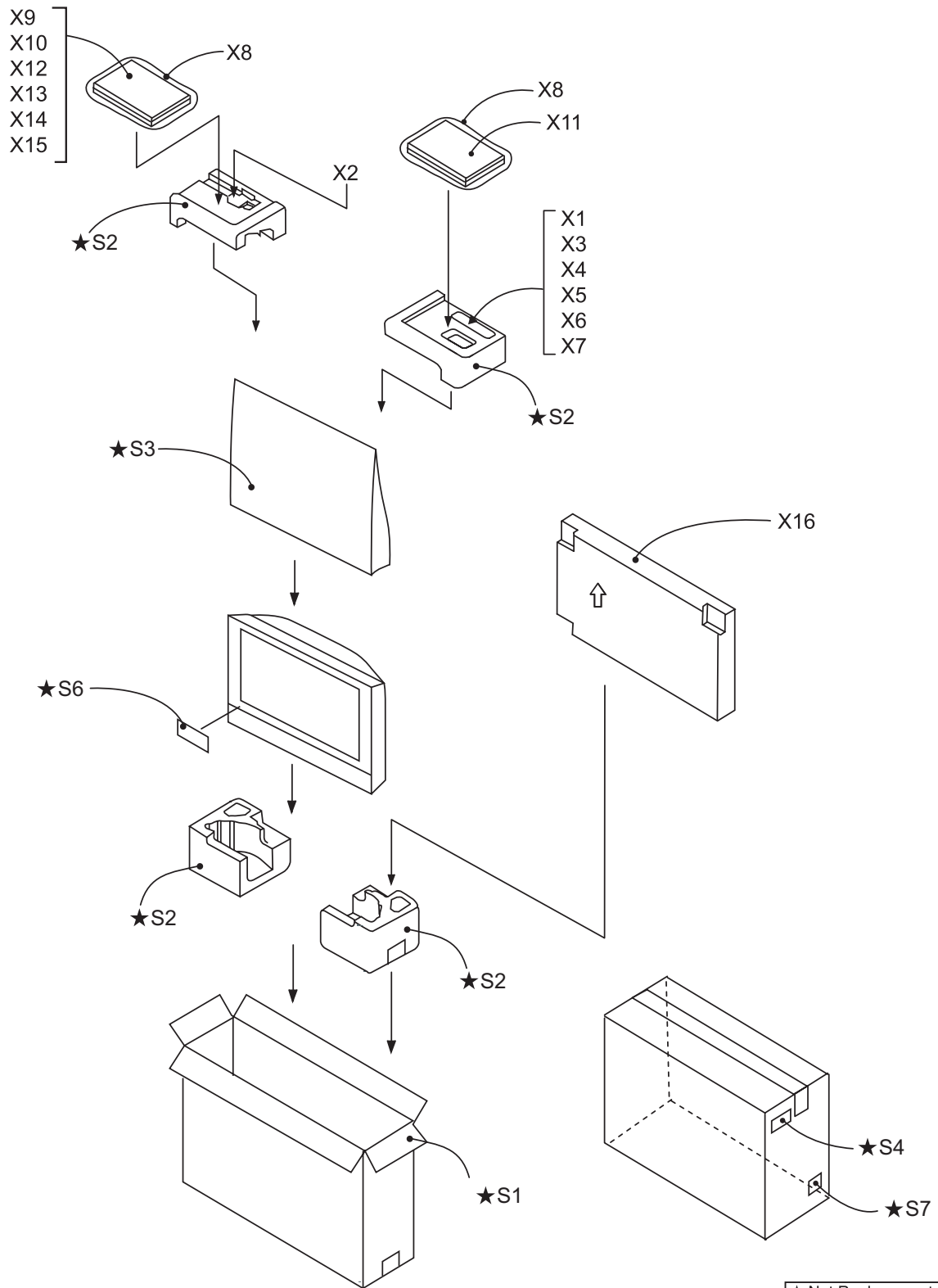

NO.	PARTS CODE	PRICE RANK	NEW MARK	PART DELIVERY	DESCRIPTION
[12] PACKING PARTS					
S1	SPAKCD035WJZZ		N	R	Packing Case (LC-37GX1E/K/I/F)
S1	SPAKCD036WJZZ		N	R	Packing Case (LC-37GX1RU)
S2	SPAKXB270WJZZ		N	R	Buffer Material (Bottom)
S3	SPAKPA338WJZZ	AQ		R	Wrapping Paper
S4	TLABKA002WJZZ			R	Case No. Label
S5	TLABN0134BMZZ			R	SEES No. Label, x2
S6	TLABZB316WJZZ		S	R	POP Label
S7	TLABSA050WJZZ	AF		R	Green Dot Label (LC-37XD1F)
[13] SERVICE JIGS					
N	QCNW-C222WJQZ	AW		R	80pins, x2used, LCD Cont. to LCD Panel Unit
N	QCNW-E687WJQZ			R	14-14pins, Power to Inverter Unit (LA)
N	QCNW-E688WJQZ			R	12pins, Main to Inverter Unit (LB)
N	QCNW-E689WJQZ			R	4-20pins, (PL)
N	QPWBHD965WJQZ			R	41pins (LV)
N	QCNWGA015WJPZ	AK		R	Interface Cable, 9pins, D-sub - Mini DIN, (AN-AIRS)
N	QCNWKA011WJZZ	BH		S	33pins, Digital Unit to Main Unit
N	QCNWKA012WJZZ	BP		S	Digital Software Writing Jig

INDEX

PARTS CODE	No.	PRICE RANK	NEW MARK	PART RANK
[C]				
CCABAB582WJ01	10-1		N	R
CCABBA933WJ01	10-2		N	R
CCOVAB923WJ01	10-3			R
CDAi-A327WJ01	10-4-1			R
CDAi-A327WJ06	10-4			R
"	11-X16			R
CDAi-A328WJ01	10-4-2			R
[D]				
DUNTKD604FM21	1-N		N	R
DUNTKD604WE21	10-6		N	R
DUNTKD628FM12	1-N		N	R
DUNTKD628WE12	10-7		N	R
DUNTKD787FM02	1-N		N	R
DUNTKD787WE02	10-8		N	R
DUNTKD833FM06	1-N		N	S
DUNTKD833WE06	10-9		N	S
DUNTKD909FM05	1-N		N	R
DUNTKD909WE05	10-10		N	R
DUNTKD910FM01	1-N		N	R
DUNTKD910WE01	10-11		N	R
DUNTKD915FM07	1-N		N	R
DUNTKD915WE07	10-12		N	R
[G]				
GCABAB582WJKA	10-1-1		N	R
GCABBA933WJKA	10-2-1		N	R
GCÖVAB586WJKA	10-1-3			R
GCÖVAB883WJKA	10-1-2		N	R
GCÖVAB907WJKA	10-1-4		N	R
GCÖVAB923WJKA	10-3-1		N	R
GCÖVAB940WJKA	10-4-2-1		N	R
GDAi-A327WJKA	10-4-1-1		N	R
GDAi-A328WJKA	10-4-2-2		N	R
[H]				
HBDGBA060WJSA	10-1-3			R
HDECQA600WJKA	10-4-2-3			R
HDECQA667WJSA	10-1-4			R
HDECSA004WJKA	10-1-5		N	R
HINDPB972WJSA	10-1-5		N	R
HPNLSA097WJSA	10-1-6		N	R
[J]				
JBTN-A615WJKA	10-3-2		N	R
[L]				
LANGFA327WJSA	10-16		N	R
LANGFA330WJFW	10-17		N	R
LANGKA862WJFW	10-18		N	R
LANGKA865WJFW	10-19		N	R
LANGKA888WJFW	10-4-1-2		N	R
LANGQA027WJFW	5-E701	AE		R
LANGTA403WJFW	10-20		N	R
LANGTA421WJFW	10-21		N	R
LCHSMA312WJZZ	10-22			R
LHLDW1033CEKZ	10-23	AA		R
LHLDW1173CEZZ	10-24	AD		R
LHLDWA012WJKZ	11-X4	AC		R
LHLDWA043WJKZ	10-25	AB		R
LHLDWA083WJ00	11-X5	AD		R
LHLDWA131WJKZ	11-X6	AE		R
LHLDWA137WJZZ	10-26	AB		R
LHLDWA157WJKZ	10-27			R
LX-BZ3049GEF7	5-N	AA		R
LX-BZA052WJFN	10-28	AA		R
LX-BZA146WJF7	10-4-3	AC		R
LX-BZA147WJF8	10-4-4	AE		R
LX-BZA165WJZZ	5-N	AB		R
LX-HZA003WJFN	10-29	AC		R
[P]				
PCUSGA023WJKZ	10-30		N	R
PFLT-A048WJZZ	10-31		N	R
PFLT-A072WJZZ	10-32			R
PFLT-A073WJZZ	10-33			R
PFLT-A080WJZZ	10-34		N	R
PMLT-A165WJZZ	10-35	AF		R
PMLT-A360WJZZ	10-36			R
PMLT-A362WJZZ	10-37			R
PMLT-A365WJZZ	10-38			R
PMLT-A385WJZZ	10-39			R
PRDARA242WJFW	5-RDA706		N	R
PRDARA306WJFW	5-RDA702	AG	N	R

PARTS CODE	No.	PRICE RANK	NEW MARK	PART RANK
PRDARA308WJFW	5-RDA704	AH	N	R
PRDARA336WJFW	5-RDA701		N	R
PRDARA337WJFW	5-RDA703		N	R
PRDARA367WJFW	5-RDA705		N	R
PSLDM4646CEFW	7-SLD101	AD		R
PSLDMA685WJZZ	10-40			R
PSLDMA688WJZZ	4-N	AE		R
PSLDMA838WJZZ	4-N	AD		R
"	10-41	AD		R
PSLDMA943WJFW	4-N	AK		R
PSLDMB053WJFW	10-42			R
PSLDMB055WJFW	10-43			R
PSLDMB056WJFW	4-N			R
PSPAGA344WJZZ	10-44	AC		R
PSPAHA850WJZZ	10-2-2			R
PSPAHA933WJZZ	10-1-7		N	R
PSPAHA934WJZZ	10-1-8		N	R
PSPAHB047WJKZ	10-45			R
PSPAHB085WJZZ	10-1-13		N	R
PSPAHB086WJZZ	10-2-3		N	R
PSPAZA872WJKZ	10-46	AN		R
PSPAZA949WJZZ	10-4-1-3			R
PSPAZA950WJZZ	10-4-1-4			R
PSPAzb264WJZZ	10-1-9		N	R
[Q]				
QACCKA021WJZZ	11-X1			R
QCNCMA012WJZZ	6-P201	AD		S
QCNCMA199WJSA	4-N	AV		R
QCNCMA202WJZZY	9-P2702	AK		R
QCNCMA247WJZZ	5-P702	AD		R
QCNCMA250WJZZ	3-P1101	AE		R
"	3-P1102	AE		R
"	3-P1201	AE		R
"	5-P701	AE		R
"	6-P202	AE		S
QCNCWA010WJZZY	9-SC2705	AE		R
QCNCWA202WJZZY	4-SC4601	AK		R
QCNCWA248WJZZY	9-SC1702	AD		R
QCNCWA251WJZZY	9-SC1701	AH		R
"	9-SC2702	AH		R
"	9-SC2703	AH		R
"	9-SC2704	AH		R
"	9-SC2707	AH		R
QCNCWA507WJQZY	9-SC2302	AM		R
QCNCW-C222WJQZ	13-N	AW		R
QCNCW-E599WJQZ	10-47			R
QCNCW-E601WJQZ	10-48			R
QCNCW-E687WJQZ	13-N			R
QCNCW-E688WJQZ	13-N			R
QCNCW-E689WJQZ	13-N			R
QCNCW-F089WJQZ	10-49			R
QCNCW-F099WJQZ	10-1-10		N	R
QCNCW-F102WJQZ	10-50		N	R
QCNCW-F164WJQZ	10-51		N	R
QCNCWA015WJJPZ	13-N	AK		R
QCNCWA075WJJPZ	11-X3	AU		R
QCNCWA011WJZZ	13-N	BH		S
QCNCWA012WJZZ	13-N	BP		S
QEARPA212WJFW	10-52	AE		R
QFS-TA005WJZZ	5-F702	AG	S	R
QFS-ZA007WJZZ	5-F701	AC		R
QJAKEA073WJZZ	9-J2701	AD		R
"	9-J2702	AD		R
QJAKJA007WJZZ	3-J1301	AD		R
QJAKZA033WJZZ	3-J1201	AK		R
QLUGHA002WJZZ	5-LUG701	AB		R
"	5-LUG702	AB		R
"	5-LUG703	AB		R
"	5-LUG704	AB		R
"	5-LUG705	AB		R
"	5-LUG706	AB		R
QLUGHA006WJZZY	4-LUG4602	AC		R
"	4-LUG4603	AC		R
"	9-LUG1701	AC		R
"	9-LUG1702	AC		R
"	9-LUG1703	AC		R
"	9-LUG1704	AC		R
QLUGHA009WJZZY	3-LUG301	AC		R
"	3-LUG302	AC		R
"	3-LUG303	AC		R

PARTS CODE	No.	PRICE RANK	NEW MARK	PART RANK	PARTS CODE	No.	PRICE RANK	NEW MARK	PART RANK
"	3-LUG304	AC		R	"	3-FB1106	AB		R
"	4-LUG4601	AC		R	"	3-FB1108	AB		R
"	4-LUG4604	AC		R	"	3-FB1109	AB		R
"	6-LUG201	AC		S	"	3-FB1110	AB		R
"	6-LUG202	AC		S	"	3-FB1203	AB		R
"	6-LUG203	AC		S	"	3-FB1204	AB		R
QLUGZA002WJZZY	9-LUG1705	AC		R	RBLN-0065CEZZY	6-FB202	AC		S
"	9-LUG1706	AC		R	RBLN-0077TAZZY	3-FB1103	AB		R
"	9-LUG1707	AC		R	"	3-FB1104	AB		R
"	9-LUG1708	AC		R	RBLN-0210TAZZY	3-FB1213	AB		R
"	9-LUG1709	AC		R	"	6-FB201	AB		S
"	9-LUG1710	AC		R	"	9-FB1907	AB		R
QPLGN0463TAZZY	4-P4001	AC		R	"	9-FB1909	AB		R
"	4-P4003	AC		R	"	9-FB2303	AB		R
QPLGN1075TAZZY	9-P1702	AD		R	"	9-FB2310	AB		R
QPLGNA043WJZZ	5-P707	AB		R	"	9-FB2715	AB		R
QPLGNA053WJZZ	5-P704	AF		R	"	9-FB2716	AB		R
QPLGNA058WJZZ	8-P151	AC		R	RBLN-0250TAZZY	4-FB4701	AC		R
QPLGNA173WJZZY	3-P301	AD		R	"	9-FB1701	AC		R
QPLGNA333WJZZY	7-P101	AD		R	"	9-FB1702	AC		R
QPLGNA338WJZZY	9-P2302	AD		R	"	9-FB1705	AC		R
QPLGNA343WJZZY	9-P1701	AD		R	"	9-FB1706	AC		R
QPLGNA347WJZZY	9-P2303	AD		R	"	9-FB1707	AC		R
QPLGZ0738CEZZ	5-P703	AC		R	"	9-FB3501	AC		R
QPWBHD965WJQZ	13-N			R	"	9-FB3502	AC		R
QSOCNA008WJZZ	5-SC701	AE		R	"	9-FB3503	AC		R
QSOCDA036WJZZ	9-SC2301	AF		R	RBLN-0254TAZZY	3-FB1218	AB		R
QSOCNA003WJZZY	4-SC4602	AM		R	"	9-FB2701	AB		R
QSOCNA229WJZZ	9-SC2303	AH		R	"	9-FB2702	AB		R
QSOCNA472WJZZY	9-P2304	AD		R	"	9-FB2703	AB		R
QSOCZ0738CEZZ	3-SC301	AE		R	"	9-FB2713	AB		R
QSOCZA072WJZZQ	9-SC1901	AH		R	"	9-FB2714	AB		R
"	9-SC1902	AH		R	"	9-FB3001	AB		R
QSOCZA116WJZZ	3-J1101	AK		R	"	9-FB3002	AB		R
QSW-K0003AJZZ+	8-S151	AB		R	"	9-FB3004	AB		R
"	8-S152	AB		R	"	9-FB3005	AB		R
"	8-S153	AB		R	"	9-FB3006	AB		R
"	8-S154	AB		R	"	9-FB3007	AB		R
"	8-S155	AB		R	"	9-FB3008	AB		R
"	8-S157	AB		R	"	9-FB3009	AB		R
QSW-K0095CEZZ	9-S3001	AB		R	"	9-FB3010	AB		R
QSW-SA020WJZZY	9-S3501	AE		R	"	9-FB3014	AB		R
【 R 】					"	9-FB3301	AB		R
R1LK370D3LZ1AB	2-N		N	J	"	9-FB3302	AB		R
"	10-5		N	J	"	9-FB3303	AB		R
RBLN-0020CEZZ	5-FB706	AB		R	"	9-FB3304	AB		R
"	5-FB708	AB		R	"	9-FB3305	AB		R
"	5-FB709	AB		R	"	9-FB3306	AB		R
"	5-FB710	AB		R	"	9-FB3701	AB		R
RBLN-0020CEZZ+	5-FB702	AB		R	"	9-FB3702	AB		R
RBLN-0051TAZZY	3-FB1105	AC		R	"	9-FB3703	AB		R
"	3-FB1107	AC		R	"	9-FB3705	AB		R
"	3-FB1111	AC		R	RBLN-A007WJZZY	5-FB701	AC		R
"	3-FB1112	AC		R	RBLN-A215WJZZY	4-FB4001	AB		R
"	3-FB1201	AC		R	"	4-FB4002	AB		R
"	3-FB1202	AC		R	"	4-FB4003	AB		R
RBLN-0060TAZZY	6-FB203	AB		S	"	4-FB4004	AB		R
"	9-FB1901	AB		R	"	4-FB4005	AB		R
"	9-FB1902	AB		R	"	4-FB4006	AB		R
"	9-FB1903	AB		R	"	4-FB4007	AB		R
"	9-FB1904	AB		R	"	4-FB4201	AB		R
"	9-FB1905	AB		R	"	4-FB4202	AB		R
"	9-FB1906	AB		R	"	4-FB4401	AB		R
"	9-FB1908	AB		R	"	4-FB4402	AB		R
RBLN-0061TAZZY	9-FB1703	AD		R	"	4-FB4601	AB		R
"	9-FB1704	AD		R	"	4-FB4602	AB		R
"	9-FB2301	AD		R	"	4-FB4603	AB		R
"	9-FB2302	AD		R	RBLN-A303WJZZY	4-FB4008	AB		R
"	9-FB2305	AD		R	"	4-FB4009	AB		R
"	9-FB2306	AD		R	RC-EZA452WJZZ	5-C752	AG		R
"	9-FB2307	AD		R	"	5-C756	AG		R
"	9-FB2308	AD		R	"	5-C768	AG		R
"	9-FB2309	AD		R	RC-EZA480WJZZ	5-C757	AD		R
"	9-FB2705	AD		R	RC-EZA489WJZZ+	5-C723	AC		R
"	9-FB2706	AD		R	"	5-C729	AC		R
"	9-FB2707	AD		R	"	5-C731	AC		R
"	9-FB2708	AD		R	"	5-C735	AC		R
"	9-FB2709	AD		R	"	5-C736	AC		R
"	9-FB2710	AD		R	"	5-C814	AC		R
"	9-FB2711	AD		R	RC-EZA490WJZZ+	5-C758	AD		R
RBLN-0062TAZZY	3-FB1101	AB		R	RC-EZA499WJZZ	5-C744	AH		R
"	3-FB1102	AB		R	"	5-C751	AH		R

LC-37XD1E/RU

PARTS CODE	No.	PRICE RANK	NEW MARK	PART RANK
"	5-C755	AH		R
RC-EZA510WJZZ	5-C754	AF		R
"	5-C767	AF		R
RC-EZA513WJZZ	3-C338	AH		R
"	3-C339	AH		R
"	5-C743	AH		R
"	5-C762	AH		R
RC-EZA813WJZZ	5-C715			R
RC-FZ0010TAZZ	5-C813	AC		R
RC-FZA026WJZZ	5-C704	AE		R
"	5-C712	AE		R
RC-FZA124WJZZ	5-C706	AG		R
RC-FZA126WJZZ	5-C701	AE		R
RCiLCA133WJZZ	5-L704			R
RCiLFA071WJZZY	9-FL2304	AD		R
"	9-FL2305	AD		R
"	9-FL2306	AD		R
"	9-FL2307	AD		R
"	9-FL2308	AD		R
"	9-FL2309	AD		R
"	9-FL2310	AD		R
"	9-FL2311	AD		R
"	9-FL2312	AD		R
"	9-FL2313	AD		R
RCiLFA134WJZZY	9-L1901	AF		R
"	9-L1902	AF		R
"	9-L1903	AF		R
"	9-L1904	AF		R
"	9-L1905	AF		R
"	9-L1906	AF		R
"	9-L1907	AF		R
"	9-L1908	AF		R
RCiLFA225WJZZ	5-L701			R
"	5-L706			R
RCiLPA212WJZZY	9-L1701	AF		R
RCiLPA213WJZZY	9-L1702	AG		R
"	9-L1703	AG		R
RCiLPA214WJZZY	4-L4701	AG		R
RCiLPA386WJZZ	3-L301	AF		R
"	3-L302	AF		R
RCiLPA546WJZZ	5-L703	AH		R
RCiLPA642WJZZ	5-L753	AE		R
RC-KZ0029CEZZ	5-C774	AC		R
"	5-C785	AC		R
RC-KZ0103GEZZ	5-C777	AD		R
"	5-C778	AD		R
"	5-C779	AD		R
"	5-C780	AD		R
RC-KZ0105GEZZ	5-C708	AD		R
"	5-C709	AD		R
"	5-C741	AD		R
RC-KZ0124TAZZY	9-C3529	AC		R
"	9-C3530	AC		R
"	9-C3551	AC		R
"	9-C3567	AC		R
"	9-C3569	AC		R
RC-KZA067WJZZY	9-C3560	AB		R
RC-KZA070WJZZY	4-C4701	AD		R
"	9-C1706	AD		R
"	9-C1726	AD		R
"	9-C1740	AD		R
RC-KZA073WJZZY	3-C361	AD		R
"	3-C1132	AD		R
"	3-C1133	AD		R
"	3-C1136	AD		R
"	3-C1137	AD		R
"	3-C1145	AD		R
"	3-C1146	AD		R
"	3-C1148	AD		R
"	3-C1157	AD		R
"	3-C1158	AD		R
"	3-C1161	AD		R
"	3-C1205	AD		R
"	3-C1208	AD		R
"	3-C1220	AD		R
"	3-C1221	AD		R
"	3-C1222	AD		R
"	3-C1223	AD		R
"	4-C4622	AD		R
"	4-C4709	AD		R
"	4-C4711	AD		R
"	6-C279	AD		S

PARTS CODE	No.	PRICE RANK	NEW MARK	PART RANK
"	9-C1711	AD		R
"	9-C1723	AD		R
"	9-C1724	AD		R
"	9-C1737	AD		R
"	9-C1738	AD		R
"	9-C1755	AD		R
"	9-C1756	AD		R
"	9-C1784	AD		R
"	9-C1910	AD		R
"	9-C1918	AD		R
"	9-C1919	AD		R
"	9-C1921	AD		R
"	9-C1931	AD		R
"	9-C1935	AD		R
"	9-C2321	AD		R
"	9-C2741	AD		R
"	9-C3004	AD		R
"	9-C3006	AD		R
"	9-C3013	AD		R
"	9-C3019	AD		R
"	9-C3024	AD		R
"	9-C3027	AD		R
"	9-C3032	AD		R
"	9-C3036	AD		R
"	9-C3041	AD		R
"	9-C3331	AD		R
"	9-C3332	AD		R
"	9-C3333	AD		R
"	9-C3334	AD		R
"	9-C3521	AD		R
"	9-C3738	AD		R
"	9-C3739	AD		R
"	9-C3741	AD		R
"	9-C3742	AD		R
RC-KZA213WJZZY	5-C776	AC		R
"	5-C783	AC		R
RC-KZA304WJZZ	5-C714	AD		R
"	5-C719	AD		R
"	5-C734	AD		R
"	5-C786	AD		R
"	5-C805	AD		R
RC-KZA388WJZZY	5-C713	AC		R
"	5-C794	AC		R
RC-KZA450WJZZY	5-C791	AD		R
RC-KZA510WJZZY	9-C2329	AB		R
RCORF0103CEZZ	10-53	AK		R
"	10-1-11	AK		R
RCORFA023WJZZ	10-54	AK		R
RCRSB0250GEZZ+	9-X3701	AG		R
RCRSC0012CEZZY	9-X3001	AH		R
"	9-X3301	AH		R
RCRSC0032TAZZY	4-X4001	AG		R
RCRSCA039WJZZY	6-X202	AG		S
RCRSCA108WJZZY	9-X1901	AF		R
RCRUAA075WJZZY	4-X4002	AQ		R
RFiLN0003TAZZY	9-FL2301	AD		R
"	9-FL2302	AD		R
"	9-FL2303	AD		R
RFiLN0017TAZZY	3-FL1101	AC		R
"	3-FL1102	AC		R
"	3-FL1103	AC		R
"	3-FL1104	AC		R
"	3-FL1105	AC		R
"	3-FL1106	AC		R
"	3-FL1107	AC		R
"	3-FL1108	AC		R
"	3-FL1109	AC		R
"	3-FL1110	AC		R
"	3-FL1211	AC		R
"	3-FL1212	AC		R
RH-DX0466CEZZ	5-D758	AE		R
RH-DX0477CEZZ	5-D701	AF		R
RH-DXA070WJZZY	5-D793	AE		R
RH-DXA073WJZZ	5-D709	AM		R
RH-DXA080WJZZ	5-D729	AK		R
"	5-D736	AK		R
RH-DXA081WJZZ	5-D737	AH		R
RH-DXA085WJZZ	5-D739	AK	N	R
RH-DXA088WJZZY	5-D738	AD		R
RH-EX0487CEZZY	9-D1702	AC		R
"	9-D1707	AC		R
RH-EX0646GEZZY	8-D151	AA		R

PARTS CODE	No.	PRICE RANK	NEW MARK	PART RANK	PARTS CODE	No.	PRICE RANK	NEW MARK	PART RANK
"	8-D152	AA		R	RH-iXB742WJZZQ	4-iC4201	AX		R
"	8-D155	AA		R	"	4-iC4202	AX		R
RH-EX1015GEZZY	5-D780	AD		R	RH-iXB752WJZZQ	9-iC3701	BH		R
"	5-D781	AD		R	RH-iXB753WJZZY	9-iC3504	AN		R
RH-EX1026CEZZY	3-D313	AB		R	RH-iXB754WJZZQ	9-iC3503	BF		R
"	3-D1102	AB		R	RH-iXB755WJZZQ	9-iC3002	BZ		R
"	3-D1103	AB		R	RH-iXB765WJQQZ	9-iC3501	AW		R
"	3-D1118	AB		R	"	9-iC3502	AW		R
"	3-D1119	AB		R	RH-iXB921WJZZQ	4-iC4203	AV		R
"	3-D1120	AB		R	RH-iXB946WJZZQ	9-iC1710	AU		R
"	3-D1121	AB		R	RH-PX0421CEZZY	7-D103	AD		R
"	3-D1122	AB		R	"	7-D114	AD		R
"	3-D1123	AB		R	"	7-D115	AD		R
RH-EX1034CEZZY	3-D1106	AB		R	RH-TXA026WJZZY	4-Q4401	AD		R
"	3-D1107	AB		R	"	5-Q730	AD		R
"	3-D1113	AB		R	"	5-Q731	AD		R
"	3-D1114	AB		R	RH-TXA037WJZZY	5-Q723	AE		R
"	3-D1115	AB		R	"	5-Q724	AE		R
"	3-D1116	AB		R	"	5-Q725	AE		R
"	3-D1117	AB		R	RH-VXA071WJQZ	5-VA701	AD		R
RH-EX1049CEZZY	3-D1109	AB		R	"	5-VA702	AD		R
"	3-D1110	AB		R	RR-FZA006WJZZ	5-R719			R
"	3-D1111	AB		R	RR-HZ0008GEZZY	5-R701	AE		R
"	3-D1112	AB		R	"	5-R702	AE		R
RH-EX1064CEZZY	3-D1105	AB		R	"	5-R704	AE		R
"	3-D1108	AB		R	RRLYDA008WJZZ	5-RY701	AG		R
RH-EX1068CEZZY	3-D1101	AB		R	RRMCGA538WJSA	11-X2		N	S
"	3-D1104	AB		R	RRMCGA053WJZZ	7-RMC101	AE		R
RH-EX1234CEZZY	4-D4701	AE		R	RSP-ZA203WJZZ	10-55		N	S
"	5-D770	AE		R	RSP-ZA204WJZZ	10-56		N	S
"	5-D776	AE		R	RTRNWA244WJZZ	5-T702			R
RH-EX1239CEZZY	3-D1201	AB		R	RTRNWA255WJZZ	5-T701			R
RH-EX1247CEZZY	9-D2305	AB		R	RTUNQA034WJZZ	2-TU201			R
"	9-D2306	AB		R					
"	9-D2307	AB		R	【 S 】				
"	9-D2308	AB		R	SPAKCD035WJZZ	12-S1		N	R
"	9-D2313	AB		R	SPAKCD036WJZZ	12-S1		N	R
RH-EX1271CEZZY	9-D2301	AB		R	SPAKPA338WJZZ	12-S3	AQ		R
"	9-D2302	AB		R	SPAKXB270WJZZ	12-S2		N	R
"	9-D2303	AB		R	SSAKAA009WJZZ	11-X7			R
"	9-D2304	AB		R	SSAKAA010WJZZ	11-X8			R
"	9-D2314	AB		R					
"	9-D2315	AB		R	【 T 】				
RH-EX1295CEZZY	3-D314	AB		R	TGAN-A077WJZZ	11-X15			R
"	3-D315	AB		R	TGAN-A342WJZZ	11-X13			R
"	3-D316	AB		R	TGAN-A512WJZZ	11-X14			R
"	3-D317	AB		R	TiNS-C723WJZZ	11-X9		N	R
RH-EX1394CEZZY	5-D763	AB		R	TiNS-C724WJZZ	11-X10		N	R
RH-EX1398CEZZY	5-D741	AB		R	TiNS-C725WJZZ	11-X11		N	R
"	5-D751	AB		R	TiNS-C726WJZZ	11-X12			R
RH-EX1400CEZZY	5-D749	AB		R	TLABKA002WJZZ	12-S4			R
RH-EXA091WJZZY	5-D718	AB		R	TLABN0134BMZZ	12-S5			R
RH-EXA092WJZZY	5-D711	AB		R	TLABNB415WJZZ	10-66			R
"	5-D714	AB		R	TLABSA050WJZZ	12-S7	AF		R
"	7-D101	AB		R	TLABZB316WJZZ	12-S6		S	R
RH-EXA094WJZZY	5-D710	AB		R					
"	5-D748	AB		R	【 V 】				
"	5-D753	AB		R	VCAAPD0JJ227MY	6-C270	AF		S
RH-EXA096WJZZY	5-D721	AB		R	"	6-C273	AF		S
RH-EXA100WJZZY	5-D706			R	VCAAPD1AJ686MY	4-C4420	AE		R
RH-EXA101WJZZY	5-D754	AB		R	"	4-C4707	AE		R
"	5-D756	AB		R	"	9-C1704	AE		R
"	5-D759	AB		R	"	9-C1721	AE		R
RH-EXA102WJZZY	5-D746	AB		R	"	9-C1735	AE		R
"	5-D772	AB		R	"	9-C1744	AE		R
"	6-D202	AB		S	"	9-C1753	AE		R
RH-EXA103WJZZY	3-D311	AB		R	VCCCCY1HH100DY	3-C1204	AA		R
"	3-D312	AB		R	"	3-C1207	AA		R
RH-EXA359WJZZY	5-D778	AE		R	"	4-C4608	AA		R
"	5-D782	AE		R	"	9-C2318	AA		R
"	5-D783	AE		R	VCCCCY1HH101JY	3-C1104	AA		R
RH-FXA003WJZZ	5-D730	AD		R	"	3-C1108	AA		R
"	5-D731	AD		R	"	3-C1117	AA		R
"	5-D732	AD		R	"	3-C1118	AA		R
"	5-D733	AD		R	"	3-C1127	AA		R
"	5-D734	AD		R	"	3-C1128	AA		R
RH-HXA033WJZZ	5-TH701	AG		R	"	3-C1203	AA		R
RH-iXA992WJZZY	9-iC3001	AM		R	"	3-C1206	AA		R
RH-iXB064WJN1Q	9-iC3301	BR		R	"	3-C1210	AA		R
RH-iXB680WJZZQ	4-iC4001	BH		R	"	3-C1216	AA		R
RH-iXB682WJZZQ	6-iC202	AZ		S	"	3-C1224	AA		R
RH-iXB731WJZZS	9-iC2303			R	"	3-C1225	AA		R
					"	5-C722	AA		R
					"	5-C726	AA		R
					"	9-C2702	AA		R

LC-37XD1E/RU

PARTS CODE	No.	PRICE RANK	NEW MARK	PART RANK
"	9-C2703	AA		R
"	9-C2704	AA		R
"	9-C2705	AA		R
"	9-C2713	AA		R
"	9-C3012	AA		R
"	9-C3017	AA		R
"	9-C3022	AA		R
"	9-C3040	AA		R
"	9-C3046	AA		R
"	9-C3048	AA		R
"	9-C3050	AA		R
"	9-C3339	AA		R
"	9-C3341	AA		R
"	9-C3343	AA		R
"	9-C3525	AA		R
"	9-C3526	AA		R
"	9-C3528	AA		R
"	9-C3531	AA		R
"	9-C3727	AA		R
"	9-C3728	AA		R
"	9-C3729	AA		R
"	9-C3730	AA		R
"	9-C3731	AA		R
"	9-C3732	AA		R
"	9-C3733	AA		R
"	9-C3734	AA		R
"	9-C3743	AA		R
"	9-C3744	AA		R
VCCCCY1HH102JY	5-C739	AB		R
"	9-C1773	AB		R
VCCCCY1HH120JY	9-C1929	AA		R
"	9-C1934	AA		R
VCCCCY1HH150JY	4-C4007	AA		R
"	6-C235	AA		S
"	6-C260	AA		S
"	9-C3034	AA		R
VCCCCY1HH180JY	4-C4006	AA		R
"	9-C3039	AA		R
VCCCCY1HH181JY	9-C2710	AA		R
VCCCCY1HH220JY	6-C202	AA		S
"	6-C203	AA		S
"	9-C1743	AA		R
"	9-C3315	AA		R
"	9-C3318	AA		R
VCCCCY1HH2R0CY	6-C259	AA		S
VCCCCY1HH330JY	3-C316	AA		R
"	3-C317	AA		R
"	4-C4611	AA		R
"	4-C4612	AA		R
"	4-C4613	AA		R
"	9-C2312	AA		R
"	9-C2315	AA		R
VCCCCY1HH331JY	9-C3719	AA		R
"	9-C3720	AA		R
"	9-C3721	AA		R
"	9-C3722	AA		R
"	9-C3723	AA		R
"	9-C3724	AA		R
"	9-C3725	AA		R
"	9-C3726	AA		R
VCCCCY1HH470JY	3-C318	AA		R
"	3-C319	AA		R
"	4-C4607	AA		R
"	4-C4610	AA		R
"	9-C2701	AA		R
VCCCCY1HH471JY	9-C2322	AA		R
"	9-C2323	AA		R
"	9-C2330	AA		R
"	9-C2711	AA		R
"	9-C3712	AA		R
VCCCCY1HH560JY	9-C1745	AB		R
"	9-C1767	AB		R
"	9-C1768	AB		R
"	9-C3714	AB		R
"	9-C3715	AB		R
"	9-C3716	AB		R
VCCCCY1HH5R0CY	9-C3717	AA		R
VCCCCY1HH6R0DY	4-C4614	AA		R
"	4-C4615	AA		R
"	4-C4616	AA		R
"	9-C3718	AA		R
VCCCCY1HH820JY	4-C4617	AA		R

PARTS CODE	No.	PRICE RANK	NEW MARK	PART RANK
"	4-C4618	AA		R
"	4-C4619	AA		R
VCCCCZ1HH101JY	9-C3537	AB		R
VCEASX0JN108MY	6-C204	AE		S
VCEASX0JN226MY	4-C4717	AB		R
"	6-C244	AB		S
VCEASX0JN227MY	9-C3532	AC		R
VCEASX0JN476MY	4-C4030	AC		R
"	4-C4715	AC		R
"	9-C1746	AC		R
"	9-C1747	AC		R
VCEASX1AN336MY	6-C241	AC		S
VCEASX1CN106MY	4-C4008	AC		R
"	4-C4019	AC		R
"	4-C4032	AC		R
"	4-C4201	AC		R
"	4-C4203	AC		R
"	4-C4401	AC		R
"	4-C4412	AC		R
"	4-C4606	AC		R
"	4-C4623	AC		R
"	4-C4625	AC		R
"	4-C4634	AC		R
"	4-C4635	AC		R
"	4-C4639	AC		R
"	4-C4640	AC		R
"	4-C4641	AC		R
"	6-C242	AC		S
"	6-C246	AC		S
"	6-C247	AC		S
"	6-C249	AC		S
"	6-C252	AC		S
"	6-C261	AC		S
"	7-C104	AC		R
"	9-C2306	AC		R
"	9-C2714	AC		R
"	9-C3704	AC		R
"	9-C3705	AC		R
"	9-C3711	AC		R
VCEASX1CN107MY	3-C1251	AC		R
"	6-C206	AC		S
VCEASX1CN226MY	3-C311	AC		R
"	9-C1716	AC		R
"	9-C1720	AC		R
"	9-C1733	AC		R
"	9-C1765	AC		R
"	9-C1766	AC		R
VCEASX1HN105MY	3-C346	AB		R
"	3-C347	AB		R
"	4-C4001	AB		R
"	9-C2706	AB		R
"	9-C2707	AB		R
"	9-C2708	AB		R
"	9-C2709	AB		R
VCEASX1HN106MY	3-C324	AC		R
"	3-C325	AC		R
"	3-C358	AC		R
"	3-C359	AC		R
"	6-C212	AC		S
"	6-C230	AC		S
VCEASX1HN225MY	3-C306	AB		R
"	3-C307	AB		R
"	3-C320	AB		R
"	3-C321	AB		R
"	3-C328	AB		R
"	3-C329	AB		R
"	6-C237	AB		S
VCEASX1HN335MY	9-C3708	AB		R
VCEASX1VN226MY	3-C348	AC		R
"	3-C349	AC		R
"	9-C1715	AC		R
VCEASY1CN107MY	7-C107	AC		R
"	9-C3702	AC		R
"	9-C3706	AC		R
"	9-C3713	AC		R
VCEASY1CN476MY	3-C360	AC		R
"	3-C1219	AC		R
"	4-C4710	AC		R
"	9-C3335	AC		R
"	9-C3336	AC		R
VCEASY1CN477MY	3-C364	AD		R
"	3-C1130	AD		R

LC-37XD1E/RU

PARTS CODE	No.	PRICE RANK	NEW MARK	PART RANK
"	9-C3312	AA		R
"	9-C3313	AA		R
"	9-C3314	AA		R
"	9-C3316	AA		R
"	9-C3317	AA		R
"	9-C3319	AA		R
"	9-C3320	AA		R
"	9-C3321	AA		R
"	9-C3322	AA		R
"	9-C3323	AA		R
"	9-C3324	AA		R
"	9-C3325	AA		R
"	9-C3326	AA		R
"	9-C3327	AA		R
"	9-C3328	AA		R
"	9-C3329	AA		R
"	9-C3330	AA		R
"	9-C3701	AA		R
"	9-C3707	AA		R
"	9-C3709	AA		R
"	9-C3710	AA		R
"	9-C3735	AA		R
"	9-C3736	AA		R
"	9-C3737	AA		R
VCKYCY1HB102KY	3-C354	AA		R
"	3-C355	AA		R
"	3-C1119	AA		R
"	3-C1120	AA		R
"	3-C1134	AA		R
"	3-C1135	AA		R
"	3-C1201	AA		R
"	3-C1211	AA		R
"	3-C1217	AA		R
"	5-C711	AA		R
"	5-C775	AA		R
"	6-C209	AA		S
"	6-C233	AA		S
"	6-C272	AA		S
"	9-C1912	AA		R
"	9-C1913	AA		R
"	9-C1916	AA		R
"	9-C1917	AA		R
"	9-C1923	AA		R
"	9-C1924	AA		R
"	9-C1927	AA		R
"	9-C1930	AA		R
"	9-C1936	AA		R
"	9-C1941	AA		R
"	9-C1943	AA		R
"	9-C1946	AA		R
"	9-C1948	AA		R
"	9-C1955	AA		R
"	9-C1956	AA		R
"	9-C1960	AA		R
"	9-C1965	AA		R
"	9-C1967	AA		R
"	9-C1968	AA		R
"	9-C1969	AA		R
"	9-C1971	AA		R
"	9-C1973	AA		R
"	9-C1974	AA		R
"	9-C1975	AA		R
"	9-C3018	AA		R
"	9-C3023	AA		R
"	9-C3037	AA		R
"	9-C3038	AA		R
"	9-C3042	AA		R
"	9-C3047	AA		R
"	9-C3049	AA		R
"	9-C3337	AA		R
"	9-C3338	AA		R
"	9-C3340	AA		R
"	9-C3342	AA		R
"	9-C3522	AA		R
"	9-C3527	AA		R
"	9-C3563	AA		R
VCKYCY1HB103KY	3-C350	AA		R
"	3-C351	AA		R
"	3-C352	AA		R
"	3-C353	AA		R
"	4-C4002	AA		R
"	4-C4005	AA		R

PARTS CODE	No.	PRICE RANK	NEW MARK	PART RANK
"	4-C4009	AA		R
"	4-C4013	AA		R
"	4-C4016	AA		R
"	4-C4029	AA		R
"	4-C4204	AA		R
"	4-C4206	AA		R
"	5-C721	AA		R
"	6-C257	AA		S
"	6-C258	AA		S
"	9-C1702	AA		R
"	9-C1769	AA		R
"	9-C1770	AA		R
"	9-C1771	AA		R
"	9-C1783	AA		R
"	9-C1928	AA		R
"	9-C3002	AA		R
"	9-C3008	AA		R
"	9-C3043	AA		R
"	9-C3044	AA		R
"	9-C3045	AA		R
"	9-C3703	AA		R
VCKYCY1HB104KY	3-C305	AA		R
"	3-C308	AA		R
"	4-C4636	AA		R
"	4-C4637	AA		R
"	4-C4638	AA		R
"	5-C716	AA		R
"	5-C717	AA		R
"	5-C720	AA		R
"	5-C730	AA		R
"	5-C732	AA		R
"	5-C750	AA		R
"	5-C763	AA		R
"	5-C764	AA		R
"	5-C765	AA		R
"	5-C772	AA		R
"	5-C789	AA		R
"	5-C790	AA		R
"	5-C831	AA		R
"	5-C832	AA		R
"	9-C2308	AA		R
"	9-C2309	AA		R
"	9-C2310	AA		R
"	9-C3014	AA		R
VCKYCY1HB152KY	4-C4705	AA		R
VCKYCY1HB153KY	3-C314	AA		R
"	3-C315	AA		R
"	3-C326	AA		R
"	3-C327	AA		R
VCKYCY1HB221KY	3-C332	AA		R
"	3-C333	AA		R
"	3-C334	AA		R
"	3-C335	AA		R
"	3-C1114	AA		R
"	3-C1116	AA		R
"	9-C1772	AA		R
"	9-C2725	AA		R
VCKYCY1HB222KY	3-C309	AA		R
"	3-C310	AA		R
"	3-C312	AA		R
"	3-C313	AA		R
"	3-C365	AA		R
"	3-C366	AA		R
"	5-C707	AA		R
"	5-C733	AA		R
"	9-C1751	AA		R
VCKYCY1HB223KY	5-C803	AA		R
VCKYCY1HB272KY	5-C771	AA		R
VCKYCY1HB331KY	3-C1122	AA		R
"	3-C1123	AA		R
"	3-C1139	AA		R
"	3-C1140	AA		R
VCKYCY1HB332KY	4-C4627	AA		R
"	4-C4628	AA		R
"	4-C4632	AA		R
"	4-C4633	AA		R
"	5-C728	AA		R
"	9-C1730	AA		R
VCKYCY1HB333KY	5-C702	AA		R
VCKYCY1HB392KY	3-C301	AA		R
"	3-C302	AA		R
VCKYCY1HB471KY	3-C1125	AA		R

PARTS CODE	No.	PRICE RANK	NEW MARK	PART RANK	PARTS CODE	No.	PRICE RANK	NEW MARK	PART RANK
"	3-C1126	AA		R	"	3-C1252	AC		R
"	3-C1143	AA		R	"	4-C4702	AC		R
"	3-C1144	AA		R	"	9-C1708	AC		R
VCKYCY1HB472KY	5-C745	AA		R	"	9-C1728	AC		R
VCKYCY1HB682KY	9-C1717	AA		R	"	9-C1748	AC		R
VCKYCY1HF103ZY	3-C1131	AA		R	"	9-C3568	AC		R
"	3-C1159	AA		R	VCKYTV1CF225ZY	7-C102	AB		R
"	3-C1202	AA		R	VCKYTV1EB104KY	3-C1101	AB		R
"	6-C205	AA		S	"	3-C1102	AB		R
"	6-C207	AA		S	"	3-C1103	AB		R
"	6-C211	AA		S	"	3-C1105	AB		R
"	6-C222	AA		S	"	3-C1106	AB		R
"	6-C227	AA		S	"	3-C1107	AB		R
"	6-C236	AA		S	"	9-C2726	AB		R
"	6-C248	AA		S	VCKYTV1EB224KY	3-C340	AA		R
"	6-C250	AA		S	"	3-C341	AA		R
"	6-C251	AA		S	"	3-C362	AA		R
"	6-C253	AA		S	"	3-C363	AA		R
"	6-C254	AA		S	VCKYTV1EB474KY	5-C703	AC		R
"	6-C266	AA		S	VCKYTV1HB102KY	5-C710	AA		R
"	6-C267	AA		S	VCKYTV1HB103KY	9-C2740	AA		R
"	6-C271	AA		S	VCKYTV1HB683KY	5-C749	AB		R
"	7-C105	AA		R	"	5-C753	AB		R
VCKYCY1HF224ZY	3-C303	AA		R	VHD1SS226//-1Y	9-D2310	AC		R
"	3-C304	AA		R	"	9-D2311	AC		R
"	3-C322	AA		R	"	9-D2312	AC		R
"	3-C323	AA		R	VHD1SS352//-1Y	4-D4703	AB		R
"	9-C3740	AA		R	"	5-D702	AB		R
VCKYCZ1CF104ZY	9-C3501	AA		R	"	5-D703	AB		R
"	9-C3502	AA		R	"	5-D707	AB		R
"	9-C3503	AA		R	"	5-D713	AB		R
"	9-C3504	AA		R	"	5-D719	AB		R
"	9-C3505	AA		R	"	5-D722	AB		R
"	9-C3506	AA		R	"	5-D723	AB		R
"	9-C3507	AA		R	"	5-D740	AB		R
"	9-C3508	AA		R	"	5-D742	AB		R
"	9-C3509	AA		R	"	5-D747	AB		R
"	9-C3510	AA		R	"	5-D752	AB		R
"	9-C3511	AA		R	"	5-D755	AB		R
"	9-C3512	AA		R	"	5-D757	AB		R
"	9-C3513	AA		R	"	5-D764	AB		R
"	9-C3514	AA		R	"	5-D765	AB		R
"	9-C3515	AA		R	"	5-D767	AB		R
"	9-C3516	AA		R	"	5-D771	AB		R
"	9-C3517	AA		R	"	5-D773	AB		R
"	9-C3518	AA		R	"	5-D774	AB		R
"	9-C3519	AA		R	"	5-D775	AB		R
"	9-C3520	AA		R	"	5-D779	AB		R
"	9-C3533	AA		R	"	5-D784	AB		R
"	9-C3534	AA		R	"	9-D1703	AB		R
"	9-C3535	AA		R	"	9-D1705	AB		R
"	9-C3536	AA		R	"	9-D1706	AB		R
"	9-C3538	AA		R	"	9-D1903	AB		R
"	9-C3539	AA		R	"	9-D1904	AB		R
"	9-C3540	AA		R	"	9-D1905	AB		R
"	9-C3541	AA		R	"	9-D1906	AB		R
"	9-C3542	AA		R	VHD1SS355//-1Y	5-D728	AB		R
"	9-C3543	AA		R	VHD1SS390+/-1Y	3-D306	AB		R
"	9-C3544	AA		R	"	3-D307	AB		R
"	9-C3545	AA		R	"	3-D308	AB		R
"	9-C3546	AA		R	"	3-D309	AB		R
"	9-C3547	AA		R	"	3-D310	AB		R
"	9-C3548	AA		R	"	3-D318	AB		R
"	9-C3549	AA		R	"	9-D2707	AB		R
"	9-C3550	AA		R	VHDD1FL20U/-1Y	5-D708	AC		R
"	9-C3552	AA		R	"	5-D715	AC		R
"	9-C3553	AA		R	"	5-D717	AC		R
"	9-C3554	AA		R	"	5-D724	AC		R
"	9-C3555	AA		R	"	5-D725	AC		R
"	9-C3556	AA		R	"	5-D726	AC		R
"	9-C3557	AA		R	"	5-D761	AC		R
"	9-C3558	AA		R	VHDDAN202K/-1Y	9-D1901	AB		R
"	9-C3559	AA		R	"	9-D1902	AB		R
VCKYCZ1HB102KY	9-C3564	AB		R	"	9-D2309	AB		R
VCKYTV1CB105KY	3-C1109	AD		R	VHDL1114+++/-1Y	5-D704	AC		R
"	3-C1110	AD		R	VHDB160M40-1Y	5-D705	AC		R
"	3-C1121	AC		R	"	5-D744	AC		R
"	3-C1124	AC		R	VHDB520S30-1Y	9-D1913	AC		R
"	3-C1138	AC		R	VHDSF6L20U+-1	5-D735	AG		R
"	3-C1142	AC		R	VHDSFPA73//2EY	4-D4702	AD		R
"	3-C1212	AC		R	VHDTCCMS01+-1Y	9-D1704	AE		R
"	3-C1218	AC		R	"	9-D1708	AE		R

LC-37XD1E/RU

PARTS CODE	No.	PRICE RANK	NEW MARK	PART RANK
"/	9-D1709	AE		R
VH DU05NU44+-1Y	5-D712	AE		R
"/	5-D716	AE		R
"/	5-D720	AE		R
"/	5-D743	AE		R
"/	5-D768	AE		R
"/	5-D769	AE		R
VH HM1103J03-1Y	9-TH3001	AC		R
VH i24LC2BiN-1Y	9-iC1902			R
VH i24LC2BiNQES	9-iC1901			R
VH iAK4363VF-1Y	9-iC3702	AQ		R
VH iBD3533F+-1Y	9-iC3506	AG		R
VH iBR24L64F-1Y	4-iC4204	AK		R
VH iBU4214G+-1Y	9-iC3005	AE		R
VH iBU4228G+-1Y	4-iC4003	AD		R
"/	9-iC3004	AD		R
VH iBU4239G+-1Y	9-iC1701	AE		R
VH iFA5501AN-1Y	5-iC701	AQ		R
VH iHA17431G-1Y	5-iC706		N	R
VH iICL3225E-1Y	9-iC2301	AN		R
VH iLCX125FT-1Y	9-iC2701	AD		R
VH iLCX244FT-1Y	4-iC4404	AE		R
VH iLCX573FT-1Y	4-iC4402	AF		R
"/	4-iC4405	AF		R
VH iLV4053FT-1Y	6-iC204	AE		S
VH iMM1506XN-1Y	3-iC1101	AD		R
"/	3-iC1102	AD		R
VH iMM1507XN-1Y	3-iC1201	AD		R
VH iMM3033E+-1Y	6-iC206	AD		S
VH iMP1410ES-1Y	9-iC1708	AP		R
"/	9-iC1712	AP		R
VH iMP1583+-1Y	4-iC4701	AH		R
"/	9-iC1706	AH		R
VH iMR4020+-1	5-iC705	AQ		R
VH iMR4040+-1	5-iC704			R
VH iNJM2902V-1Y	5-iC708	AD	S	R
VH iNJM2903M-1Y	5-iC709	AE		R
VH iNJM4558M-1Y	3-iC303	AD		R
VH iPQ018ENA-1Y	4-iC4704	AF		R
VH iPQ12RDA2-1S	5-iC713		N	R
VH iPQ1M185M-1Y	6-iC205	AD		S
VH iPQ1R50/-1Y	9-iC1705	AF		R
VH iPQ20WZ11-1Y	9-iC1702	AF		R
"/	9-iC1703	AF		R
"/	9-iC1707	AF		R
VH iPST3646N-1Y	5-iC710	AE		R
VH iSi19023+-1Q	9-iC1905	BD		R
VH iT7WB125A-1Y	6-iC201	AE		S
"/	9-iC3003	AE		R
VH iTA76431R-1Y	5-iC707	AE		R
VH iTC4052BT-1Y	9-iC2704	AF		R
VH iTC7SH02U1EY	4-iC4408		N	R
VH iTC7SH08U-1Y	4-iC4002	AF		R
"/	4-iC4403	AF		R
VH iTC7SH32U1EY	4-iC4406			R
"/	4-iC4407			R
VH iTC7SHU04-1Y	4-iC4005		N	R
VH iTC7W00U/-1Y	9-iC2307	AE		R
VH iTC7W53U/-1Y	9-iC2306	AF		R
VH iTCLCX245-2Y	4-iC4401	AE		R
VH iTDA8931T-1Y	3-iC301	AS		R
"/	3-iC302	AS		R
VH iTL712CPW-1Y	9-iC2304	AK		R
"/	9-iC2305	AK		R
VH iTPS850+-1Y	7-iC101	AG		R
VH iTSH73CPT-1Y	4-iC4604	AL		R
VPC KM330J3R9NY	6-L213	AB	S	
VPC NN2R2JR77NY	6-L207	AB	S	
"/	6-L208	AB	S	
"/	6-L209	AB	S	
"/	6-L210	AB	S	
VPC UN1R5MR12NY	6-L206	AC	S	
"/	9-L2703	AC	R	
VPD 9M100J1R7NY	4-L4601	AC	R	
VPD 9M5R6J1R6NY	4-L4603	AB	R	
"/	4-L4604	AB	R	
"/	4-L4605	AB	R	
VRD-RA2BE123JY	8-R152	AA	R	
VRD-RA2BE822JY	8-R151	AA	R	
"/	8-R153	AA	R	
VRK-CD1JJ151JY	9-R3533	AC	R	
"/	9-R3534	AC	R	

PARTS CODE	No.	PRICE RANK	NEW MARK	PART RANK
"/	9-R3535	AC		R
"/	9-R3536	AC		R
VRK-CD1JJ220JY	9-R3509	AC		R
VRK-CD1JJ330JY	9-R3524	AC		R
"/	9-R3525	AC		R
"/	9-R3526	AC		R
"/	9-R3527	AC		R
"/	9-R3542	AC		R
"/	9-R3543	AC		R
"/	9-R3544	AC		R
"/	9-R3545	AC		R
VRK-CD1JJ680JY	9-R3501	AC		R
"/	9-R3518	AC		R
VRN-VV3DBR15J	5-R750	AB		R
"/	5-R751	AB		R
VRN-VV3DBR18J	5-R760	AD		R
VRS-CH1JF000JY	4-R4027	AA		R
"/	6-R272	AA		S
"/	6-R273	AA		S
VRS-CH1JF100JY	9-R1920	AA		R
"/	9-R1921	AA		R
"/	9-R1922	AA		R
"/	9-R1923	AA		R
"/	9-R1924	AA		R
"/	9-R1925	AA		R
"/	9-R1927	AA		R
VRS-CH1JF101JY	9-R2333	AA		R
VRS-CH1JF103JY	4-R4036	AA		R
"/	4-R4223	AA		R
"/	4-R4224	AA		R
"/	6-R245	AA		S
"/	9-R2305	AA		R
VRS-CH1JF104JY	9-R2331	AA		R
"/	9-R2708	AA		R
"/	9-R2709	AA		R
VRS-CH1JF220JY	9-R3503	AA		R
VRS-CH1JF470JY	4-R4030	AA		R
"/	4-R4031	AA		R
"/	4-R4201	AA		R
"/	4-R4202	AA		R
"/	4-R4203	AA		R
"/	4-R4204	AA		R
"/	4-R4205	AA		R
"/	4-R4206	AA		R
"/	4-R4207	AA		R
"/	4-R4208	AA		R
"/	4-R4209	AA		R
"/	4-R4211	AA		R
"/	4-R4212	AA		R
"/	4-R4213	AA		R
"/	4-R4214	AA		R
"/	4-R4215	AA		R
"/	4-R4216	AA		R
"/	4-R4217	AA		R
"/	4-R4218	AA		R
"/	4-R4401	AA		R
"/	4-R4402	AA		R
"/	4-R4403	AA		R
"/	4-R4404	AA		R
"/	4-R4407	AA		R
"/	4-R4408	AA		R
"/	4-R4410	AA		R
"/	4-R4411	AA		R
"/	4-R4412	AA		R
"/	4-R4413	AA		R
"/	4-R4414	AA		R
"/	4-R4415	AA		R
"/	4-R4416	AA		R
"/	4-R4421	AA		R
"/	4-R4422	AA		R
"/	4-R4427	AA		R
"/	4-R4428	AA		R
"/	4-R4429	AA		R
VRS-CH1JF680JY	9-R3575	AA		R
VRS-CJ1JF100JY	9-R1914	AA		R
"/	9-R1916	AA		R
VRS-CJ1JF101JY	3-R1139	AA		R
"/	3-R1152	AA		R
"/	9-R1934	AA		R
"/	9-R2307	AA		R
"/	9-R2702	AA		R
"/	9-R3004	AA		R

PARTS CODE	No.	PRICE RANK	NEW MARK	PART RANK	PARTS CODE	No.	PRICE RANK	NEW MARK	PART RANK
	9-R3301	AA		R		9-R1833	AA		R
VRS-CJ1JF102JY	3-R301	AA		R		9-R1834	AA		R
VRS-CJ1JF103JY	3-R327	AA		R		9-R1835	AA		R
	3-R333	AA		R		9-R1836	AA		R
	3-R345	AA		R		9-R1837	AA		R
	7-R123	AA		R		9-R1838	AA		R
	7-R124	AA		R		9-R1841	AA		R
	9-R2710	AA		R		9-R1851	AA		R
	9-R2711	AA		R		9-R1855	AA		R
	9-R2716	AA		R		9-R1943	AA		R
VRS-CJ1JF104JY	3-R302	AA		R		9-R1944	AA		R
	3-R307	AA		R		9-R2301	AA		R
VRS-CJ1JF222JY	3-R348	AA		R		9-R2303	AA		R
VRS-CJ1JF224JY	9-R2706	AA		R		9-R2367	AA		R
	9-R2707	AA		R		9-R2370	AA		R
VRS-CJ1JF272JY	3-R1143	AA		R		9-R2373	AA		R
	3-R1158	AA		R		9-R2375	AA		R
VRS-CJ1JF331JY	3-R1140	AA		R		9-R2377	AA		R
	3-R1155	AA		R		9-R2378	AA		R
VRS-CJ1JF392JY	3-R328	AA		R		9-R2379	AA		R
VRS-CJ1JF472JY	3-R306	AA		R		9-R2380	AA		R
	9-R2712	AA		R		9-R2381	AA		R
	9-R2713	AA		R		9-R2382	AA		R
	9-R3005	AA		R		9-R2386	AA		R
	9-R3008	AA		R		9-R2387	AA		R
VRS-CJ1JF473JY	9-R1913	AB		R		9-R2388	AA		R
	9-R1915	AB		R		9-R2389	AA		R
VRS-CJ1JF474JY	9-R1911	AA		R		9-R2390	AA		R
	9-R1912	AA		R		9-R2391	AA		R
VRS-CY1JF000JY	3-R358	AA		R		9-R2392	AA		R
	3-R1104	AA		R		9-R2393	AA		R
	3-R1105	AA		R		9-R2394	AA		R
	3-R1106	AA		R		9-R2395	AA		R
	3-R1110	AA		R		9-R2398	AA		R
	3-R1115	AA		R		9-R2718	AA		R
	3-R1120	AA		R		9-R2722	AA		R
	3-R1126	AA		R		9-R2723	AA		R
	3-R1130	AA		R		9-R2724	AA		R
	3-R1137	AA		R		9-R2725	AA		R
	3-R1138	AA		R		9-R2727	AA		R
	3-R1228	AA		R		9-R2728	AA		R
	4-R4001	AA		R		9-R2729	AA		R
	4-R4004	AA		R		9-R2730	AA		R
	4-R4010	AA		R		9-R2731	AA		R
	4-R4018	AA		R		9-R2732	AA		R
	4-R4019	AA		R		9-R2733	AA		R
	4-R4024	AA		R		9-R2734	AA		R
	4-R4025	AA		R		9-R2735	AA		R
	4-R4626	AA		R		9-R2755	AA		R
	4-R4674	AA		R		9-R2756	AA		R
	5-RJ1	AA		R		9-R2758	AA		R
	5-RJ2	AA		R		9-R2771	AA		R
	5-RJ3	AA		R		9-R3013	AA		R
	5-R798	AA		R		9-R3014	AA		R
	5-R799	AA		R		9-R3015	AA		R
	5-R811	AA		R		9-R3016	AA		R
	5-R815	AA		R		9-R3017	AA		R
	5-R816	AA		R		9-R3021	AA		R
	5-R848	AA		R		9-R3022	AA		R
	6-R201	AA		S		9-R3034	AA		R
	6-R209	AA		S		9-R3041	AA		R
	6-R211	AA		S		9-R3044	AA		R
	6-R213	AA		S		9-R3054	AA		R
	6-R227	AA		S		9-R3064	AA		R
	6-R247	AA		S		9-R3070	AA		R
	6-R266	AA		S		9-R3306	AA		R
	6-R267	AA		S		9-R3561	AA		R
	6-R268	AA		S		9-R3596	AA		R
	6-R269	AA		S		9-R3712	AA		R
	6-R274	AA		S		9-R3713	AA		R
	6-R281	AA		S		9-R3714	AA		R
	6-R282	AA		S		9-R3715	AA		R
	6-R283	AA		S		9-R3741	AA		R
	6-R293	AA		S		9-R3748	AA		R
	6-R294	AA		S		9-R3749	AA		R
	7-R135	AA		R		9-R3750	AA		R
	9-R1704	AA		R		9-R3752	AA		R
	9-R1705	AA		R		9-TH3003	AA		R
	9-R1707	AA		R	VRS-CY1JF100JY	6-R214	AA		S
	9-R1714	AA		R		6-R286	AA		S
	9-R1831	AA		R		9-R1919	AA		R
	9-R1832	AA		R	VRS-CY1JF101JY	3-R1201	AA		R

LC-37XD1E/RU

PARTS CODE	No.	PRICE RANK	NEW MARK	PART RANK
"	4-R4016	AA		R
"	4-R4038	AA		R
"	4-R4039	AA		R
"	4-R4190	AA		R
"	4-R4191	AA		R
"	4-R4192	AA		R
"	4-R4193	AA		R
"	4-R4194	AA		R
"	4-R4195	AA		R
"	4-R4196	AA		R
"	4-R4197	AA		R
"	4-R4657	AA		R
"	4-R4658	AA		R
"	4-R4710	AA		R
"	4-R4717	AA		R
"	5-R884	AA		R
"	6-R220	AA	S	
"	6-R243	AA	S	
"	6-R264	AA	S	
"	6-R265	AA	S	
"	7-R101	AA		R
"	9-R1700	AA		R
"	9-R1711	AA		R
"	9-R1716	AA		R
"	9-R1722	AA		R
"	9-R1727	AA		R
"	9-R1761	AA		R
"	9-R1763	AA		R
"	9-R1764	AA		R
"	9-R1781	AA		R
"	9-R1782	AA		R
"	9-R1783	AA		R
"	9-R1784	AA		R
"	9-R1785	AA		R
"	9-R1787	AA		R
"	9-R1788	AA		R
"	9-R1789	AA		R
"	9-R1790	AA		R
"	9-R1791	AA		R
"	9-R1792	AA		R
"	9-R1793	AA		R
"	9-R1794	AA		R
"	9-R1795	AA		R
"	9-R1796	AA		R
"	9-R1797	AA		R
"	9-R1798	AA		R
"	9-R1805	AA		R
"	9-R1842	AA		R
"	9-R2321	AA		R
"	9-R2330	AA		R
"	9-R2364	AA		R
"	9-R2705	AA		R
"	9-R3019	AA		R
"	9-R3701	AA		R
"	9-R3702	AA		R
"	9-R3703	AA		R
"	9-R3716	AA		R
"	9-R3717	AA		R
"	9-R3718	AA		R
"	9-R3719	AA		R
"	9-R3720	AA		R
"	9-R3721	AA		R
"	9-R3722	AA		R
"	9-R3723	AA		R
"	9-R3724	AA		R
"	9-R3725	AA		R
"	9-R3726	AA		R
"	9-R3727	AA		R
"	9-R3728	AA		R
"	9-R3729	AA		R
"	9-R3730	AA		R
"	9-R3731	AA		R
"	9-R3742	AA		R
"	9-R3746	AA		R
"	9-R3747	AA		R
VRS-CY1JF102FY	9-R2339	AA		R
VRS-CY1JF102JY	3-R310	AA		R
"	3-R311	AA		R
"	3-R312	AA		R
"	3-R313	AA		R
"	3-R353	AA		R
"	3-R354	AA		R

PARTS CODE	No.	PRICE RANK	NEW MARK	PART RANK
"	3-R1134	AA		R
"	3-R1144	AA		R
"	3-R1145	AA		R
"	3-R1147	AA		R
"	3-R1159	AA		R
"	3-R1160	AA		R
"	3-R1177	AA		R
"	3-R1179	AA		R
"	3-R1210	AA		R
"	3-R1211	AA		R
"	3-R1213	AA		R
"	3-R1214	AA		R
"	3-R1226	AA		R
"	3-R1227	AA		R
"	4-R4447	AA		R
"	6-R271	AA	S	
"	9-R1731	AA		R
"	9-R1736	AA		R
"	9-R2326	AA		R
"	9-R2335	AA		R
"	9-R2338	AA		R
"	9-R2352	AA		R
"	9-R2354	AA		R
"	9-R2362	AA		R
"	9-R2363	AA		R
"	9-R2372	AA		R
"	9-R2374	AA		R
"	9-R2396	AA		R
"	9-R2397	AA		R
"	9-R2415	AA		R
"	9-R2416	AA		R
"	9-R2417	AA		R
"	9-R2715	AA		R
"	9-R2719	AA		R
"	9-R3312	AA		R
"	9-R3521	AA		R
VRS-CY1JF103FY	5-R790	AA		R
"	9-R1723	AA		R
"	9-R1753	AA		R
"	9-R1768	AA		R
VRS-CY1JF103JY	3-R321	AA		R
"	3-R322	AA		R
"	3-R351	AA		R
"	3-R352	AA		R
"	3-R356	AA		R
"	4-R4003	AA		R
"	4-R4005	AA		R
"	4-R4006	AA		R
"	4-R4007	AA		R
"	4-R4008	AA		R
"	4-R4011	AA		R
"	4-R4012	AA		R
"	4-R4013	AA		R
"	4-R4015	AA		R
"	4-R4017	AA		R
"	4-R4026	AA		R
"	4-R4028	AA		R
"	4-R4032	AA		R
"	4-R4035	AA		R
"	4-R4037	AA		R
"	4-R4225	AA		R
"	4-R4226	AA		R
"	4-R4227	AA		R
"	4-R4228	AA		R
"	4-R4229	AA		R
"	4-R4230	AA		R
"	4-R4231	AA		R
"	4-R4232	AA		R
"	4-R4247	AA		R
"	4-R4409	AA		R
"	4-R4417	AA		R
"	4-R4419	AA		R
"	4-R4420	AA		R
"	4-R4425	AA		R
"	4-R4426	AA		R
"	4-R4431	AA		R
"	4-R4432	AA		R
"	4-R4441	AA		R
"	4-R4666	AA		R
"	4-R4668	AA		R
"	4-R4670	AA		R
"	4-R4672	AA		R

PARTS CODE	No.	PRICE RANK	NEW MARK	PART RANK
"	4-R4673	AA		R
"	4-R4705	AA		R
"	4-R4706	AA		R
"	4-R4707	AA		R
"	4-R4712	AA		R
"	5-R709	AA		R
"	5-R806	AA		R
"	6-R241	AA		S
"	6-R284	AA		S
"	6-R285	AA		S
"	6-R289	AA		S
"	7-R102	AA		R
"	9-R1702	AA		R
"	9-R1709	AA		R
"	9-R1712	AA		R
"	9-R1720	AA		R
"	9-R1725	AA		R
"	9-R1756	AA		R
"	9-R1774	AA		R
"	9-R1780	AA		R
"	9-R1845	AA		R
"	9-R1847	AA		R
"	9-R1848	AA		R
"	9-R1908	AA		R
"	9-R1910	AA		R
"	9-R1917	AA		R
"	9-R1918	AA		R
"	9-R1937	AA		R
"	9-R2306	AA		R
"	9-R2310	AA		R
"	9-R2311	AA		R
"	9-R2315	AA		R
"	9-R2319	AA		R
"	9-R2329	AA		R
"	9-R2334	AA		R
"	9-R2337	AA		R
"	9-R2342	AA		R
"	9-R2754	AA		R
"	9-R3001	AA		R
"	9-R3003	AA		R
"	9-R3009	AA		R
"	9-R3040	AA		R
"	9-R3302	AA		R
"	9-R3303	AA		R
"	9-R3304	AA		R
"	9-R3305	AA		R
"	9-R3307	AA		R
"	9-R3308	AA		R
"	9-R3514	AA		R
"	9-R3738	AA		R
"	9-R3739	AA		R
"	9-R3740	AA		R
"	9-R3751	AA		R
VRS-CY1 JF104 JY	3-R1150	AA		R
"	3-R1153	AA		R
"	3-R1154	AA		R
"	3-R1173	AA		R
"	3-R1212	AA		R
"	3-R1215	AA		R
"	4-R4009	AA		R
"	5-R749	AA		R
"	5-R832	AA		R
"	5-R840	AA		R
"	5-R885	AA		R
"	9-R1733	AA		R
"	9-R1738	AA		R
"	9-R1743	AA		R
"	9-R1749	AA		R
"	9-R1751	AA		R
"	9-R1769	AA		R
"	9-R1773	AA		R
"	9-R1775	AA		R
"	9-R1804	AA		R
"	9-R1846	AA		R
"	9-R2308	AA		R
"	9-R2320	AA		R
"	9-R2720	AA		R
"	9-R2721	AA		R
"	9-R2737	AA		R
"	9-R3011	AA		R
"	9-R3018	AA		R
"	9-R3024	AA		R

PARTS CODE	No.	PRICE RANK	NEW MARK	PART RANK
"	9-R3028	AA		R
"	9-R3029	AA		R
"	9-R3030	AA		R
"	9-R3031	AA		R
"	9-R3032	AA		R
"	9-R3033	AA		R
"	9-R3512	AA		R
VRS-CY1 JF105 JY	5-R703	AA		R
"	5-R839	AA		R
"	9-R1932	AA		R
"	9-R3708	AA		R
VRS-CY1 JF122 JY	3-R319	AA		R
"	3-R320	AA		R
"	5-R801	AA		R
"	5-R809	AA		R
"	5-R812	AA		R
"	5-R820	AA		R
"	5-R868	AA		R
"	5-R871	AA		R
"	5-R873	AA		R
VRS-CY1 JF123 FY	9-R1779	AA		R
VRS-CY1 JF123 JY	5-R859	AA		R
"	5-R867	AA		R
"	9-R2714	AA		R
VRS-CY1 JF132 JY	9-R1745	AG		R
VRS-CY1 JF151 JY	6-R238	AA		S
"	6-R259	AA		S
"	9-R2359	AA		R
"	9-R3567	AA		R
"	9-R3568	AA		R
"	9-R3569	AA		R
"	9-R3570	AA		R
"	9-R3588	AA		R
"	9-R3589	AA		R
"	9-R3590	AA		R
"	9-R3591	AA		R
VRS-CY1 JF152 JY	3-R325	AA		R
"	3-R326	AA		R
"	5-R847	AA		R
"	9-R1903	AA		R
"	9-R1904	AA		R
"	9-R1933	AA		R
VRS-CY1 JF153 FY	3-R1101	AA		R
"	3-R1102	AA		R
"	4-R4703	AA		R
VRS-CY1 JF153 JY	6-R248	AA		S
VRS-CY1 JF161 FY	4-R4665	AA		R
"	4-R4667	AA		R
"	4-R4669	AA		R
VRS-CY1 JF161 JY	7-R108	AA		R
"	7-R122	AA		R
VRS-CY1 JF181 JY	6-R290	AA		S
VRS-CY1 JF182 JY	9-R3704	AA		R
"	9-R3705	AA		R
"	9-R3706	AA		R
VRS-CY1 JF183 JY	4-R4651	AA		R
"	4-R4652	AA		R
"	5-R712	AA		R
VRS-CY1 JF201 FY	4-R4002	AA		R
VRS-CY1 JF202 FY	9-R1729	AA		R
"	9-R1732	AA		R
"	9-R1735	AA		R
"	9-R1748	AA		R
VRS-CY1 JF202 JY	9-R1746	AA		R
VRS-CY1 JF203 FY	9-R1721	AA		R
"	9-R1744	AA		R
VRS-CY1 JF221 JY	3-R349	AA		R
"	3-R350	AA		R
"	3-R1131	AA		R
"	3-R1161	AA		R
"	5-R789	AA		R
"	9-R2358	AA		R
"	9-R2366	AA		R
"	9-R2368	AA		R
"	9-R3560	AA		R
VRS-CY1 JF222 FY	9-R1734	AA		R
VRS-CY1 JF222 JY	3-R303	AA		R
"	3-R304	AA		R
"	3-R305	AA		R
"	3-R330	AA		R
"	3-R331	AA		R
"	4-R4021	AA		R

LC-37XD1E/RU

PARTS CODE	No.	PRICE RANK	NEW MARK	PART RANK
"	5-R870	AA		R
"	9-R1806	AA		R
"	9-R2336	AA		R
"	9-R2347	AA		R
"	9-R2351	AA		R
VRS-CY1JF223JY	9-R1928	AA		R
VRS-CY1JF224JY	5-R743	AA		R
VRS-CY1JF240JY	4-R4634	AA		R
"	4-R4635	AA		R
"	4-R4636	AA		R
"	4-R4637	AA		R
VRS-CY1JF242FY	4-R4628	AA		R
VRS-CY1JF271FY	4-R4619	AA		R
"	4-R4620	AA		R
"	4-R4621	AA		R
"	4-R4622	AA		R
"	4-R4623	AA		R
"	4-R4624	AA		R
"	4-R4662	AA		R
"	4-R4663	AA		R
"	4-R4664	AA		R
VRS-CY1JF271JY	3-R1216	AA		R
"	3-R1219	AA		R
"	9-R2349	AA		R
"	9-R2355	AA		R
VRS-CY1JF272FY	4-R4627	AA		R
VRS-CY1JF272JY	3-R1218	AA		R
"	3-R1222	AA		R
"	5-R861	AA		R
"	5-R862	AA		R
"	6-R287	AA		S
"	9-R1737	AA		R
"	9-R1901	AA		R
"	9-R1902	AA		R
"	9-R2739	AA		R
VRS-CY1JF273FY	4-R4702	AA		R
VRS-CY1JF273JY	6-R226	AA		S
"	7-R104	AA		R
"	9-R1945	AA		R
VRS-CY1JF330JY	4-R4029	AA		R
VRS-CY1JF331FY	4-R4617	AA		R
"	4-R4618	AA		R
"	4-R4659	AA		R
VRS-CY1JF331JY	3-R1217	AA		R
"	3-R1221	AA		R
"	6-R237	AA		S
VRS-CY1JF332DY	5-R705	AA		R
"	5-R777	AA		R
"	5-R788	AA		R
VRS-CY1JF332JY	4-R4708	AA		R
"	5-R869	AA		R
"	9-R1728	AA		R
"	9-R3735	AA		R
"	9-R3736	AA		R
"	9-R3737	AA		R
VRS-CY1JF333JY	5-R754	AA		R
"	5-R864	AA		R
"	5-R865	AA		R
"	9-R2343	AA		R
"	9-R2376	AA		R
"	9-R3597	AA		R
VRS-CY1JF392JY	3-R314	AA		R
"	3-R316	AA		R
"	3-R1202	AA		R
"	6-R242	AA		S
"	9-R2340	AA		R
"	9-R2353	AA		R
VRS-CY1JF393FY	3-R1103	AA		R
"	3-R1108	AA		R
"	9-R2341	AA		R
VRS-CY1JF393JY	9-R2741	AA		R
VRS-CY1JF470FY	4-R4616	AA		R
"	9-R2704	AA		R
VRS-CY1JF470JY	4-R4210	AA		R
"	4-R4219	AA		R
"	4-R4220	AA		R
"	4-R4221	AA		R
"	4-R4222	AA		R
"	4-R4233	AA		R
"	4-R4234	AA		R
"	4-R4235	AA		R
"	4-R4236	AA		R

PARTS CODE	No.	PRICE RANK	NEW MARK	PART RANK
"	4-R4237	AA		R
"	4-R4238	AA		R
"	4-R4239	AA		R
"	4-R4240	AA		R
"	4-R4241	AA		R
"	4-R4242	AA		R
"	4-R4243	AA		R
"	4-R4244	AA		R
"	4-R4246	AA		R
"	4-R4248	AA		R
"	4-R4250	AA		R
"	4-R4251	AA		R
"	4-R4405	AA		R
"	4-R4406	AA		R
"	4-R4418	AA		R
"	4-R4433	AA		R
"	4-R4434	AA		R
"	4-R4601	AA		R
"	4-R4602	AA		R
"	4-R4603	AA		R
"	4-R4604	AA		R
"	4-R4605	AA		R
"	4-R4606	AA		R
"	4-R4607	AA		R
"	4-R4608	AA		R
"	4-R4609	AA		R
"	4-R4629	AA		R
"	4-R4630	AA		R
"	4-R4643	AA		R
"	4-R4644	AA		R
"	4-R4645	AA		R
"	4-R4646	AA		R
"	4-R4647	AA		R
"	4-R4648	AA		R
"	4-R4649	AA		R
"	4-R4650	AA		R
"	4-R4675	AA		R
"	6-R207	AA		S
"	6-R208	AA		S
"	6-R255	AA		S
"	6-R256	AA		S
"	9-R1715	AA		R
"	9-R1717	AA		R
"	9-R1718	AA		R
"	9-R1730	AA		R
"	9-R1750	AA		R
"	9-R2365	AA		R
"	9-R3502	AA		R
"	9-R3743	AA		R
"	9-R3744	AA		R
VRS-CY1JF471JY	4-R4430	AA		R
"	4-R4631	AA		R
"	4-R4632	AA		R
"	4-R4639	AA		R
"	4-R4640	AA		R
VRS-CY1JF472DY	5-R837	AA	S	R
VRS-CY1JF472JY	3-R360	AA		R
"	4-R4020	AA		R
"	4-R4633	AA		R
"	4-R4638	AA		R
"	5-R762	AA		R
"	5-R860	AA		R
"	5-R863	AA		R
"	5-R872	AA		R
"	5-R875	AA		R
"	5-R876	AA		R
"	5-R878	AA		R
"	6-R215	AA		S
"	6-R216	AA		S
"	6-R217	AA		S
"	6-R218	AA		S
"	9-R1926	AA		R
"	9-R1929	AA		R
"	9-R2752	AA		R
"	9-R2753	AA		R
"	9-R3006	AA		R
"	9-R3010	AA		R
"	9-R3012	AA		R
VRS-CY1JF473JY	3-R308	AA		R
"	3-R309	AA		R
"	3-R323	AA		R
"	3-R324	AA		R

PARTS CODE	No.	PRICE RANK	NEW MARK	PART RANK	PARTS CODE	No.	PRICE RANK	NEW MARK	PART RANK
"	4-R4660	AA		R	"	9-R1938	AA		R
"	4-R4661	AA		R	"	9-R1939	AA		R
"	5-R866	AA		R	"	9-R1940	AA		R
"	9-R1906	AA		R	"	9-R1941	AA		R
"	9-R1909	AA		R	"	9-R1942	AA		R
"	9-R2332	AA		R	"	9-R3002	AA		R
"	9-R2357	AA		R	"	9-R3504	AA		R
"	9-R2360	AA		R	"	9-R3506	AA		R
"	9-R2738	AA		R	"	9-R3510	AA		R
"	9-R3039	AA		R	"	9-R3511	AA		R
VRS-CY1JF474FY	4-R4701	AA		R	"	9-R3517	AA		R
VRS-CY1JF474JY	3-R315	AA		R	"	9-R3519	AA		R
"	3-R317	AA		R	"	9-R3520	AA		R
VRS-CY1JF4R7JY	9-R2776	AA		R	"	9-R3532	AA		R
VRS-CY1JF511FY	9-R1726	AA		R	"	9-R3541	AA		R
"	9-R1747	AA		R	"	9-R3550	AA		R
VRS-CY1JF512JY	9-R3745	AA		R	VRS-CZ1JF330JY	9-R1935	AA		R
VRS-CY1JF514JY	6-R270	AA		S	"	9-R2371	AA		R
VRS-CY1JF560JY	3-R346	AA		R	"	9-R3551	AA		R
"	3-R347	AA		R	"	9-R3552	AA		R
VRS-CY1JF561JY	9-R2350	AA		R	"	9-R3553	AA		R
VRS-CY1JF562JY	4-R4245	AA		R	"	9-R3554	AA		R
"	4-R4249	AA		R	"	9-R3580	AA		R
"	4-R4704	AA		R	"	9-R3581	AA		R
"	9-R1701	AA		R	"	9-R3582	AA		R
"	9-R1755	AA		R	"	9-R3583	AA		R
"	9-R1854	AA		R	"	9-R3592	AA		R
VRS-CY1JF563JY	5-R886	AA		R	"	9-R3593	AA		R
"	9-R1786	AA		R	"	9-R3594	AA		R
"	9-R2703	AA		R	"	9-R3595	AA		R
VRS-CY1JF564JY	3-R1141	AA		R	VRS-CZ1JF333JY	9-R1706	AA		R
"	3-R1142	AA		R	"	9-R2309	AA		R
"	3-R1156	AA		R	"	9-R2317	AA		R
"	3-R1157	AA		R	"	9-R2318	AA		R
"	3-R1224	AA		R	"	9-R2717	AA		R
"	3-R1225	AA		R	"	9-R3505	AA		R
VRS-CY1JF622FY	9-R1719	AA		R	"	9-R3537	AA		R
"	9-R1754	AA		R	"	9-R3540	AA		R
"	9-R3007	AA		R	"	9-R3557	AA		R
VRS-CY1JF681FY	5-R710	AA		R	"	9-R3559	AA		R
VRS-CY1JF682JY	3-R329	AA		R	"	9-R3562	AA		R
"	3-R334	AA		R	"	9-R3563	AA		R
"	3-R1203	AA		R	"	9-R3564	AA		R
"	5-R716	AA		R	VRS-CZ1JF680JY	9-R3045	AB		R
"	5-R879	AA		R	"	9-R3046	AB		R
VRS-CY1JF750JY	3-R1204	AA		R	"	9-R3047	AB		R
"	6-R205	AA		S	"	9-R3048	AB		R
VRS-CY1JF752JY	9-R1770	AA		R	"	9-R3049	AB		R
VRS-CY1JF821JY	7-R109	AA		R	"	9-R3050	AB		R
"	7-R121	AA		R	"	9-R3051	AB		R
VRS-CY1JF822DY	5-R725	AA		R	"	9-R3052	AB		R
VRS-CY1JF822JY	9-R2356	AA		R	"	9-R3053	AB		R
"	9-R2740	AA		R	"	9-R3513	AB		R
VRS-CY1JF823FY	9-R1767	AA		R	"	9-R3515	AB		R
VRS-CY1JF910FY	9-R1930	AA		R	VRS-TQ2BD000JY	5-R770	AA		R
"	9-R1931	AA		R	"	5-R835	AA		R
VRS-CZ1JF000JY	9-R3069	AA		R	"	5-R857	AA		R
"	9-R3571	AA		R	VRS-TQ2BD1R0JY	6-R228	AA		S
VRS-CZ1JF101JY	9-R3055	AA		R	VRS-TQ2EF100JY	5-R714	AA		R
"	9-R3056	AA		R	VRS-TQ2EF101JY	5-R715	AA		R
"	9-R3057	AA		R	VRS-TQ2EF102JY	5-R772	AA		R
"	9-R3058	AA		R	VRS-TQ2EF103JY	5-R769			R
"	9-R3059	AA		R	VRS-TQ2EF122JY	5-R763	AA		R
"	9-R3060	AA		R	"	5-R768	AA		R
"	9-R3061	AA		R	"	5-R817	AA		R
"	9-R3062	AA		R	VRS-TQ2EF123FY	5-R744			R
"	9-R3063	AA		R	"	5-R808			R
"	9-R3313	AA		R	VRS-TQ2EF124FY	5-R706	AA		R
"	9-R3314	AA		R	"	5-R707	AA		R
"	9-R3315	AA		R	"	5-R708	AA		R
"	9-R3316	AA		R	"	5-R822	AA		R
"	9-R3317	AA		R	"	5-R826	AA		R
"	9-R3318	AA		R	VRS-TQ2EF220JY	5-R828	AA		R
"	9-R3319	AA		R	VRS-TQ2EF221JY	5-R851	AA		R
"	9-R3320	AA		R	"	5-R852	AA		R
"	9-R3321	AA		R	VRS-TQ2EF332JY	5-R824	AA		R
VRS-CZ1JF102JY	9-R3507	AA		R	VRS-TQ2EF333FY	5-R797			R
"	9-R3508	AA		R	VRS-TQ2EF391JY	5-R767	AA		R
VRS-CZ1JF220JY	9-R1762	AA		R	VRS-TQ2EF393FY	5-R713			R
"	9-R1776	AA		R	VRS-TQ2EF394DY	5-R720			R
"	9-R1777	AA		R	"	5-R721			R
"	9-R1800	AA		R	"	5-R722			R

LC-37XD1E/RU

PARTS CODE	No.	PRICE RANK	NEW MARK	PART RANK
"	5-R723			R
"	5-R724			R
VRS-TQ2EF394FY	5-R728			R
"	5-R729			R
"	5-R730			R
"	5-R731			R
"	5-R732			R
VRS-TQ2EF681JY	5-R718	AA		R
"	5-R726	AA		R
"	5-R881	AA		R
"	5-R882	AA		R
VRS-TQ2EF683JY	5-R810	AA		R
VRS-TQ2EF752FY	5-R771			R
VRS-TV1JD000JY	5-R752	AA		R
"	5-R800	AA		R
VRS-TV1JD102JY	5-R776	AA		R
"	5-R782	AA		R
VRS-TV1JD103JY	5-R717	AA		R
"	5-R733	AA		R
"	5-R734	AA		R
"	5-R741	AA		R
"	5-R742	AA		R
"	5-R745	AA		R
"	5-R746	AA		R
"	5-R748	AA		R
"	5-R753	AA		R
"	5-R757	AA		R
"	5-R759	AA		R
"	5-R761	AA		R
"	5-R764	AA		R
"	5-R766	AA		R
"	5-R773	AA		R
"	5-R774	AA		R
"	5-R779	AA		R
"	5-R785	AA		R
"	5-R786	AA		R
"	5-R787	AA		R
"	5-R791	AA		R
"	5-R793	AA		R
"	5-R823	AA		R
"	5-R825	AA		R
"	5-R830	AA		R
"	5-R831	AA		R
"	5-R834	AA		R
"	5-R836	AA		R
VRS-TV1JD104JY	5-R765	AA		R
VRS-TV1JD153FY	5-R747	AA		R
"	5-R775	AA		R
VRS-TV1JD203FY	5-R795	AA		R
VRS-TV1JD221JY	3-R1107	AA		R
"	3-R1109	AA		R
"	3-R1146	AA		R
"	3-R1148	AA		R
VRS-TV1JD223FY	5-R755			R
VRS-TV1JD223JY	5-R783	AA		R
VRS-TV1JD224JY	5-R805	AA		R
VRS-TV1JD242FY	5-R778	AA		R
"	5-R781	AA		R
VRS-TV1JD242JY	5-R784	AA		R
VRS-TV1JD272JY	5-R792	AA		R
"	5-R796	AA		R
"	5-R858	AA		R
VRS-TV1JD273FY	5-R756			R
VRS-TV1JD390JY	5-R711	AA		R
VRS-TV1JD563JY	5-R727	AA		R
VRS-TV1JD564JY	5-R740	AA		R
"	5-R758	AA		R
VRS-TV1JD682JY	5-R780	AA		R
VRS-TV1JD821FY	5-R794	AA		R
VRS-TW2ED000JY	3-R343	AB		R
"	9-R1703	AB		R
VRS-TW2ED100JY	3-R335	AA		R
"	3-R336	AA		R
"	3-R337	AA		R
"	3-R338	AA		R
VRS-TW2ED101JY	3-R1119	AA		R
"	3-R1128	AA		R
VRS-TW2ED220JY	3-R339	AB		R
"	3-R340	AB		R
VRS-TW2ED2R7JY	3-R355	AB		R
VRS-TW2ED561JY	6-R225	AA		S
VRS-TW2ED680JY	3-R1111	AA		R

PARTS CODE	No.	PRICE RANK	NEW MARK	PART RANK
"	3-R1112	AA		R
VRS-TW2ED750JY	3-R1113	AA		R
"	3-R1114	AA		R
"	3-R1116	AA		R
"	3-R1117	AA		R
"	3-R1118	AA		R
"	3-R1121	AA		R
"	3-R1123	AA		R
"	3-R1125	AA		R
"	3-R1127	AA		R
"	3-R1129	AA		R
"	3-R1206	AA		R
"	3-R1209	AA		R
"	9-R2322	AA		R
"	9-R2324	AA		R
"	9-R2325	AA		R
VRS-TW2HF1R0JY	9-R1739	AA		R
"	9-R1740	AA		R
"	9-R1741	AA		R
"	9-R1742	AA		R
"	9-R1757	AA		R
"	9-R1758	AA		R
"	9-R1759	AA		R
"	9-R1760	AA		R
"	9-R1771	AA		R
"	9-R1772	AA		R
VRS-TW2HF1R8JY	6-R275	AA		S
"	6-R276	AA		S
"	6-R277	AA		S
VRS-TW2HF820JY	3-R318	AB		R
VRS-TX2HF000JY	4-R4709	AB		R
"	4-R4711	AB		R
"	4-R4715	AB		R
"	4-R4716	AB		R
VRS-TX2HF1R0JY	4-R4713	AB		R
VRS-VV3AB273J	5-R802	AA		R
"	5-R803	AA		R
VRS-VV3DB102J	5-R854	AA		R
VRS-VV3LB220J	5-R804	AB		R
VS2SA1530AR-1Y	3-Q307	AB		R
"	3-Q1103	AB		R
"	3-Q1104	AB		R
"	3-Q1107	AB		R
"	3-Q1108	AB		R
"	3-Q1201	AB		R
"	3-Q1202	AB		R
"	4-Q4201	AB		R
"	9-Q1702	AB		R
"	9-Q1704	AB		R
"	9-Q2306	AB		R
"	9-Q2312	AB		R
"	9-Q2313	AB		R
"	9-Q2314	AB		R
"	9-Q2315	AB		R
VS2SC2735//1EY	6-Q203	AC		S
"	6-Q210	AC		S
VS2SC3928AR-1Y	3-Q301	AB		R
"	3-Q302	AB		R
"	4-Q4001	AB		R
"	4-Q4002	AB		R
"	4-Q4601	AB		R
"	4-Q4602	AB		R
"	4-Q4603	AB		R
"	4-Q4604	AB		R
"	4-Q4605	AB		R
"	4-Q4606	AB		R
"	4-Q4607	AB		R
"	4-Q4703	AB		R
"	5-Q702	AB		R
"	5-Q704	AB		R
"	5-Q708	AB		R
"	5-Q710	AB		R
"	5-Q712	AB		R
"	5-Q713	AB		R
"	5-Q721	AB		R
"	5-Q726	AB		R
"	5-Q733	AB		R
"	7-Q102	AB		R
"	7-Q103	AB		R
"	7-Q106	AB		R
"	7-Q107	AB		R
"	9-Q1701	AB		R

PARTS CODE	No.	PRICE RANK	NEW MARK	PART RANK
"	9-Q1703	AB		R
"	9-Q2305	AB		R
"	9-Q2307	AB		R
"	9-Q2701	AB		R
"	9-Q2702	AB		R
"	9-Q2703	AB		R
"	9-Q2704	AB		R
"	9-Q2705	AB		R
"	9-Q2706	AB		R
"	9-Q2711	AB		R
VS2SD2185R+-1Y	5-Q729	AF		R
VS2SK3525+-1	5-Q701	AM		R
"	5-Q709	AM		R
VS2SK536///-1Y	9-Q1901	AE		R
"	9-Q1902	AE		R
"	9-Q1903	AE		R
"	9-Q1904	AE		R
VSCPH6318+-1Y	4-Q4704	AE		R
"	9-Q1706	AE		R
VSDTC114EE/-1Y	9-Q2302	AB		R
"	9-Q2303	AB		R
VSDTC144EE/-1Y	4-Q4701	AA		R
"	4-Q4702	AA		R
"	9-Q1905	AA		R
"	9-Q1906	AA		R
"	9-Q1907	AA		R
"	9-Q1908	AA		R
"	9-Q1909	AA		R
"	9-Q1910	AA		R
"	9-Q2304	AA		R
"	9-Q2707	AA		R
"	9-Q2708	AA		R
"	9-Q2715	AA		R
"	9-Q2717	AA		R
"	9-Q3001	AA		R
"	9-Q3501	AA		R
"	9-Q3702	AA		R
"	9-Q3703	AA		R
VSDTC144EUA-1Y	5-Q734	AB		R
VSDTC314TK/-1Y	3-Q303	AC		R
"	3-Q304	AC		R
"	3-Q305	AC		R
"	3-Q306	AC		R
"	3-Q1101	AC		R
"	3-Q1102	AC		R
"	3-Q1105	AC		R
"	3-Q1106	AC		R
"	3-Q1203	AC		R
"	3-Q1204	AC		R
VSRN4904///-1Y	6-Q209	AB		S
VSSSM3K15FS-1Y	9-Q2709	AC		R
"	9-Q2710	AC		R
"	9-Q3003	AC		R
"	9-Q3004	AC		R
VSSSM6J51TU-1Y	9-iC1709	AF		R
【 X 】				
XBBS930P06000	10-57	AA		R
XBBS940P06000	10-58	AB		R
XBPS730P06WS0	10-59	AA		R
XBPS830P06000	10-60	AA		R
XBPSN20P14JS0	4-N	AB		R
XEBS740P10000	10-4-1-5			R
XEBS930P08000	10-61	AA		R
XEBS930P10000	10-62	AA		R
"	10-3-3	AA		R
"	10-1-12	AA		R
XEBS940P16000	10-63	AB		R
XJPS730P04WS0	10-64			R
XJPS730P08WS0	4-N	AA		R
"	10-65	AA		R
XNESN20-16000	4-N			R