

MECHANICAL EXPLODED VIEW

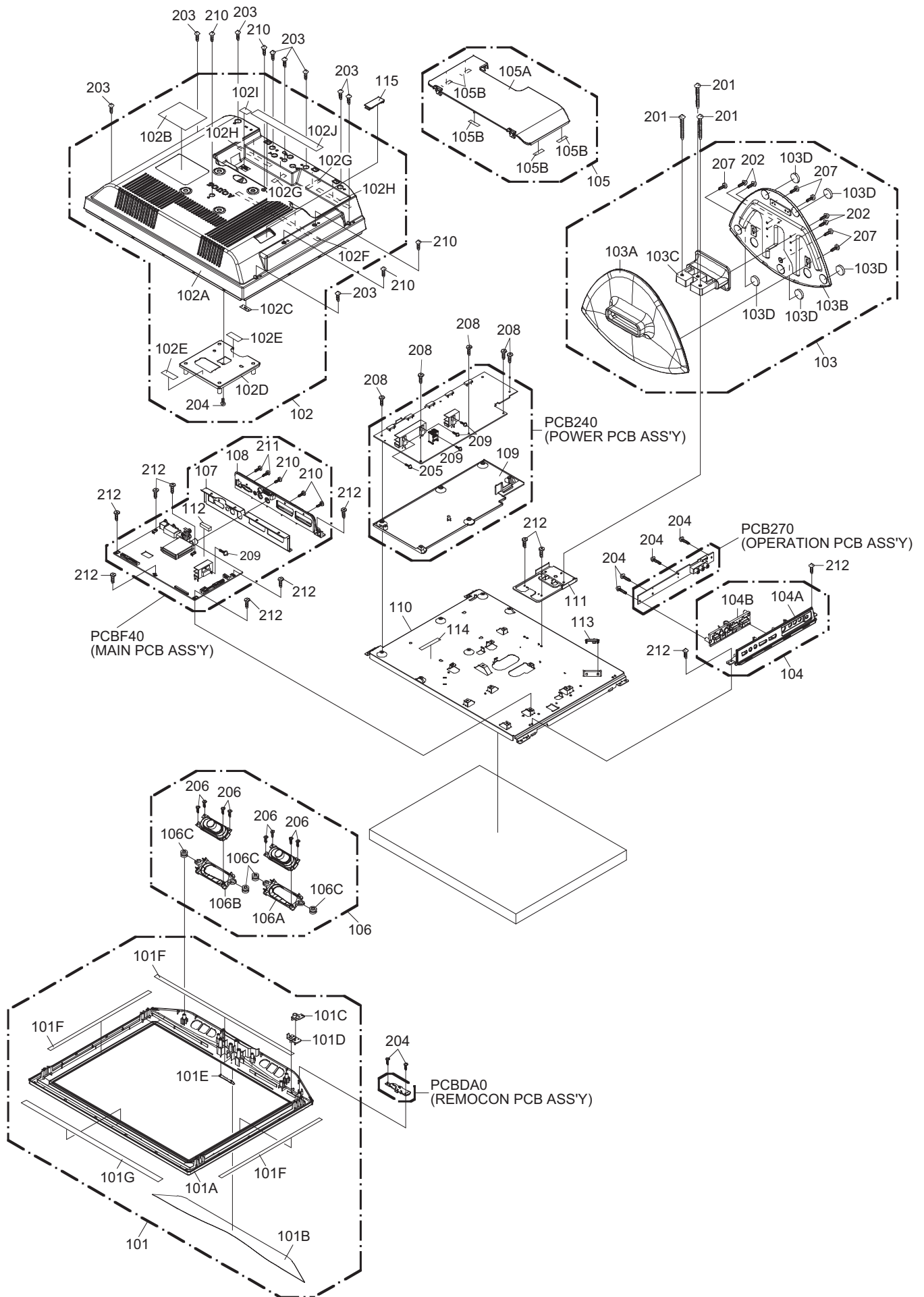

MECHANICAL EXPLODED VIEW (PACKING DIAGRAM)

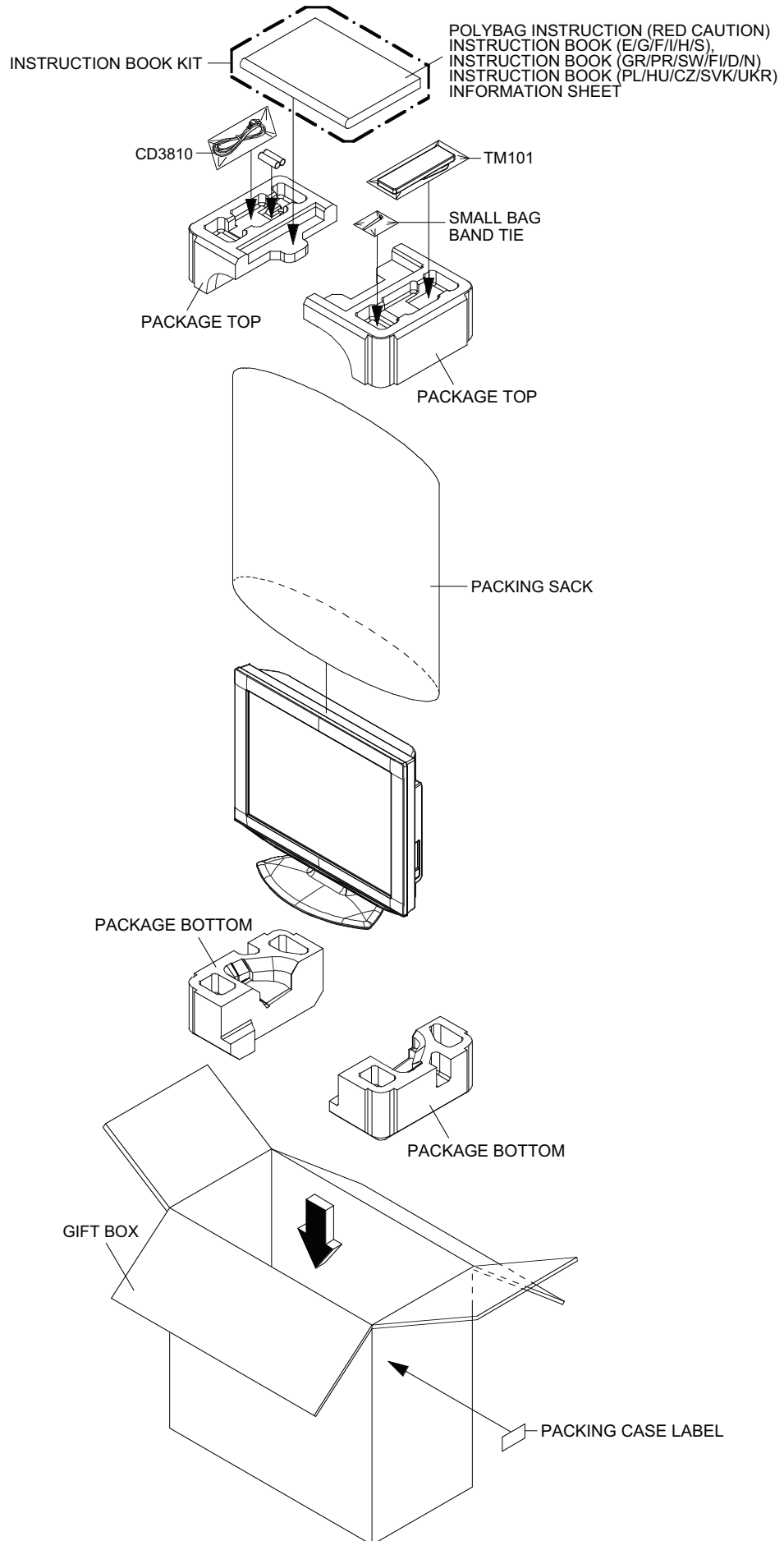

MECHANICAL REPLACEMENT PARTS LIST

REF. NO.	PART NO.	DESCRIPTION	CODE
101	9JD7A7010276A	FRONT CABI ASS'Y	
101A	9JD701WPJ1482	CABINET FRONT	
101B	9JD702WNB0001	SHEET SPEAKER	
101C	9JD706WPA0026	COVER LED	
101D	9JD713WPA0412	GLASS LED	
101E	9JD7235270037	BADGE BRAND	
101F	9JD800WQ00124	FELT SHEET	
101G	9JD800WQ00112	FELT SHEET	9x390xT0.3
102	9JD7A7020118A	BACK CABI ASS'Y	
102A	9JD702WPA1284	CABINET BACK	
102B	9JD7225270039	SHEET RATING	
102C	9JD753CUAA001	ANGLE KENSINGTON	
102D	9JD761WSA0474	ANGLE BACK	
102E	9JD800WFA0066	CUSHION	30x14xT2
102F	9JD800WQ00103	FELT SHEET	9x250xT0.3
102G	9JD800WQ00120	FELT SHEET	
102H	9JD800WQ00122	FELT SHEET	
102I	9JD7230008304	SHEET AC INLET	
102J	9JD7230008306	SHEET JACK	
103	9JD7A7040028A	STAND ASS'Y	
103A	9JD704WPA0076	STAND	
103B	9JD704WPA0077	FRAME STAND	
103C	9JD761WSA0463	ANGLE STAND	
103D	9JD800WFA0119	CUSHION LEG	
104	9JD7A7110011A	PLATE BUTTON ASS'Y	
104A	9JD711WPD0713	PLATE BUTTON	
104B	9JD735WPB0357	BUTTON FRAME	
105	9JD7A7020123A	COVER BACK ASS'Y	
105A	9JD702WPA1289	COVER BACK	
105B	9JD800WQ0A062	FELT,SHEET	
106	9JDA31A14EX30L	SPEAKER CABI ASSY	
106A	9JD761WPA0466	HOLDER SPEAKER-L	
106B	9JD761WPA0467	HOLDER SPEAKER-R	
106C	9JD800WR00084	DAMPER SPEAKER	
107	9JD752WSA0647	SHIELD JACK	
108	9JD761WPA0468	PLATE JACK	
109	9JD761WPA0469	HOLDER PCB	
110	9JD761WSA0461	COVER LCD	
111	9JD761WSA0473	ANGLE FRAME	
112	9JD8965TS4025	CUSHION 65TS5-4	5x4x25
113	9JD899RFC21V0	HOLDER CORD	
114	9JD800WQ0A062	FELT,SHEET	
115	9JD702WPA1290	COVER CONNECTOR	
201	9JD8117540C0S	SCREW TAPPING(B0) TRUSS	4x30
202	9JD8117540A0U	SCREW TAPPING(B0) TRUSS	4x10
203	9JD8110630B0S	SCREW TAP TITE(P) BRAZIER	3x20
204	9JD8110630A0U	SCREW TAP TITE(P) BRAZIER	3x10
205	9JD810763080U	SCREW TAP TITE(S) BRAZIER	3x8
206	9JD811022680U	SCREW TAP TITE(P) BIND	2.6x8
207	9JD8110K3080U	SCREW TAP TITE(P) LAMIHEAD	3x8
208	9JD8109D30A0U	SCREW TAP TITE(B) WH8	3x10
209	9JD8109I30A0U	SCREW TAP TITE(B) WH7	3x10
210	9JD8109230A0S	SCREW TAP TITE(B) BIND	3x10
211	9JD810213080S	SCREW PAN	M3x8
212	9JD810923080U	SCREW TAP TITE(B) BIND	3x8
---	9JD7235270041	PACKING CASE LABEL	
---	9JD791WHAA155	PACKING SACK	
---	9JD791WHAA172	SMALL BAG	
---	9JD792PHA0001	PACKAGE TOP	
---	9JD792PHA0002	PACKAGE BOTTOM	
---	9JD793PCD0001	GIFT BOX	
---	9JD899SGR150W	BAND TIE	
---	9JDA31A14E975	INSTRUCTION BOOK KIT	
---	9JDJ31A0301B	INSTRUCTION BOOK(E/G/F//H/S)	
---	9JDJ31A0310B	INSTRUCTION BOOK(GR/PR/SW/FI/D/N)	
---	9JDJ31A0311B	INSTRUCTION BOOK(PL/HU/CZ/SVK/UKR)	
---	9JDJ31A0329A	INFORMATION SHEET	
---	9JDJA4ND100	POLYBAG INSTRUCTION(REDCAUTION)	
---	9JDJA4ND200	POLYBAG INSTRUCTION(REDCAUTION)	







ELECTRICAL REPLACEMENT PART LIST

REF. NO.	PART NO.	DESCRIPTION	CODE
		REMOCON PCB ASS'Y	
		*** PCB ***	
PCBDA0	9JDA31A14EDA0L	REMOCON PCB ASS'Y	CEF281A
		*** DIODES ***	
D2201	9JD0021E9Q010	LED	LTL-1BEFJ-002A
		*** CONNECTORS ***	
CD4302	9JD06CU262302	CORD CONNECTOR	CU262302
CP2201	9JD069S260639	CONNECTOR PCB SIDE	A2001WR2-6P
		*** OTHERS ***	
OS2201	9JD077A033001	REMOTE RECEIVER	ROM-V338TAO
		MAIN PCB ASS'Y	
		*** PCB ***	
PCBF40	9JDA31A14EF40L	MAIN PCB ASS'Y	CMF102A
		*** CAPACITORS ***	
C339	9JDE7EYF3102M	CE	1000 UF 25V
		*** DIODES ***	
D101	9JDDE7RB1202B	DIODE ZENER	UDZS12B TE-177
D102	9JDDE7RB1202B	DIODE ZENER	UDZS12B TE-177
D103	9JDDE7RB1202B	DIODE ZENER	UDZS12B TE-177
D104	9JDDE7RB1202B	DIODE ZENER	UDZS12B TE-177
D800	9JDDE7RB5R62B	DIODE ZENER	UDZS5.6B TE-17
D802	9JDDE7RB5R62B	DIODE ZENER	UDZS5.6B TE-17
D803	9JDDE7RB5R62B	DIODE ZENER	UDZS5.6B TE-17
D804	9JDD7R20S300	DIODE SCHOTTKY BARRIER	RB520S-30-TE61
D805	9JDD7R20S300	DIODE SCHOTTKY BARRIER	RB520S-30-TE61
D806	9JDDE7RB5R62B	DIODE ZENER	UDZS5.6B TE-17
D807	9JDDE7RB5R62B	DIODE ZENER	UDZS5.6B TE-17
D808	9JDDE7RB5R62B	DIODE ZENER	UDZS5.6B TE-17
D809	9JDDE7RB5R62B	DIODE ZENER	UDZS5.6B TE-17
D810	9JDDE7RB5R62B	DIODE ZENER	UDZS5.6B TE-17
D811	9JDDE7RB5R62B	DIODE ZENER	UDZS5.6B TE-17
D812	9JDDE7RB5R62B	DIODE ZENER	UDZS5.6B TE-17
D813	9JDDE7RB5R62B	DIODE ZENER	UDZS5.6B TE-17
D814	9JDDE7RB5R62B	DIODE ZENER	UDZS5.6B TE-17
D815	9JDDE7RB5R62B	DIODE ZENER	UDZS5.6B TE-17
D816	9JDDE7RB5R62B	DIODE ZENER	UDZS5.6B TE-17
D817	9JDDE7RB5R62B	DIODE ZENER	UDZS5.6B TE-17
D818	9JDDE7RB5R62B	DIODE ZENER	UDZS5.6B TE-17
D819	9JDDE7RB5R62B	DIODE ZENER	UDZS5.6B TE-17
D820	9JDDE7RB5R62B	DIODE ZENER	UDZS5.6B TE-17
D821	9JDDE7RB5R62B	DIODE ZENER	UDZS5.6B TE-17
D822	9JDDE7RB5R62B	DIODE ZENER	UDZS5.6B TE-17
D823	9JDDE7RB5R62B	DIODE ZENER	UDZS5.6B TE-17
D824	9JDDE7RB5R62B	DIODE ZENER	UDZS5.6B TE-17
D825	9JDDE7RB5R62B	DIODE ZENER	UDZS5.6B TE-17
D826	9JDDE7RB5R62B	DIODE ZENER	UDZS5.6B TE-17
D827	9JDDE7RB5R62B	DIODE ZENER	UDZS5.6B TE-17
D828	9JDDE7RB5R62B	DIODE ZENER	UDZS5.6B TE-17
D829	9JDDE7RB5R62B	DIODE ZENER	UDZS5.6B TE-17
D3200	9JDD28R11FS20	DIODE	EC11FS2-TE12L

ELECTRICAL REPLACEMENT PART LIST

D3201	9JDD28R11FS20	DIODE	EC11FS2-TE12L
D3208	9JDD28R11FS20	DIODE	EC11FS2-TE12L
D3401	9JDD28R1QS040	DIODE	EC31QS04-TE12L
D3402	9JDD28R1QS040	DIODE	EC31QS04-TE12L
D3403	9JDD28R1QS040	DIODE	EC31QS04-TE12L
D3404	9JDD28R1QS040	DIODE	EC31QS04-TE12L
D3405	9JDD28R1QS040	DIODE	EC31QS04-TE12L
D3407	9JDDE7RB3602B	DIODE ZENER	UDZS36B TE-17
D3409	9JDD28R11FS20	DIODE	EC11FS2-TE12L
D3804	9JDD28R11FS20	DIODE	EC11FS2-TE12L
D4200	9JDDE7RB5R62B	DIODE ZENER	UDZS5.6B TE-17
D4205	9JDDE7RB1202B	DIODE ZENER	UDZS12B TE-177
D4206	9JDDE7RB1202B	DIODE ZENER	UDZS12B TE-177
D4207	9JDDE7RB3R32B	DIODE ZENER	UDZS3.3B TE-17
D4209	9JDDE7RB5R62B	DIODE ZENER	UDZS5.6B TE-17
D4210	9JDDE7RB4R72B	DIODE ZENER	UDZS4.7B TE-17
D4211	9JDDE7RB4R72B	DIODE ZENER	UDZS4.7B TE-17
D4212	9JDDE7RB3R32B	DIODE ZENER	UDZS3.3B TE-17
D4303	9JDDE7RB5R62B	DIODE ZENER	UDZS5.6B TE-17
D4305	9JDDGERMA1110	DIODE SILICON	MA111-(TX)
D4313	9JDDE7RB5R62B	DIODE ZENER	UDZS5.6B TE-17
D7200	9JDD15R002500	DIODE SILICON	1SS250

*** ICS ***

IC102	9JDICMF032200	IC	ISL83220ECVZ-T
 IC302	9JDI03SP20520	IC	LA42052-E
IC801	9JDS31A03EE01	MEMORY DATA	AT24C256BN-10SU-1.8
IC802	9JDI9UF032290	IC	PST3229NR
IC803	9JDS31A14EM01	MEMORY DATA	VCT-6773G-FA-B3-000
IC3205	9JDI1KF98D050	IC	KIA78D05F
 IC3400	9JDI07F0C0WF0	IC	BA00BC0WFP-E2
 IC3401	9JDI07F078200	IC	BD7820FP-E2
 IC3402	9JDI07F078200	IC	BD7820FP-E2
 IC3403	9JDI1KJ9A431A	IC	KIA431A-AT
 IC3404	9JDI07F0C0WF0	IC	BA00BC0WFP-E2
IC7200	9JDI1SF023800	IC	KE454U2380TFP
IC7201	9JDI07J9139A0	IC	BD8139AEFV

*** TRANSISTORS ***

Q001	9JDT2AA5132E0	FET	KTK5132E-RTK/P
Q002	9JDT2AA5132E0	FET	KTK5132E-RTK/P
Q300	9JDTPAAB05001	COMPOUND TRANSISTOR	KRA102SRTK
Q301	9JDTCAA3875SY	TRANSISTOR SILICON	KTC3875S_Y_RTK
Q302	9JDTCAA3875SY	TRANSISTOR SILICON	KTC3875S_Y_RTK
Q303	9JDTCAA3875SY	TRANSISTOR SILICON	KTC3875S_Y_RTK
Q304	9JDTAAA1504SY	TRANSISTOR SILICON	KTA1504S_Y_RTK
Q3400	9JDTAAA1504SY	TRANSISTOR SILICON	KTA1504S_Y_RTK
Q3401	9JDTNAA05003	COMPOUND TRANSISTOR	KRC102SRTK
Q3402	9JDTAAA1504SY	TRANSISTOR SILICON	KTA1504S_Y_RTK
Q3403	9JDTNAA05003	COMPOUND TRANSISTOR	KRC102SRTK
Q3404	9JDTNAA05003	COMPOUND TRANSISTOR	KRC102SRTK
Q3405	9JDTAAA01664Y	TRANSISTOR SILICON	KTA1664-Y-RTF/P
Q3406	9JDTNAA05003	COMPOUND TRANSISTOR	KRC102SRTK
Q3407	9JDTAAA01664Y	TRANSISTOR SILICON	KTA1664-Y-RTF/P
Q3408	9JDTNAA05003	COMPOUND TRANSISTOR	KRC102SRTK
Q3409	9JDTNAA05003	COMPOUND TRANSISTOR	KRC102SRTK
Q4202	9JDTAAA1504SY	TRANSISTOR SILICON	KTA1504S_Y_RTK
Q4203	9JDTAAA1504SY	TRANSISTOR SILICON	KTA1504S_Y_RTK
Q4204	9JDTCAA3875SY	TRANSISTOR SILICON	KTC3875S_Y_RTK
Q4205	9JDTCAA3875SY	TRANSISTOR SILICON	KTC3875S_Y_RTK
Q4207	9JDTCAA3875SY	TRANSISTOR SILICON	KTC3875S_Y_RTK
Q4208	9JDTCAA3875SY	TRANSISTOR SILICON	KTC3875S_Y_RTK
Q4209	9JDTCAA3875SY	TRANSISTOR SILICON	KTC3875S_Y_RTK
Q4210	9JDTCAA3875SY	TRANSISTOR SILICON	KTC3875S_Y_RTK
Q4212	9JDTCAA3875SY	TRANSISTOR SILICON	KTC3875S_Y_RTK

ELECTRICAL REPLACEMENT PART LIST

Q4213	9JDTAAA1504SY	TRANSISTOR SILICON	KTA1504S_Y_RTK
Q4214	9JDTAAA1504SY	TRANSISTOR SILICON	KTA1504S_Y_RTK
Q4215	9JDTCAA3875SY	TRANSISTOR SILICON	KTC3875S_Y_RTK
Q4216	9JDTPAAC05002	COMPOUND TRANSISTOR	KRA103SRTK
Q4217	9JDTPAAC05002	COMPOUND TRANSISTOR	KRA103SRTK
Q4218	9JDTNAA05003	COMPOUND TRANSISTOR	KRC102SRTK
Q4219	9JDTNAA05003	COMPOUND TRANSISTOR	KRC102SRTK
Q4305	9JDTPAAB05001	COMPOUND TRANSISTOR	KRA102SRTK
Q4308	9JDTPAAB05001	COMPOUND TRANSISTOR	KRA102SRTK
Q4309	9JDTNAA05003	COMPOUND TRANSISTOR	KRC102SRTK
Q4310	9JDTNAA05003	COMPOUND TRANSISTOR	KRC102SRTK
Q7200	9JDT83J045200	TRANSISTOR SILICON	2SC4520T-TD-E
Q7201	9JDTAAA1544T0	TRANSISTOR SILICON	KTA1544T-RTK/P
Q7202	9JDT63J017290	TRANSISTOR SILICON	2SA1729-TD-E
Q7203	9JDTN7MD09001	COMPOUND,TRANSISTOR	DTC144EE TL
Q7204	9JDT27T030180	FET	2SK3018T106
Q7205	9JDT27T030180	FET	2SK3018T106
*** COILS ***			
B001	9JD024HT03563	CORE,BEADS	W4BRH3.5X6X1.0X2
B002	9JD024HC56013	CORE,BEADS	FCM1608KF-601T02
B103	9JD024HC51023	CORE,BEADS	FCM1608KF-102T02
B105	9JD024HC51023	CORE,BEADS	FCM1608KF-102T02
B300	9JD024HT03564	CORE,BEADS	W4BRH3.5X6X1.0
B301	9JD024HT03564	CORE,BEADS	W4BRH3.5X6X1.0
B302	9JD024HT03564	CORE,BEADS	W4BRH3.5X6X1.0
B303	9JD024HT03563	CORE,BEADS	W4BRH3.5X6X1.0X2
B304	9JD024HT03563	CORE,BEADS	W4BRH3.5X6X1.0X2
B305	9JD024HT03564	CORE,BEADS	W4BRH3.5X6X1.0
B306	9JD024HT03564	CORE,BEADS	W4BRH3.5X6X1.0
B307	9JD024HT03564	CORE,BEADS	W4BRH3.5X6X1.0
B801	9JD024HC51816	CORE,BEADS	HCB1608KF-181T20
B802	9JD024HC51816	CORE,BEADS	HCB1608KF-181T20
B803	9JD024HC51816	CORE,BEADS	HCB1608KF-181T20
B804	9JD024HC51816	CORE,BEADS	HCB1608KF-181T20
B805	9JD024HC51816	CORE,BEADS	HCB1608KF-181T20
B806	9JD024HC51816	CORE,BEADS	HCB1608KF-181T20
B807	9JD024HC51816	CORE,BEADS	HCB1608KF-181T20
B808	9JD024HC51816	CORE,BEADS	HCB1608KF-181T20
B809	9JD024HC51816	CORE,BEADS	HCB1608KF-181T20
B810	9JD024HC51816	CORE,BEADS	HCB1608KF-181T20
B811	9JD024HC51816	CORE,BEADS	HCB1608KF-181T20
B812	9JD024HC51816	CORE,BEADS	HCB1608KF-181T20
B813	9JD024HC56005	CORE,BEADS	FCM1608CF-600T06
B818	9JD024HC51816	CORE,BEADS	HCB1608KF-181T20
B819	9JD024HC51816	CORE,BEADS	HCB1608KF-181T20
B3400	9JD024HC51216	CORE,BEADS	HCB1608KF-121T20
B3401	9JD024HC51216	CORE,BEADS	HCB1608KF-121T20
B3402	9JD024HC51216	CORE,BEADS	HCB1608KF-121T20
B3403	9JD024HC51216	CORE,BEADS	HCB1608KF-121T20
B3404	9JD024HC51216	CORE,BEADS	HCB1608KF-121T20
B3405	9JD024HC51216	CORE,BEADS	HCB1608KF-121T20
B4201	9JD024HC56005	CORE,BEADS	FCM1608CF-600T06
B4202	9JD024HC56005	CORE,BEADS	FCM1608CF-600T06
B4203	9JD024HC56013	CORE,BEADS	FCM1608KF-601T02
B4204	9JD024HC56013	CORE,BEADS	FCM1608KF-601T02
B4205	9JD0246C51024	CORE,BEADS	MMZ1608R102CT
B4206	9JD0246C51024	CORE,BEADS	MMZ1608R102CT
B4208	9JD024HC56005	CORE,BEADS	FCM1608CF-600T06
B4217	9JD0246C51024	CORE,BEADS	MMZ1608R102CT
B4218	9JD024HC56005	CORE,BEADS	FCM1608CF-600T06
B4302	9JD024NC51021	CORE,BEADS	EBMS160808A102_RDC45
B4303	9JD024HC56005	CORE,BEADS	FCM1608CF-600T06
B4304	9JD024HC56005	CORE,BEADS	FCM1608CF-600T06
B4305	9JD024HC56005	CORE,BEADS	FCM1608CF-600T06
B4306	9JD024HC51816	CORE,BEADS	HCB1608KF-181T20

ELECTRICAL REPLACEMENT PART LIST

B4307	9JD024HC51816	CORE,BEADS	HCB1608KF-181T20
B4309	9JD024HC51816	CORE,BEADS	HCB1608KF-181T20
B4310	9JD024HC56005	CORE,BEADS	FCM1608CF-600T06
B4314	9JD024NC51021	CORE,BEADS	EBMS160808A102_RDC45
B4318	9JD024HC51816	CORE,BEADS	HCB1608KF-181T20
B4323	9JD024HC56005	CORE,BEADS	FCM1608CF-600T06
B7201	9JD024HC51816	CORE,BEADS	HCB1608KF-181T20
B7202	9JD024HC51816	CORE,BEADS	HCB1608KF-181T20
B7203	9JD024HC51816	CORE,BEADS	HCB1608KF-181T20
B7204	9JD024HC56005	CORE,BEADS	FCM1608CF-600T06
B7205	9JD024HC51816	CORE,BEADS	HCB1608KF-181T20
L103	9JD0216SD220J	COIL	22 UH
L800	9JD0216SD2R2J	COIL	2.2 UH
L802	9JD0216SD2R2J	COIL	2.2 UH
L803	9JD0216SD2R2J	COIL	2.2 UH
L804	9JD0216SD2R2J	COIL	2.2 UH
L805	9JD0216SD2R2J	COIL	2.2 UH
L806	9JD0216SD2R2J	COIL	2.2 UH
L3400	9JD021LA6470J	COIL	47 UH
L4202	9JD021LA6220J	COIL	22 UH
L4203	9JD021LA6220J	COIL	22 UH
L4204	9JD021LA6220J	COIL	22 UH
L4205	9JD021LA6220J	COIL	22 UH
L4206	9JD021LA6220J	COIL	22 UH
L4207	9JD021LA6220J	COIL	22 UH
L4208	9JD0216SD220J	COIL	22 UH
L4211	9JD021LA6220J	COIL	22 UH
L4212	9JD021LA6220J	COIL	22 UH
L4214	9JD021LA6220J	COIL	22 UH
L4217	9JD021LA6220J	COIL	22 UH
L4227	9JD0216SD220J	COIL	22 UH
L7201	9JD0216S8470K	COIL	47 UH
L7202	9JD0216SD2R2J	COIL	2.2 UH
*** JACKS ***			
CP102	9JD063W100053	JACK	MD24-95V-EC
J4200	9JD060K411041	RCA JACK	AV2-13P2-07H
J4205	9JD063Y100070	SOCKET,21PIN	RGB-16C
J4206	9JD063Y100070	SOCKET,21PIN	RGB-16C
J4208	9JD060J131019	HEADPHONE JACK	MSJ-2000B_AG(O87)
*** CONNECTORS ***			
CP301	9JD069S270629	CONNECTOR PCB SIDE	A2001WV2-7P
CP302	9JD069S140419	CONNECTOR PCB SIDE	A2502WV2-4P
CP802	9JD069S260629	CONNECTOR PCB SIDE	A2001WV2-6P
CP3400	9JD069S270639	CONNECTOR PCB SIDE	A2001WR2-7P
CP3401	9JD069S2E0639	CONNECTOR PCB SIDE	A2001WR2-14P
CP4201	9JD069EVB3030	CONNECTOR PCB SIDE	00_6232_011_006_800+
CP4301	9JD069S260629	CONNECTOR PCB SIDE	A2001WV2-6P
CP7201	9JD06AAY08019	CONNECTOR PCB SIDE	QS0CNA222WJZZYH(41)
*** CRYSTAL & CERAMIC OSCILLATORS ***			
X801	9JD100DT02007	CRYSTAL	DSX840GA
*** NETWORKS ***			
NR801	9JD110P4470M4	R,NETWORK	4D03WGJ0470T5E
NR802	9JD110P4470M4	R,NETWORK	4D03WGJ0470T5E
NR803	9JD110P4470M4	R,NETWORK	4D03WGJ0470T5E
NR7200	9JD110P4330M4	R,NETWORK	4D03WGJ0330T5E

ELECTRICAL REPLACEMENT PART LIST

*** OTHERS ***











CP4302	9JD06G2S21501	CONNECTOR PCB SIDE	D229FD015G107BY
SH4301	9JD126D000044	TERMINAL PIN	YQ-36
SH4302	9JD126D000044	TERMINAL PIN	YQ-36
SH4303	9JD126D000044	TERMINAL PIN	YQ-36
SH4304	9JD126D000044	TERMINAL PIN	YQ-36
SH4305	9JD126D000044	TERMINAL PIN	YQ-36
SH4306	9JD126D000044	TERMINAL PIN	YQ-36

POWER PCB ASS'Y













*** PCB ***

PCB240	9JDA31A14E240L	POWER PCB ASS'Y	CEF279A
--------	----------------	-----------------	---------

*** RESISTORS ***

 R505	9JDR31X1155J	RC	1.5M OHM 1W
 R506	9JDR3X181R27J	R,METAL OXIDE	0.27 OHM 1W
 R507	9JDR65584101J	R,FUSE	100 OHM 1/4W
 R511	9JDR3K781104J	R,METAL OXIDE	100K OHM 1W
 R514	9JDR63881R22J	R,FUSE	0.22 OHM 1W
 R516	9JDR31X1126J	RC	12M OHM 1W
 R527	9JDR65584150J	R,FUSE	15 OHM 1/4W
 R528	9JDR65584150J	R,FUSE	15 OHM 1/4W
 R547	9JDR3K28A220J	R,METAL	22 OHM 2W
 R568	9JDR3X28A2R7J	R,METAL OXIDE	2.7 OHM 2W

*** CAPACITORS ***

 C503	9JDP2122B224M	CMP	0.22 UF 275V ECQUL
C504	9JDC03L0R7Q2K	CC	470 PF 2KV R
 C506	9JDP2122B104M	CMP	0.1 UF 275V ECQUL
 C509	9JDP2122B224M	CMP	0.22 UF 275V ECQUL
 C514	9JDE77CHH181M	CE	180 UF 400V
C515	9JDP332E4393J	CPP	0.039 UF 400V
 C522	9JDE8E2U5220D	CE	22 UF 50V
 C523	9JDE7EYF3182M	CE	1800 UF 25V
 C524	9JDE7EYF2102M	CE	1000 UF 16V
 C525	9JDE8E2U5470D	CE	47 UF 50V
 C526	9JDE8E2U5220D	CE	22 UF 50V
 C527	9JDE7EYF3182M	CE	1800 UF 25V
 C532	9JDE7EYF2102M	CE	1000 UF 16V
 C554	9JDCD39E0MH3M	CC	0.0022UF 250V
C6700	9JDP4J7F3683J	CMPP	0.068 UF 250V PMS
C6704	9JDE8E173821M	CE	820 UF 25V
C6705	9JDP4J7F3683J	CMPP	0.068 UF 250V PMS
C6709	9JDE8E173821M	CE	820 UF 25V
C6712	9JDP4J7F3683J	CMPP	0.068 UF 250V PMS
C6716	9JDE8E173821M	CE	820 UF 25V
C6717	9JDP4J7F3683J	CMPP	0.068 UF 250V PMS
C6721	9JDE8E173821M	CE	820 UF 25V
C6724	9JDP4J7F3683J	CMPP	0.068 UF 250V PMS
C6728	9JDE8E173821M	CE	820 UF 25V

*** DIODES ***

 D501	9JDD6C047110A	DIODE VARISTA	ENE471D-10A
 D502	9JDD4AT01H3E0	DIODE RECTIFIER	1H3-E
 D503	9JDD2WXN40050	DIODE SILICON	1N4005-EIC
 D504	9JDD2WXN40050	DIODE SILICON	1N4005-EIC
D505	9JDD4AT01H3E0	DIODE RECTIFIER	1H3-E
 D506	9JDD2WTRM11C0	DIODE SILICON	RM11C-EIC
 D507	9JDD2WTRM11C0	DIODE SILICON	RM11C-EIC
 D508	9JDD2WTRM11C0	DIODE SILICON	RM11C-EIC

ELECTRICAL REPLACEMENT PART LIST

▲D509	9JDD2WTRM11C0	DIODE SILICON	RM11C-EIC
D510	9JDD97U06R21B	DIODE,ZENER	MTZJ6.2B T-77
D511	9JDD1VT001330	DIODE,SILICON	1SS133T-77
D512	9JDD2BXARS010	DIODE SILICON	SARS01-V1
D513	9JDD97U05R61B	DIODE,ZENER	MTZJ5.6B T-77
▲D514	9JDD4AT01H3E0	DIODE RECTIFIER	1H3-E
▲D515	9JDD2BAMX22S0	DIODE SCHOTTKY	FMX-22S
D516	9JDD97U06R21B	DIODE,ZENER	MTZJ6.2B T-77
D517	9JDD4CRSK34A0	DIODE SCHOTTKY	SK34A
▲D518	9JDD4AT01H3E0	DIODE RECTIFIER	1H3-E
▲D519	9JDD2LT001F50	DIODE SILICON	1F5-E
▲D520	9JDD23A0010J0	DIODE SCHOTTKY	SBR100-10J-CBC11
D521	9JDD1VT001330	DIODE,SILICON	1SS133T-77
D522	9JDD97U03R31B	DIODE,ZENER	MTZJ3.3B T-77
D523	9JDD97U01301B	DIODE,ZENER	MTZJ13B T-77
D524	9JDD1VT001330	DIODE,SILICON	1SS133T-77
D525	9JDD97U02001B	DIODE,ZENER	MTZJ20B T-77
D535	9JDD97U03001B	DIODE,ZENER	MTZJ30B T-77
▲D536	9JDD2LKS3400	DIODE SCHOTTKY	SR340-004
D6700	9JDD27PAN2020	DIODE,FAST RECOVERY	DAN202KT146
D6701	9JDD27PAN2020	DIODE,FAST RECOVERY	DAN202KT146
D6702	9JDD27PAN2020	DIODE,FAST RECOVERY	DAN202KT146
D6703	9JDDD1R0157A0	DIODE SILICON	MA157A-(TX)
D6704	9JDDD1R0157A0	DIODE SILICON	MA157A-(TX)
D6705	9JDD27PAN2020	DIODE,FAST RECOVERY	DAN202KT146
D6707	9JDDD1R0157A0	DIODE SILICON	MA157A-(TX)
D6708	9JDDD1R0157A0	DIODE SILICON	MA157A-(TX)
D6709	9JDD27PAN2020	DIODE,FAST RECOVERY	DAN202KT146
D6710	9JDDD1R0157A0	DIODE SILICON	MA157A-(TX)
D6711	9JDD27PAN2020	DIODE,FAST RECOVERY	DAN202KT146

*** ICS ***

▲IC501	9JDI2BT067650	IC	STR-W6765
▲IC502	9JD000220002W	PHOTO COUPLER	PS2561AL1-1-V(W)
▲IC503	9JDI1KJ9A431A	IC	KIA431A-AT
▲IC504	9JDI03T057790	IC	LA5779-E

*** TRANSISTORS ***

Q501	9JDTCAA3875SY	TRANSISTOR SILICON	KTC3875S_Y_RTK
Q502	9JDTPAAB05001	COMPOUND TRANSISTOR	KRA102SR TK
Q503	9JDTNAA05003	COMPOUND TRANSISTOR	KRC102SR TK
Q504	9JDTNAA05003	COMPOUND TRANSISTOR	KRC102SR TK
Q505	9JDTCAA3875SY	TRANSISTOR SILICON	KTC3875S_Y_RTK
Q506	9JDTAAA1504SY	TRANSISTOR SILICON	KTA1504S_Y_RTK
Q511	9JDTCAA3875SY	TRANSISTOR SILICON	KTC3875S_Y_RTK
Q512	9JDTAAA1504SY	TRANSISTOR SILICON	KTA1504S_Y_RTK
Q513	9JDTAAT01281Y	TRANSISTOR SILICON	KTA1281_Y
Q6700	9JDT85A058860	TRANSISTOR SILICON	2SC5886A
Q6701	9JDT85A058860	TRANSISTOR SILICON	2SC5886A
Q6702	9JDTAAA1504SY	TRANSISTOR SILICON	KTA1504S_Y_RTK
Q6703	9JDT85A058860	TRANSISTOR SILICON	2SC5886A
Q6704	9JDT85A058860	TRANSISTOR SILICON	2SC5886A
Q6705	9JDTAAA1504SY	TRANSISTOR SILICON	KTA1504S_Y_RTK
Q6706	9JDT85A058860	TRANSISTOR SILICON	2SC5886A
Q6707	9JDT85A058860	TRANSISTOR SILICON	2SC5886A
Q6708	9JDT85A058860	TRANSISTOR SILICON	2SC5886A
Q6709	9JDTAAA1504SY	TRANSISTOR SILICON	KTA1504S_Y_RTK
Q6710	9JDT85A058860	TRANSISTOR SILICON	2SC5886A
Q6711	9JDT85A058860	TRANSISTOR SILICON	2SC5886A
Q6712	9JDTAAA1504SY	TRANSISTOR SILICON	KTA1504S_Y_RTK
Q6713	9JDT85A058860	TRANSISTOR SILICON	2SC5886A
Q6714	9JDT85A058860	TRANSISTOR SILICON	2SC5886A
Q6715	9JDT85A058860	TRANSISTOR SILICON	2SC5886A
Q6716	9JDTAAA1504SY	TRANSISTOR SILICON	KTA1504S_Y_RTK
Q6717	9JDT85A058860	TRANSISTOR SILICON	2SC5886A

ELECTRICAL REPLACEMENT PART LIST

*** COILS ***

B508	9JD024HT03564	CORE,BEADS	W4BRH3.5X6X1.0
L504	9JD02167E220K	COIL	22 UH
L505	9JD02167B470J	COIL	47 UH
L506	9JD02186I6R8L	COIL	6.8 UH
L507	9JD02186I6R8L	COIL	6.8 UH
L509	9JD02167E220K	COIL	22 UH
▲L510	9JD029X000113	COIL,LINE FILTER	SS24V-K07325
▲L511	9JD029X000113	COIL,LINE FILTER	SS24V-K07325
L512	9JD02167B101J	COIL	100 UH
L513	9JD02120K470M	COIL	47 UH
L6700	9JD021L3J101K	COIL	100 UH
L6701	9JD021L3J101K	COIL	100 UH
L6702	9JD021L3J101K	COIL	100 UH
L6703	9JD021L3J101K	COIL	100 UH
L6704	9JD021L3J101K	COIL	100 UH

*** TRANSFORMERS ***

▲T501	9JD0481400834	TRANSFORMER,SWITCHING	81400834
▲T6700	9JD0481180011	TRANSFORMER,SWITCHING	ETJV27ZJ18BC
▲T6701	9JD0481180011	TRANSFORMER,SWITCHING	ETJV27ZJ18BC
▲T6702	9JD0481180011	TRANSFORMER,SWITCHING	ETJV27ZJ18BC
▲T6703	9JD0481180011	TRANSFORMER,SWITCHING	ETJV27ZJ18BC
▲T6704	9JD0481180011	TRANSFORMER,SWITCHING	ETJV27ZJ18BC

*** JACKS ***

▲CP501	9JD064Q1A0003	JACK,AC	CCT2302-0911
--------	---------------	---------	--------------

*** CONNECTORS ***

CP502	9JD069S270629	CONNECTOR PCB SIDE	A2001WV2-7P
CP503	9JD069S2E0629	CONNECTOR PCB SIDE	A2001WV2-14P
CD3401	9JD06CU271301	CORD CONNECTOR	CU271301
CD3402	9JD06CU2E1301	CORD CONNECTOR	CU2E1301
CP6700	9JD0694W23019	CONNECTOR PCB SIDE	1747386-1
CP6701	9JD0694W23019	CONNECTOR PCB SIDE	1747386-1
CP6702	9JD0694W23019	CONNECTOR PCB SIDE	1747386-1
CP6703	9JD0694W23019	CONNECTOR PCB SIDE	1747386-1
CP6705	9JD0694W23019	CONNECTOR PCB SIDE	1747386-1

*** FUSES ***

▲F501	9JD080NT04004	FUSE	50T040H
FH501	9JD06710T0009	HOLDER,FUSE	EYF-52BCY
FH502	9JD06710T0009	HOLDER,FUSE	EYF-52BCY
▲F6700	9JD0804U01001	FUSE	SBL10CDL
▲F6701	9JD0804U01001	FUSE	SBL10CDL
▲F6702	9JD0804U01001	FUSE	SBL10CDL
▲F6703	9JD0804U01001	FUSE	SBL10CDL
▲F6704	9JD0804U01001	FUSE	SBL10CDL

*** THERMISTOR ***

▲TH501	9JDDSR0LDNB00	THERMISTOR	NTPAA2R2LDNB0
--------	---------------	------------	---------------

*** OTHERS ***

EL2401	9JD124116281A	EYE LET	XRY16X28BD
EL2402	9JD124120301A	EYE LET	XRY20X30BD
SH501	9JD126D000044	TERMINAL PIN	YQ-36
SH502	9JD126D000044	TERMINAL PIN	YQ-36

ELECTRICAL REPLACEMENT PART LIST

SH503	9JD126D000044	TERMINAL PIN	YQ-36
SH507	9JD126D000044	TERMINAL PIN	YQ-36
		OPERATION PCB ASS'Y	
		*** PCB ***	
PCB270	9JDA31A14E270L	OPERATION PCB ASS'Y	CEF280A
		*** COILS ***	
B2200	9JD024HC51816	CORE,BEADS	HCB1608KF-181T20
B2201	9JD024HC51816	CORE,BEADS	HCB1608KF-181T20
B2202	9JD024HC51816	CORE,BEADS	HCB1608KF-181T20
B2203	9JD0246C51024	CORE,BEADS	MMZ1608R102CT
B2204	9JD0246C51024	CORE,BEADS	MMZ1608R102CT
B2205	9JD0246C51024	CORE,BEADS	MMZ1608R102CT
		*** JACKS ***	
J2201	9JD060R431033	RCA JACK	RCA-359HA-00A-01
J2202	9JD060R131024	HEADPHONE JACK	PJ-364H
		*** SWITCHES ***	
SW2201	9JD0504101T34	SWITCH,TACT	EVQ21505R
SW2202	9JD0504101T34	SWITCH,TACT	EVQ21505R
SW2203	9JD0504101T34	SWITCH,TACT	EVQ21505R
SW2204	9JD0504101T34	SWITCH,TACT	EVQ21505R
SW2205	9JD0504101T34	SWITCH,TACT	EVQ21505R
SW2206	9JD0504101T34	SWITCH,TACT	EVQ21505R
SW2207	9JD0504101T34	SWITCH,TACT	EVQ21505R
		*** CONNECTORS ***	
CD2200	9JD06CU272301	CORD CONNECTOR	CU272301
CP2200	9JD069EVB3050	CONNECTOR PCB SIDE	00_6232_011_102_800+
		*** OTHERS ***	
J2200	9JD062R750007	PLUG	DIN-417HA-01
		AND OTHERS	
		*** CONNECTORS ***	
CD302	9JD06CU144401	CORD CONNECTOR	CU144401
CD306	9JD122H0B0803	CORD JUMPER	2H0B0803
CD7201	9JD12BR080121	CORD JUMPER	FFC058012003509T1-A04
		*** TUNER ***	
 TU001	9JD0163Y03009	RF UNIT	TAFV-W323D
		*** AC CORD ***	
 CD3810	9JD120Q155804	CORD AC	P205-1324-4
		*** OTHERS ***	
BT001	9JD141R003018	BATTERY,MANGAN	GR6M
BT002	9JD141R003018	BATTERY,MANGAN	GR6M
 SP301	9JD070N435023	SPEAKER	YDP3085-2RN
 SP302	9JD070N435023	SPEAKER	YDP3085-2RN
TM101	9JD076B0NB020	TRANSMITTER	ETR0088-010151

ELECTRICAL REPLACEMENT PART LIST

V2301

9JD0956120005

LCD

LK197V3GZ91

RESISTOR

RC..... CARBON RESISTOR

CAPACITORS

CC..... CERAMIC CAPACITOR
CE..... ALUMI ELECTROLYTIC CAPACITOR
CP..... POLYESTER CAPACITOR
CPP..... POLYPROPYLENE CAPACITOR
CPL..... PLASTIC CAPACITOR
CMP..... METAL POLYESTER CAPACITOR
CMPL..... METAL PLASTIC CAPACITOR
CMPP..... METAL POLYPROPYLENE CAPACITOR

SHARP

COPYRIGHT © 2007 BY SHARP CORPORATION

ALL RIGHTS RESERVED.

No part of this publication may be reproduced, stored in a retrieval system, or transmitted in any form or by any means, electronic, mechanical, photocopying, recording, or otherwise, without prior written permission of the publisher.