

# SEC 5. EXPLODED VIEWS

---

- Items with no part number and no description are not stocked because they are seldom required for routine service.
- The construction parts of an assembled part are indicated with a collation number in the remark column.
- Items marked " \* " are not stocked since they are seldom required for routine service. Some delay should be anticipated.

The components identified by shading and mark  $\triangle$  are critical for safety. Replace only with part number specified.

The components identified by mark  $\square$  contain confidential information. Strictly follow the instructions whenever the components are repaired and/or replaced.

## 5-1. KDL-32EX700

### 5-1-1. CHASSIS-1

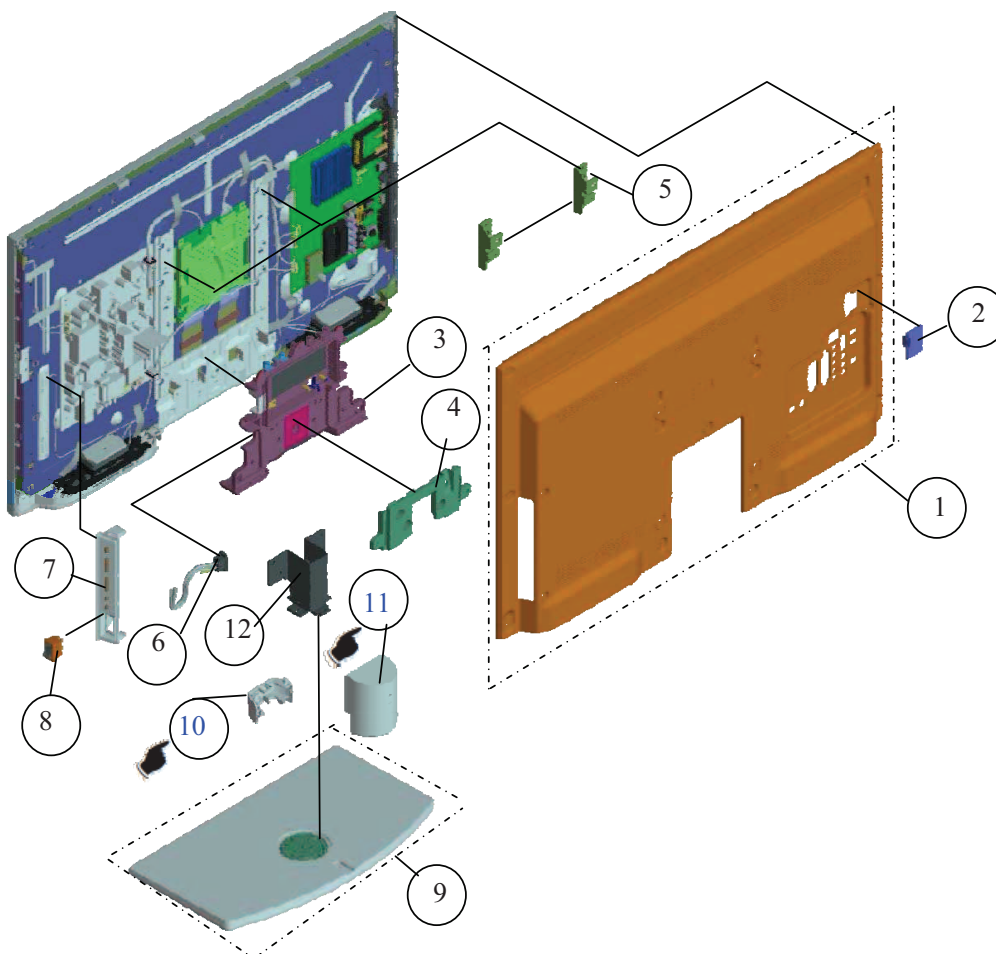

REF.NO.	PART NO.	DESCRIPTION
1	X-2547-285-1	REAR COVER
1	X-2541-871-1	REAR COVER
2	* 4-115-101-02	COVER, EC
3	4-169-434-01	COVER, UN
4	4-169-437-01	COVER, HO
5	4-164-305-01	BRACKET,
6	1-842-031-11	AC INLET (2
7	1-487-798-11	SWITCH UN
8	1-798-309-11	POWER SW
9	X-2546-096-1	BASE (M3A
10	4-170-477-01	COVER, NE
11	4-170-485-01	COVER, NE
12	4-170-449-01	NECK (M3A

## 5-1. KDL-32EX700

### 5-1-2. CHASSIS-2

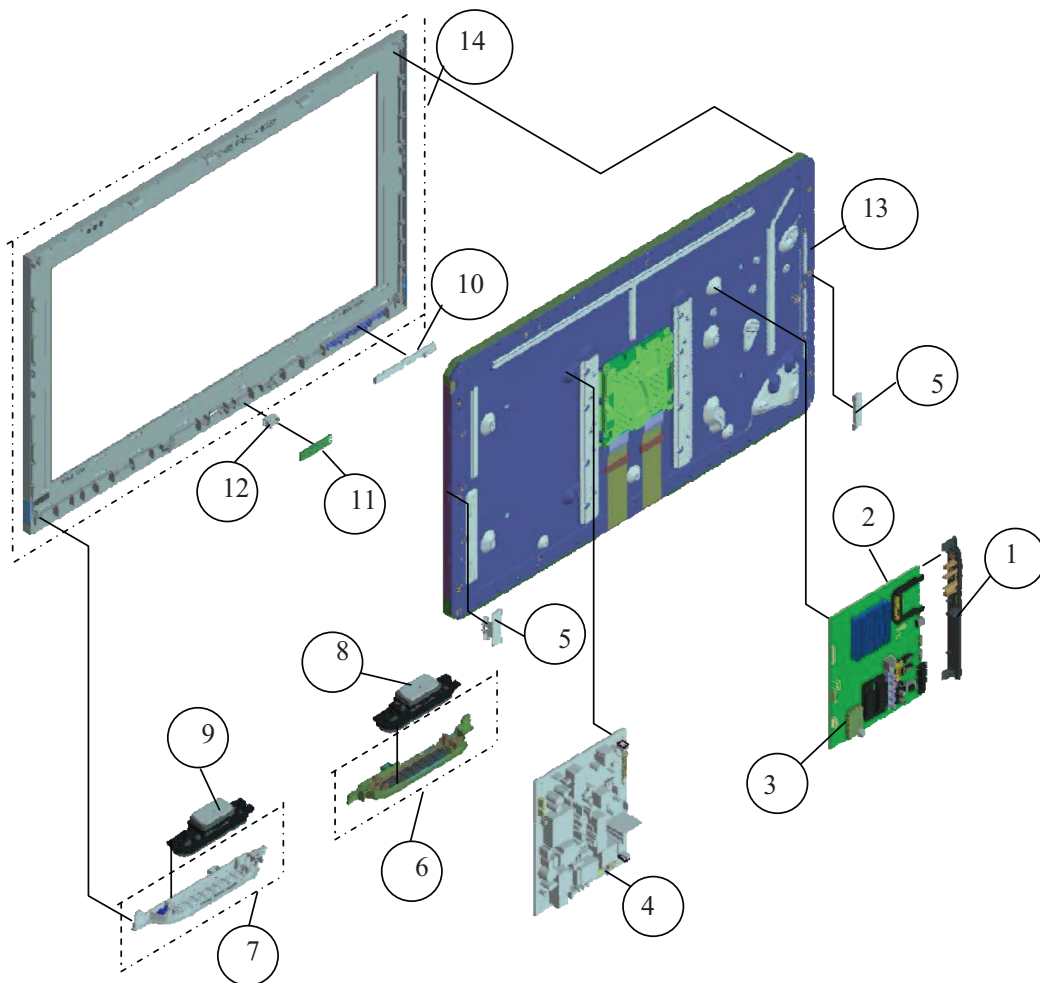

REF.NO.	PART NO.	DES
1	4-166-898-01	BR
2	A-1763-471-A	BA (32 SO
2	A-1763-470-A	BA
3	4-182-211-01	GA
4	A-1754-371-A	GE
5	4-169-442-01	BR
6	X-2547-773-1	BR
7	X-2547-771-1	BR
8,9	1-826-873-41	LO
10	A-1744-405-A	HL
11	A-1736-860-A	HM
12	1-856-068-11	LE
13	1-811-088-11	LC
14	X-2541-866-1	BE

## 5-1. KDL-32EX700

### 5-1-3. SCREWS

	PART No.	DESCRIPTION
■	2-580-639-01	SCREW, +BVTP 4X12 TYPE2 IT-3
□	2-580-611-01	SCREW, +PSW M6X16
▼	2-580-600-01	SCREW +PSW M4X8
▽	2-580-608-01	SCREW, +PSW M5X16
●	2-580-592-01	SCREW, +PSW M3X8
○	4-159-298-01	SCREW, +PSW M4X10
☆	2-580-591-01	SCREW, +PSW M3X5
★	7-685-646-79	SCREW, +BVTP 3X8 TYPE2 IT-3

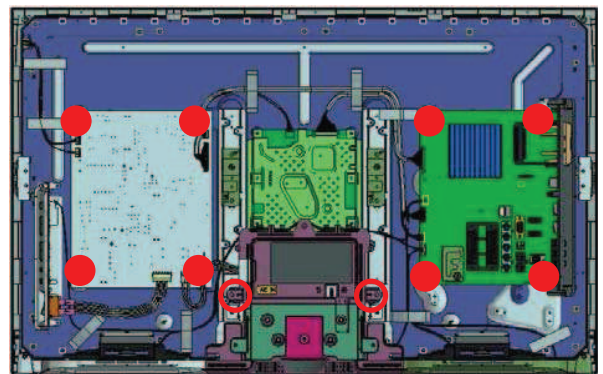
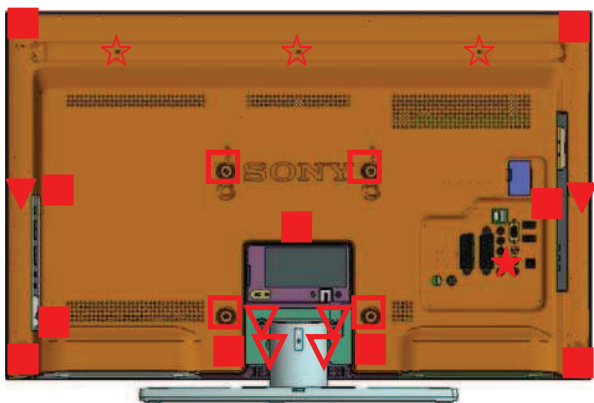

5-2. KDL-40EX700  
5-2-1. CHASSIS-1

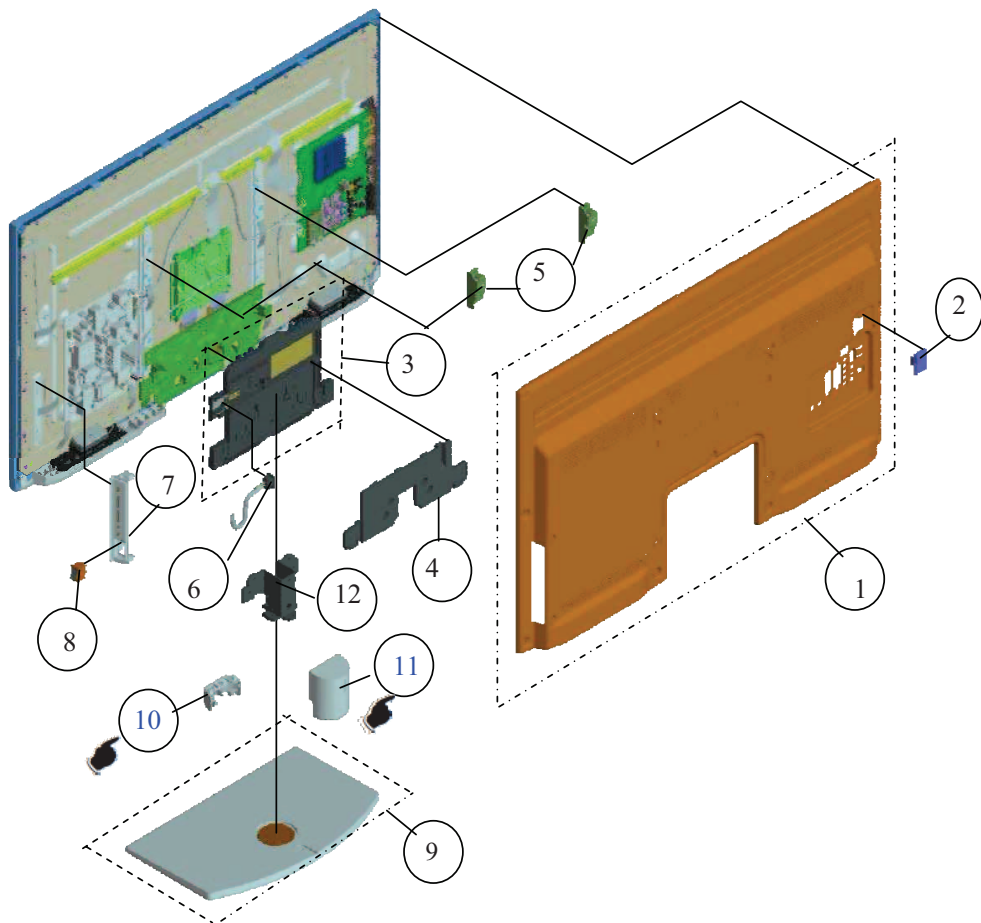

REF.NO.	PART NO.	DESCRIPTION
1	X-2547-249-1	REAR COVER (EXCEPT IRAN (SOUTH AFRICA))
1	X-2541-872-1	REAR COVER (IRAN (SOUTH AFRICA))
2	* 4-115-101-02	COVER, FRONT (40EX700(A) SOUTH AFRICA)
2	4-115-101-41	COVER, FRONT (SOUTH AFRICA)
3	X-2547-769-1	COVER, UPPER
4	4-169-438-01	COVER, HORIZONTAL
5	4-164-305-01	BRACKET
6	1-842-031-11	AC INLET
7	1-487-798-11	SWITCH UNIT
8	1-798-309-11	POWER SWITCH
9	X-2546-097-1	BASE (ML)
10	4-170-477-01	COVER, NECK
11	4-170-485-01	COVER, NECK
12	4-170-450-01	NECK (ML)

## 5-2. KDL-40EX700

### 5-2-2. CHASSIS-2

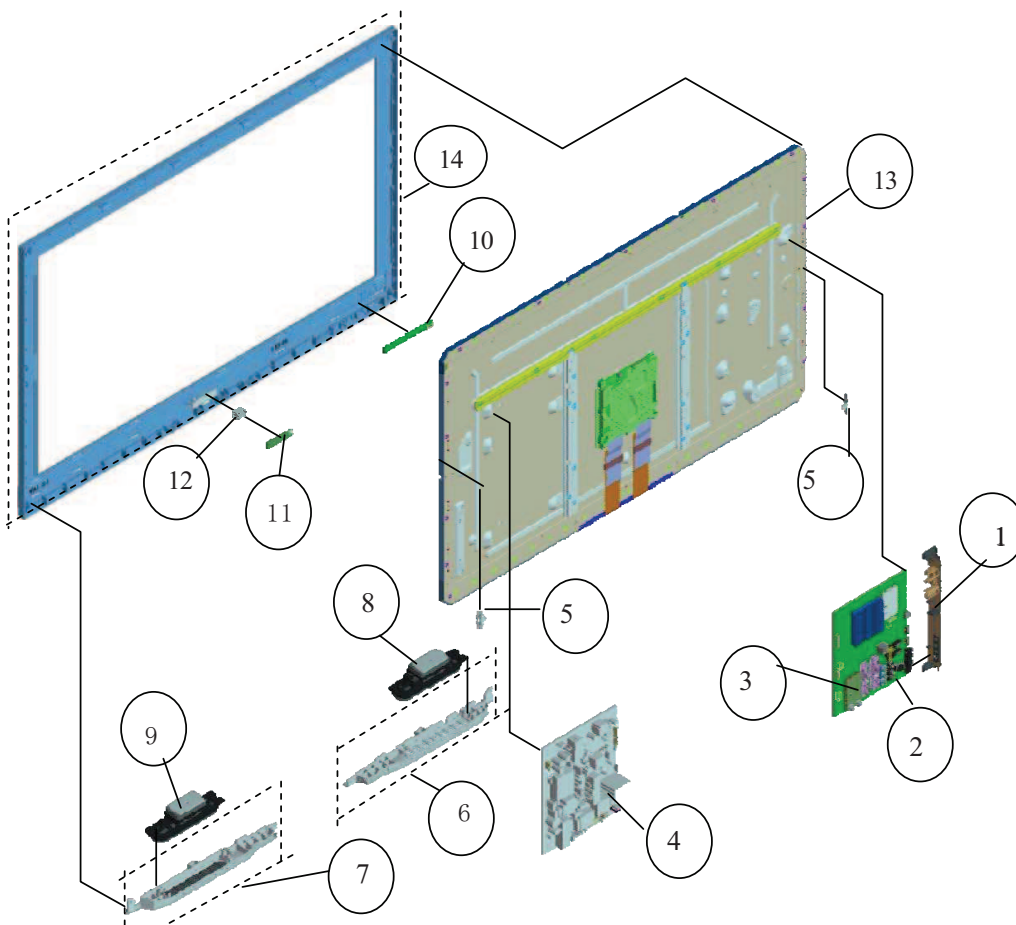

REF.NO.	PART NO.	DESCRIP
1	4-166-898-01	BRACKET
2	A-1763-471-A	BAL COM (40EX700) SINGAPO
2	A-1763-470-A	BAL COM
3	4-182-211-01	GASKET
4	A-1754-371-A	GE3A UNI
5	4-169-441-01	BRACKET
6	X-2547-777-1	BRACKET
7	X-2547-775-1	BRACKET
8,9	1-826-873-41	LOUDSPE
10	A-1744-405-A	HLR MOU
11	A-1736-860-A	HMS2 MO
12	1-856-068-11	LENS
13	A-1811-089-11	LCD PANE
14	X-2547-265-2	BEZEL (40

## 5-2. KDL-40EX700

### 5-2-3. SCREWS

	PART No.	DESCRIPTION
■	2-580-639-01	SCREW, +BVTP 4X12 TYPE2 IT-3
□	2-580-611-01	SCREW, +PSW M6X16
▲	2-580-603-01	SCREW, +PSW M4X16
▽	2-580-608-01	SCREW, +PSW M5X16
●	2-580-592-01	SCREW, +PSW M3X8
○	4-159-298-01	SCREW, +PSW M4X10
☆	2-580-591-01	SCREW, +PSW M3X5
★	7-685-646-79	SCREW, +BVTP 3X8 TYPE2 IT-3

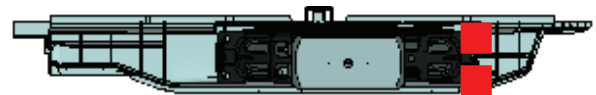
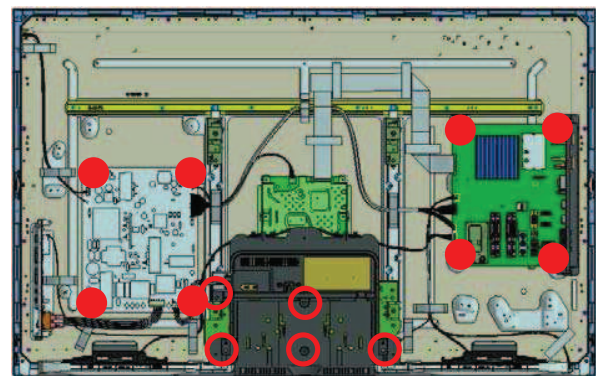
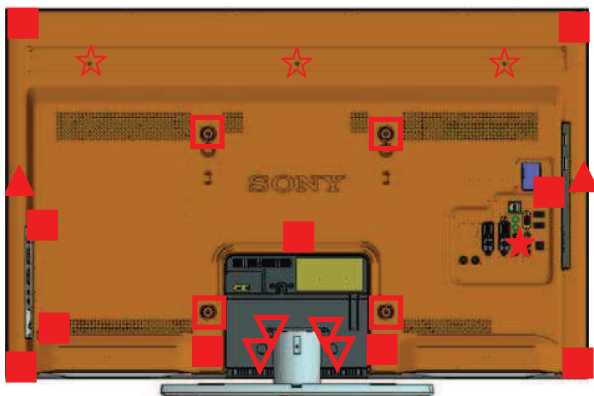

## 5-3. KDL-46EX700

### 5-3-1. CHASSIS-1

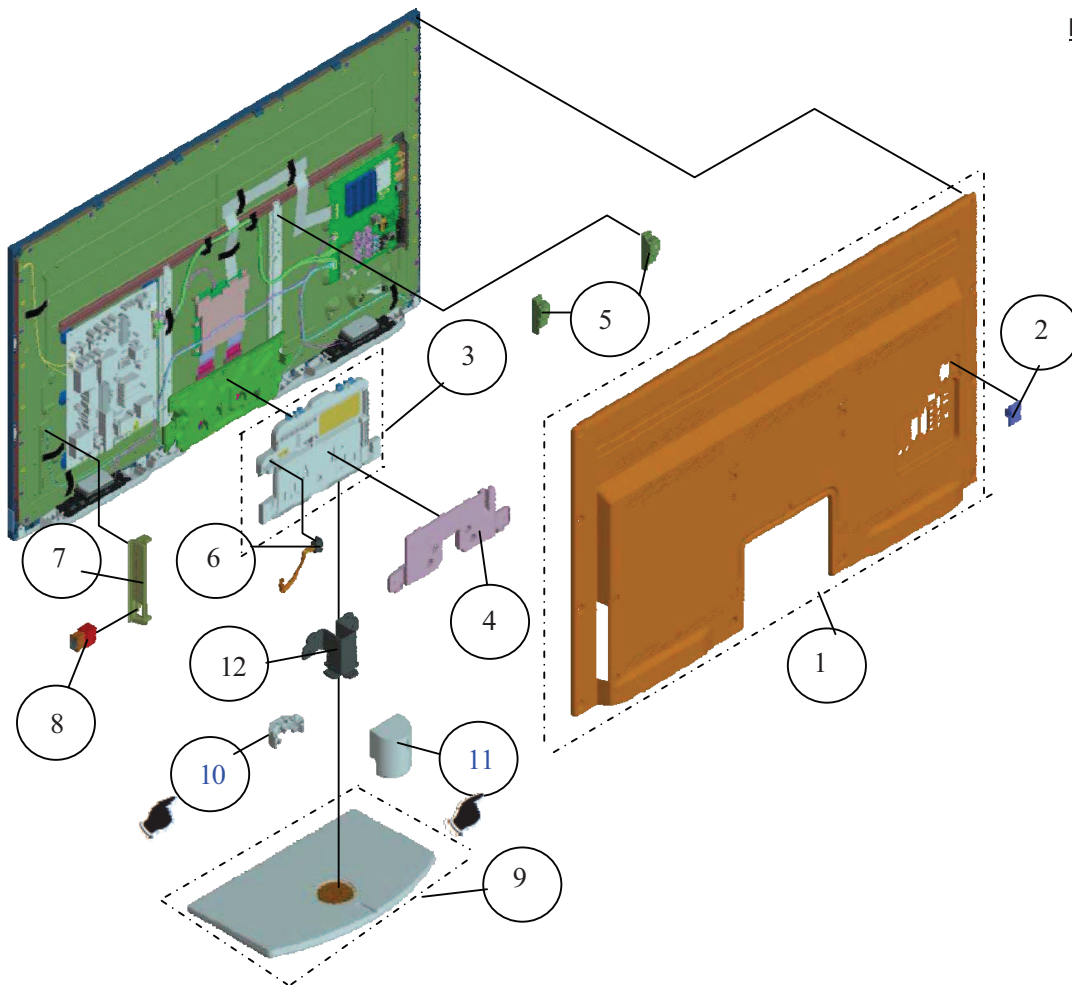

REF.NO.	PART NO.	DESCRIP
1	X-2541-873-1	REAR CO
2	* 4-115-101-02	COVER, (46EX700 SOUTH A
2	4-115-101-41	COVER,
3	X-2547-769-1	COVER,
4	4-169-438-01	COVER,
5	4-164-305-01	BRACKE
6	1-842-031-11	AC INLE
7	1-487-798-11	SWITCH
8	1-798-309-11	POWER
9	X-2546-097-1	BASE (M
10	4-170-477-01	COVER,
11	4-170-485-01	COVER,
12	4-170-450-01	NECK (M



## 5-3. KDL-46EX700

### 5-3-2. CHASSIS-2

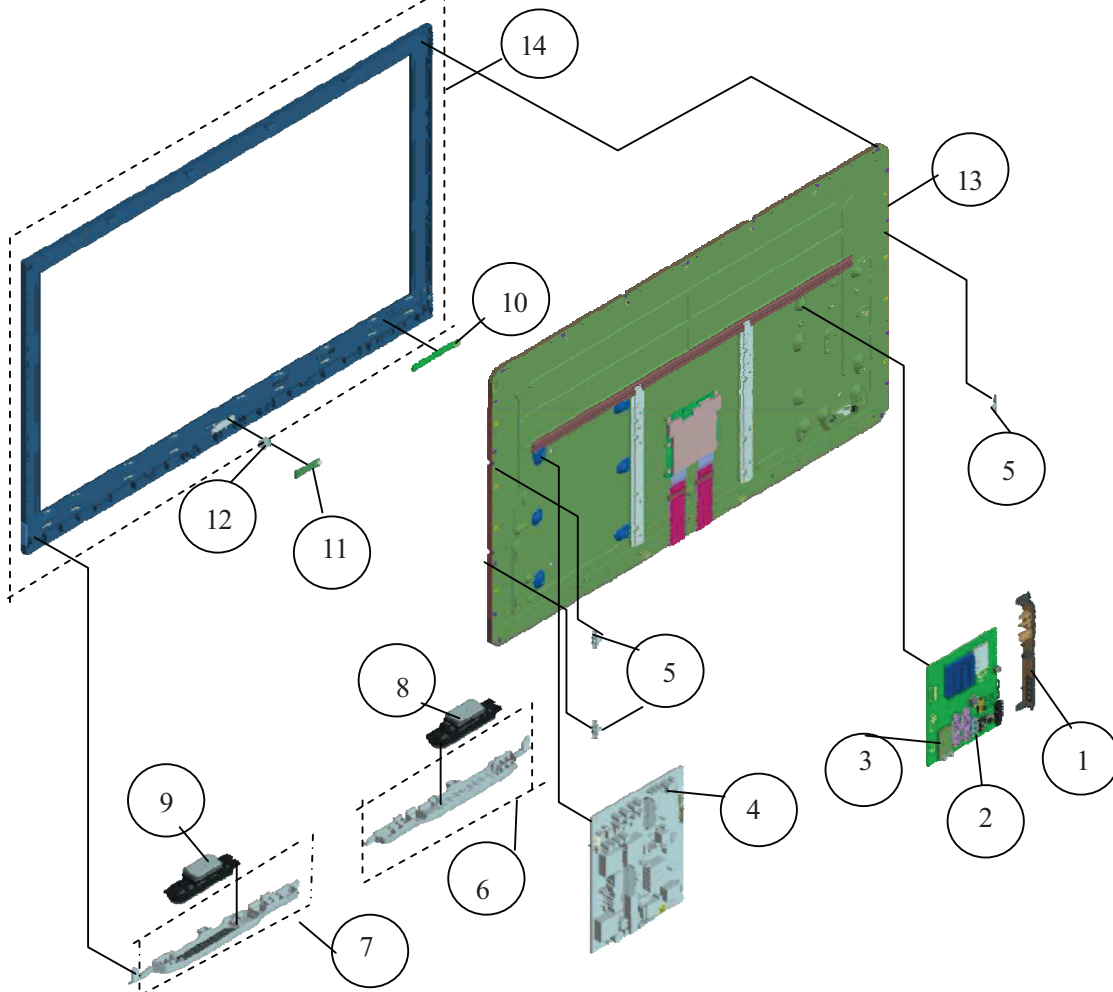

REF.NO.	PART NO.	D
1	4-166-898-01	BRA
2	A-1763-471-A	BAL (46E SINC 46EX
2	A-1763-470-A	BAL
3	4-182-211-01	GAS
4	A-1754-366-A	GE2
5	4-169-441-01	BRA
6	X-2547-783-1	BRA
7	X-2547-780-1	BRA
8,9	1-826-873-41	LOU
10	A-1744-405-A	HLR
11	A-1736-860-A	HMS
12	1-856-068-11	LEN
13	1-811-090-11	LCD
14	X-2547-264-1	BEZ

## 5-3. KDL-46EX700

### 5-3-3. SCREWS

	PART No.	DESCRIPTION
■	2-580-639-01	SCREW, +BVTP 4X12 TYPE2 IT-3
□	2-580-611-01	SCREW, +PSW M6X16
▲	2-580-603-01	SCREW, +PSW M4X16
▽	2-580-608-01	SCREW, +PSW M5X16
●	2-580-592-01	SCREW, +PSW M3X8
○	4-159-298-01	SCREW, +PSW M4X10
☆	2-580-591-01	SCREW, +PSW M3X5
★	7-685-646-79	SCREW, +BVTP 3X8 TYPE2 IT-3

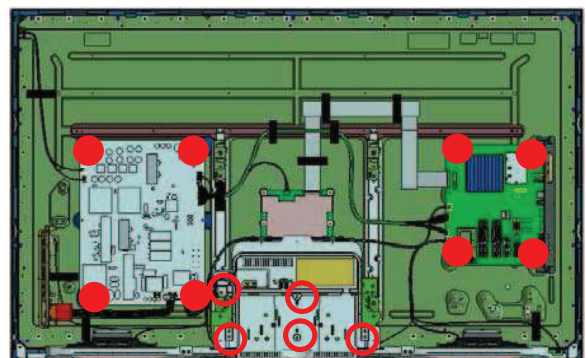
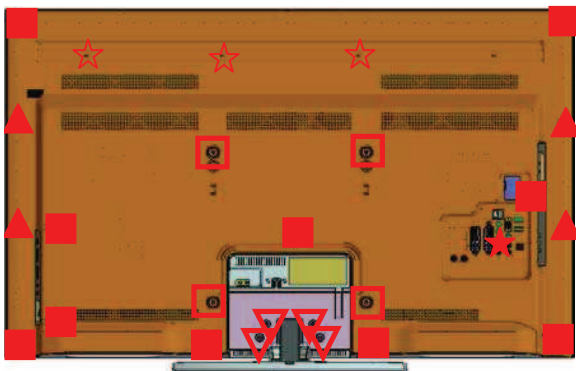

## 5-4. KDL-52EX700

### 5-4-1. CHASSIS-1

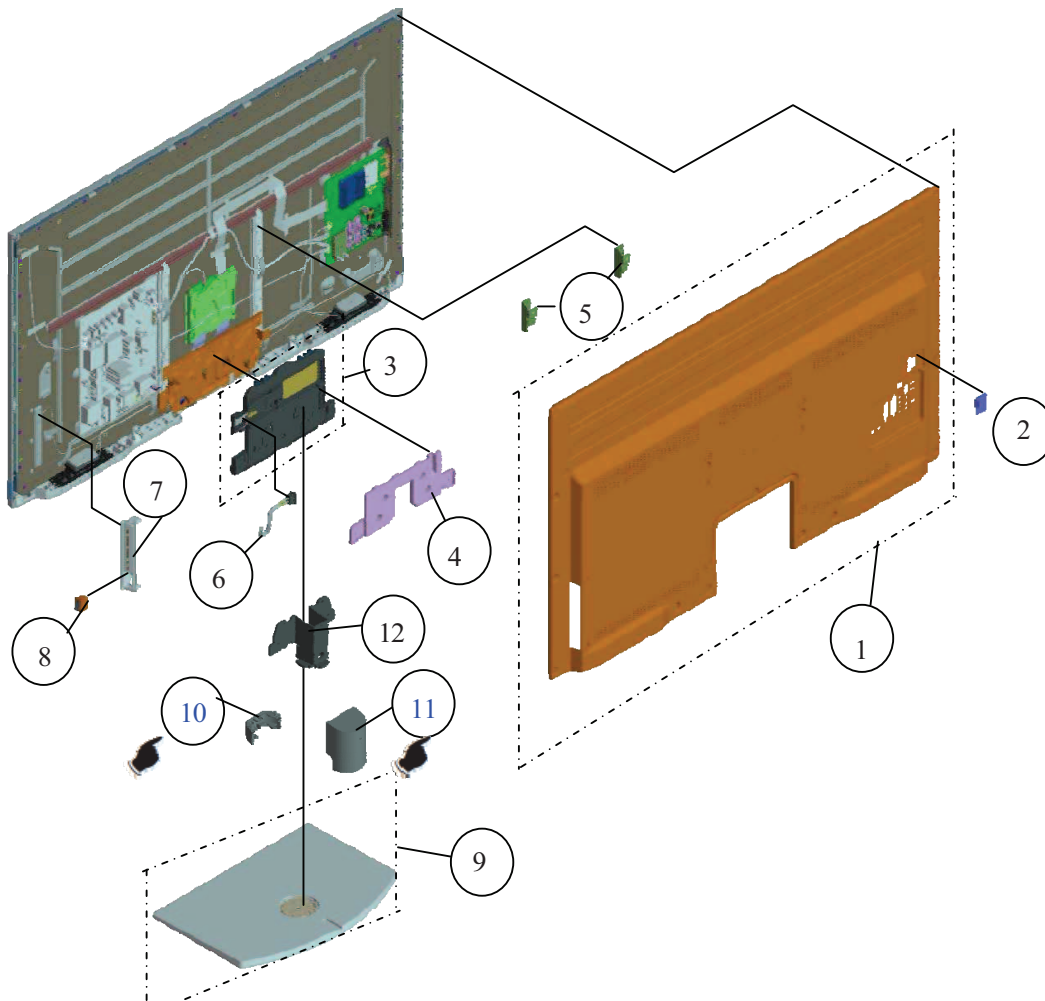

<u>REF.NO.</u>	<u>PART NO.</u>	
1	X-2541-874-1	
1	X-2547-252-1	
2	* 4-115-101-02	
3	X-2547-769-1	
4	4-169-439-01	
5	4-164-305-01	
6	1-842-031-11	
7	1-487-798-11	
8	1-798-309-11	
9	X-2546-098-1	
10	4-170-479-01	
11	4-170-487-01	
12	4-170-451-01	

## 5-4. KDL-52EX700

### 5-4-2. CHASSIS-2

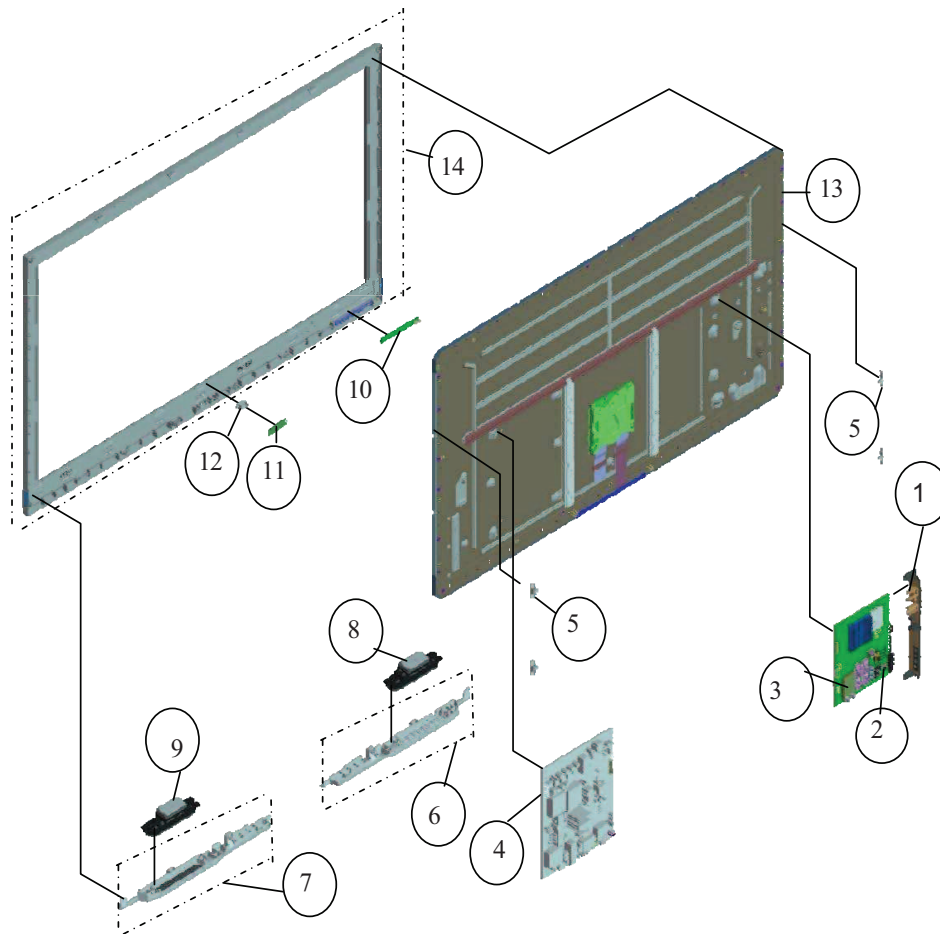

REF.NO.	PART NO.	DESCR
1	4-166-898-01	BRACKET
2	A-1763-471-A	BALANCE COIL (52EX700) SINGAPORE
2	A-1763-470-A	BALANCE COIL
3	4-182-211-01	GASKET
4	A-1754-366-A	GE2B UNIT
5	4-169-441-01	BRACKET
6	X-2547-786-1	BRACKET
7	X-2547-785-1	BRACKET
8,9	1-826-873-41	LOUDSPEAKER
10	A-1744-405-A	HLR MODULE
11	A-1736-860-A	HMS2 MODULE
12	1-856-068-11	LENS
13	A-1-811-091-11	LCD PANEL
14	X-2547-263-1	BEZEL (52EX700)

## 5-4. KDL-52EX700

### 5-4-3. SCREWS

	PART No.	DESCRIPTION
■	2-580-639-01	SCREW, +BVTP 4X12 TYPE2 IT-3
□	2-580-611-01	SCREW, +PSW M6X16
▲	2-580-603-01	SCREW, +PSW M4X16
▽	2-580-608-01	SCREW, +PSW M5X16
●	2-580-592-01	SCREW, +PSW M3X8
○	4-159-298-01	SCREW, +PSW M4X10
☆	2-580-591-01	SCREW, +PSW M3X5
★	4-685-646-79	SCREW, +BVTP 3X8 TYPE2 IT-3

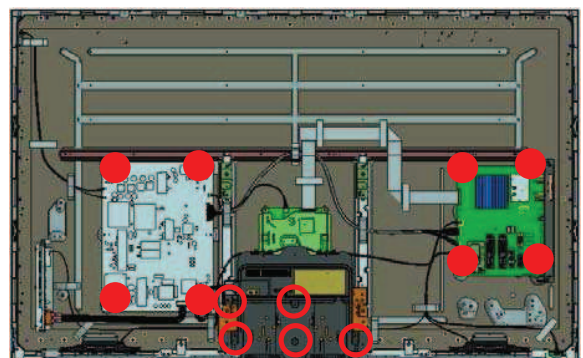
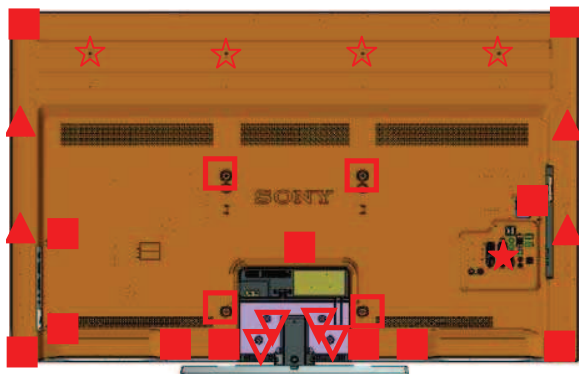

## 5-5. KDL-60EX700

### 5-5-1. CHASSIS-1

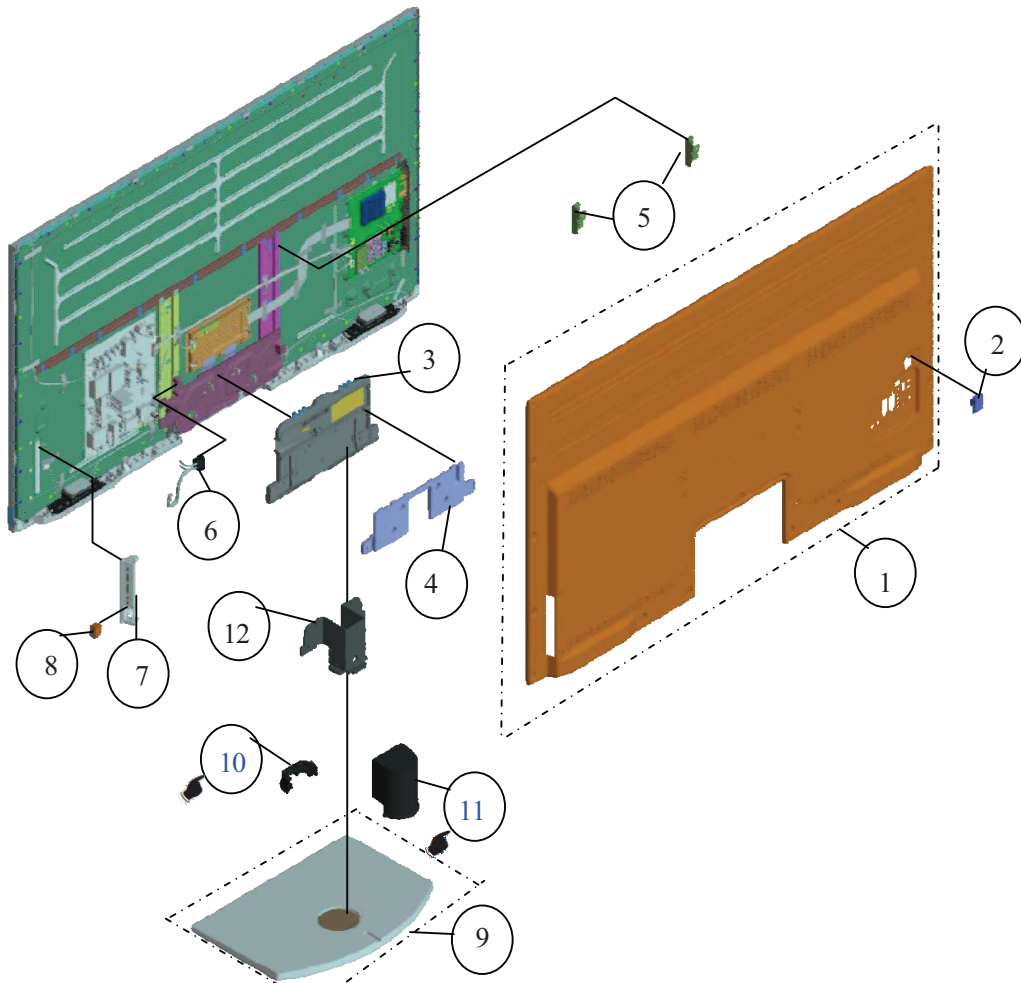

<u>REF.NO.</u>	<u>PART NO.</u>
1	X-2541-875-1
2	* 4-115-101-02
3	4-169-436-01
4	4-169-440-01
5	4-164-305-01
6	1-842-104-31
7	1-487-798-11
8	1-798-309-11
9	X-2546-099-1
10	4-170-476-01
11	4-170-488-01
12	4-170-452-01

## 5-5. KDL-60EX700

### 5-5-2. CHASSIS-2

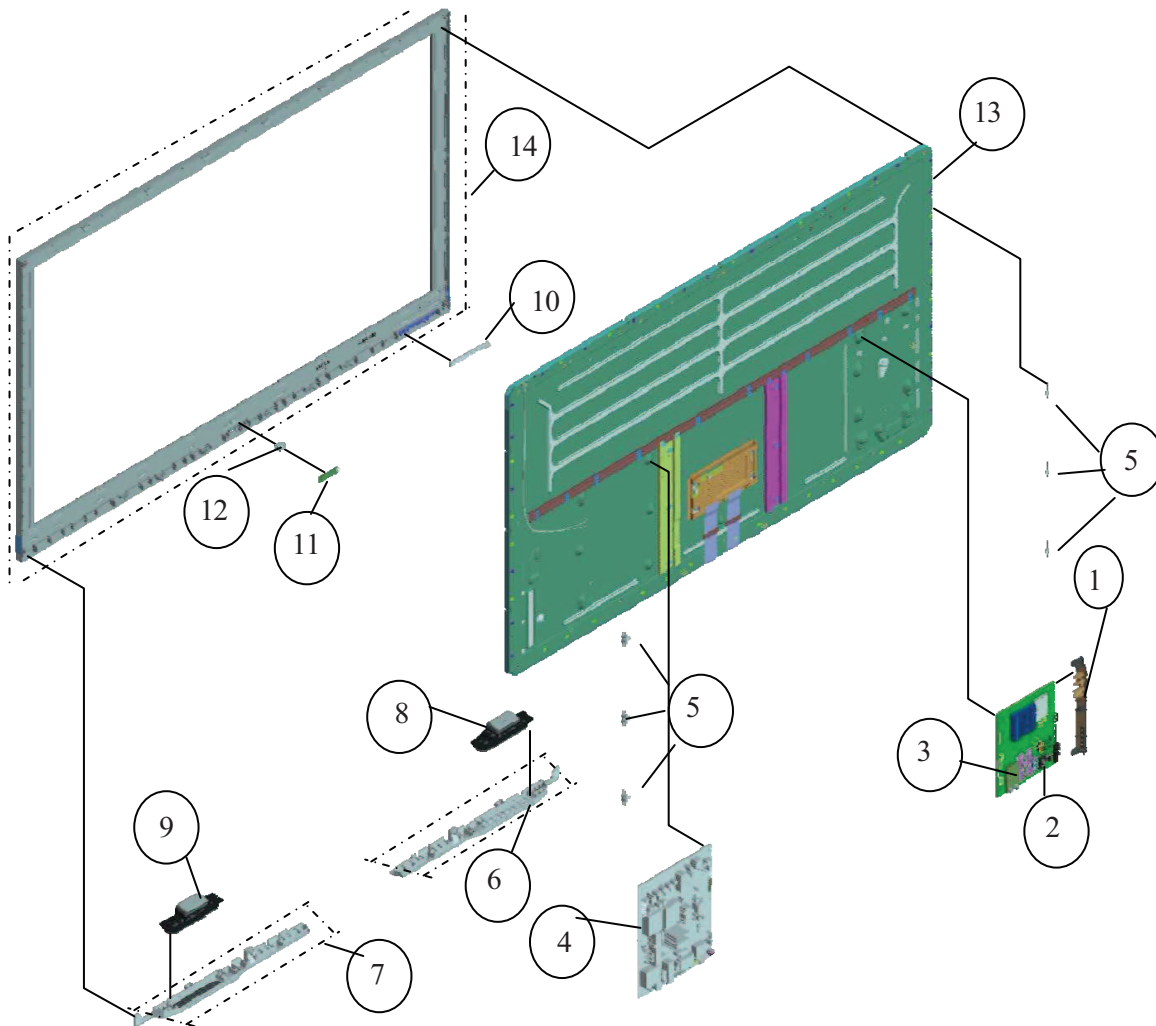

#### REF.NO PART NO. DE

1	4-166-898-01	BR
2	A-1763-471-A	BA NE GA
2	A-1763-470-A	BA
3	4-182-211-01	GA
4	1-474-211-11	ST
5	4-169-441-01	BR
6	X-2547-788-1	BR
7	X-2547-787-1	BR
8	1-826-873-41	LO
10	A-1744-405-A	HL
11	A-1736-860-A	HM
12	1-856-068-11	LE
13	1-811-092-11	LC
13	1-811-092-21	LC
14	X-2541-870-1	BE

## 5-5. KDL-60EX700

### 5-5-3. SCREWS

	PART No.	DESCRIPTION
■	2-580-639-01	SCREW, +BVTP 4X12 TYPE2 IT-3
□	2-580-611-01	SCREW, +PSW M6X16
▲	2-580-603-01	SCREW, +PSW M4X16
▽	2-580-608-01	SCREW, +PSW M5X16
●	2-580-592-01	SCREW, +PSW M3X8
○	4-159-298-01	SCREW, +PSW M4X10
☆	2-580-591-01	SCREW, +PSW M3X5
★	7-685-646-79	SCREW, +BVTP 3X8 TYPE2 IT-3

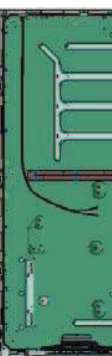
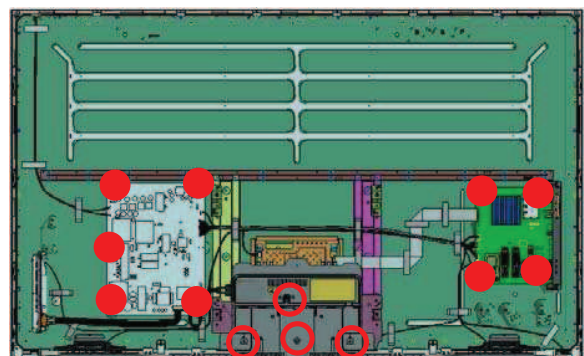
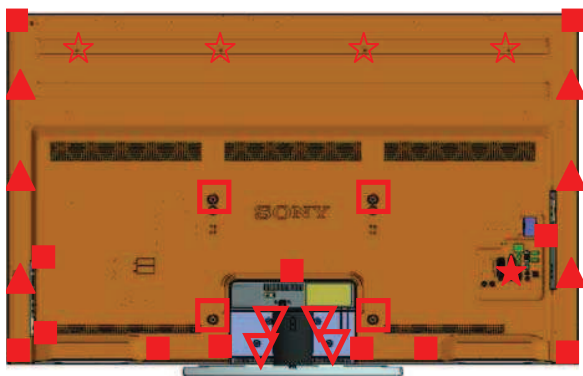



## 5-6. OTHER PART (KDL-32EX700)

### 5-6-1. MISCELLANEOUS

<u>PART NO.</u>	<u>DESCRIPTION (CONNECTORS)</u>	<u>REMARK</u>
1-837-790-11	LEAD WIRE WITH CONNECTOR(LVDS) (CN2600-TCON(1))	
1-837-663-12	CONNECTOR ASSY (CN6003-ACSW(1))	
1-910-100-16	HARNESS ASSY (1) (CN2602, CN4300-CN002, SW, HMS2,SP(1) )	
1-910-100-17	HARNESS ASSY (2) (CN6151-CN3800, CN2561,TCON(1))	

#### (OTHERS)

A-1565-554-C	R2 MOUNT	
2-580-626-01	SCREW, SP 4-40 UNC (R2 PWB)	
* 4-164-923-01	LABEL, REAR TERMINAL (32EX700(AUSTRALIA, NEW ZEALAND, SOUTH AFRICA, IRAN(SHAHAB)), GA-ANALOG))	
4-164-924-01	LABEL, REAR TERMINAL(32EX700(Hong Kong))	

### 5-6-2. PACKING

<u>PART NO.</u>	<u>DESCRIPTION</u>	<u>REMARK</u>
*4-182-605-01	CARTON,INDIVIDUAL(32OCA)	
*4-176-721-01	CUSHION, UPPER (OCA32)	
*4-176-722-01	CUSHION, LOWER (OCA32)	
* 4-188-559-01	SHEET, SLIP	
1-821-926-11	PLUG CONVERSION ADAPTOR (32EX700(AUSTRALIA, NEW ZEALAND, SOUTH AFRICA), GA-ANALOG))	
* 1-837-463-11	▲ POWER-SUPPLY CORD (32EX700(SOUTH AFRICA), GA-ANALOG))	
1-837-646-11	▲ POWER-SUPPLY CORD (32EX700(SOUTH AFRICA), GA-ANALOG))(HONG KONG)	
1-837-651-11	▲ POWER-SUPPLY CORD (32EX700(SOUTH AFRICA), GA-ANALOG))	

### 5-6-2. PACKING (continue)

<u>PART NO.</u>	<u>DESCRIPTION</u>
1-837-650-11	▲ POWER-SUPPLY CORD SE (32EX700(AUSTRALIA, NEW ZEALAND, SOUTH AFRICA), GA-ANALOG))
1-837-642-11	▲ POWER-SUPPLY CORD SE (32EX700( SOUTH AFRICA), IRAN(SHAHAB))

### 5-6-3. ACCESSORIES

<u>PART NO.</u>	<u>DESCRIPTION</u>
4-182-864-11	MANUAL, INSTRUCTION (32EX700(AUSTRALIA, NEW ZEALAND, SOUTH AFRICA), GA-ANALOG))
4-181-157-31	MANUAL, INSTRUCTION (32EX700(AUSTRALIA, NEW ZEALAND, SOUTH AFRICA), GA-ANALOG))
4-181-157-11	MANUAL, INSTRUCTION (32EX700(AUSTRALIA, NEW ZEALAND, SOUTH AFRICA), GA-ANALOG))
4-181-157-21	MANUAL, INSTRUCTION (32EX700(AUSTRALIA, NEW ZEALAND, SOUTH AFRICA), GA-ANALOG))
4-182-055-11	MANUAL, INSTRUCTION (32EX700(AUSTRALIA, NEW ZEALAND, SOUTH AFRICA), GA-ANALOG))
4-182-055-21	MANUAL, INSTRUCTION (32EX700(AUSTRALIA, NEW ZEALAND, SOUTH AFRICA), GA-ANALOG))

### 5-6-4. REMOTE COMMANDER

1-487-764-11	REMOTE COMMANDER (R)
--------------	----------------------

## 5-6. OTHER PART (KDL-40EX700)

### 5-6-5. MISCELLANEOUS

<u>PART NO.</u>	<u>DESCRIPTION</u> <u>(CONNECTORS)</u>	<u>REMARK</u>
1-837-665-12	CONNECTOR ASSY (CN6003-ACSW(1) )	
1-837-704-11	FLEXIBLE FLAT CABLE 51P (CN2600-TCON(1) )	
1-910-100-18	HARNESS ASSY (1)( CN2602,CN4300-CN002,SW,HMS2,SP(1	
1-910-100-19	HARNESS ASSY (2) (CN6151-CN3800, CN2561,TCON(1) )	
<u>(OTHERS)</u>		
A-1565-554-C	R2 MOUNT	
2-580-626-01	SCREW, SP 4-40 UNC (R2 PWB)	
* 4-164-923-01	LABEL, REAR TERMINAL (40EX700(AUSTRALIA,NEW ZEALAND, SINGAPORE, SOUTH AFRICA, IRAN(SHAHAB),GA-ANALOG))	
4-164-924-01	LABEL, REAR TERMINAL (40EX700(Hong Kong))	
4-182-212-01	SPACER	

### 5-6-6. PACKING

<u>PART NO.</u>	<u>DESCRIPTION</u>	<u>REMARK</u>
* 4-182-604-01	CARTON,INDIVIDUAL(40OCA)	
* 4-176-746-01	CUSHION, LOWER (OCA40)	
* 4-176-745-01	CUSHION, UPPER (OCA40)	
* 4-182-692-01	CUSHION,SIDE CENTER(OCA40)	
1-821-926-11	PLUG CONVERSION ADAPTOR (40EX700(AUSTRALIA,NEW ZEALAND, SINGAPORE, SOUTH AFRICA, GA-ANALOG))	
1-822-631-11	PLUG CONVERSION ADAPTOR (40EX700(AUSTRALIA,NEW ZEALAND, SINGAPORE, SOUTH AFRICA, GA-ANALOG))	
* 1-837-463-11	POWER-SUPPLY CORD (40EX700(SINGAPORE, SOUTH AFRICA, GA-ANALOG))	

### 5-6-6. PACKING (continue)

<u>PART NO.</u>	<u>DESCRIPTION</u>
1-837-646-11	POWER-SUPPLY SOUTH AFRICA,
1-837-650-11	POWER-SUPPLY (40EX700(AUSTR
1-837-642-12	POWER-SUPPLY (40EX700(SINGAP
	IRAN (SHAHAB), C
1-837-651-11	POWER-SUPPLY (40EX700(SINGAP

### 5-6-7. ACCESSORIES

<u>PART NO.</u>	<u>DESCRIPTION</u>
4-182-864-11	MANUAL, INSTRU
4-181-157-11	MANUAL, INSTRU (40EX700(AUSTR SOUTH AFRICA, C
4-181-157-21	MANUAL, INSTRU (40EX700(AUSTR SOUTH AFRICA, C
4-181-157-31	MANUAL, INSTRU (40EX700(AUSTR SOUTH AFRICA, C
4-182-055-11	MANUAL, INSTRU
4-182-055-21	MANUAL, INSTRU

### 5-6-8. REMOTE COMMAND

<u>PART NO.</u>	<u>DESCRIPTION</u>
1-487-764-11	REMOTE COMM

## 5-6. OTHER PART (KDL-46EX700)

### 5-6-9. MISCELLANEOUS

<u>PART NO.</u>	<u>DESCRIPTION (CONNECTORS)</u>	<u>REMARK</u>
1-837-666-12	CONNECTOR ASSY(CN6003-ACSW(1))	
1-837-705-11	FLEXIBLE FLAT CABLE 51P(CN2600-TCON(1))	
1-910-100-20	HARNESS ASSY (1)(CN2602,CN4300-CN002,SW,HMS2,SP(1))	
1-910-100-21	HARNESS ASSY (2)(CN6151-CN3800,CN2561,TCON(1))	

#### (OTHERS)

4-182-212-01	SPACER	
4-100-136-01	SHEET(CORE), C(46EX700(IRAN(SHAHAB)))	
A-1565-554-C	R2 MOUNT (46EX700(AUSTRALIA,NEW ZEALAND,SINGAPORE, SOUTH AFRICA,GAANALOG),46EX700(HONG KONG))	
* 4-164-923-01	LABEL, REAR TERMINAL (46EX700(AUSTRALIA,NEW ZEALAND,SINGAPORE, SOUTH AFRICA,GA-ANALOG),46EX700(IRAN(SHAHAB)))	
4-164-924-01	LABEL, REAR TERMINAL(46EX700(HONG KONG))	
2-580-626-01	SCREW, SP 4-4O UNC (R2 PWB)	

### 5-6-10. PACKING

<u>PART NO.</u>	<u>DESCRIPTION</u>	<u>REMARK</u>
* 3-209-296-31	BAG, PROTECTION	
* 4-182-603-01	CARTON,INDIVIDUAL(46OCA)	
* 4-176-794-01	CUSHION, LOWER (OCA46)	
* 4-176-793-01	CUSHION, UPPER (OCA46)	
4-188-559-21	SHEET, SLIP (46EX700(AUSTRALIA,NEW ZEALAND,SINGAPORE, SOUTH AFRICA,GA-ANALOG),46EX700(HONG KONG))	
* 4-176-796-01	TRAY (OCA46)	
1-821-926-11	PLUG CONVERSION ADAPTOR (46EX700(AUSTRALIA,NEW ZEALAND, SINGAPORE,SOUTH AFRICA,GA-ANALOG))	

### 5-6-10. PACKING (continue)

<u>PART NO.</u>	<u>DESCRIPTION</u>
1-822-631-11	PLUG CONVERSION ADAPTOR (46EX700(AUSTRALIA,NEW ZEALAND, SINGAPORE,SOUTH AFRICA,GA-ANALOG))
* 1-837-463-11	▲ POWER-SUPPLY CORD 46EX700(SINGAPORE,SOUTH AFRICA,GA-ANALOG)
1-837-651-11	▲ POWER-SUPPLY CORD 46EX700(SINGAPORE,SOUTH AFRICA,GA-ANALOG)
1-837-646-11	▲ POWER-SUPPLY CORD 46EX700(SINGAPORE,SOUTH AFRICA,GA-ANALOG) 46EX700(HONG KONG))
1-837-650-11	▲ POWER-SUPPLY CORD (46EX700)
1-837-642-12	▲ POWER-SUPPLY CORD SET (46EX700(SINGAPORE,SOUTH AFRICA,GA-ANALOG), 46EX700(IRAN(SHAHAB)))

### 5-6-11. ACCESSORIES

<u>PART NO.</u>	<u>DESCRIPTION</u>
4-181-157-31	MANUAL, INSTRUCTION (46EX700(AUSTRALIA,NEW ZEALAND, SINGAPORE,SOUTH AFRICA,GA-ANALOG))
4-181-157-11	MANUAL, INSTRUCTION ((46EX700(AUSTRALIA,NEW ZEALAND, SINGAPORE,SOUTH AFRICA,GA-ANALOG))
4-182-055-11	MANUAL, INSTRUCTION(/AC/G)
4-182-864-11	MANUAL, INSTRUCTION (46EX700)

### 5-6-12. REMOTE COMMANDER

<u>PART NO.</u>	<u>DESCRIPTION</u>
1-487-764-11	REMOTE COMMANDER (RM-G)

## 5-6. OTHER PART (KDL-52EX700)

### 5-6-13. MISCELLANEOUS

<u>PART NO.</u>	<u>DESCRIPTION</u>	<u>REMARK</u>
	<b>(CONNECTORS)</b>	
1-837-667-12	CONNECTOR ASSY (CN6102-ACSW(1) )	
1-837-706-11	FLEXIBLE FLAT CABLE 51P(CN2600-TCON(1))	
1-910-100-22	HARNESS ASSY (1)(CN2602,CN4300-CN002, SW,HMS2,SP(1))	
1-910-100-23	HARNESS ASSY (2)CN6151-CN3800,CN2561, TCON(1)	
	<b>(OTHERS)</b>	
* 4-164-923-01	LABEL, REAR TERMINAL(/LB/RC(1)) (52EX700(AUSTRALIA,NEW ZEALAND,SINGAPORE, SOUTH AFRICA,GA-ANALOG))	
4-164-924-01	LABEL, REAR TERMINAL(/LB/RC(1)) (52EX700(HONG KONG))	
4-182-212-01	SPACER	
A-1777-460-A	STAND (LL3A) ASSY	
A-1565-554-C	R2 MOUNT	
2-580-626-01	SCREW, SP 4-40 UNC(R2-PWB)	

### 5-6-14. PACKING

<u>PART NO.</u>	<u>DESCRIPTION</u>	<u>REMARK</u>
* 4-176-843-01	TRAY (OCA52)	
* 4-182-602-01	CARTON,INDIVIDUAL(52OCA)	
* 4-176-841-01	CUSHION, LOWER (OCA52)	
* 4-176-840-01	CUSHION, UPPER (OCA52)	
1-821-926-11	PLUG CONVERSION ADAPTOR (52EX700(AUSTRALIA, NEW ZEALAND,SINGAPORE, SOUTH AFRICA,GA-ANALOG))	

### 5-6-14. PACKING (continue)

<u>PART NO.</u>	<u>DESCRIPTION</u>
1-822-631-11	PLUG CONVERSION ADAP (52EX700(AUSTRALIA,NEW SOUTH AFRICA,GA-ANALOG))
* 1-837-463-11	▲ POWER-SUPPLY CORD(52EX700(AUSTRALIA,NEW ZEALAND,SINGAPORE,SOUTH AFRICA,GA-ANALOG))
1-837-651-11	▲ POWER-SUPPLY CORD(52EX700(AUSTRALIA,NEW ZEALAND,SINGAPORE,SOUTH AFRICA,GA-ANALOG))
1-837-646-11	▲ POWER-SUPPLY CORD(52EX700(AUSTRALIA,NEW ZEALAND,SINGAPORE,SOUTH AFRICA,GA-ANALOG),52EX700(HONG KONG))
1-837-650-11	▲ POWER-SUPPLY CORD SE (52EX700(AUSTRALIA,NEW ZEALAND,SINGAPORE,SOUTH AFRICA,GA-ANALOG))
1-837-642-12	▲ POWER-SUPPLY CORD SE (52EX700(SINGAPORE, SOUTH AFRICA,GA-ANALOG))

### 5-6-15. ACCESSORIES

<u>PART NO.</u>	<u>DESCRIPTION</u>
4-181-157-31	MANUAL, INSTRUCTION(52EX700(AUSTRALIA,NEW ZEALAND,SINGAPORE, SOUTH AFRICA,GA-ANALOG))
4-181-157-21	MANUAL, INSTRUCTION(52EX700(AUSTRALIA,NEW ZEALAND,SINGAPORE, SOUTH AFRICA,GA-ANALOG))
4-181-157-11	MANUAL, INSTRUCTION(52EX700(AUSTRALIA,NEW ZEALAND,SINGAPORE, SOUTH AFRICA,GA-ANALOG))
4-182-864-11	MANUAL, INSTRUCTION(52EX700(AUSTRALIA,NEW ZEALAND,SINGAPORE,SOUTH AFRICA,GA-ANALOG))

### 5-6-16. REMOTE COMMANDER

<u>PART NO.</u>	<u>DESCRIPTION</u>
1-487-764-11	REMOTE COMMANDER (R)

## 5-4. OTHER PART (KDL-60EX700)

### 5-4-17. MISCELLANEOUS

<u>PART NO.</u>	<u>DESCRIPTION</u> <b>(CONNECTORS)</b>	<u>REMARK</u>
* 1-837-532-12	CONNECTOR ASSY CN6003-ACSW(1)	
* 1-837-710-11	FLEXIBLE FLAT CABLE 51P CN2600-TCON(1)	
* 1-910-100-24	HARNESS ASSY (1) CN2602,CN4300-CN002,SW,HMS2,SP(1)	
* 1-910-100-25	HARNESS ASSY (2) CN6151-CN3800,CN2561,TCON(1)	
	<b>(OTHERS)</b>	
4-182-212-01	SPACER	
* 4-164-923-01	LABEL, REAR TERMINAL (60EX700(AUSTRALIA,NEW ZEALAND, SINGAPORE, SOUTH AFRICA, GA-ANALOG))	
4-164-924-01	LABEL, REAR TERMINAL(60EX700(HONG KONG)	
A-1565-554-C	R2 MOUNT	
2-580-626-01	SCREW, SP 4-40 UNC (R2-PWB)	
* 4-184-461-31	SHEET, PROTECTION	

### 5-4-18. PACKING

<u>PART NO.</u>	<u>DESCRIPTION</u>	<u>REMARK</u>
* 4-182-601-01	CARTON,INDIVIDUAL(60OCA)	
* 4-176-908-01	CUSHION, LOWER (OCA60)	
* 4-176-911-01	CUSHION, LOWER TOP-FRONT (OCA60)	
* 4-176-910-01	CUSHION, MIDDLE LEFT (OCA60)	
* 4-176-909-01	CUSHION, MIDDLE RIGHT (OCA60)	
* 4-176-907-01	CUSHION, UPPER (OCA60)	

### 5-4-18. PACKING (continue)

<u>PART NO.</u>	<u>DESCRIPTION</u>	<u>REMARK</u>
* 2-639-807-01	JOINT	
*4-176-913-01	TRAY (OCA60)	
1-837-654-11	▲ POWER-SUPPLY COF	
1-837-639-11	▲ POWER-SUPPLY COF GA-ANALOG))	
1-837-640-11	▲ POWER-SUPPLY COF GA-ANALOG)), 600EX	
1-837-634-11	▲ POWER-SUPPLY COF ((60EX700(SINGAPOR	
1-835-166-12	▲ POWER-SUPPLY COF ((60EX700(SINGAPOR	
* 1-837-657-11	▲ POWER-SUPPLY COF ((60EX700(SINGAPOR	
* 1-837-655-11	▲ POWER-SUPPLY COF ((60EX700(SINGAPOR	

---

5-4. OTHER PART  
(KDL-60EX700)

**5-4-19. ACCESSORIES**

<u>PART NO.</u>	<u>DESCRIPTION</u>	<u>REMARK</u>
4-181-157-31	MANUAL, INSTRUCTION(60EX700(AUSTRALIA,NEW ZEALAND, SINGAPORE, SOUTH AFRICA, GA-ANALOG))	
4-181-157-11	MANUAL, INSTRUCTION□(60EX700(AUSTRALIA,NEW ZEALAND, SINGAPORE, SOUTH AFRICA, GA-ANALOG))	
4-181-157-21	MANUAL, INSTRUCTION□(60EX700(AUSTRALIA,NEW ZEALAND, SINGAPORE, SOUTH AFRICA, GA-ANALOG))	
4-182-864-11	MANUAL, INSTRUCTION□(60EX700(HONG KONG))	

**5-4-20. REMOTE COM**

<u>PART NO.</u>	<u>DESCRIPTION</u>
1-487-764-11	REMOTE COMM

# END

---

**9-888-282-02**

KDL-32/40/46/52/60EX700(HONG KONG,AUSTRALIA,NEW  
ZEALAND,SINGAPORE,SOUTH AFRICA,IRAN,GA-ANALOG AREA)

**Sony Corporation**  
**Sony EMCS (Malaysia) Sdn. Bhd.**  
**TVEG**

# APPENDIX

CAUTION TO SHARP EDGE OF REAR COVER(40)

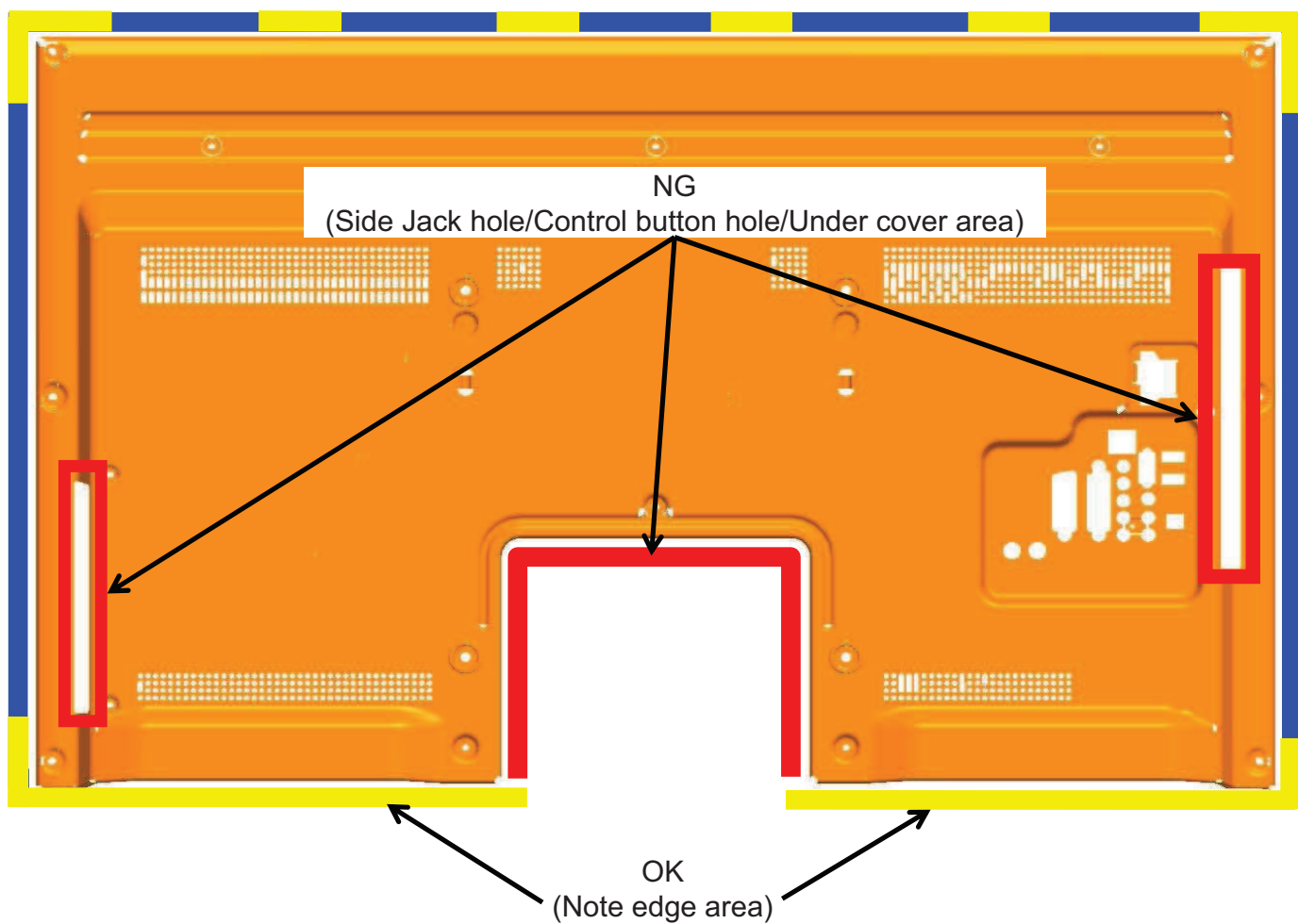



---

CAUTION TO SHARP EDGE OF REAR COVER(46)

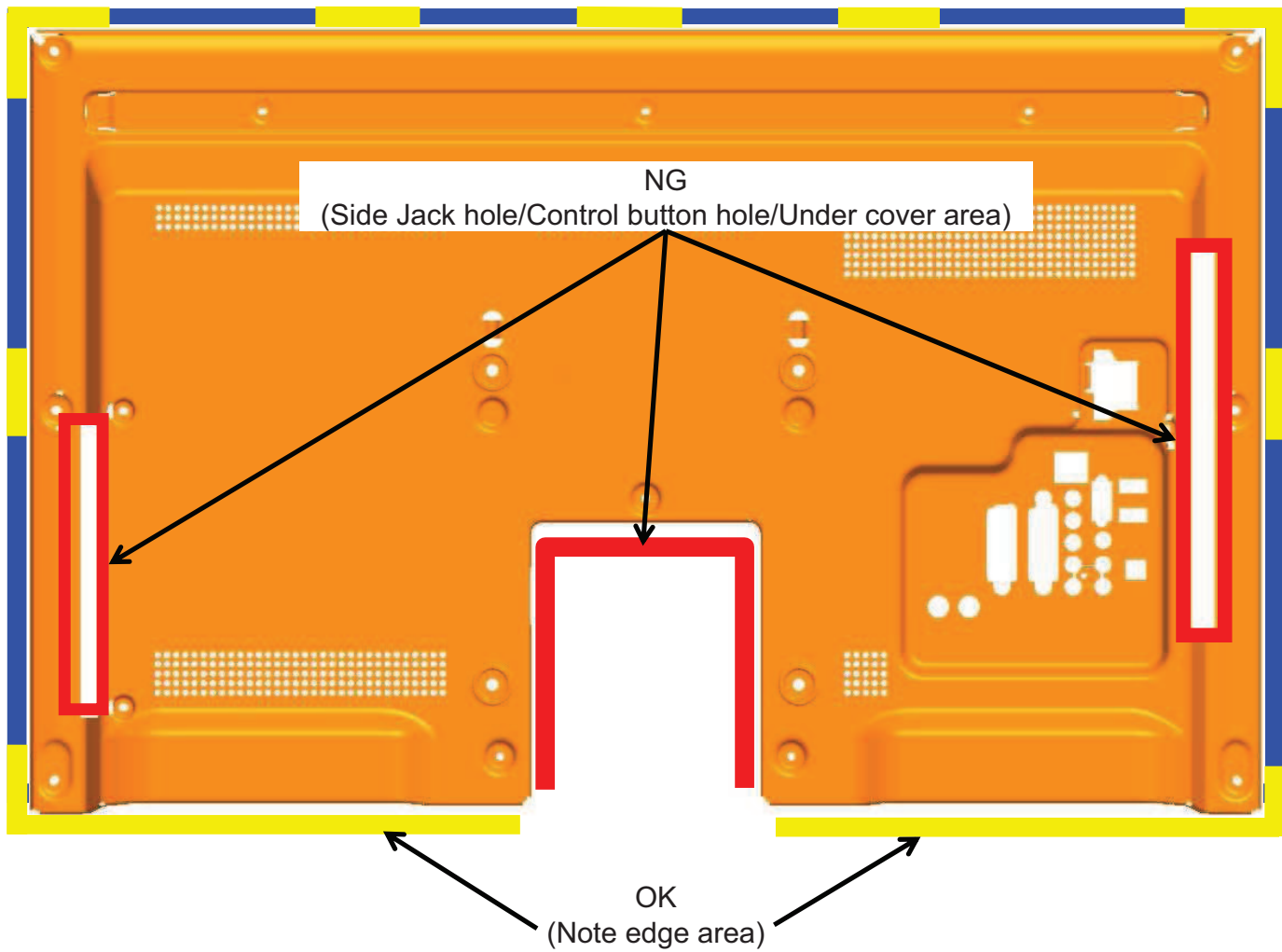

---

CAUTION TO SHARP EDGE OF REAR COVER(52)

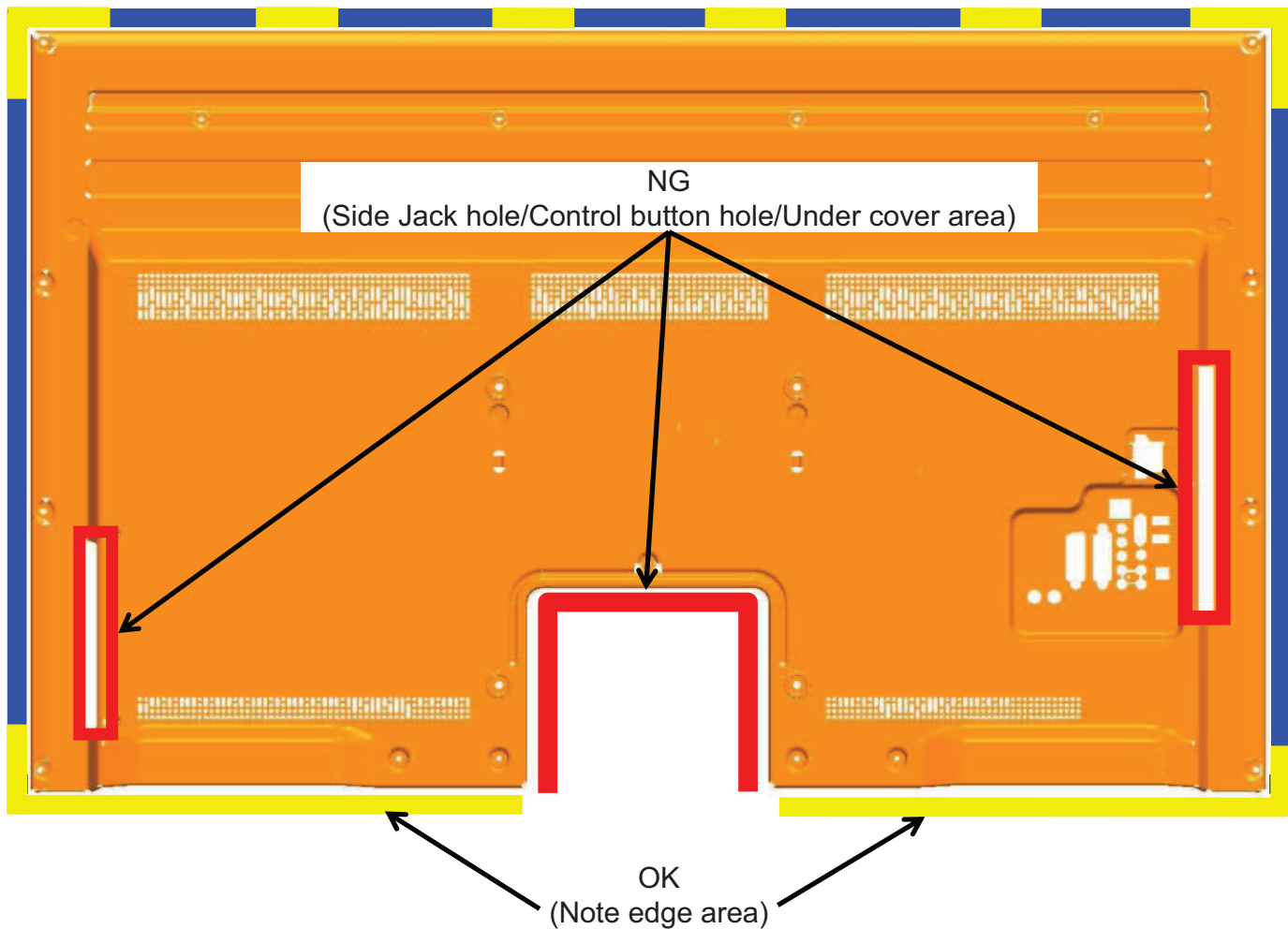

---

CAUTION TO SHARP EDGE OF REAR COVER(60)

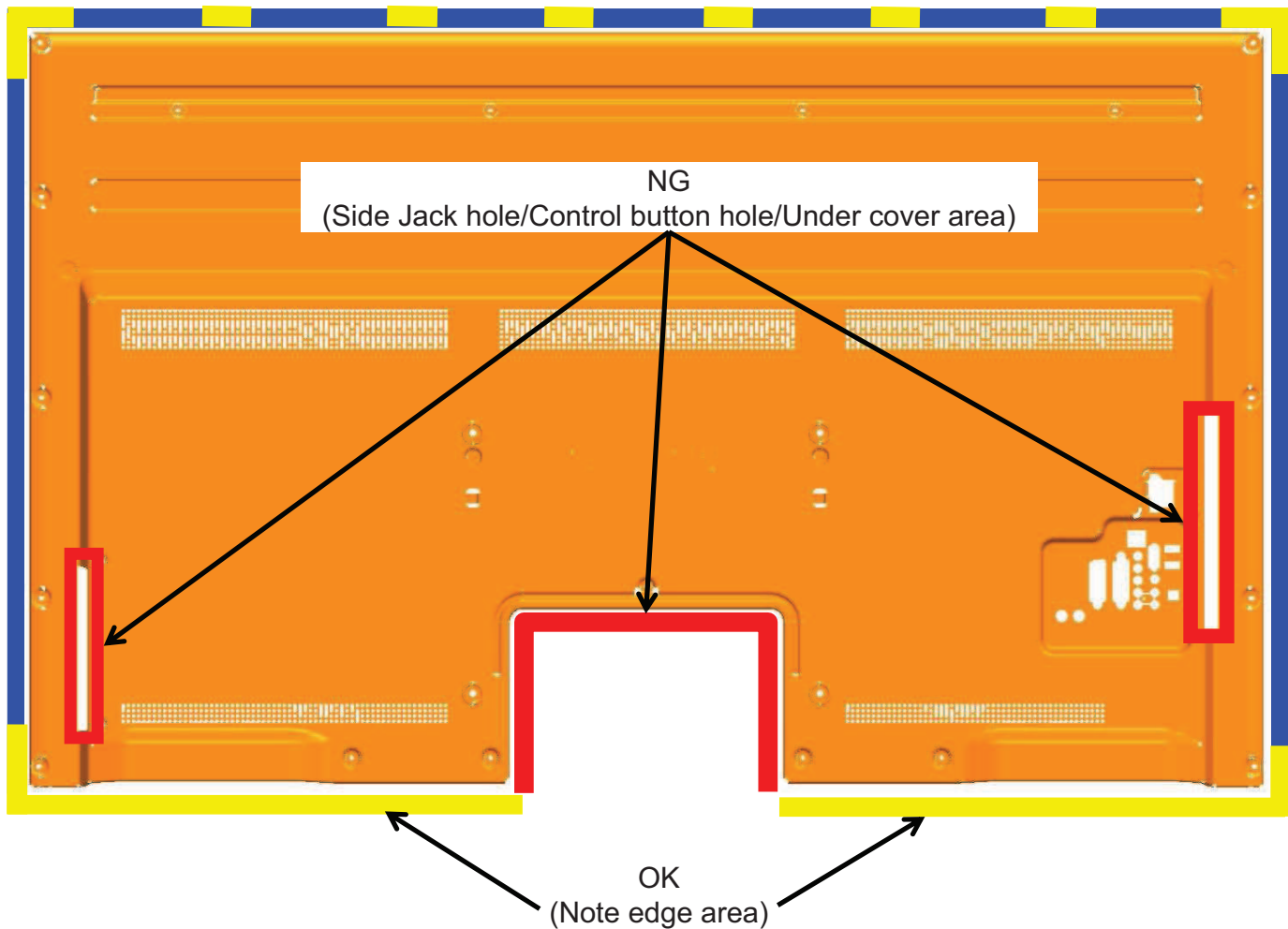

---

Method of RC handling to open.

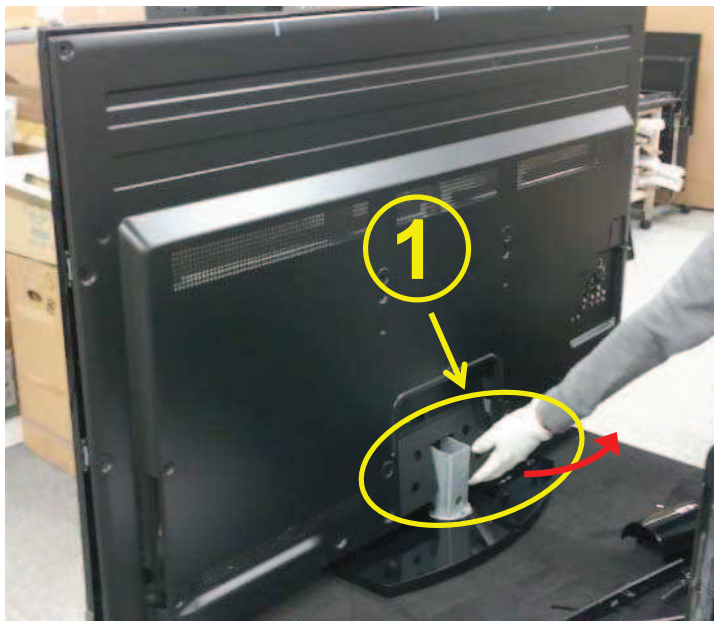

1. Lift up HOOK COVER a little to move REAR COVER and SP-BRACKET.
2. Grab REAR COVER at the bottom



Method of RC handling to open.



- 3. Hold REAR COVER
- 4. Lift up REAR COVER by both hands 20 degrees.
- 5. Pull REAR COVER downward to the bottom edge of BEZEL.

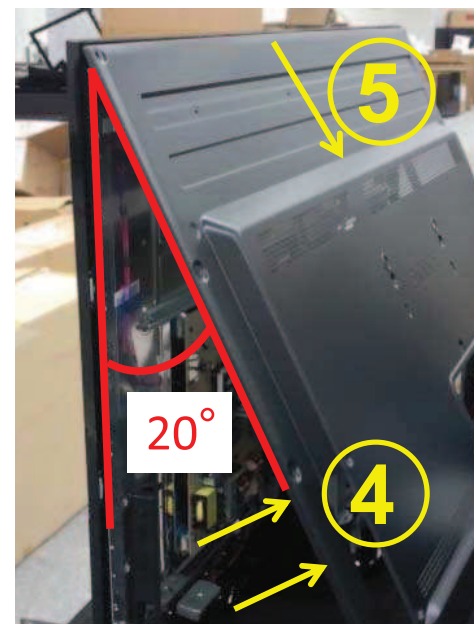

Method of RC handling to close.

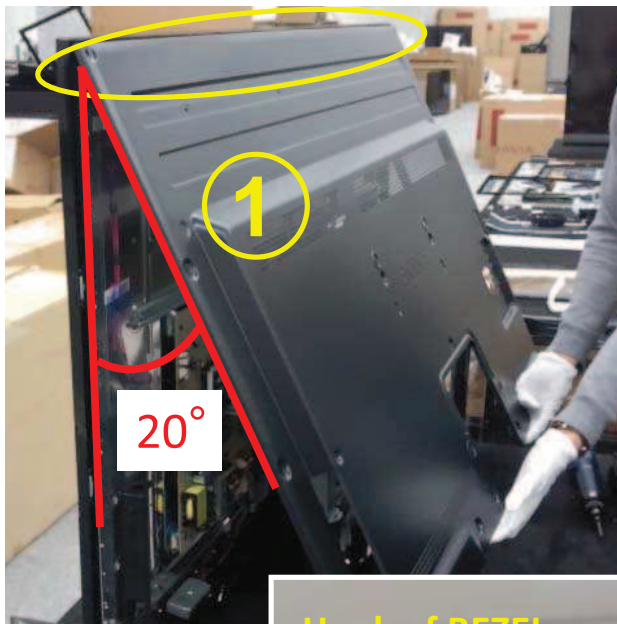

1. Align the holes of REAR COVER to BEZEL at top edge, and insert.
2. Pushing RC at the middle of top edge (portion) can help insertion complete.



---

Method of RC handling to close.



- 3. Align Close while pushing RC on t
- 4. Pushing Confirm screw holes ind
- aligned, and screw these holes at
- (Need to hold RC while screwing,
- moves downward due to the gra

