

matr.31210.0001

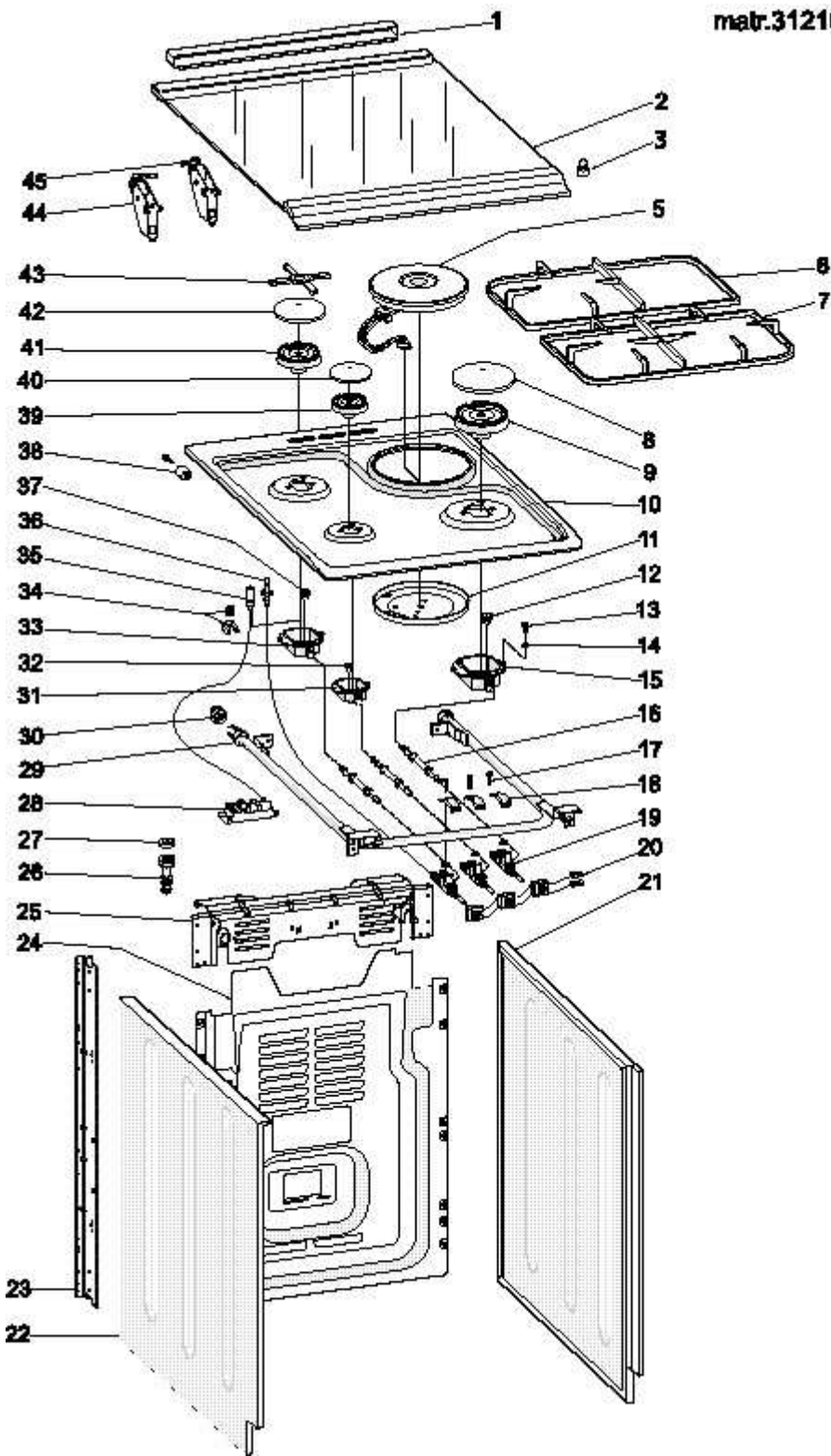

4280110a