

DAEWOO

Refrigerator Service Manual

**MODEL : FR - 530NT
FR - 590NT
FR - 590NW**

✓ Caution

: In this Manual, some parts can be changed for improving, their performance without notice in the parts list. So, if you need the latest parts information, please refer to PPL(Parts Price List) in Service Information Center(<http://svc.dwe.co.kr>).

DAEWOO ELECTRONICS CO., LTD.

SAFETY AND PRECAUTIONS

- 1) For starters, be sure to check any chances of the leakage of electricity
- 2) You could handle a part in the vicinity of electricity after unplugging
- 3) You should put on rubber glovers to prevent an electric shock on operation test
- 4) Make sure the rated current, voltage, capacity before using an instrument
- 5) Keep your wet hands away from the metal goods in the freezer compartment not to be frostbitten
- 6) Be careful not to let water to permeate the electric part in the machine room
- 7) with the door open during your working, you might be damaged by that door
- 8) You should give a tilt to the refrigerator for your safe after removing the breakable goods inside the refrigerator
- 9) You'd better use cotton gloves if you fix it up around the evaporator

TABLE OF CONTENTS

1. EXTERNAL VIEWS	2
1-1. EXTERNAL SIZE	2
1-2. NAME OF PARTS.....	4
2. SPECIFICATIONS	5
2-1. OUTLINE.....	5
2-2. ELECTRIC PARTS	6
2-3. POWER CORD	10
2-4. DOOR COLOR.....	11
3. OPERATION AND FUCTIONS.....	12
4. DIAGRAM	
4-1. WIRING DIRGRAM.....	23
4-2. CIRCIT DIAGRAM	24
4-3. AIR FLOW DIAGRAM.....	25
4-4. REFRIGENT CYCLE DIAGRAM.....	26
5. DISASSEMBLY AND ASSEMBLY.....	27
6. EXPLODED VIEW AND PARTS LIST.....	39
6-1. FR-230NT/590NT TOTAL EXPLODED VIEW AND PARTS LIST	39
6-2. FR-590NW TOTAL EXPLODED VIEW AND PARTS LIST	44
6-3. MACHINE ROOM EXPLODED VIEW AND PARTS LIST	49

1. EXTERNAL VIEWS

1. EXTERNAL SIZE

■ FR-530NT

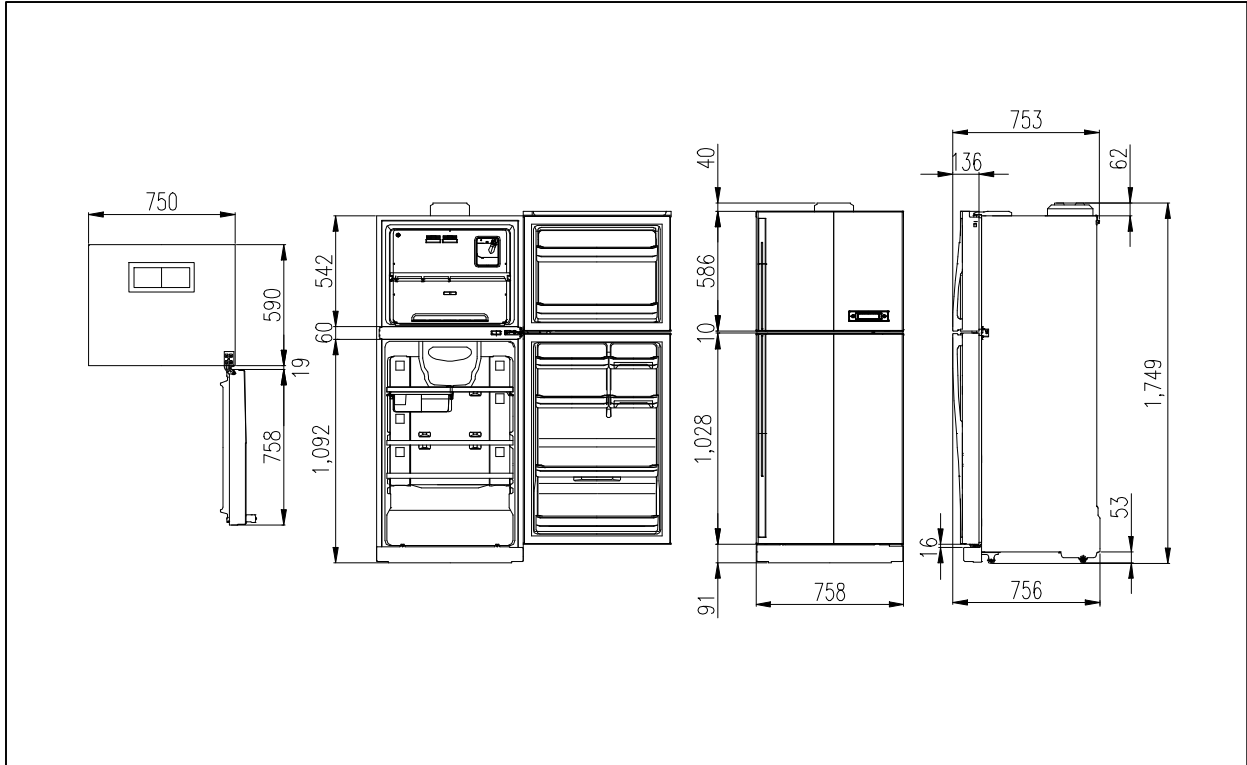

■ FR-590NT

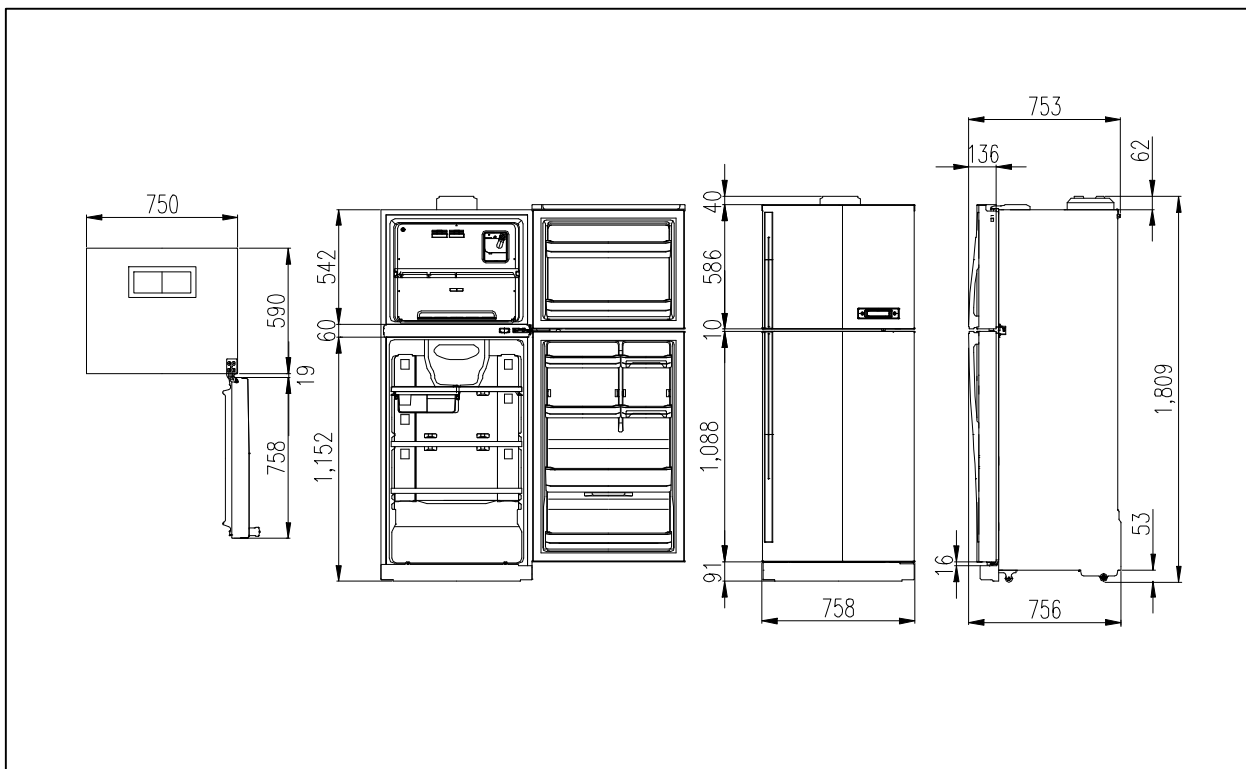

■ FR-590NW

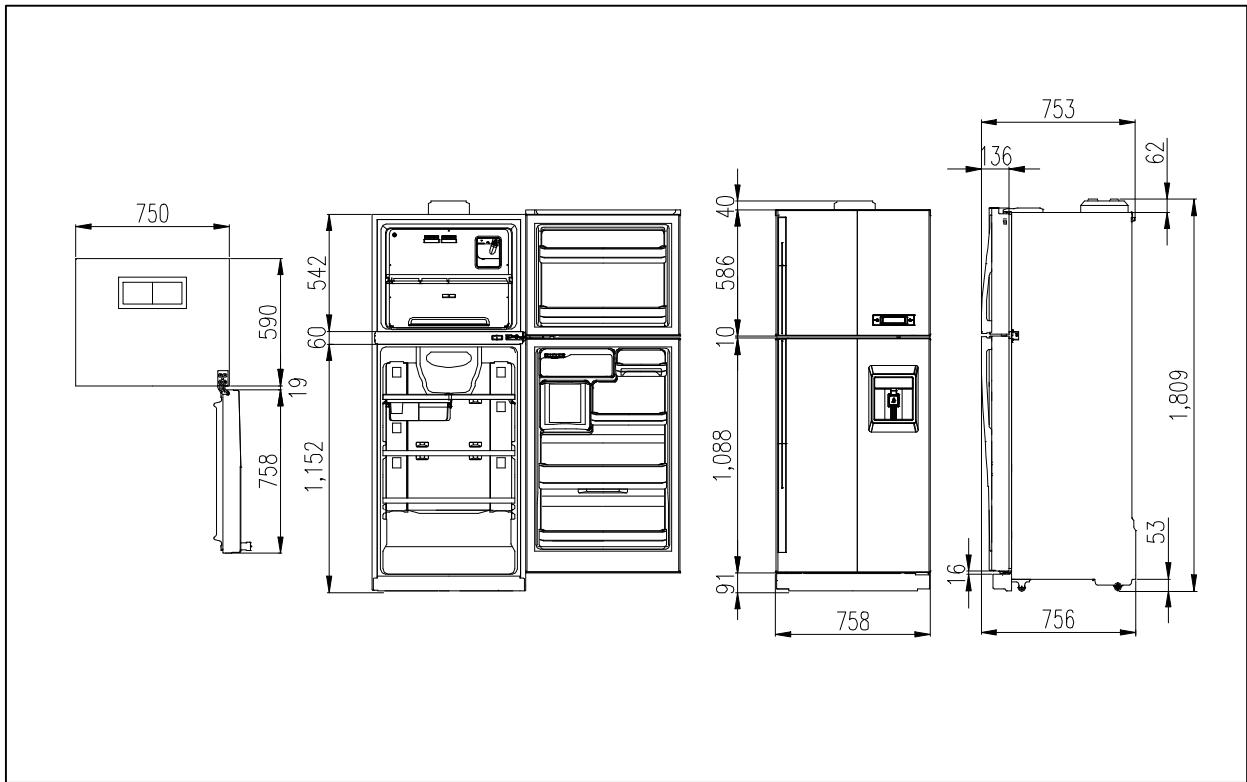

EXTERNAL VIEWS

2. NAME OF PARTS

■ FR-530NT,FR-590NT

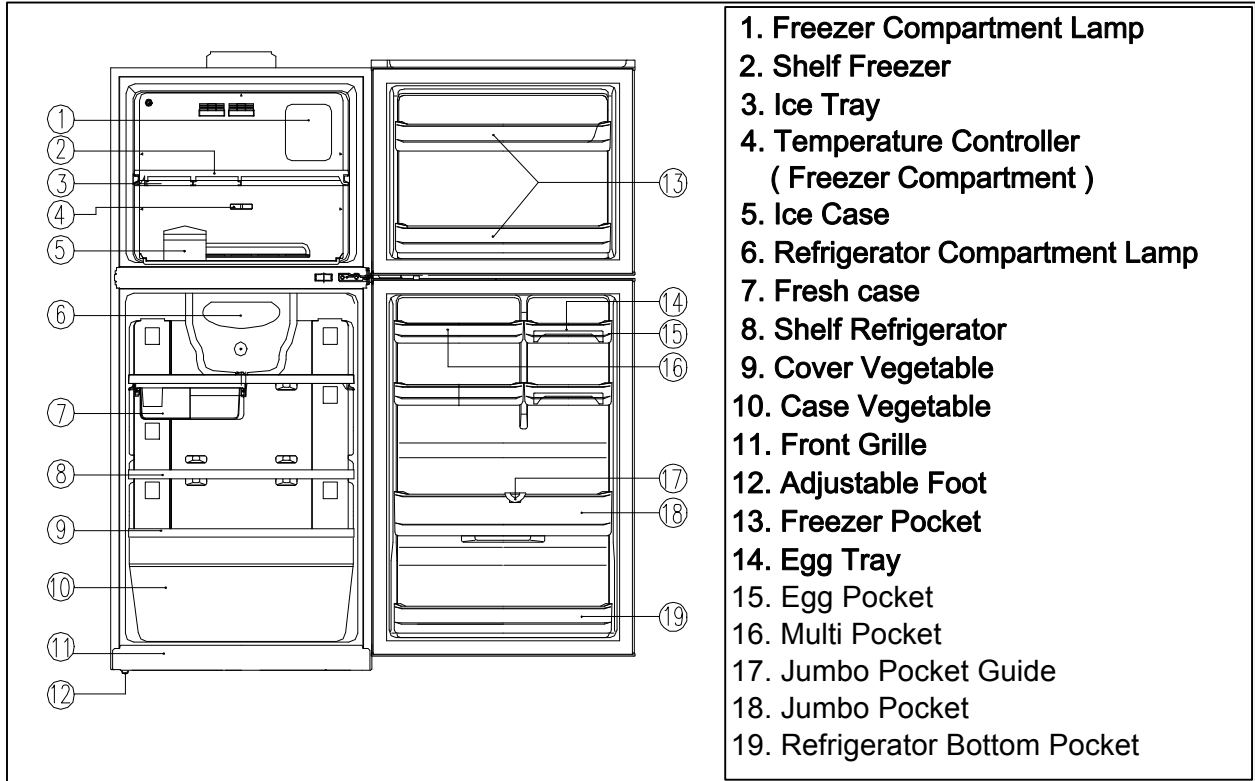

■ FR-590NW

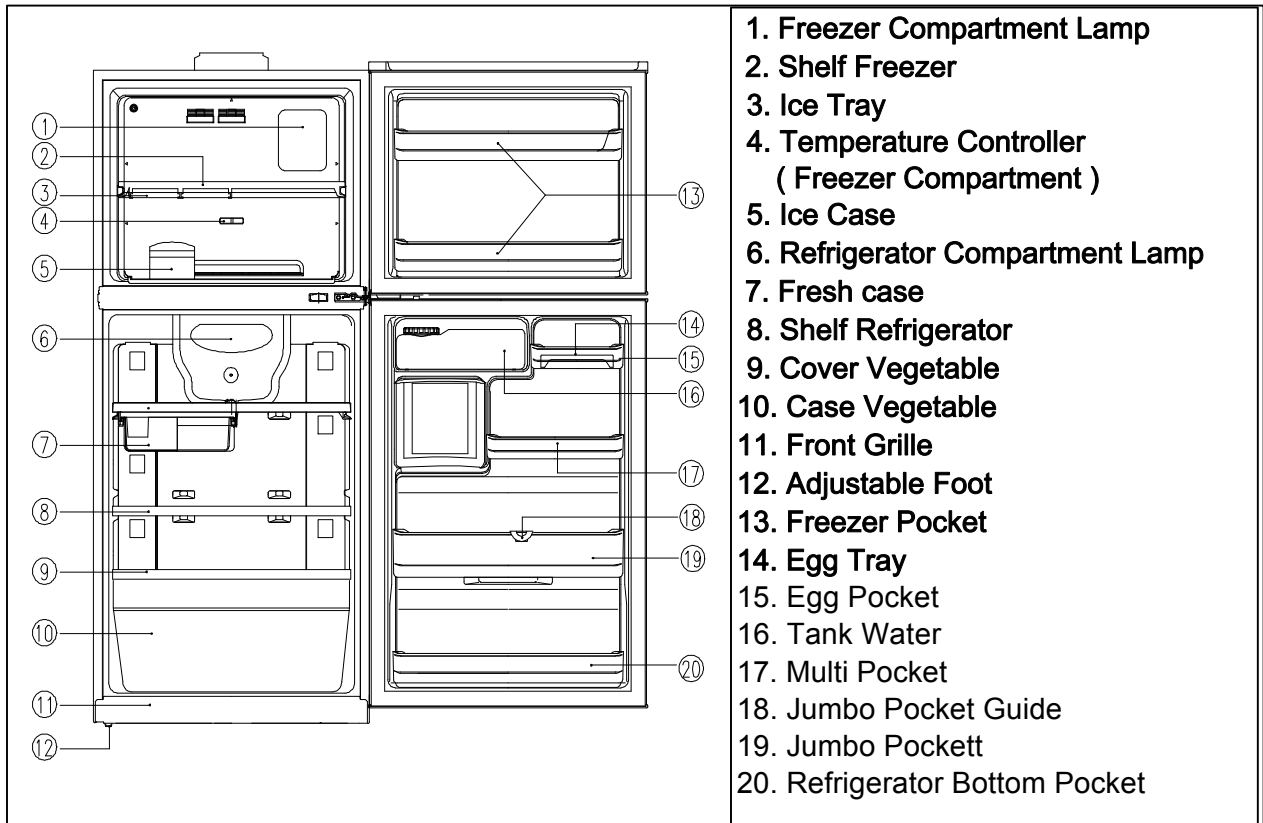

2. SPECIFICATIONS

2-1. OUTLINE

DIVISION		CONTENTS		
MODEL NAME		FR-530NT	FR-590NT	FR-590NW
USABLE CAPACITY (L)	FREEZER	125	125	125
	REFRIGERATOR	319	355	351
	TOTAL	444	480	476
EXTERNAL DIMENSION(mm)	WIDTH	758	758	758
	DEPTH	756	756	756
	HEIGHT	1749	1809	1809
REFRIGERANT	R12	115	115	115
	R134a	95	95	95
COOLING & CONTROL SYSTEM	COOLING SYSTEM	Fan Cooling System		
	DEFROST SYSTEM	Fin Evaporator Forced		
	DEFROST CONTROL	Automatic Start & Stop		
NET WEIGHT (kg)		71	72	72

EXTERNAL VIEWS

2-2 ELECTRIC PARTS

1) COMPRESSOR

REFRIGERANT	R12						
VOLTAGE (V/HZ)	100 /50,60	110 / 60	115,120/60	127/60	220 / 60	220~240 / 50	230 / 50
COMP MODEL	X	X	X	X	PL23YH-4	SL28YE-5	←
PART CODE	X	X	X	X	3956123P40	3954128A50	←
STARTING TYPE	X	X	X	X	RSCR	RSIR	←

REFRIGERANT	R134a						
VOLTAGE (V/HZ)	100 /50,60	110 / 60	115,120/60	127/60	220 / 60	220 ~240/50	230 / 50
COMP MODEL	X	HBL25YG-3	X	X	X	HSL27YE-5	HPL26YH-5
PART CODE	X	3952125R30	X	X	X	3954127G50	3956126S50
STARTING TYPE	X	CSR	X	X	X	RSIR	RSCR

2) RELAY

REFRIGERANT		R12						
VOLTAGE (V/HZ)		100 /50,60	110 / 60	115,120/60	127/60	220 / 60	220~240 / 50	230 / 50
ASSY	TYPE NAME	X	X	X	X	181SHBYY-52	276THBYY-52	←
	PART CODE	X	X	X	X	3018116610	3018119940	←
PTC	RESISTANCE	X	X	X	X	33 Ω	22 Ω	←
	PART CODE	X	X	X	X			
OVER LOAD	PART CODE	X	X	X	X			

REFRIGERANT		R134a						
VOLTAGE (V/HZ)		100 /50,60	110 / 60	115,120/60	127/60	220 / 60	220~240 / 50	230 / 50
ASSY	TYPE NAME	X	783NHBZZ-52	X	X	X	276THBYY-52	197NHBYY-52
	PART CODE	X	3018119390	X	X	X	3018119940	3018119920
PTC	RESISTANCE	X	S220	X	X	X	22 Ω	S330
	PART CODE	X		X	X	X		
OVER LOAD	PART CODE	X	783NHB	X	X	X	276THB	197NHB

3) STARTING CAPACITOR

REFRIGERANT	R12						
VOLTAGE (V/HZ)	100 /50,60	110 / 60	115,120/60	127/60	220 / 60	220 ~240 / 50	230 / 50
PART CODE	X	X	X	X	X	X	X
RATED VOLTAGE	X	X	X	X	X	X	X
RATED CAPACITANCE	X	X	X	X	X	X	X

REFRIGERANT	R134a						
VOLTAGE (V/HZ)	100 /50,60	110 / 60	115,120/60	127/60	220 / 60	220~240 / 50	230 / 50
PART CODE	X	3016400100	X	X	X	X	X
RATED VOLTAGE	X	200V	X	X	X	X	X
RATED CAPACITANCE	X	100 uF	X	X	X	X	X

4) RUNNING CAPACITOR

REFRIGERANT	R12						
VOLTAGE (V/HZ)	100 /50,60	110 / 60	115,120/60	127/60	220 / 60	220~240 / 50	230 / 50
PART CODE	X	X	X	X	3016401160	X	X
RATED VOLTAGE	X	X	X	X	350V	X	X
RATED CAPACITANCE	X	X	X	X	4 uF	X	X

REFRIGERANT	R134a						
VOLTAGE (V/HZ)	100 /50,60	110 / 60	115,120/60	127/60	220 / 60	220~240 / 50	230 / 50
PART CODE	X	3816800400	X	X	X	X	3016401910
RATED VOLTAGE	X	300V	X	X	X	X	400V
RATED CAPACITANCE	X	7 uF	X	X	X	X	4 uF

5) F-FAN MOTOR

REFRIGERANT	R12,R134a						
VOLTAGE (V/HZ)	100 /50,60	110 / 60	115,120/60	127/60	220/60	220~240 / 50	230 / 50
TYPE NAME	DL-2213DWFC	←	←	←	←	←	←
PART CODE	3015907200	←	←	←	←	←	←
REVOLUTION	2200RPM	←	←	←	←	←	←

EXTERNAL VIEWS

6) C- FAN MOTOR

REFRIGERANT	R12,R134a						
VOLTAGE (V/HZ)	100 /50,60	110 / 60	115,120/60	127/60	220/60	220~240 / 50	230 / 50
TYPE NAME	X		←				←
PART CODE	X	3015905031	←			3015905021	←
REVOLUTION	X	2400RPM	←		2400RPM	2400RPM	←

7) DEFROST HEATER

REFRIGERANT	R12,R134a						
VOLTAGE (V/HZ)	100 /50,60	110 / 60	115,120/60	127/60	220/60	220~240 / 50	230 / 50
SPEC (W)	X	110V 148W	←	←	220V 148W	←	←
PART CODE	X	3012805510	←	←	3012805500	←	←

8) LAMP ASSEMBLY

REFRIGERANT	R12,R134a						
VOLTAGE (V/HZ)	100 /50,60	110 / 60	115,120/60	127/60	220/60	220~240 / 50	230 / 50
SPEC (W)	X	120V 15W	←	←	240V 15W	←	←
PART CODE	X	3013600050	←	←	3013600020	←	←
COLOR							

9) MAIN PCB ASSEMBLY

REFRIGERANT	R12,R134a						
VOLTAGE (V/HZ)	100 /50,60	110 / 60	115,120/60	127/60	220/60	220~240 / 50	230 / 50
TYPE NAME	X	RT2002	←	←	←	←	←
PART CODE	X	3014392000	←	←	←	←	←

10) DRYER

REFRIGERANT	R12	R134a
SPEC (g)	10g	15g
PART CODE	3016801000	3016801010

11) FUSE (PCB)

REFRIGERANT	R12,R134a						
VOLTAGE (V/HZ)	100 /50,60	110 / 60	115,120/60	127/60	220/60	220~240 / 50	230 / 50
RATED CURRENT	x	250V/1.6A	←	←	←	←	←
PART CODE	x	5F3GB1682R	←	←	←	←	←

12) THERMOSTAT FUSE

REFRIGERANT	R12,R134a						
VOLTAGE (V/HZ)	100 /50,60	110 / 60	115,120/60	127/60	220/60	220~240 / 50	230 / 50
OPERATING TEMPERATURE	x	77°C	←	←	←	←	←
PART CODE	x	3017200500	←	←	←	←	←

13) DOOR S/W





REFRIGERANT	R12,R134a						
VOLTAGE (V/HZ)	100 /50,60	110 / 60	115,120/60	127/60	220/60	220~240 / 50	230 / 50
PART CODE	3018100010	←	←	←	←	←	←

14) R-SENSOR

REFRIGERANT	R12,R134a						
VOLTAGE (V/HZ)	100 /50,60	110 / 60	115,120/60	127/60	220/60	220~240 / 50	230 / 50
PART CODE	3014802300	←	←	←	←	←	←

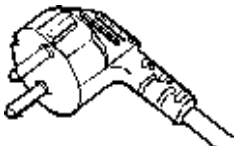
EXTERNAL VIEWS

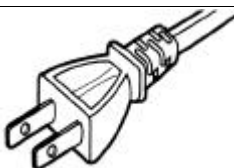
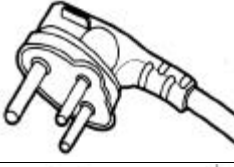
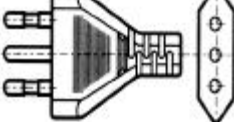
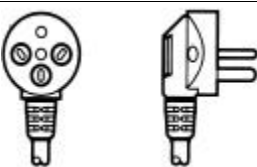
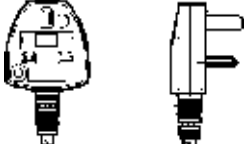
3. POWER CORD

NO	SHAPE OF POWER CORD	PART CODE	DESCRIPTION	REMARK
1		3011315000	CP-2PIN	For european country
2		401RA17200	CP-2PIN	For other country
3		4006D17101	KP-30	For America & El Salvador
4		401PD17101	KP-211	For Japan & Taiwan
5		3011300801	BP-3PIN	
6		3011303010	# 267	For Chile
7		3011315310		For Israel
8		3011303050	BS-1363A	For U.K, Middle Asia Singapore & Malaysia
9		3011301200	KP-551/550	For China & Australia

* Upper power cord's part code is only lead wire, without any kinds of terminal or housing

4. DOOR COLOR

1) ASSEMBLY URETHAN FREEZER DOOR

Refrigerant	R12				R134a			
COLORTYPE	Dull laminasheet	High-glossy Laminasheet	Normal PCM	High-glossy Bright PCM	Dull laminasheet	High-glossy Laminasheet	Normal PCM	High-glossy Bright PCM
PARTCODE								

2) ASSEMBLY URETHAN REFRIGERATOR DOOR

■ FR-530NT

a. NON-KEY TYPE

Refrigerant	R12				R134a			
COLORTYPE	Dull laminasheet	High-glossy Laminasheet	Normal PCM	High-glossy Bright PCM	Dull laminasheet	High-glossy Laminasheet	Normal PCM	High-glossy Bright PCM
PARTCODE								

b. KEY TYPE

Refrigerant	R12				R134a			
COLORTYPE	Dull laminasheet	High-glossy Laminasheet	Normal PCM	High-glossy Bright PCM	Dull laminasheet	High-glossy Laminasheet	Normal PCM	High-glossy Bright PCM
PARTCODE								

■ FR-590NT

a. NON-KEY TYPE

Refrigerant	R12				R134a			
COLORTYPE	Dull laminasheet	High-glossy Laminasheet	Normal PCM	High-glossy Bright PCM	Dull laminasheet	High-glossy Laminasheet	Normal PCM	High-glossy Bright PCM
PARTCODE								

b. KEY TYPE

Refrigerant	R12				R134a			
COLORTYPE	Dull laminasheet	High-glossy Laminasheet	Normal PCM	High-glossy Bright PCM	Dull laminasheet	High-glossy Laminasheet	Normal PCM	High-glossy Bright PCM
PARTCODE								

■ FR-590NW

a. NON-KEY TYPE



Refrigerant	R12				R134a			
COLORTYPE	Dull laminasheet	High-glossy Laminasheet	Normal PCM	High-glossy Bright PCM	Dull laminasheet	High-glossy Laminasheet	Normal PCM	High-glossy Bright PCM
PARTCODE								

b. KEY TYPE

Refrigerant	R12				R134a			
COLORTYPE	Dull laminasheet	High-glossy Laminasheet	Normal PCM	High-glossy Bright PCM	Dull laminasheet	High-glossy Laminasheet	Normal PCM	High-glossy Bright PCM
PARTCODE								

3. OPERATION AND FUNCTION

1. DISPLAY

INPUT	CONTROL OBJECT	
F-PCB Buttons ; TEMP CONTROL Button	CUSTOM LED	
CONTENTS		REMARK
<p>1. Custom LED Display</p>  <p>2. Normal State</p> <p>1) Initial State ; Compartment Icons indicate Medium-mode ("MED" LDE BAR are lit.)</p> <p>3. TEMP CONTROL Button</p> <p>1) Temperature Regulation of Freshfood Compartment</p> <p>2) Medium-right Icons are lit by pressing the button.</p> <p style="text-align: center;"> → MIN → MED → MAX → SUPER </p> <p style="text-align: center;">  </p> <p>4. Temperature Regulation of Freezer Compartment</p> <p>1) Temperature is regulated by moving the lever to the lift and/or the right</p> <p>2) Temperature has nothing to do with PCB control.</p>		

2. Temperature Regulation of Refrigerator (Freshfood Compartment)

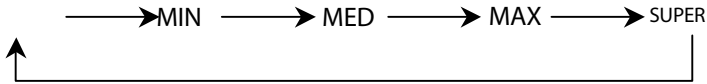
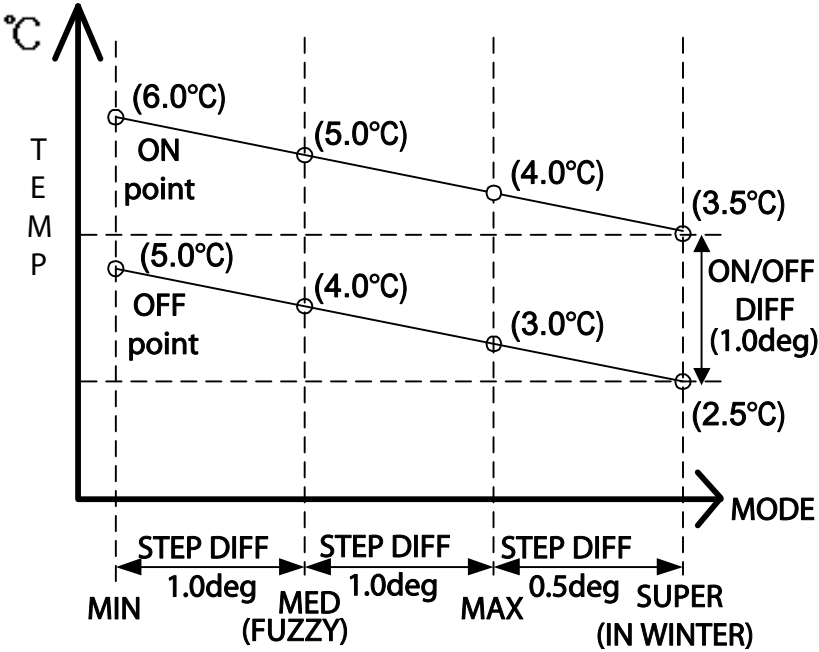
INPUT	CONTROL OBJECT	
1. TEMP Control Button 2. R-Sensor 3. RT -Sensor	1. COMP 2. F-FAN	
CONTENTS		REMARK
<p>1. Temperature regulation by TEMP Control Button.</p>  <p>2. Fan is controlled by On/Off-point of each mode.</p> <p>3. ON / OFF DIFF : 1.0 °C (Medium Off-point : 4.0 °C)</p> <p>4. Step Difference of Fresh Food Compartment. MIN <=> MED : 1 °C MED <=> MAX : 1 °C MAX <=> SUPER(IN WINTER) : 0.5 °C</p> 		<p>►Reference</p> <ul style="list-style-type: none"> - <u>ON/OFF Diff</u> : Fixed at Micom - <u>STEP Diff</u> : Fixed at Micom <p><u>Comp/C-fan co-working</u></p>

OPERATION AND FUNCTION

3. FUZZY MODE

INPUT	CONTROL OBJECT
1. FUZZY Control Button 2. R-Sensor 3. RT-Sensor	1. COMP 2. F-FAN
CONTENTS	REMARK
1. FUZZY MODE is started by pushing the FUZZY Control Button. 2. If you want to stop the FUZZY MODE function, Push the FUZZY Control Button again. 3. At FUZZY MODE, the TEMP Control is set to "MED" of normal mode. 4. At FUZZY MODE, the TEMP Control Button cannot be set. (At FUZZY MODE stop, the TEMP Control Button can be set.)	

4. Defrosting Period

INPUT	CONTROL OBJECT	
1. Total Run-time of COMP 2. Running-rate of COMP 3. Total time of Door openings 4. Total times of Door open-close 5. RT-Temperature	1. Defrosting Mode	
CONTENTS		REMARK
1. What to be considered in determining Defrosting Period 1) Total Run-time of COMP : 6,7,8,9,10,11,12,13 hours 2) Running-rate of COMP (every 1 hour's running-rate) : more than 80% 3) Total time of Door openings : 3 minutes 4) Total times of Door open-close : 4 times 5) Total time (COMP-On + COMP-Off) : 60 hours 6) Ambient Temperature : more than 35 7) In each Error : R1, D1, F3, C1, RT Error 2. Terms to start Defrosting Period 1) The Defrosting starts with the following conditions, in case total COMP-run time passes 6 hours a. When an Error occurs b. When running-rate of COMP (every 1 hour's running-rate) is more than 80% c. When total Door-opening time is more than 3 minutes d. When total times of Door open-close is more than 4 times e. When the ambient temperature is more than 35 2) After total COMP-run time passes 6 hours, Defrosting starts under the condition that terms of 1) are satisfied, in case of each 1 hour's COMP running-rate. 3) Defrosting starts unconditionally when total COMP-run time passes 14 hours under the condition that terms of 1), 2) are not satisfied. 4) Defrosting starts immediately when total time (COMP-On + COMP-Off time) is more than 60 hours under the condition that terms of 1), 2), 3) are not satisfied.		

5. Defrosting Mode

INPUT	CONTROL OBJECT				REMARK
1. Defrosting Period	1. COMP 2. F-FAN 3. HEATER				
CONTENTS					REMARK
1. Defrosting Mode					C-Fan and COMP are co-working.
<div style="border: 1px solid black; padding: 5px; width: fit-content; margin: 0 auto;">Pre-cool</div>	1) Time : 25minutes 2) COMP and F-Fan are On, and HTR is off 3) Pre-cool turns off when R-Sensor $\leq 2.5\text{ }^{\circ}\text{C}$				
<div style="border: 1px solid black; padding: 5px; width: fit-content; margin: 0 auto;">Heater Defrosting</div>	1) Heater turns off when D-Sensor $\leq 10\text{ }^{\circ}\text{C}$ 2) Limit time : 80minutes 3) Heater continues to be On for 40 minutes of limit time when D-Sensor is in error. 4) Limit time <ul style="list-style-type: none"> a. 30 seconds : Heater continues to be on after Defrostomg regardless of D-Sensor temperature. b. 40 minutes : in case of D1 Error c. 80 minutes : in normal control state 				
<div style="border: 1px solid black; padding: 5px; width: fit-content; margin: 0 auto;">Pause</div>	1) Time : 4minutes 2) COMP and F -Fan are Off.				
<div style="border: 1px solid black; padding: 5px; width: fit-content; margin: 0 auto;">Fan -delay</div>	1) Time : 5minutes 2) Only COMP is On, while F-Fan is off.				
2. Output Control and Limit Time of each Defrosting Mode					
	Pre-cool	HTR Defrosting	Pause	Fan-delay	
COMP	ON	OFF	OFF	ON	
F-Fan	ON	OFF	OFF	OFF	
Heater	OFF	ON	OFF	OFF	
Limit Time	25 min	a. 80 min b. 40 min (In D-Sensor error)	4 min	5 min	

6. Error Display (displayed on C-LED of F-PCB)

INPUT		CONTROL OBJECT	
1. TEMP Control Button 2. Refrigerator (Freshfood Compartment) Door		1. CUSTOMLED	
CONTENTS			REMARK
1. How to start ; open and close refrigerator door 3 times while pressing TEMP Control Button and it starts after 3 seconds. 2. Display 1) If any error, Bar-LED of C-LED are lit. 2) In Error Display Mode, the Buzzer beeps in short interval - every 0.1 second at 5 seconds' cycle. 3. How to finish : doing above NO.1 again. 4. It ends by itself 4 minutes after start. 5. All the Error Code is reset by itself when it returns to normal state. 6. At FUZZY MODE, the ERROR Display mode cannot be set. (At FUZZY MODE stop, the ERROR Display mode can be set.) 7. Error Code			Limit-time ; 4min. Check Error without using Jig
JIG Code	Custom LED	CONTENTS	Running State
r 1	"MIN " of Up	R-S open/shortcircuit	Running by 20min.'s period according to RT
r t	"MED " of Up	RT -S open/shortcircuit	Deletion by RT-Sensor
d 1	"MAX " of Up	D-S open/shortcircuit	Heater is On for 40 min. during Defrosting.
d00r	"SUPER " of Up	Defective Door S/W (when S/W senses that door opened more than 1 hour)	Deletion of sensing DoorS/W
C 1	"MIN " of Down	Abnormal Cycle (COMP runs more than 3 hours at D-S \geq -5°C)	Normal Running
F 3	"MED " of Down	In case of Heater Defrosting, when it returns to Time(80min.), not D-Sensor	Normal Running (Deletion of Pre-cool Mode in Defrosting Mode)
ALL LED Bar off		Normal state without Error	
6. Error Control 1) "r1" Error a. Occurrence : in case of R-Sensor open/short-circuit. b. Control it in accordance as ambient temperature.			

CONTENTS						REMARK
RT-S	rt Error	~13℃	14~19℃	20~29℃	29℃~	
Running Rate (ON/OFF)	16 / 24	6 / 34	10 / 30	16 / 24	20 / 20	
<p>c. Dissolution : if R-Sensor is in normal state, it is finished by itself.</p> <p>2) "rt" Error</p> <p>a. Occurrence : RT-Sensor open/short-circuit</p> <p>b. Control : deletion of control condition by RT-Sensor</p> <p>c. Dissolution : if RT-Sensor is in normal state, it is finished by itself.</p> <p>3) "d1" Error</p> <p>a. Occurrence : D-Sensor open/short-circuit</p> <p>b. Control : by limit time (40min) of Defrosting-return</p> <p>c. Dissolution : if D-Sensor is in normal state, it is finished by itself.</p> <p>4) "door" Error</p> <p>a. Occurrence : when door-opening is sensed for more than 1 hour</p> <p>b. Control : deletion of Door SW sensing function</p> <p>c. Dissolution : if Door SW open-close is sensed, it ends by itself.</p> <p>d. Display dissolution : after Custom LED Display Mode (Door SW should be in normal state if Error Display Mode is to start.)</p> <p>6) "C1" Error</p> <p>a. Occurrence : when COMP runs continuously for more than 3 hours while D-Sensor is above -5℃</p> <p>b. Control : normal running</p> <p>c. Dissolution : when D-Sensor temperature is below -5℃ while Comp is Off</p> <p>7) "F3" Error</p> <p>a. Occurrence: by limit time of 80min at defrosting-return</p> <p>b. Control : normal running</p> <p>c. Dissolution : the end of defrosting is done by D - Sensor</p>						

7. Forced Defrosting

INPUT	CONTROL OBJECT	
1. Defrosting Key	1. Defrosting Mode	
CONTENTS		REMARK
<p>A/S (Heater) Forced Defrosting</p> <ol style="list-style-type: none"> 1. Start : The defrosting begins by pressing defrosting key 5 times (Defrosting.) 2. Process <ol style="list-style-type: none"> 1) Let Heater On for 30seconds. 2) Delete Precool of normal defrosting mode. <p style="text-align: center;">HTR → Pause → Fan Delay → Normal</p> 3. Heater turns Off when D-Sensor temperature is more than 10°C, 30 seconds after Heater On. 4. If FUZZY Control Button is pushed 5 times while pushing TEMP Control Button at the same time, then the Forced Defrosting mode begins. 5. At FUZZY MODE stop, the Forced Defrosting function can be set. 		

8. Time Delay of Electric Devices

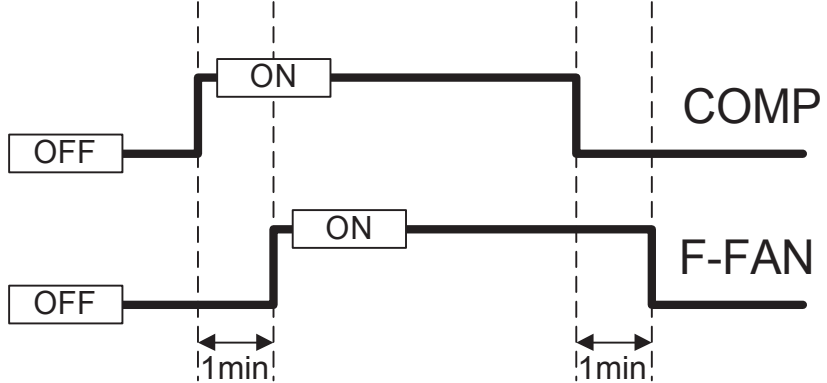
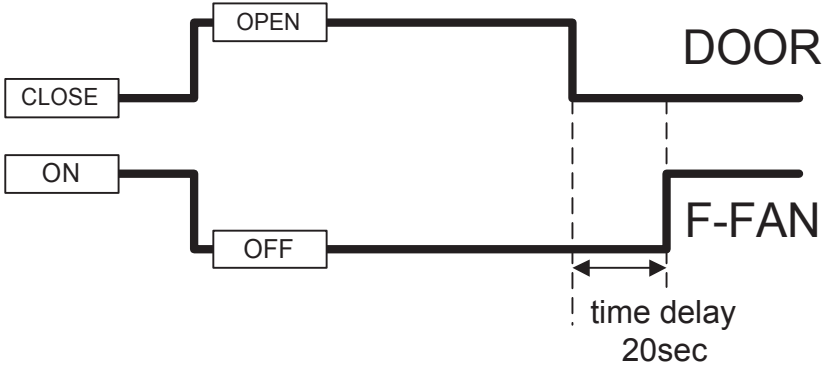
INPUT	CONTROL OBJECT	
1. Door Switch 2. COMP On/Off	1. F-FAN	
CONTENTS		REMARK
<p>1. F-Fan Time Delay in COMP On/Off * Fan turns On/Off 1minute after COMP On/Off.</p>  <p>2. F-Fan Time Delay by Door Switch * Line check on : After 6 hours of initial run, the function of easy-door opening starts.</p>  <p>1)Before 6 hours of initial run, F-Fan delay time is 1sec. 2)After 6 hours of initial run, F-Fan delay time is 20sec.</p>		

9. Initial Defrosting

INPUT	CONTROL OBJECT
1. D-Sensor 2. Initial Power Supply	1. Defrosting Mode
CONTENTS	
1. Defrosting mode starts when D-Sensor $\leq 3.5^{\circ}\text{C}$ at initial power supply.	REMARK COMP delayed for 6 min. at initial defrosting

10. Explanation after Delivery

INPUT	CONTROL OBJECT
1. TEMP Control Button 2. Power Cord	1. Electric Devices
CONTENTS	
1. Start : push the TEMP Control Button for 5 seconds within 10 seconds. after initial power supply(plug-in). 2. Electric devices turn Off for 3 hours. 3. Display works in normal way.	REMARK

11. Prevention of COMP Restart

INPUT	CONTROL OBJECT
1. (None)	1. COMP
CONTENTS	
1. COMP does not restart for 6 minutes after COMP Off, though R-Sensor turns on.	REMARK 6 min. delay

12. Buzzer Alarm

INPUT	CONTROL OBJECT
1. Buttons on F-PCB 2. Door Switch	1. BUZZER
CONTENTS	
1. Buzzer rings by pushing F-PCB Buttons. 2. Buzzer rings for 1 second after initial power supply (plug-in). 3. Buzzer rings for 1 second at the start of A/S Forced Defrosting. 4. Buzzer rings every 1 minute after door opening. (It rings within 5 minutes and ring-time is prolonged as time passes.) 5. Buzzer makes short ring every 5 seconds in Error Display.	REMARK

OPERATION AND FUNCTION

13. Demonstration Function

INPUT		CONTROL OBJECT							
1. Door Switch 2. TEMP Control Button		1. Electric Devices							
CONTENTS			REMARK						
1. Start : open and close Refrigerator[Freshfood Compartment] Door 5 times while pushing TEMP Control Button at the same time. 2. Control 1) Electric devices turn Off except for F-Fan. 2) Fan Control <table border="1" data-bbox="256 741 841 808"> <thead> <tr> <th></th> <th>Door Open</th> <th>Door Close</th> </tr> </thead> <tbody> <tr> <td>F-FAN</td> <td>ON</td> <td>OFF</td> </tr> </tbody> </table>				Door Open	Door Close	F-FAN	ON	OFF	
	Door Open	Door Close							
F-FAN	ON	OFF							
3. Dissolution : 1) Open and close Refrigerator[Freshfood Compartment] Door 5 times while pushing TEMP Control Button at the same time. in Demonstration mode. 2) Supply the power again (plug-out and plug-in)									

14. Control of R -Sensor Off -Point

INPUT		CONTROL OBJECT									
1. Slide SW(SW1) on M -PCB		1. Control Resistance of R-Sensor "2" Off-point									
CONTENTS			REMARK								
1. In case of Weak-refrigeration (though F-Fan and COMP work on and on), the following actions are to be done. 2. Resistance R70 : Control Resistance of R -Sensor Medium Off-point (4.0 °C , 31.4KΩ) 3. Resistance R71 : reduceing R-Sensor Resistance by 1.5 °C Refrigeration (2.5 °C , 2KΩ) 4. Resistance R72 : reduceing R-Sensor Resistance by 1.5 °C in case of weak-Refrigeration (1.0 °C , 2KΩ) 5. J1,J2 : during A/S, if J1,J2 are opened, R -Sensor Medium Off-point decreases by 1.5 °C 6. J1, J2 Status and R-Sensor Medium Off -point <table border="1" data-bbox="284 1648 1026 1805"> <thead> <tr> <th>J1,J2 Status</th> <th>R-Sensor Medium Off-point</th> </tr> </thead> <tbody> <tr> <td>J1 (o), J2 (o)</td> <td>4.0 °C</td> </tr> <tr> <td>J1 (x), J2 (o)</td> <td>2.5 °C</td> </tr> <tr> <td>J1 (x), J2 (x)</td> <td>1.0 °C</td> </tr> </tbody> </table>			J1,J2 Status	R-Sensor Medium Off-point	J1 (o), J2 (o)	4.0 °C	J1 (x), J2 (o)	2.5 °C	J1 (x), J2 (x)	1.0 °C	- (o) : Jumper exist - (x) : Jumper don't exist
J1,J2 Status	R-Sensor Medium Off-point										
J1 (o), J2 (o)	4.0 °C										
J1 (x), J2 (o)	2.5 °C										
J1 (x), J2 (x)	1.0 °C										

4. DIAGRAM

1. WIRING DIAGRAM

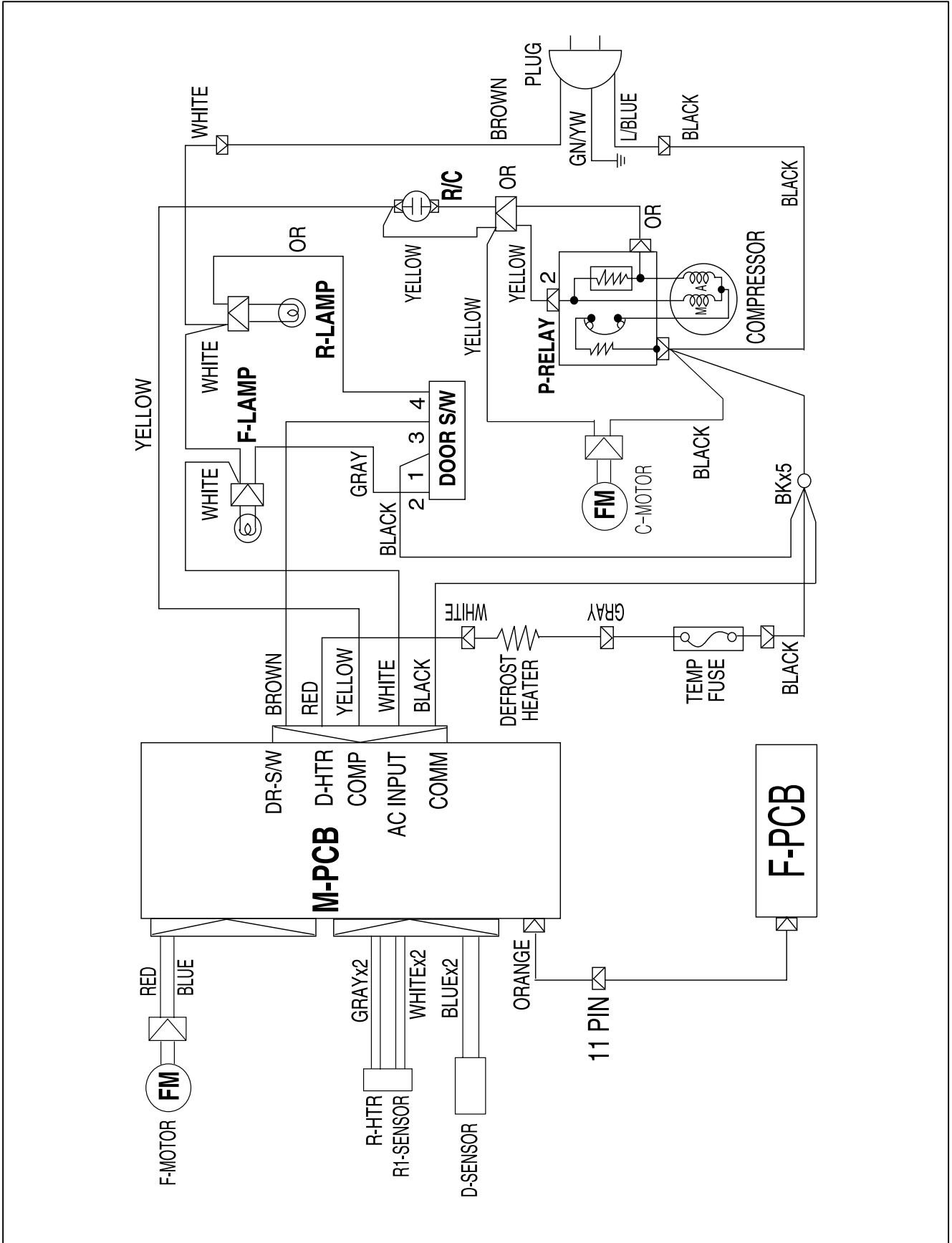

2. CIRCUIT WIRING DIAGRAM

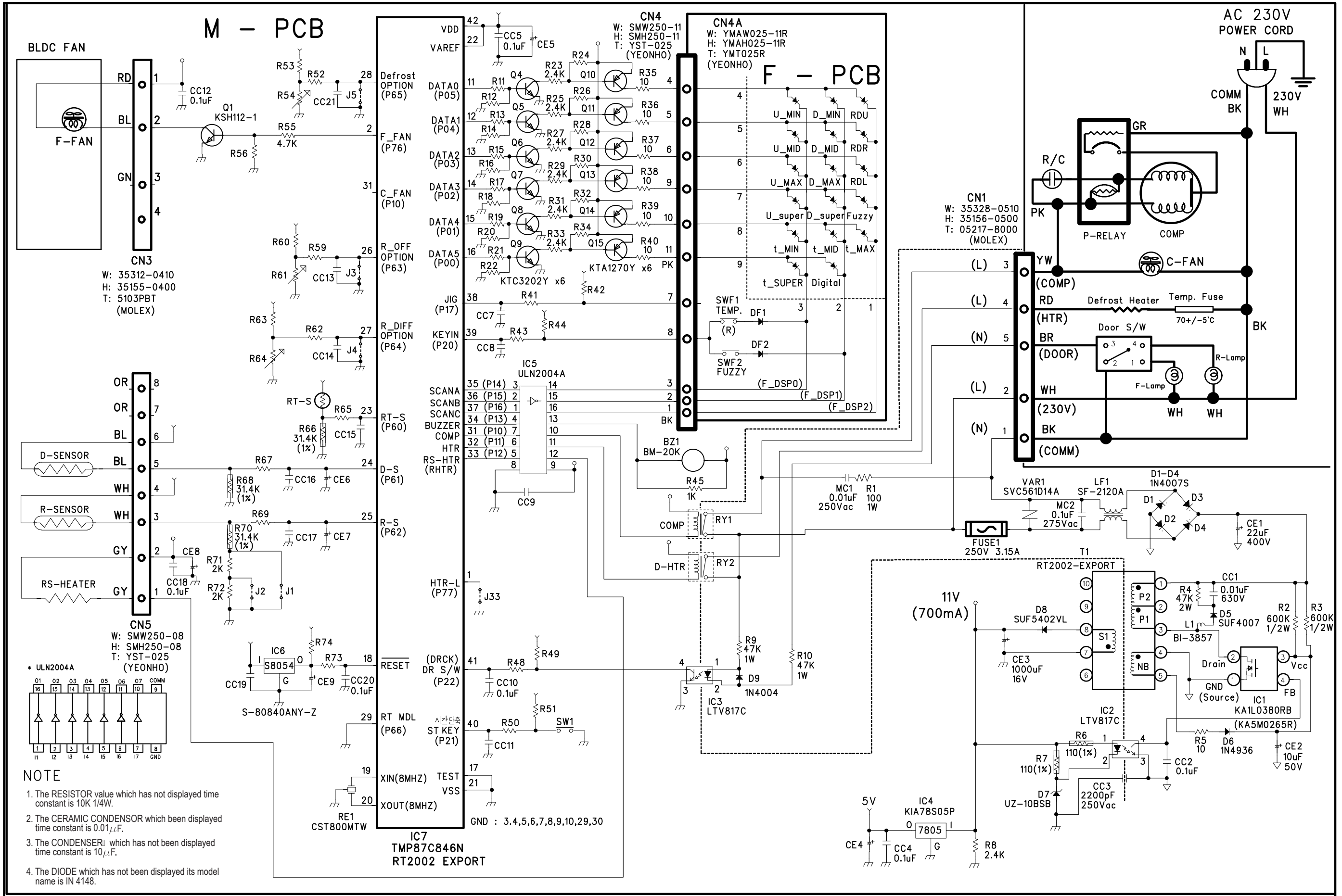

3. AIR FLOW DIAGRAM

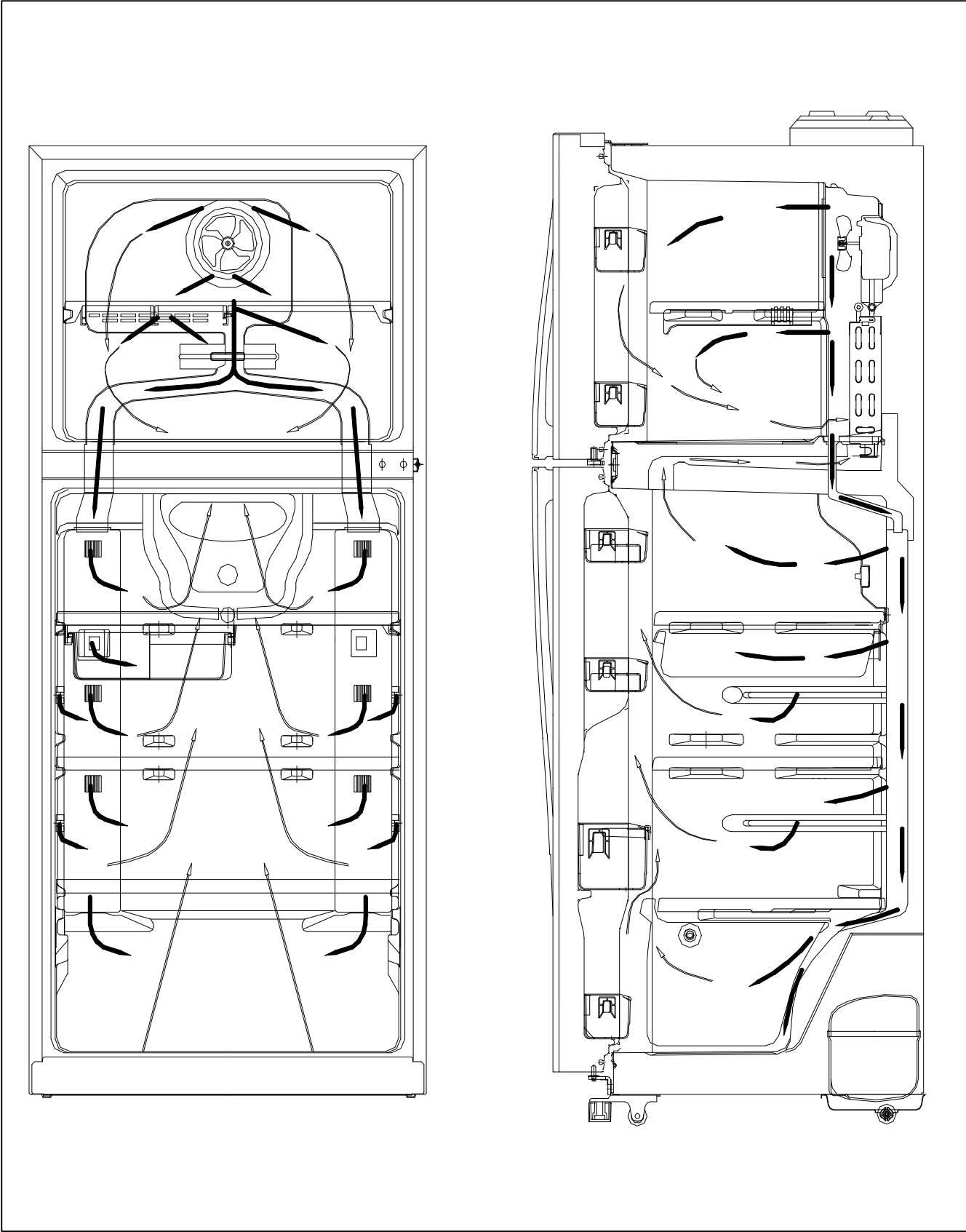

4. REFRIGRANT CYCLE DIAGRAM

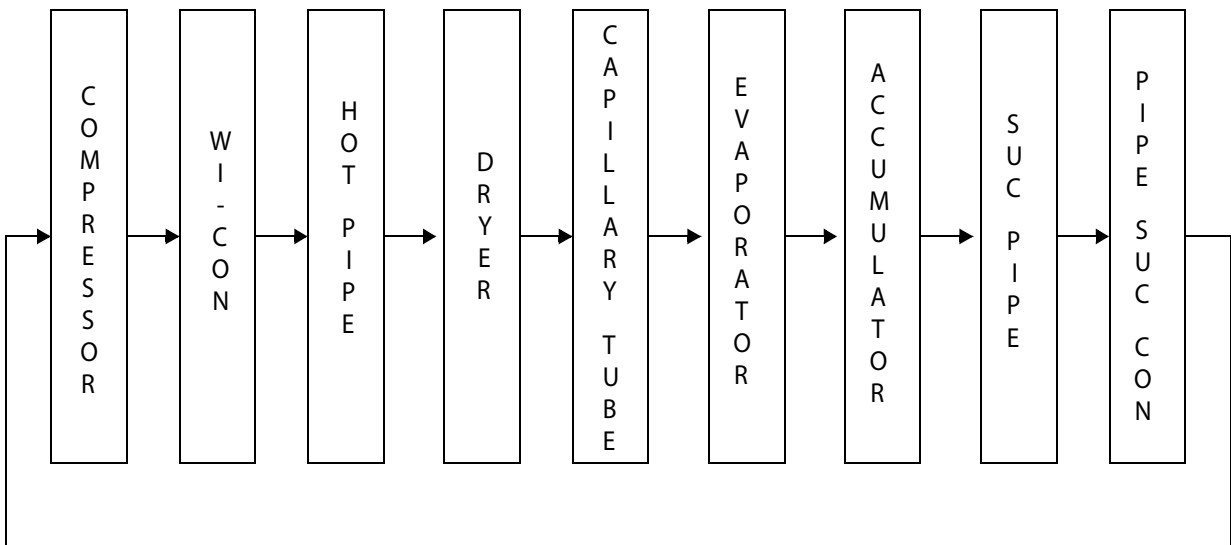
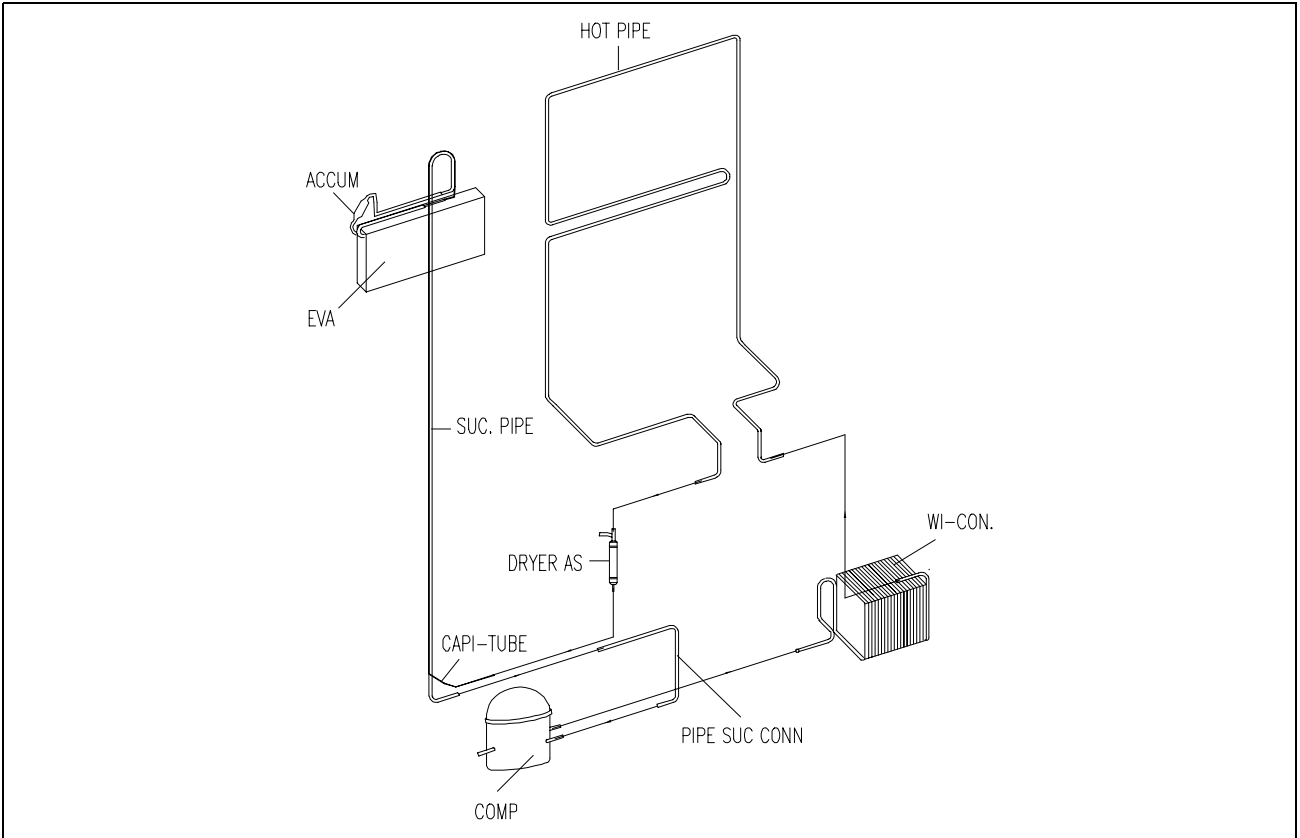

5. DISASSEMBLY AND ASSEMBLY

1.FREEZER & REFRIGERATOR DOORS

1) Insert flat type(-) screw driver between Hinge cover and Cabinet surface to remove the Cover
(Be careful not to break the hooks of Cover and not to damage the Cabinet surface.)



2) Remove 4 bolts with 10mm wrench.
3) Disconnect Connector Housing
4) Lift F-Door a little to remove it.

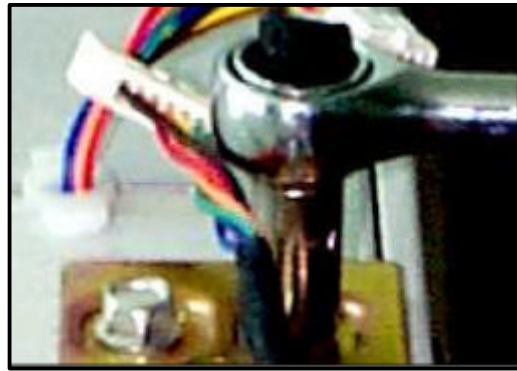

5) Unfasten Hinge Pin with 6mm wrench.



6) Lift R-Door up a little to remove it.



2.DOOR HANDLES

- 1) Insert rectangular bent tool whose diameter is less than 4mm into the hole of Handle to remove the Handle Decorator.



- 2) Pull out Handle Decorator from up to down
* Be careful not to damage the surface of Handle
Once it is peeled or damaged, corrosion may occur from metal parts beneath the handle.



- 3) Remove the 2(3) Handle screws.
- 4) See to it that the screws are fastened well when reassembling the handle.



3. FREEZER LOUVER

1) Push smoothly the locker of light bulb cover and Remove it



2) Remove the screw cover on the top left using screw driver ("- " type)



3) Remove the screw using driver. ("+" type)



4) Remove the screw on the light bulb base.



DISASSEMBLY AND ASSEMBLY

5) Pull the housing by pressing the locker smoothly



6) Remove the louver

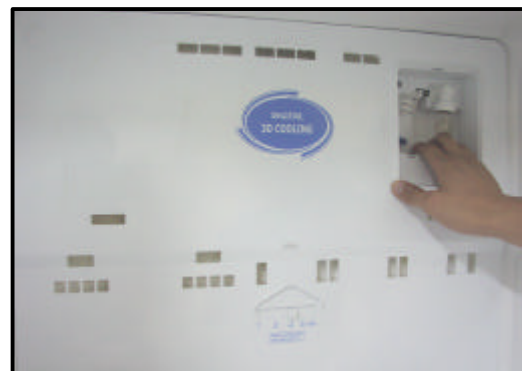

4. REFRIGERATOR CONTROL BOX

1) Remove the light bulb cover by pushing the locker with screw driver



2) Remove the screws on the light bulb base.



5.EXCHANGE OF TEMPERATURE FESE

1) Remove fuse fixing clip down left of evaporator

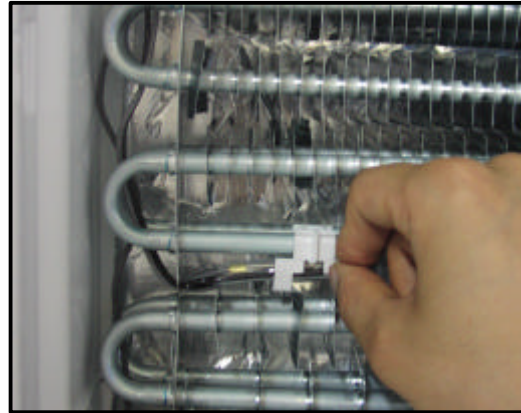

2) Separate temperature fuse out of fixing clip

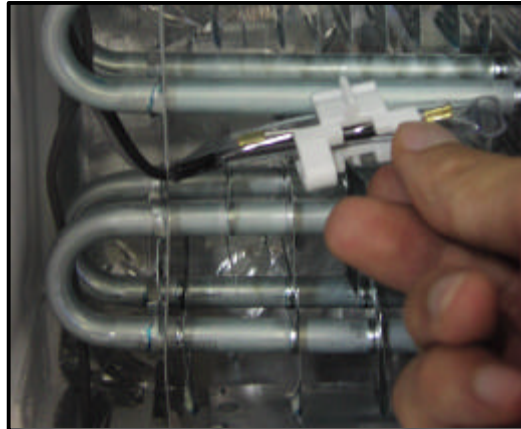

3) Pull out temperature fuse connector of 2 wires

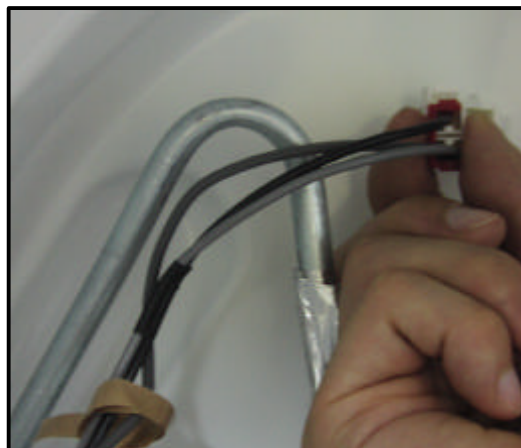

6. EVAPORATOR

- 1) Place any sheet on freezer compartment floor to protect it
- 2) Remove 2 screws left right of evaporator.



- 3) Cut black gum out.



- 4) Pull pipes about 50mm forward.
- 5) Disconnect pipes by unsoldering them

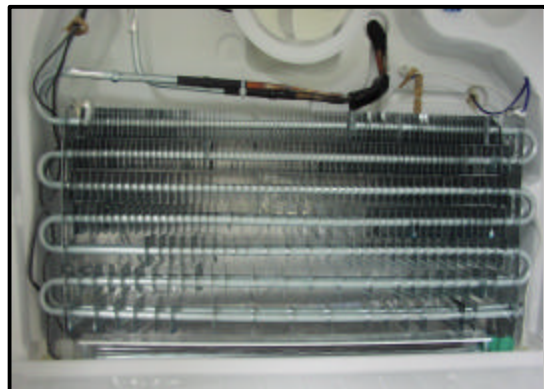

7. DEFROST HEATER

1) Remove connector of gray wire on the top left.

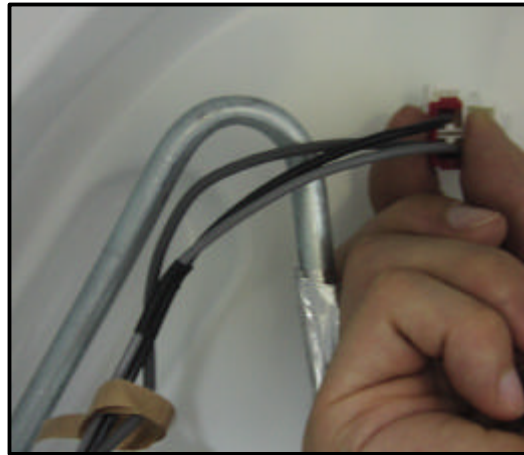

2) Remove connector of white wire on the top right.



3) Remove defrosting sensor on the top right of evaporator.

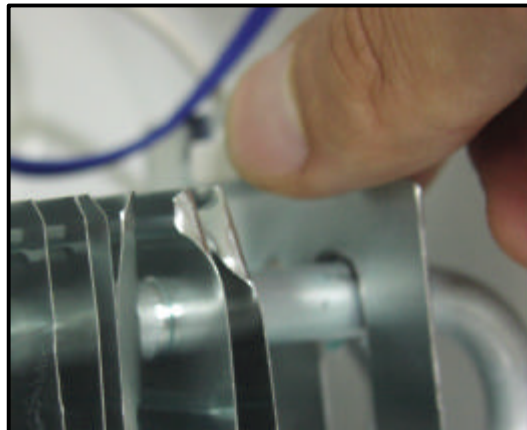

DISASSEMBLY AND ASSEMBLY

4) Pull evaporator forward slowly until defrosting heater appears.

* Be careful not to damage suction pipe and capillary pipe.



5) Pull heater fixing rubbers forward.



6) Straighten with screw driver left 2 hooks of aluminum plate, then right hooks are open of itself.

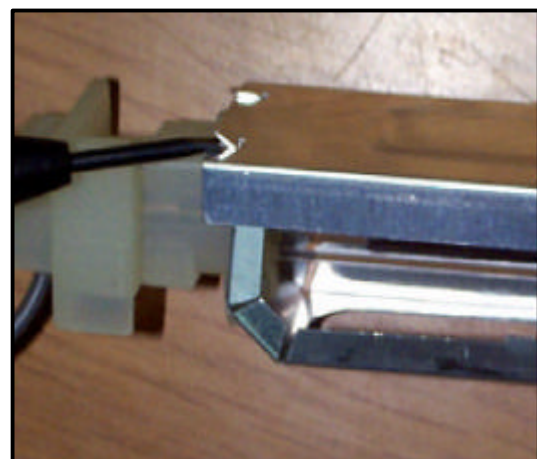

8. CUBIC DUCT

- 1) insert screw driver into the gap to pull out
* Be careful not to break the hook.



9. SIDE LOUVER

- 1) Pull louver forward slowly.
* Be careful not to damage sealing
sponge stripes



10. FRONT CONTROL PANEL

- 1) Place any sheet right of panel to protect surface of it.
- 2) Insert small screw driver into the gap to lift panel windows up.
- 3) Insert another driver into the gap and move it left loosen 2 hooks.
- 4) Pull window out smoothly.
loosen 2 hooks.



DISASSEMBLY AND ASSEMBLY

5) Remove 2 screws.



6) Lift up panel to remove.



7) Remove connector.



8) Remove screws on the back of panel.



11. COMPRESSOR

- 1) Remove Machine-room Cover screws.
- 2) Pull the cover up to remove.



- 3) Remove P-Relay Band by pressing it up toward the compressor.
- 4) Remove Relay Assembly from Compressor.
- 5) Cut out Service Pipe and tiny pipe of Dryer.
- 6) Remove Compressor Pipes using soldering torch.
- 7) Remove 4 Compressor Washers.



12.WIRE CONDENSER & C-FAN

- 1) Remove the 2 Case screws using cross type screw driver.



DISASSEMBLY AND ASSEMBLY

- 2) Remove Wire-condenser pipes using soldering torch.
- 3) Cut out of Dryer fixing cable.

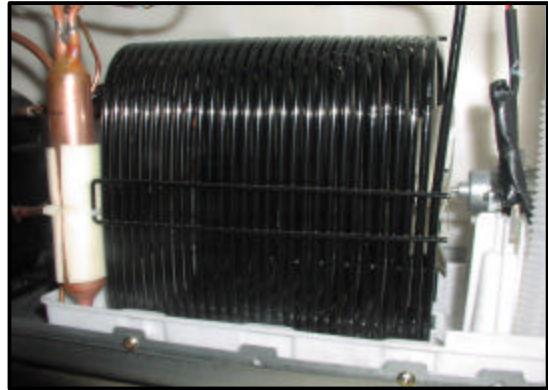

- 4) Turn the Drain Hose by 90degrees to remove.
- 5) Press the Housing Locker down to remove it.
- 6) Pull out Wire-condenser.
* Be careful not to damage pipes when pulling out the Condenser.

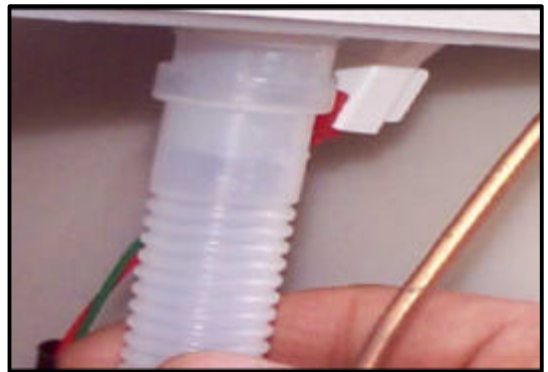

- 7) Press the Motor Band down to remove it.
- 8) Lift the Motor up to remove.



6. EXPLODED VIEW AND PARTS LIST

6-1. FR-530NT/FR-590NT TOTAL EXPLODED VIEW

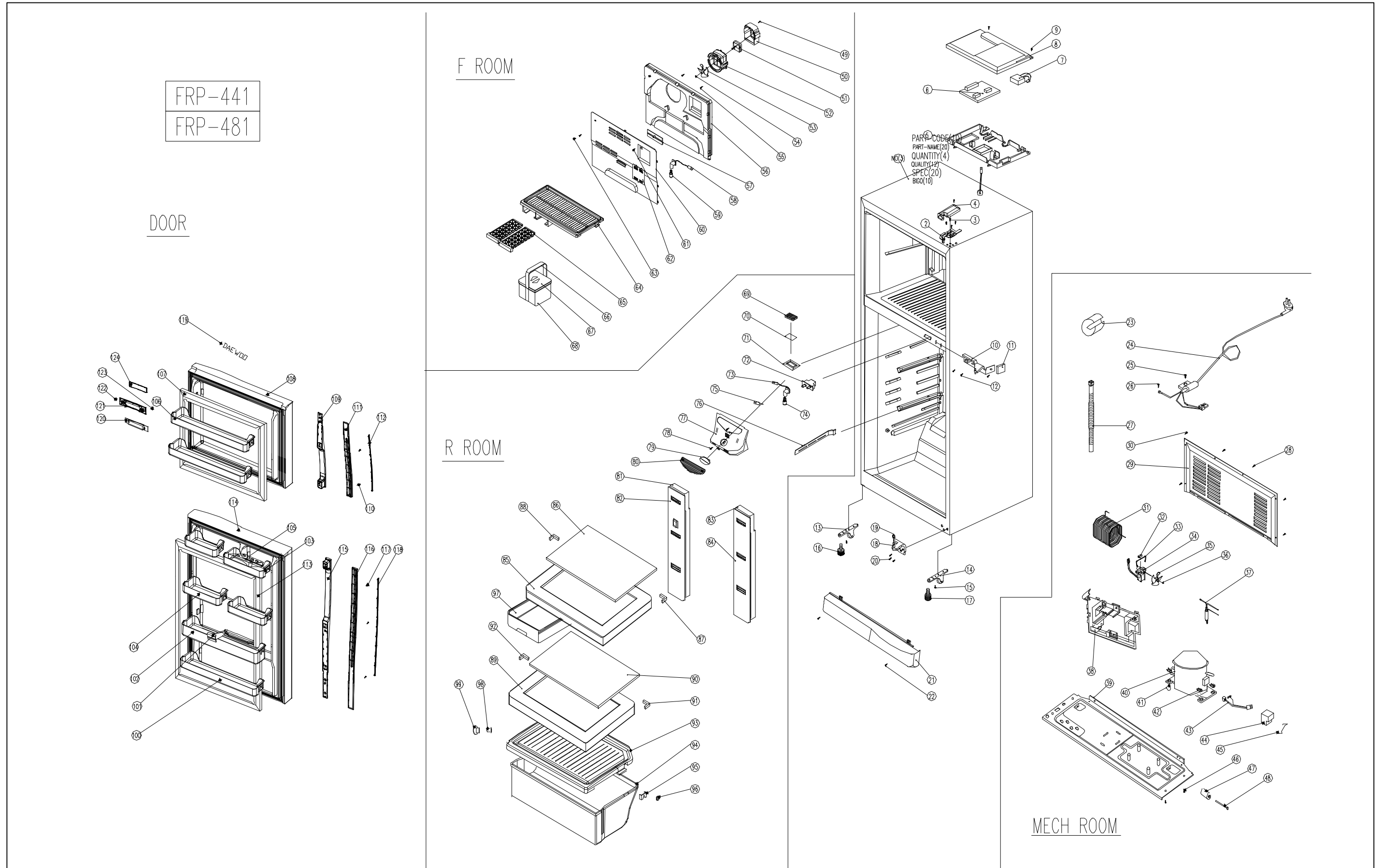

EXPLODED VIEW AND PARTS LIST

1) FR-530NT/FR-590NT

NO	PART CODE	PART NAME	PART DESCRIPTION	QUANTITY	REMARK
1	3000015000	ASSY CAB URT	FRP-441	1	
	3000015100	ASSY CAB URT	FRP-481	1	
2	3012905400	HINGE *T	"SCP1, T2.3"	1	
3	3016001240	SPECIAL BOLT *T	6X 22 SWCH22A(YL)	5	
4	3011429000	COVER *T HI	PP	1	
5	3010519200	BOX M/PCB	PP	1	
6	3014392000	PCB MAIN AS		1	
7	3016401910	CAPACITOR RUNNING	400VAC 4UF(WIRE)	1	
8	3011444901	COVER MAIN PCB BOX	PP	1	
9	7112401611	SCREW TAPPING	T1 TRS 4X16 MFZN	2	
10	3012905802	HINGE *M AS	PO T3.2	1	
11	3011424700	COVER *M HINGE	ABS	1	
12	3016001220	SPECIAL BOLT *M	6X20 SWCH22A(WH)	3	
13	3012102901	FOOT *F *L AS		1	
14	3012103001	FOOT *F *R AS		1	
15	3016000700	SPECIAL SCREW	M6X15	2	
16	3012101501	FOOT ADJ *R AS		1	
17	3012102501	FOOT ADJ *L AS		1	
18	3012906400	HINGE *U AS		1	
19	3016005300	SPECIAL WASHER	S10C T1.5	1	
20	3016001240	SPECIAL BOLT T/U	6X22SWCH22A(YL)	3	
21	3011470100	COVER CABINET BRAKET	PP	1	
22	7112401611	SCREW TAPPING	T1 TRS 4X16 MFZN	2	
23	3010101340	ABSORBER SUCTION PIPE	NR	3	
24	3011302030	CORD POWER AS	CP-2PIN(2)	1	
25	7112401211	SCREW TAPPING	T1 TRS 4X12 MFZN	1	
26	7001400865	SCREW MACHINE	PAN 4X8 BSNI	1	
27	3013202700	HOSE DRAIN B	PP	1	
28	7112401211	SCREW TAPPING	T1 TRS 4X12 MFZN	6	
29	3012401410	GRILLE	SBHGI T0.4	1	
30	7112401211	SCREW TAPPING	T1 TRS 4X12 MFZN	2	
31	3014423900	PIPE WICON AS	FRB-48/52/5640NT	1	
32	3010102100	ABSORBER C MOTOR	NR	1	
33	3012004400	FIXTURE C MOTOR	SUC	1	
34	3015905021	MOTOR C	230V / 50Hz	1	
35	3011802200	FAN		1	

EXPLODED VIEW AND PARTS LIST

NO	PART CODE	PART NAME	PART DESCRIPTION	QUANTITY	REMARK
36	3011200500	CLAMP FAN	SUS304	1	
37	3016801010	DRYER AS	FRB-4460NT/4760NT	1	
38	3011118000	CASE VAPORI		1	
39	3010314910	BASE COMPRESSOR	SBHGI T1.0	1	
40	3956126S50	COMPRESSOR	HPL26YH-5 240V-50HZ	1	
41	3010101440	ABSORBER COMP AS		4	
42	3016002500	SPECIAL WAHER	SK-5 T0.8	4	
43	3018119920	SWITCH P-RELAY AS	"4TM197NHBY-52(3P,S330)"	1	
44	3811400503	COVER RELAY	V235	1	
45	3012610000	CLAMP BAND RELAY	SK-5 T0.7	1	
46	3016003300	SPECIAL BOLT	T2 M6.5X20	4	
47	3016500000	CASTER *B	PP	2	
48	3014902900	SHAFT CASTER *B	SWRM-10	2	
49	7112401211	SCREW TAPPING	T1 TRS 4X12 MFZN	1	
50	3012007901	FIXTURE MOTOR B	PP	1	
51	3015907200	MOTOR F	BLDL 12V	1	
52	3012007800	FIXTURE MOTOR A	PP	1	
53	3011802200	FAN	ABS(OD110)	1	
54	3011200500	CLAMP FAN	SUS 304	1	
55	7112401611	SCREW TAPPING	T1 TRS 4X12 MFZN	2	
56	3013334112	INSULATOR F-LUVR	F-PS	1	
57	3013402110	KNOB F CONTROL	PP	1	
58	3017903422	SOCKET F LAMP AS		1	
59	3013600020	LAMP AS	240 [V] / 15[W]	1	
60	3018908210	LOUVER F	HIPS	1	
61	7112401611	SCREW TAPPING	T1 TRS 4X16 MFZN	2	
62	3015504201	WINDOW F	GPPS	1	
63	3010924600	CAP F-LOUVER	HIPS T2.3	1	
64	3017807500	SHELF F	HIPS	1	
65	3011110200	CASE ICING	PP	2	
66	3012603401	HANDLE ICE BOX	ABS	1	
67	3011445501	COVER ICE-BOX	GPPS	1	
68	3010519600	BOX ICE	HIPS	1	
69	3018701300	DEODORANT ANTI RETURN		1	
70	3018700700	DEODORANT SHEET	UNITRON	1	
71	3011102501	CASE DEODORANT A	PP	1	
72	3018100010	SWITCH DOOR	2 BUTTON / 4 PIN	1	

EXPLODED VIEW AND PARTS LIST

NO	PART CODE	PART NAME	PART DESCRIPTION	QUANTITY	REMARK
73	3017903300	SOCKET R LAMP AS		1	
74	3013600020	LAMP AS	240V 15W	1	
75	3014802300	SENSOR R AS		1	
76	3011439500	COVER CUBIC/D	HIPS	4	
77	3011445000	COVER CONTROL	HIPS	1	
78	7112401611	SCREW TAPPING	T1 TRS 4X16 MFZN	1	
79	3010918400	CAP CONTROL BOX	ABS	1	
80	3015504001	WINDOW R	GPPS	1	
81	3013331100	INSULATOR R *S *L	"F-PS, FRP-441"	1	
	3013330900	INSULATOR R *S *L	"F-PS, FRP-481"	1	
82	3018906300	LOUVER R *S *L	"PP, FRP-441"	1	
	3018902500	LOUVER R *S *L	"PP, FRP-481"	1	
83	3013331100	INSULATOR R *S *R	"F-PS, FRP-441"	1	
	3013331000	INSULATOR R *S *R	"F-PS, FRP-481"	1	
84	3018906400	LOUVER R *S *R	"PP, FRP-441"	1	
	3018902600	LOUVER R *S *R	"PP, FRP-481"	1	
85	3017802340	SHELF R *T	HIPS	1	
86	3014547710	PALTE SHELF GLASS	GALSS(T0.4X595.3X369.4)	1	
87	3012017000	FIXTURE GLASS SHELF R	HIPS	1	
88	3012016000	FIXTURE GLASS SHELF L	HIPS	1	
89	3017805101	SLELF R *U	GPPS	1	
90	3014547710	PALTE SHELF GLASS	GALSS(T0.4X595.3X369.4)	1	
91	3012017000	FIXTURE GLASS SHELF R	HIPS	1	
92	3012016000	FIXTURE GLASS SHELF L	HIPS	1	
93	3011439701	COVER VEGETABLE CASE	GPPS	1	
94	3011117700	CASE VEGETABLE	GPPS	1	
95	3011432800	COVER ROLL A	HIPS	2	
96	3014700500	ROLLER VEGETABLE CASE	POM	2	
97	3011117811	CASE CHILLED	GPPS	1	
98	3014700600	ROLLER V/CASE FIXTURE	POM	2	
99	3015303600	SUPPORTER V/CASE BOX	GPPS	2	
100	3019018810	POCKET R DOOR *U	GPPS	1	
101	3012513000	GUIDE JUMBO POCKET	GPPS	1	
102	3019018710	POCKET JUMBO	GPPS	1	
103	3019018510	POCKET EGG	GPPS	2	
104	3019018610	POCKET MULTI	GPPS	2	
105	3011107411	CASE EGG	GPPS	1	

EXPLODED VIEW AND PARTS LIST

NO	PART CODE	PART NAME	PART DESCRIPTION	QUANTITY	REMARK
106	3019018410	POCKET F DOOR	GPPS	2	
107	3012301400	GASKET F DOOR AS	PVC	1	
108	3011751510	DOOR F URT AS	FRP-441	1	
	3011795510	DOOR F URT AS	FRP-481	1	
109	3012628300	HANDLE F DOOR	FR-B442BB	1	
110	7002501611	SCREW MACHINE	TRS 5X16 MFZN	2	
111	3011613400	DECORATOR F HANDLE A	FR-B442BB	1	
112	3011613500	DECORATOR F HANDLE B	ABS+CR	1	
113	3012301700	GASKET R DOOR AS	PVC	1	
114	3011751920	DOOR R URT AS	FRP-441	1	
	3011752110	DOOR R URT AS	FRP-481	1	
115	3012628400	HANDLE R DOOR	FR-B442BB	1	
116	7002501611	SCREW MACHINE	TRS 5X16 MFZN	3	
117	3011613600	DECORATOR R HANDLE A	ABS	1	
118	3011613700	DECORATOR R HANDLE B	ABS + CR	1	
119		EMBLEM DAEWOO		1	
120	3014393000	PCB FRONT AS		1	
121	3014232100	PANEL FCP	ABS	1	
122	3016302900	BUTTON FCP *L	ABS	1	
123	3016303000	BUTTON FCP *R	ABS	1	
124	3015504600	WINDOW FCP	ABS + INSERT	1	

6-2. FR-590NW TOTAL EXPLODED VIEW

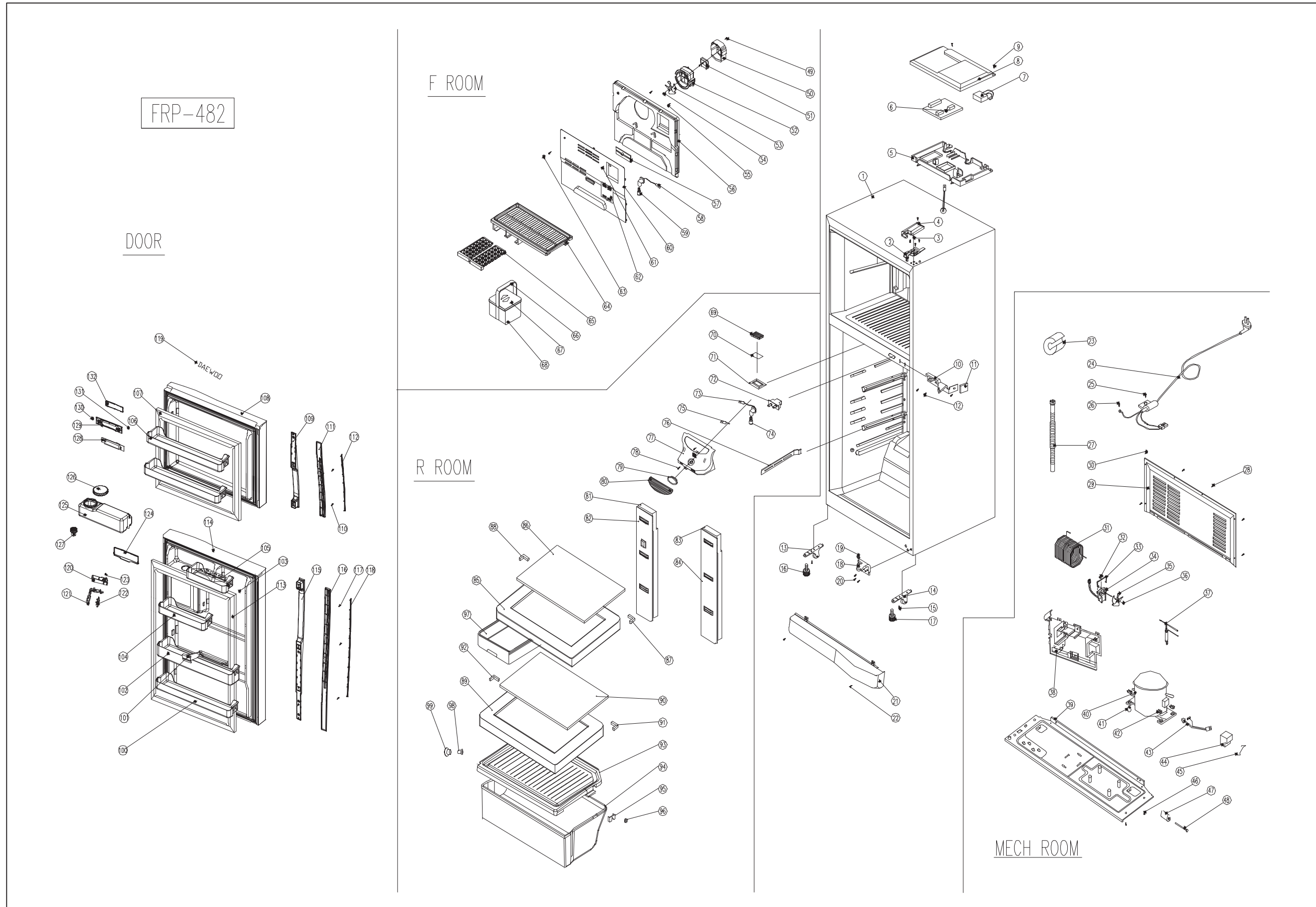

EXPLODED VIEW AND PARTS LIST

2) FR-590NW

NO	PART CODE	PART NAME	PART DESCRIPTION	QUANTITY	REMARK
1	3000015100	ASSY CAB URT	FRP-481	1	
2	3012905400	HINGE *T	"SCP1, T2.3"	1	
3	3016001240	SPECIAL BOLT *T	6 X 22 SWCH22A(YL)	5	
4	3011429000	COVER *T HI	PP	1	
5	3010519200	BOX MAIN PCB	PP	1	
6	3014392000	PCB MAIN AS		1	
7	3016401910	CAPACITOR RUNNING	400VAC 4UF(WIRE)	1	
8	3011444901	COVER MAIN PCB BOX	PP	1	
9	7112401611	SCREW TAPPING	T1 TRS 4X16 MFZN	2	
10	3012905802	HINGE *M AS	PO T3.2	1	
11	3011424700	COVER *M HINGE	ABS	1	
12	3016001220	SPECIAL BOLT *M	6X20 SWCH22A(WH)	3	
13	3012102901	FOOT *F *L AS		1	
14	3012103001	FOOT *F *R AS		1	
15	3016000700	SPECIAL SCREW	M6X15	2	
16	3012101501	FOOT ADJ *R AS		1	
17	3012102501	FOOT ADJ *L AS		1	
18	3012906400	HINGE *U AS		1	
19	3016005300	SPECIAL WASHER	S10C T1.5	1	
20	3016001240	SPECIAL BOLT T/U	6X22SWCH22A(YL)	3	
21	3011470100	COVER CABINET BRAKET	PP	1	
22	7112401611	SCREW TAPPING	T1 TRS 4X16 MFZN	2	
23	3010101340	ABSORBER SUCTION PIPE	NR	3	
24	3010101340	CORD POWER AS	CP-2PIN(2)	1	
25	7112401211	SCREW TAPPING	T1 TRS 4X12 MFZN	1	
26	7001400865	SCREW MACHINE	PAN 4X8 BSNI	1	
27	3013202700	HOSE DRAIN B	PP	1	
28	7112401211	SCREW TAPPING	T1 TRS 4X12 MFZN	6	
29	3012401410	GRILLE	SBHGI T0.4	1	
30	7112401211	SCREW TAPPING	T1 TRS 4X12 MFZN	2	
31	3014423900	PIPE WICON AS	FLTT SW D4.76	1	
32	3010102100	ABSORBER C MOTOR	NR	1	
33	3012004400	FIXTURE C MOTOR	SUC	1	
34	3015905021	MOTOR C	230V/50HZ(RT 3.17)	1	
35	3011802200	FAN		1	
36	3011200500	CLAMP FAN	SUS304	1	

EXPLODED VIEW AND PARTS LIST

NO	PART CODE	PART NAME	PART DESCRIPTION	QUANTITY	REMARK
37	3016801010	DRYER AS	FRB-4460NT/4760NT	1	
38	3011118000	CASE VAPORI		1	
39	3010314910	BASE COMPRESSOR	SBHGI T1.0	1	
40	3956126S50	COMPRESSOR	HPL26YH-5 240V-50HZ	1	
41	3010101440	ABSORBER COMP AS		4	
42	3016002500	SPECIAL WAHER	SK-5 T0.8	4	
43	3018116610	SWITCH P-RELAY AS	"4TM197NHBYY-52(3P,S330)"	1	
44	3811400503	COVER RELAY	V235		
45	3012610000	CLAMP BAND RELAY	SK-5 T0.7	1	
46	3016003300	SPECIAL BOLT	T2 M6.5X20	4	
47	3016500000	CASTER *B	PP	2	
48	3014902900	SHAFT CASTER *B	SWRM-10	2	
49	7112401211	SCREW TAPPING	T1 TRS 4X12 MFZN	1	
50	3012007901	FIXTURE MOTOR B	PP	1	
51	3015907200	MOTOR F	BLDL 12V	1	
52	3012007800	FIXTURE MOTOR A	PP	1	
53	3011802200	FAN	ABS(OD110)	1	
54	3011200500	CLAMP FAN	SUS 304	1	
55	7112401611	SCREW TAPPING	T1 TRS 4X12 MFZN	2	
56	3013334110	INSULATOR F-LUVR	F-PS	1	
57	3013402110	KNOB CONTROL	PP	1	
58	3017903422	SOCKET F LAMP AS		1	
59	3013600020	LAMP AS	240 [V] / 15[W]	1	
60	3018908210	LOUVER F	HIPS	1	
61	7112401611	SCREW TAPPING	T1 TRS 4X16 MFZN	2	
62	3015504201	WINDOW F	GPPS	1	
63	3010924600	CAP F-LOUVER	HIPS T2.3	1	
64	3017807500	SHELF F	HIPS	1	
65	3011110200	CASE ICING	PP	2	
66	3012603401	HANDLE ICE BOX	ABS	1	
67	3011445501	COVER ICE-BOX	GPPS	1	
68	3010519600	BOX ICE	HIPS	1	
69	3018701300	DEODORANT ANTI RETURN		1	
70	3018700700	DEODORANT SHEET	UNITRON	1	
71	3011102501	CASE DEODORANT A	PP	1	
72	3018100010	SWITCH DOOR	2 BUTTON / 4 PIN	1	
73	3017903300	SOCKET R LAMP AS		1	

EXPLODED VIEW AND PARTS LIST

NO	PART CODE	PART NAME	PART DESCRIPTION	QUANTITY	REMARK
74	3013600020	LAMP AS	240V 15W	1	
75	30143802300	SENSOR R AS	FRP-481	1	
76	3011439500	COVER CUBIC/D	HIPS	4	
77	3011445000	COVER CONTROL	HIPS	1	
78	7112401611	SCREW TAPPING	T1 TRS 4X16 MFZN	1	
79	3010918400	CAP CONTROL BOX	ABS	1	
80	3015504001	WINDOW R	GPPS	1	
81	3013330900	INSULATOR R *S *L	"F-PS, FRP-481"	1	
82	3018902500	LOUVER R *S *L	"PP, FRP-481"	1	
83	3013331000	INSULATOR R *S *R	"F-PS, FRP-481"	1	
84	3018902600	LOUVER R *S *R	"PP, FRP-481"	1	
85	3017802340	SHELF R *T	HIPS	1	
86	3014547710	PALTE SHELF GLASS	GALSS(T0.4X595.3X369.4)	1	
87	3012017000	FIXTURE GLASS SHELF R	HIPS	1	
88	3012016000	FIXTURE GLASS SHELF L	HIPS	1	
89	3017805101	SLELF R *U	GPPS	1	
90	3014547710	PALTE SHELF GLASS	GALSS(T0.4X595.3X369.4)	1	
91	3012017000	FIXTURE GLASS SHELF R	HIPS	1	
92	3012016000	FIXTURE GLASS SHELF L	HIPS	1	
93	3011439701	COVER VEGETABLE CASE	GPPS	1	
94	3011117700	CASE VEGETABLE	GPPS	1	
95	3011432800	COVER ROLL A	HIPS	2	
96	3014700500	ROLLER VEGETABLE CASE	POM	2	
97	3011117811	CASE CHILLED	GPPS	1	
98	3014700600	ROLLER V/CASE FIXTURE	POM	2	
99	3015303600	SUPPORTER V/CASE BOX	GPPS	2	
100	3019018810	POCKET R DOOR *U	GPPS	1	
101	3012513000	GUIDE JUMBO POCKET	GPPS	1	
102	3019018710	POCKET JUMBO	GPPS	1	
103	3019018510	POCKET EGG	GPPS	1	
104	3019018610	POCKET MULTI	GPPS	1	
105	3011107411	CASE EGG	GPPS	1	
106	3019018410	POCKET F DOOR	GPPS	2	
107	3012301400	GASKET F DOOR AS	PVC	1	
108	3011795000	DOOR F URT AS	FRP-482	1	
109	3012628300	HANDLE F DOOR	FR-B442BB	1	
110	7002501611	SCREW MACHINE	TRS 5X16 MFZN	2	

EXPLODED VIEW AND PARTS LIST

NO	PART CODE	PART NAME	PART DESCRIPTION	QUANTITY	REMARK
111	3011613400	DECORATOR F HANDLE A	FR-B442BB	1	
112	3011613500	DECORATOR F HANDLE B	ABS+CR	1	
113	3012301700	GASKET R DOOR AS	PVC	1	
114	3011792900	DOOR R URT AS	FRP-441	1	
115	3012628400	HANDLE R DOOR	FR-B442BB	1	
116	7002501611	SCREW MACHINE	TRS 5X16 MFZN	3	
117	3011613600	DECORATOR R HANDLE A	ABS	1	
118	3011613700	DECORATOR R HANDLE B	ABS + CR	1	
119		EMBLEM DAEWOO		1	
120	3012014500	FIXTURE LEVER	ABS	1	
121	3013701000	LEVER WATER DISPENSER	ABS + CR		
122	3011475400	COVER LEVER	SILICON RUBBER	1	
123	3015100700	SPRING LEVER	FRB-4840NW	1	
124	3014232000	PANEL WATER DISPENSER	ABS	1	
125	3018200500	TANK WATER		1	
126	3010914101	CAP TANK A	FRP-4840NW	1	
127	3010822800	CAP OUTLET AS	FRP-4840NW	1	
128	3014393000	PCB FRONT AS		1	
129	3014232100	PANEL FCP	ABS	1	
130	3016302900	BUTTON FCP *L	ABS	1	
131	3016303000	BUTTON FCP *R	ABS	1	
132	3015504600	WINDOW FCP	ABS + INSERT	1	

5. DISASSEMBLY AND ASSEMBLY

6-3 MACHINE ROOM EXPLODED VIEW AND PARTS LIST

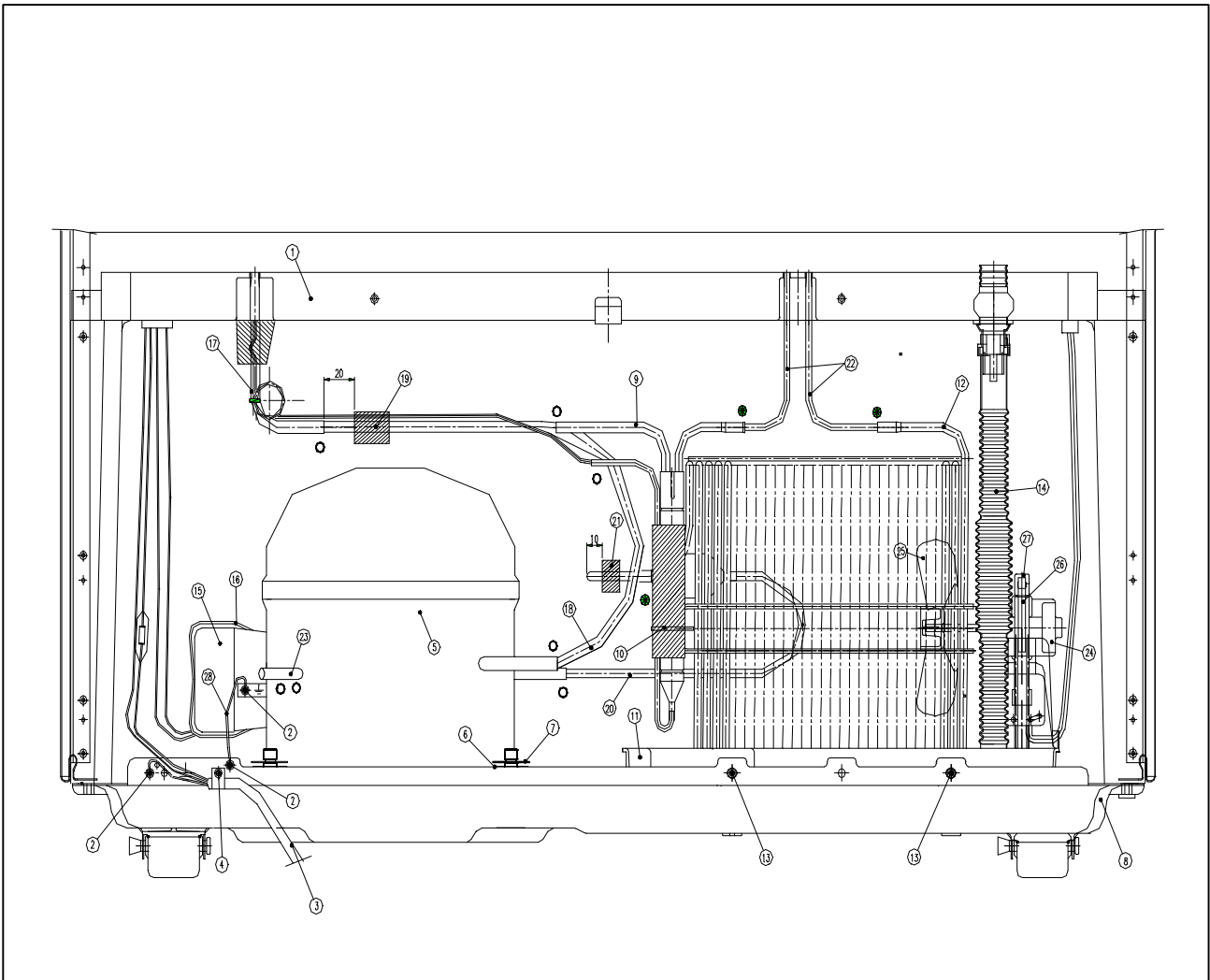

NO	PART NAME	NO	PART NAME	NO	PART NAME
1	BASE CAB AS	8-3	SHAFT CASTER *B	17	PIPE SUC AS
2	SCREW MACHINE	8-4	CASTER *B	18	PIPE SUC CONN
3	CORD POWER AS	9	DRYER AS	19	ABSORBER PIPE
4	SCREW TAPPING	10	CABLE TIE	20	PIPE MUFFLER AS
5	COMPRESSOR	11	VASE VAPORI AS	21	ABSORBER PIPE A
6	ABSORBER COMP AS	11-1	CASE VAPORI	22	PIPE HOT
6-1	ABSORBER COMP RUB B	11-2	SEAL CASE VAPORI	23	PIPE SERVICE
6-2	ABSORBER COMP RUB A	12	PIPE WICON AS	24	MOTOR C
6-3	ABSORBER COMP SPRING	13	SCREW TAPPING	25	FAN C AS
7	WASHER SPECIAL	14	HOSE DRAIN B AS	26	FIXTURE C MOTOR
8	BASE COMP AS	14-1	HOSE DRAIN B	27	ABSORBER C MOTOR
.8-1	BASE COMP	15	COVER C FAN	28	HARNES EARTH
8-2	SPECIAL BOLT	16	BAND RELAY		