

Model No. : DMC-TZ80/TZ81/ZS60 Frame and Casing Section

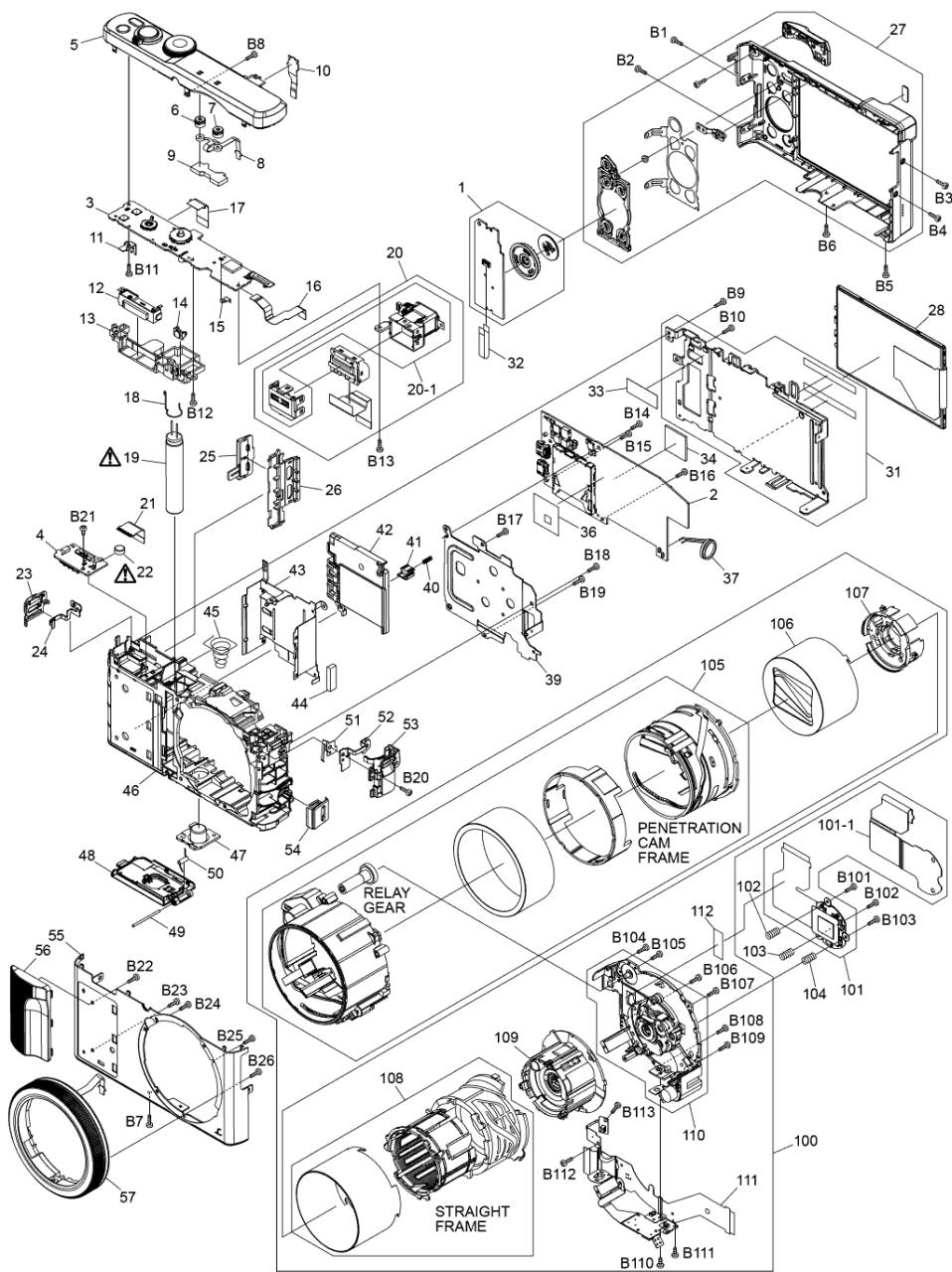

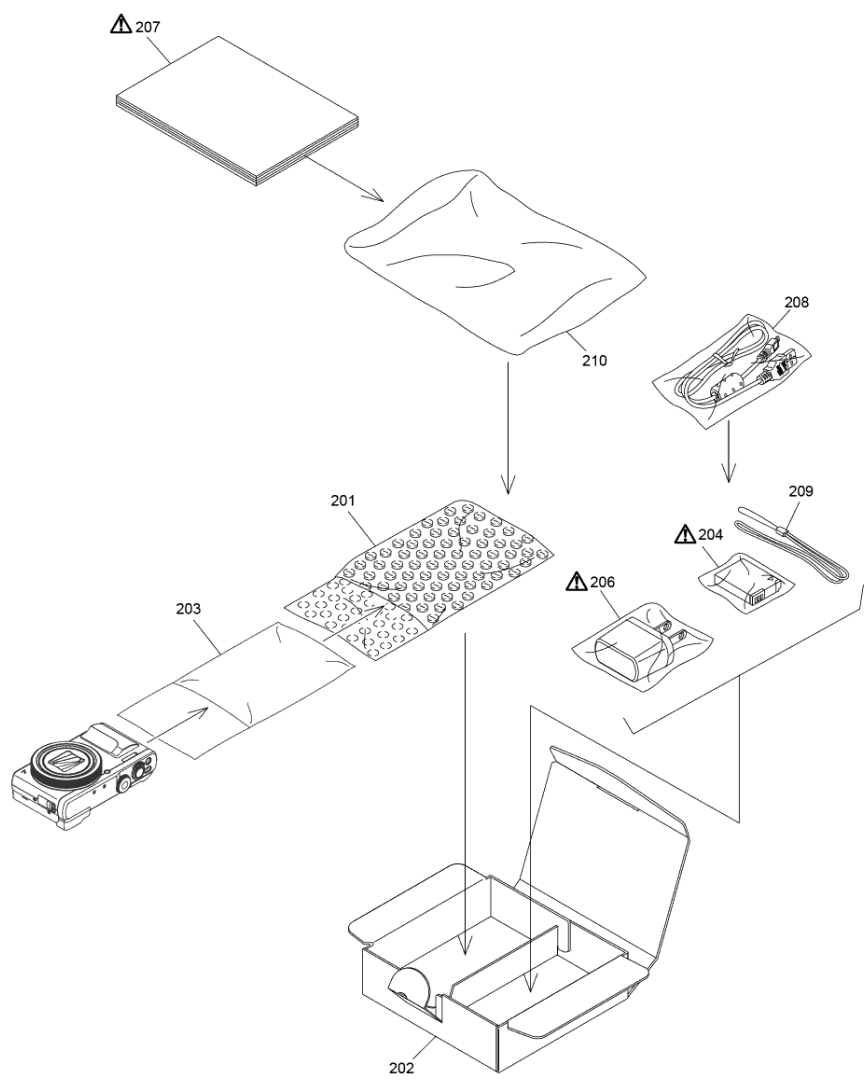

Model No. : DMC-TZ80/TZ81/ZS60 Packing Parts and Accessories Section





























Model No. : DMC-TZ80/TZ81/ZS60 Parts List

Change	Safety	Ref. No.	Part No.	Part Name & Description	Q'ty	Remarks
		1	SYQ0678	REAR OPERATION P.C.B. UNIT	1	
		2	SEP0684AD	MAIN P.C.B.	1	(RTL) E.S.D. (TZ80/81)EG,EP,EF,EB
		2	SEP0684AC	MAIN P.C.B.	1	(RTL) E.S.D. EE,GC,GA,GN,P,PP,GH
		3	SEQ0144	TOP P.C.B. UNIT	1	E.S.D.
		4	SEP0689AA	BATTERY P.C.B.	1	(RTL) E.S.D.
		5	SYK1401	TOP CASE UNIT	1	(-K)
		5	SYK1390	TOP CASE UNIT	1	(-S)
		6	VMT2027	MIC DAMPER	1	
		7	VMT2027	MIC DAMPER	1	
		8	SEP0752AA	MIC UNIT	1	
		9	SGQ0368	MIC SPACER	1	
		10	SEP0718AA	EYE SENSOR FPC	1	E.S.D.
		11	VMP0H67	TOP EARTH PLATE A	1	
		12	EFN-AMFH9ZD	FLASH UNIT	1	
		13	SGQ0683	FLASH SPACER	1	
		14	VGL1365	AF PANEL LIGHT	1	
		15	SMP0289	TOP EARTH PLATE B	1	
		16	STJ0176	WIFI FPC	1	
		17	STJ0173	TOP FPC	1	
		18	SMB0189	EARTH SPRING	1	
	⚠	19	F2A2F8200003	E.CAPACITOR	1	(C8003)
		20	SYK1389	LVF UNIT	1	
		20-1	SYQ0551	LVF COVER UNIT	1	
		21	STJ0174	BATTERY FPC	1	
	⚠	22	ML-421S/DN	BUTTON BATTERY	1	(B9401)
		23	SGK0276K	STRAP COVER (L)	1	
		24	SMP0237	STRAP PLATE (L)	1	
		25	SKF0111K	JACK COVER	1	
		26	SYK1386	JACK DOOR BASE UNIT	1	
		27	SYK1271	REAR CASE UNIT	1	
		28	L5BDDY00177	LCD UNIT	1	
		31	SYQ0809	FRAME PLATE UNIT	1	
		32	STJ0175	REAR OPERATION FPC	1	
		33	SGQ0711	FRAME PLATE SHEET	1	
		34	SJD0034	HEAT RADIATION PAD	1	
		36	SGS0084	CU PROTECT SHEET	1	
		37	L0AA01A00182	SPEAKER	1	
		39	SMP0240	LENS FIX PLATE	1	
		40	VMB4304	BATTERY LOCK SPRING	1	
		41	SGQ0697	BATTERY LOCK KNOB	1	
		42	SGQ0682	PCB SPACER	1	
		43	SMP0236	BATTERY CASE	1	
		44	SJQ0026	GASKET	1	
		45	VMB4851	BATTERY OUT SPRING	1	
		46	SMK0050	FRAME	1	
		47	VGQ1823	TRIPOD	1	
		48	SYK1273	BATTERY DOOR UNIT	1	
		49	VMS8342	BATTERY DOOR SHAFT	1	
		50	VMB4767	BATTERY DOOR SPRING	1	
		51	SMP0290	FRONT EARTH PLATE	1	
		52	SMP0238	STRAP PLATE (R)	1	
		53	SGK0281K	STRAP COVER (R)	1	
		54	SYK1383	SPEAKER FIX PLATE UNIT	1	
		55	SKK0354K	FRONT CASE	1	
		56	SGQ0680	FRONT GRIP	1	
		57	SYQ0608	CONTROL RING UNIT	1	
		B1	VHD2240	SCREW	1	
		B2	VHD2240	SCREW	1	
		B3	VHD2240	SCREW	1	
		B4	VHD2240	SCREW	1	
		B5	VHD2240	SCREW	1	
		B6	VHD2240	SCREW	1	

Model No. : DMC-TZ80/TZ81/ZS60; Parts List

Change	Safety	Ref. No.	Part No.	Part Name & Description	Q'ty	Remarks
		B7	VHD2240	SCREW	1	
		B8	VHD2371	SCREW	1	
		B9	VHD2239	SCREW	1	
		B10	VHD2239	SCREW	1	
		B11	VHD2369	SCREW	1	
		B12	VHD2369	SCREW	1	
		B13	VHD2369	SCREW	1	
		B14	VHD2369	SCREW	1	
		B15	VHD2369	SCREW	1	
		B16	VHD2369	SCREW	1	
		B17	VHD2369	SCREW	1	
		B18	VHD2369	SCREW	1	
		B19	VHD2369	SCREW	1	
		B20	VHD2369	SCREW	1	
		B21	VHD2432	SCREW	1	
		B22	VHD2457	SCREW	1	
		B23	VHD2457	SCREW	1	
		B24	VHD2457	SCREW	1	
		B25	VHD2457	SCREW	1	
		B26	VHD2457	SCREW	1	
		100	SXW0317	LENS UNIT (W/O MOS)	1	
		101	SEQ0133	MOS UNIT	1	
		101-1	SZT0250	HEAT RADIATION SHEET	1	
		102	VMB4601	TILT SPRING	1	
		103	VMB4601	TILT SPRING	1	
		104	VMB4601	TILT SPRING	1	
		105	SXW0065	FIX FRAME UNIT	1	
		106	VXP3972	1ST LENS FRAME UNIT	1	
		107	VXP3977	2ND LENS FRAME UNIT	1	
		108	SXW0063	BOTH SIDE CUM FRAME UNIT	1	
		109	VXP3978	3RD LENS FRAME UNIT	1	
		110	SXQ0667	MASTER FLANGE UNIT	1	
		111	SEQ0132	LENS FPC UNIT	1	
		112	SZT0247	LENS TAPE	1	
		B101	VHD2388	SCREW	1	
		B102	VHD2388	SCREW	1	
		B103	VHD2388	SCREW	1	
		B104	VHD2390	SCREW	1	
		B105	VHD2390	SCREW	1	
		B106	VHD2390	SCREW	1	
		B107	VHD2390	SCREW	1	
		B108	VHD2390	SCREW	1	
		B109	VHD2390	SCREW	1	
		B110	VHD2451	SCREW	1	
		B111	VHD2451	SCREW	1	
		B112	VHD2492	SCREW	1	
		B113	VHD2492	SCREW	1	
		201	SPF0014	BAG, BUBBLE WRAP	1	
		202	SPK0144	PACKING CASE	1	TZ80EG-K, EP-K, EF-K, EB-K, EE-K, GC-K, GA-K, GN-K
		202	SPU0132	PACKING CASE	1	TZ80EG-S, EP-S, EF-S, EB-S, EE-S, GA-S, GN-S
		202	SPU0201	PACKING CASE	1	GC-K
		202	SPK0146	PACKING CASE	1	TZ81EG-K
		202	SPU0134	PACKING CASE	1	TZ81EG-S
		202	SPK0143	PACKING CASE	1	P-K, PP-K
		202	SPU0131	PACKING CASE	1	P-S, PP-S
		202	SPK0145	PACKING CASE	1	GH-K
		202	SPU0133	PACKING CASE	1	GH-S
		203	SPF0065	CAMERA BAG	1	
		204	----	BATTERY PACK	1	
		206	SAE0012DA	AC ADAPTOR	1	(TZ80/81) EG, EP, EF, EE, GA

Model No. : DMC-TZ80/TZ81/ZS60; Parts List

Change	Safety	Ref. No.	Part No.	Part Name & Description	Q'ty	Remarks
		206	SAE0012FA	AC ADAPTOR	1	EB,GH
		206	SAE0012HA	AC ADAPTOR	1	GC
		206	SAE0012GA	AC ADAPTOR	1	GN
		206	SAE0012AA	AC ADAPTOR	1	P,PP
		207	SQT1169	BASIC O/I (GERMAN)	1	(TZ80/81)EG
		207	SQT1170	BASIC O/I (FRENCH)	1	(TZ80/81)EG,EF
		207	SQT1171	BASIC O/I (ITALIAN)	1	TZ80EG
		207	SQT1172	BASIC O/I (DUTCH)	1	TZ80EG,EF
		207	SQT1173	BASIC O/I (SPANISH)	1	TZ80EG
		207	SQT1174	BASIC O/I (PORTUGUESE)	1	TZ80EG
		207	SQT1175	BASIC O/I (FINNISH)	1	EP
		207	SQT1176	BASIC O/I (DANISH)	1	EP
		207	SQT1177	BASIC O/I (SWEDISH)	1	EP
		207	SQT1178	BASIC O/I (POLISH)	1	EP
		207	SQT1179	BASIC O/I (CZECH)	1	EP
		207	SQT1180	BASIC O/I (HUNGARIAN)	1	EP
		207	SQT1181	BASIC O/I (ENGLISH)	1	EB
		207	SQT1182	BASIC O/I (RUSSIAN)	1	EE
		207	SQT1183	BASIC O/I (UKRAINIAN)	1	EE
		207	SQT1224	BASIC O/I (ENGLISH)	1	GC
		207	SQT1225	BASIC O/I (ARABIC)	1	GC
		207	SQT1184	BASIC O/I (ENGLISH)	1	GA,GH
		207	SQT1185	BASIC O/I (CHINESE (TRADITIONAL))	1	GA,GH
		207	SQT1189	BASIC O/I (ENGLISH)	1	GN
		207	SQT1166	BASIC O/I (ENGLISH)	1	P,PP
		207	SQT1167	BASIC O/I (FRENCH)	1	PP
		207	SQT1168	BASIC O/I (SPANISH)	1	P,PP
		208	K1HY04YY0106	USB CABLE	1	
		209	VFC4297-C	HAND STRAP	1	
		210	VPF1553	BAG, POLYETHYLENE	1	