

Model No. : DMC-FZ70/72 Frame and Casing Section

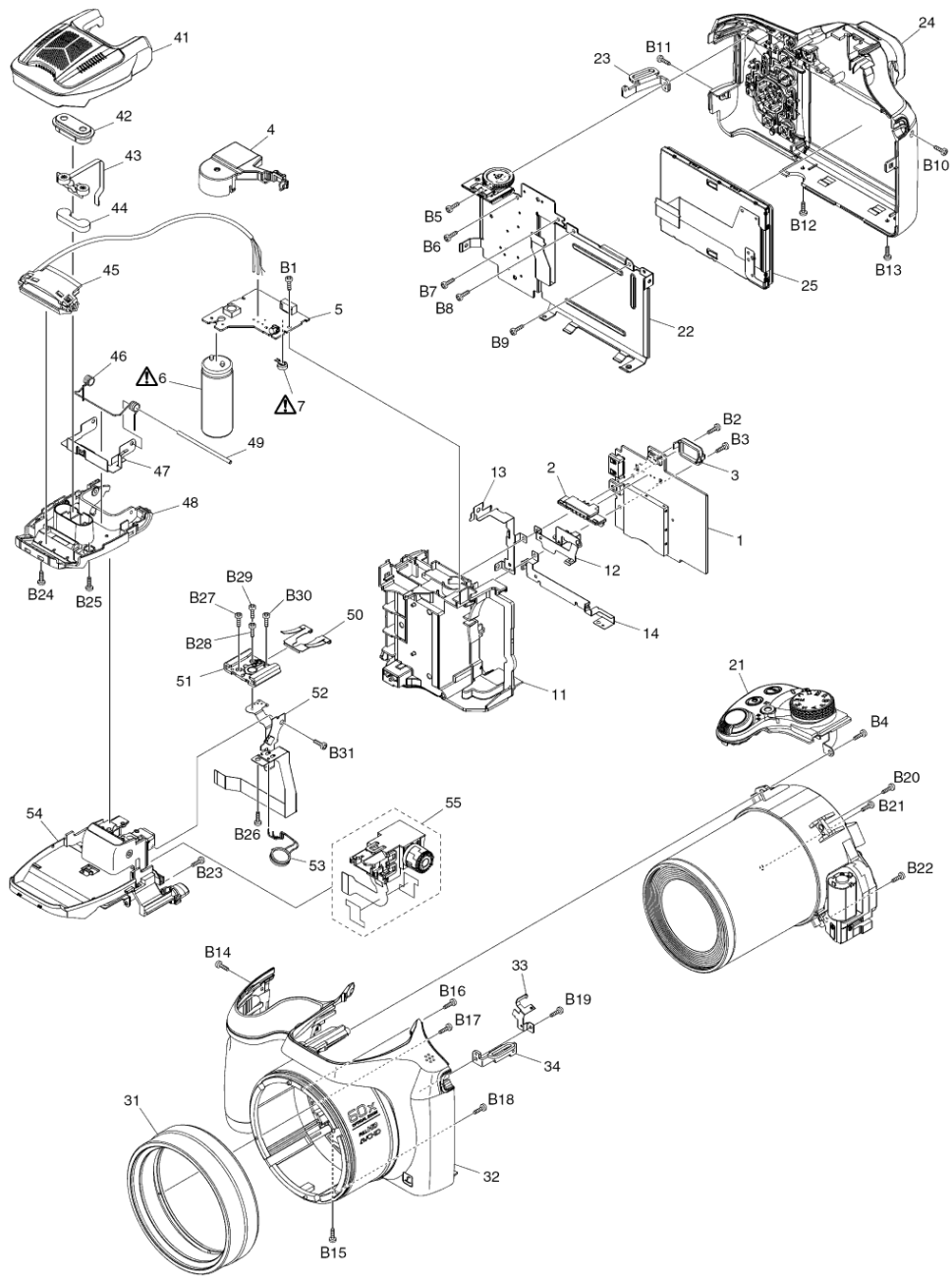

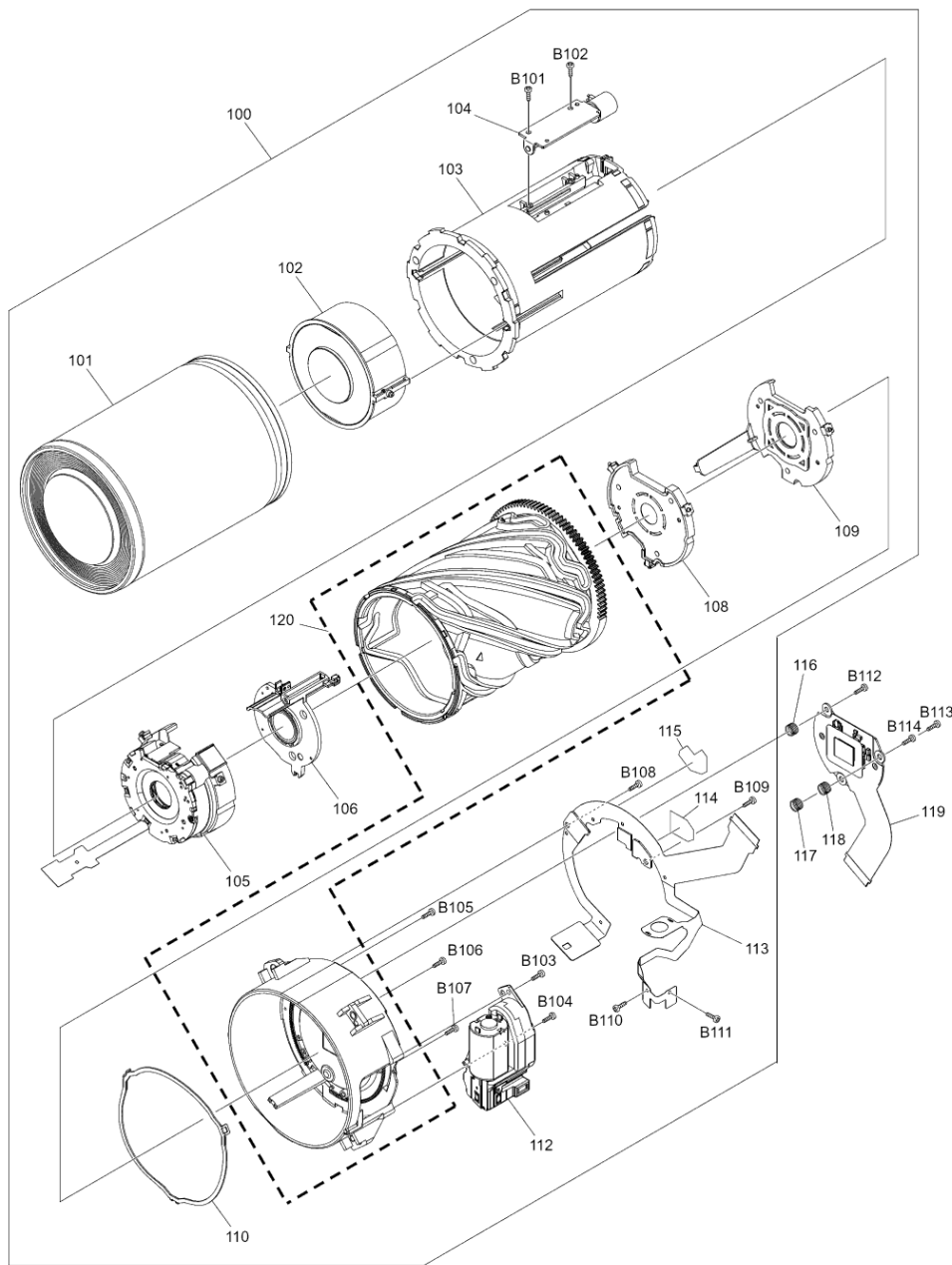

Model No. : DMC-FZ70/72 Camera Lens Section



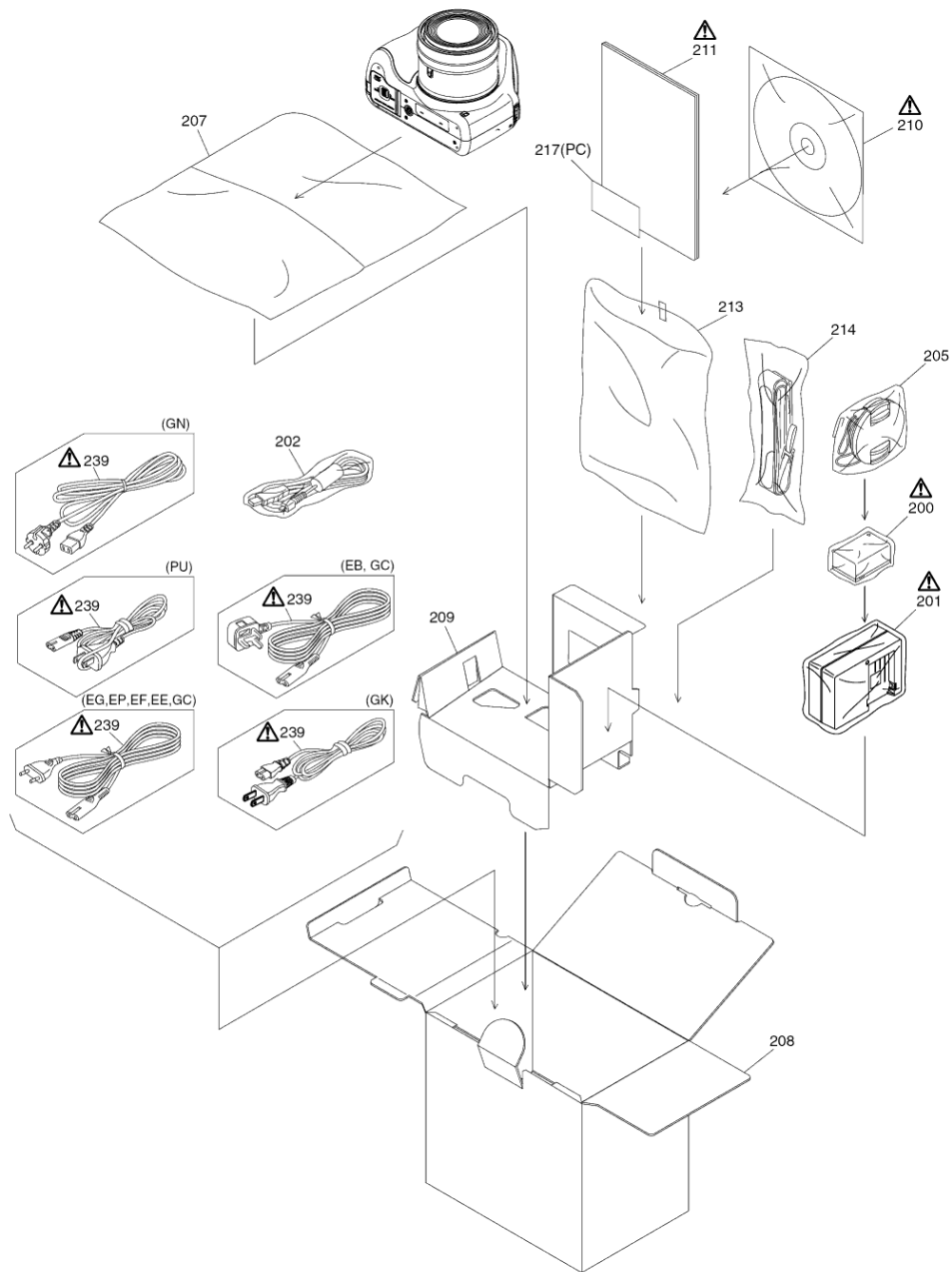













Model No. : DMC-FZ70/72 Packing Parts and Accessories Section





















Model No. : DMC-FZ70/72 Parts List

Change	Safety	Ref. No.	Part No.	Part Name & Description	Q'ty	Remarks
		1	VEP56187A	MAIN P.C.B.	1	(RTL) E.S.D. P, PC, PU, GK, GN, EE
		1	VEP56187B	MAIN P.C.B.	1	(RTL) E.S.D. GC, EG, EP, EF, EB
		2	K1ZZ00001523	BATTERY CONNECTOR	1	(P9001)
		3	VMP0G37	FRAME SPACER A	1	
		4	VGQ1D82	CONDENSOR COVER	1	
		5	VEP58200A	FLASH P.C.B.	1	(RTL) E.S.D.
		6	F9Z000000038	E.CAPACITOR	1	(C8003)
		7	N4ECY25Y0002	BUTTON BATTERY	1	(B8001)
		11	VYK6N15	BATTERY CASE UNIT	1	
		12	VMP0G30	STROBE EARTH PLATE	1	
		13	VMP0G32	JACK EARTH PLATE	1	
		14	VMP0G31	SD EARTH PLATE	1	
		21	VYK6P04	TOP OPERATION UNIT	1	
		22	VYK6P80	LCD HOLDER UNIT	1	
		23	VGQ1N48	STRAP HOLDER L	1	
		24	VYK6P79	REAR CASE UNIT	1	P, PC, PU, GC, GK, GN
		24	VYK6P81	REAR CASE UNIT	1	EG, EP, EF, EB, EE
		25	VYK6P72	LCD UNIT	1	
		31	VDW2676	LENS RING FRONT	1	
		32	VYK6N13	FRONT CASE UNIT	1	
		33	VMP0G29	FRONT EARTH PLATE	1	
		34	VGQ1N56	STRAP HOLDER R	1	
		41	VYK6P43	FLASH CASE TOP UNIT	1	
		42	VGQ1N61	MIC DUMPER	1	
		43	VEP54041A	MIC UNIT	1	
		44	VGQ1R80	MIC SUPPORTER	1	
		45	VYQ8751	FLASH UNIT	1	
		46	VMB4748	FLASH POP UP SPRING	1	
		47	VMP0G33	FLASH EARTH PLATE	1	
		48	VKM0H09	FLASH CASE BOTTOM	1	
		49	VMS7911-A	FLASH SHAFT	1	
		50	VMC2111	SHOE SPRING	1	
		51	VEK0T23	HOT SHOE UNIT	1	
		52	VEP59131A	HOT SHOE FLEX UNIT	1	
		53	L0AA01A00102	SPEAKER	1	
		54	VYK6P44	FLASH BASE UNIT	1	
		55	VYQ8854	EVF UNIT	1	
		B1	VHD1870	SCREW	1	
		B2	VHD1870	SCREW	1	
		B3	VHD1870	SCREW	1	
		B4	XTV2+8JFN	SCREW	1	
		B5	VHD2418	SCREW	1	
		B6	VHD2418	SCREW	1	
		B7	VHD2418	SCREW	1	
		B8	VHD2418	SCREW	1	
		B9	VHD2418	SCREW	1	
		B10	VHD2438	SCREW	1	
		B11	VHD1870	SCREW	1	
		B12	VHD1870	SCREW	1	
		B13	VHD2438	SCREW	1	
		B14	VHD2438	SCREW	1	
		B15	VHD1870	SCREW	1	
		B16	VHD2252-B	SCREW	1	
		B17	VHD2252-B	SCREW	1	
		B18	VHD2252-B	SCREW	1	
		B19	VHD2418	SCREW	1	
		B20	XTV2+8JFN	SCREW	1	
		B21	XTV2+8JFN	SCREW	1	
		B22	XTV2+8JFN	SCREW	1	
		B23	VHD1870	SCREW	1	
		B24	VHD1870	SCREW	1	
		B25	VHD1870	SCREW	1	

Model No. : DMC-FZ70/72 Parts List

Change	Safety	Ref. No.	Part No.	Part Name & Description	Q'ty	Remarks
		B26	VHD2150	SCREW	1	
		B27	VHD2247-A	SCREW	1	
		B28	VHD2247-A	SCREW	1	
		B29	VHD2438	SCREW	1	
		B30	VHD2438	SCREW	1	
		B31	VHD2150	SCREW	1	
		100	VXW1702	LENS UNIT (W/O MOS)	1	[SPC]
		101	VXP3966	1ST LENS FRAME UNIT	1	[SPC]
		102	VXP3946	2ND LENS FRAME UNIT	1	[SPC]
		103	VXQ2472	MIDDLE FRAME UNIT	1	[SPC]
		104	L6HAYYYD0071	FOCUS MOTOR UNIT	1	[SPC]
		105	VXP3947	3RD LENS FRAME UNIT	1	[SPC]
		106	VXP3948	4TH LENS FRAME UNIT	1	[SPC]
		108	VXP3949	5TH LENS FRAME UNIT	1	[SPC]
		109	VXP3950	6TH LENS FRAME UNIT	1	[SPC]
		110	VMC2249	WAVE WASHER	1	[SPC]
		112	L6DAYYYD0009	ZOOM MOTOR UNIT	1	[SPC]
		113	VEK0U53	LENS FLEX UNIT	1	[SPC]
		114	VZT1170	DUST-PROOF TAPE A	1	[SPC]
		115	VZT1190	DUST-PROOF TAPE B	1	[SPC]
		116	VMB4541	TILT SPRING	1	[SPC]
		117	VMB4541	TILT SPRING	1	[SPC]
		118	VMB4541	TILT SPRING	1	[SPC]
		119	VEK0U82	MOS UNIT	1	E.S.D. [SPC]
		120	SDW0020ZKIT	CAM FRAME KIT	1	[SPC]
		B101	VHD1974	SCREW	1	[SPC]
		B102	VHD1974	SCREW	1	[SPC]
		B103	VHD1974	SCREW	1	[SPC]
		B104	VHD1974	SCREW	1	[SPC]
		B105	VHD1974	SCREW	1	[SPC]
		B106	VHD1974	SCREW	1	[SPC]
		B107	VHD1974	SCREW	1	[SPC]
		B108	VHD2011	SCREW	1	[SPC]
		B109	VHD2011	SCREW	1	[SPC]
		B110	VHD2492	SCREW	1	[SPC]
		B111	VHD2492	SCREW	1	[SPC]
		B112	VHD2351	SCREW	1	[SPC]
		B113	VHD2351	SCREW	1	[SPC]
		B114	VHD2351	SCREW	1	[SPC]
		200	-----	BATTERY	1	P, PC
		200	-----	BATTERY	1	PU, GC, GN, EG, EP, EF, EB, EE
		200	-----	BATTERY	1	GK
		201	DE-A83BA/SX	BATTERY CHARGER	1	P, PC
		201	DE-A84AB/SX	BATTERY CHARGER	1	PU, GN, EG, EP, EF, EB, EE
		201	DE-A84BD/SX	BATTERY CHARGER	1	GC, GK
		202	K1HY08YY0031	USB CABLE	1	
		205	VYQ8752	LENS CAP UNIT	1	
		207	VFF1526	CAMERA BAG	1	
		208	VPK5684	PACKING CASE	1	P, PC, PU, GC, GN
		208	VPK5685	PACKING CASE	1	EG, EP, EF, EB, EE
		208	VPK5686	PACKING CASE	1	GK
		209	VPN7653	CUSHION	1	
		210	VFF1231	CD-ROM (SOFT/INSTRUCTION BOOK)	1	P, PC, PU See "Notes"
		210	VFF1235	CD-ROM (SOFT/INSTRUCTION BOOK)	1	GC, GN See "Notes"
		210	VFF1236	CD-ROM (SOFT/INSTRUCTION BOOK)	1	GK See "Notes"
		210	VFF1232	CD-ROM (SOFT/INSTRUCTION BOOK)	1	EG See "Notes"
		210	VFF1233	CD-ROM (SOFT/INSTRUCTION BOOK)	1	EP, EF, EB See "Notes"
		210	VFF1234	CD-ROM (SOFT/INSTRUCTION BOOK)	1	EE See "Notes"
		211	VQT5B59	BASIC O/I (ENGLISH/SPANISH)	1	P
		211	VQT5B60	BASIC O/I (ENGLISH/CANADIAN FRENCH)	1	PC
		211	VQT5B61	BASIC O/I (SPANISH/PORTUGUESE)	1	PU

Model No. : DMC-FZ70/72 Parts List

Change	Safety	Ref. No.	Part No.	Part Name & Description	Q'ty	Remarks
		211	VQT5B71	BASIC O/I (ENGLISH/CHINESE (TRADITIONAL))	1	GC
		211	VQT5B72	BASIC O/I (ARABIC/VIETNAMESE)	1	GC
		211	VQT5B73	BASIC O/I (CHINESE (SIMPLIFIED))	1	GK
		211	VQT5B74	BASIC O/I (ENGLISH)	1	GN
		211	VQT5B62	BASIC O/I (GERMAN/TURKISH)	1	EG
		211	VQT5B63	BASIC O/I (ITALIAN/DUTCH)	1	EG
		211	VQT5B64	BASIC O/I (SPANISH/PORTUGUESE)	1	EG
		211	VQT5B65	BASIC O/I (FRENCH)	1	EG, EF
		211	VQT5B66	BASIC O/I (SWEDISH/DANISH)	1	EP
		211	VQT5B67	BASIC O/I (POLISH/CZECH)	1	EP
		211	VQT5B68	BASIC O/I (HUNGARIAN/FINNISH)	1	EP
		211	VQT5B69	BASIC O/I (ENGLISH)	1	EB
		211	VQT5B70	BASIC O/I (RUSSIAN/UKRAINIAN)	1	EE
		213	VPF1539	BAG, POLYETHYLENE	1	
		214	VFC4453	SHOULDER STRAP	1	
		217	VQL2C67-4A	OPERATING LABEL	1	PC
		239	K2CA2CA00025	AC CORD	1	PU
		239	K2CQ2YY00082	AC CORD	1	GC, EG, EP, EF, EE
		239	K2CT3YY00034	AC CORD	1	GC, EB
		239	K2CA2YY00130	AC CORD	1	GK
		239	K2CJ2YY00052	AC CORD	1	GN