

Service
Service
Service



Service Manual

SERVICING

For servicing CDR79x the set has to be divided into two parts:

- Except for the CD-R/W module all workshops can repair the set on component level.
The Switched Mode Power Supply unit will be exchanged completely in case of a failure.
- The **CD-R/W module** can only be repaired on component level with the help of ComPair.
With this tool diagnosing of the set can be done in an interactive way. In this tool also the adjustment procedure has been implemented. The adjustment is absolutely necessary in case the CDR-Main Board and/or CD drive (CDR Loader) is disconnected from the matched production combination.
Only designated workshops can perform these repairs!
Please send the complete set to the designated workshop.

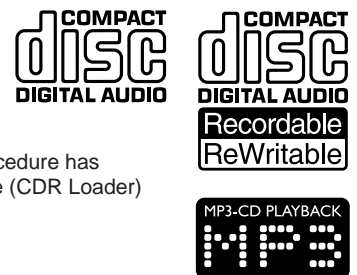

Available circuit descriptions: *The Basics of Compact Disc Recordable/Rewritable* 4822 725 25242
2nd line Service Manual CDR Mozart Module 3122 785 60030

TABLE OF CONTENTS

	chapter		chapter
Technical Specification and Measurement setup.....	1-1, 1-2	HEADPHONE BOARD	7-8
Location of printed circuit boards	1-3	CD LOADER	8-1 to 8-6
Warnings & Safety	2-1	EXPLODED VIEWS	
Brief Operating Instructions	3-1 to 3-3	apparatus.....	10-1
Dismantling Instructions.....	4-1 to 4-8	CD loader.....	8-6
Service hints	5-1 to 5-5	MECHANICAL PARTSLIST.....	10-2
Service Test Program	5-7 to 5-9	ELECTRICAL PARTSLIST.....	10-3 ff
BLOCK DIAGRAMS	6-1 to 6-4		
WIRING DIAGRAM.....	6-5		
POWER BOARD (for orientation only)	7-1		
DISPLAY BOARD	7-2 to 7-4		
KEY BOARD	7-5		
LIGHTGUIDE BOARD	7-5		
INTERFACE BOARD.....	7-6 to 7-7		



© Copyright 2002 Philips Consumer Electronics B.V. Eindhoven, The Netherlands
All rights reserved. No part of this publication may be reproduced, stored in a retrieval system or transmitted, in any form or by any means, electronic, mechanical, photocopying, or otherwise without the prior permission of Philips.

Published by MS 0217 Service Audio Printed in The Netherlands Subject to modification

GB 3103 785 25180

version 1.0



PHILIPS

TECHNICAL SPECIFICATION

General:

Mains voltage	: 220V-240V / 50-60Hz for /00 100V-240V /50-60Hz for /01 120V / 60Hz for /17
Power consumption	: ≤ 20W ≤ 0,6W in stand by

Input / Output:

Analog in:	
input sensitivity	: ≤250mV _{rms}
max. input voltage	: 2,8V _{rms}
input impedance	: 47kΩ

Analog out:	
output level	: 2V _{rms} ±2dB
output impedance	: 300Ω

Digital in (acc. IEC958):	
input level	: 0,5V _{pp}
input impedance	: 75Ω

Digital out (acc. IEC958):	
output level	: 0,5V _{pp}
output impedance	: 75Ω

Headphone:	
output level	: max. 5V _{rms} at 100kΩ
output impedance	: 120Ω
frequency response	: 20 - 20.000 Hz ±3dB (typ. ±2dB)
distortion	: ≤ 0,01% at 1 kHz and -6dB output level at 120Ω
channel difference	: ≤ 3dB at 1 kHz
channel crosstalk	: -73dB at 1kHz (typ. -80dB)
signal/noise ratio	: ≥ 95dB (A-weighted)

AUDIO PERFORMANCE

CD module: To be measured on ANALOG OUT socket.

frequency response	: 20 - 20.000 Hz ±0,5dB
signal/noise ratio	: ≥ 92dB (97dB A-weighted)
distortion	: -90dB at 1 kHz (-95dB typ.)
channel difference	: ≤ 0,3dB at 1 kHz
channel crosstalk	: -95dB at 1kHz(-100dB typ.)
de emphasis	: 0 or 15/50μs switched automatically by subcode on the disc

laser	
output power	: 500μW
wave length	: 780 ±20nm

CD-RW module: To be measured on ANALOG OUT socket.

frequency response	: 20 - 20.000 Hz ±0,5dB
signal/noise ratio	: ≥ 86dB (89dB A-weighted)
distortion	: -90dB at 1 kHz (-85dB recording)
channel difference	: ≤ 0,3dB at 1 kHz (≤ 0,5dB recording)
channel crosstalk	: -95dB at 1kHz (-89dB recording)
de emphasis	: 0 or 15/50μs switched automatically by subcode on the disc

laser (laser class 3B)	
output power	: 1mW max. during reading 20mW max. during writing
wave length	: 780 ±20nm

Remote Control:

RC5 commands **RC283105**

RC KEY	SYSTEM CODE		COMMAND CODE	
	CD	CDR		
⏻ Standby	20	26	12	
CD	20	20	63	
TIMER REC	26	26	90	
CDR	26	26	63	
1	20	26	01	
2	20	26	02	
3	20	26	03	
4	20	26	04	
5	20	26	05	
6	20	26	06	
7	20	26	07	
8	20	26	08	
9	20	26	09	
TRACK INCR.	26	26	114	
0	20	26	00	
PROGRAM	20	26	36	
ALBUM -	20	26	CD 113	CDR 115
ALBUM +	20	26	112	
▶ PLAY	20	26	53	
◀	20	26	33	
▶	20	26	32	
■ STOP	20	26	54	
◀◀	20	26	50	
▶▶	20	26	52	
 PAUSE	20	26	48	
DISPLAY	20	26	11	
DIM	16	26	71	
CD TEXT/edit	20	26	CD 88	CDR 82
DELETE	20	26	49	
SHUFFLE	20	26	28	
REPEAT	20	26	29	

RC5 code RC283105, 220402

MEASUREMENT SETUP

CD

Use Audio Signal Disc SBC429 4822 397 30184
(replaces test disc 3)

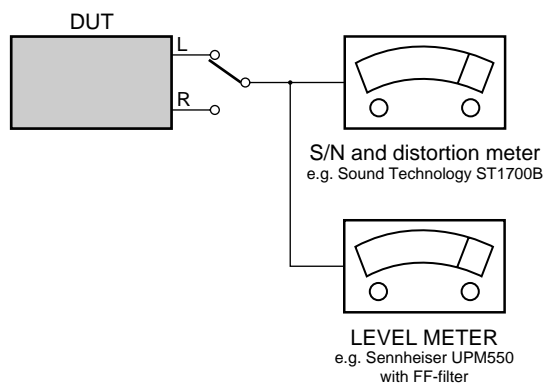

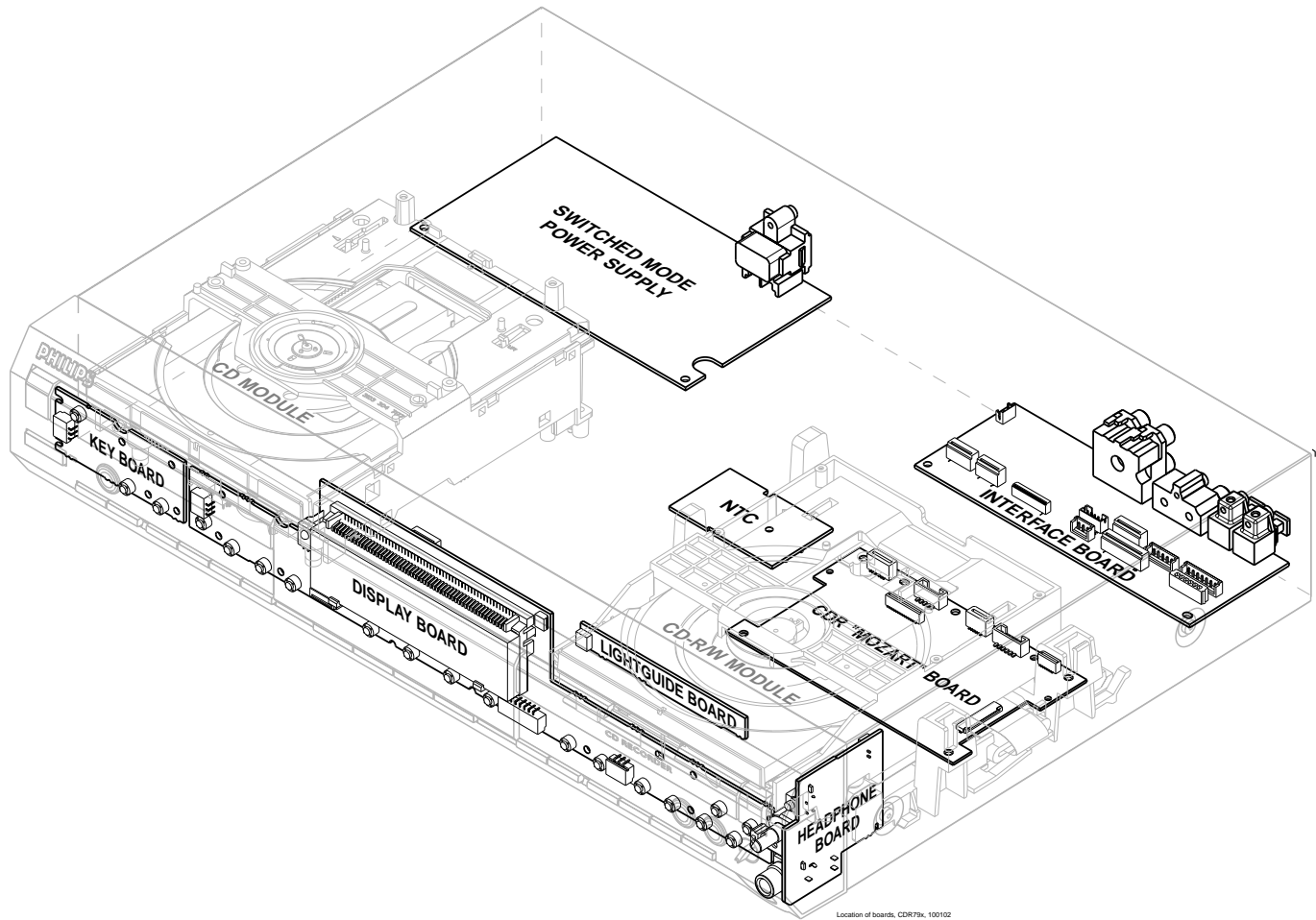

Location of boards, CDR75x, 100102

picture 1

(GB) WARNING

All ICs and many other semiconductors are susceptible to electrostatic discharges (ESD). Careless handling during repair can reduce life drastically.
When repairing, make sure that you are connected with the same potential as the mass of the set via a wristband with resistance. Keep components and tools at this potential.

(F) ATTENTION

Tous les IC et beaucoup d'autres semi-conducteurs sont sensibles aux décharges statiques (ESD). Leur longévité pourrait être considérablement écourtée par le fait qu'aucune précaution n'est prise à leur manipulation.
Lors de réparations, s'assurer de bien être relié au même potentiel que la masse de l'appareil et enfilez le braceleterti d'une résistance de sécurité.
Veiller à ce que les composants ainsi que les outils que l'on utilise soient également à ce potentiel.



(D) WARNUNG

Alle ICs und viele andere Halbleiter sind empfindlich gegenüber elektrostatischen Entladungen (ESD).
Unvorsichtige Behandlung im Reparaturfall kann die Lebensdauer drastisch reduzieren.
Sorgen Sie dafür, daß Sie im Reparaturfall über ein Pulsarmband mit Widerstand mit dem Massepotential des Gerätes verbunden sind.
Halten Sie Bauteile und Hilfsmittel ebenfalls auf diesem Potential.

(NL) WAARSCHUWING

Alle IC's en vele andere halfgeleiders zijn gevoelig voor electrostatische ontladingen (ESD).
Onzorgvuldig behandelen tijdens reparatie kan de levensduur drastisch doen verminderen. Zorg ervoor dat u tijdens reparatie via een polsband met weerstand verbonden bent met hetzelfde potentiaal als de massa van het apparaat.
Houd componenten en hulpmiddelen ook op ditzelfde potentiaal.

(I) AVVERTIMENTO

Tutti IC e parecchi semi-conduttori sono sensibili alle scariche statiche (ESD).
La loro longevità potrebbe essere fortemente ridatta in caso di non osservazione della più grande cauzione alla loro manipolazione. Durante le riparazioni occorre quindi essere collegato allo stesso potenziale che quello della massa del'apparecchio tramite un braccialetto a resistenza.
Assicurarsi che i componenti e anche gli utensili con quali si lavora siano anche a questo potenziale.

(GB) AVAILABLE ESD PROTECTION EQUIPMENT :

anti-static table mat	large 1200x650x1.25mm	4822 466 10953
	small 600x650x1.25mm	4822 466 10958
anti-static wristband		4822 395 10223
connection box	(3 press stud connections, 1MΩ)	4822 320 11307
extendible cable	(2m, 2MΩ, to connect wristband to connection box)	4822 320 11305
connecting cable	(3m, 2MΩ, to connect table mat to connection box)	4822 320 11306
earth cable	(1MΩ, to connect any product to mat or to connection box)	4822 320 11308
KIT ESD3	(combining all 6 prior products - small table mat)	4822 310 10671
wristband tester		4822 344 13999

(GB)

Safety regulations require that the set be restored to its original condition and that parts which are identical with those specified be used.
Safety components are marked by the symbol

(F)

Les normes de sécurité exigent que l'appareil soit remis à l'état d'origine et que soient utilisées les pièces de rechange identiques à celles spécifiées.
Les composants de sécurité sont marqués

SAFETY



(D)

Bei jeder Reparatur sind die geltenden Sicherheitsvorschriften zu beachten. Der Originalzustand des Gerätes darf nicht verändert werden. Für Reparaturen sind Originalersatzteile zu verwenden.
Sicherheitsbauteile sind durch das Symbol markiert.

(NL)

Veiligheidsbepalingen vereisen, dat het apparaat in zijn oorspronkelijke toestand wordt teruggebracht en dat onderdelen, identiek aan de gespecificeerde, worden toegepast.
De Veiligheidsonderdelen zijn aangeduid met het symbool

(I)

Le norme di sicurezza estigono che l'apparecchio venga rimesso nelle condizioni originali e che siano utilizzati i pezzi di ricambio identici a quelli specificati.
Componenti di sicurezza sono marcati con

(GB) DANGER: Invisible laser radiation when open.
AVOID DIRECT EXPOSURE TO BEAM.

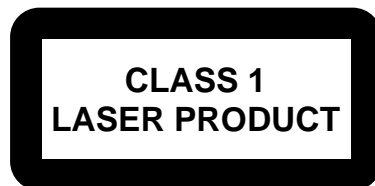

(S) Varning !

Osynlig laserstrålning när apparaten är öppnad och spärren är urkopplad. Betrakta ej strålen.

(DK) Advarsel !

Usynlig laserstrålning ved åbning når sikkerhedsafbrydere er ude af funktion. Undgå udsættelse for stråling.

(FIN) Varoitus !

Avatussa laitteessa ja suojalukituksen ohitettaessa olet alltiina näkymättömälle laserisäteilylle. Älä katso säteeseen !

(GB)

After servicing and before returning the set to customer perform a leakage current measurement test from all exposed metal parts to earth ground, to assure no shock hazard exists.
The leakage current must not exceed 0.5mA.

(F)

"Pour votre sécurité, ces documents doivent être utilisés par des spécialistes agréés, seuls habilités à réparer votre appareil en panne".

The following excerpt of the Owner's Manual serves as a very short introduction to the set. The complete Owners Manual can be downloaded in several languages from the Internet site of Philips Customer Care Center: www.p4c.philips.com

Controls

English

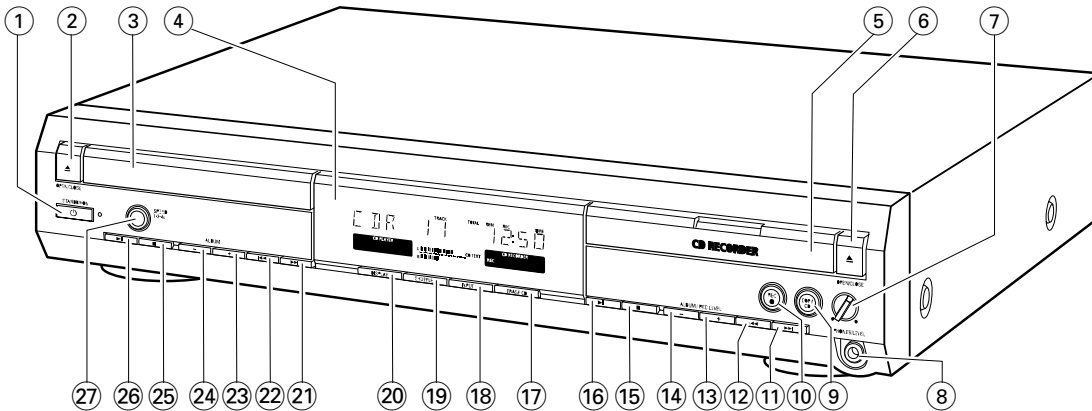

- ① **STANDBY-ON**
switches the unit on/to standby
- ② **▲ OPEN/CLOSE**
opens/closes the CD player drawer
- ③ CD player drawer
- ④ display
- ⑤ **CD RECORDER**
CD recorder drawer
blue light on: CD recorder is selected
red light on: recording in progress
- ⑥ **▲ OPEN/CLOSE**
opens/closes the CD recorder drawer
- ⑦ **PHONES/LEVEL**
adjusts the headphone volume
- ⑧ **PHONES/LEVEL**
6.3 mm headphone jack
- ⑨ **COPY CD**
selects recording and automatic finalizing of current CD
- ⑩ **REC ●**
selects other recording modes
- ⑪ **▶▶**
CD recorder: selects the next track, searches forward
- ⑫ **◀◀**
CD recorder: selects the previous track, searches backward
- ⑬ **ALBUM/REC LEVEL+**
CD recorder: selects the next album on an MP3-CD,
increases the recording level
- ⑭ **ALBUM/REC LEVEL-**
CD recorder: selects the previous album on an MP3-CD,
decreases the recording level
- ⑮ **■**
CD recorder: stops playback/recording
- ⑯ **▶||**
CD recorder: starts/interrupts playback
- ⑰ **ERASE CD**
erases recordings on a CDRW
- ⑱ **INPUT**
selects the input for an external appliance
- ⑲ **SHUFFLE**
plays tracks in random order
- ⑳ **DISPLAY**
selects display information
- ㉑ **▶▶**
CD player: selects the next track, searches forward
- ㉒ **◀◀**
CD player: selects the previous track, searches backward
- ㉓ **ALBUM+**
CD player: selects the next album on an MP3-CD
- ㉔ **ALBUM-**
CD player: selects the previous album on an MP3-CD
- ㉕ **■**
CD player: stops playback
- ㉖ **▶||**
CD player: starts/interrupts playback
- ㉗ **SPEED 1·2·4x**
selects the record speed for internal recording
Note: SPEED 1·2·4x, REC and COPY CD will be illuminated depending on the different modes you are in. This in order to facilitate finding the relevant keys for selection.

Remote control

English

Remote control keys

- 1 switches the unit on/to standby
- 2 **CD, CDR** selects the CD player deck or the CD recorder deck
- 3 **TIMER REC** starts a time restricted recording
- 4 **Number/alphabet keys**
1-0 keys in numbers for tracks
ABC - WXYZ: keys in letters for CD text
SPACE: keys in a space for CD text
.: keys in a dot or symbol for CD text
- 5 **TR. INCR.** selects automatic or manual increment of a track
- 6 **PROGRAM** enters the program menu
- 7 **ALBUM+** selects the next album on an MP3-CD
- 8 **ALBUM-** selects the previous album on an MP3-CD
- 9 starts playback
- 10 selects the previous track
- 11 selects the next track
- 12 stops playback
- 13 searches forward
- 14 searches backward
- 15 interrupts playback
- 16 **DIM** controls the brightness of the display
- 17 **DISPLAY** selects display information
- 18 **CD TEXT/edit** switches through CD text information, enters/exits the CD text edit menu
- 19 **DELETE** deletes CD text
- 20 **REPEAT** repeats a track, an entire CD(RW), or a program
- 21 **SHUFFLE** plays tracks in random order

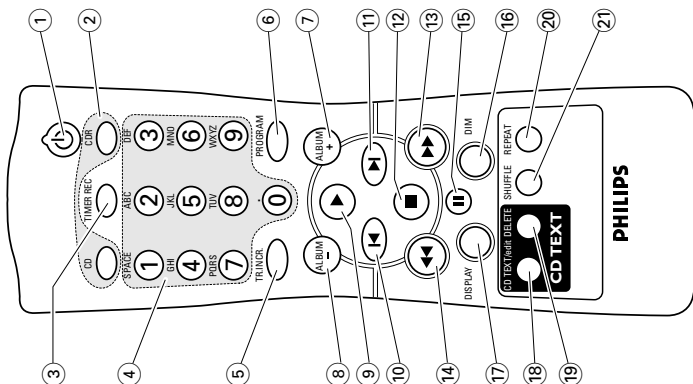

Remote control usage

Open the battery compartment of the remote control and insert 2 alkaline batteries, type **AA** (R06, UM-3).

Do not use old and new or different types of batteries in combination.

Remove batteries if they are dead or if the remote control will not be used for a long time.

Batteries contain chemical substances, so they should be disposed of properly.

The buttons on the remote control work the same way as the corresponding ones on the unit.

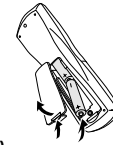

Connections

English

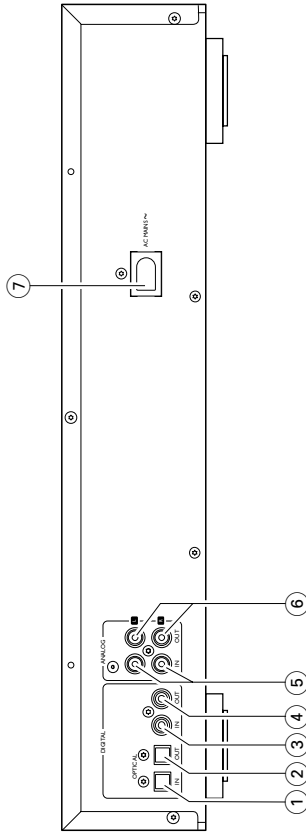

Connections

- 1 **OPTICAL IN** connect to the digital optical output of an external digital appliance
- 2 **OPTICAL OUT** connect to the digital optical input of an external digital appliance
- 3 **DIGITAL IN** connect to the digital coaxial output of an external digital appliance
- 4 **DIGITAL OUT** connect to the digital coaxial input of an external digital appliance
- 5 **ANALOG IN L/R** connect to the analog audio output of an external appliance
- 6 **ANALOG OUT L/R** connect to the analog audio input of an external appliance
- 7 **AC MAINS ~** After all other connections have been made, connect the power cord to the power outlet.

Setup information

Place the unit on a flat, hard and stable surface. Do not position the unit on top of other equipment that might heat it up (e.g. receiver or amplifier) if the unit is placed in a cabinet, make sure to leave at least 3.5 cm (1.5 inches) free around the unit to prevent overheating. Active mobile phones near the unit may cause malfunctions.

Connections general

Never make or change connections with the power supply switched on.

For playback the following outputs are present:

- Analog output (ANALOG OUT L/R)
- Digital coaxial output (DIGITAL OUT)
- Digital optical output (OPTICAL OUT)

For external recording the following inputs are present

- Analog input (ANALOG IN L/R)
- Digital coaxial input (DIGITAL IN)
- Digital optical input (OPTICAL IN)

These inputs can be connected to the corresponding output(s) of your amplifier/receiver or directly to the corresponding output(s) of the external appliance.

It is not possible to connect a turntable directly to ANALOG IN L/R. If you wish to use a turntable with the unit, you have to connect an amplifier/receiver to ANALOG IN L/R on the CD player/recorder. Then connect the turntable to the amplifier.

The connections you make will depend upon the possibilities your audio equipment offers and how you are going to use the unit. Please refer to the user manuals for your audio equipment first.

We recommend doing analog recording only if digital recording is not possible. Digital recording will result in better sound quality.

If possible, always make both digital and analog connections. In this way you can always make analog recordings when digital recording is not possible.

Analog connections

These connections are required for playback and recording via an amplifier/receiver, equipped with analog in- and outputs.

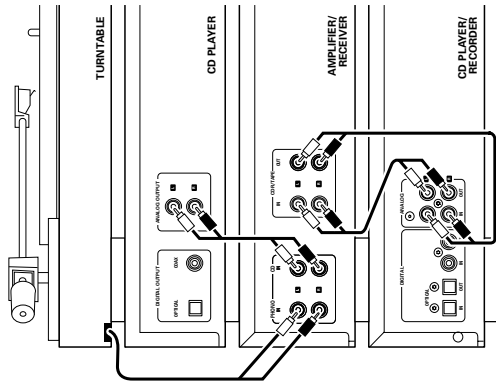

- 1 Connect the red plug of the supplied audio cable (cinch) to the red jack ANALOG IN R and the white plug to the white jack ANALOG IN L on the CD player/recorder.
 - 2 Connect the other end of the audio cable to the analog outputs of the amplifier/receiver (CDR OUT TAPE OUT, AUX OUT, REC OUT, etc.).
 - 3 Connect the red plug of the supplied audio cable (cinch) to the red jack ANALOG OUT R and the white plug to the white jack ANALOG OUT L on the CD player/recorder.
 - 4 Connect the other end of the audio cable to the analog inputs of the amplifier/receiver (CD-R, TAPE IN, AUX, PLAY IN, etc.).
 - 5 Connect all other components of your system (tape deck, CD player, tuner, turntable, etc.) via their analog outputs to the appropriate analog inputs of the amplifier/receiver (CD IN, TUNER IN, AUX IN, PHONO IN, etc.).
- Recording can be done now with any appliance connected to an analog input of the amplifier/receiver: Press INPUT on the CD player/recorder repeatedly to select the analog input.
ANALOG IN is displayed.

How to connect if the analog output on the amplifier/receiver is already being used (occupied)
 Most amplifiers/receivers have multiple analog output connections (TAPE, VCR, ...) but some amplifiers/receivers have only 1 analog output in case you have already hooked up a tape deck (DAT recorder or MD recorder) to this output you will have to change the existing connections.

- 1 Disconnect the analog connections from the tape deck to the amplifier/receiver.
- 2 Connect the CD player/recorder (see steps 1-4 in the previous chapter).
- 3 Connect the analog outputs of the tape deck to any free analog inputs (AUX, CD) on the amplifier/receiver: You can now playback your tape or record from your tape deck on CD. However, it is no longer possible to record on tape.

Digital connections

Direct digital coaxial connection
 This connection is required for direct recording from any digital audio equipment with a digital coaxial output (e.g. CD player or DVD player).

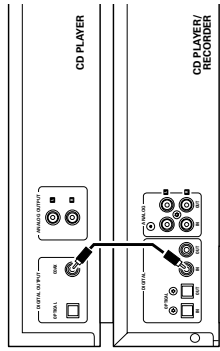

- Use a digital coaxial cable to connect the coaxial output of the external appliance with DIGITAL IN on the CD player/recorder:
- 1 Recording can be done now via the digital coaxial input. Press INPUT on the CD player/recorder repeatedly to select the digital coaxial input.
DIGITAL IN is displayed.

Direct digital optical connection

This connection is required for direct recording from any digital audio equipment with a digital optical output (e.g. CD player or DVD player).

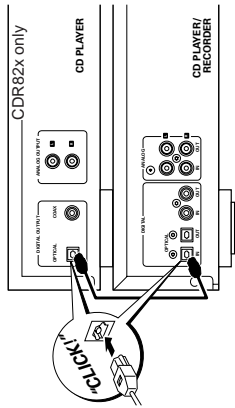

- 1 Remove the dust caps from the digital optical input of the CD player/recorder and from the digital optical output of the external appliance. Keep the caps in a safe place.
 - 2 Use a digital optical cable to connect the optical output of the external appliance with OPTICAL IN on the CD player/recorder. Make sure you insert both plugs fully, until a click is heard.
- Recording can be done now via the digital optical input. Press INPUT repeatedly on the CD player/recorder to select the digital optical input.
DIGITAL IN is displayed.

Digital coaxial connections via a digital receiver

If you have a receiver with digital coaxial in- and outputs, these connections allow you to make digital recordings from various sources connected to the receiver.

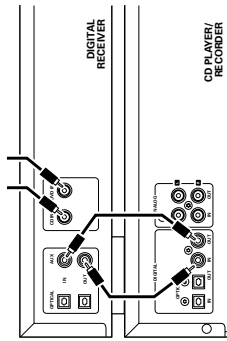

- Use a coaxial cable to connect the digital coaxial input of the receiver with DIGITAL OUT on the CD player/recorder. Use another coaxial cable to connect the digital coaxial output of the receiver with DIGITAL IN on the CD player/recorder.
- 1 Recording can be done now with any digital appliance connected to a digital input of the digital receiver (e.g. CD player or DVD player). Press INPUT on the CD player/recorder repeatedly to select the digital coaxial input.
DIGITAL IN is displayed.

Digital optical connections via a digital receiver
 If you have a receiver with digital optical in- and outputs, these connections allow you to make digital recordings from various sources connected to the receiver.

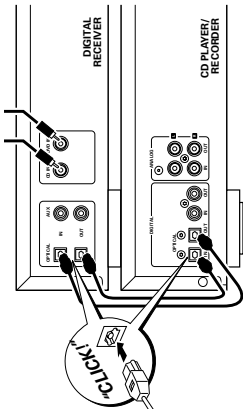

- 1 Remove the dust caps from the digital optical in- and outputs of the CD player/recorder and from the digital optical output of the receiver. Keep the caps in a safe place.
 - 2 Use a digital optical cable to connect the optical input of the receiver with OPTICAL OUT on the CD player/recorder. Use another digital optical cable to connect the optical output of the receiver with OPTICAL IN on the CD player/recorder. Make sure you insert the plugs fully, until a click is heard.
- Recording can be done now with any digital appliance connected to a digital input of the receiver (e.g. CD player or DVD player). Press INPUT on the CD player/recorder repeatedly to select the digital optical input.
DIGITAL IN is displayed.

Power

The type plate is located on the rear of the unit.

- 1 Check whether the power voltage as shown on the type plate corresponds to your local power voltage. If it does not, consult your dealer or service organization.
- 2 **Make sure all connections have been made before switching on the power supply.**
- 3 Connect the power cable supplied to AC MAINS ~ and to the power outlet. This switches on the power supply. When the unit is switched to standby, it is still consuming some power: **To disconnect the unit from the power completely, remove the power plug from the power outlet.**

Dismantling the Top Cover

- Remove 7 (9) screws as shown in picture 2.
- Raise top cover at the rear and pull it backwards.

remark: in some production batches the top cover may be fixed with 5 screws at the rear side.

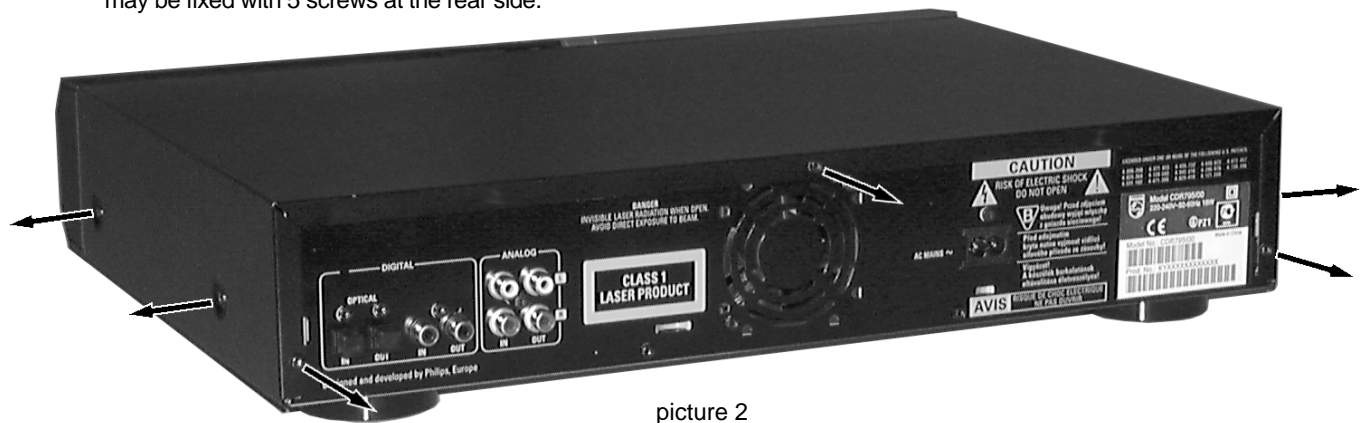

picture 2

Dismantling the Tray Covers

To dismantle the ornamental cover, the tray has to be moved out first. This can either be done by activating the Open/Close-key or manually. In order to avoid unnecessary loading it is recommended to move the tray out manually a few centimetres. To release the tray manually proceed as shown in pictures 3, 4, 5 and 6. The tray will move out a little. Afterwards it can be pulled out as far as convenient.

Release tray of CD Loader

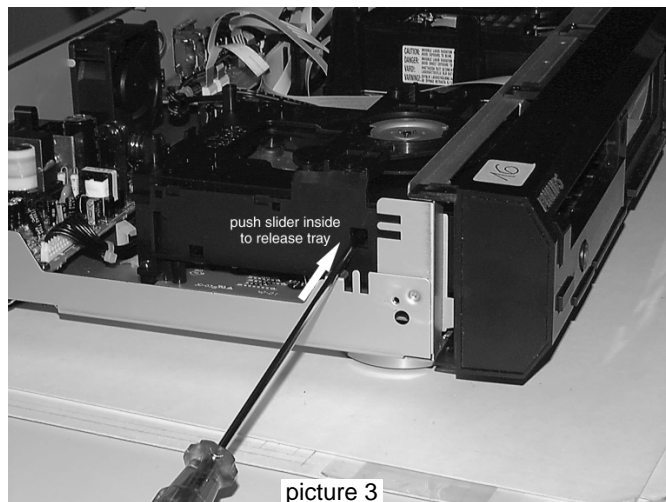

picture 3

Release tray of CDR module

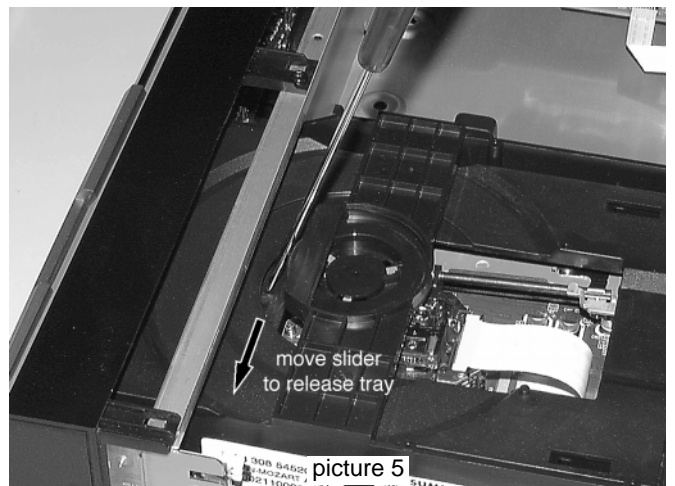

picture 5

or

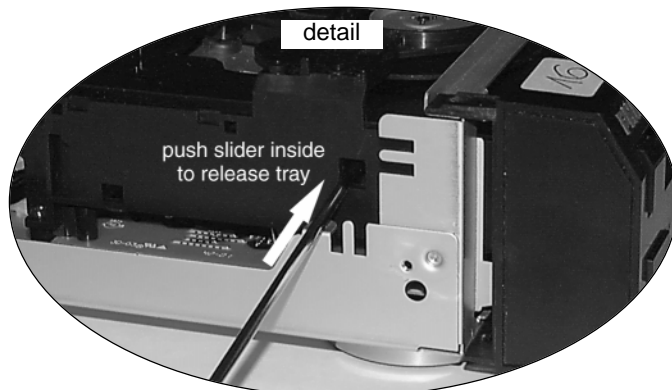

picture 4

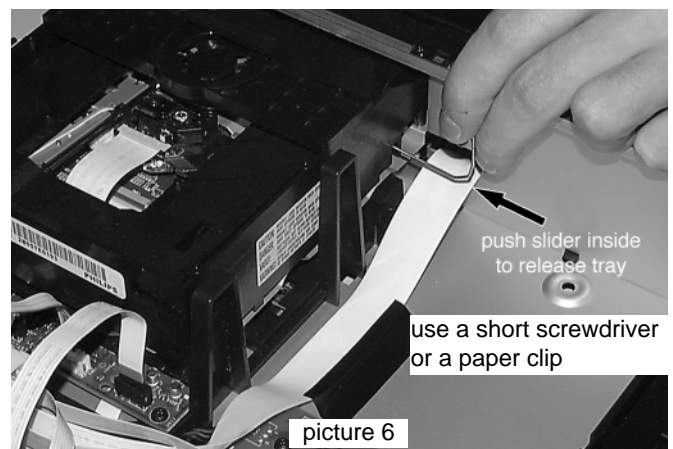

picture 6

Dismantling the Tray Covers continued

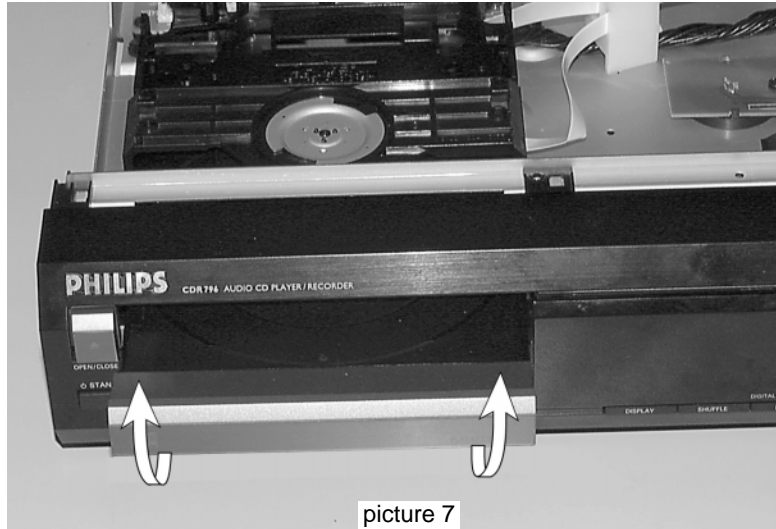

picture 7

- To release the cover from the catch on the tray, pull it frontwards on bottom side as shown in picture 7 and 8.
- Pull the cover up.

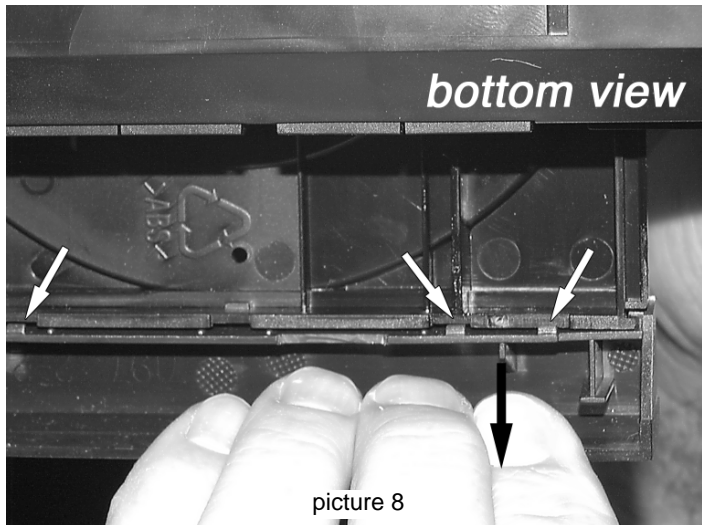

picture 8

Dismantling the ornamental cover
from the CDR-tray
functions in the same manner.

Dismantling the Front Cabinet



picture 9

- Remove top cover and ornamental covers from the trays first → see description above and on page 4-1.
- Move trays back to *closed* position.
- Loosen 2 screws as shown in picture 9.
- Remove adhesive tape from cable 8016 and take cable to Headphone Board out of its guidings on the right side of the CDR support.
- Release 4 catches on top (as shown in picture 9) first, then 2 catches on bottom (see picture 10).

Dismantling the *Front Cabinet* continued

- Pull front cabinet forwards.
As the lug fits very tight in the bottom it is recommended to make use of a screwdriver (see picture 11).
- Place front cabinet as shown in picture 12.

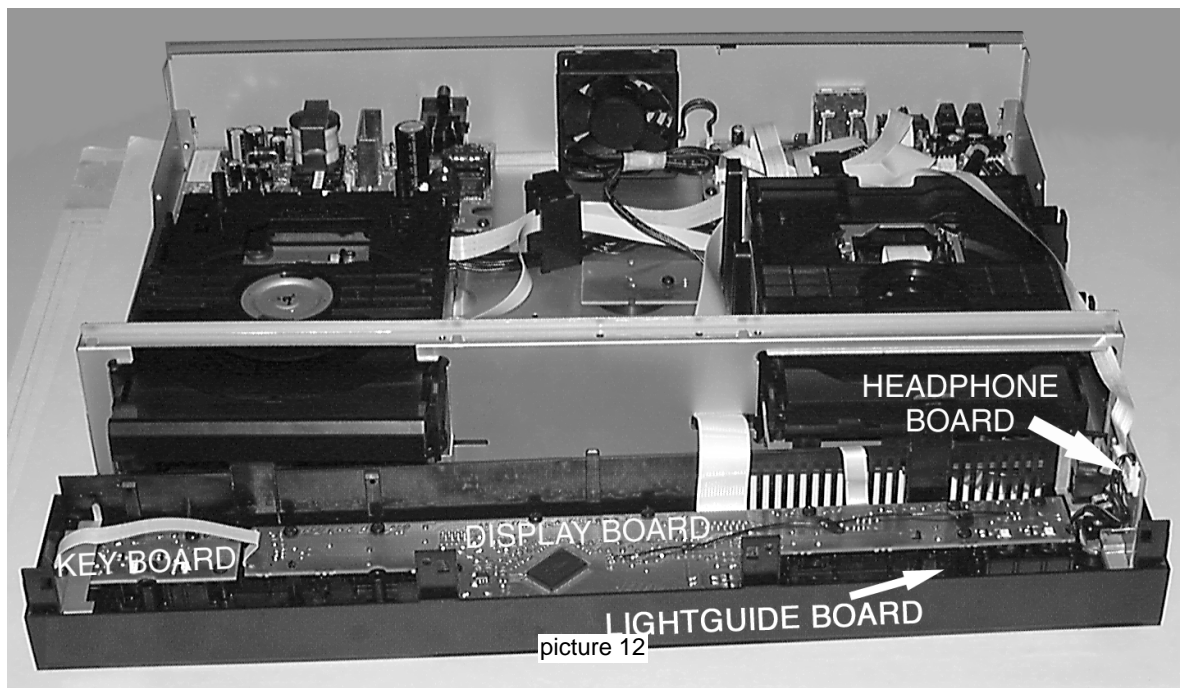
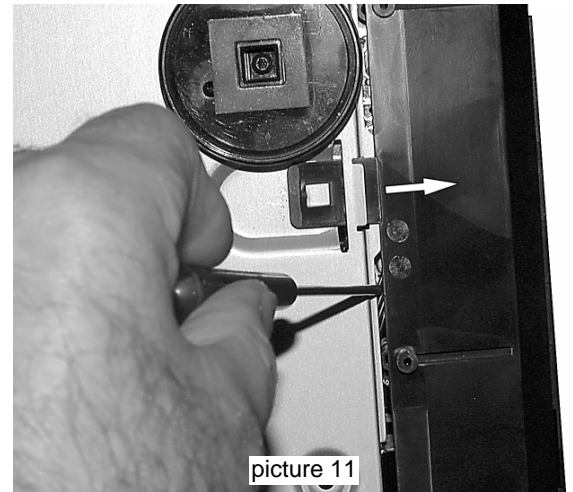
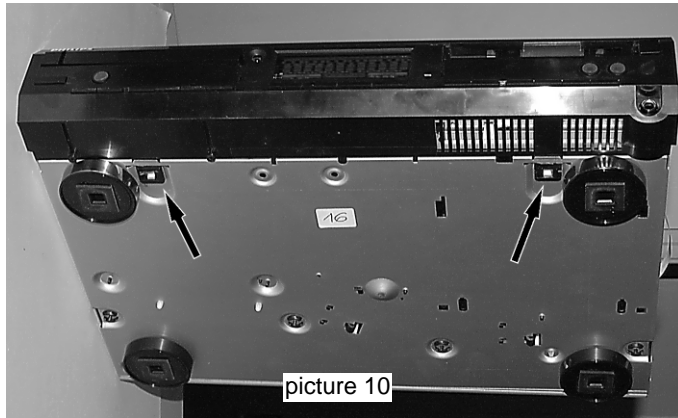

Dismantling the *CD module*

- Remove top cover and ornamental cover from the tray first → see description on pages 4-1 and 4-2.
- Loosen 2 screws at the rear side → see picture 13.
- Move the complete module backwards.
- Pull the module on rear side up and turn it out.
- Put the module to a proper service position. → see also chapter SERVICE HINTS.



picture 13

Mounting the *CD module*

- For proper mounting it is necessary that the pins on the front side (see picture 14) are put into the feed holes on the front cabinet (see picture 15).
- Move the module frontwards until the guiding pins at the rear slip into the holes on the bottom.
- Fix the module with 2 screws at the rear (see picture 13).

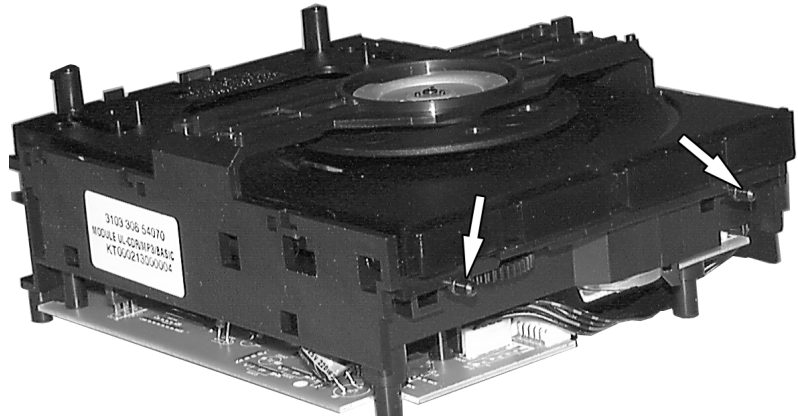

picture 14

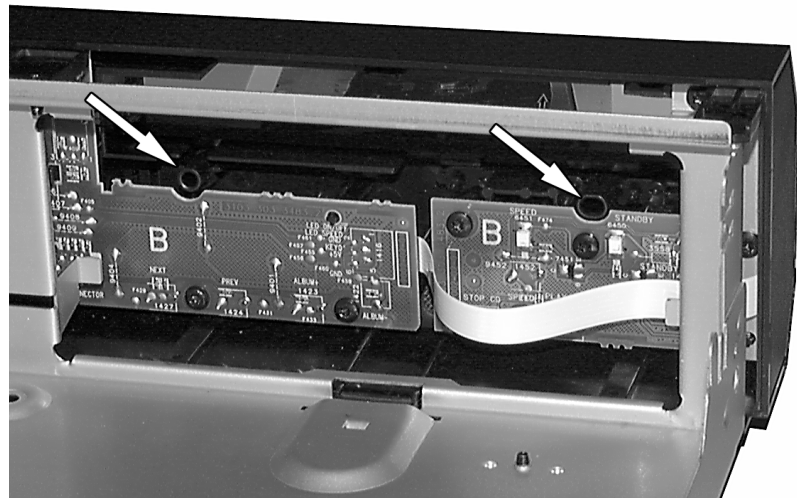

picture 15

Dismantling the *CDR module*

- Remove top cover and ornamental cover from the tray first
→ see description on pages 4-1 and 4-2.
- move tray back to *closed* position.
- to dismantle the **complete module**:
 - loosen 3 screws to bottom cabinet (see picture 16 ①)
 - disengage catches (see picture 17 ②)
 - move module backwards ③ until catches to bottom cabinet become free and pull it up.

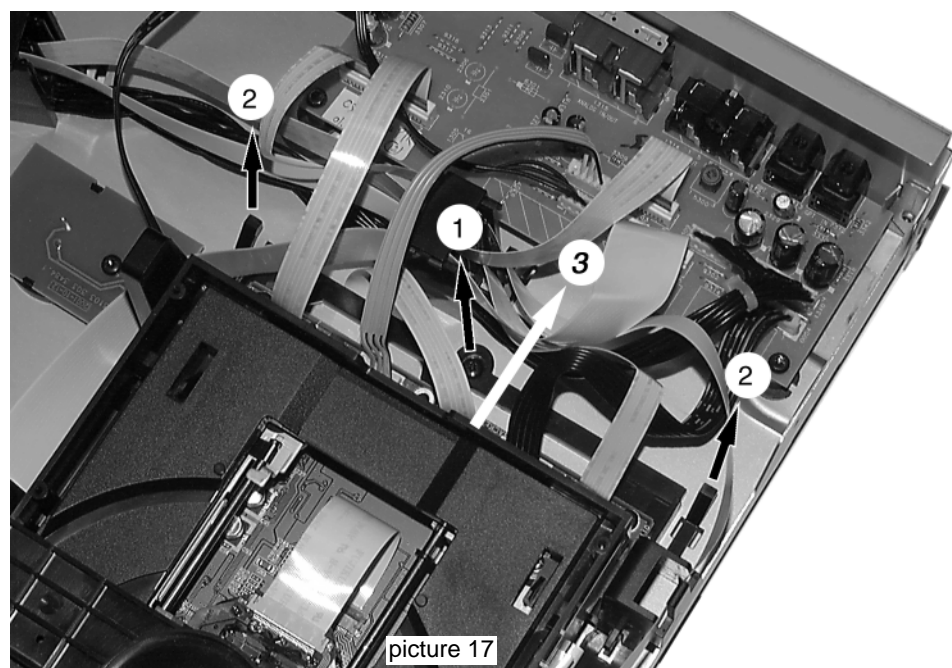
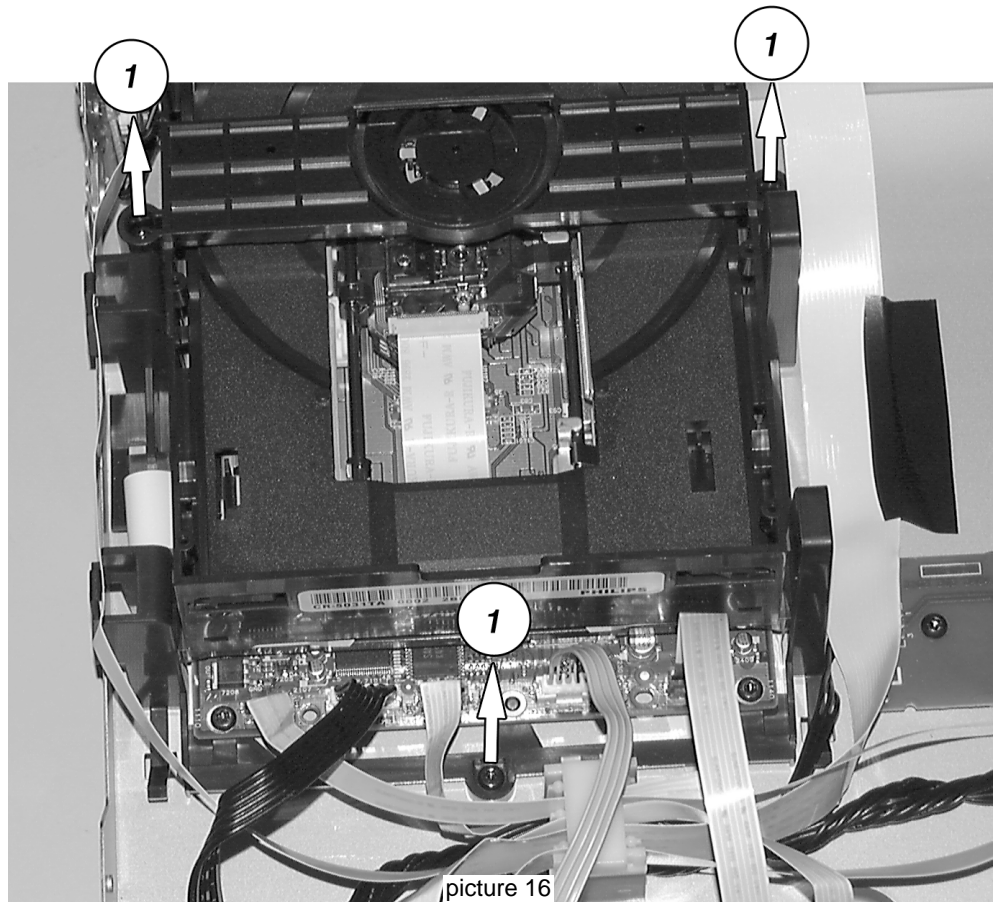

Dismantling the CDR module

continued

• to dismantle the **Loader module:**

- move tray completely out.
- loosen 4 screws to frame as shown in picture 18.

attention: flex wire to Mozart Board is too short for simple fetching the loader out. It is advised either to dismantle the complete module as described on page 4-5 and to move it a few centimetres back or to loosen ferrite core as shown in picture 18a.

- put the module to a proper service position.
→ see also chapter SERVICE HINTS.

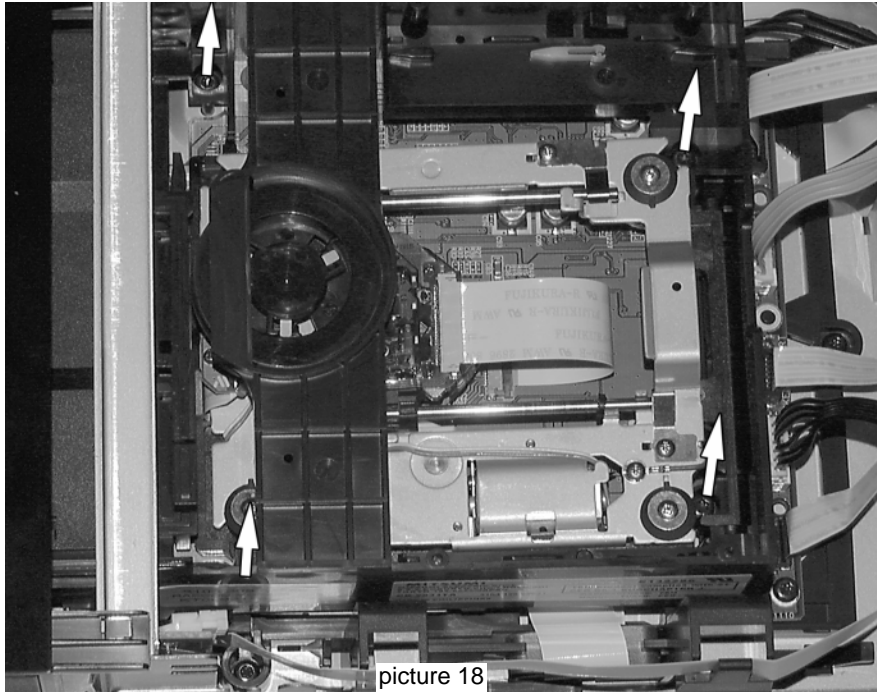

Press locking lug with a screwdriver down and move ferrite core out of its guiding. Turn ferrite core up and move it gently along the cable.

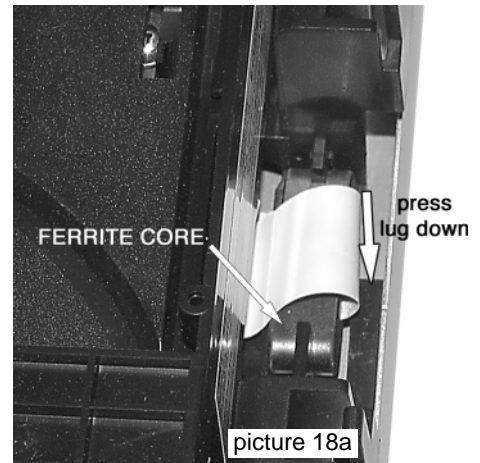
• to dismantle the **MOZART Board:**

- loosen 2 screws to frame as shown in picture 19.
- unlock flex foil connector and disconnect flex wire.
- pull the board out of it's guidings (backwards).
- place the Mozart board to a proper service position.
→ see also chapter SERVICE HINTS.

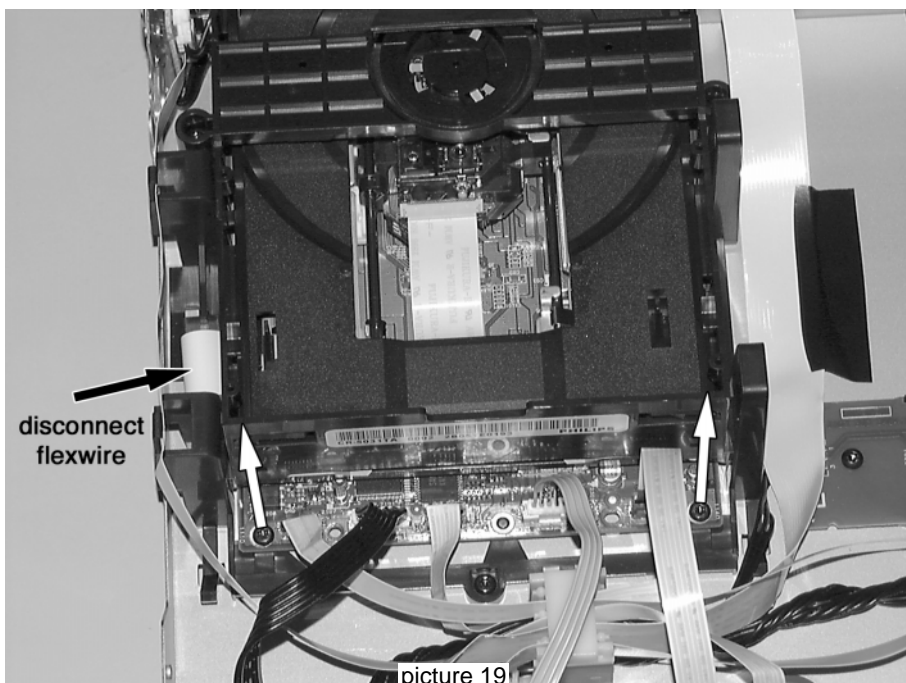

Dismantling the *Power board*

- Remove top cover first → see description on page 4-1.
- Loosen 3 screws as indicated in picture 20.
- Move the board backwards to release the mains socket.
- Lift it on the rear and turn it out.

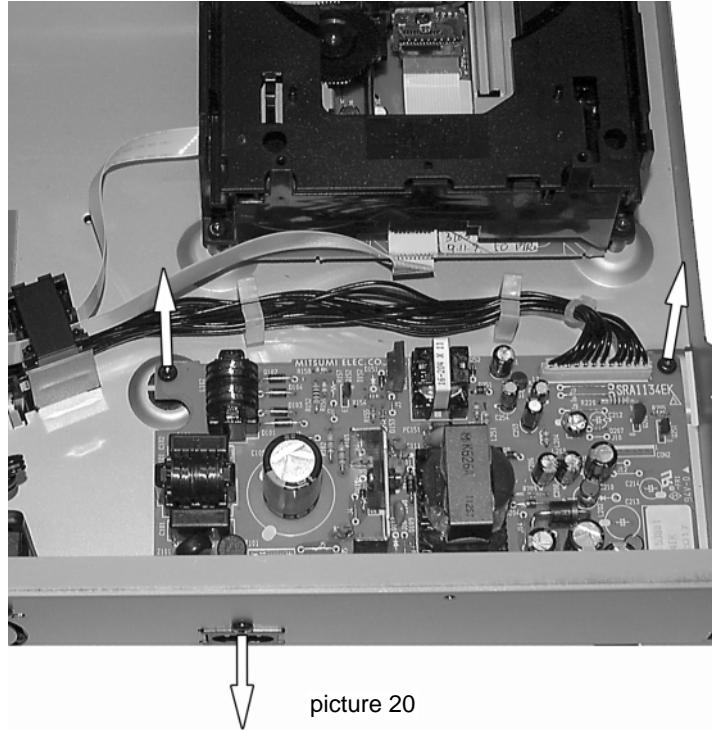

Attention: to fulfil safety requirements after repair it is absolutely necessary to fix the cables as in its original condition. See picture 21.

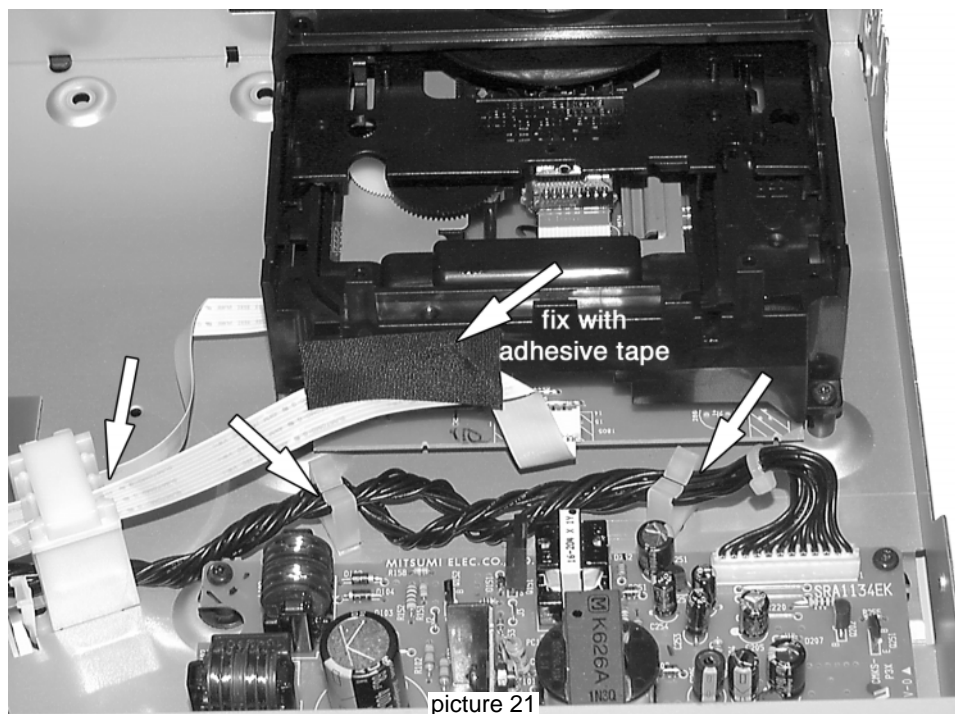

Dismantling the *Interface Board*

- Remove top cover first → see description on page 4-1.
- Loosen 2 screws from the board and 4 screws from sockets at the rear plate.
- Move the Interface board backwards to release the sockets and turn it out (if necessary disengage cable guide).
- place the Interface board to a proper service position.
→ see also chapter SERVICE HINTS.



picture 22

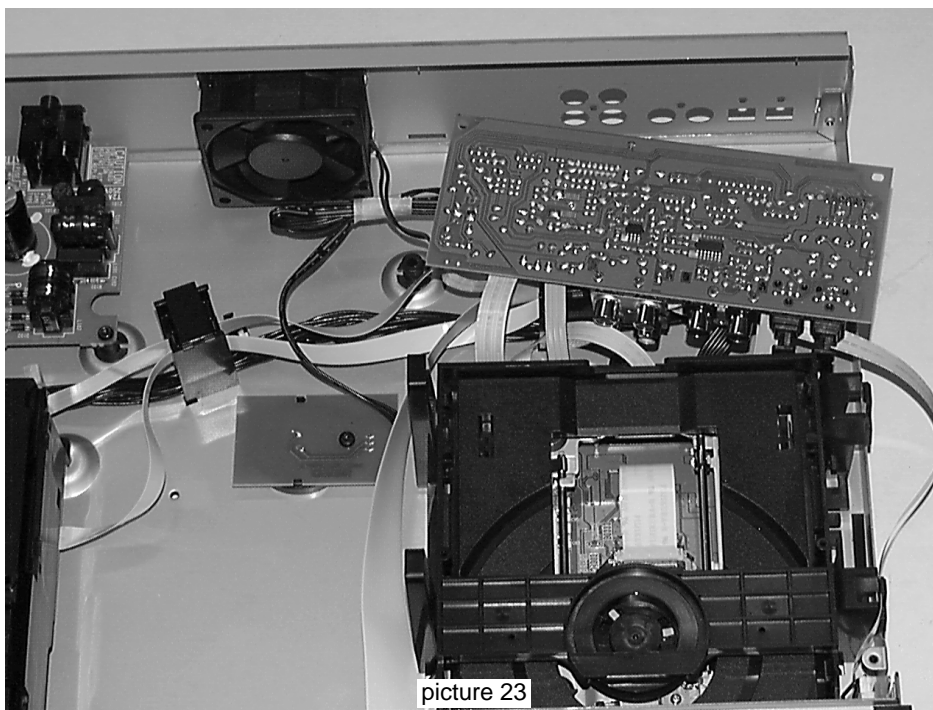

picture 23

SERVICE TOOLS

- TORX T10** screwdriver with shaftlength 150mm4822 395 50423
- TORX screwdriver set SBC 163**4822 295 50145

- Audio signal disc SBC 429**.....4822 397 30184
- Playability test disc SBC444**4822 397 30245
- Test disc 5** (disc without errors) +
- Test disc 5A** (disc with dropout errors, black spots and fingerprints)
 SBC 426/426A4822 397 30096
- Burn in test disc** (65 min. 1kHz signal at -30dB level without "pause") ...4822 397 30155

DEALER MODE

The sets are equipped with a special DEALER MODE. This mode blocks the trays of the CD - and CDR module to prevent customers from fetching out CDs from exhibition sets.

The Dealer mode can be switched on/off as follows:

- 1) Switch the set with the Remote Control to [Standby]
- 2) Press the [DISPLAY] key at least for 5s
 → Display shows
TRAYS LOCKED else *UNLOCKED*

DEMO MODE

The DEMO MODE displays various features of the set and will start automatically when no key has been pressed for several minutes or during Standby mode.

The Demo mode can be switched on/off as follows:

- 1) Switch the set with the Remote Control to [Standby]
- 2) Press the [STOP] key on the set at least for 5s
 → Display shows
DEMO ON else *DEMO OFF*

HANDLING CHIP COMPONENTS

GENERAL

DISMOUNTING

MOUNTING

EXAMPLES

PRECAUTIONS

General Service position

For measurements on: Power Board
Interface Board
For manual release of: CD tray
CDR tray

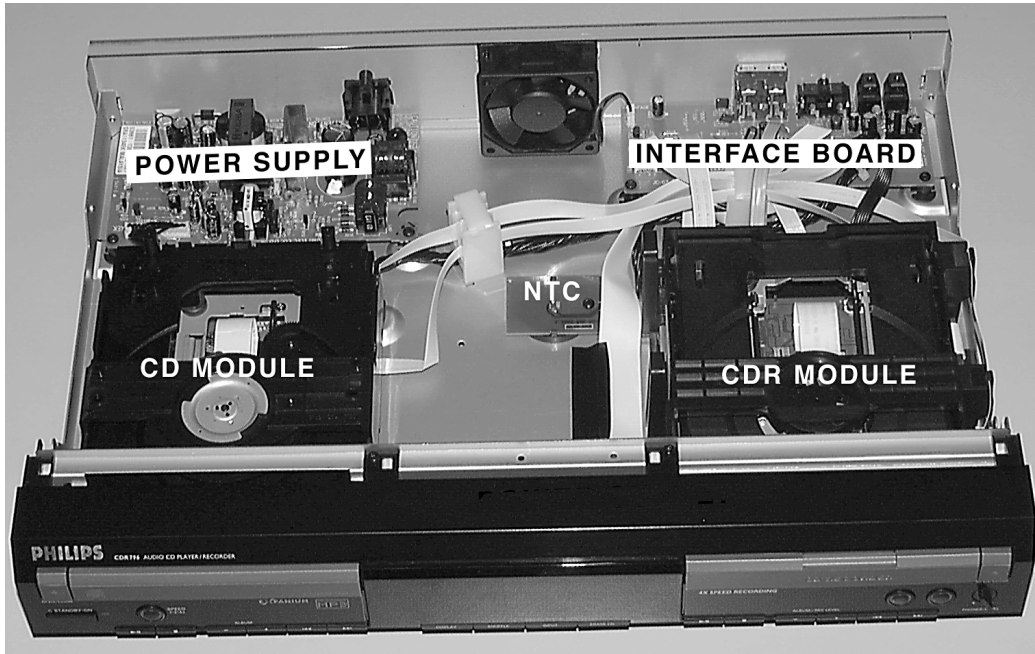

picture 24

Service position Front Board

For dismantling instructions see chapter 4-1 to 4-3

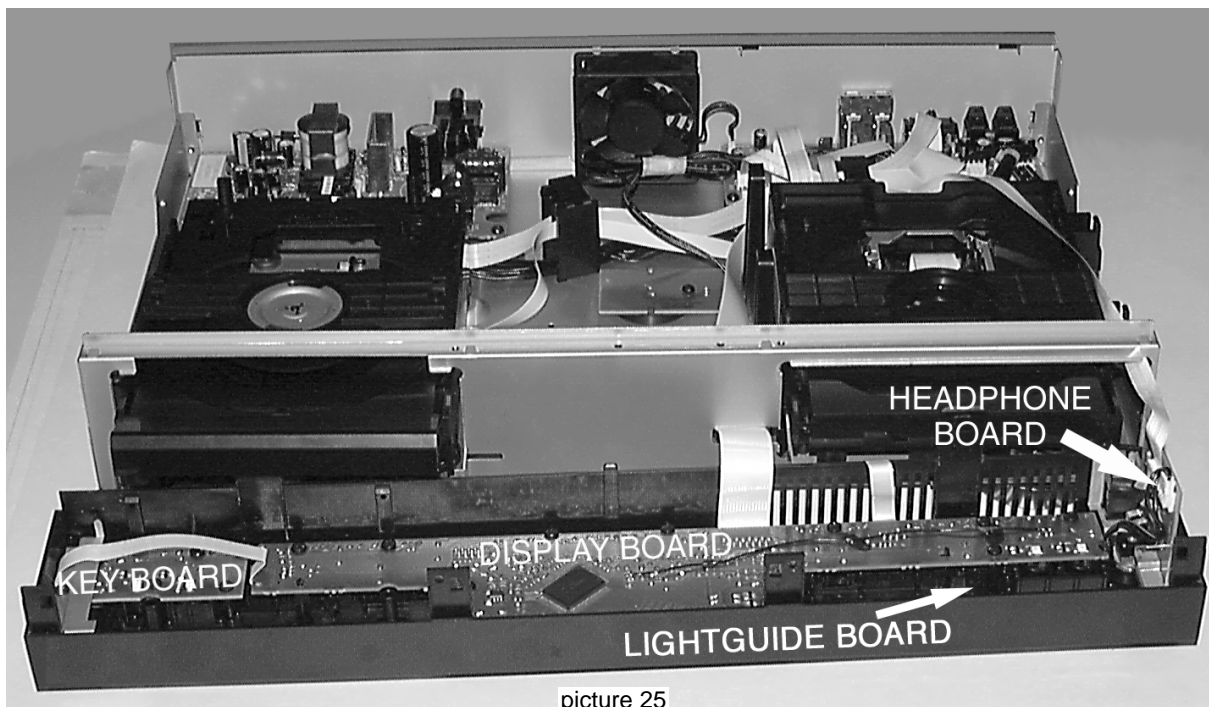

picture 25

Service position *CD Module*

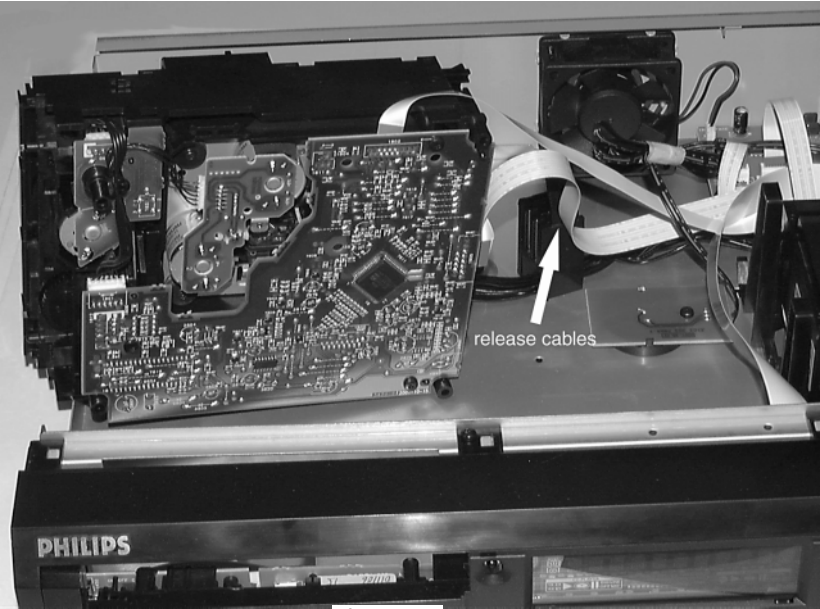

picture 26

For dismantling instructions see chapter 4-4.

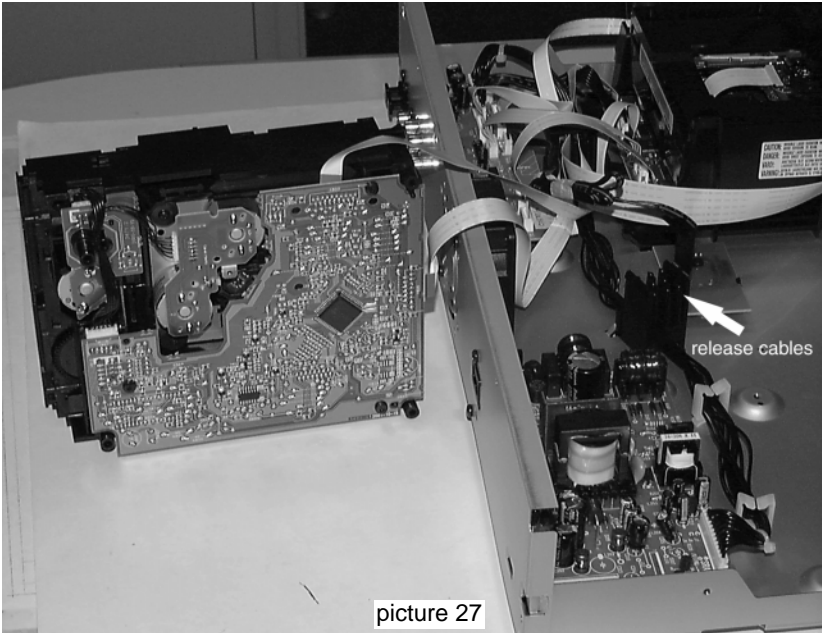

picture 27

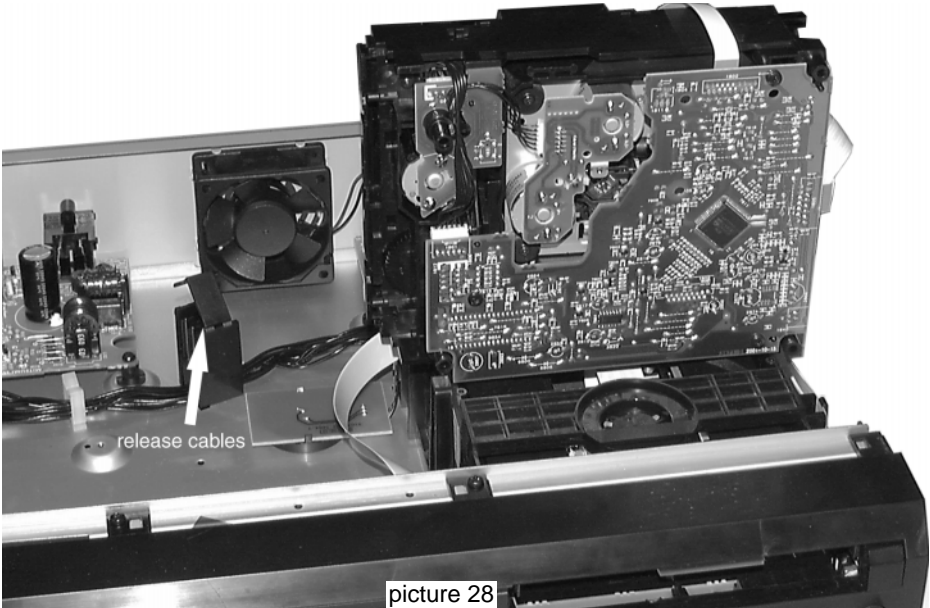

picture 28

Service position *CDR Module*

For dismantling instructions see chapter 4-5.

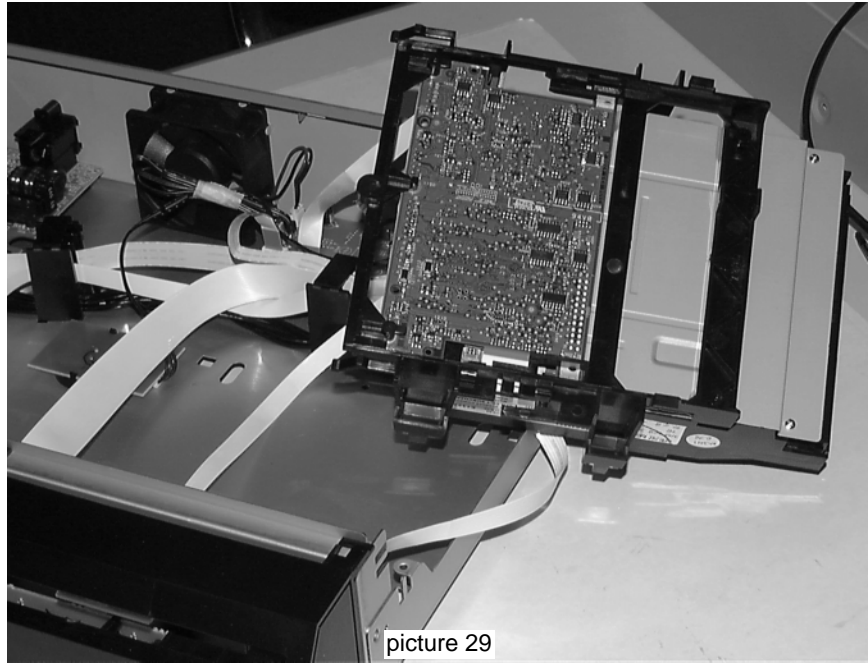

**Service position *MOZART Board*
(Back-end)**

For dismantling instructions see chapter 4-6.

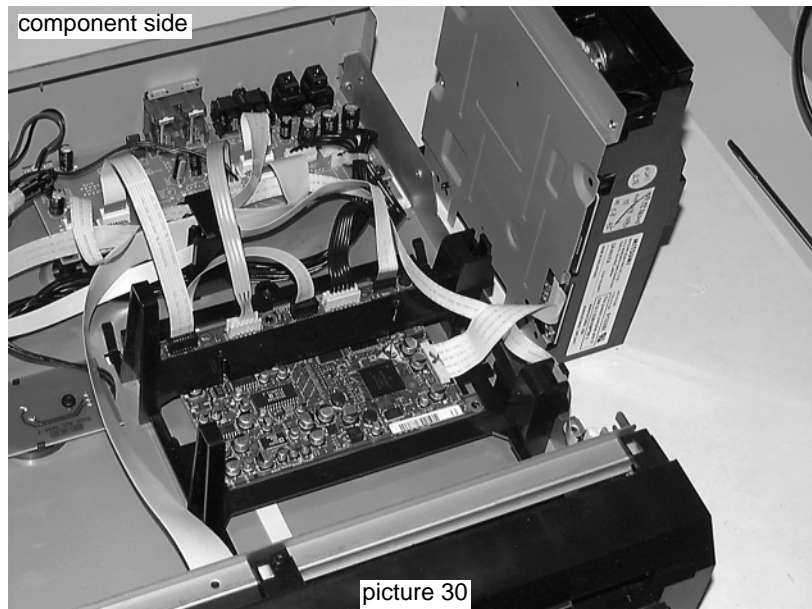

copper side

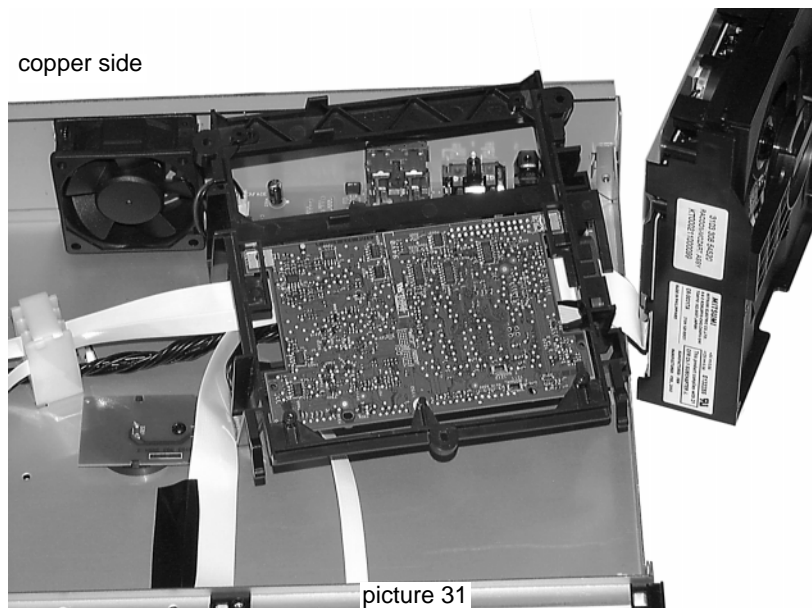

Service position *Power Board*

For dismantling instructions of the top cover see chapter 4-1.
 All important measurements can be carried out from the component side without any further dismantling.

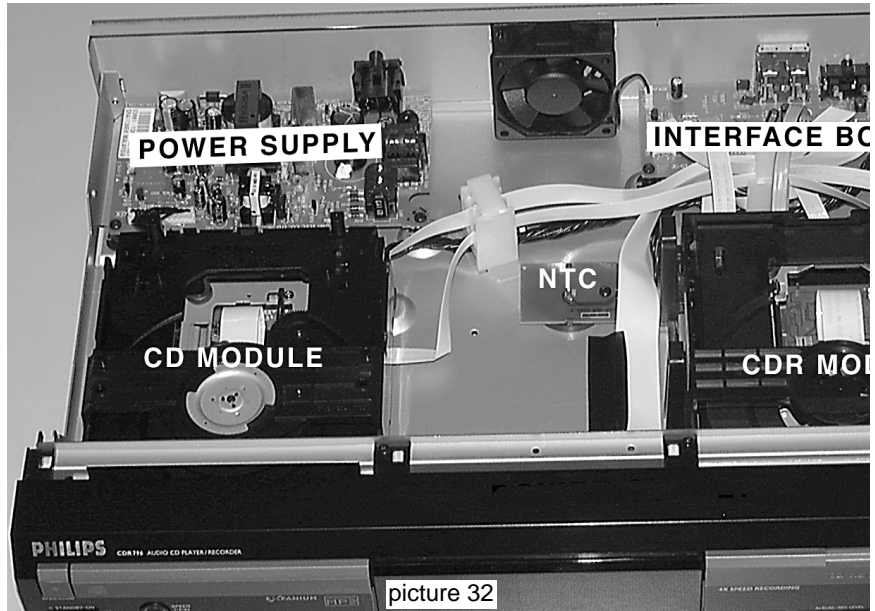

Service position *Interface Board*

For dismantling instructions of the top cover see chapter 4-1.
 Component side is now accessible without any further dismantling.

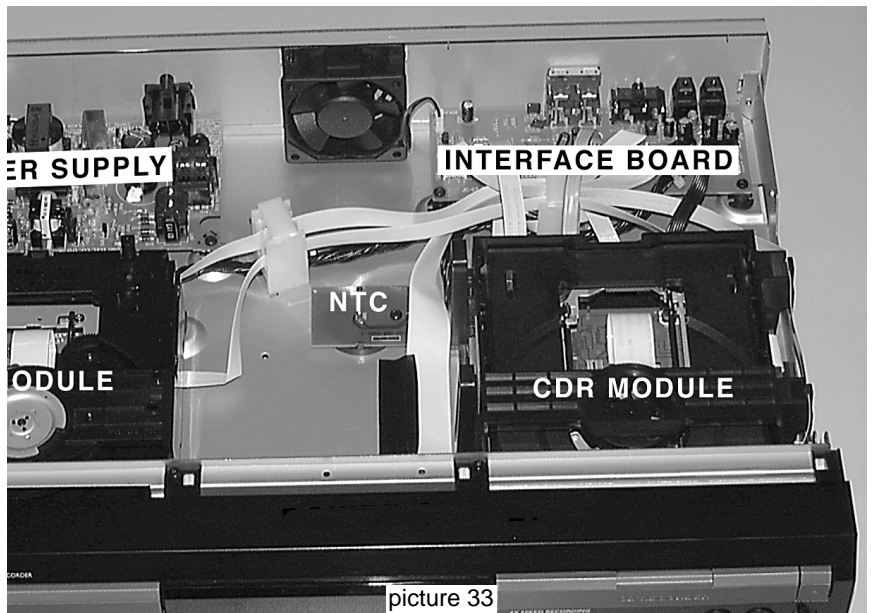

To get access to the copper side the board has to be dismantled and turned to service position as shown in picture 34.
 For dismantling instructions see chapter 4-8.

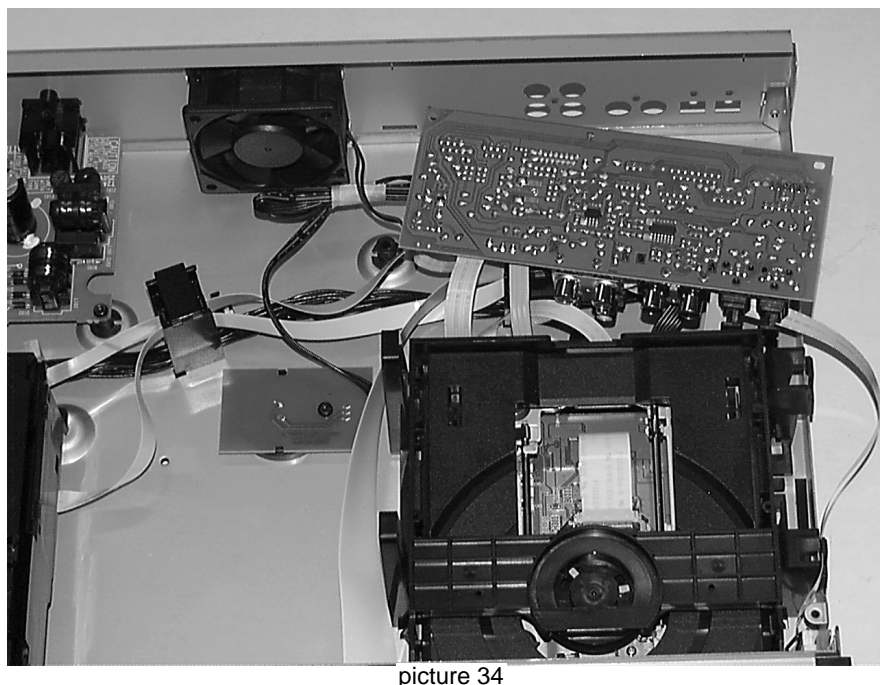

Personal Notes:

SERVICE TESTPROGRAM VARIOUS TESTS

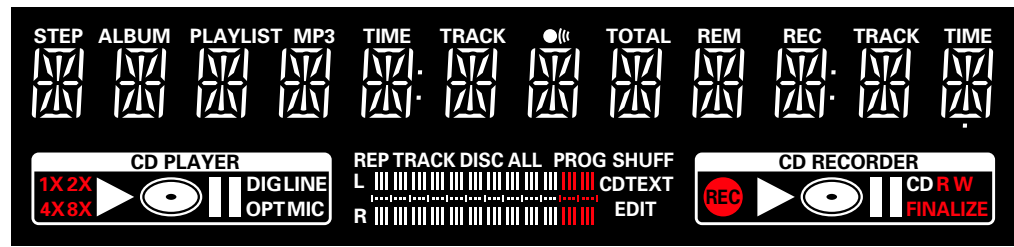
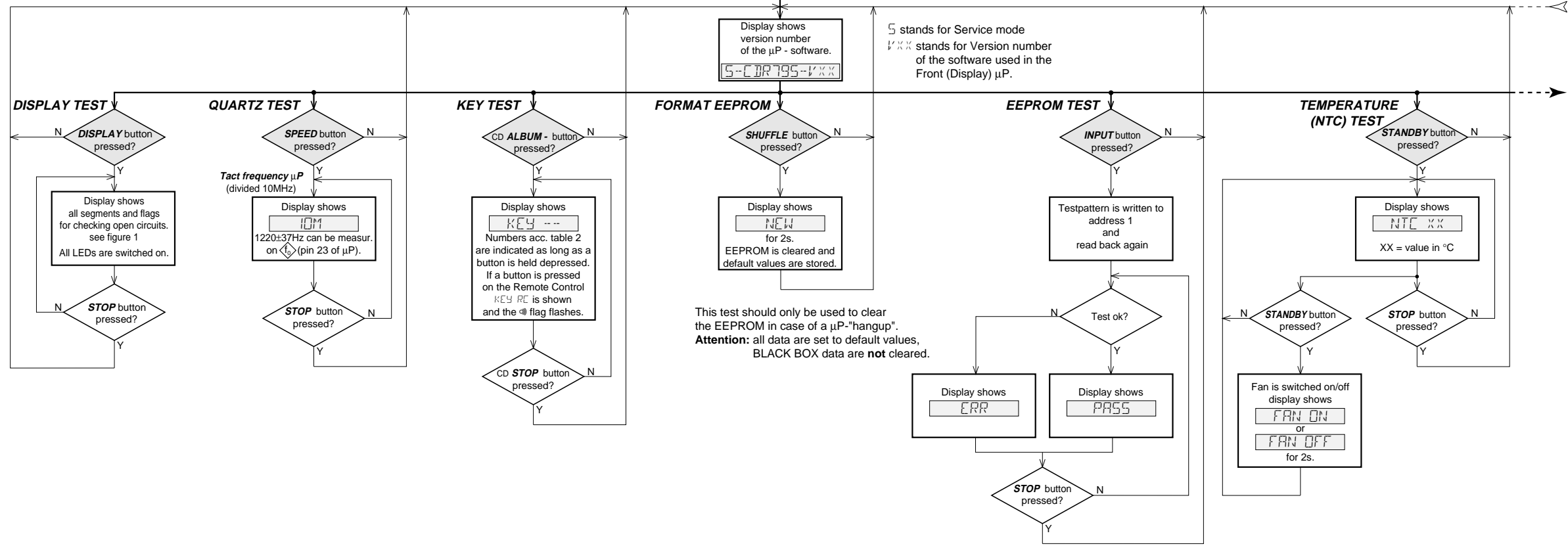
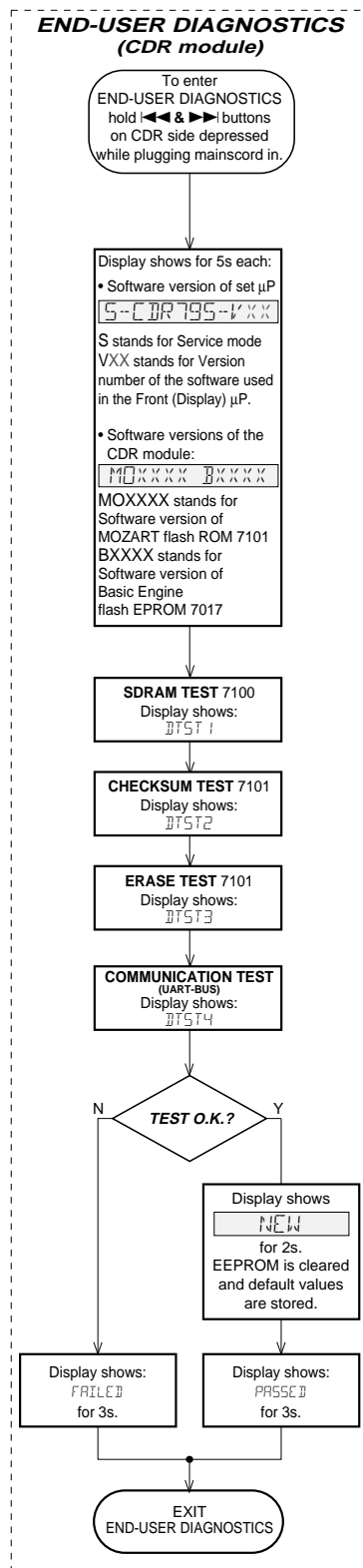

fig. 1

KEY CODES

KEY	KEY CODE	KEY	KEY CODE
OPEN/CLOSE (CD)	0	ERASE CD	12
STANDBY	1	PLAY/PAUSE (CDR)	13
SPEED	2	STOP (CDR)	14
PLAY/PAUSE (CD)	3	ALBUM - (CDR)	15
STOP (CD)	4 (exit)	ALBUM + (CDR)	16
ALBUM - (CD)	5	◀▶ (CDR)	17
ALBUM + (CD)	6	▶▶ (CDR)	18
◀▶ (CD)	7	RECORD	19
▶▶ (CD)	8	COPY CD	20
DISPLAY	9	OPEN/CLOSE (CDR)	21
SHUFFLE	10		
INPUT	11		

table 2

SERVICE TESTPROGRAM
CDR MODULE

- * To leave Service Testprogram plug mains cord off.
- * In the main menu the sound settings (volume, ...) and trays work as in normal mode.

To enter Service Testprogram hold **PLAY & REC** buttons depressed while plugging mainscord in.

5 stands for Service mode
VXXX stands for Version number of the software used in the Front (Display) µP.

Display shows version number of the µP - software.
5-CDR795-VXX

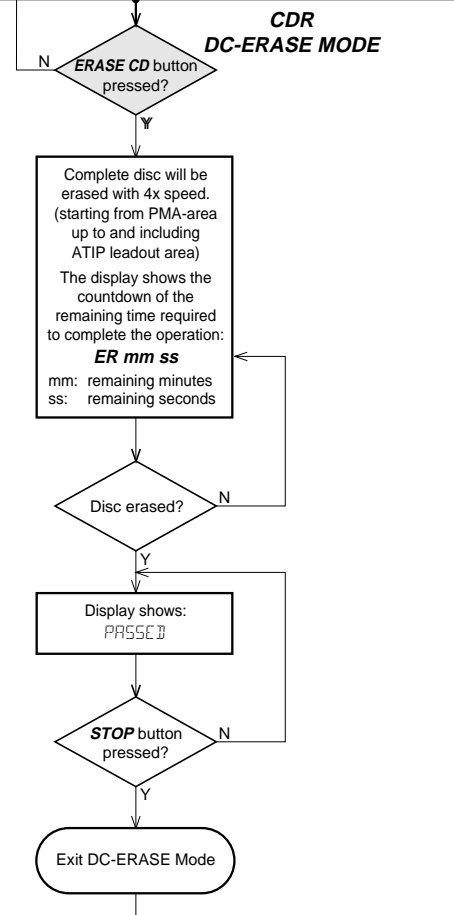
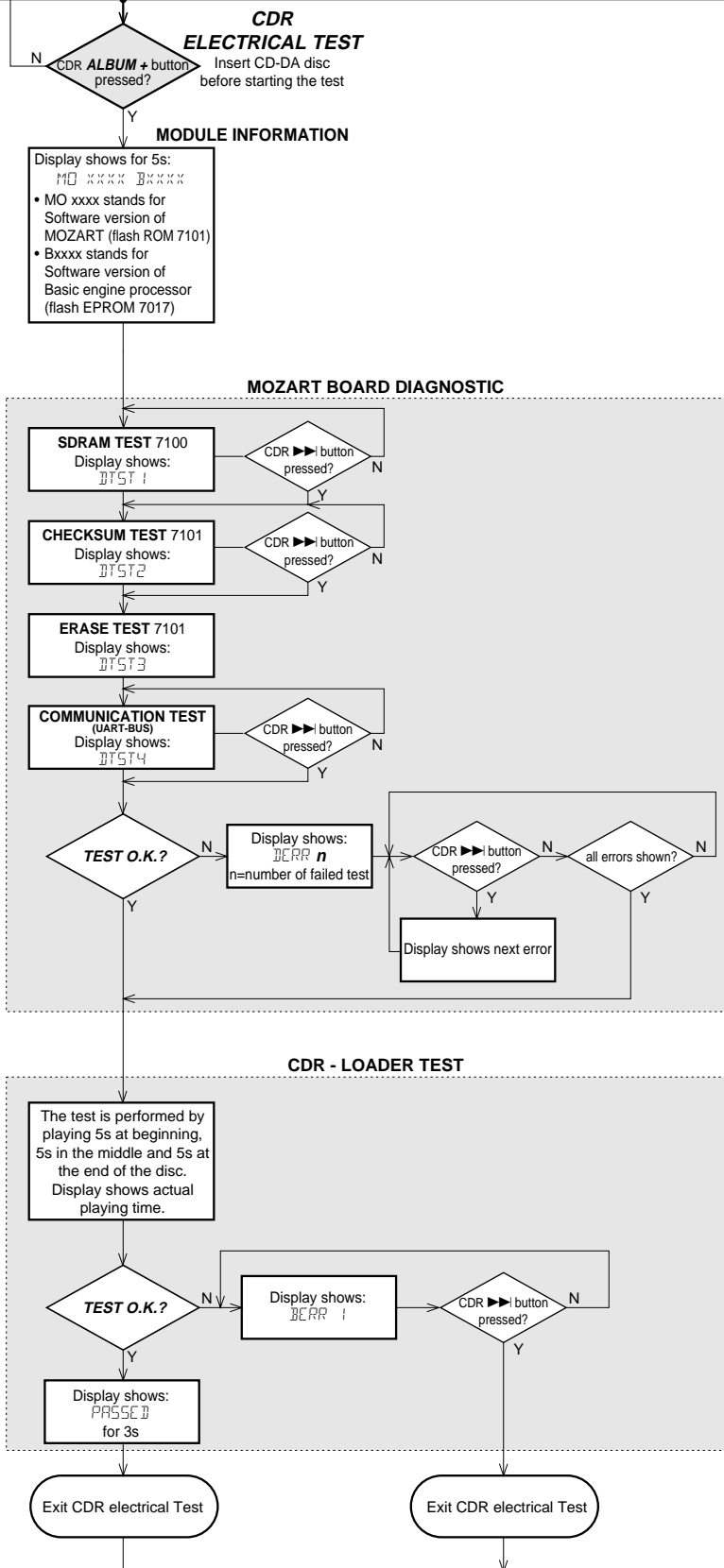

Note: With the DC-Erase mode the CD-RW can be changed back in its original state, like a new disc. Stopping the erase-function by switching power off will leave the disc in an unpredictable status!

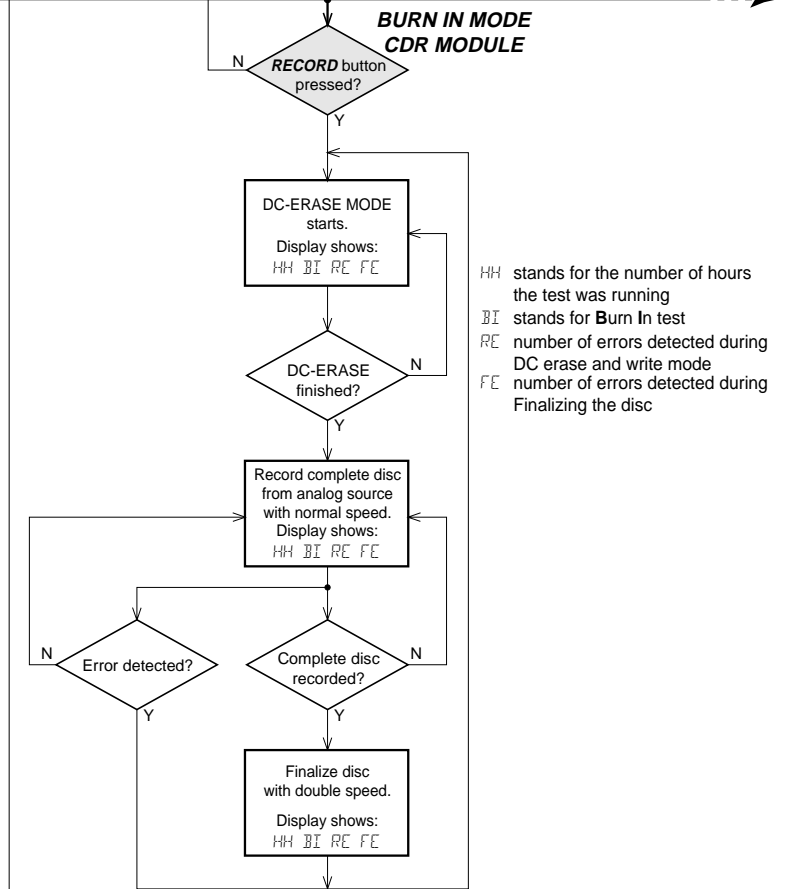

HH stands for the number of hours the test was running
BI stands for Burn In test
RE number of errors detected during DC erase and write mode
FE number of errors detected during Finalizing the disc

Note: The BURN-IN mode is an endless cycle of
* DC erase, to erase the CD-RW disc with max. laser power
* Recording a CD-RW disc with speed N=1
* and Finalizing with double speed
This test is intended to check the quality of a CDR loader and to detect intermittent failures.

SERVICE TESTPROGRAM
CD MODULE

To enter Service Testprogram hold **PLAY & REC** buttons depressed while plugging mains cord in.

- * To leave Service Testprogram plug mains cord off.
- * In the main menu the sound settings (volume, ...) and trays work as in normal mode.

Display shows version number of the P - software.
S-CDR795-VXX

S stands for Service mode
VXX stands for Version number of the software used in the Front (Display) P.

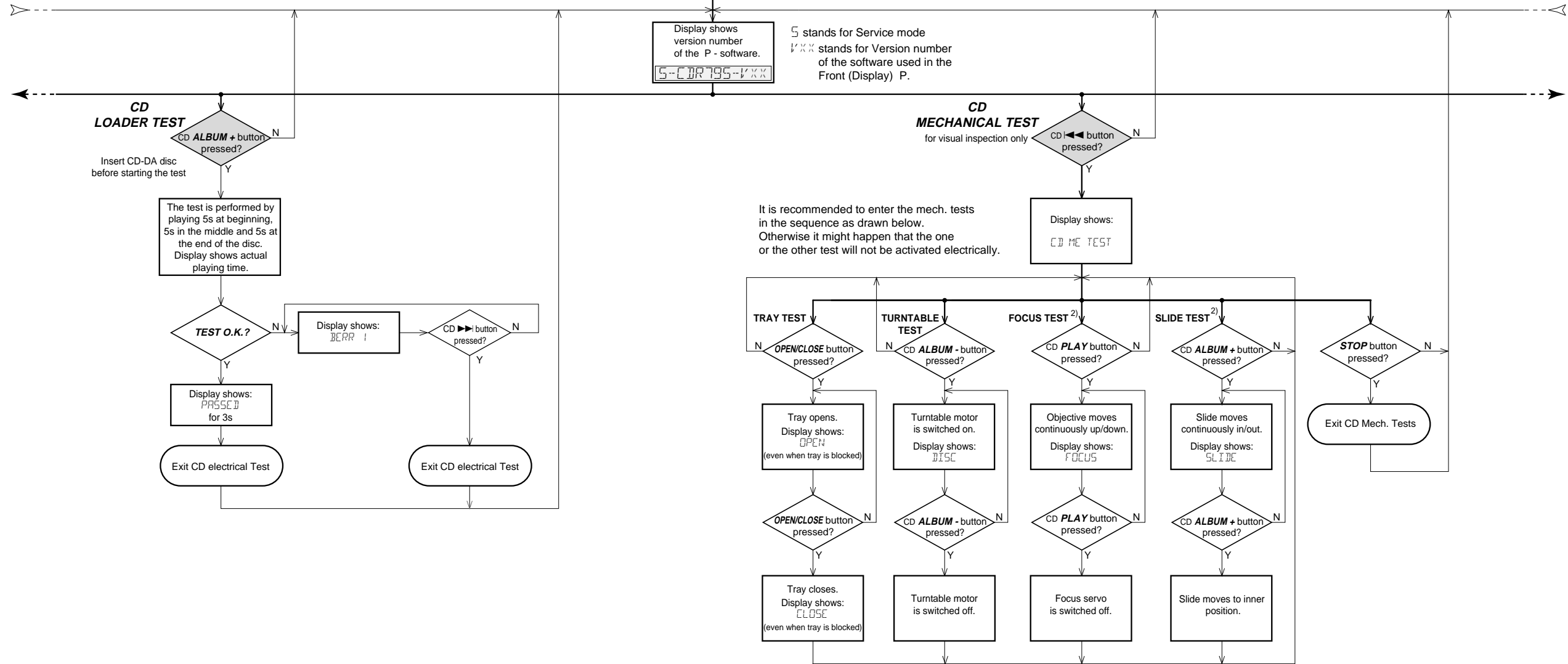

²⁾ Move slide manually backwards to get view of the pickup.

BLOCK DIAGRAM

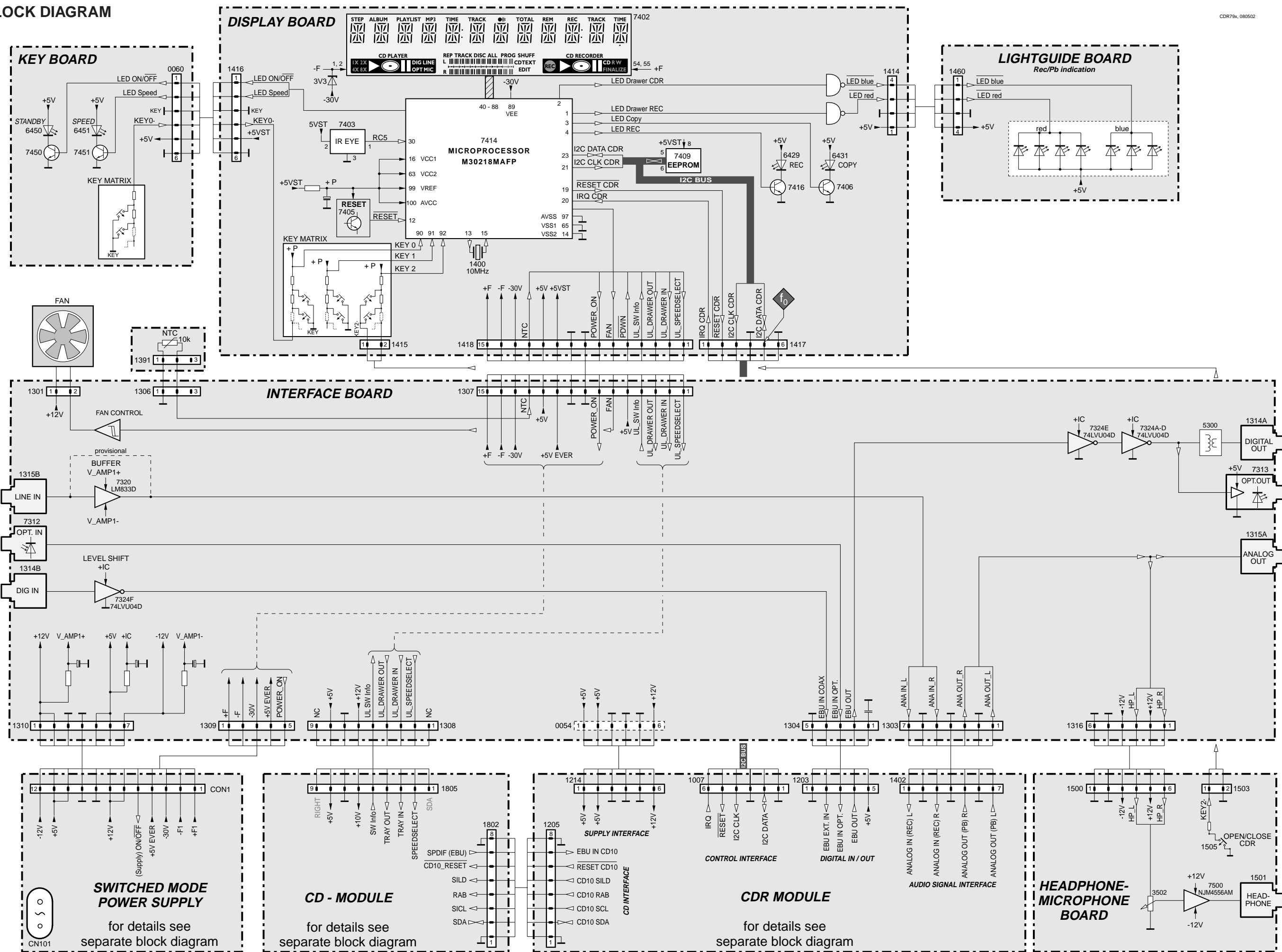

BLOCK DIAGRAM CDR MODULE

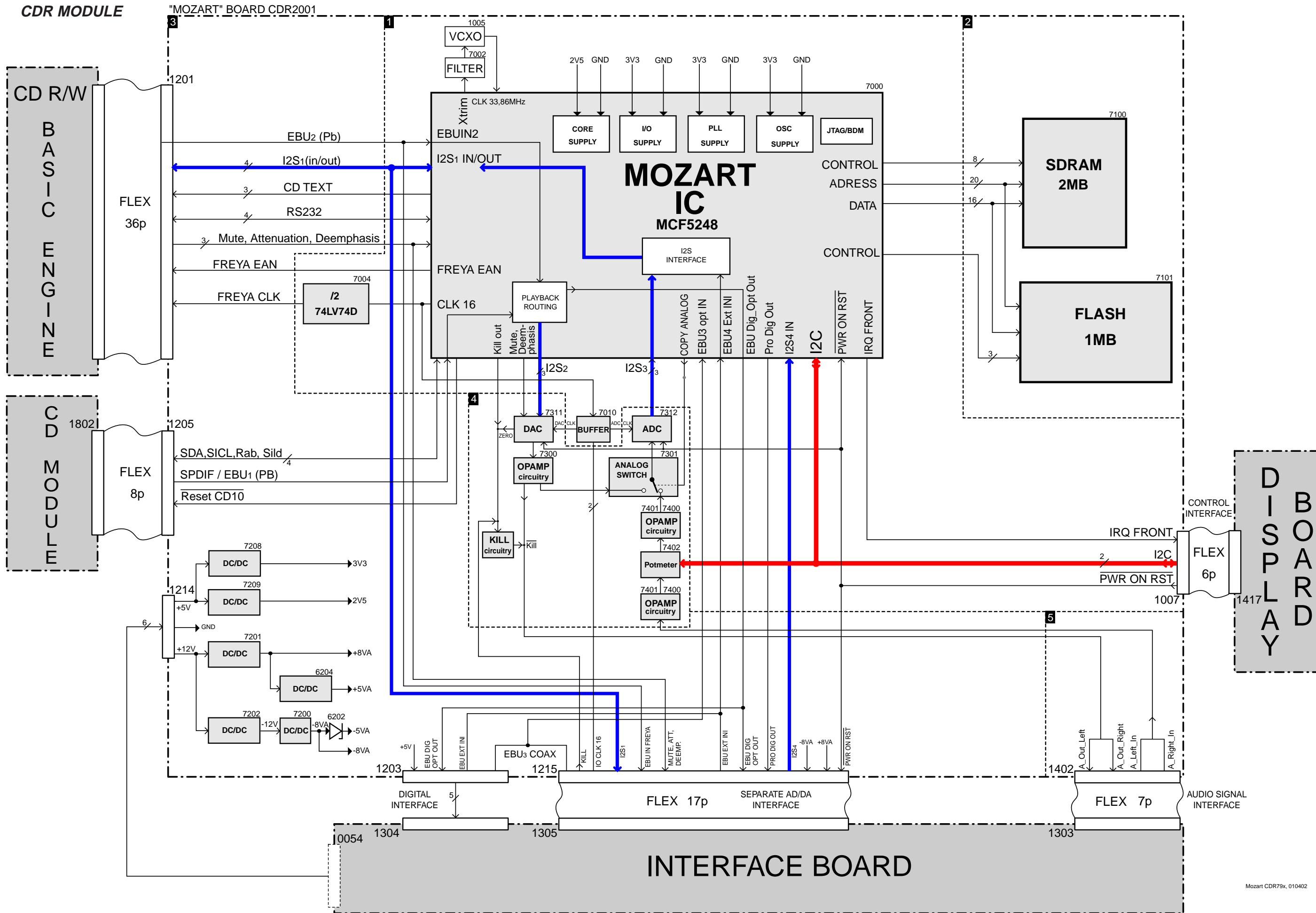

BLOCK DIAGRAM CD MODULE

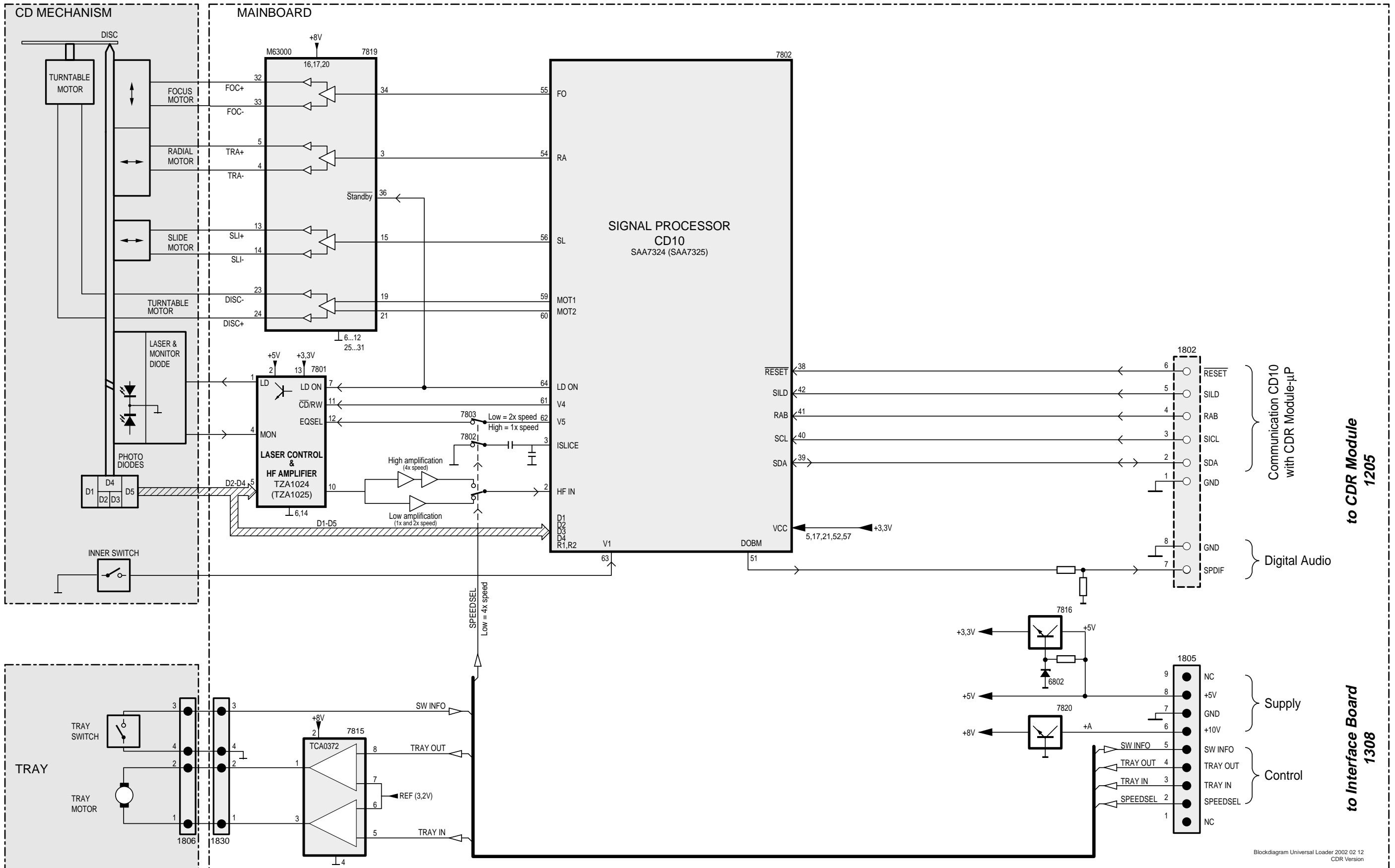

WIRING DIAGRAM

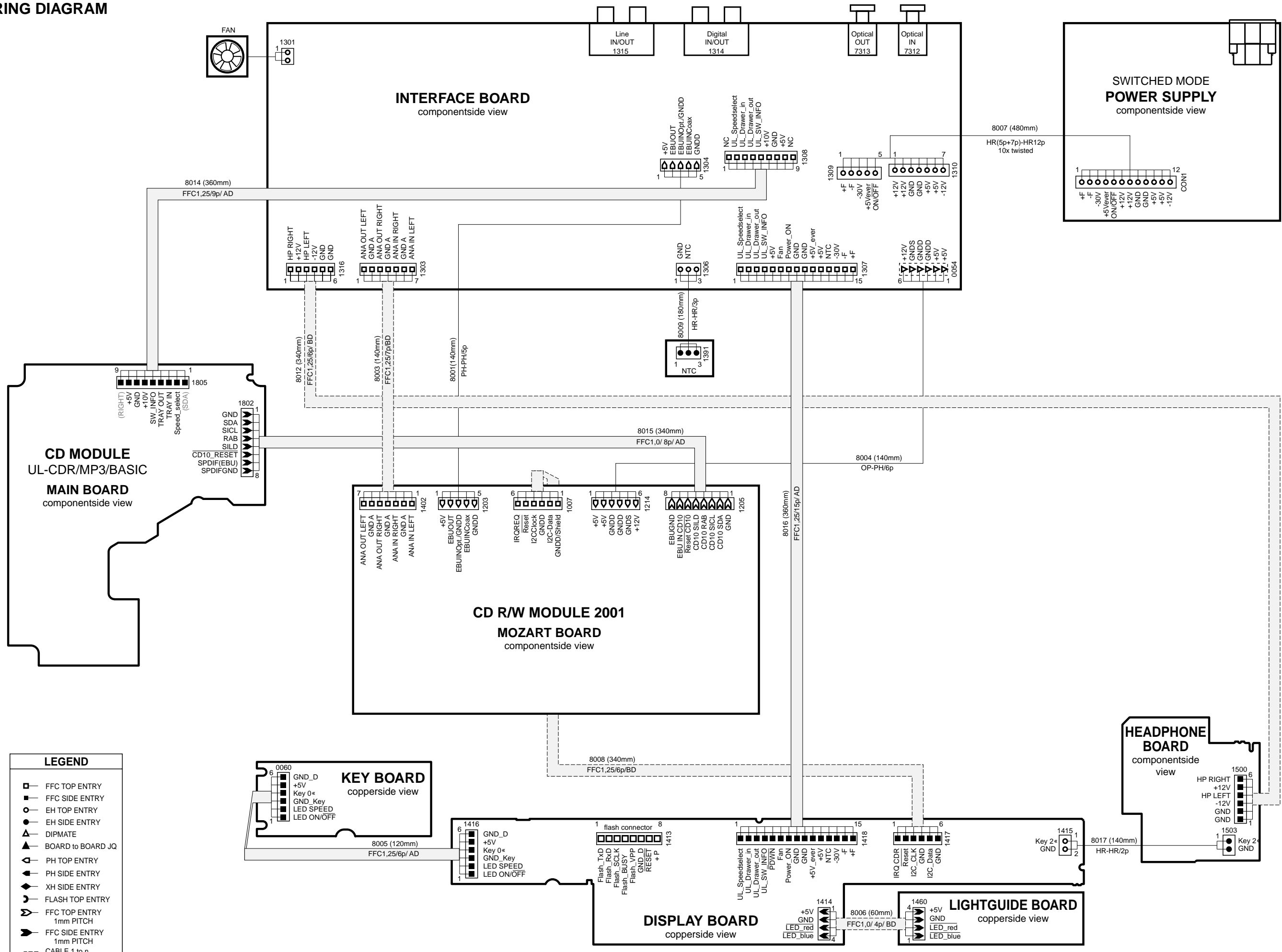

LEGEND	
□	FFC TOP ENTRY
■	FFC SIDE ENTRY
○	EH TOP ENTRY
●	EH SIDE ENTRY
▲	DIPMATE
△	BOARD to BOARD JQ
◁	PH TOP ENTRY
▷	PH SIDE ENTRY
◀	XH SIDE ENTRY
▶	FLASH TOP ENTRY
↔	FFC TOP ENTRY 1mm PITCH
↔	FFC SIDE ENTRY 1mm PITCH
---	CABLE 1 to n

For service code numbers of flexfoil cables see mechanical partslist.

Switched Mode Power Supply / EU + USA version (/00/17)

for orientation only

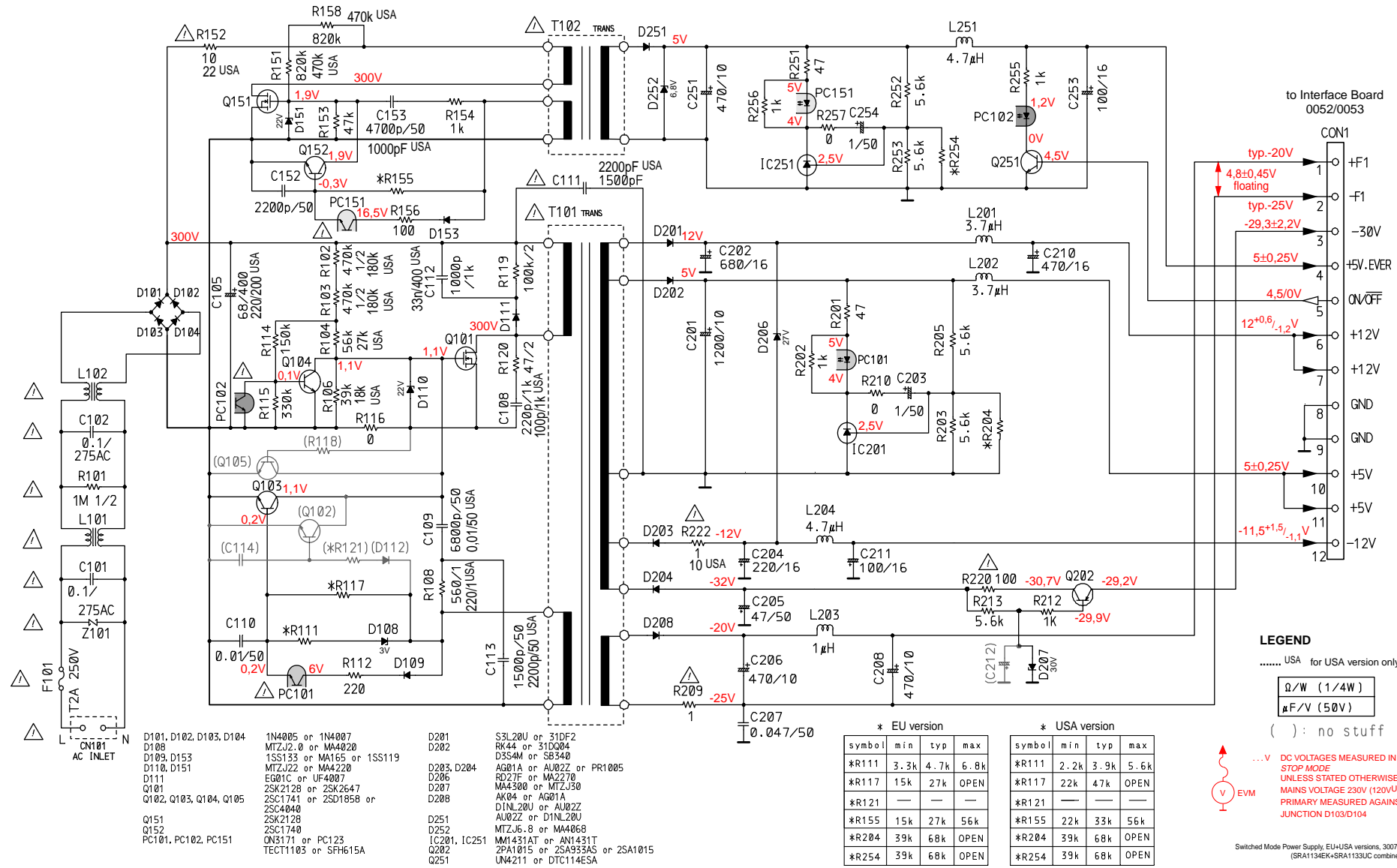

POWER BOARD / component side view
USA and European version

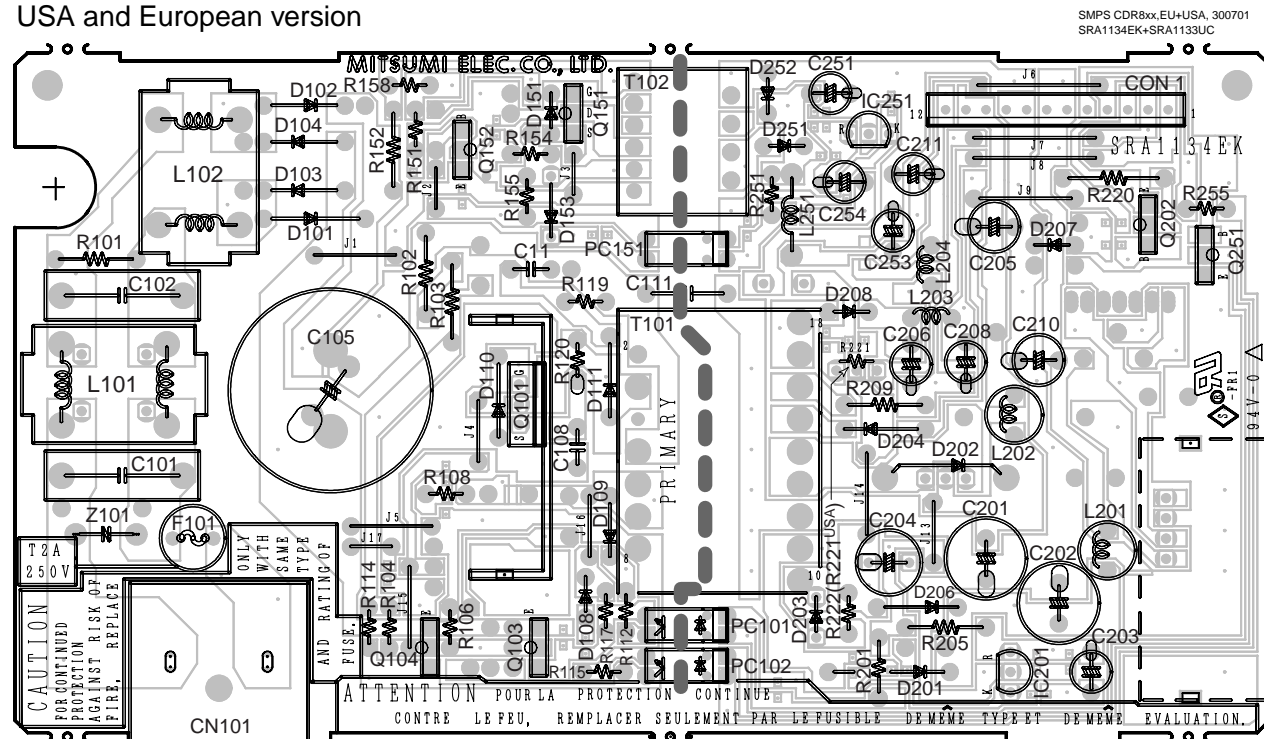

POWER BOARD / copper side view
USA and European version

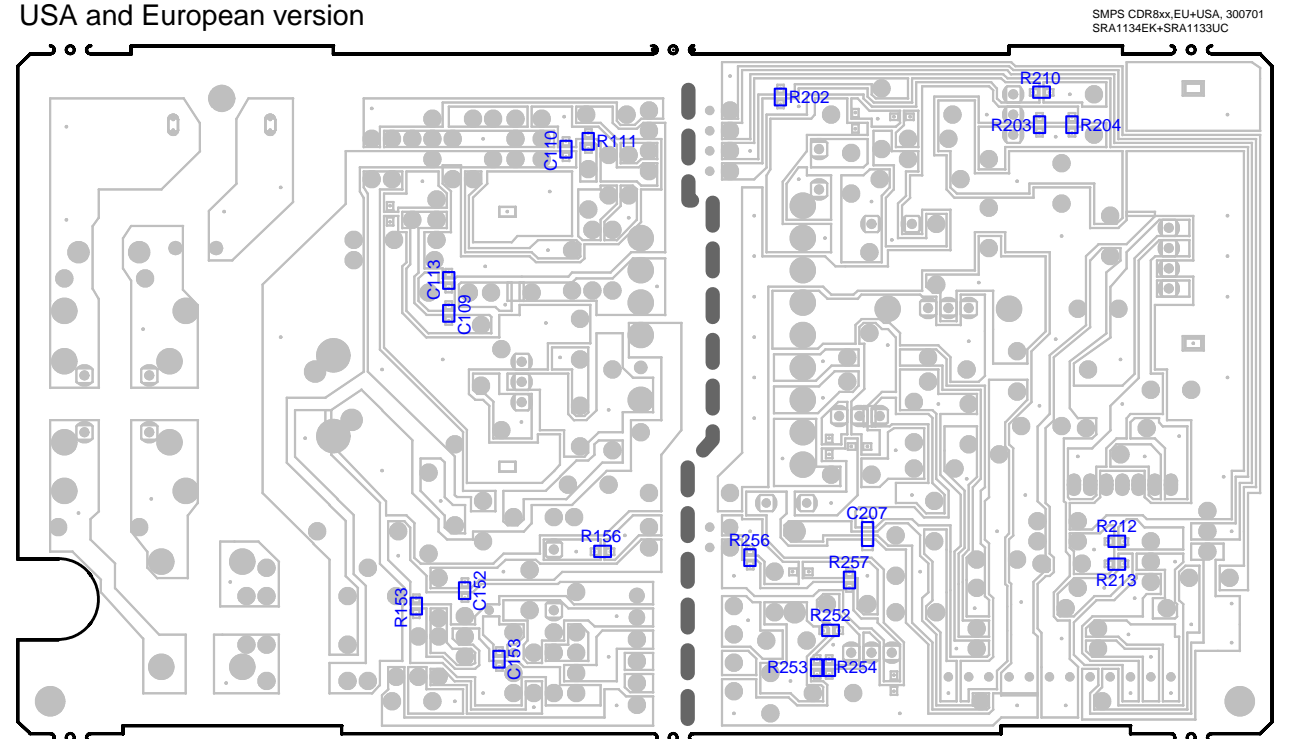

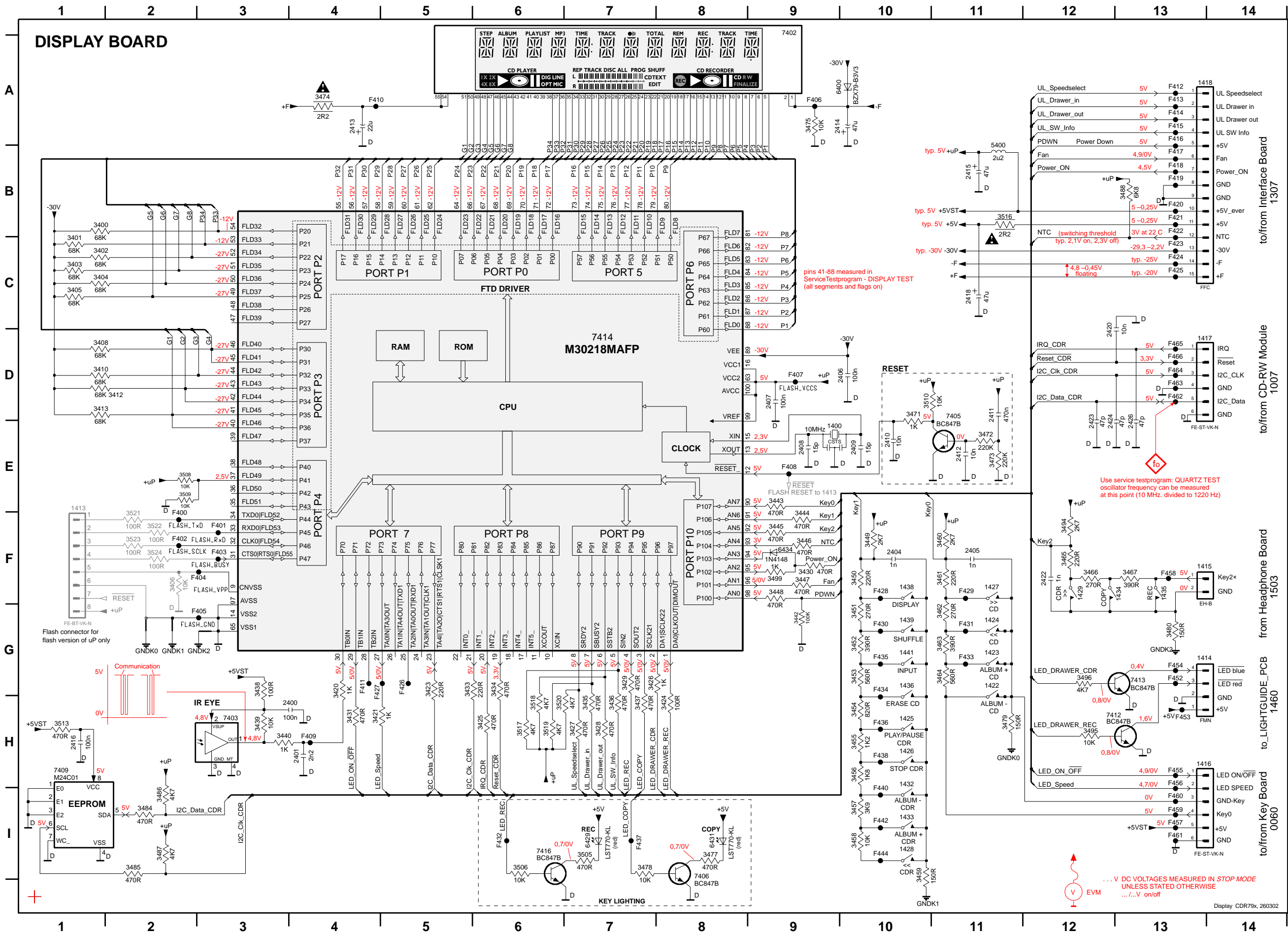

DISPLAY BOARD

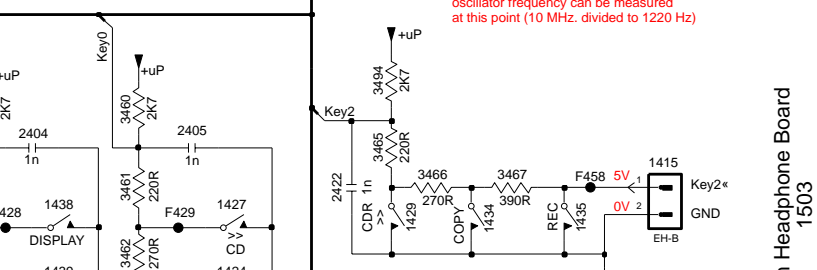
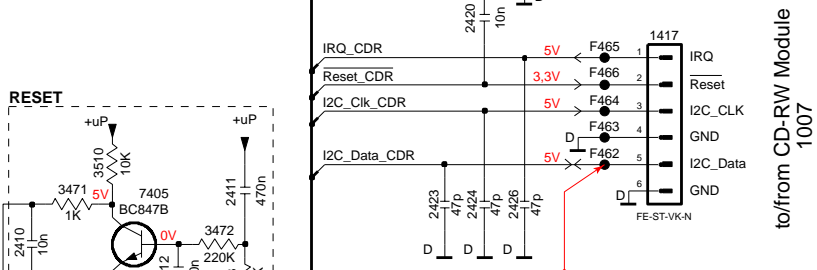
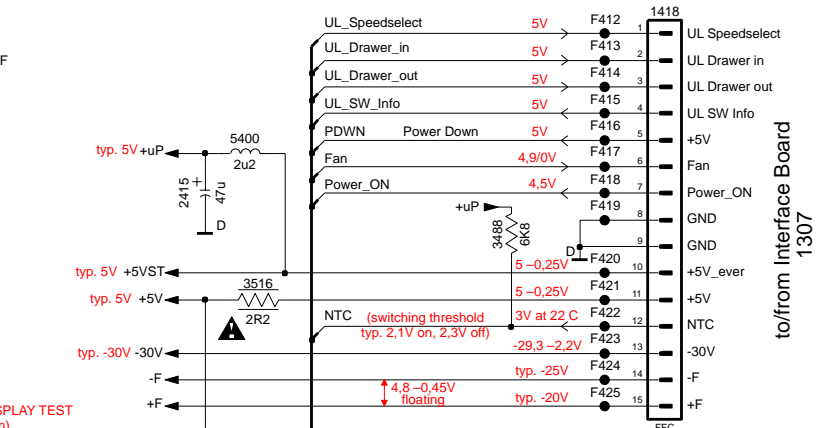

- 1400 E9
- 1413 F1
- 1414 G1
- 1415 F13
- 1416 H13
- 1417 D13
- 1418 A13
- 1422 G11
- 1423 G11
- 1424 G11
- 1425 H10
- 1426 H10
- 1427 F11
- 1428 H10
- 1429 F12
- 1430 I10
- 1431 F13
- 1432 H10
- 1433 I10
- 1434 F13
- 1435 F13
- 1436 G10
- 1438 F10
- 1439 G10
- 1441 G10
- 2401 H4
- 2404 F10
- 2405 F11
- 2406 D10
- 2407 D9
- 2408 E9
- 2409 E10
- 2410 E10
- 2411 D11
- 2412 E11
- 2413 A4
- 2414 A9
- 2415 B11
- 2416 H1
- 2418 C11
- 2420 D12
- 2422 F12
- 2423 E12
- 2424 D12
- 2426 D13
- 3400 B1
- 3401 C1
- 3402 C1
- 3403 C1
- 3404 C1
- 3405 C1
- 3406 F2
- 3408 D1
- 3410 D1
- 3412 D2
- 3413 D1
- 3420 G4
- 3421 H4
- 3423 G5
- 3424 H8
- 3425 H6
- 3426 H7
- 3427 H7
- 3428 H7
- 3429 G7
- 3430 F9
- 3431 H4
- 3433 G5
- 3434 G6
- 3435 H7
- 3436 H7
- 3437 H7
- 3438 G3
- 3439 H3
- 3440 H3
- 3442 G9
- 3443 E9
- 3444 F9
- 3445 F9
- 3446 F9
- 3447 F9
- 3448 F9
- 3449 F10
- 3450 F10
- 3451 G10
- 3452 G10
- 3453 G10
- 3454 H10
- 3455 H10
- 3456 H10
- 3457 I10
- 3458 I10
- 3460 F11
- 3461 F11
- 3462 G11
- 3463 G11
- 3464 G11
- 3465 F12
- 3466 F12
- 3467 F13
- 3471 D10
- 3472 E11
- 3473 E11
- 3474 A4
- 3475 A9
- 3477 I8
- 3478 I7
- 3479 H11
- 3480 G13
- 3484 I2
- 3485 I2
- 3486 I2
- 3487 I2
- 3488 B13
- 3494 F12
- 3495 H12
- 3496 G12
- 3499 F9
- 3505 I7
- 3506 I6
- 3508 E2
- 3509 E2
- 3510 D10
- 3513 H1
- 3516 B11
- 3517 H6
- 3518 H6
- 3519 H6
- 3520 H6
- 3521 F2
- 3522 F2
- 3523 F2
- 3524 F2
- 5400 B11
- 6400 A10
- 6429 I7
- 6431 I8
- 6434 F9
- 7402 A9
- 7403 H3
- 7405 D11
- 7406 I8
- 7409 H1
- 7412 H12
- 7413 G13
- 7414 B8
- 7416 I6
- F402 F2
- F401 F3
- F402 F2
- F403 F3
- F404 F3
- F405 G9
- F406 A9
- F407 D9
- F408 E9
- F409 H4
- F410 A4
- F411 G4
- F412 A13
- F413 A13
- F414 A13
- F415 A13
- F416 A13
- F417 B13
- F418 B13
- F419 B13
- F420 B13
- F421 B13
- F422 B13
- F423 C13
- F424 C13
- F425 C13
- F426 G5
- F427 G4
- F428 F10
- F429 F11
- F430 G10
- F431 G11
- F432 I6
- F433 G11
- F434 G10
- F435 G10
- F436 H10
- F437 I7
- F438 H10
- F440 I10
- F442 I10
- F444 I10
- F452 G13
- F453 H13
- F454 G13
- F455 H13
- F456 H13
- F457 I13
- F458 F13
- F459 I13
- F460 I13
- F461 I13
- F462 D13
- F463 D13
- F464 D13
- F465 D13
- F466 D13

... V DC VOLTAGES MEASURED IN STOP MODE UNLESS STATED OTHERWISE ... V on/off

2400 B4	2407 A7	2412 B6	2424 A13	3403 C6	3410 C6	3423 B6	3428 A6	3434 B6	3439 B4	3445 B8	3450 A6	3455 A12	3460 A5	3465 A16	3473 B5	3480 B8	3488 B8	3508 A5	3518 A6	3523 A5	4405 B5	4411 A5	7409 B5
2401 B5	2408 B6	2416 B5	2426 A13	3404 C6	3412 C5	3424 A7	3429 A7	3435 A6	3440 B4	3446 B7	3451 A6	3456 A13	3461 A3	3466 A16	3475 B10	3484 B5	3494 B8	3509 A5	3519 B6	3524 A5	4406 A5	6429 B16	7412 C10
2404 A7	2409 B6	2420 A13	3400 C7	3405 C6	3413 C5	3425 B6	3430 B9	3436 A6	3442 B9	3447 A7	3452 A7	3457 A14	3462 A3	3467 A16	3477 A16	3485 B5	3499 B7	3510 B6	3520 B6	4401 A7	4408 A12	6431 B16	7413 C10
2405 A4	2410 A6	2422 A16	3401 C7	3406 A5	3420 B6	3426 A7	3431 B5	3437 A7	3443 B8	3448 A7	3453 A9	3458 A14	3463 A2	3471 A6	3478 B16	3486 B5	3505 B15	3513 B5	3521 A4	4402 A8	4409 B8	7405 A6	7414 B7
2406 B8	2411 A5	2423 A13	3402 C6	3408 C6	3421 B6	3427 A6	3433 B6	3438 B4	3444 B7	3449 B8	3454 A11	3459 A6	3464 A1	3472 A5	3479 A5	3487 B5	3506 B15	3517 A6	3522 A4	4404 B6	4410 A16	7406 B16	7416 B15

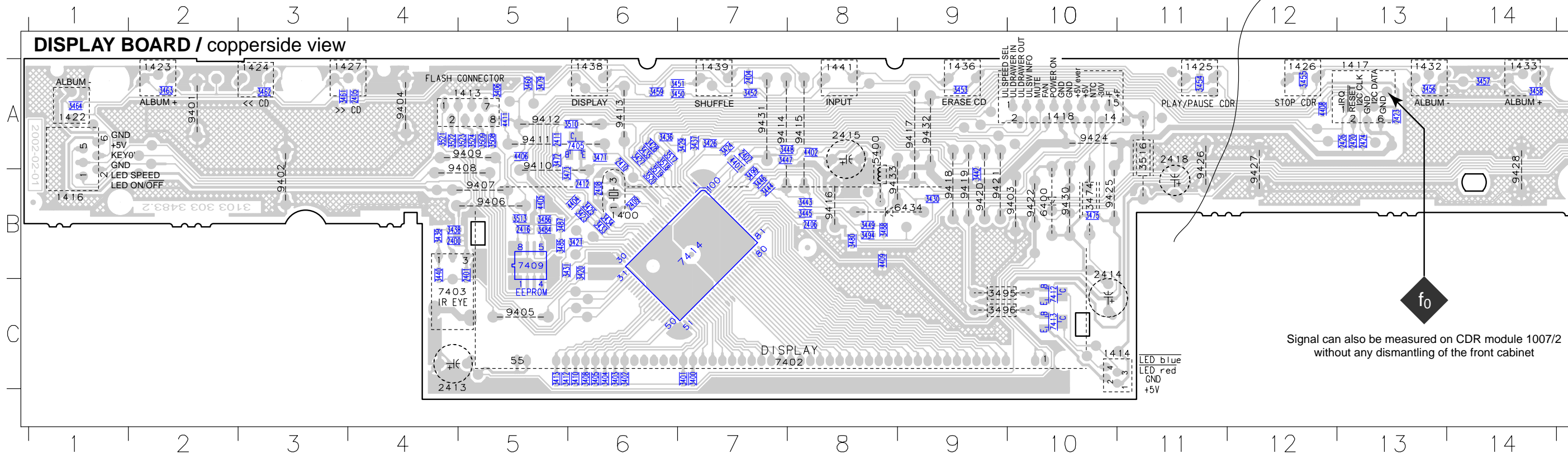

1400 B6	1416 B1	1423 A2	1427 A3	1433 A14	1438 A6	2414 C10	3495 C9	6400 B10	9401 A2	9405 C5	9409 A5	9413 A6	9417 A9	9421 B9	9426 A11	9431 A7
1413 A5	1417 A13	1424 A3	1428 A15	1434 A16	1439 A7	2415 A8	3496 C9	6434 B8	9402 B3	9406 B5	9410 B5	9414 A7	9418 B9	9422 B10	9427 B12	9432 A9
1414 C11	1418 A10	1425 A11	1429 A16	1435 A15	1441 A8	2418 A11	3516 A11	7402 C7	9403 B10	9407 B5	9411 A5	9415 A8	9419 B9	9424 A10	9428 B14	9433 B9
1415 A16	1422 A1	1426 A12	1432 A13	1436 A9	2413 C4	3474 B10	5400 B8	7403 C4	9404 A4	9408 B5	9412 A5	9416 B8	9420 B9	9425 B10	9430 B10	

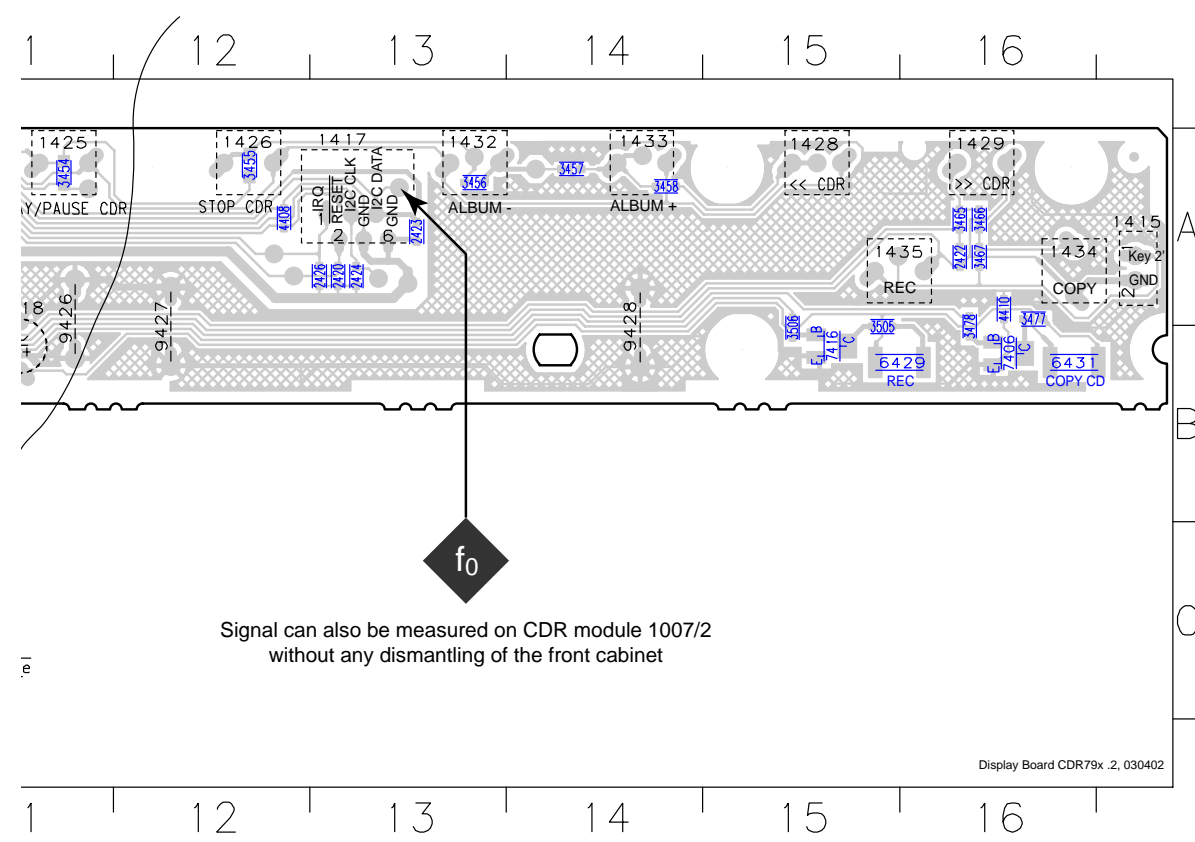

DISPLAY GRID ASSIGNMENT

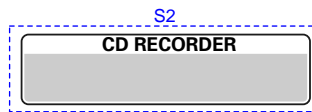
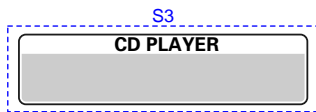
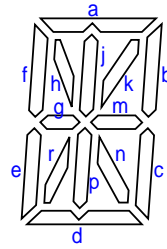
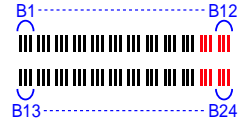
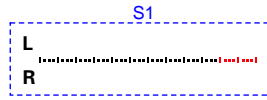
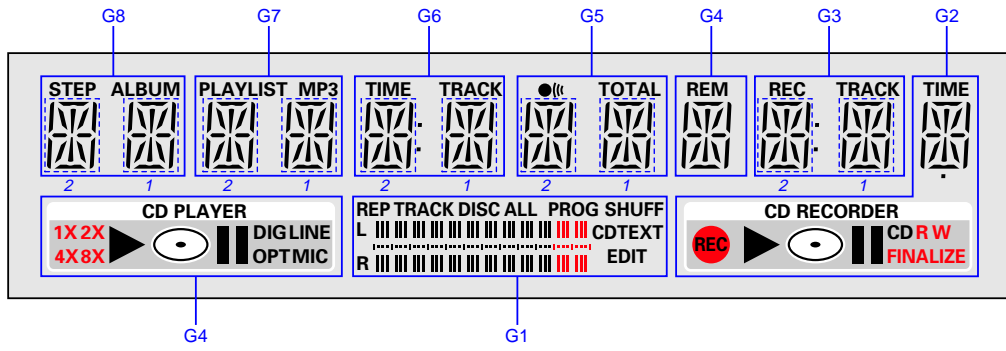

Pin		44	45	46	47	48	49	50	51
		G8	G7	G6	G5	G4	G3	G2	G1
5	P1	2d	2d	2d	2d	LINE	2d	-	B1
6	P2	2n	2n	2n	2n	MIC	2n	REC	B2
7	P3	2p	2p	2p	2p	DIG	2p	▶	B3
8	P4	2r	2r	2r	2r	OPT	2r	FINALIZE	B4
9	P5	2e	2e	2e	2e		2e		B5
10	P6	2c	2c	2c	2c	○	2c	○	B6
11	P7	2g	2g	2g	2g	○	2g	○	B7
12	P8	2m	2m	2m	2m	▶	2m	-	B8
13	P9	2f	2f	2f	2f	2X	2f	W	B9
14	P10	2b	2b	2b	2b	1X	2b	R	B10
15	P11	2k	2k	2k	2k	8X	2k	CD	B11
16	P12	2j	2j	2j	2j	4X	2j	-	B12
17	P13	2h	2h	2h	2h	S3	2h	S2	S1
18	P14	2a	2a	2a	2a	-	2a	-	B13
19	P15	-	-	•	-	-	•	•	B14
20	P16	1d	1d	1d	1d	d	1d	d	B15
21	P17	1n	1n	1n	1n	n	1n	n	B16
22	P18	1p	1p	1p	1p	p	1p	p	B17
23	P19	1r	1r	1r	1r	r	1r	r	B18
24	P20	1e	1e	1e	1e	e	1e	e	B19
25	P21	1c	1c	1c	1c	c	1c	c	B20
26	P22	1g	1g	1g	1g	g	1g	g	B21
27	P23	1m	1m	1m	1m	m	1m	m	B22
28	P24	1f	1f	1f	1f	f	1f	f	B23
29	P25	1b	1b	1b	1b	b	1b	b	B24
30	P26	1k	1k	1k	1k	k	1k	k	REP
31	P27	1j	1j	1j	1j	j	1j	j	TRACK
32	P28	1h	1h	1h	1h	h	1h	h	DISC
33	P29	1a	1a	1a	1a	a	1a	a	ALL
34	P30	STEP	MP3	TRACK	TOTAL	REM	TRACK	TIME	PROG
35	P31	ALBUM	PLAYLIST	TIME	🔊	-	REC	-	SHUFF
36	P32	-	-	-	-	-	-	-	CD
37	P33	-	-	-	-	-	-	-	TEXT
38	P34	-	-	-	-	-	-	-	EDIT

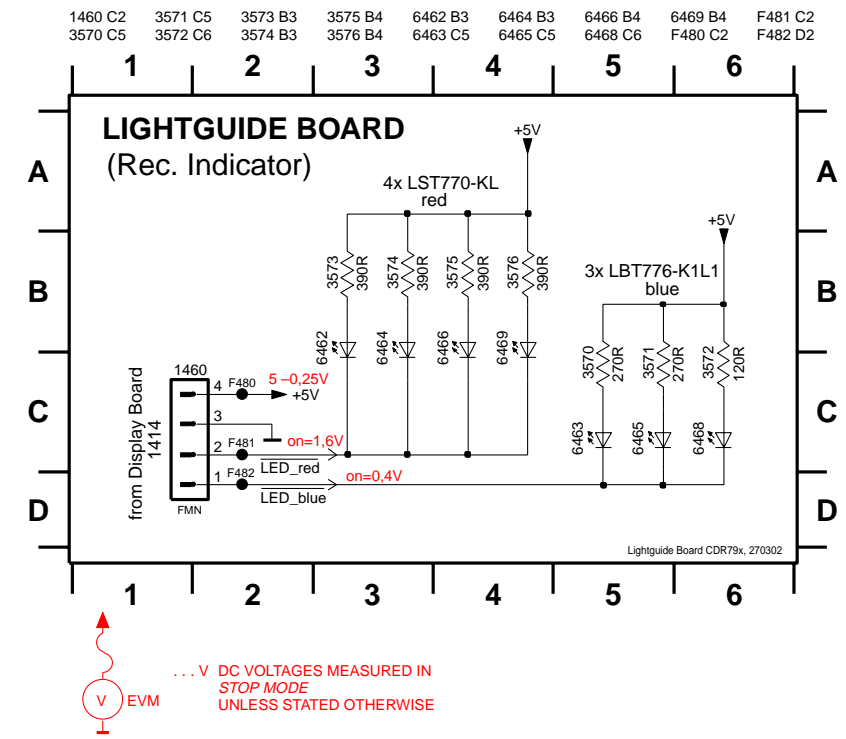
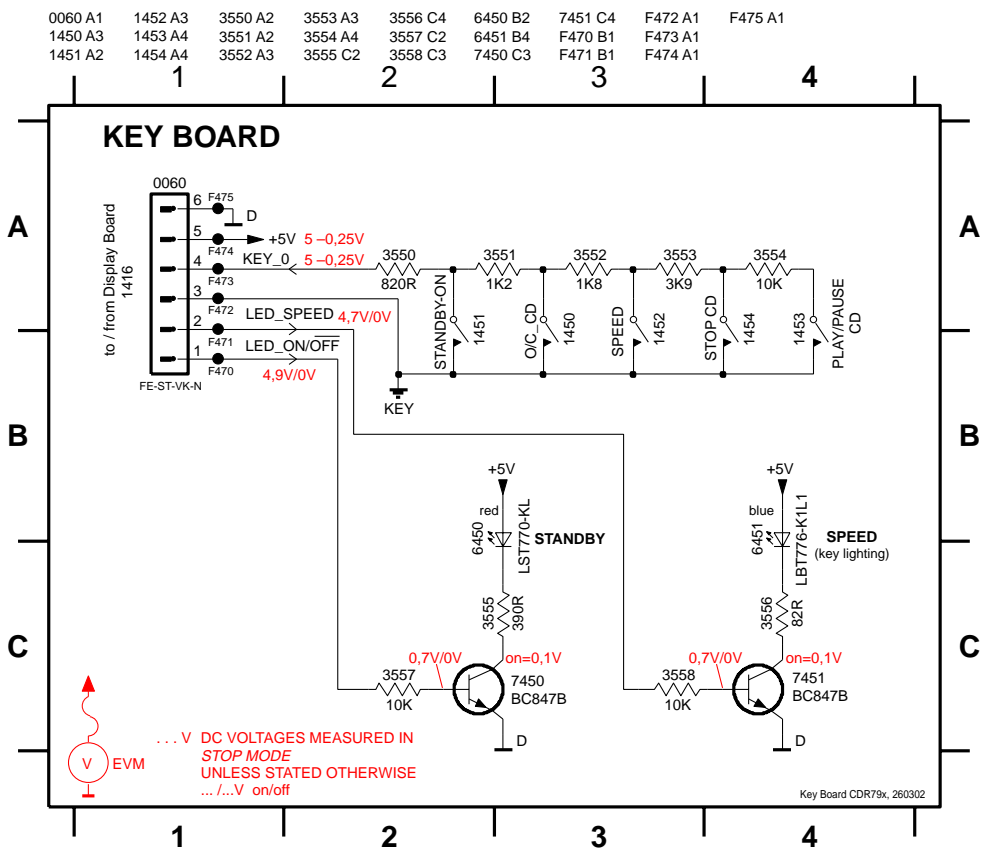

0060 A1	1452 A3	3550 A2	3553 A3	3556 B3	6450 B2	7451 A3
1450 B1	1453 A3	3551 B2	3554 A3	3557 A1	6451 B3	9451 A2
1451 A1	1454 A4	3552 B2	3555 A2	3558 B2	7450 A2	9452 B3

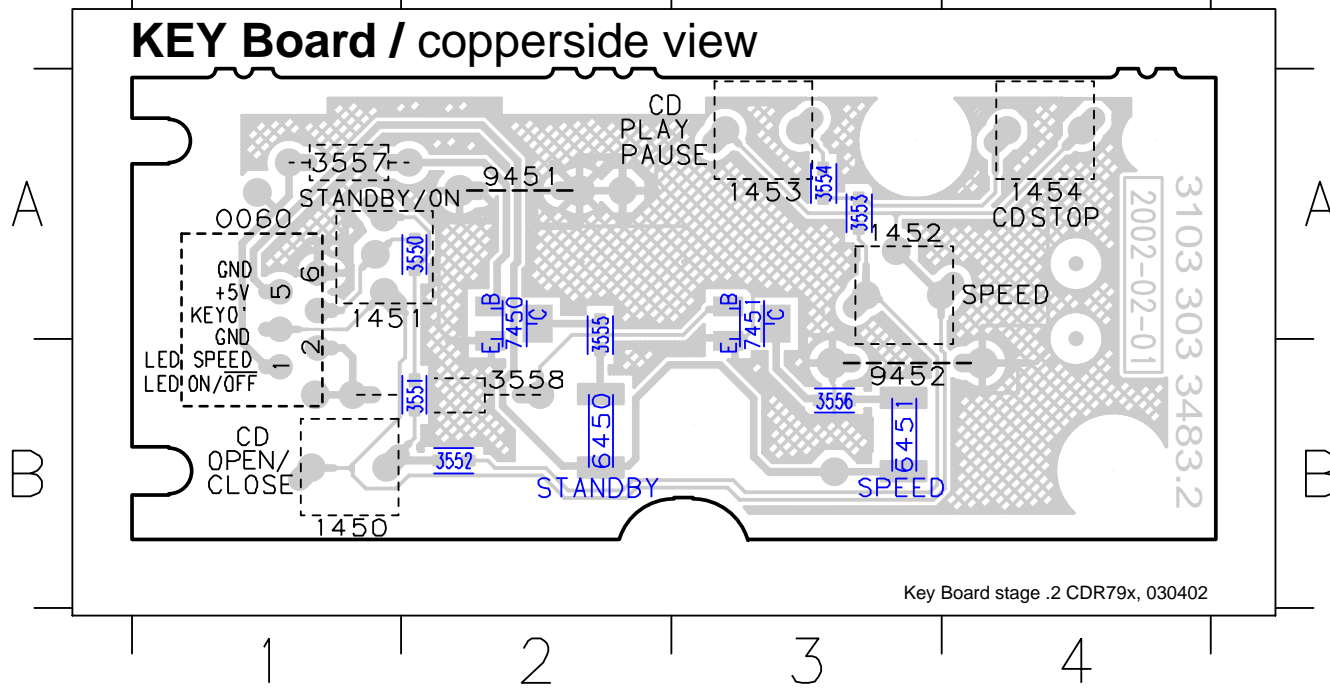

1460 A1	3571 D1	3573 E1	3575 D1	4461 A1	6462 E1	6464 C1	6466 D1	6469 E1
3570 D1	3572 E1	3574 C1	3576 E1	4463 A1	6463 D1	6465 D1	6468 E1	

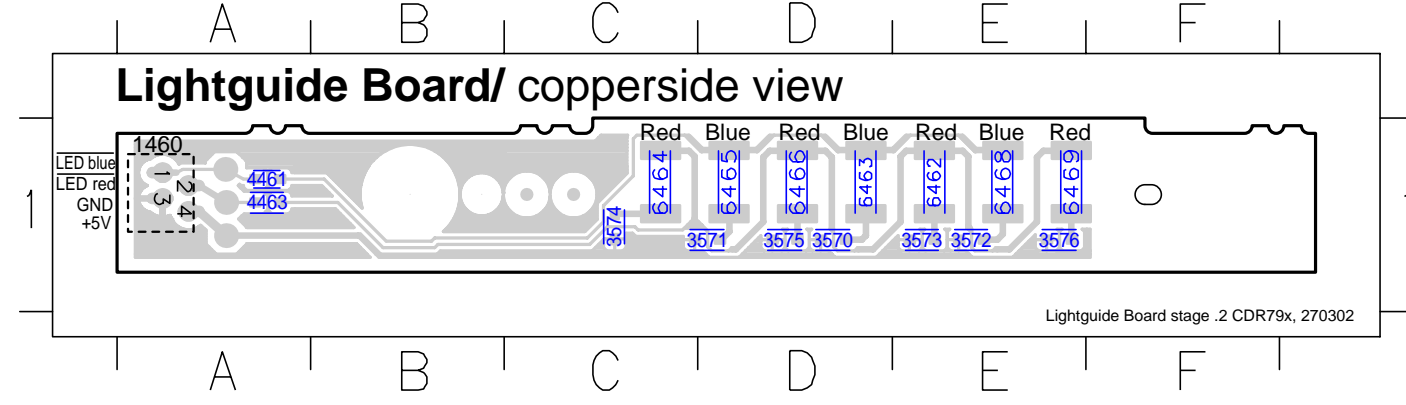

INTERFACE BOARD

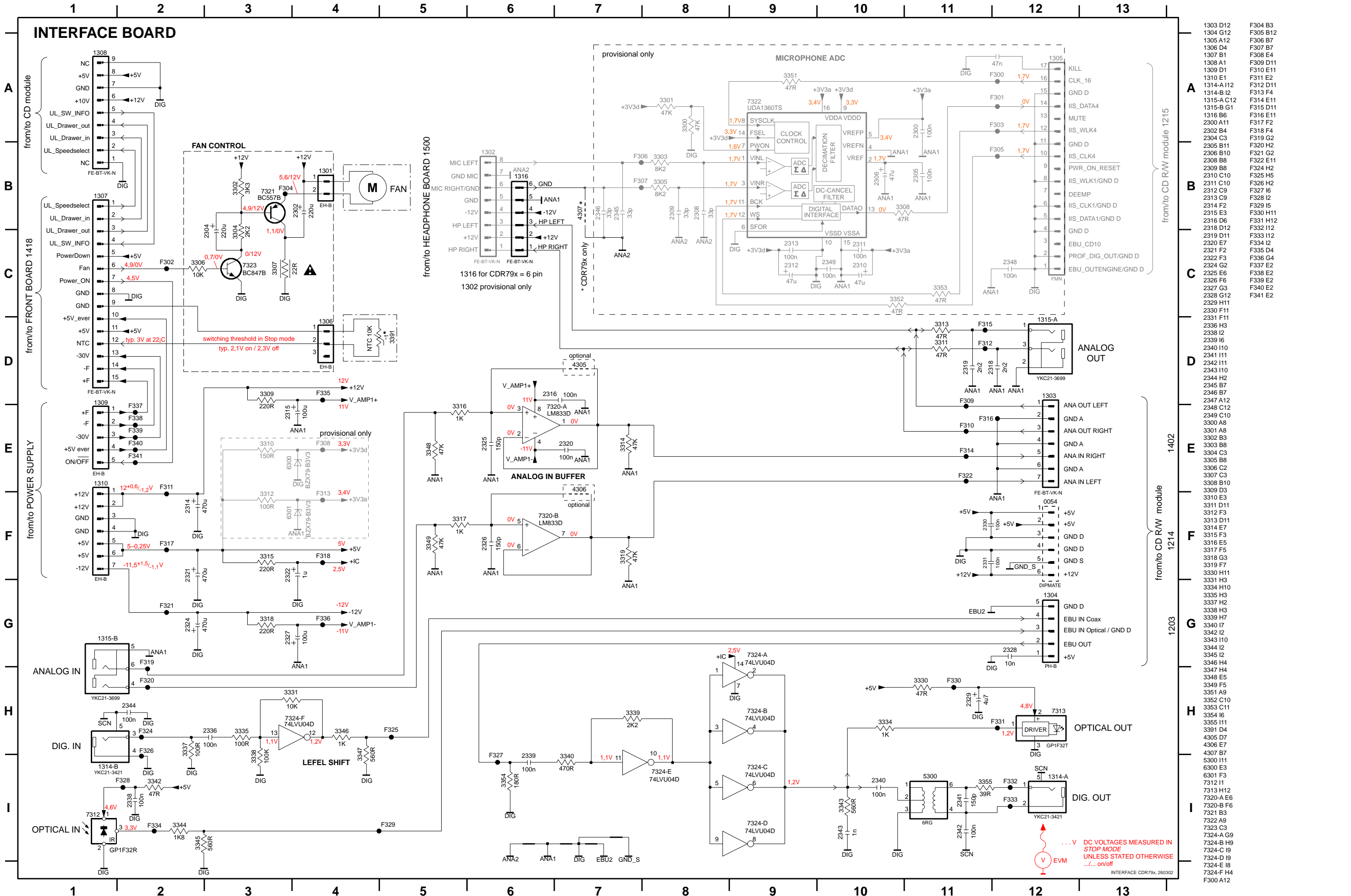

- 1303 D12
- 1304 G12
- 1305 A12
- 1306 D4
- 1307 B1
- 1308 A1
- 1309 D1
- 1310 E1
- 1314-A I12
- 1315-A C12
- 1315-B G1
- 1316 B6
- 2300 A11
- 2302 B4
- 2304 C3
- 2305 B11
- 2306 B10
- 2308 B8
- 2309 B8
- 2310 C10
- 2311 C10
- 2312 C9
- 2313 C9
- 2314 F2
- 2315 E3
- 2316 D6
- 2318 D12
- 2319 D11
- 2320 E7
- 2321 F2
- 2322 F3
- 2324 G2
- 2325 E6
- 2326 F6
- 2327 G3
- 2328 G12
- 2329 H11
- 2330 F11
- 2331 F11
- 2336 H3
- 2338 I2
- 2339 I6
- 2340 I10
- 2341 I11
- 2342 I11
- 2343 I10
- 2344 H2
- 2345 B7
- 2346 B7
- 2347 A12
- 2348 C12
- 2349 C10
- 3000 A8
- 3001 A8
- 3002 B3
- 3003 B8
- 3004 C3
- 3005 B8
- 3006 C2
- 3007 C3
- 3008 B10
- 3009 D3
- 3010 E3
- 3011 D11
- 3012 F3
- 3013 D11
- 3014 E7
- 3015 F3
- 3016 E5
- 3017 F5
- 3018 G3
- 3019 F7
- 3030 H11
- 3031 H3
- 3034 H10
- 3035 H3
- 3037 H2
- 3038 H3
- 3039 H7
- 3040 I7
- 3042 I2
- 3043 I10
- 3044 I2
- 3045 I2
- 3046 H4
- 3047 H4
- 3048 E5
- 3049 F5
- 3051 A9
- 3052 C10
- 3054 I6
- 3055 I11
- 3056 D4
- 4305 D7
- 4306 E7
- 4307 B7
- 5000 I11
- 6000 E3
- 6001 F3
- 7012 I1
- 7013 H12
- 7020-A E6
- 7020-B F6
- 7021 B3
- 7022 A9
- 7023 C3
- 7024-A G9
- 7024-B H9
- 7024-C I9
- 7024-D I9
- 7024-E I8
- 7024-F H4
- F300 A12
- F304 B3
- F305 B12
- F306 B7
- F307 B7
- F308 E4
- F309 D11
- F310 E11
- F311 E2
- F312 D11
- F313 F4
- F314 E11
- F315 D11
- F316 E11
- F317 F2
- F318 F4
- F319 C2
- F320 H2
- F321 G2
- F322 E11
- F323 H2
- F324 H2
- F325 H5
- F326 H2
- F327 I6
- F328 I2
- F329 I5
- F330 H11
- F331 H12
- F332 I2
- F333 I2
- F334 I2
- F335 D4
- F336 G4
- F337 E2
- F338 E2
- F339 E2
- F340 E2
- F341 E2

... V DC VOLTAGES MEASURED IN STOP MODE UNLESS STATED OTHERWISE
 ... on/off

INTERFACE CDR79x, 260302

0054 A8	1304 B5	1308 B5	1315 C4	2306 B2	2315 B4	2322 B6	3307 B1	3330 C8	6300 B4	7321 B1	9304 B6	9309 C3	9313 C2	9317 B2
1301 C1	1305 A3	1309 B6	1316 A1	2310 B2	2318 C3	2324 B8	3309 B5	3342 C8	6301 B3	9301 A5	9305 B4	9310 B1	9314 A7	9318 B3
1302 A1	1306 A5	1310 B8	2302 B1	2312 B3	2319 C3	2327 B3	3315 B7	3351 B3	7312 C7	9302 A7	9307 A4	9311 C2	9315 B1	9319 A7
1303 A2	1307 A5	1314 C6	2304 C1	2314 B7	2321 B7	2329 B7	3318 B8	5300 B6	7313 C7	9303 B5	9308 A4	9312 C6	9316 B2	9320 A7

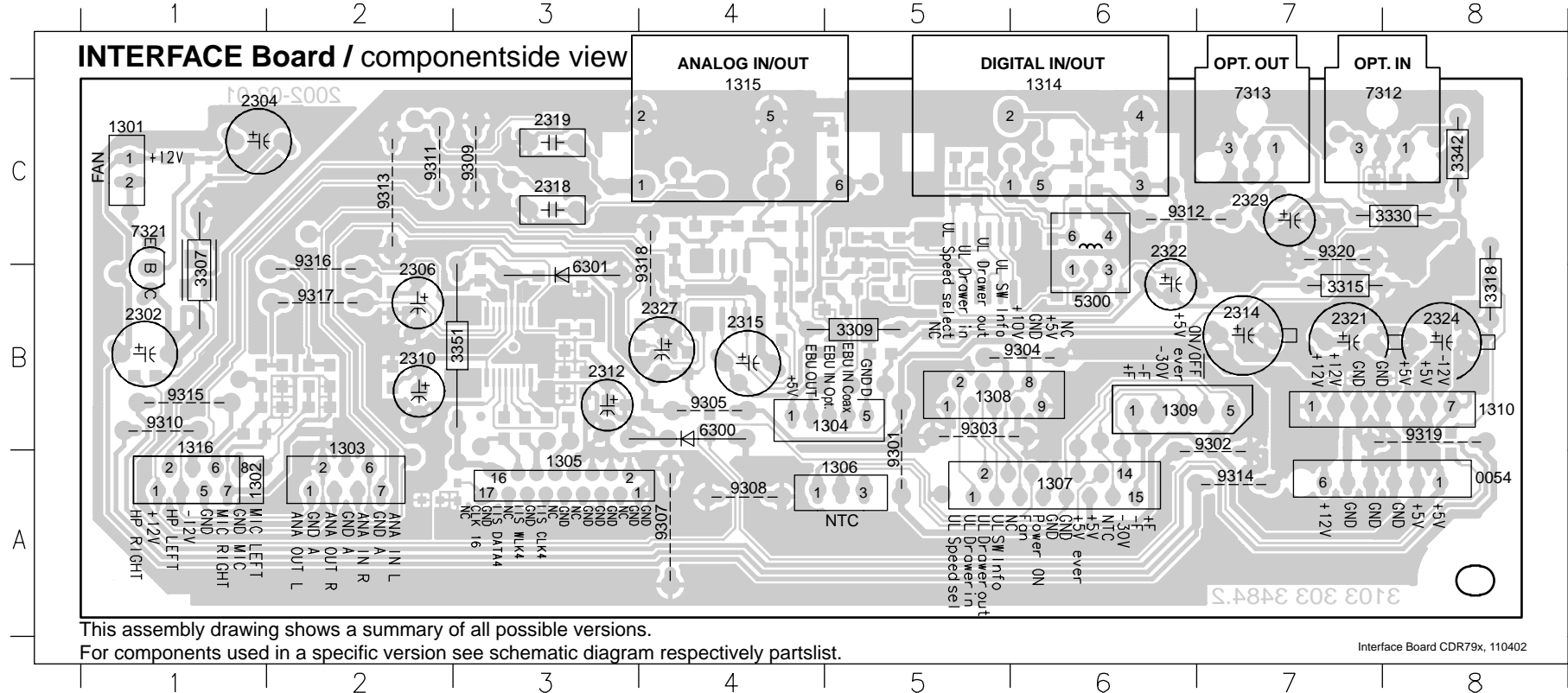

2300 B3	2311 B2	2325 B4	2331 B7	2340 B6	2344 C6	2348 B3	3302 C1	3306 B1	3312 B3	3317 C4	3335 B6	3340 C5	3346 B5	3352 B3	4301 A8	4305 B4	7322 B3
2305 B2	2313 B3	2326 C4	2336 C6	2341 C6	2345 B2	2349 A2	3303 B2	3308 B3	3313 C3	3319 B4	3337 C6	3343 C5	3347 B5	3353 B3	4302 B4	4306 C4	7323 B1
2308 B2	2316 B4	2328 B5	2338 C8	2342 C6	2346 B2	3300 B3	3304 C1	3310 B3	3314 B4	3331 B5	3338 B6	3344 B5	3348 C5	3354 B5	4303 C5	4307 A1	7324 B5
2309 B2	2320 B4	2330 B8	2339 B5	2343 C5	2347 A3	3301 B3	3305 B1	3311 C3	3316 B4	3334 C6	3339 C5	3345 B5	3349 C4	3355 C6	4304 B3	7320 B4	

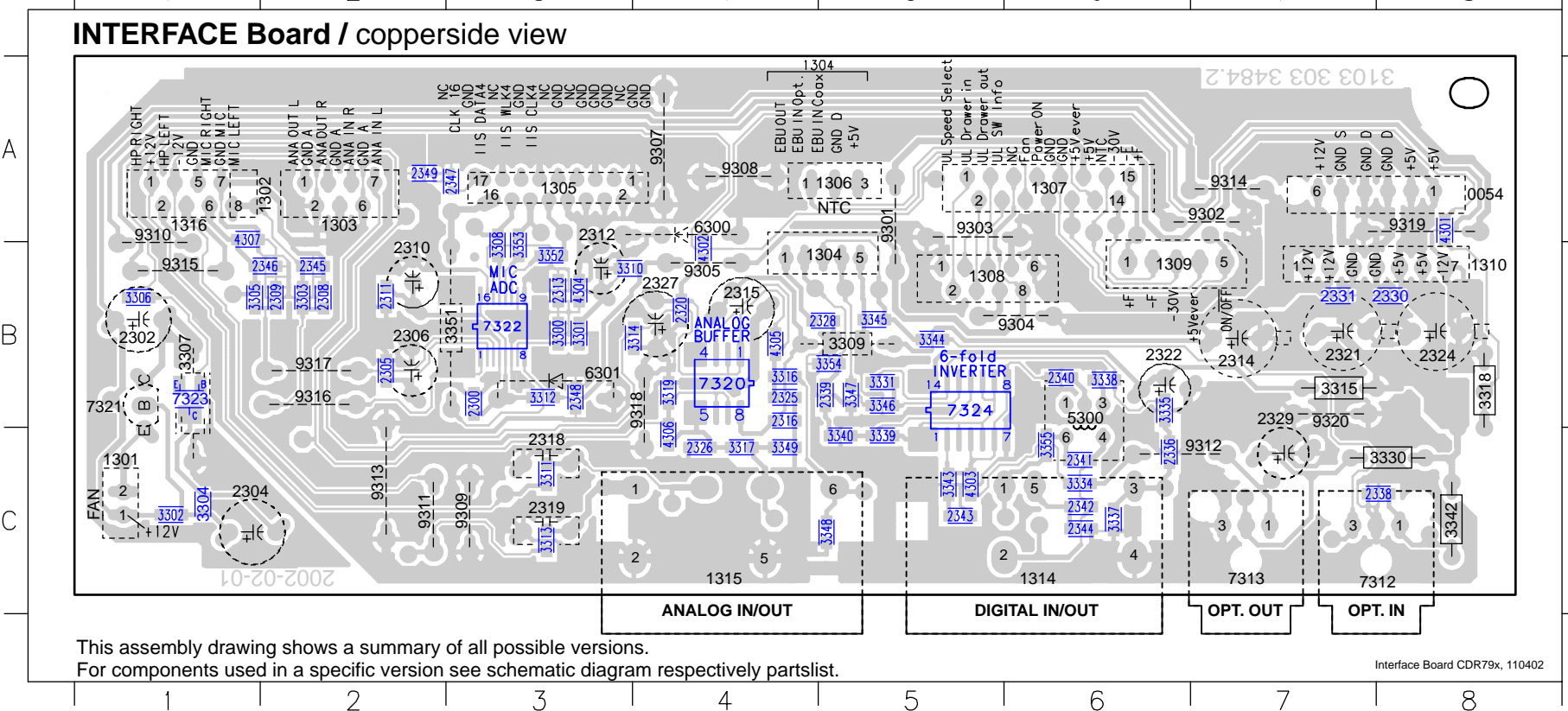

0054 A8	1304 B5	1308 B5	1315 C4	2306 B2	2315 B4	2322 B6	3307 B1	3330 C8	6300 B4	7321 B1	9304 B6	9309 C3	9313 C2	9317 B2
1301 C1	1305 A3	1309 B6	1316 A1	2310 B2	2318 C3	2324 B8	3309 B5	3342 C8	6301 B3	9301 A5	9305 B4	9310 B1	9314 A7	9318 B3
1302 A1	1306 A5	1310 B8	2302 B1	2312 B3	2319 C3	2327 B3	3315 B7	3351 B3	7312 C7	9302 A7	9307 A4	9311 C2	9315 B1	9319 A7
1303 A2	1307 A5	1314 C6	2304 C1	2314 B7	2321 B7	2329 B7	3318 B8	5300 B6	7313 C7	9303 B5	9308 A4	9312 C6	9316 B2	9320 A7

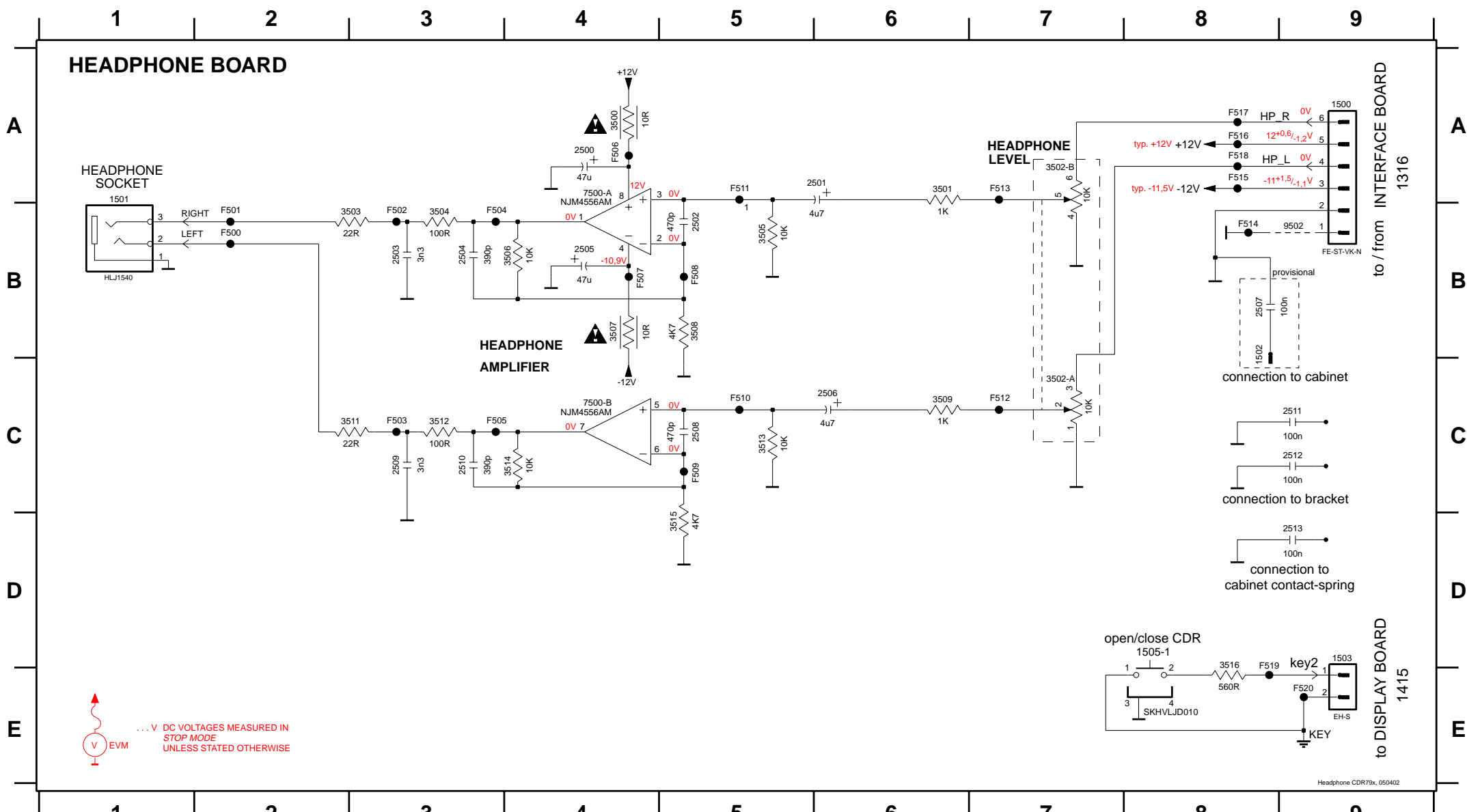

- 1500 A9
- 1501 A1
- 1502 C8
- 1503 D9
- 1505-1 D8
- 1505-2 E8
- 2500 A4
- 2501 A6
- 2502 B5
- 2503 B3
- 2504 B3
- 2505 B4
- 2506 C6
- 2507 B8
- 2508 C5
- 2509 C3
- 2510 C3
- 2511 C9
- 2512 C9
- 2513 D9
- 3500 A4
- 3501 A6
- 3502-A C7
- 3502-B B7
- 3503 B3
- 3504 B3
- 3505 B5
- 3506 B4
- 3507 B4
- 3508 B5
- 3509 C6
- 3511 C3
- 3512 C3
- 3513 C5
- 3514 C4
- 3515 D5
- 3516 E8
- 7500-A A4
- 7500-B C4
- 9502 B9
- F500 B2
- F501 B2
- F502 B3
- F503 C3
- F504 B3
- F505 C3
- F506 A4
- F507 B4
- F508 B5
- F509 C5
- F510 C5
- F511 A5
- F512 C7
- F513 A7
- F514 B8
- F515 A8
- F516 A8
- F517 A8
- F518 A8
- F519 E9
- F520 E9

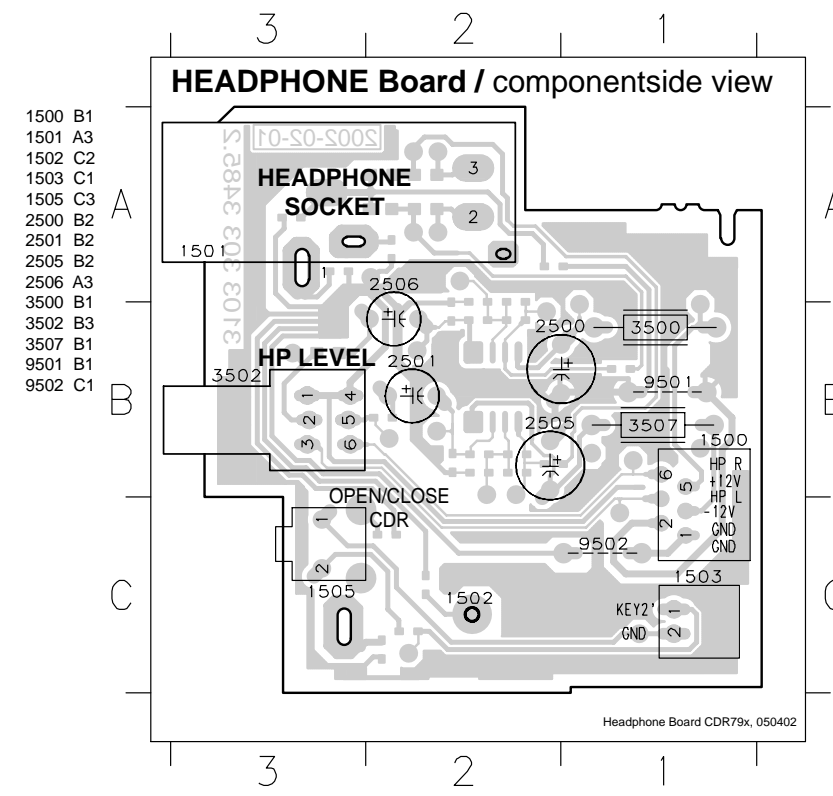

- 1500 B1
- 1501 A3
- 1502 C2
- 1503 C1
- 1505 C3
- 2500 B2
- 2501 B2
- 2505 B2
- 2506 A3
- 3500 B1
- 3502 B3
- 3507 B1
- 9501 B1
- 9502 C1

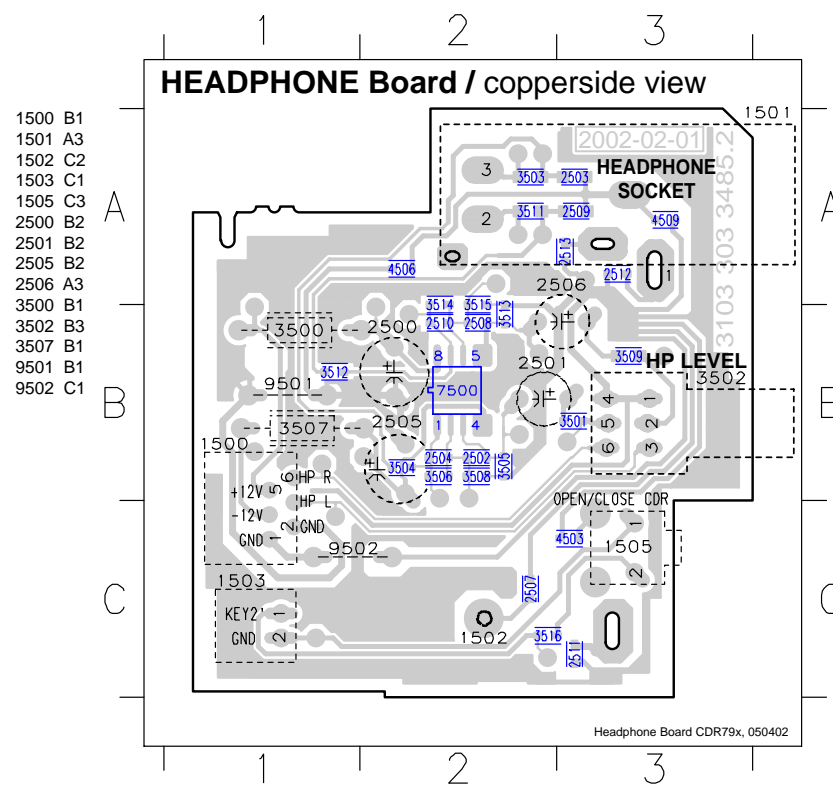

- 1500 B1
- 1501 A3
- 1502 C2
- 1503 C1
- 1505 C3
- 2500 B2
- 2501 B2
- 2505 B2
- 2506 A3
- 3500 B1
- 3502 B3
- 3507 B1
- 9501 B1
- 9502 C1

- 2502 B2
- 2503 A3
- 2504 B2
- 2507 C2
- 2508 B2
- 2509 A3
- 2510 B2
- 2511 C3
- 2512 A3
- 2513 A3
- 3501 B3
- 3503 A2
- 3504 B2
- 3505 B2
- 3506 B2
- 3508 B2
- 3509 B3
- 3511 A2
- 3512 B1
- 3513 B2
- 3514 A2
- 3515 A2
- 3516 C2
- 4503 C3
- 4506 A2
- 4509 A3
- 7500 B2

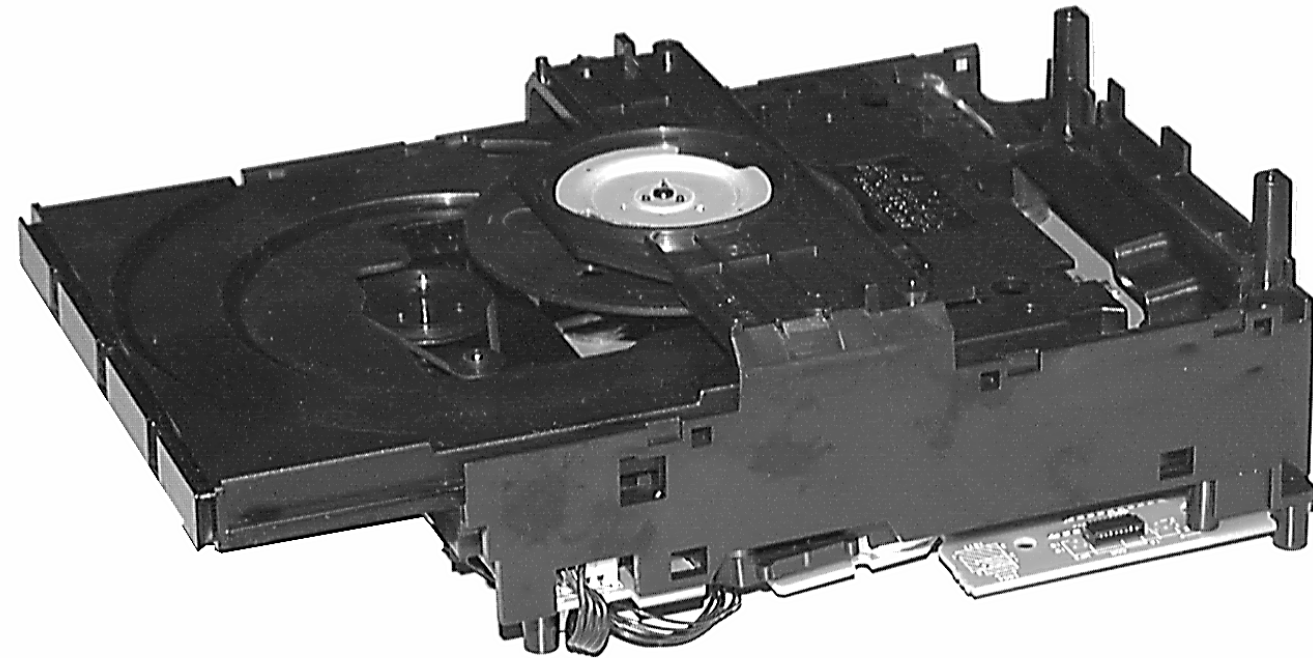

Service hints

CAUTION

CHARGED CAPACITORS ON THE SERVO BOARD MAY DAMAGE THE CD DRIVE ELECTRONICS WHEN CONNECTING A NEW CD MECHANISM. THAT'S WHY, BESIDES THE SAFETY MEASURES LIKE

- **SWITCH OFF POWER SUPPLY**
- **ESD PROTECTION**

ADDITIONAL ACTIONS MUST BE TAKEN BY THE REPAIR TECHNICIAN.

The following steps have to be done when replacing the CD mechanism:

1. Disconnect flexfoil cable from the old CD drive
2. Put a paperclip onto the flexfoil cable to short-circuit the contacts (fig.1)
3. Remove the old CD drive
4. Remove paperclip from the flexfoil cable and connect it to the new CD drive

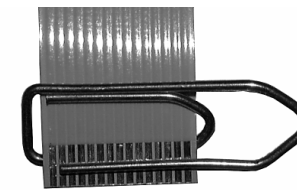

fig.1

Universal Loader

(Single Disc Tray Loader)

Layout stage .5

Emergency open

- In case of a Supply fault, the tray can be opened manually.
1. Remove the top cover of the set to get access to the CD Module.
 2. proceed as shown in picture below.

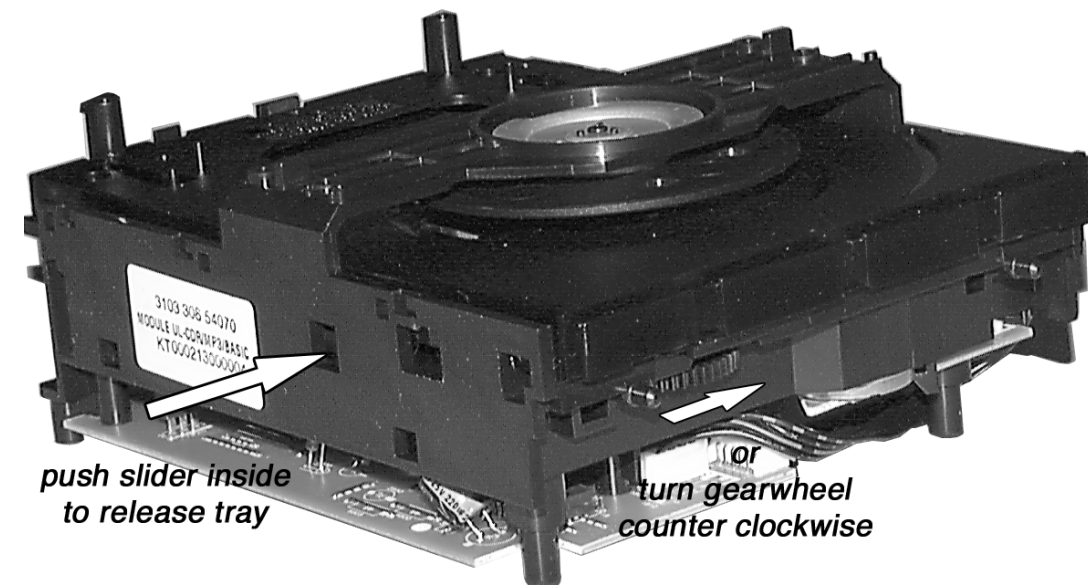

TABLE OF CONTENTS

Abbreviations	8-2
Blockdiagram	8-3
Component Layout CD Board	8-4
Circuit Diagram	8-5
Exploded View	8-6
Mechanical Partslist	8-6, 10-2
Electrical Partslist	10-7



Service hints

Dismantling of Tray

1. Open the tray and release 2 catches as shown in fig. 2
2. Pull tray out.

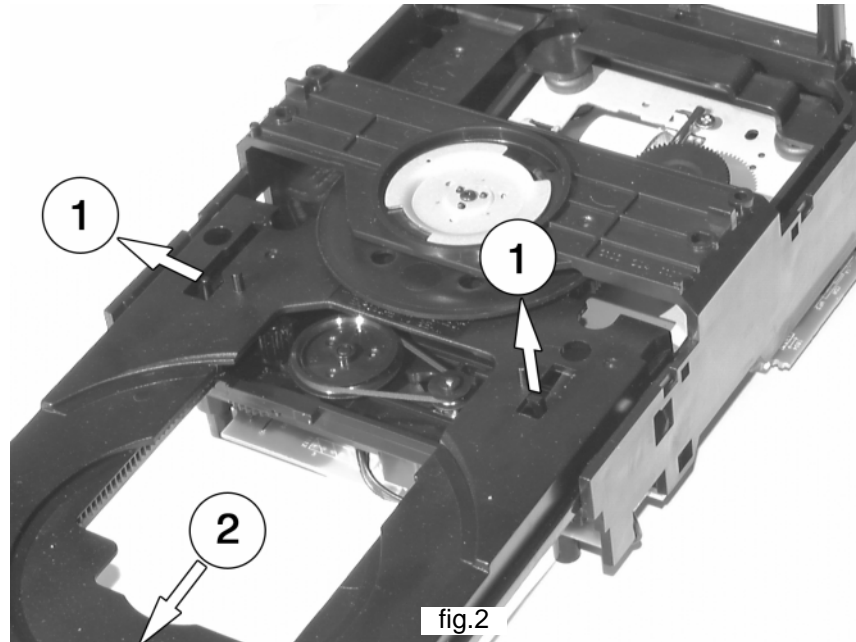

Assembling of Tray

1. Check if slider is on the right side → see picture below.
2. If necessary - move slider to the right end position first.
3. Insert the Tray.

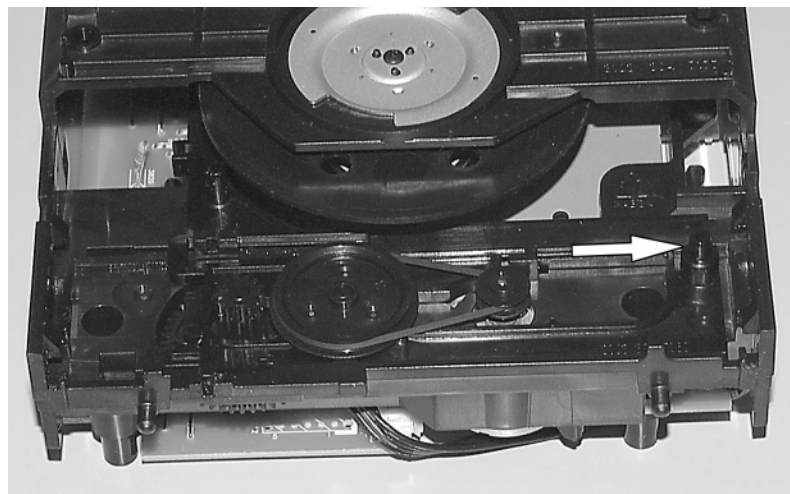

Abbreviations

Laser Power Control & HF Amplifier (ADALAS) TZA1024/TZA1025

Pin	Name	Direction	Description
1	LD	HF-preamp → CD-drive	current output to laser diode
2	VCCL	+5V	laser supply voltage
3	CFIL	→ HF-preamp	external filter capacitor
4	MON	CD-drive → HF-preamp	laser monitor diode input
5	DIN	CD-drive → HF-preamp	central diode input
6	GND	GND	ground
7	PWRON	CD10 → HF-preamp	power-on select input
8	CMFB	VrefCD10 (+3,3V / 2)	common mode feedback voltage input
9	RFFB	→ HF-preamp	external RF feedback resistor
10	RFEQO	HF-preamp →	RF amplifier output
11	CDRW	CD10 → HF-preamp	gain select input for CDDA/CDRW
12	EQSEL	CD10 → HF-preamp	equalizer/speed select input
13	VCC2	+3,3V	supply voltage
14	RGADJ	GND	external laser supply gain adjust resistor

SIGNAL PROCESSOR (CD10) SAA7325

Pin	Name	Direction	Description
1	HFREF	→ CD10	comparator common mode input
2	HFIN	→ CD10	comparator signal input
3	ISLICE	CD10 →	current feedback from data slicer
4	VSSA1	GND	analog ground 1
5	VDDA1	+3,3V	analog supply voltage 1
6	IREF	CD10 →	reference current output pin
7	VRIN	CD10 →	reference voltage for servo ADC's
8	D1	CD-drive → CD10	unipolar current input (central diode signal input)
9	D2	CD-drive → CD10	unipolar current input (central diode signal input)
10	D3	CD-drive → CD10	unipolar current input (central diode signal input)
11	D4	CD-drive → CD10	unipolar current input (central diode signal input)
12	R1	CD-drive → CD10	unipolar current input (satellite diode signal input)
13	R2	CD-drive → CD10	unipolar current input (satellite diode signal input)
14	VSSA2	GND	analog ground 2
15	CROUT	CD10 → X-TAL	crystal/resonator output
16	CRIN	X-TAL → CD10	crystal/resonator input
17	VDDA2	+3,3V	analog supply voltage 2
18	LN	CD10 →	DAC left channel differential output - negative
19	LP	CD10 →	DAC left channel differential output - positive
20	VNEG	GND	DAC negative reference input
21	VPOS	+3,3V	DAC positive reference input
22	RN	CD10 →	DAC right channel differential output - negative
23	RP	CD10 →	DAC right channel differential output - positive
24	SELPLL	CD10 →	selects whether internal clock multiplier PLL is used
25	TEST1	GND	test control input 1; this pin should be tied low
26	CL16	CD10 → NPC	16.9344 MHz system clock output
27	DATA	CD10 → NPC	serial data output (3-state)
28	WCLK	CD10 → NPC	word clock output (3-state)
29	SCLK	CD10 → NPC	serial bit clock output (3-state)
30	EF	CD10 → NPC	C2 error flag output (3-state)
31	TEST2	GND	test control input 2; this pin should be tied low
32	KILL	CD10 → Mute control	kill output (programmable; open-drain)
33	VSSD1	GND	digital ground 2
34	V2/V3	CD10 → NPC	versatile I/O: input versatile pin 2 or output versatile pin 3 (open-drain)
35	WCLI	NPC → CD10	word clock input (for data loopback to DAC)
36	SDI	NPC → CD10	serial data input (for data loopback to DAC)
37	SCLI	NPC → CD10	serial bit clock input (for data loopback to DAC)
38	RESETn	μP → CD10	power-on reset input (active low)
39	SDA	μP ↔ CD10	microcontroller interface data I/O line (open-drain output)
40	SCL	μP → CD10	microcontroller interface clock line input
41	RAB	μP → CD10	microcontroller interface R/W and load control line input (4-wire bus mode)
42	SILD	μP → CD10	microcontroller interface R/W and load control line input (4-wire bus mode)
43	STATUS	CD10 →	servo interrupt request line/decoder status register output (open-drain)
44	TEST3	GND	test control input 3; this pin should be tied low
45	RCK	→ CD10	subcode clock input
46	SUB	CD10 →	P-to-W subcode bits output (3-state)
47	SFSY	CD10 → μP	subcode frame sync output (3-state)
48	SBSY	CD10 → NPC	subcode block sync output (3-state)
49	CL11/4	CD10 →	11.2896 MHz or 4.2336 MHz (for microcontroller) clock output
50	VSSD2	GND	digital ground 3
51	DOBM	CD10 →	bi-phase mark output (externally buffered; 3-state)
52	VDDD1P	+3,3V	digital supply voltage 2 for periphery
53	CFLG	CD10 →	correction flag output (open-drain)
54	RA	CD10 → servo driver	radial actuator output
55	FO	CD10 → servo driver	focus actuator output
56	SL	CD10 → servo driver	slide control output
57	VDDD2C	+3,3V	digital supply voltage 3 for core
58	VSSD3	GND	digital ground 4
59	MOTO1	CD10 → servo driver	motor output 1; versatile (3-state)
60	MOTO2	CD10 →	motor output 2; versatile (3-state)
61	V4	CD10 → HF-preamp	versatile output pin 4
62	V5	CD10 → HF-preamp	versatile output pin 5
63	V1	innerswitch → CD10	versatile input pin 1
64	LDON	CD10 → HF-preamp	laser drive on output (open-drain)

BLOCK DIAGRAM Universal Loader CDR Version

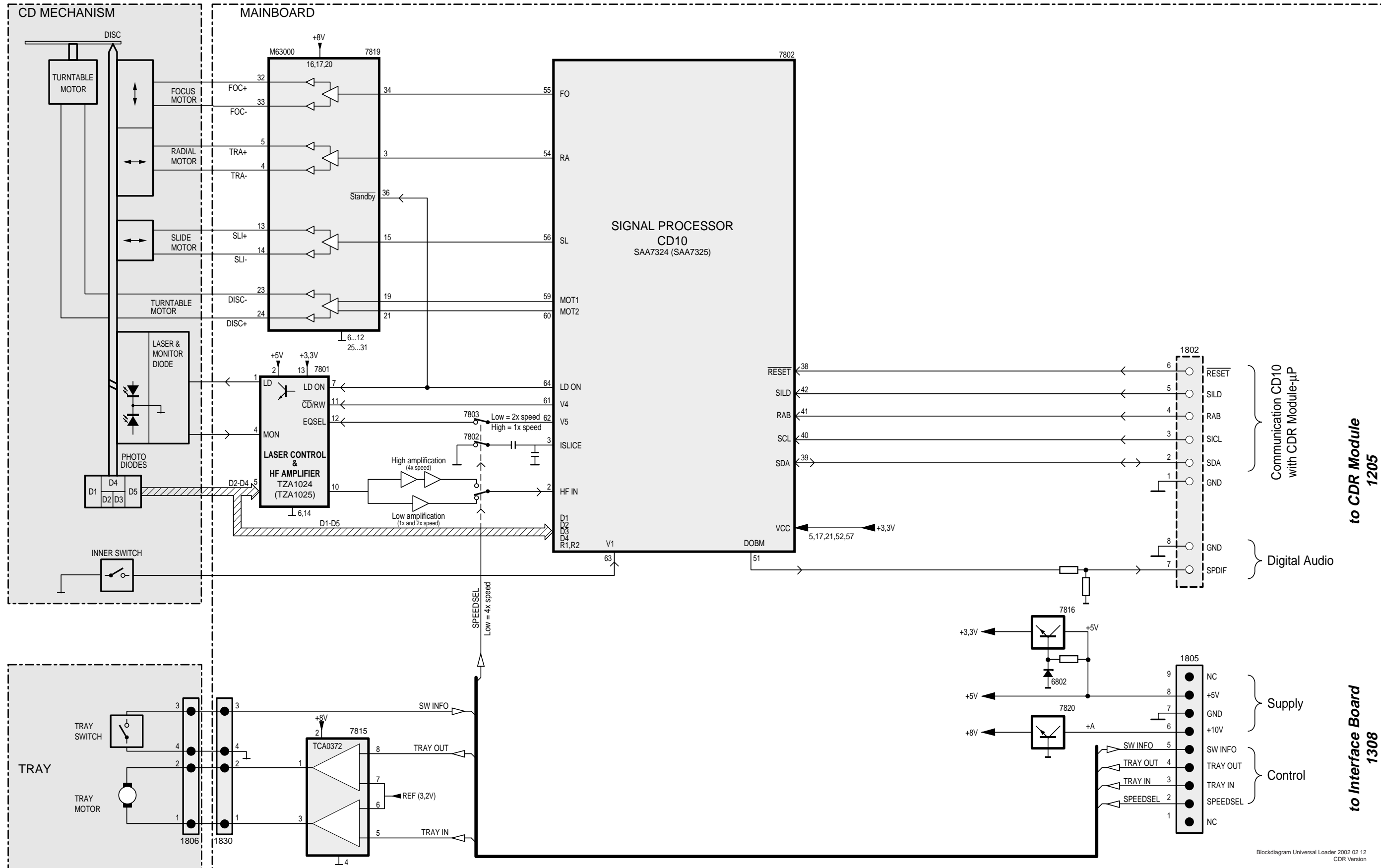

CD Board Copperside view (Universal Loader)

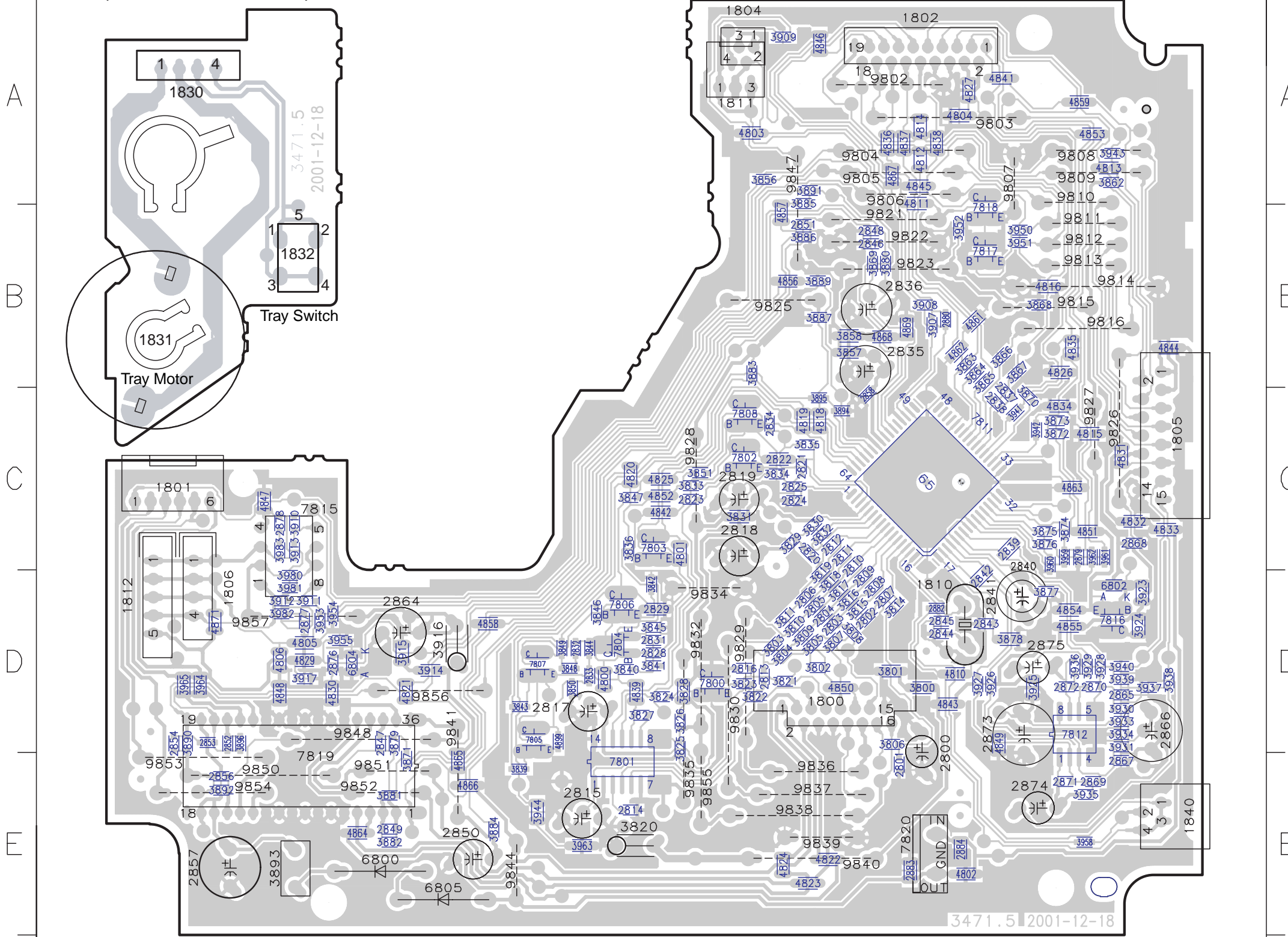

Mapping SMD parts

HMC parts

2801 E5	3835 C4	3961 C6	1800 D4
2802 D5	3836 C3	3962 C6	1801 C1
2803 D4	3839 E3	3963 E3	1802 A5
2804 D4	3840 D3	3964 D1	1804 A4
2805 D4	3841 D3	3965 D1	1805 C6
2806 D4	3842 D3	3980 D2	1806 D1
2807 D5	3843 D3	3981 D2	1810 D5
2808 D5	3844 D3	3982 D1	1811 A4
2809 D5	3845 D3	3983 C1	1812 D1
2810 C5	3846 D3	4800 D3	1830 A1
2811 C5	3847 C3	4801 C4	1831 B1
2812 C4	3848 D3	4802 E5	1832 B1
2813 D4	3849 D3	4803 A4	1840 E6
2814 E3	3850 D3	4804 A5	2800 D5
2816 D4	3851 C4	4805 D2	2815 E3
2820 C4	3856 A4	4806 D1	2817 D3
2821 C4	3857 B5	4810 D5	2818 C4
2822 C4	3858 B5	4811 A5	2819 C4
2823 C4	3862 A6	4812 A5	2835 B5
2824 C4	3863 B5	4813 A6	2836 B5
2825 C4	3864 B5	4814 A5	2840 D6
2828 D3	3865 B5	4815 C6	2841 D5
2829 D4	3866 B5	4816 B6	2850 E3
2831 D3	3867 B5	4818 C4	2857 E1
2832 D3	3868 B6	4819 C4	2864 D2
2833 D3	3869 B5	4820 C3	2866 D6
2834 C4	3870 C6	4821 D2	2873 D5
2837 C5	3871 E2	4822 E4	2874 E6
2838 C5	3872 C6	4823 E4	2875 D6
2839 C5	3873 C6	4824 E4	3820 E3
2842 D5	3874 C6	4825 C4	3893 E2
2843 D5	3875 C6	4826 B6	3916 D2
2844 D5	3876 C6	4827 A5	6800 E2
2845 D5	3877 D6	4829 D2	6805 E2
2846 B5	3878 D5	4830 D2	7815 C1
2847 D2	3879 D2	4831 C6	7819 E2
2848 B5	3880 B5	4832 C6	7820 E5
2849 E2	3881 E2	4833 C6	9802 A5
2851 B4	3882 E2	4834 C6	9803 A5
2852 D1	3883 B4	4835 B6	9804 A5
2853 D1	3884 E3	4836 A5	9805 A5
2854 D1	3885 A4	4837 A5	9806 A5
2856 E1	3886 B4	4838 A5	9807 A6
2858 C5	3887 B4	4839 D3	9808 A6
2865 D6	3889 B4	4841 A5	9809 A6
2867 E6	3890 D1	4842 C4	9810 A6
2868 C6	3891 A4	4843 D5	9811 B6
2869 E6	3892 E1	4844 B6	9812 B6
2870 D6	3894 C5	4845 A5	9813 B6
2871 E6	3895 C4	4846 A4	9814 B6
2872 D6	3896 D1	4847 C1	9815 B6
2876 D2	3907 B5	4848 D1	9816 B6
2877 D2	3908 B5	4849 D5	9821 B5
2878 C1	3909 A4	4850 D5	9822 B5
2879 C6	3910 C2	4851 C6	9823 B5
2880 B5	3911 D2	4852 C4	9825 B4
2882 D5	3912 D1	4853 A6	9826 C6
2883 E5	3913 C2	4854 D6	9827 C6
2884 E5	3914 D2	4855 D6	9828 C4
3800 D5	3915 D2	4856 B4	9829 D4
3801 D5	3917 D2	4857 B4	9830 D4
3802 D4	3923 D6	4858 D3	9832 D4
3803 D4	3924 D6	4859 A6	9834 D4
3804 D4	3925 D6	4861 B5	9835 D4
3805 D4	3926 D5	4862 B5	9836 E4
3806 D5	3927 D5	4863 C6	9837 E4
3807 D4	3928 D6	4864 E2	9838 E4
3808 D5	3929 D6	4865 E2	9839 E4
3809 D4	3930 D6	4866 E2	9840 E4
3810 D4	3931 D6	4867 A5	9841 E2
3811 D4	3933 D6	4868 B5	9844 E3
3814 D5	3934 D6	4869 B5	9847 B4
3815 D5	3935 E6	4871 D1	9848 D2
3816 D5	3936 D6	4899 D3	9850 E1
3817 D5	3937 D6	6802 D6	9851 E2
3818 D4	3938 D6	6804 D2	9852 E2
3819 D4	3939 D6	7800 D4	9853 D1
3821 D4	3940 D6	7801 E3	9854 E1
3822 D4	3941 C5	7802 C4	9855 E4
3823 D4	3942 C6	7803 C3	9856 D2
3824 D4	3943 A6	7804 D3	9857 D2
3825 D4	3944 E3	7805 D3	
3826 D4	3950 B5	7806 D3	
3827 D3	3951 B5	7807 D3	
3828 D4	3952 B5	7808 C4	
3829 C4	3953 D2	7811 C5	
3830 C4	3954 D2	7812 D6	
3831 C4	3955 D2	7816 D6	
3832 C4	3958 E6	7817 B5	
3833 C4	3959 C6	7818 B5	
3834 C4	3960 C6		

This assembly drawing shows a summary of all possible versions. For components used in a specific version see schematic diagram respectively partslist.

1800	D1	1830	H13	2803	B5	2809	B5	2815	E4	2821	E9	2831	I7	2838	D14	2845	B10	2851	J4	2858	F12	2880	F14	3803	C3	3809	B4	3817	B5	3823	E3	3829	D9	3839	I8	3845	I7	3857	G12	3866	D14	3877	B11	3883	F10	3890	I5	3907	F13	3914	H4	3954	J15	3983	J13	7803	F8	7815A	I13
1801	G1	1831	H13	2804	B5	2810	B5	2816	E3	2822	E9	2832	I9	2839	B11	2846	H5	2852	I4	2864	I13	2883	H14	3804	C3	3810	B4	3818	B5	3824	F3	3831	E9	3840	H7	3846	H7	3858	G13	3867	D14	3878	B10	3884	H4	3891	J5	3908	F14	3915	H4	3955	I15	3983	G15	7804	H7	7815B	J13
1802	E15	1832	H13	2805	B5	2811	B5	2817	E6	2824	F10	2833	H9	2840	B11	2847	G4	2853	I4	2868	I15	2884	H15	3805	C4	3811	C4	3819	C5	3825	E7	3832	E10	3841	H7	3848	H9	3862	C15	3868	C14	3879	G5	3885	J4	3892	J5	3910	J4	3923	G15	3963	H7	7805	H8	7816	G15		
1805	H15	2800	C1	2806	C5	2812	C5	2818	E7	2825	F10	2835	F12	2842	B11	2848	G5	2854	I5	2876	J15	2880	C1	3806	A4	3814	A5	3820	E4	3826	E7	3833	E8	3842	H8	3849	H8	3863	D14	3869	H5	3880	G5	3886	J4	3894	I5	3911	H4	3924	G15	3963	H7	7806	H8	7819	F3		
1806	H13	2801	A5	2807	A5	2813	D4	2819	E10	2828	H7	2836	G13	2843	B10	2849	G4	2856	J5	2877	I13	2882	C1	3807	A4	3815	A5	3821	E2	3827	D6	3835	E10	3843	J8	3850	H8	3864	D14	3871	H5	3881	G5	3887	I5	3895	I5	3912	H13	3944	H7	3981	J14	7807	I8	7820	H15		
1810	B10	2802	A5	2808	A5	2814	E4	2820	D10	2829	H7	2837	E14	2844	B10	2850	I4	2857	H4	2878	J13	2882	C3	3808	B4	3816	B5	3822	E2	3828	E7	3836	F7	3844	H9	3856	G10	3865	D14	3873	B14	3882	G5	3889	I5	3896	I4	3913	J13	3953	H5	3982	I13	7808	E9	7811	D12		

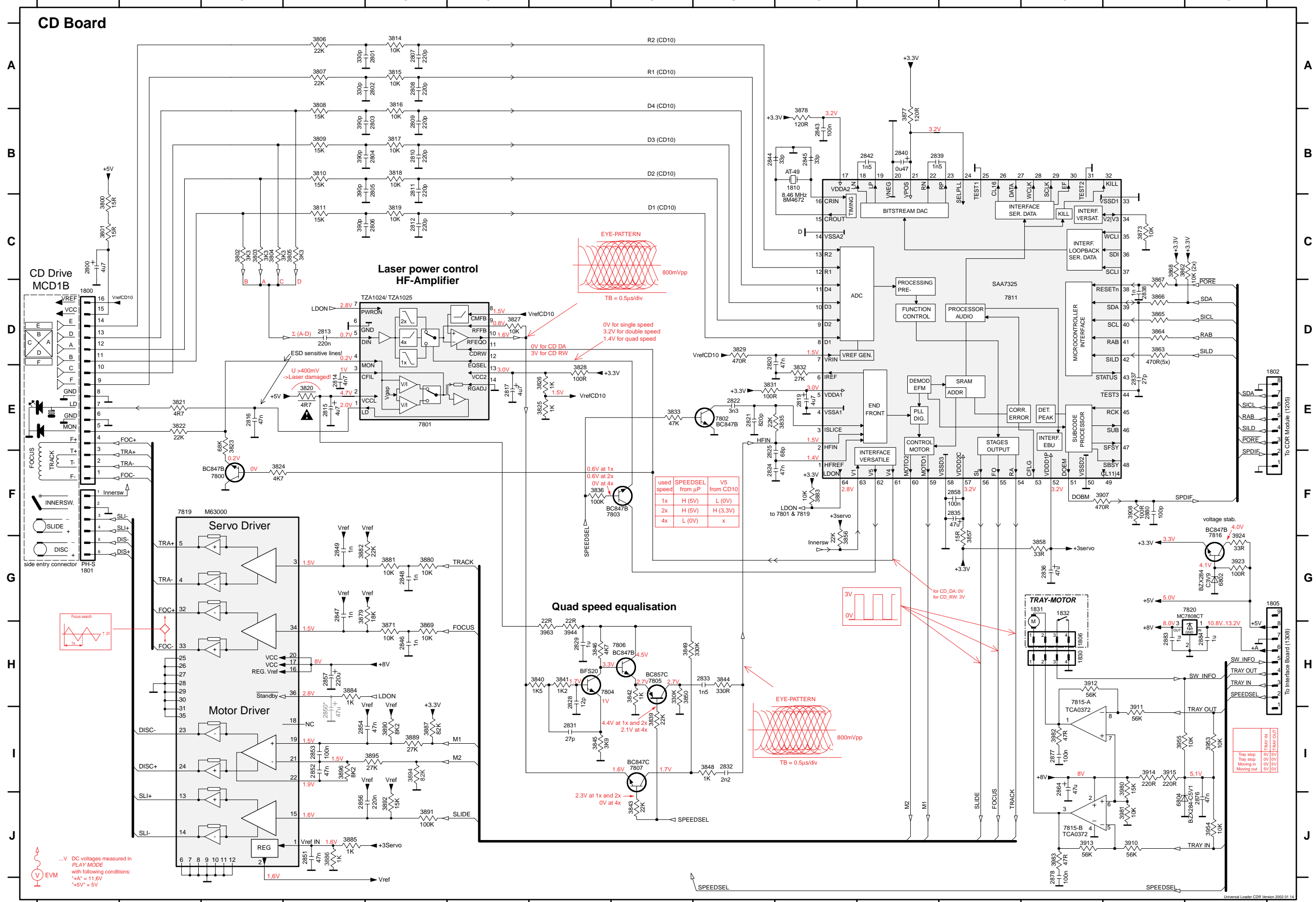

used speed	SPEEDSEL from µP	V5
1x	H (5V)	L (0V)
2x	H (5V)	H (3.3V)
4x	L (0V)	x

Tray stop	Tray stop	Tray stop
MOV IN	MOV IN	MOV IN
MOV IN	MOV IN	MOV IN
MOV IN	MOV IN	MOV IN

...V DC voltages measured in "PLAY MODE" with following conditions:
 +A = 11.6V
 +5V = 5V

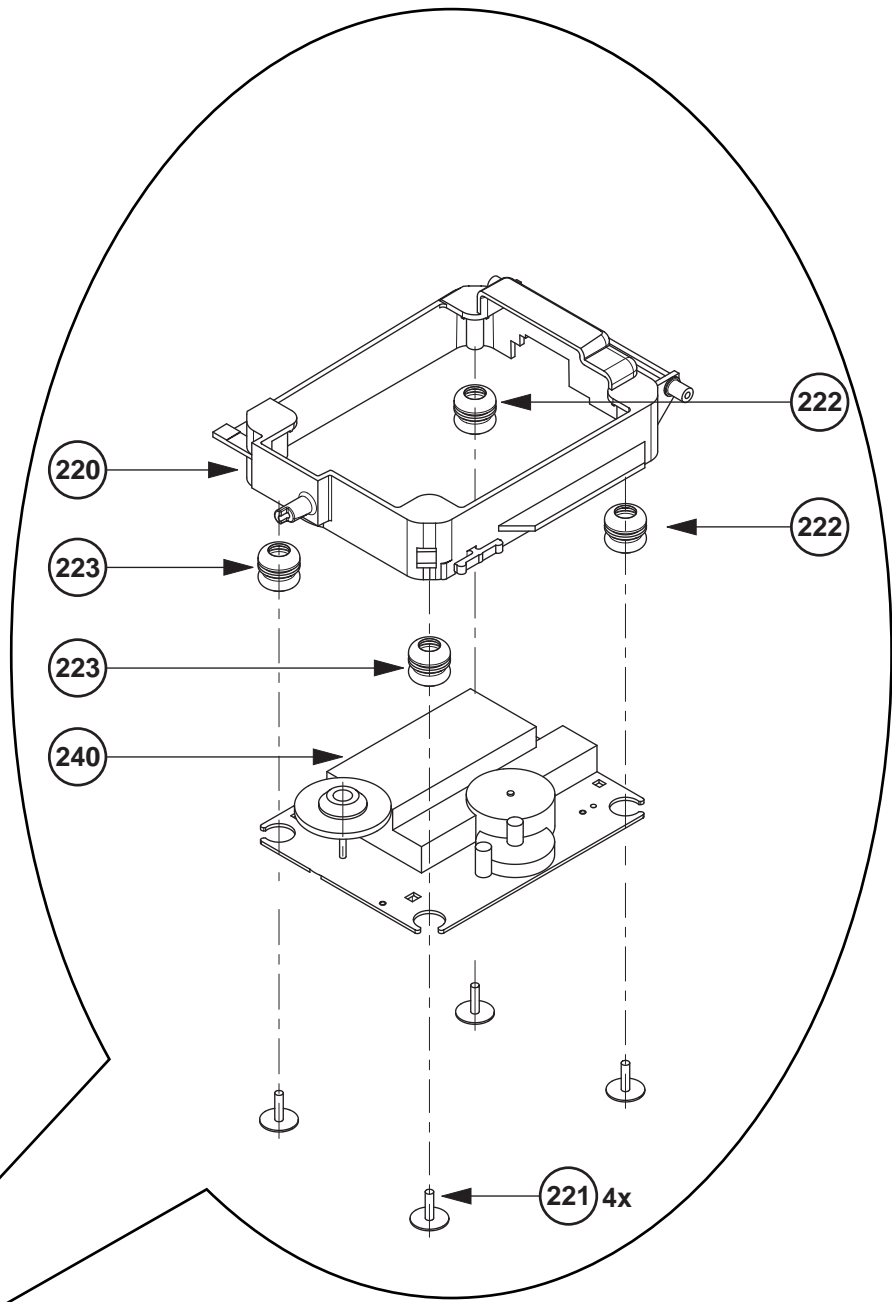
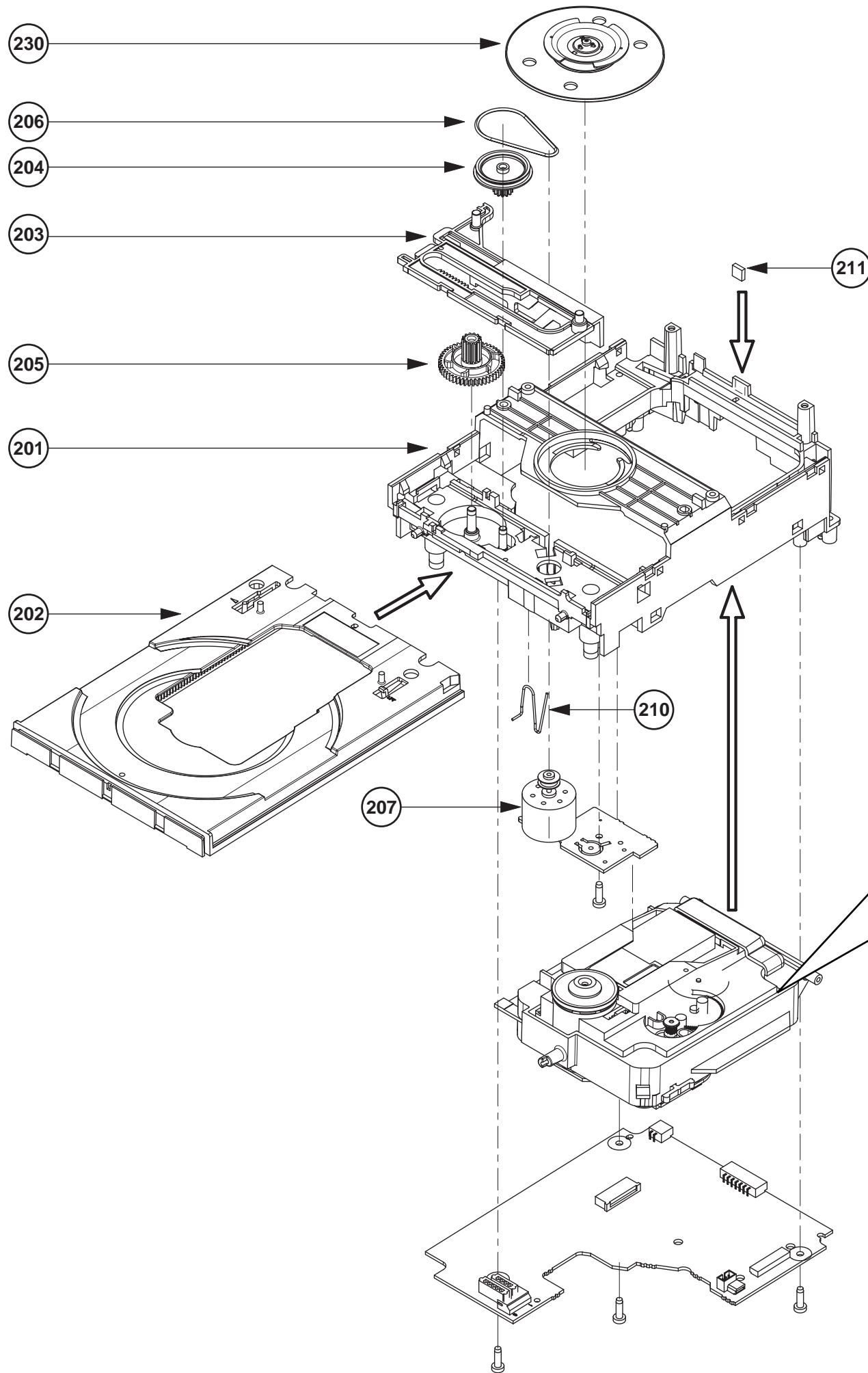

MECHANICAL PARTS

202	3103 304 71780	DRAWER
203	3103 304 71800	SLIDER
204	3103 304 71820	PULLEY GEARWHEEL
205	3103 304 71830	GEARWHEEL
206	3103 304 71910	DRIVING BELT
207	3103 308 54160	MOTOR ASSY
210	3103 301 06660	SPRING SUPPORT
220	3103 304 71790	SUPPORT CD
222	4822 529 10387	RUBBER DAMPER CD DRIVE, FRONT
223	4822 529 10387	RUBBER DAMPER CD DRIVE, FRONT
230	3103 308 11940	CLAMPER ASSY DA11
240	3103 309 05350	CD DRIVE MCD1B

Only those parts of which a service code number is stated are normal service parts.

MECHANICAL PARTSLIST APPARATUS**MECHANICAL PARTSLIST CD LOADER****MECHANICAL PARTS**

121	3104 120 00290	WORDMARK PHILIPS
131	4822 462 11174	FOOT, SILVER
132	4822 462 42158	FOOT, BLACK
200	3103 308 12840	FRONT ASSY CDR795, BLACK
200	3103 308 12850	FRONT ASSY CDR796, SILVER
202	3103 308 12590	DISPLAY-WINDOW, PRINTED
204	3103 308 12620	ORNAMENT.COVER CD TRAY, CDR795
204	3103 308 12960	ORNAMENT.COVER CD TRAY, CDR796
205	3103 308 12630	ORNAMENT.COVER CDR TRAY,CDR795
205	3103 308 12970	ORNAMENT.COVER CDR TRAY,CDR796
224	3103 304 72550	KNOB VOLUME, CDR795
224	3103 308 12980	KNOB VOLUME, CDR796

MISCELLANEOUS

312	3103 308 92610	AUDIO CABLE STEREO CINCH 1.5m
318	3139 238 01920	REMOTE CONTR. RC283105/01 BLACK
385 ▲	2422 070 98151	MAINS CORD, EUROPE
385 ▲	2422 070 98152	MAINS CORD, USA
1005 ▲	3103 308 53880	POWER BOARD, SMPS CDR8xx/00
1005 ▲	3103 308 53890	POWER BOARD, SMPS CDR8xx/17
1007	3103 308 52950	FAN, KD120 6PTS 3 - C112
8003	4822 320 12703	FLEXFOIL CABLE, 7P, 140mm, BD
8005	3103 308 92970	FLEXFOIL CABLE 6P, 120mm AD
8006	3103 308 92980	FLEXFOIL CABLE 4P, 60mm BD
8008	3139 110 34680	FLEXFOIL CABLE, 6P, 340mm BD
8012	3139 110 34680	FLEXFOIL CABLE, 6P, 340mm BD
8014	3103 308 93000	FLEXFOIL CABLE, 9P, 360mm AD
8015	3139 110 53540	FLEXFOIL CABLE, 8P, 340mm AD
8016	3103 308 93020	FLEXFOIL CABLE, 15P, 360mm AD
8020	3104 157 11780	FLEXFOIL CABLE, 36P, 77mm BD

202	3103 304 71780	DRAWER
203	3103 304 71800	SLIDER
204	3103 304 71820	PULLEY GEARWHEEL
205	3103 304 71830	GEARWHEEL
206	3103 304 71910	DRIVING BELT
207	3103 308 54160	MOTOR ASSY
210	3103 301 06660	SPRING SUPPORT
220	3103 304 71790	SUPPORT CD
222	4822 529 10387	RUBBER DAMPER CD DRIVE, FRONT
223	4822 529 10387	RUBBER DAMPER CD DRIVE, FRONT
230	3103 308 11940	CLAMPER ASSY DA11
240	3103 309 05350	CD DRIVE MCD1B

Only those parts of which a service code number is stated are normal service parts.

ELECTRICAL PARTSLIST *DISPLAY BOARD*

MISCELLANEOUS

1413	4822 265 11515	FFC-CONNECTOR, 8P, TOP ENTRY
1414	2422 025 16979	FFC-CONNECTOR 4P, SIDE ENTRY
1416	4822 265 11207	FFC-CONNECTOR, 6P, SIDE ENTRY
1417	4822 265 11207	FFC-CONNECTOR, 6P, SIDE ENTRY
1418	4822 265 10979	FFC-CONNECTOR, 15P, SIDE ENTRY
1422	4822 276 13114	TACT SWITCH
1423	4822 276 13114	TACT SWITCH
1424	4822 276 13114	TACT SWITCH
1425	4822 276 13114	TACT SWITCH
1426	4822 276 13114	TACT SWITCH
1427	4822 276 13114	TACT SWITCH
1428	4822 276 13114	TACT SWITCH
1429	4822 276 13114	TACT SWITCH
1432	4822 276 13114	TACT SWITCH
1433	4822 276 13114	TACT SWITCH
1434	4822 276 13114	TACT SWITCH
1435	4822 276 13114	TACT SWITCH
1436	4822 276 13114	TACT SWITCH
1438	4822 276 13114	TACT SWITCH
1439	4822 276 13114	TACT SWITCH
1441	4822 276 13114	TACT SWITCH
7402	3103 308 54540	DISPLAY, FTD CDR79x
7403	4822 130 10165	GP1U28XP, IR EYE

CAPACITORS

2400©	2238 586 59812	100nF	10%	50V
2401©	4822 126 14238	2,2nF	10%	50V
2404©	5322 126 11578	1nF	10%	63V
2405©	5322 126 11578	1nF	10%	63V
2406©	2238 586 59812	100nF	10%	50V
2407©	2238 586 59812	100nF	10%	50V
2408©	4822 122 33752	15pF	5%	50V
2409©	4822 122 33752	15pF	5%	50V
2410©	5322 126 11583	10nF	10%	63V
2411©	3198 017 44740	470nF	20%	10V
2412©	5322 126 11583	10nF	10%	63V
2413	3198 029 52290	22µF	20%	50V
2414	4822 124 41751	47µF	20%	16V
2415	4822 124 81286	47µF	20%	16V
2416©	2238 586 59812	100nF	10%	50V
2418	4822 124 40433	47µF	20%	25V
2420©	5322 126 11583	10nF	10%	63V
2422©	5322 126 11578	1nF	10%	63V
2423©	4822 122 33777	47pF	5%	63V
2424©	4822 122 33777	47pF	5%	63V
2426©	4822 122 33777	47pF	5%	63V

RESISTORS

3400©	4822 051 30683	68kΩ	5%	0,06W
3401©	4822 051 30683	68kΩ	5%	0,06W
3402©	4822 051 30683	68kΩ	5%	0,06W
3403©	4822 051 30683	68kΩ	5%	0,06W
3404©	4822 051 30683	68kΩ	5%	0,06W
3405©	4822 051 30683	68kΩ	5%	0,06W
3406©	4822 051 30103	10kΩ	5%	0,06W
3408©	4822 051 30683	68kΩ	5%	0,06W
3410©	4822 051 30683	68kΩ	5%	0,06W
3412©	4822 051 30683	68kΩ	5%	0,06W
3413©	4822 051 30683	68kΩ	5%	0,06W
3420©	4822 051 30102	1kΩ	5%	0,06W
3421©	4822 051 30102	1kΩ	5%	0,06W
3423©	4822 051 30221	220Ω	5%	0,06W

RESISTORS

3424©	4822 051 30101	100Ω	5%	0,06W
3425©	4822 051 30471	470Ω	5%	0,06W
3426©	4822 051 30102	1kΩ	5%	0,06W
3427©	4822 051 30471	470Ω	5%	0,06W
3428©	4822 051 30471	470Ω	5%	0,06W
3429©	4822 051 30471	470Ω	5%	0,06W
3430©	4822 051 30471	470Ω	5%	0,06W
3431©	4822 051 30471	470Ω	5%	0,06W
3433©	4822 051 30221	220Ω	5%	0,06W
3434©	4822 051 30471	470Ω	5%	0,06W
3435©	4822 051 30471	470Ω	5%	0,06W
3436©	4822 051 30471	470Ω	5%	0,06W
3437©	4822 051 30471	470Ω	5%	0,06W
3438©	4822 051 30101	100Ω	5%	0,06W
3439©	4822 051 30103	10kΩ	5%	0,06W
3440©	4822 051 30102	1kΩ	5%	0,06W
3443©	4822 051 30471	470Ω	5%	0,06W
3444©	4822 051 30471	470Ω	5%	0,06W
3445©	4822 051 30471	470Ω	5%	0,06W
3446©	4822 051 30471	470Ω	5%	0,06W
3447©	4822 051 30471	470Ω	5%	0,06W
3448©	4822 051 30471	470Ω	5%	0,06W
3449©	4822 051 30272	2,7kΩ	5%	0,06W
3450©	4822 051 30221	220Ω	5%	0,06W
3451©	4822 051 30271	270Ω	5%	0,06W
3452©	4822 051 30391	390Ω	5%	0,06W
3453©	4822 051 30561	560Ω	5%	0,06W
3454©	4822 117 12968	820Ω	5%	0,06W
3455©	4822 117 11817	1,2kΩ	1%	0,06W
3456©	4822 117 12903	1,8kΩ	1%	0,06W
3457©	4822 051 30392	3,9kΩ	5%	0,06W
3458©	4822 051 30103	10kΩ	5%	0,06W
3459©	4822 051 30151	150Ω	5%	0,06W
3460©	4822 051 30272	2,7kΩ	5%	0,06W
3461©	4822 051 30221	220Ω	5%	0,06W
3462©	4822 051 30271	270Ω	5%	0,06W
3463©	4822 051 30391	390Ω	5%	0,06W
3464©	4822 051 30561	560Ω	5%	0,06W
3465©	4822 051 30221	220Ω	5%	0,06W
3466©	4822 051 30271	270Ω	5%	0,06W
3467©	4822 051 30391	390Ω	5%	0,06W
3471©	4822 051 30102	1kΩ	5%	0,06W
3472©	4822 117 12891	220kΩ	1%	0,06W
3473©	4822 117 12891	220kΩ	1%	0,06W
3474▲	4822 052 10228	2,2Ω	5%	0,33W
3475©	4822 051 30103	10kΩ	5%	0,06W
3477©	4822 051 30181	180Ω	5%	0,06W
3478©	4822 051 30103	10kΩ	5%	0,06W
3479©	4822 051 30151	150Ω	5%	0,06W
3480©	4822 051 30151	150Ω	5%	0,06W
3484©	4822 051 30471	470Ω	5%	0,06W
3485©	4822 051 30471	470Ω	5%	0,06W
3486©	4822 051 30472	4,7kΩ	5%	0,06W
3487©	4822 051 30472	4,7kΩ	5%	0,06W
3488©	4822 051 30682	6,8kΩ	5%	0,06W
3494©	4822 051 30272	2,7kΩ	5%	0,06W
3495	4822 050 21003	10kΩ	2%	0,25W
3496©	4822 051 30472	4,7kΩ	5%	0,06W
3499©	4822 051 30102	1kΩ	5%	0,06W
3505©	4822 051 30181	180Ω	5%	0,06W
3506©	4822 051 30103	10kΩ	5%	0,06W
3509©	4822 051 30103	10kΩ	5%	0,06W
3510©	4822 051 30103	10kΩ	5%	0,06W

ELECTRICAL PARTSLIST DISPLAY BOARD**ELECTRICAL PARTSLIST KEY BOARD****RESISTORS**

3513	4822 051 30471	470Ω	5%	0,06W
3516	4822 052 10228	2,2Ω	5%	0,33W
3517	4822 051 30472	4,7kΩ	5%	0,06W
3518	4822 051 30472	4,7kΩ	5%	0,06W
3519	4822 051 30472	4,7kΩ	5%	0,06W

3520	4822 051 30472	4,7kΩ	5%	0,06W
3521	4822 051 30101	100Ω	5%	0,06W
3522	4822 051 30101	100Ω	5%	0,06W
3523	4822 051 30101	100Ω	5%	0,06W
3524	4822 051 30101	100Ω	5%	0,06W

4401	4822 051 20008	CHIP JUMPER 0805
4402	4822 051 30008	CHIP JUMPER 0603
4404	4822 051 30008	CHIP JUMPER 0603
4405	4822 051 30008	CHIP JUMPER 0603
4406	4822 051 30008	CHIP JUMPER 0603

4408	4822 051 30008	CHIP JUMPER 0603
4409	4822 051 30008	CHIP JUMPER 0603
4410	4822 051 30008	CHIP JUMPER 0603
4411	4822 051 30008	CHIP JUMPER 0603

COILS

1400	2422 540 98526	RESONATOR 10MHz
5400	4822 157 62552	2,2μH

DIODES

6400	3198 010 53380	BZX79-B3V3
6429	9322 147 85685	LST770-KL, RED
6431	9322 147 85685	LST770-KL, RED
6434	4822 130 30621	1N4148

TRANSISTORS

7405	5322 130 60159	BC846B
7406	5322 130 60159	BC846B
7412	5322 130 60159	BC846B
7413	5322 130 60159	BC846B
7416	5322 130 60159	BC846B

INTEGRATED CIRCUITS

7409	9965 000 04931	M24C01-WMN6, EEPROM
7414	3103 308 84560	M30218FCFP, uP FLASH PROG. V12

MISCELLANEOUS

0060	4822 265 11207	FFC-CONNECTOR, 6P, SIDE ENTRY
1450	4822 276 13114	TACT SWITCH
1451	4822 276 13114	TACT SWITCH
1452	4822 276 13114	TACT SWITCH
1453	4822 276 13114	TACT SWITCH

1454	4822 276 13114	TACT SWITCH
------	----------------	-------------

RESISTORS

3550	4822 117 12968	820Ω	5%	0,06W
3551	4822 117 11817	1,2kΩ	1%	0,06W
3552	4822 117 12903	1,8kΩ	1%	0,06W
3553	4822 051 30392	3,9kΩ	5%	0,06W
3554	4822 051 30103	10kΩ	5%	0,06W

3555	4822 051 30391	390Ω	5%	0,06W
3556	4822 117 13501	82Ω	5%	0,6W
3557	4822 050 21003	10kΩ	2%	0,25W
3558	4822 050 21003	10kΩ	2%	0,25W

DIODES

6450	9322 147 85685	LST770-KL, RED
6451	9322 147 83685	LBT776-K1L1, BLUE

TRANSISTORS

7450	5322 130 60159	BC846B
7451	5322 130 60159	BC846B

ELECTRICAL PARTSLIST LIGHTGUIDE BOARD**MISCELLANEOUS**

1460	2422 025 16979	FFC-CONNECTOR, 4P, SIDE ENTRY
------	----------------	-------------------------------

RESISTORS

3570	4822 051 30479	47Ω	5%	0,06W
3571	4822 051 30479	47Ω	5%	0,06W
3572	4822 051 30479	47Ω	5%	0,06W
3573	4822 051 30121	120Ω	5%	0,06W
3574	4822 051 30121	120Ω	5%	0,06W

3575	4822 051 30121	120Ω	5%	0,06W
3576	4822 051 30121	120Ω	5%	0,06W
4461	4822 051 30008	CHIP JUMPER 0603		
4463	4822 051 30008	CHIP JUMPER 0603		

DIODES

6462	9322 147 85685	LST770-KL, RED
6463	9322 147 83685	LBT776-K1L1, BLUE
6464	9322 147 85685	LST770-KL, RED
6465	9322 147 83685	LBT776-K1L1, BLUE

6466	9322 147 85685	LST770-KL, RED
6468	9322 147 83685	LBT776-K1L1, BLUE
6469	9322 147 85685	LST770-KL, RED

ELECTRICAL PARTSLIST HEADPHONE BOARD**MISCELLANEOUS**

1500	4822 265 11207	FFC-CONNECTOR, 6P, SIDE ENTRY
1501	4822 267 31453	HEADPHONE SOCKET 6,3mm
1505	2422 128 03032	TACT SWITCH

CAPACITORS

2500	4822 124 81286	47 μ F	20%	16V
2501	4822 124 12032	4,7 μ F	20%	50V
2502©	4822 126 13881	470pF	5%	50V
2503©	5322 126 11579	3,3nF	10%	63V
2504©	4822 126 14315	390pF	5%	50V

2505	4822 124 81286	47 μ F	20%	16V
2506	4822 124 12032	4,7 μ F	20%	50V
2507©	2238 586 59812	100nF	10%	50V
2508©	4822 126 13881	470pF	5%	50V
2509©	5322 126 11579	3,3nF	10%	63V

2510©	4822 126 14315	390pF	5%	50V
2511©	2238 586 59812	100nF	10%	50V
2512©	2238 586 59812	100nF	10%	50V
2513©	2238 586 59812	100nF	10%	50V

RESISTORS

3500▲	4822 052 10109	10 Ω	5%	NFR
3501©	4822 051 30102	1k Ω	5%	0,06W
3502	4822 101 21199	POTMETER 2x10K Ω		
3503©	4822 117 12139	22 Ω	5%	0,06W
3504©	4822 051 30101	100 Ω	5%	0,06W

3505©	4822 051 30103	10k Ω	5%	0,06W
3506©	4822 051 30103	10k Ω	5%	0,06W
3507▲	4822 052 10109	10 Ω	5%	NFR
3508©	4822 051 30472	4,7k Ω	5%	0,06W
3509©	4822 051 30102	1k Ω	5%	0,06W

3511©	4822 117 12139	22 Ω	5%	0,06W
3512©	4822 051 30101	100 Ω	5%	0,06W
3513©	4822 051 30103	10k Ω	5%	0,06W
3514©	4822 051 30103	10k Ω	5%	0,06W
3515©	4822 051 30472	4,7k Ω	5%	0,06W

3516©	4822 051 30561	560 Ω	5%	0,06W
4503©	4822 051 30008	CHIP JUMPER 0603		
4506©	4822 051 30008	CHIP JUMPER 0603		
4509©	4822 051 30008	CHIP JUMPER 0603		

INTEGRATED CIRCUITS

7500©	4822 209 31378	NJM4556M, 2-FOLD OP-AMP.
-------	----------------	--------------------------

ELECTRICAL PARTSLIST INTERFACE BOARD**MISCELLANEOUS**

1303	4822 267 10953	FFC-CONNECTOR, 7P, TOP ENTRY
1307	4822 265 10981	FFC-CONNECTOR, 15P, TOP ENTRY
1308	2422 025 14518	FFC-CONNECTOR, 9P, TOP ENTRY
1314	4822 267 31448	CINCH SOCKET, 2-FOLD
1315	4822 265 11151	CINCH SOCKET, 4-FOLD

1316	4822 267 10731	FFC-CONNECTOR, 6P, TOP ENTRY
7312	4822 218 11487	OPTICAL CONNECTOR, GP1F32R

CAPACITORS

2302	4822 124 40196	220µF	20%	16V
2304	4822 124 40196	220µF	20%	16V
2314	4822 124 80791	470µF	20%	16V
2315	4822 124 40207	100µF	20%	25V
2316	2238 586 59812	100nF	10%	50V

2318	4822 121 70654	2,2nF	10%	50V
2319	4822 121 70654	2,2nF	10%	50V
2320	2238 586 59812	100nF	10%	50V
2321	4822 124 80791	470µF	20%	16V
2322	4822 124 21913	1µF	20%	63V

2324	4822 124 80791	470µF	20%	16V
2325	4822 122 33753	150pF	5%	50V
2326	4822 122 33753	150pF	5%	50V
2327	4822 124 40207	100µF	20%	25V
2328	5322 126 11583	10nF	10%	63V

2329	4822 124 40769	4,7µF	20%	100V
2330	2238 586 59812	100nF	10%	50V
2331	2238 586 59812	100nF	10%	50V
2336	2238 586 59812	100nF	10%	50V
2338	2238 586 59812	100nF	10%	50V

2339	2238 586 59812	100nF	10%	50V
2340	2238 586 59812	100nF	10%	50V
2341	4822 122 33753	150pF	5%	50V
2342	2238 586 59812	100nF	10%	50V
2343	3198 016 31020	1nF	5%	25V

2344	2238 586 59812	100nF	10%	50V
------	----------------	-------	-----	-----

RESISTORS

3302	4822 051 30332	3,3kΩ	5%	0,06W
3304	4822 051 30222	2,2kΩ	5%	0,06W
3306	4822 051 30103	10kΩ	5%	0,06W
3307	4822 052 10229	22Ω	5%	0,33W
3309	4822 116 83872	220Ω	5%	0,5W

3311	4822 051 30479	47Ω	5%	0,06W
3313	4822 051 30479	47Ω	5%	0,06W
3314	4822 117 12925	47kΩ	1%	0,06W
3315	4822 116 83872	220Ω	5%	0,5W
3316	4822 051 30102	1kΩ	5%	0,06W

3317	4822 051 30102	1kΩ	5%	0,06W
3318	4822 116 83872	220Ω	5%	0,5W
3319	4822 117 12925	47kΩ	1%	0,06W
3330	4822 116 52195	47Ω	5%	0,5W
3331	4822 051 30103	10kΩ	5%	0,06W

3334	4822 051 30102	1kΩ	5%	0,06W
3335	4822 051 30101	100Ω	5%	0,06W
3337	4822 051 30101	100Ω	5%	0,06W
3338	4822 117 13632	100kΩ	1%	0,06W
3339	4822 051 30222	2,2kΩ	5%	0,06W

3340	4822 051 30471	470Ω	5%	0,06W
3342	4822 116 52195	47Ω	5%	0,5W
3343	4822 051 30561	560Ω	5%	0,06W
3344	4822 117 12903	1,8kΩ	1%	0,06W
3345	4822 051 30561	560Ω	5%	0,06W

RESISTORS

3347	4822 051 30561	560Ω	5%	0,06W
3346	4822 051 30102	1kΩ	5%	0,06W
3348	4822 117 12925	47kΩ	1%	0,06W
3349	4822 117 12925	47kΩ	1%	0,06W
3354	4822 051 30181	180Ω	5%	0,06W

3355	2120 108 91909	39Ω	5%	
3391	4822 117 12063	10kΩ NTC		
4301	4822 051 30008	CHIP JUMPER 0603		
4302	4822 051 30008	CHIP JUMPER 0603		
4303	4822 051 30008	CHIP JUMPER 0603		

4307	4822 051 30008	CHIP JUMPER 0603		
------	----------------	------------------	--	--

COILS

5300	2422 536 00019	TRANSFORMER, DIGITAL OUT		
------	----------------	--------------------------	--	--

TRANSISTORS

7321	4822 130 44568	BC557B		
7323	5322 130 60159	BC846B		

INTEGRATED CIRCUITS

7313	4822 130 10845	LED (OPTICAL OUT)		
7320	4822 209 30095	LM833D, 2-FOLD OP-AMP.		
7324	4822 209 17235	74LVU04D, 6-FOLD INVERTER		

ELECTRICAL PARTSLIST CD LOADER

MISCELLANEOUS

1800	2422 025 12133	FFC-CONNECTOR, 16P, SIDE ENTRY
1802	2422 025 16833	FFC-CONNECTOR, 8P, SIDE ENTRY
1805	4822 265 11531	FFC-CONNECTOR, 9P, SIDE ENTRY
1832	2422 129 16655	LEAF SWITCH 1P
8000	3103 308 92850	FLEXFOIL CABLE, 16P, 100mm BD

CAPACITORS

2800	4822 124 22726	4,7 μ F	20%	35V
2801	4822 126 14241	330pF	5%	50V
2802	4822 126 14241	330pF	5%	50V
2803	4822 126 14315	390pF	5%	50V
2804	4822 126 14315	390pF	5%	50V
2805	4822 126 14315	390pF	5%	50V
2806	4822 126 14315	390pF	5%	50V
2807	4822 126 13883	220pF	5%	50V
2808	4822 126 13883	220pF	5%	50V
2809	4822 126 13883	220pF	5%	50V
2810	4822 126 13883	220pF	5%	50V
2811	4822 126 13883	220pF	5%	50V
2812	4822 126 13883	220pF	5%	50V
2813	4822 126 13879	220nF	20%	16V
2814	4822 126 13193	4,7nF	10%	63V
2815	4822 124 22726	4,7 μ F	20%	35V
2816	3198 024 44730	47nF	5%	50V
2817	4822 124 22726	4,7 μ F	20%	35V
2819	4822 124 22726	4,7 μ F	20%	35V
2820	3198 024 44730	47nF	5%	50V
2821	3198 016 38210	820pF	10%	25V
2822	5322 126 11579	3,3nF	10%	63V
2824	3198 024 44730	47nF	5%	50V
2825	4822 126 13956	68pF	5%	63V
2828	4822 126 11663	12pF	5%	50V
2829	4822 126 14043	1 μ F	20%	16V
2831	4822 126 11669	27pF	10%	50V
2832	4822 126 14238	2,2nF	10%	50V
2833	4822 126 14247	1,5nF	10%	50V
2835	4822 124 12362	47 μ F	20%	4V
2836	4822 124 12362	47 μ F	20%	4V
2837	4822 126 11669	27pF	10%	50V
2838	5322 126 11578	1nF	10%	63V
2839	2238 916 11552	1,5nF	5%	25V
2840	5322 124 41948	0,47 μ F	20%	50V
2842	2238 916 11552	1,5nF	5%	25V
2843	4822 126 14305	100nF	10%	16V
2844	2222 867 15339	33pF	5%	50V
2845	2222 867 15339	33pF	5%	50V
2846	3198 016 31020	1nF	5%	25V
2847	3198 016 31020	1nF	5%	25V
2848	3198 016 31020	1nF	5%	25V
2849	3198 016 31020	1nF	5%	25V
2851	3198 024 44730	47nF	5%	50V
2852	3198 024 44730	47nF	5%	50V
2853	4822 126 14305	100nF	10%	16V
2854	3198 024 44730	47nF	5%	50V
2856	4822 126 13879	220nF	20%	16V
2857	4822 124 80144	220 μ F	20%	25V
2858	4822 126 14305	100nF	10%	16V
2864	4822 124 81286	47 μ F	20%	16V
2868	3198 024 44730	47nF	5%	50V
2876	3198 024 44730	47nF	5%	50V
2877	4822 126 14305	100nF	10%	16V
2878	4822 126 14305	100nF	10%	16V
2880	4822 122 31765	100pF	5%	50V
2883	4822 126 14043	1 μ F	20%	16V
2884	4822 126 14043	1 μ F	20%	16V

RESISTORS

2823	4822 051 30008	CHIP JUMPER 0603
3800	4822 051 20159	15 Ω 5% 0,1W
3801	4822 051 20159	15 Ω 5% 0,1W
3802	4822 051 30332	3,3k Ω 5% 0,06W
3803	4822 051 30332	3,3k Ω 5% 0,06W
3804	4822 051 30332	3,3k Ω 5% 0,06W
3805	4822 051 30332	3,3k Ω 5% 0,06W
3806	4822 051 30223	22k Ω 5% 0,06W
3807	4822 051 30223	22k Ω 5% 0,06W
3808	4822 051 30153	15k Ω 5% 0,06W
3809	4822 051 30153	15k Ω 5% 0,06W
3810	4822 051 30153	15k Ω 5% 0,06W
3811	4822 051 30153	15k Ω 5% 0,06W
3814	4822 051 30103	10k Ω 5% 0,06W
3815	4822 051 30103	10k Ω 5% 0,06W
3816	4822 051 30103	10k Ω 5% 0,06W
3817	4822 051 30103	10k Ω 5% 0,06W
3818	4822 051 30103	10k Ω 5% 0,06W
3819	4822 051 30103	10k Ω 5% 0,06W
3820	4822 052 10478	4,7 Ω 5% NFR25
3821	4822 117 13608	4,7 Ω 5% 0,06W
3822	4822 051 30223	22k Ω 5% 0,06W
3823	4822 051 30683	68k Ω 5% 0,06W
3824	4822 051 30472	4,7k Ω 5% 0,06W
3825	4822 051 30102	1k Ω 5% 0,06W
3826	4822 051 10102	1k Ω 2% 0,25W
3827	4822 051 30103	10k Ω 5% 0,06W
3828	4822 117 11373	100 Ω 1% 0,1W
3829	4822 051 30471	470 Ω 5% 0,06W
3831	4822 051 30101	100 Ω 5% 0,06W
3832	4822 051 30273	27k Ω 5% 0,06W
3833	4822 117 12925	47k Ω 1% 0,06W
3834	4822 051 30008	CHIP JUMPER 0603
3835	4822 051 30223	22k Ω 5% 0,06W
3836	4822 117 13632	100k Ω 1% 0,06W
3839	4822 051 30223	22k Ω 5% 0,06W
3840	4822 051 30152	1,5k Ω 5% 0,06W
3841	4822 117 11817	1,2k Ω 1% 0,06W
3842	4822 051 30102	1k Ω 5% 0,06W
3843	4822 051 30223	22k Ω 5% 0,06W
3844	4822 051 30331	330 Ω 5% 0,06W
3845	4822 051 30392	3,9k Ω 5% 0,06W
3846	4822 051 30472	4,7k Ω 5% 0,06W
3848	4822 051 30102	1k Ω 5% 0,06W
3849	4822 051 30334	330k Ω 5% 0,06W
3850	4822 051 30334	330k Ω 5% 0,06W
3856	4822 051 30223	22k Ω 5% 0,06W
3857	4822 051 20159	15 Ω 5% 0,1W
3858	4822 051 20339	33 Ω 5% 0,1W
3862	4822 051 30103	10k Ω 5% 0,06W
3863	4822 051 30471	470 Ω 5% 0,06W
3864	4822 051 30471	470 Ω 5% 0,06W
3865	4822 051 30471	470 Ω 5% 0,06W
3866	4822 051 30471	470 Ω 5% 0,06W
3867	4822 051 30471	470 Ω 5% 0,06W
3868	4822 051 30103	10k Ω 5% 0,06W
3869	4822 051 30103	10k Ω 5% 0,06W
3871	4822 051 30103	10k Ω 5% 0,06W
3873	4822 051 30103	10k Ω 5% 0,06W
3877	4822 051 30121	120 Ω 5% 0,06W
3878	4822 051 20121	120 Ω 5% 0,1W
3879	4822 051 30183	18k Ω 5% 0,06W
3880	4822 051 30103	10k Ω 5% 0,06W
3881	4822 051 30103	10k Ω 5% 0,06W
3882	4822 051 30223	22k Ω 5% 0,06W

ELECTRICAL PARTSLIST CD LOADER**RESISTORS**

3883	4822 051 30103	10kΩ	5%	0,06W
3884	4822 051 30102	1kΩ	5%	0,06W
3885	4822 051 30102	1kΩ	5%	0,06W
3886	4822 051 30102	1kΩ	5%	0,06W
3887	4822 117 12864	82kΩ	5%	0,06W

3889	4822 051 30273	27kΩ	5%	0,06W
3890	4822 117 12902	8,2kΩ	1%	0,06W
3891	4822 117 13632	100kΩ	1%	0,06W
3892	4822 051 30153	15kΩ	5%	0,06W
3894	4822 117 12864	82kΩ	5%	0,06W

3895	4822 051 30273	27kΩ	5%	0,06W
3896	4822 117 12902	8,2kΩ	1%	0,06W
3907	4822 051 30471	470Ω	5%	0,06W
3908	4822 051 30101	100Ω	5%	0,06W
3910	2322 704 65603	56kΩ	1%	0,06W

3911	2322 704 65603	56kΩ	1%	0,06W
3912	2322 704 65603	56kΩ	1%	0,06W
3913	2322 704 65603	56kΩ	1%	0,06W
3914	4822 117 11503	220Ω	5%	0,1W
3915	4822 117 11503	220Ω	5%	0,1W

3923	4822 117 11373	100Ω	1%	0,1W
3924	4822 051 20339	33Ω	5%	0,1W
3944	4822 051 20229	22Ω	5%	0,1W
3953	4822 051 30103	10kΩ	5%	0,06W
3954	4822 051 30103	10kΩ	5%	0,06W

3955	4822 051 30103	10kΩ	5%	0,06W
3963	4822 051 20229	22Ω	5%	0,1W
3964	4822 051 20008	CHIP JUMPER 0805		
3965	4822 051 20008	CHIP JUMPER 0805		
3980	4822 051 30153	15kΩ	5%	0,06W

3981	4822 051 30103	10kΩ	5%	0,06W
3982	4822 051 30479	47Ω	5%	0,06W
3983	4822 051 30479	47Ω	5%	0,06W
4804	4822 051 20008	CHIP JUMPER 0805		
4806	4822 051 20008	CHIP JUMPER 0805		

4815	4822 051 20008	CHIP JUMPER 0805		
4816	4822 051 20008	CHIP JUMPER 0805		
4818	4822 051 20008	CHIP JUMPER 0805		
4819	4822 051 20008	CHIP JUMPER 0805		
4820	4822 051 20008	CHIP JUMPER 0805		

4821	4822 051 20008	CHIP JUMPER 0805		
4822	4822 051 20008	CHIP JUMPER 0805		
4823	4822 051 20008	CHIP JUMPER 0805		
4824	4822 051 20008	CHIP JUMPER 0805		
4825	4822 051 20008	CHIP JUMPER 0805		

4826	4822 051 20008	CHIP JUMPER 0805		
4827	4822 051 20008	CHIP JUMPER 0805		
4829	4822 051 20008	CHIP JUMPER 0805		
4830	4822 051 20008	CHIP JUMPER 0805		
4831	4822 051 20008	CHIP JUMPER 0805		

4832	4822 051 20008	CHIP JUMPER 0805		
4833	4822 051 20008	CHIP JUMPER 0805		
4834	4822 051 20008	CHIP JUMPER 0805		
4836	4822 051 20008	CHIP JUMPER 0805		
4837	4822 051 20008	CHIP JUMPER 0805		

4838	4822 051 20008	CHIP JUMPER 0805		
4839	4822 051 20008	CHIP JUMPER 0805		
4842	4822 051 20008	CHIP JUMPER 0805		
4843	4822 051 20008	CHIP JUMPER 0805		
4844	4822 051 20008	CHIP JUMPER 0805		

4845	4822 051 20008	CHIP JUMPER 0805		
4846	4822 051 20008	CHIP JUMPER 0805		
4847	4822 051 20008	CHIP JUMPER 0805		
4848	4822 051 20008	CHIP JUMPER 0805		
4849	4822 051 20008	CHIP JUMPER 0805		

RESISTORS

4850	4822 051 20008	CHIP JUMPER 0805		
4851	4822 051 20008	CHIP JUMPER 0805		
4852	4822 051 20008	CHIP JUMPER 0805		
4854	4822 051 20008	CHIP JUMPER 0805		
4855	4822 051 20008	CHIP JUMPER 0805		

4856	4822 051 20008	CHIP JUMPER 0805		
4857	4822 051 20008	CHIP JUMPER 0805		
4858	4822 051 20008	CHIP JUMPER 0805		
4861	4822 051 20008	CHIP JUMPER 0805		
4862	4822 051 20008	CHIP JUMPER 0805		

4864	4822 051 20008	CHIP JUMPER 0805		
4865	4822 051 20008	CHIP JUMPER 0805		
4866	4822 051 20008	CHIP JUMPER 0805		
4867	4822 051 20008	CHIP JUMPER 0805		
4868	4822 051 20008	CHIP JUMPER 0805		

4869	4822 051 20008	CHIP JUMPER 0805		
4871	4822 051 20008	CHIP JUMPER 0805		

COILS

1810	2422 543 01068	RESONATOR 8MHZ		
------	----------------	----------------	--	--

DIODES

6802	9322 129 34685	BZX284-C3V9		
6804	9340 548 52115	BZX284-C5V1		

TRANSISTORS

7800	4822 130 60511	BC847B		
7802	4822 130 60511	BC847B		
7803	4822 130 60511	BC847B		
7804	5322 130 42718	BFS20		
7805	5322 130 42756	BC857C		

7806	4822 130 60511	BC847B		
7807	5322 130 42755	BC847C		
7816	4822 130 60511	BC847B		

INTEGRATED CIRCUITS

7801	4822 209 17286	TZA1024T/N1, HF-Amplifier		
7811	9352 684 20557	SAA7325H/T/M2B, Signal Processor		
7815	4822 209 62059	TCA0372DP1, 2-FOLD OP-AMP.		
7819	9322 158 56682	M63000SP, Motor driver		
7820	4822 209 72554	MC7808CT 8V Regulator		