

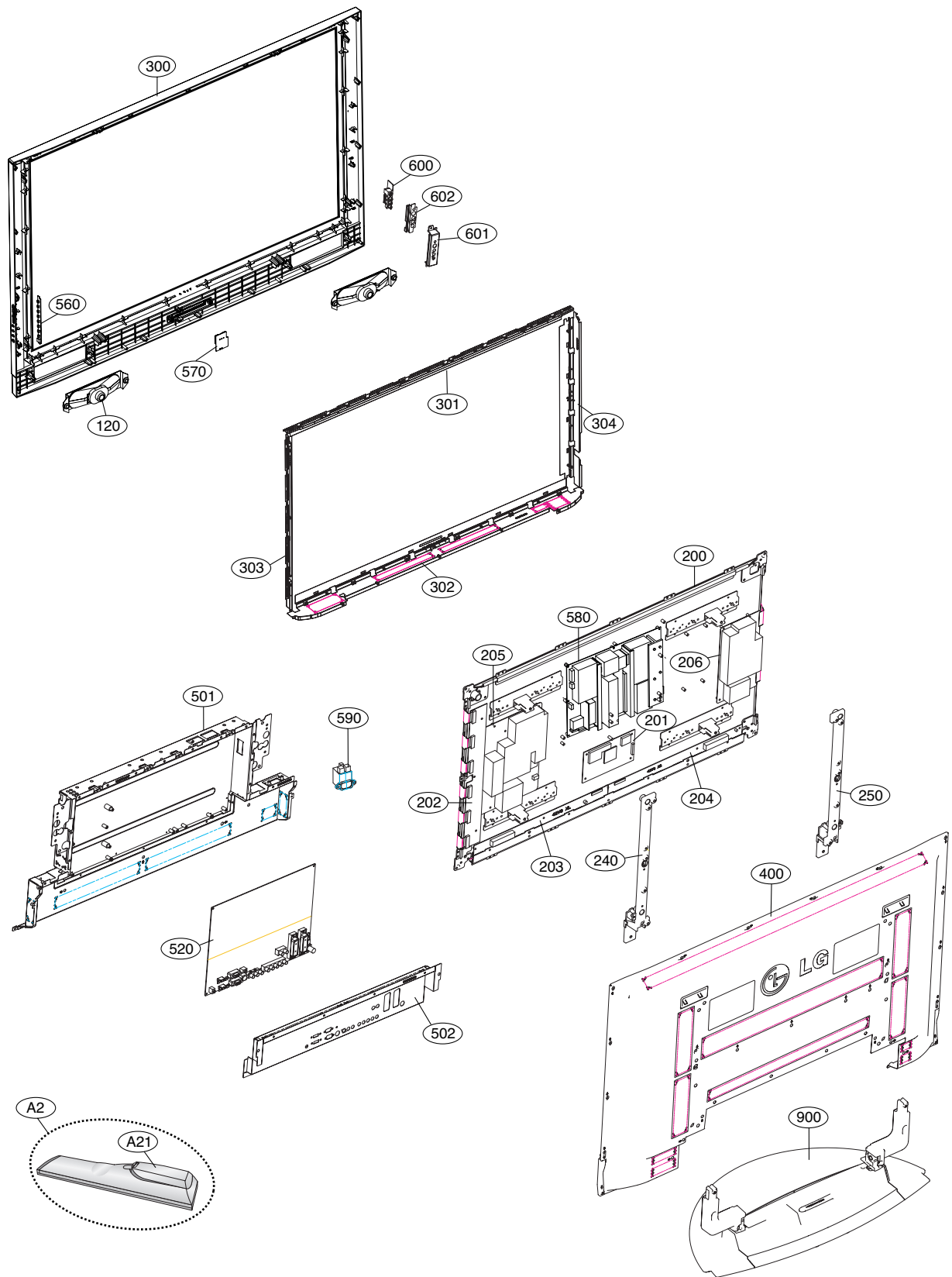













# EXPLODED VIEW



# EXPLODED VIEW PARTS LIST

The components identified by mark  is critical for safety.  
Replace only with part number specified.

No.	Part No.	Descriptions	
120	EAB30829201	Speaker, Woofer g1560102 ND 15W 8OHM 82DB 100HZ 193 X 57 X 50 LUG MACOM	
	200	EAJ38199501	PDP, Module-XGA PDP42X40523.ASLGB XGA 42INCH 1024X768 16/9 PDP DIVISION
	201	EBR36954101	Hand Insert PCB Assembly, CTRL ASS'Y HAND INSERT 42" X4A CTRL PDP DIVISION
	202	EBR36939101	Hand Insert PCB Assembly, YDRV ASS'Y HAND INSERT 42" X4A AU Layer 4 PDP DIVISION
	203	EBR36925801	Hand Insert PCB Assembly, XRLT ASS'Y HAND INSERT 42" X4A Layer 4 PDP DIVISION
	204	EBR36939201	Hand Insert PCB Assembly, XRRT ASS'Y HAND INSERT 42" X4A PDP DIVISION
	205	EBR36954501	Hand Insert PCB Assembly, YSUS ASS'Y HAND INSERT 42" X4A YSUS PDP DIVISION
	206	EBR36921701	Hand Insert PCB Assembly, ZSUS ASS'Y HAND INSERT 42" X4A 2 Layer (OSP) PDP DIVISION
240	4980900366C	Supporter, CASTING ALDC NON AL NON	
250	4980900366D	Supporter, CASTING ALDC NON AL NON	
	300	30919E0076D	Cover Assembly, 42PC35-ZC.KEUYLMP PD74A 42" LGEMA B/K SPRAY APPLY
301	4980900367A	Supporter, ASSY AL FILTER TOP,42PC1,LGEMA	
302	4980900368A	Supporter, ASSY AL FILTER BOTT, 42PC1,LGEMA	
303	4980900369A	Supporter, ASSY AL ASSY AL FILTER RIGHT, 42PC1,LGEMA	
304	4980900370B	Supporter, PRESS AL 0.8 Supporter AL FILTER 42PC35-ZC APPLY (GASKET 3t)	
	400	MCK30275905	Cover, PRESS PCM 0.4 42PC35-ZC AL WITHOUT HANDLE 42PC3 ANALOG TYPE
	501	AGU30208005	Plate Assembly, ASSY AV PLATE 42PC35-ZC EUROPASS3 CHASSIS APPLY
502	AGU34705202	Plate Assembly, REAR AV PLATE COVER ASSEMBLE 42PC35 & 50PC35 EU EUROPASS3 BASIC PRESS	
520	EBR39660222	Hand Insert PCB Assembly, Main MAIN M.I PD73A 42PC35-ZC KEKLLMP Hand Insert PCB Assembly MAIN for MA_CKD	
560	68719SML76A	Hand Insert PCB Assembly, Sub SUB M.I PD61A 42PC3D-EC . -	
570	EBR40151401	PCB Assembly, Sub SUB T.T PD73A 42PC35-ZC KEKLLMP SUB IR PCB Package Assembly for MA CKD	
	580	EAY32808901	SMPS, AC/DC YPSUJ014A 100VTO240V 400W 50 TO 60HZ UL/CSA/CE/TUV 42INCH XPOWER DISPLAY PSU LG
590	6200J000115	Filter, AC Line IJ-N06CESL1 5.3mH 250VAC 6A 0.22uF 1000pF UL/VDE/CSA/TUV/CCC HOUSING/RING BK DONGJI	
600	EBR39741801	Hand Insert PCB Assembly, Sub SUB M.I PD73A 42PC35 AEULLHX Hand Insert PCB Assembly SUB Side AV	
601	4811900021M	Bracket Assembly, SIDE AV 42PC35 & 50PC35-ZC PD74A EUROPASS3	
602	48149V0003A	Plate, PRESS SPTTE T0.3 SIDE AV 42PC1R	
	900	3501900014R	Base Assembly, STAND AP-42DC11 PN61A FOLDING STAND LGEMA LOCAL ASSEMBLE PHANTOM (B/K COSMETIC)
A2	AKB33871401	Remote Controller Assembly, 19_22LS4D, EU(PAL), LD73B	
A21	MCK36759201	Cover, MOLD ABS HF-380 MKJ339814 ABS, HF-380 TX BATTERY COVER	

# REPLACEMENT PARTS LIST

DATE: 2007. 10. 02.

LOC. NO.	PART NO.	DESCRIPTION / SPECIFICATION	LOC. NO.	PART NO.	DESCRIPTION / SPECIFICATION
<b>CAPACITORS</b>					
C1	0CK104DK56A	0805B104K500CT 100nF 10% 50V X7R	C114	0CK104CF56A	0603B104K160CT 100nF 10% 16V X7R
C100	0CC470CK41A	C1608C0G1H470JT 47pF 5% 50V C0G -	C115	0CK104CF56A	0603B104K160CT 100nF 10% 16V X7R
C100	0CC101CK41A	C1608C0G1H101JT 100pF 5% 50V C0G	C116	0CK104CF56A	0603B104K160CT 100nF 10% 16V X7R
C1003	0CK103CK56A	0603B103K500CT 10nF 10% 50V X7R -	C117	0CK104CF56A	0603B104K160CT 100nF 10% 16V X7R
C1004	0CK103CK56A	0603B103K500CT 10nF 10% 50V X7R -	C118	0CE106WFKDC	MVK4.0TP16VC10M 10uF 20% 16V 16MA
C1005	0CK103CK56A	0603B103K500CT 10nF 10% 50V X7R -	C119	0CK104CF56A	0603B104K160CT 100nF 10% 16V X7R
C1006	0CK103CK56A	0603B103K500CT 10nF 10% 50V X7R -	C120	0CK104CF56A	0603B104K160CT 100nF 10% 16V X7R
C1007	0CK104CK56A	0603B104K500CT 100nF 10% 50V X7R	C1205	0CK393CK56A	0603B393K500CT 39nF 10% 50V X7R -
C1008	0CK104CK56A	0603B104K500CT 100nF 10% 50V X7R	C1206	0CK102CK56A	0603B102K500CT 1nF 10% 50V X7R -5
C1009	0CK104CK56A	0603B104K500CT 100nF 10% 50V X7R	C1207	0CK393CK56A	0603B393K500CT 39nF 10% 50V X7R -
C101	0CK103BH56A	C1005X7R1E103KT- 10nF 10% 25V X7R	C1208	0CK102CK56A	0603B102K500CT 1nF 10% 50V X7R -5
C101	0CH5101K416	C2012C0G1H101JT 100pF 5% 50V C0G	C121	0CK104CF56A	0603B104K160CT 100nF 10% 16V X7R
C101	0CC101CK41A	C1608C0G1H101JT 100pF 5% 50V C0G	C1217	0CE106WH6DC	MVK5.0TP25VC10M 10uF 20% 25V 25MA
C1010	0CK104CK56A	0603B104K500CT 100nF 10% 50V X7R	C122	0CK104CF56A	0603B104K160CT 100nF 10% 16V X7R
C102	0CE106WFKDC	MVK4.0TP16VC10M 10uF 20% 16V 16MA	C1225	0CE106WH6DC	MVK5.0TP25VC10M 10uF 20% 25V 25MA
C102	0CH5330K416	C2012C0G1H330JT 33pF 5% 50V C0G -	C123	0CK104CF56A	0603B104K160CT 100nF 10% 16V X7R
C103	0CE4763F618	ESF476M016T1A5E05G 47uF 20% 16V 6	C1232	0CE107WF6DC	MVK6.3TP16VC100M 100uF 20% 16V 11
C103	0CK104CF56A	0603B104K160CT 100nF 10% 16V X7R	C1234	0CK102CK56A	0603B102K500CT 1nF 10% 50V X7R -5
C104	0CE4763F618	ESF476M016T1A5E05G 47uF 20% 16V 6	C1235	0CK102CK56A	0603B102K500CT 1nF 10% 50V X7R -5
C104	0CK105CD56A	C1608X7R1A105KT 1uF 10% 10V X7R -	C1236	0CE106WH6DC	MVK5.0TP25VC10M 10uF 20% 25V 25MA
C105	0CE4763F618	ESF476M016T1A5E05G 47uF 20% 16V 6	C1237	0CE106WH6DC	MVK5.0TP25VC10M 10uF 20% 25V 25MA
C105	0CK104CF56A	0603B104K160CT 100nF 10% 16V X7R	C1239	0CK104CK56A	0603B104K500CT 100nF 10% 50V X7R
C106	0CK104CF56A	0603B104K160CT 100nF 10% 16V X7R	C124	0CK104CF56A	0603B104K160CT 100nF 10% 16V X7R
C1068	0CE107WF6DC	MVK6.3TP16VC100M 100uF 20% 16V 11	C1244	0CK393CK56A	0603B393K500CT 39nF 10% 50V X7R -
C107	0CK104CF56A	0603B104K160CT 100nF 10% 16V X7R	C1246	0CK393CK56A	0603B393K500CT 39nF 10% 50V X7R -
C108	0CK104CF56A	0603B104K160CT 100nF 10% 16V X7R	C1247	0CE107WF6DC	MVK6.3TP16VC100M 100uF 20% 16V 11
C109	0CK105CD56A	C1608X7R1A105KT 1uF 10% 10V X7R -	C1248	0CC050CK11A	C1608C0G1H050DT 5pF 0.5PF 50V C0G
C110	0CE106WFKDC	MVK4.0TP16VC10M 10uF 20% 16V 16MA	C1249	0CC050CK11A	C1608C0G1H050DT 5pF 0.5PF 50V C0G
C1100	0CC100CK41A	C1608C0G1H100JT 10pF 5% 50V C0G -	C125	0CK104CF56A	0603B104K160CT 100nF 10% 16V X7R
C1101	0CC100CK41A	C1608C0G1H100JT 10pF 5% 50V C0G -	C1250	0CC050CK11A	C1608C0G1H050DT 5pF 0.5PF 50V C0G
C1104	0CK103CK56A	0603B103K500CT 10nF 10% 50V X7R -	C1251	0CC050CK11A	C1608C0G1H050DT 5pF 0.5PF 50V C0G
C1105	0CK103CK56A	0603B103K500CT 10nF 10% 50V X7R -	C1252	0CC050CK11A	C1608C0G1H050DT 5pF 0.5PF 50V C0G
C1106	0CC120CK41A	C1608C0G1H120JT 12pF 5% 50V C0G -	C1253	0CC050CK11A	C1608C0G1H050DT 5pF 0.5PF 50V C0G
C1108	0CC120CK41A	C1608C0G1H120JT 12pF 5% 50V C0G -	C1254	0CC050CK11A	C1608C0G1H050DT 5pF 0.5PF 50V C0G
C111	0CK104CF56A	0603B104K160CT 100nF 10% 16V X7R	C1255	0CC050CK11A	C1608C0G1H050DT 5pF 0.5PF 50V C0G
C1116	0CK104CK56A	0603B104K500CT 100nF 10% 50V X7R	C126	0CK104CF56A	0603B104K160CT 100nF 10% 16V X7R
C1119	0CK104CK56A	0603B104K500CT 100nF 10% 50V X7R	C127	0CK104CF56A	0603B104K160CT 100nF 10% 16V X7R
C112	0CK104CF56A	0603B104K160CT 100nF 10% 16V X7R	C128	0CK104CF56A	0603B104K160CT 100nF 10% 16V X7R
C1120	0CK104CK56A	0603B104K500CT 100nF 10% 50V X7R	C129	0CK104CF56A	0603B104K160CT 100nF 10% 16V X7R
C1121	0CK104CK56A	0603B104K500CT 100nF 10% 50V X7R	C130	0CK104CF56A	0603B104K160CT 100nF 10% 16V X7R
C1123	0CK104CK56A	0603B104K500CT 100nF 10% 50V X7R	C1300	0CK105DH56A	C2012X7R105KFT 1uF 10% 25V X7R -5
C1125	0CK104CK56A	0603B104K500CT 100nF 10% 50V X7R	C1301	0CK104CK56A	0603B104K500CT 100nF 10% 50V X7R
C1128	0CK104CK56A	0603B104K500CT 100nF 10% 50V X7R	C1302	0CE108EH618	KMG5.0TP25VB1000M 1000uF 20% 25V
C113	0CK104CF56A	0603B104K160CT 100nF 10% 16V X7R	C1303	0CK105DH56A	C2012X7R105KFT 1uF 10% 25V X7R -5
C1132	0CC681CK41A	C1608C0G1H681JT 680pF 5% 50V C0G	C1304	0CK104CK56A	0603B104K500CT 100nF 10% 50V X7R
C1133	0CK104BF56A	C1005X7R104KET 100nF 10% 16V X7R	C1305	0CK104CK56A	0603B104K500CT 100nF 10% 50V X7R
C1134	0CK104BF56A	C1005X7R104KET 100nF 10% 16V X7R	C1306	0CK222CK56A	0603B222K500CT 2.2nF 10% 50V X7R
C1135	0CK225DFK4A	C2012Y5V1C225MT 2.2uF 20% 16V Y5V	C1307	0CK682CK51A	C1608Y5P1H682KT 6.8nF 10% 50V Y5P
C1136	0CK104CK56A	0603B104K500CT 100nF 10% 50V X7R	C1308	0CK682CK51A	C1608Y5P1H682KT 6.8nF 10% 50V Y5P
			C1309	0CE475WK6DC	MVK5.0TP50VC4.7M 4.7uF 20% 50V 19

LOC. NO.	PART NO.	DESCRIPTION / SPECIFICATION	LOC. NO.	PART NO.	DESCRIPTION / SPECIFICATION
C131	0CK104CF56A	0603B104K160CT 100nF 10% 16V X7R	C1369	0CK104CK56A	0603B104K500CT 100nF 10% 50V X7R
C1310	0CE475WK6DC	MVK5.0TP50VC4.7M 4.7uF 20% 50V 19	C137	0CK104CF56A	0603B104K160CT 100nF 10% 16V X7R
C1311	0CK104CK56A	0603B104K500CT 100nF 10% 50V X7R	C1370	0CK474EK66A	C3216X7R1H474MT 470nF 20% 50V X7R
C1312	0CK103CK56A	0603B103K500CT 10nF 10% 50V X7R -	C1371	0CK474EK66A	C3216X7R1H474MT 470nF 20% 50V X7R
C1313	0CE226WF6DC	MVK5.0TP16VC22M 22uF 20% 16V 30MA	C1373	0CK104CK56A	0603B104K500CT 100nF 10% 50V X7R
C1314	0CC030CK01A	0603N3R0C500LT 3pF 0.25PF 50V C0G	C138	0CK104CF56A	0603B104K160CT 100nF 10% 16V X7R
C1315	0CC030CK01A	0603N3R0C500LT 3pF 0.25PF 50V C0G	C139	0CK104CF56A	0603B104K160CT 100nF 10% 16V X7R
C1316	0CK104CK56A	0603B104K500CT 100nF 10% 50V X7R	C140	0CK104CF56A	0603B104K160CT 100nF 10% 16V X7R
C1317	0CC560CK41A	C1608C0G1H560JT 56pF 5% 50V C0G -	C1400	0CE475WK6DC	MVK5.0TP50VC4.7M 4.7uF 20% 50V 19
C1318	0CC560CK41A	C1608C0G1H560JT 56pF 5% 50V C0G -	C1401	0CE475WK6DC	MVK5.0TP50VC4.7M 4.7uF 20% 50V 19
C1319	0CE335WK6D8	MVK4.0TP50VC3.3M 3.3uF 20% 50V 14	C1402	0CK682CK51A	C1608Y5P1H682KT 6.8nF 10% 50V Y5P
C132	0CK104CF56A	0603B104K160CT 100nF 10% 16V X7R	C1403	0CK682CK51A	C1608Y5P1H682KT 6.8nF 10% 50V Y5P
C1320	0CK474CH94A	0603F474Z250CT 470nF -20TO+80% 25	C1404	0CK103CK56A	0603B103K500CT 10nF 10% 50V X7R -
C1321	0CK474CH94A	0603F474Z250CT 470nF -20TO+80% 25	C1407	0CE226WF6DC	MVK5.0TP16VC22M 22uF 20% 16V 30MA
C1322	0CK103CK56A	0603B103K500CT 10nF 10% 50V X7R -	C1408	0CE107WF6DC	MVK6.3TP16VC100M 100uF 20% 16V 11
C1325	0CE226WF6DC	MVK5.0TP16VC22M 22uF 20% 16V 30MA	C1409	0CK104CF56A	0603B104K160CT 100nF 10% 16V X7R
C1326	0CK474CH94A	0603F474Z250CT 470nF -20TO+80% 25	C141	0CK104CF56A	0603B104K160CT 100nF 10% 16V X7R
C1327	0CK104CK56A	0603B104K500CT 100nF 10% 50V X7R	C1410	0CE476WF6DC	MVK6.3TP16VC47M 47uF 20% 16V 80MA
C1329	0CK474CH94A	0603F474Z250CT 470nF -20TO+80% 25	C1411	0CK103CK56A	0603B103K500CT 10nF 10% 50V X7R -
C133	0CK104CF56A	0603B104K160CT 100nF 10% 16V X7R	C1412	0CK104CF56A	0603B104K160CT 100nF 10% 16V X7R
C1330	0CK103CK56A	0603B103K500CT 10nF 10% 50V X7R -	C1413	0CK104CF56A	0603B104K160CT 100nF 10% 16V X7R
C1332	0CK474CH94A	0603F474Z250CT 470nF -20TO+80% 25	C1418	0CK474CH94A	0603F474Z250CT 470nF -20TO+80% 25
C1333	0CC101CK41A	C1608C0G1H101JT 100pF 5% 50V C0G	C1419	0CK474CH94A	0603F474Z250CT 470nF -20TO+80% 25
C1335	0CK474CH94A	0603F474Z250CT 470nF -20TO+80% 25	C142	0CK104CF56A	0603B104K160CT 100nF 10% 16V X7R
C1338	0CK471CK56A	C1608X7R1H471KT 470pF 10% 50V X7R	C1420	0CK225DFK4A	C2012Y5V1C225MT 2.2uF 20% 16V Y5V
C134	0CK104CF56A	0603B104K160CT 100nF 10% 16V X7R	C1421	0CC820CK41A	C1608C0G1H820JT 82pF 5% 50V C0G -
C1340	0CK103CK56A	0603B103K500CT 10nF 10% 50V X7R -	C1422	0CK474CH94A	0603F474Z250CT 470nF -20TO+80% 25
C1341	0CE335WK6D8	MVK4.0TP50VC3.3M 3.3uF 20% 50V 14	C1423	0CK474CH94A	0603F474Z250CT 470nF -20TO+80% 25
C1342	0CK104CK56A	0603B104K500CT 100nF 10% 50V X7R	C1426	0CK474CH94A	0603F474Z250CT 470nF -20TO+80% 25
C1343	0CE107WF6DC	MVK6.3TP16VC100M 100uF 20% 16V 11	C1428	0CK225DFK4A	C2012Y5V1C225MT 2.2uF 20% 16V Y5V
C1344	0CE106WH6DC	MVK5.0TP25VC10M 10uF 20% 25V 25MA	C1429	0CK474CH94A	0603F474Z250CT 470nF -20TO+80% 25
C1345	0CE106WH6DC	MVK5.0TP25VC10M 10uF 20% 25V 25MA	C143	0CK104CF56A	0603B104K160CT 100nF 10% 16V X7R
C1346	0CK474CH94A	0603F474Z250CT 470nF -20TO+80% 25	C1439	0CK474CH94A	0603F474Z250CT 470nF -20TO+80% 25
C1347	0CK474CH94A	0603F474Z250CT 470nF -20TO+80% 25	C144	0CK104CF56A	0603B104K160CT 100nF 10% 16V X7R
C135	0CK104CF56A	0603B104K160CT 100nF 10% 16V X7R	C1440	0CK225DFK4A	C2012Y5V1C225MT 2.2uF 20% 16V Y5V
C1350	0CE106WFKDC	MVK4.0TP16VC10M 10uF 20% 16V 16MA	C1441	0CK474CH94A	0603F474Z250CT 470nF -20TO+80% 25
C1351	0CK104CK56A	0603B104K500CT 100nF 10% 50V X7R	C1442	0CK225DFK4A	C2012Y5V1C225MT 2.2uF 20% 16V Y5V
C1352	0CK104CK56A	0603B104K500CT 100nF 10% 50V X7R	C1444	0CK474CH94A	0603F474Z250CT 470nF -20TO+80% 25
C1353	0CK222CK56A	0603B222K500CT 2.2nF 10% 50V X7R	C1445	0CK225DFK4A	C2012Y5V1C225MT 2.2uF 20% 16V Y5V
C1354	0CC102CK41A	C1608C0G1H102JT 1nF 5% 50V C0G -5	C1447	0CK474CH94A	0603F474Z250CT 470nF -20TO+80% 25
C1355	0CK104CK56A	0603B104K500CT 100nF 10% 50V X7R	C1448	0CK474CH94A	0603F474Z250CT 470nF -20TO+80% 25
C1356	0CC101CK41A	C1608C0G1H101JT 100pF 5% 50V C0G	C1449	0CK225DFK4A	C2012Y5V1C225MT 2.2uF 20% 16V Y5V
C1357	0CC221CK41A	C1608C0G1H221JT 220pF 5% 50V C0G	C145	0CK104CF56A	0603B104K160CT 100nF 10% 16V X7R
C1358	0CH2122K516	0805B122K500CT 1.2nF 10% 50V Y5P	C1450	0CK104CF56A	0603B104K160CT 100nF 10% 16V X7R
C1359	0CK104CK56A	0603B104K500CT 100nF 10% 50V X7R	C1451	0CK104CF56A	0603B104K160CT 100nF 10% 16V X7R
C136	0CK104CF56A	0603B104K160CT 100nF 10% 16V X7R	C1452	0CC150CK41A	C1608C0G1H150JT 15pF 5% 50V C0G -
C1360	0CC331CK41A	C1608C0G1H331JT 330pF 5% 50V C0G	C1453	0CC150CK41A	C1608C0G1H150JT 15pF 5% 50V C0G -
C1361	0CC331CK41A	C1608C0G1H331JT 330pF 5% 50V C0G	C146	0CK104CF56A	0603B104K160CT 100nF 10% 16V X7R
C1362	0CK104CK56A	0603B104K500CT 100nF 10% 50V X7R	C147	0CK104CF56A	0603B104K160CT 100nF 10% 16V X7R
C1363	0CK104CK56A	0603B104K500CT 100nF 10% 50V X7R	C148	0CK104CF56A	0603B104K160CT 100nF 10% 16V X7R
C1364	0CK104CK56A	0603B104K500CT 100nF 10% 50V X7R	C149	0CK104CF56A	0603B104K160CT 100nF 10% 16V X7R
C1365	0CK104CK56A	0603B104K500CT 100nF 10% 50V X7R	C150	0CK104CF56A	0603B104K160CT 100nF 10% 16V X7R
C1366	0CK104CK56A	0603B104K500CT 100nF 10% 50V X7R	C151	0CK104CF56A	0603B104K160CT 100nF 10% 16V X7R
C1367	0CK104CK56A	0603B104K500CT 100nF 10% 50V X7R	C152	0CK104CF56A	0603B104K160CT 100nF 10% 16V X7R
C1368	0CK104CK56A	0603B104K500CT 100nF 10% 50V X7R	C153	0CK104CF56A	0603B104K160CT 100nF 10% 16V X7R

LOC. NO.	PART NO.	DESCRIPTION / SPECIFICATION	LOC. NO.	PART NO.	DESCRIPTION / SPECIFICATION
C154	0CK104CF56A	0603B104K160CT 100nF 10% 16V X7R	C199	0CK104CF56A	0603B104K160CT 100nF 10% 16V X7R
C155	0CK104CF56A	0603B104K160CT 100nF 10% 16V X7R	C200	0CK103CK56A	0603B103K500CT 10nF 10% 50V X7R -
C156	0CK104CF56A	0603B104K160CT 100nF 10% 16V X7R	C201	OCC470CK41A	C1608C0G1H470JT 47pF 5% 50V C0G -
C157	0CK104CF56A	0603B104K160CT 100nF 10% 16V X7R	C202	OCC101CK41A	C1608C0G1H101JT 100pF 5% 50V C0G
C158	0CK104CF56A	0603B104K160CT 100nF 10% 16V X7R	C203	0CK104CF56A	0603B104K160CT 100nF 10% 16V X7R
C159	0CK104CF56A	0603B104K160CT 100nF 10% 16V X7R	C204	0CK103CK56A	0603B103K500CT 10nF 10% 50V X7R -
C160	0CK104CF56A	0603B104K160CT 100nF 10% 16V X7R	C206	0CK104CF56A	0603B104K160CT 100nF 10% 16V X7R
C161	0CK104CF56A	0603B104K160CT 100nF 10% 16V X7R	C207	0CK104CF56A	0603B104K160CT 100nF 10% 16V X7R
C162	0CK104CF56A	0603B104K160CT 100nF 10% 16V X7R	C209	EAE32755801	CL31A106K5HNNNE 10uF 10% 16V X5R
C163	0CK104CF56A	0603B104K160CT 100nF 10% 16V X7R	C212	EAE32755801	CL31A106K5HNNNE 10uF 10% 16V X5R
C164	0CK104CF56A	0603B104K160CT 100nF 10% 16V X7R	C213	EAE32755801	CL31A106K5HNNNE 10uF 10% 16V X5R
C165	0CK104CF56A	0603B104K160CT 100nF 10% 16V X7R	C216	EAE32755801	CL31A106K5HNNNE 10uF 10% 16V X5R
C166	EAE32755801	CL31A106K5HNNNE 10uF 10% 16V X5R	C218	0CK103CK56A	0603B103K500CT 10nF 10% 50V X7R -
C167	EAE32755801	CL31A106K5HNNNE 10uF 10% 16V X5R	C219	0CK103CK56A	0603B103K500CT 10nF 10% 50V X7R -
C168	EAE32755801	CL31A106K5HNNNE 10uF 10% 16V X5R	C220	0CK103CK56A	0603B103K500CT 10nF 10% 50V X7R -
C169	OCC100CK41A	C1608C0G1H100JT 10pF 5% 50V C0G -	C221	0CK103CK56A	0603B103K500CT 10nF 10% 50V X7R -
C170	OCC220CK41A	C1608C0G1H220JT 22pF 5% 50V C0G -	C222	0CK103CK56A	0603B103K500CT 10nF 10% 50V X7R -
C1700	0CK104CK56A	0603B104K500CT 100nF 10% 50V X7R	C224	0CK103CK56A	0603B103K500CT 10nF 10% 50V X7R -
C1701	0CK104BF56A	C1005X7R104KET 100nF 10% 16V X7R	C226	OCE107WF6DC	MVK6.3TP16VC100M 100uF 20% 16V 11
C1702	0CK104CK56A	0603B104K500CT 100nF 10% 50V X7R	C227	OCE107WF6DC	MVK6.3TP16VC100M 100uF 20% 16V 11
C1703	0CK104CK56A	0603B104K500CT 100nF 10% 50V X7R	C228	0CK103CK56A	0603B103K500CT 10nF 10% 50V X7R -
C1705	0CK104CK56A	0603B104K500CT 100nF 10% 50V X7R	C229	0CK103CK56A	0603B103K500CT 10nF 10% 50V X7R -
C1706	0CK104CK56A	0603B104K500CT 100nF 10% 50V X7R	C230	0CK103CK56A	0603B103K500CT 10nF 10% 50V X7R -
C1707	0CK104CK56A	0603B104K500CT 100nF 10% 50V X7R	C231	0CK103CK56A	0603B103K500CT 10nF 10% 50V X7R -
C1708	OCE226WF6DC	MVK5.0TP16VC22M 22uF 20% 16V 30MA	C232	0CK103CK56A	0603B103K500CT 10nF 10% 50V X7R -
C1709	0CK104CK56A	0603B104K500CT 100nF 10% 50V X7R	C233	0CK103CK56A	0603B103K500CT 10nF 10% 50V X7R -
C171	0CK103CK56A	0603B103K500CT 10nF 10% 50V X7R -	C234	0CK104CK56A	0603B104K500CT 100nF 10% 50V X7R
C1710	0CK104CK56A	0603B104K500CT 100nF 10% 50V X7R	C235	0CK104CK56A	0603B104K500CT 100nF 10% 50V X7R
C172	0CK103CK56A	0603B103K500CT 10nF 10% 50V X7R -	C236	0CK104CK56A	0603B104K500CT 100nF 10% 50V X7R
C173	0CK104CF56A	0603B104K160CT 100nF 10% 16V X7R	C237	0CK104CK56A	0603B104K500CT 100nF 10% 50V X7R
C174	0CK104CF56A	0603B104K160CT 100nF 10% 16V X7R	C238	0CK104CK56A	0603B104K500CT 100nF 10% 50V X7R
C175	0CK103CK56A	0603B103K500CT 10nF 10% 50V X7R -	C239	0CK104CK56A	0603B104K500CT 100nF 10% 50V X7R
C176	0CK103CK56A	0603B103K500CT 10nF 10% 50V X7R -	C240	0CK104CK56A	0603B104K500CT 100nF 10% 50V X7R
C177	0CK103CK56A	0603B103K500CT 10nF 10% 50V X7R -	C241	0CK104CK56A	0603B104K500CT 100nF 10% 50V X7R
C178	0CK104CF56A	0603B104K160CT 100nF 10% 16V X7R	C242	0CK104CK56A	0603B104K500CT 100nF 10% 50V X7R
C179	0CK104CF56A	0603B104K160CT 100nF 10% 16V X7R	C243	0CK104CK56A	0603B104K500CT 100nF 10% 50V X7R
C180	0CK104CF56A	0603B104K160CT 100nF 10% 16V X7R	C301	0CK104CF56A	0603B104K160CT 100nF 10% 16V X7R
C181	OCE106WFKDC	MVK4.0TP16VC10M 10uF 20% 16V 16MA	C302	0CK104CF56A	0603B104K160CT 100nF 10% 16V X7R
C182	0CK105CD56A	C1608X7R1A105KT 1uF 10% 10V X7R -	C303	0CK104CF56A	0603B104K160CT 100nF 10% 16V X7R
C183	0CK104CF56A	0603B104K160CT 100nF 10% 16V X7R	C306	0CK104CF56A	0603B104K160CT 100nF 10% 16V X7R
C184	0CK104CF56A	0603B104K160CT 100nF 10% 16V X7R	C307	0CK104CF56A	0603B104K160CT 100nF 10% 16V X7R
C185	0CK104CF56A	0603B104K160CT 100nF 10% 16V X7R	C308	0CK104CF56A	0603B104K160CT 100nF 10% 16V X7R
C186	0CK104CF56A	0603B104K160CT 100nF 10% 16V X7R	C309	0CK104CF56A	0603B104K160CT 100nF 10% 16V X7R
C187	0CK104CF56A	0603B104K160CT 100nF 10% 16V X7R	C310	0CK104CF56A	0603B104K160CT 100nF 10% 16V X7R
C188	0CK103CK56A	0603B103K500CT 10nF 10% 50V X7R -	C311	0CK104CF56A	0603B104K160CT 100nF 10% 16V X7R
C189	0CK103CK56A	0603B103K500CT 10nF 10% 50V X7R -	C312	0CK104CF56A	0603B104K160CT 100nF 10% 16V X7R
C190	0CK103CK56A	0603B103K500CT 10nF 10% 50V X7R -	C313	0CK104CF56A	0603B104K160CT 100nF 10% 16V X7R
C191	0CK103CK56A	0603B103K500CT 10nF 10% 50V X7R -	C314	0CK104CF56A	0603B104K160CT 100nF 10% 16V X7R
C192	0CK103CK56A	0603B103K500CT 10nF 10% 50V X7R -	C409	0CK104CF56A	0603B104K160CT 100nF 10% 16V X7R
C193	0CK822CK46A	0603B822J500CT 8.2nF 10% 50V X7R	C410	0CK104CF56A	0603B104K160CT 100nF 10% 16V X7R
C194	0CK822CK46A	0603B822J500CT 8.2nF 10% 50V X7R	C411	0CK104CF56A	0603B104K160CT 100nF 10% 16V X7R
C195	OCC220CK41A	C1608C0G1H220JT 22pF 5% 50V C0G -	C412	OCE106WFKDC	MVK4.0TP16VC10M 10uF 20% 16V 16MA
C196	OCC100CK41A	C1608C0G1H100JT 10pF 5% 50V C0G -	C413	0CK104CF56A	0603B104K160CT 100nF 10% 16V X7R
C197	0CK475CC94A	C1608Y5V0J475ZT 4.7uF -20TO+80% 6	C414	OCE106WFKDC	MVK4.0TP16VC10M 10uF 20% 16V 16MA
C198	0CK475CC94A	C1608Y5V0J475ZT 4.7uF -20TO+80% 6	C415	0CK104CF56A	0603B104K160CT 100nF 10% 16V X7R

LOC. NO.	PART NO.	DESCRIPTION / SPECIFICATION	LOC. NO.	PART NO.	DESCRIPTION / SPECIFICATION
C429	0CK104CK56A	0603B104K500CT 100nF 10% 50V X7R	C627	0CK104CF56A	0603B104K160CT 100nF 10% 16V X7R
C430	0CK104CK56A	0603B104K500CT 100nF 10% 50V X7R	C630	0CE107WF6DC	MVK6.3TP16VC100M 100uF 20% 16V 11
C515	0CE107WF6DC	MVK6.3TP16VC100M 100uF 20% 16V 11	C633	0CK475CC94A	C1608Y5V0J475ZT 4.7uF -20TO+80% 6
C516	0CK104CF56A	0603B104K160CT 100nF 10% 16V X7R	C635	0CK472CK56A	0603B472K500CT 4.7nF 10% 50V X7R
C517	0CE227WF6DC	MVK8.0TP16VC220M 220uF 20% 16V 80	C636	0CK103CK56A	0603B103K500CT 10nF 10% 50V X7R -
C518	0CK104CF56A	0603B104K160CT 100nF 10% 16V X7R	C637	0CK472CK56A	0603B472K500CT 4.7nF 10% 50V X7R
C519	0CE107WF6DC	MVK6.3TP16VC100M 100uF 20% 16V 11	C638	0CE107WF6DC	MVK6.3TP16VC100M 100uF 20% 16V 11
C520	0CK104CF56A	0603B104K160CT 100nF 10% 16V X7R	C639	0CE107WF6DC	MVK6.3TP16VC100M 100uF 20% 16V 11
C521	0CK104CF56A	0603B104K160CT 100nF 10% 16V X7R	C640	0CE107WF6DC	MVK6.3TP16VC100M 100uF 20% 16V 11
C522	0CE107WF6DC	MVK6.3TP16VC100M 100uF 20% 16V 11	C641	0CC470CK41A	C1608C0G1H470JT 47pF 5% 50V C0G -
C523	0CE107WF6DC	MVK6.3TP16VC100M 100uF 20% 16V 11	C642	0CC470CK41A	C1608C0G1H470JT 47pF 5% 50V C0G -
C524	0CE477WF6DC	MVK10TP16VC470M 470uF 20% 16V 80M	C643	0CK475DD56A	C2012X7R1A475KT 4.7uF 10% 10V X7R
C525	0CK104CF56A	0603B104K160CT 100nF 10% 16V X7R	C700	0CK104CK56A	0603B104K500CT 100nF 10% 50V X7R
C526	0CK104CF56A	0603B104K160CT 100nF 10% 16V X7R	C701	0CE226WF6DC	MVK5.0TP16VC22M 22uF 20% 16V 30MA
C527	0CE107WF6DC	MVK6.3TP16VC100M 100uF 20% 16V 11	C702	0CK104CK56A	0603B104K500CT 100nF 10% 50V X7R
C528	0CE227WF6DC	MVK8.0TP16VC220M 220uF 20% 16V 80	C703	0CK104CK56A	0603B104K500CT 100nF 10% 50V X7R
C529	0CK104CF56A	0603B104K160CT 100nF 10% 16V X7R	C704	0CK104CK56A	0603B104K500CT 100nF 10% 50V X7R
C530	0CK104CF56A	0603B104K160CT 100nF 10% 16V X7R	C705	0CE226WF6DC	MVK5.0TP16VC22M 22uF 20% 16V 30MA
C531	0CK104CF56A	0603B104K160CT 100nF 10% 16V X7R	C706	0CK104BF56A	C1005X7R104KET 100nF 10% 16V X7R
C532	0CK104CF56A	0603B104K160CT 100nF 10% 16V X7R	C707	0CK104CK56A	0603B104K500CT 100nF 10% 50V X7R
C533	0CE107WF6DC	MVK6.3TP16VC100M 100uF 20% 16V 11	C708	0CK104BF56A	C1005X7R104KET 100nF 10% 16V X7R
C534	0CE227WF6DC	MVK8.0TP16VC220M 220uF 20% 16V 80	C709	0CK104CK56A	0603B104K500CT 100nF 10% 50V X7R
C535	0CK105CD56A	C1608X7R1A105KT 1uF 10% 10V X7R -	C710	0CK104CK56A	0603B104K500CT 100nF 10% 50V X7R
C537	0CK104CF56A	0603B104K160CT 100nF 10% 16V X7R	C711	0CK104CK56A	0603B104K500CT 100nF 10% 50V X7R
C539	0CK104CF56A	0603B104K160CT 100nF 10% 16V X7R	C712	0CK104CK56A	0603B104K500CT 100nF 10% 50V X7R
C540	0CK105CD56A	C1608X7R1A105KT 1uF 10% 10V X7R -	C713	0CK104BF56A	C1005X7R104KET 100nF 10% 16V X7R
C541	0CE107WF6DC	MVK6.3TP16VC100M 100uF 20% 16V 11	C714	0CK104CK56A	0603B104K500CT 100nF 10% 50V X7R
C542	0CK104CF56A	0603B104K160CT 100nF 10% 16V X7R	C715	0CK104CK56A	0603B104K500CT 100nF 10% 50V X7R
C543	0CE107WF6DC	MVK6.3TP16VC100M 100uF 20% 16V 11	C716	0CK104CK56A	0603B104K500CT 100nF 10% 50V X7R
C544	0CK104CF56A	0603B104K160CT 100nF 10% 16V X7R	C717	0CK104CK56A	0603B104K500CT 100nF 10% 50V X7R
C548	0CE107WF6DC	MVK6.3TP16VC100M 100uF 20% 16V 11	C718	0CK104CK56A	0603B104K500CT 100nF 10% 50V X7R
C549	0CE107WF6DC	MVK6.3TP16VC100M 100uF 20% 16V 11	C721	0CK104CK56A	0603B104K500CT 100nF 10% 50V X7R
C550	0CK104CF56A	0603B104K160CT 100nF 10% 16V X7R	C722	0CK104CK56A	0603B104K500CT 100nF 10% 50V X7R
C551	0CK104CF56A	0603B104K160CT 100nF 10% 16V X7R	C723	0CE226WF6DC	MVK5.0TP16VC22M 22uF 20% 16V 30MA
C553	0CK104CF56A	0603B104K160CT 100nF 10% 16V X7R	C724	0CK104CK56A	0603B104K500CT 100nF 10% 50V X7R
C554	0CK105CD56A	C1608X7R1A105KT 1uF 10% 10V X7R -	C725	0CC200CK41A	C1608C0G1H200JT 20pF 5% 50V C0G -
C555	0CK105CD56A	C1608X7R1A105KT 1uF 10% 10V X7R -	C726	0CK104CK56A	0603B104K500CT 100nF 10% 50V X7R
C601	0CC101CK41A	C1608C0G1H101JT 100pF 5% 50V C0G	C727	0CE226WF6DC	MVK5.0TP16VC22M 22uF 20% 16V 30MA
C602	0CK104CF56A	0603B104K160CT 100nF 10% 16V X7R	C728	0CK104CK56A	0603B104K500CT 100nF 10% 50V X7R
C603	0CK103CK56A	0603B103K500CT 10nF 10% 50V X7R -	C729	0CK104CK56A	0603B104K500CT 100nF 10% 50V X7R
C604	0CC100CK41A	C1608C0G1H100JT 10pF 5% 50V C0G -	C730	0CK104CK56A	0603B104K500CT 100nF 10% 50V X7R
C605	0CK104CF56A	0603B104K160CT 100nF 10% 16V X7R	C732	0CK104CK56A	0603B104K500CT 100nF 10% 50V X7R
C606	0CK104CF56A	0603B104K160CT 100nF 10% 16V X7R	C733	0CK104CK56A	0603B104K500CT 100nF 10% 50V X7R
C608	0CC101CK41A	C1608C0G1H101JT 100pF 5% 50V C0G	C734	0CK104CK56A	0603B104K500CT 100nF 10% 50V X7R
C609	0CK104CF56A	0603B104K160CT 100nF 10% 16V X7R	C736	0CE226WF6DC	MVK5.0TP16VC22M 22uF 20% 16V 30MA
C610	0CC271CK41A	C1608C0G1H271JT 270pF 5% 50V C0G	C737	0CK104CK56A	0603B104K500CT 100nF 10% 50V X7R
C611	0CE107WF6DC	MVK6.3TP16VC100M 100uF 20% 16V 11	C738	0CK104CK56A	0603B104K500CT 100nF 10% 50V X7R
C612	0CE476WF6DC	MVK6.3TP16VC47M 47uF 20% 16V 80MA	C739	0CK104CK56A	0603B104K500CT 100nF 10% 50V X7R
C613	0CE107WF6DC	MVK6.3TP16VC100M 100uF 20% 16V 11	C740	0CE226WF6DC	MVK5.0TP16VC22M 22uF 20% 16V 30MA
C615	0CK104CK56A	0603B104K500CT 100nF 10% 50V X7R	C741	0CK104CK56A	0603B104K500CT 100nF 10% 50V X7R
C616	0CK104CK56A	0603B104K500CT 100nF 10% 50V X7R	C742	0CK104CK56A	0603B104K500CT 100nF 10% 50V X7R
C623	0CC470CK41A	C1608C0G1H470JT 47pF 5% 50V C0G -	C743	0CE226WF6DC	MVK5.0TP16VC22M 22uF 20% 16V 30MA
C624	0CC470CK41A	C1608C0G1H470JT 47pF 5% 50V C0G -	C744	0CK104CK56A	0603B104K500CT 100nF 10% 50V X7R
C625	0CK104CF56A	0603B104K160CT 100nF 10% 16V X7R	C745	0CK104CK56A	0603B104K500CT 100nF 10% 50V X7R
C626	0CK104CF56A	0603B104K160CT 100nF 10% 16V X7R	C746	0CK104CK56A	0603B104K500CT 100nF 10% 50V X7R

LOC. NO.	PART NO.	DESCRIPTION / SPECIFICATION	LOC. NO.	PART NO.	DESCRIPTION / SPECIFICATION
C747	0CK104CK56A	0603B104K500CT 100nF 10% 50V X7R	C803	0CK106EF56A	C3216X7R1C106KT 10uF 10% 16V X7R
C749	0CK104BF56A	C1005X7R104KET 100nF 10% 16V X7R	C806	0CK104CK56A	0603B104K500CT 100nF 10% 50V X7R
C750	0CK104CK56A	0603B104K500CT 100nF 10% 50V X7R	C807	0CK103CK56A	0603B103K500CT 10nF 10% 50V X7R -
C751	0CK104CK56A	0603B104K500CT 100nF 10% 50V X7R	C810	0CK103CK56A	0603B103K500CT 10nF 10% 50V X7R -
C752	0CK104CK56A	0603B104K500CT 100nF 10% 50V X7R	C812	0CK103CK56A	0603B103K500CT 10nF 10% 50V X7R -
C753	0CK104CK56A	0603B104K500CT 100nF 10% 50V X7R	C813	0CK104CK56A	0603B104K500CT 100nF 10% 50V X7R
C754	0CK104CK56A	0603B104K500CT 100nF 10% 50V X7R	C815	0CK104CK56A	0603B104K500CT 100nF 10% 50V X7R
C755	0CK104CK56A	0603B104K500CT 100nF 10% 50V X7R	C817	0CK103CK56A	0603B103K500CT 10nF 10% 50V X7R -
C756	0CK104CK56A	0603B104K500CT 100nF 10% 50V X7R	C818	0CK104CK56A	0603B104K500CT 100nF 10% 50V X7R
C757	0CK104CK56A	0603B104K500CT 100nF 10% 50V X7R	C822	0CK106EF56A	C3216X7R1C106KT 10uF 10% 16V X7R
C758	0CE226WF6DC	MVK5.0TP16VC22M 22uF 20% 16V 30MA	C824	0CK103CK56A	0603B103K500CT 10nF 10% 50V X7R -
C759	0CK104CK56A	0603B104K500CT 100nF 10% 50V X7R	C826	0CK103CK56A	0603B103K500CT 10nF 10% 50V X7R -
C760	0CK104CK56A	0603B104K500CT 100nF 10% 50V X7R	C828	0CK104CK56A	0603B104K500CT 100nF 10% 50V X7R
C761	0CK104CK56A	0603B104K500CT 100nF 10% 50V X7R	C830	0CK104CK56A	0603B104K500CT 100nF 10% 50V X7R
C762	0CK104CK56A	0603B104K500CT 100nF 10% 50V X7R	C831	0CK103CK56A	0603B103K500CT 10nF 10% 50V X7R -
C763	0CK104CK56A	0603B104K500CT 100nF 10% 50V X7R	C834	0CK104CK56A	0603B104K500CT 100nF 10% 50V X7R
C764	0CK104CK56A	0603B104K500CT 100nF 10% 50V X7R	C836	0CK103CK56A	0603B103K500CT 10nF 10% 50V X7R -
C765	0CE476WF6DC	MVK6.3TP16VC47M 47uF 20% 16V 80MA	C840	0CK103CK56A	0603B103K500CT 10nF 10% 50V X7R -
C766	0CK104CK56A	0603B104K500CT 100nF 10% 50V X7R	C841	0CK103CK56A	0603B103K500CT 10nF 10% 50V X7R -
C767	0CK104CK56A	0603B104K500CT 100nF 10% 50V X7R	C844	0CK103CK56A	0603B103K500CT 10nF 10% 50V X7R -
C768	0CK104CK56A	0603B104K500CT 100nF 10% 50V X7R	C846	0CK104CK56A	0603B104K500CT 100nF 10% 50V X7R
C769	0CK104CK56A	0603B104K500CT 100nF 10% 50V X7R	C847	0CK104CK56A	0603B104K500CT 100nF 10% 50V X7R
C770	0CK104CK56A	0603B104K500CT 100nF 10% 50V X7R	C850	0CK103CK56A	0603B103K500CT 10nF 10% 50V X7R -
C771	0CK104CK56A	0603B104K500CT 100nF 10% 50V X7R	C851	0CK225DFK4A	C2012Y5V1C225MT 2.2uF 20% 16V Y5V
C772	0CK103CK56A	0603B103K500CT 10nF 10% 50V X7R -	C852	0CE107WF6DC	MVK6.3TP16VC100M 100uF 20% 16V 11
C773	0CK104CK56A	0603B104K500CT 100nF 10% 50V X7R	C853	0CE107WF6DC	MVK6.3TP16VC100M 100uF 20% 16V 11
C774	0CK104BF56A	C1005X7R104KET 100nF 10% 16V X7R	C854	0CK103CK56A	0603B103K500CT 10nF 10% 50V X7R -
C775	0CK104CK56A	0603B104K500CT 100nF 10% 50V X7R	C855	0CK103CK56A	0603B103K500CT 10nF 10% 50V X7R -
C776	0CK104CK56A	0603B104K500CT 100nF 10% 50V X7R	C856	0CK103CK56A	0603B103K500CT 10nF 10% 50V X7R -
C777	0CK104CK56A	0603B104K500CT 100nF 10% 50V X7R	C857	0CK104BF56A	C1005X7R104KET 100nF 10% 16V X7R
C778	0CK104CK56A	0603B104K500CT 100nF 10% 50V X7R	C859	0CK104BF56A	C1005X7R104KET 100nF 10% 16V X7R
C779	0CK104CK56A	0603B104K500CT 100nF 10% 50V X7R	C860	0CK104BF56A	C1005X7R104KET 100nF 10% 16V X7R
C780	0CK104CK56A	0603B104K500CT 100nF 10% 50V X7R	C861	0CK104BF56A	C1005X7R104KET 100nF 10% 16V X7R
C781	0CK104CK56A	0603B104K500CT 100nF 10% 50V X7R	C862	0CK104BF56A	C1005X7R104KET 100nF 10% 16V X7R
C782	0CK104CK56A	0603B104K500CT 100nF 10% 50V X7R	C863	0CK104BF56A	C1005X7R104KET 100nF 10% 16V X7R
C783	0CK104CK56A	0603B104K500CT 100nF 10% 50V X7R	C864	0CK104BF56A	C1005X7R104KET 100nF 10% 16V X7R
C784	0CK104CK56A	0603B104K500CT 100nF 10% 50V X7R	C865	0CK104BF56A	C1005X7R104KET 100nF 10% 16V X7R
C785	0CK104CK56A	0603B104K500CT 100nF 10% 50V X7R	C866	0CK104BF56A	C1005X7R104KET 100nF 10% 16V X7R
C786	0CK104CK56A	0603B104K500CT 100nF 10% 50V X7R	C867	0CK104BF56A	C1005X7R104KET 100nF 10% 16V X7R
C787	0CK104CK56A	0603B104K500CT 100nF 10% 50V X7R	C868	0CK104BF56A	C1005X7R104KET 100nF 10% 16V X7R
C788	0CK104CK56A	0603B104K500CT 100nF 10% 50V X7R	C869	0CK104BF56A	C1005X7R104KET 100nF 10% 16V X7R
C789	0CK104CK56A	0603B104K500CT 100nF 10% 50V X7R	C870	0CK104BF56A	C1005X7R104KET 100nF 10% 16V X7R
C790	0CK104CK56A	0603B104K500CT 100nF 10% 50V X7R	C875	0CK104BF56A	C1005X7R104KET 100nF 10% 16V X7R
C791	0CK104BF56A	C1005X7R104KET 100nF 10% 16V X7R	C900	0CK104CK56A	0603B104K500CT 100nF 10% 50V X7R
C792	0CK104CK56A	0603B104K500CT 100nF 10% 50V X7R	C901	0CE107WF6DC	MVK6.3TP16VC100M 100uF 20% 16V 11
C793	0CE226WF6DC	MVK5.0TP16VC22M 22uF 20% 16V 30MA	C903	0CE476WF6DC	MVK6.3TP16VC47M 47uF 20% 16V 80MA
C794	0CK103CK56A	0603B103K500CT 10nF 10% 50V X7R -	C905	0CK103CK56A	0603B103K500CT 10nF 10% 50V X7R -
C795	0CC220CK41A	C1608C0G1H220JT 22pF 5% 50V C0G -	C907	0CE107WF6DC	MVK6.3TP16VC100M 100uF 20% 16V 11
C796	0CE226WF6DC	MVK5.0TP16VC22M 22uF 20% 16V 30MA	C908	0CK104CF56A	0603B104K160CT 100nF 10% 16V X7R
C797	0CE476WF6DC	MVK6.3TP16VC47M 47uF 20% 16V 80MA	C909	0CK103CK56A	0603B103K500CT 10nF 10% 50V X7R -
C798	0CK104CK56A	0603B104K500CT 100nF 10% 50V X7R	C910	0CK104CK56A	0603B104K500CT 100nF 10% 50V X7R
C799	0CK104CK56A	0603B104K500CT 100nF 10% 50V X7R	C911	0CK103CK56A	0603B103K500CT 10nF 10% 50V X7R -
C800	0CK104CK56A	0603B104K500CT 100nF 10% 50V X7R	C912	0CE476WF6DC	MVK6.3TP16VC47M 47uF 20% 16V 80MA
C801	0CE226WF6DC	MVK5.0TP16VC22M 22uF 20% 16V 30MA	C914	0CK104CK56A	0603B104K500CT 100nF 10% 50V X7R
C802	0CK104CK56A	0603B104K500CT 100nF 10% 50V X7R	C915	0CE107WF6DC	MVK6.3TP16VC100M 100uF 20% 16V 11

LOC. NO.	PART NO.	DESCRIPTION / SPECIFICATION	LOC. NO.	PART NO.	DESCRIPTION / SPECIFICATION
C917	0CK104CK56A	0603B104K500CT 100nF 10% 50V X7R	ZD1109	EAH33945901	CDS3C30GTH 30V 50V 120V 1.9A 1W S
C924	0CE107WF6DC	MVK8.0TP25VC100M 100uF 20% 25V 18	ZD1110	EAH33945901	CDS3C30GTH 30V 50V 120V 1.9A 1W S
C925	0CE227WF6DC	MVK8.0TP16VC220M 220uF 20% 16V 80	ZD1111	EAH33945901	CDS3C30GTH 30V 50V 120V 1.9A 1W S
C928	0CE227WF6DC	MVK8.0TP16VC220M 220uF 20% 16V 80	ZD1112	EAH33945901	CDS3C30GTH 30V 50V 120V 1.9A 1W S
C929	0CE227WF6DC	MVK8.0TP16VC220M 220uF 20% 16V 80	ZD1113	EAH33945901	CDS3C30GTH 30V 50V 120V 1.9A 1W S
C931	0CK104CK56A	0603B104K500CT 100nF 10% 50V X7R	ZD1114	EAH33945901	CDS3C30GTH 30V 50V 120V 1.9A 1W S
C932	0CK104CK56A	0603B104K500CT 100nF 10% 50V X7R	ZD1203	EAH33945901	CDS3C30GTH 30V 50V 120V 1.9A 1W S
C933	0CK104CK56A	0603B104K500CT 100nF 10% 50V X7R	ZD1211	EAH33946001	CDS3C05GTA 5.6V 6.4V 19V 1.9A 1W
C934	0CK104CK56A	0603B104K500CT 100nF 10% 50V X7R	ZD1212	EAH33946001	CDS3C05GTA 5.6V 6.4V 19V 1.9A 1W
C935	0CK104CK56A	0603B104K500CT 100nF 10% 50V X7R	ZD1218	EAH33945901	CDS3C30GTH 30V 50V 120V 1.9A 1W S
C937	0CE107WF6DC	MVK6.3TP16VC100M 100uF 20% 16V 11	ZD1219	EAH33945901	CDS3C30GTH 30V 50V 120V 1.9A 1W S
C954	0CE477WF6DC	MVK10TP16VC470M 470uF 20% 16V 80M	ZD1220	EAH33945901	CDS3C30GTH 30V 50V 120V 1.9A 1W S
C955	0CK474CH94A	0603F474Z250CT 470nF -20TO+80% 25	ZD1221	EAH33945901	CDS3C30GTH 30V 50V 120V 1.9A 1W S
C956	0CK474CH94A	0603F474Z250CT 470nF -20TO+80% 25	ZD1222	EAH33945901	CDS3C30GTH 30V 50V 120V 1.9A 1W S
C957	0CE107WF6DC	MVK6.3TP16VC100M 100uF 20% 16V 11	ZD1223	EAH33945901	CDS3C30GTH 30V 50V 120V 1.9A 1W S
C958	0CE107WF6DC	MVK6.3TP16VC100M 100uF 20% 16V 11	ZD1224	EAH33945901	CDS3C30GTH 30V 50V 120V 1.9A 1W S
C959	0CE107WF6DC	MVK6.3TP16VC100M 100uF 20% 16V 11	ZD1226	EAH33945901	CDS3C30GTH 30V 50V 120V 1.9A 1W S
C960	0CK104CK56A	0603B104K500CT 100nF 10% 50V X7R	ZD1300	0DZRM00248A	RLZ8.2B 8.2V 7.78TO8.19V 8OHM 500
C961	0CK104CK56A	0603B104K500CT 100nF 10% 50V X7R	<b>ICs</b>		
C962	0CK104CK56A	0603B104K500CT 100nF 10% 50V X7R	IC100	0IPRP00703C	STI5100GUC(CUT3.3) 3.3V 5u 27M PB
C969	0CE107WF6DC	MVK6.3TP16VC100M 100uF 20% 16V 11	IC1002	0IMMRAL014D	AT24C02BN-SH-T 2KBIT 256x8BIT 1.8
C970	0CE107WF6DC	MVK6.3TP16VC100M 100uF 20% 16V 11	IC1003	0IMMRAL014D	AT24C02BN-SH-T 2KBIT 256x8BIT 1.8
C971	0CE107WF6DC	MVK6.3TP16VC100M 100uF 20% 16V 11	IC1004	EAN33595101	STHDMI002A 3.135TO3.465 9NSEC 9NS
C972	0CK104CK56A	0603B104K500CT 100nF 10% 50V X7R	IC102	0ISTLPH026A	74LVC14APW 1.2TO3.6V 0.01mA SCHMI
C973	0CK104CK56A	0603B104K500CT 100nF 10% 50V X7R	IC103	0IMP242560A	24LC256T-I/SM 256KBIT 256X8BIT 2
C974	0CK104CK56A	0603B104K500CT 100nF 10% 50V X7R	IC1100	0IMMRAL014D	AT24C02BN-SH-T 2KBIT 256x8BIT 1.8
C975	0CE107WF6DC	MVK6.3TP16VC100M 100uF 20% 16V 11	IC1101	0IPH741400E	74HC14D 2TO6V 0.002mA SCHMITT TRI
C977	0CK104CK56A	0603B104K500CT 100nF 10% 50V X7R	IC1102	0IPRP00009A	ICL3232CBNZ 3VTO5.5V - SSOP R/TP
C980	0CK103CK56A	0603B103K500CT 10nF 10% 50V X7R -	IC1104	0ITO741570C	TC74LCX157FT 2TO3.6V 0.01mA MULTI
C981	0CE476WF6DC	MVK6.3TP16VC47M 47uF 20% 16V 80MA	IC1105	0IMCRFA018A	NC7SB3157P6X_NL 1.65TO5.5V 0.001m
ZD1102	0CC100CK41A	C1608C0G1H100JT 10pF 5% 50V C0G -	IC1106	0IMCRFA018A	NC7SB3157P6X_NL 1.65TO5.5V 0.001m
ZD1103	0CC100CK41A	C1608C0G1H100JT 10pF 5% 50V C0G -	IC1300	0IMCRMN028C	MSP4450K-QA-D6 7.6TO8.7V _4.75TO5.
<b>DIODES</b>			IC1301	0ILNR00261C	STA335BW 5TO26V 0 10% 20W 0W 80dB
D100	EAH33945901	CDS3C30GTH 30V 50V 120V 1.9A 1W S	IC1400	0ISO206900A	CXA2069Q 8.5TO9.5V - - 1.3W QFP T
D1000	0DD184009AA	KDS184 KDS184 TP KEC - 85V - - -	IC200	0IPMG78391A	SC2595STR 2.3TO5V 0 0W SOIC R/TP
D1001	0DD184009AA	KDS184 KDS184 TP KEC - 85V - - -	IC202	0IMMRIH038B	HYB25D(C)256160CE-5 256MBIT 4MX16
D101	EAH33946001	CDS3C05GTA 5.6V 6.4V 19V 1.9A 1W	IC300	0ISTLPH003B	74LVC541APW 1.2TO3.6V 0.01mA BUFF
D102	EAH33946001	CDS3C05GTA 5.6V 6.4V 19V 1.9A 1W	IC301	0IMCRFA013A	74LCX244MTC 2TO3.6V 0.01mA BUFFER
D103	EAH33945901	CDS3C30GTH 30V 50V 120V 1.9A 1W S	IC302	0ISTLPH003B	74LVC541APW 1.2TO3.6V 0.01mA BUFF
D104	EAH33945901	CDS3C30GTH 30V 50V 120V 1.9A 1W S	IC303	0IMCRFA013A	74LCX244MTC 2TO3.6V 0.01mA BUFFER
D900	0DS226009AA	KDS226 1.2V 85V 300MA 2A 4NSEC 15	IC304	0ISTLPH048A	74LVC245APW 1.2TO3.6V 0.01mA TRAN
D902	0DS226009AA	KDS226 1.2V 85V 300MA 2A 4NSEC 15	IC305	0ISTL00083A	74LCX373MTC 2.0V to 3.6V 10uA LAT
D903	0DS226009AA	KDS226 1.2V 85V 300MA 2A 4NSEC 15	IC306	0ISTL00083A	74LCX373MTC 2.0V to 3.6V 10uA LAT
D904	0DS226009AA	KDS226 1.2V 85V 300MA 2A 4NSEC 15	IC402	0ITO740800C	TC74LCX08FT 2TO3.6V 10uA AND GATE
D905	0DS226009AA	KDS226 1.2V 85V 300MA 2A 4NSEC 15	IC403	0IMCRPH015A	74LVC32AD 1.2TO3.6V 0.01mA OR GAT
D906	0DD100009AM	EU1ZV(1) 200V 2.5V 10UA 15A 400NS	IC404	0ISTLPH026A	74LVC14APW 1.2TO3.6V 0.01mA SCHMI
ZD1100	EAH33946001	CDS3C05GTA 5.6V 6.4V 19V 1.9A 1W	IC410	0ITO741570C	TC74LCX157FT 2TO3.6V 0.01mA MULTI
ZD1101	EAH33946001	CDS3C05GTA 5.6V 6.4V 19V 1.9A 1W	IC500	0IMCRSJ001A	SC1565IST-1.8 2.2TO5.5V 1.8V 0W S
ZD1104	EAH33945901	CDS3C30GTH 30V 50V 120V 1.9A 1W S	IC501	0IPMG00027A	SC156515M-1.8TR 2.2TO5.5V 1.8V 0W
ZD1105	EAH33945901	CDS3C30GTH 30V 50V 120V 1.9A 1W S	IC502	0IMCRSJ001B	SC1565IST-2.5TR 2.2TO5V 2.5V 0W S
ZD1106	EAH33945901	CDS3C30GTH 30V 50V 120V 1.9A 1W S	IC503	0IPMGKE030A	KIA78R05F 6TO12V 5V 8W DPAK R/TP
ZD1107	EAH33945901	CDS3C30GTH 30V 50V 120V 1.9A 1W S	IC504	0IPMGKE031A	KIA78R33F 4TO10V 3.3V 8W DPAK R/T
ZD1108	EAH33945901	CDS3C30GTH 30V 50V 120V 1.9A 1W S	IC505	0IPMGKE031A	KIA78R33F 4TO10V 3.3V 8W DPAK R/T



LOC. NO.	PART NO.	DESCRIPTION / SPECIFICATION	LOC. NO.	PART NO.	DESCRIPTION / SPECIFICATION
IC506	OISS455880A	KA4558D 12TO22V 6mV - 0W 400MW 76	L606	6210TCE001G	Filter, HH-1M3216-501JT 500OHM 3.2X1.6X1.
IC507	OIPMGKE030A	KIA78R05F 6TO12V 5V 8W DPAK R/TP	L607	6210TCE001G	Filter, HH-1M3216-501JT 500OHM 3.2X1.6X1.
IC600	OIPRP00602A	TPS2010ADR 2.7TO5.5V 8.6MSEC 3.4M	L700	6210TCE001G	Filter, HH-1M3216-501JT 500OHM 3.2X1.6X1.
IC700	EAN33595901	FLI8548H-LF-BE 300MVTO3.6V,300MVT	L701	6210TCE001G	Filter, HH-1M3216-501JT 500OHM 3.2X1.6X1.
IC701	OIMP242560A	24LC256T-I/SM 256KBIT 256KX8BIT 2	L703	6210TCE001G	Filter, HH-1M3216-501JT 500OHM 3.2X1.6X1.
IC702	EAN34099701	M2404HEPROM 4KBIT 512 x 8bit 2.5V	L704	6210TCE001G	Filter, HH-1M3216-501JT 500OHM 3.2X1.6X1.
IC801	OIMMRIH038B	HYB25D(C)256160CE-5 256MBIT 4MX16	L705	6210TCE001G	Filter, HH-1M3216-501JT 500OHM 3.2X1.6X1.
IC804	OIPMG78391A	SC2595STR 2.3TO5V 0 0W SOIC R/TP	L706	6210TCE001G	Filter, HH-1M3216-501JT 500OHM 3.2X1.6X1.
IC900	OIPMGFA061A	FAN1587AD33X 4.8TO10.3V 3.3V 0W T	L707	6210TCE001G	Filter, HH-1M3216-501JT 500OHM 3.2X1.6X1.
IC901	OIPMGFA061A	FAN1587AD33X 4.8TO10.3V 3.3V 0W T	L900	6210TCE001X	Filter, HU-1H4532-121JT 120OHM 4.5X3.2X1.
IC902	OIPMG00107A	AZ1117H-2.5TR/E1 15V 2.5V 0W SOT2	L907	6210TCE001G	Filter, HH-1M3216-501JT 500OHM 3.2X1.6X1.
IC903	OIPMG00027A	SC156515M-1.8TR 2.2TO5.5V 1.8V 0W	L909	6210TCE001G	Filter, HH-1M3216-501JT 500OHM 3.2X1.6X1.
IC904	EAN32662801	KA7809ERTM 35V to 40V 9V 1W DPAK	L911	6210TCE001X	Filter, HU-1H4532-121JT 120OHM 4.5X3.2X1.
			L912	6210TCE001X	Filter, HU-1H4532-121JT 120OHM 4.5X3.2X1.
			L913	6210TCE001G	Filter, HH-1M3216-501JT 500OHM 3.2X1.6X1.
			L918	6210TCE001X	Filter, HU-1H4532-121JT 120OHM 4.5X3.2X1.
			L919	6210TCE001X	Filter, HU-1H4532-121JT 120OHM 4.5X3.2X1.
			L923	6210TCE001G	Filter, HH-1M3216-501JT 500OHM 3.2X1.6X1.
			L925	6210TCE001G	Filter, HH-1M3216-501JT 500OHM 3.2X1.6X1.
			L101	OLC1032101A	Inductor, FI-C3216-103KJT 10UH 10% - 50MA 0
			L109	OLC1032101A	Inductor, FI-C3216-103KJT 10UH 10% - 50MA 0
			L1209	OLCML00020G	Inductor, MLI-201209-3R3K 3.3UH 10% 0V 30MA
			L1210	OLCML00020G	Inductor, MLI-201209-3R3K 3.3UH 10% 0V 30MA
			L1213	OLCML00020G	Inductor, MLI-201209-3R3K 3.3UH 10% 0V 30MA
			L1214	OLCML00020G	Inductor, MLI-201209-3R3K 3.3UH 10% 0V 30MA
			L1216	OLCML00020G	Inductor, MLI-201209-3R3K 3.3UH 10% 0V 30MA
			L1217	OLCML00020G	Inductor, MLI-201209-3R3K 3.3UH 10% 0V 30MA
			L1221	OLCML00020G	Inductor, MLI-201209-3R3K 3.3UH 10% 0V 30MA
			L1222	OLCML00020G	Inductor, MLI-201209-3R3K 3.3UH 10% 0V 30MA
			L1304	EAP32842806	Inductor, NR8040T220M 22UH 20% 250V 2.2A 0.
			L1305	EAP32842806	Inductor, NR8040T220M 22UH 20% 250V 2.2A 0.
			L1306	EAP32842806	Inductor, NR8040T220M 22UH 20% 250V 2.2A 0.
			L1307	EAP32842806	Inductor, NR8040T220M 22UH 20% 250V 2.2A 0.
			L600	OLCTA00003A	Inductor, LEMC3225T6R8M 6.8UH 20% 50V 360MA
			L601	OLCTA00003A	Inductor, LEMC3225T6R8M 6.8UH 20% 50V 360MA
			L604	OLC0233002A	Inductor, FI-B2012-332KJT 3.3UH 10% 50V 50M
			L605	OLCTA00003A	Inductor, LEMC3225T6R8M 6.8UH 20% 50V 360MA
<b>FILTERs &amp; INDUCTORs</b>			<b>TRANSISTORs &amp; FETs</b>		
F1	6210VH0004A	Filter, 6210VH0004A 100OHM 30MM 13MM 34MM	Q101	OTR387500AA	2SC3875S(ALY) NPN 5V 60V 50V 150M
F2	6210VH0004A	Filter, 6210VH0004A 100OHM 30MM 13MM 34MM	Q102	OTR387500AA	2SC3875S(ALY) NPN 5V 60V 50V 150M
F3	6210VH0004A	Filter, 6210VH0004A 100OHM 30MM 13MM 34MM	Q103	OTR387500AA	2SC3875S(ALY) NPN 5V 60V 50V 150M
L100	6210TCE001G	Filter, HH-1M3216-501JT 500OHM 3.2X1.6X1.	Q1100	OTR387500AA	2SC3875S(ALY) NPN 5V 60V 50V 150M
L101	6210TCE001G	Filter, HH-1M3216-501JT 500OHM 3.2X1.6X1.	Q1200	OTR387500AA	2SC3875S(ALY) NPN 5V 60V 50V 150M
L102	6210TCE001G	Filter, HH-1M3216-501JT 500OHM 3.2X1.6X1.	Q1201	OTR387500AA	2SC3875S(ALY) NPN 5V 60V 50V 150M
L103	6210TCE001G	Filter, HH-1M3216-501JT 500OHM 3.2X1.6X1.	Q1202	OTR387500AA	2SC3875S(ALY) NPN 5V 60V 50V 150M
L104	6210TCE001G	Filter, HH-1M3216-501JT 500OHM 3.2X1.6X1.	Q1203	OTR102009AM	KRA102S PNP -30V 0V -50V -0.1A -0
L105	6210TCE001G	Filter, HH-1M3216-501JT 500OHM 3.2X1.6X1.	Q1204	OTR387500AA	2SC3875S(ALY) NPN 5V 60V 50V 150M
L106	6210TCE001G	Filter, HH-1M3216-501JT 500OHM 3.2X1.6X1.	Q1300	OTR387500AA	2SC3875S(ALY) NPN 5V 60V 50V 150M
L108	6210TCE001G	Filter, HH-1M3216-501JT 500OHM 3.2X1.6X1.	Q1301	OTR387500AA	2SC3875S(ALY) NPN 5V 60V 50V 150M
L1101	6210TCE001L	Filter, HB-1T2012-102JT 1000OHM 2X1.25X1M	Q1302	OTR387500AA	2SC3875S(ALY) NPN 5V 60V 50V 150M
L1102	6210TCE001L	Filter, HB-1T2012-102JT 1000OHM 2X1.25X1M	Q1303	OTR387500AA	2SC3875S(ALY) NPN 5V 60V 50V 150M
L1104	6210TCE001G	Filter, HH-1M3216-501JT 500OHM 3.2X1.6X1.	Q1304	OTR387500AA	2SC3875S(ALY) NPN 5V 60V 50V 150M
L1105	6210TCE001P	Filter, HB-1S2012-121JT(H:1mm) 120OHM 2X1	Q1305	OTR102009AM	KRA102S PNP -30V 0V -50V -0.1A -0
L1106	6210TCE001P	Filter, HB-1S2012-121JT(H:1mm) 120OHM 2X1			
L1107	6210TCE001P	Filter, HB-1S2012-121JT(H:1mm) 120OHM 2X1			
L1108	6210TCE001P	Filter, HB-1S2012-121JT(H:1mm) 120OHM 2X1			
L1109	6210TCE001P	Filter, HB-1S2012-121JT(H:1mm) 120OHM 2X1			
L1206	6210TCE001Z	Filter, HH-1M2012-600JT 60OHM 2X1.25X1MM			
L1207	6210TCE001Z	Filter, HH-1M2012-600JT 60OHM 2X1.25X1MM			
L1208	6210TCE001Z	Filter, HH-1M2012-600JT 60OHM 2X1.25X1MM			
L1211	6210TCE001L	Filter, HB-1T2012-102JT 1000OHM 2X1.25X1M			
L1212	6210TCE001L	Filter, HB-1T2012-102JT 1000OHM 2X1.25X1M			
L1300	6210TCE001G	Filter, HH-1M3216-501JT 500OHM 3.2X1.6X1.			
L1301	6210TCE001G	Filter, HH-1M3216-501JT 500OHM 3.2X1.6X1.			
L1302	6210TCE001G	Filter, HH-1M3216-501JT 500OHM 3.2X1.6X1.			
L1303	6210TCE001G	Filter, HH-1M3216-501JT 500OHM 3.2X1.6X1.			
L1309	6210TCE001S	Filter, HU-1M2012-121 120OHM 2X1.25X1MM S			
L1310	6210TCE001S	Filter, HU-1M2012-121 120OHM 2X1.25X1MM S			
L1311	6210TCE001S	Filter, HU-1M2012-121 120OHM 2X1.25X1MM S			
L1312	6210TCE001S	Filter, HU-1M2012-121 120OHM 2X1.25X1MM S			
L1314	6210TCE001G	Filter, HH-1M3216-501JT 500OHM 3.2X1.6X1.			
L1315	6210TCE001G	Filter, HH-1M3216-501JT 500OHM 3.2X1.6X1.			
L1401	6210TCE001G	Filter, HH-1M3216-501JT 500OHM 3.2X1.6X1.			
L1403	6210TCE001G	Filter, HH-1M3216-501JT 500OHM 3.2X1.6X1.			
L1412	6210TCE001E	Filter, HB-1M2012-800JT(H:1mm) 80OHM 2X1.			
L1413	6210TCE001E	Filter, HB-1M2012-800JT(H:1mm) 80OHM 2X1.			
L400	6210TCE001G	Filter, HH-1M3216-501JT 500OHM 3.2X1.6X1.			

LOC. NO.	PART NO.	DESCRIPTION / SPECIFICATION	LOC. NO.	PART NO.	DESCRIPTION / SPECIFICATION
Q1400	0TR387500AA	2SC3875S(ALY) NPN 5V 60V 50V 150M	AR309	0RJ0332C687	RCA86TRJ33R0 330OHM 5% 1/16W 4 SMD
Q1401	0TR387500AA	2SC3875S(ALY) NPN 5V 60V 50V 150M	AR310	0RJ0332C687	RCA86TRJ33R0 330OHM 5% 1/16W 4 SMD
Q1402	0TR387500AA	2SC3875S(ALY) NPN 5V 60V 50V 150M	AR311	0RJ0332C687	RCA86TRJ33R0 330OHM 5% 1/16W 4 SMD
Q1403	0TR150400BA	2SA1504S(ASY) PNP -5V -50V -50V -	AR312	0RJ0332C687	RCA86TRJ33R0 330OHM 5% 1/16W 4 SMD
Q1404	0TR387500AA	2SC3875S(ALY) NPN 5V 60V 50V 150M	AR313	0RJ0332C687	RCA86TRJ33R0 330OHM 5% 1/16W 4 SMD
Q400	0TR387500AA	2SC3875S(ALY) NPN 5V 60V 50V 150M	AR314	0RJ0332C687	RCA86TRJ33R0 330OHM 5% 1/16W 4 SMD
Q401	0TR387500AA	2SC3875S(ALY) NPN 5V 60V 50V 150M	AR701	0RZZH033273	MNR04M0ABJ330 330OHM 5% 1/16W 4 SM
Q402	0TR387500AA	2SC3875S(ALY) NPN 5V 60V 50V 150M	AR702	0RZZH033273	MNR04M0ABJ330 330OHM 5% 1/16W 4 SM
Q500	0TR102009AM	KRA102S PNP -30V 0V -50V -0.1A -0	AR704	EBC32260501	MNR04M0APJ000 0OHM 5% 1/16W 4 SMD
Q502	0TR387500AA	2SC3875S(ALY) NPN 5V 60V 50V 150M	AR706	0RZZH033273	MNR04M0ABJ330 330OHM 5% 1/16W 4 SM
Q503	0TR387500AA	2SC3875S(ALY) NPN 5V 60V 50V 150M	AR708	0RZZH033273	MNR04M0ABJ330 330OHM 5% 1/16W 4 SM
Q504	0TR150400BA	2SA1504S(ASY) PNP -5V -50V -50V -	AR800	EBC32260405	MNR04M0APJ680 680OHM 5% 1/16W 4 SM
Q602	0TR150400BA	2SA1504S(ASY) PNP -5V -50V -50V -	AR805	EBC32260405	MNR04M0APJ680 680OHM 5% 1/16W 4 SM
Q603	0TR387500AA	2SC3875S(ALY) NPN 5V 60V 50V 150M	AR806	EBC32260405	MNR04M0APJ680 680OHM 5% 1/16W 4 SM
Q604	0TR387500AA	2SC3875S(ALY) NPN 5V 60V 50V 150M	AR807	EBC32260405	MNR04M0APJ680 680OHM 5% 1/16W 4 SM
Q606	0TR150400BA	2SA1504S(ASY) PNP -5V -50V -50V -	AR808	EBC32260405	MNR04M0APJ680 680OHM 5% 1/16W 4 SM
Q607	0TR150400BA	2SA1504S(ASY) PNP -5V -50V -50V -	AR809	EBC32260405	MNR04M0APJ680 680OHM 5% 1/16W 4 SM
Q608	0TR387500AA	2SC3875S(ALY) NPN 5V 60V 50V 150M	AR810	EBC32260405	MNR04M0APJ680 680OHM 5% 1/16W 4 SM
Q609	0TR150400BA	2SA1504S(ASY) PNP -5V -50V -50V -	L1205	0RJ0000G676	MCR18EZHJ00 0OHM 5% 1/4W 3216 R/T
Q900	0TR387500AA	2SC3875S(ALY) NPN 5V 60V 50V 150M	L1215	0RJ0000G676	MCR18EZHJ00 0OHM 5% 1/4W 3216 R/T
Q901	0TR387500AA	2SC3875S(ALY) NPN 5V 60V 50V 150M	L1218	0RH0000D622	MCR10EZHJ000 0OHM 5% 1/8W 2012 R/
Q902	0TR387500AA	2SC3875S(ALY) NPN 5V 60V 50V 150M	L1219	0RH0000D622	MCR10EZHJ000 0OHM 5% 1/8W 2012 R/
Q903	0TR387500AA	2SC3875S(ALY) NPN 5V 60V 50V 150M	L1220	0RH0000D622	MCR10EZHJ000 0OHM 5% 1/8W 2012 R/
Q904	0TR387500AA	2SC3875S(ALY) NPN 5V 60V 50V 150M	R100	0RJ0000D677	MCR03EZPJ000 0OHM 5% 1/10W 1608 R
Q905	0TR387500AA	2SC3875S(ALY) NPN 5V 60V 50V 150M	R101	0RJ1100D677	MCR03EZPJ111 110OHM 5% 1/10W 1608
Q906	0TR387500AA	2SC3875S(ALY) NPN 5V 60V 50V 150M	R101	0RH0000D622	MCR10EZHJ000 0OHM 5% 1/8W 2012 R/
Q907	0TR387500AA	2SC3875S(ALY) NPN 5V 60V 50V 150M	R101	0RH1000D622	MCR10EZHJ101 100OHM 5% 1/8W 2012
			R101	0RJ0752D677	MCR03EZPJ750 750OHM 5% 1/10W 1608
			R1017	0RJ0222D677	MCR03EZPJ220 220OHM 5% 1/10W 1608
			R1018	0RJ6800D677	MCR03EZPJ681 680OHM 5% 1/10W 1608
			R1019	0RJ0222D677	MCR03EZPJ220 220OHM 5% 1/10W 1608
			R102	0RH0000D622	MCR10EZHJ000 0OHM 5% 1/8W 2012 R/
			R102	0RJ1101D677	MCR03EZPJ112 1.1KOHM 5% 1/10W 160
			R102	0RJ4700D677	MCR03EZPJ471 470OHM 5% 1/10W 1608
			R102	0RJ0472D677	MCR03EZPJ470 470OHM 5% 1/10W 1608
			R1020	0RJ6800D677	MCR03EZPJ681 680OHM 5% 1/10W 1608
			R1022	0RJ0222D677	MCR03EZPJ220 220OHM 5% 1/10W 1608
			R1023	0RJ0222D677	MCR03EZPJ220 220OHM 5% 1/10W 1608
			R103	0RH0000D622	MCR10EZHJ000 0OHM 5% 1/8W 2012 R/
			R103	0RH1000D622	MCR10EZHJ101 100OHM 5% 1/8W 2012
			R103	0RJ3301D677	MCR03EZPJ332 3.3KOHM 5% 1/10W 160
			R103	0RJ2203D677	MCR03EZPJ224 220KOHM 5% 1/10W 160
			R103	0RJ0472D677	MCR03EZPJ470 470OHM 5% 1/10W 1608
			R1038	0RJ0000D677	MCR03EZPJ000 0OHM 5% 1/10W 1608 R
			R1039	0RJ0000D677	MCR03EZPJ000 0OHM 5% 1/10W 1608 R
			R104	0RH5600D622	MCR10EZHJ561 560OHM 5% 1/8W 2012
			R104	0RJ9101D677	MCR03EZPJ912 9.1KOHM 5% 1/10W 160
			R104	0RJ4700D677	MCR03EZPJ471 470OHM 5% 1/10W 1608
			R1040	0RJ4702D677	MCR03EZPJ473 47KOHM 5% 1/10W 1608
			R1041	0RJ4702D677	MCR03EZPJ473 47KOHM 5% 1/10W 1608
			R1042	0RJ4702D677	MCR03EZPJ473 47KOHM 5% 1/10W 1608
			R1043	0RJ4702D677	MCR03EZPJ473 47KOHM 5% 1/10W 1608
			R1044	0RJ3301D677	MCR03EZPJ332 3.3KOHM 5% 1/10W 160
			R1049	0RJ0000D677	MCR03EZPJ000 0OHM 5% 1/10W 1608 R
			R105	0RJ1100D677	MCR03EZPJ111 110OHM 5% 1/10W 1608
<b>RESISTORS</b>					
AR100	0RJ0472C687	RCA86TRJ47R0 470OHM 5% 1/16W 4 SMD			
AR101	0RJ0472C687	RCA86TRJ47R0 470OHM 5% 1/16W 4 SMD			
AR102	0RJ0472C687	RCA86TRJ47R0 470OHM 5% 1/16W 4 SMD			
AR103	0RJ0472C687	RCA86TRJ47R0 470OHM 5% 1/16W 4 SMD			
AR104	0RJ0472C687	RCA86TRJ47R0 470OHM 5% 1/16W 4 SMD			
AR105	0RJ0472C687	RCA86TRJ47R0 470OHM 5% 1/16W 4 SMD			
AR106	0RJ0472C687	RCA86TRJ47R0 470OHM 5% 1/16W 4 SMD			
AR107	0RJ0472C687	RCA86TRJ47R0 470OHM 5% 1/16W 4 SMD			
AR108	0RJ0472C687	RCA86TRJ47R0 470OHM 5% 1/16W 4 SMD			
AR109	0RJ0472C687	RCA86TRJ47R0 470OHM 5% 1/16W 4 SMD			
AR110	0RJ0472C687	RCA86TRJ47R0 470OHM 5% 1/16W 4 SMD			
AR111	0RJ0472C687	RCA86TRJ47R0 470OHM 5% 1/16W 4 SMD			
AR200	0RJ0222C687	RCA86TRJ22R0 220OHM 5% 1/16W 4 SMD			
AR201	0RJ0222C687	RCA86TRJ22R0 220OHM 5% 1/16W 4 SMD			
AR202	0RJ0222C687	RCA86TRJ22R0 220OHM 5% 1/16W 4 SMD			
AR203	0RJ0222C687	RCA86TRJ22R0 220OHM 5% 1/16W 4 SMD			
AR204	0RJ0222C687	RCA86TRJ22R0 220OHM 5% 1/16W 4 SMD			
AR205	0RJ0222C687	RCA86TRJ22R0 220OHM 5% 1/16W 4 SMD			
AR206	0RJ0222C687	RCA86TRJ22R0 220OHM 5% 1/16W 4 SMD			
AR303	0RJ0332C687	RCA86TRJ33R0 330OHM 5% 1/16W 4 SMD			
AR304	0RJ0332C687	RCA86TRJ33R0 330OHM 5% 1/16W 4 SMD			
AR305	0RJ0332C687	RCA86TRJ33R0 330OHM 5% 1/16W 4 SMD			
AR306	0RJ0332C687	RCA86TRJ33R0 330OHM 5% 1/16W 4 SMD			
AR307	0RJ0332C687	RCA86TRJ33R0 330OHM 5% 1/16W 4 SMD			
AR308	0RJ0332C687	RCA86TRJ33R0 330OHM 5% 1/16W 4 SMD			

LOC. NO.	PART NO.	DESCRIPTION / SPECIFICATION	LOC. NO.	PART NO.	DESCRIPTION / SPECIFICATION
R105	0RH6801D622	MCR10EZHJ682 6.8KOHM 5% 1/8W 2012	R1139	0RJ1002D677	MCR03EZPJ103 10KOHM 5% 1/10W 1608
R105	0RJ2203D677	MCR03EZPJ224 220KOHM 5% 1/10W 160	R114	0RJ1002D677	MCR03EZPJ103 10KOHM 5% 1/10W 1608
R105	0RJ4701D677	MCR03EZPJ472 4.7KOHM 5% 1/10W 160	R1140	0RJ0000D677	MCR03EZPJ000 0OHM 5% 1/10W 1608 R
R1050	0RJ0000D677	MCR03EZPJ000 0OHM 5% 1/10W 1608 R	R1141	0RJ0000D677	MCR03EZPJ000 0OHM 5% 1/10W 1608 R
R1052	0RJ0000D677	MCR03EZPJ000 0OHM 5% 1/10W 1608 R	R1148	0RJ1000D677	MCR03EZPJ101 100OHM 5% 1/10W 1608
R1053	0RJ0000D677	MCR03EZPJ000 0OHM 5% 1/10W 1608 R	R1150	0RJ1000D677	MCR03EZPJ101 100OHM 5% 1/10W 1608
R1056	0RJ1002D677	MCR03EZPJ103 10KOHM 5% 1/10W 1608	R1151	0RJ1000D677	MCR03EZPJ101 100OHM 5% 1/10W 1608
R1057	0RJ1002D677	MCR03EZPJ103 10KOHM 5% 1/10W 1608	R1152	0RJ1000D677	MCR03EZPJ101 100OHM 5% 1/10W 1608
R106	0RJ1101D677	MCR03EZPJ112 1.1KOHM 5% 1/10W 160	R1157	0RJ1000D677	MCR03EZPJ101 100OHM 5% 1/10W 1608
R106	0RJ0000D677	MCR03EZPJ000 0OHM 5% 1/10W 1608 R	R1158	0RJ1000D677	MCR03EZPJ101 100OHM 5% 1/10W 1608
R106	0RJ0000D677	MCR03EZPJ000 0OHM 5% 1/10W 1608 R	R1161	0RJ1000D677	MCR03EZPJ101 100OHM 5% 1/10W 1608
R1060	0RJ3302D677	MCR03EZPJ333 33KOHM 5% 1/10W 1608	R1162	0RJ4701D677	MCR03EZPJ472 4.7KOHM 5% 1/10W 160
R1061	0RJ3302D677	MCR03EZPJ333 33KOHM 5% 1/10W 1608	R1164	0RJ1000D677	MCR03EZPJ101 100OHM 5% 1/10W 1608
R107	0RJ3301D677	MCR03EZPJ332 3.3KOHM 5% 1/10W 160	R1165	0RJ1000D677	MCR03EZPJ101 100OHM 5% 1/10W 1608
R107	0RJ0752D677	MCR03EZPJ750 75OHM 5% 1/10W 1608	R1166	0RJ3301D677	MCR03EZPJ332 3.3KOHM 5% 1/10W 160
R108	0RJ9101D677	MCR03EZPJ912 9.1KOHM 5% 1/10W 160	R1167	0RJ0000D677	MCR03EZPJ000 0OHM 5% 1/10W 1608 R
R108	0RJ3901E672	MCR10EZHJ392 3.9KOHM 5% 1/8W 2012	R1168	0RJ0000D677	MCR03EZPJ000 0OHM 5% 1/10W 1608 R
R108	0RJ0000D677	MCR03EZPJ000 0OHM 5% 1/10W 1608 R	R1169	0RJ1001D677	MCR03EZPJ102 1KOHM 5% 1/10W 1608
R109	0RH0000D622	MCR10EZHJ000 0OHM 5% 1/8W 2012 R/	R1170	0RJ1002D677	MCR03EZPJ103 10KOHM 5% 1/10W 1608
R109	0RJ0752D677	MCR03EZPJ750 75OHM 5% 1/10W 1608	R1171	0RJ0000D677	MCR03EZPJ000 0OHM 5% 1/10W 1608 R
R110	0RJ0000D677	MCR03EZPJ000 0OHM 5% 1/10W 1608 R	R1185	0RH0000D622	MCR10EZHJ000 0OHM 5% 1/8W 2012 R/
R110	0RJ1002D677	MCR03EZPJ103 10KOHM 5% 1/10W 1608	R1186	0RH0000D622	MCR10EZHJ000 0OHM 5% 1/8W 2012 R/
R1101	0RJ1002D677	MCR03EZPJ103 10KOHM 5% 1/10W 1608	R119	0RJ0000D677	MCR03EZPJ000 0OHM 5% 1/10W 1608 R
R1102	0RJ1001D677	MCR03EZPJ102 1KOHM 5% 1/10W 1608	R120	0RJ1802D677	MCR03EZPJ183 18KOHM 5% 1/10W 1608
R1103	0RJ1002D677	MCR03EZPJ103 10KOHM 5% 1/10W 1608	R1200	0RJ0752D677	MCR03EZPJ750 75OHM 5% 1/10W 1608
R1104	0RJ0000D677	MCR03EZPJ000 0OHM 5% 1/10W 1608 R	R1201	0RJ0000D677	MCR03EZPJ000 0OHM 5% 1/10W 1608 R
R1107	0RJ4701D677	MCR03EZPJ472 4.7KOHM 5% 1/10W 160	R1202	0RJ0682D677	MCR03EZPJ680 68OHM 5% 1/10W 1608
R1108	0RJ4701D677	MCR03EZPJ472 4.7KOHM 5% 1/10W 160	R1203	0RJ4703D677	MCR03EZPJ474 470KOHM 5% 1/10W 160
R111	0RJ1002D677	MCR03EZPJ103 10KOHM 5% 1/10W 1608	R1204	0RJ4702D677	MCR03EZPJ473 47KOHM 5% 1/10W 1608
R1113	0RJ0752D677	MCR03EZPJ750 75OHM 5% 1/10W 1608	R1205	0RJ2203D677	MCR03EZPJ224 220KOHM 5% 1/10W 160
R1114	0RJ2203D677	MCR03EZPJ224 220KOHM 5% 1/10W 160	R1207	0RJ2203D677	MCR03EZPJ224 220KOHM 5% 1/10W 160
R1115	0RJ0752D677	MCR03EZPJ750 75OHM 5% 1/10W 1608	R1209	0RJ3002D677	MCR03EZPJ303 30KOHM 5% 1/10W 1608
R1116	0RJ2203D677	MCR03EZPJ224 220KOHM 5% 1/10W 160	R121	0RJ1202D677	MCR03EZPJ123 12KOHM 5% 1/10W 1608
R1117	0RJ0752D677	MCR03EZPJ750 75OHM 5% 1/10W 1608	R1210	0RJ2203D677	MCR03EZPJ224 220KOHM 5% 1/10W 160
R1118	0RJ1001D677	MCR03EZPJ102 1KOHM 5% 1/10W 1608	R1211	0RJ4703D677	MCR03EZPJ474 470KOHM 5% 1/10W 160
R1119	0RJ1001D677	MCR03EZPJ102 1KOHM 5% 1/10W 1608	R1212	0RJ2203D677	MCR03EZPJ224 220KOHM 5% 1/10W 160
R112	0RJ1002D677	MCR03EZPJ103 10KOHM 5% 1/10W 1608	R1213	0RJ4703D677	MCR03EZPJ474 470KOHM 5% 1/10W 160
R1120	0RJ4701D677	MCR03EZPJ472 4.7KOHM 5% 1/10W 160	R1214	0RJ0752D677	MCR03EZPJ750 75OHM 5% 1/10W 1608
R1121	0RJ1001D677	MCR03EZPJ102 1KOHM 5% 1/10W 1608	R1215	0RJ1001D477	MCR03EZPF102 1KOHM 1% 1/10W 1608
R1122	0RJ4701D677	MCR03EZPJ472 4.7KOHM 5% 1/10W 160	R1216	0RJ1001D477	MCR03EZPF102 1KOHM 1% 1/10W 1608
R1123	0RJ0000D677	MCR03EZPJ000 0OHM 5% 1/10W 1608 R	R1219	0RJ0752D677	MCR03EZPJ750 75OHM 5% 1/10W 1608
R1124	0RJ0222D677	MCR03EZPJ220 22OHM 5% 1/10W 1608	R122	0RJ0472D677	MCR03EZPJ470 47OHM 5% 1/10W 1608
R1125	0RJ0222D677	MCR03EZPJ220 22OHM 5% 1/10W 1608	R1220	0RJ2203D677	MCR03EZPJ224 220KOHM 5% 1/10W 160
R1126	0RJ1001D677	MCR03EZPJ102 1KOHM 5% 1/10W 1608	R1221	0RJ0752D677	MCR03EZPJ750 75OHM 5% 1/10W 1608
R1127	0RJ0000D677	MCR03EZPJ000 0OHM 5% 1/10W 1608 R	R1222	0RJ0752D677	MCR03EZPJ750 75OHM 5% 1/10W 1608
R1128	0RJ0222D677	MCR03EZPJ220 22OHM 5% 1/10W 1608	R1223	0RJ2203D677	MCR03EZPJ224 220KOHM 5% 1/10W 160
R1129	0RJ0000D677	MCR03EZPJ000 0OHM 5% 1/10W 1608 R	R1224	0RJ1001D677	MCR03EZPJ102 1KOHM 5% 1/10W 1608
R113	0RJ1002D677	MCR03EZPJ103 10KOHM 5% 1/10W 1608	R1225	0RJ1001D477	MCR03EZPF102 1KOHM 1% 1/10W 1608
R1130	0RJ0000D677	MCR03EZPJ000 0OHM 5% 1/10W 1608 R	R1226	0RJ1001D477	MCR03EZPF102 1KOHM 1% 1/10W 1608
R1131	0RJ0000D677	MCR03EZPJ000 0OHM 5% 1/10W 1608 R	R1227	0RJ2201D477	MCR03EZPF222 2.2KOHM 1% 1/10W 160
R1133	0RJ0000D677	MCR03EZPJ000 0OHM 5% 1/10W 1608 R	R1228	0RJ2201D477	MCR03EZPF222 2.2KOHM 1% 1/10W 160
R1134	0RJ0000D677	MCR03EZPJ000 0OHM 5% 1/10W 1608 R	R1229	0RJ0752D677	MCR03EZPJ750 75OHM 5% 1/10W 1608
R1135	0RJ1001D677	MCR03EZPJ102 1KOHM 5% 1/10W 1608	R123	0RJ0472C678	MCR01MZPJ470 47OHM 5% 1/16W 1005
R1136	0RJ1000D677	MCR03EZPJ101 100OHM 5% 1/10W 1608	R1230	0RJ0752D677	MCR03EZPJ750 75OHM 5% 1/10W 1608
R1137	0RJ1000D677	MCR03EZPJ101 100OHM 5% 1/10W 1608	R1231	0RJ1002D677	MCR03EZPJ103 10KOHM 5% 1/10W 1608

LOC. NO.	PART NO.	DESCRIPTION / SPECIFICATION	LOC. NO.	PART NO.	DESCRIPTION / SPECIFICATION
R1235	0RJ4703D677	MCR03EZPJ474 470KOHM 5% 1/10W 160	R1310	0RJ0000D677	MCR03EZPJ000 0OHM 5% 1/10W 1608 R
R1236	0RJ4703D677	MCR03EZPJ474 470KOHM 5% 1/10W 160	R1311	0RJ1000D677	MCR03EZPJ101 100OHM 5% 1/10W 1608
R1237	0RJ1001D477	MCR03EZPF102 1KOHM 1% 1/10W 1608	R1312	0RJ1000D677	MCR03EZPJ101 100OHM 5% 1/10W 1608
R1238	0RJ1001D477	MCR03EZPF102 1KOHM 1% 1/10W 1608	R1313	0RJ1000D677	MCR03EZPJ101 100OHM 5% 1/10W 1608
R1239	0RJ0000D677	MCR03EZPJ000 0OHM 5% 1/10W 1608 R	R1314	0RJ1000D677	MCR03EZPJ101 100OHM 5% 1/10W 1608
R124	0RJ1200C678	MCR01MZPJ121 120OHM 5% 1/16W 1005	R1315	0RJ1001D677	MCR03EZPJ102 1KOHM 5% 1/10W 1608
R1240	0RJ0752D677	MCR03EZPJ750 75OHM 5% 1/10W 1608	R1316	0RJ1001D677	MCR03EZPJ102 1KOHM 5% 1/10W 1608
R1241	0RJ0752D677	MCR03EZPJ750 75OHM 5% 1/10W 1608	R1317	0RJ4701D677	MCR03EZPJ472 4.7KOHM 5% 1/10W 160
R1242	0RJ0752D677	MCR03EZPJ750 75OHM 5% 1/10W 1608	R1318	0RJ4701D677	MCR03EZPJ472 4.7KOHM 5% 1/10W 160
R1243	0RJ0752D677	MCR03EZPJ750 75OHM 5% 1/10W 1608	R1319	0RJ0000D677	MCR03EZPJ000 0OHM 5% 1/10W 1608 R
R1244	0RJ0752D677	MCR03EZPJ750 75OHM 5% 1/10W 1608	R1320	0RJ0000D677	MCR03EZPJ000 0OHM 5% 1/10W 1608 R
R1245	0RJ0752D677	MCR03EZPJ750 75OHM 5% 1/10W 1608	R1321	0RJ2001D677	MCR03EZPJ202 2KOHM 5% 1/10W 1608
R125	0RJ0472D677	MCR03EZPJ470 47OHM 5% 1/10W 1608	R1322	0RJ2001D677	MCR03EZPJ202 2KOHM 5% 1/10W 1608
R1259	0RJ1001D677	MCR03EZPJ102 1KOHM 5% 1/10W 1608	R1323	0RJ4703D677	MCR03EZPJ474 470KOHM 5% 1/10W 160
R126	0RJ0472D677	MCR03EZPJ470 47OHM 5% 1/10W 1608	R1324	0RJ4703D677	MCR03EZPJ474 470KOHM 5% 1/10W 160
R1260	0RJ2001D677	MCR03EZPJ202 2KOHM 5% 1/10W 1608	R1327	0RJ0000D677	MCR03EZPJ000 0OHM 5% 1/10W 1608 R
R1261	0RJ2001D677	MCR03EZPJ202 2KOHM 5% 1/10W 1608	R1328	0RJ2200D677	MCR03EZPJ221 220OHM 5% 1/10W 1608
R1262	0RJ0000D677	MCR03EZPJ000 0OHM 5% 1/10W 1608 R	R1329	0RJ0101D677	MCR03EZPJ1R0 1OHM 5% 1/10W 1608 R
R1263	0RJ0000D677	MCR03EZPJ000 0OHM 5% 1/10W 1608 R	R133	0RJ0472D677	MCR03EZPJ470 47OHM 5% 1/10W 1608
R1264	0RJ0000D677	MCR03EZPJ000 0OHM 5% 1/10W 1608 R	R1330	0RJ0101D677	MCR03EZPJ1R0 1OHM 5% 1/10W 1608 R
R1270	0RJ1001D677	MCR03EZPJ102 1KOHM 5% 1/10W 1608	R1331	0RJ1002D677	MCR03EZPJ103 10KOHM 5% 1/10W 1608
R1271	0RJ1001D677	MCR03EZPJ102 1KOHM 5% 1/10W 1608	R1332	0RJ2200D677	MCR03EZPJ221 220OHM 5% 1/10W 1608
R1273	0RJ3301D677	MCR03EZPJ332 3.3KOHM 5% 1/10W 160	R1333	0RJ2200D677	MCR03EZPJ221 220OHM 5% 1/10W 1608
R1274	0RJ0752D677	MCR03EZPJ750 75OHM 5% 1/10W 1608	R1334	0RJ2200D677	MCR03EZPJ221 220OHM 5% 1/10W 1608
R1275	0RJ0000D677	MCR03EZPJ000 0OHM 5% 1/10W 1608 R	R1338	0RJ3901D677	MCR03EZPJ392 3.9KOHM 5% 1/10W 160
R1276	0RJ3002D677	MCR03EZPJ303 30KOHM 5% 1/10W 1608	R134	0RJ0472D677	MCR03EZPJ470 47OHM 5% 1/10W 1608
R1277	0RJ2203D677	MCR03EZPJ224 220KOHM 5% 1/10W 160	R1345	0RJ4701D677	MCR03EZPJ472 4.7KOHM 5% 1/10W 160
R1278	0RJ2203D677	MCR03EZPJ224 220KOHM 5% 1/10W 160	R1346	0RJ4701D677	MCR03EZPJ472 4.7KOHM 5% 1/10W 160
R1279	0RJ4702D677	MCR03EZPJ473 47KOHM 5% 1/10W 1608	R1347	0RJ0392D677	MCR03EZPJ390 39OHM 5% 1/10W 1608
R128	0RJ0472D677	MCR03EZPJ470 47OHM 5% 1/10W 1608	R1348	0RJ0392D677	MCR03EZPJ390 39OHM 5% 1/10W 1608
R1280	0RJ1001D677	MCR03EZPJ102 1KOHM 5% 1/10W 1608	R1349	0RJ0392D677	MCR03EZPJ390 39OHM 5% 1/10W 1608
R1281	0RJ1001D677	MCR03EZPJ102 1KOHM 5% 1/10W 1608	R1350	0RJ0392D677	MCR03EZPJ390 39OHM 5% 1/10W 1608
R1282	0RJ2203D677	MCR03EZPJ224 220KOHM 5% 1/10W 160	R1351	0RJ0122D677	MCR03EZPJ120 12OHM 5% 1/10W 1608
R1283	0RJ2203D677	MCR03EZPJ224 220KOHM 5% 1/10W 160	R1352	0RJ0122D677	MCR03EZPJ120 12OHM 5% 1/10W 1608
R1284	0RH0000D622	MCR10EZHJ000 0OHM 5% 1/8W 2012 R/	R1353	0RJ0122D677	MCR03EZPJ120 12OHM 5% 1/10W 1608
R1285	0RH0000D622	MCR10EZHJ000 0OHM 5% 1/8W 2012 R/	R1354	0RJ0122D677	MCR03EZPJ120 12OHM 5% 1/10W 1608
R1286	0RH0000D622	MCR10EZHJ000 0OHM 5% 1/8W 2012 R/	R1355	0RJ0122D677	MCR03EZPJ120 12OHM 5% 1/10W 1608
R1287	0RH0000D622	MCR10EZHJ000 0OHM 5% 1/8W 2012 R/	R1356	0RJ0122D677	MCR03EZPJ120 12OHM 5% 1/10W 1608
R1288	0RH0000D622	MCR10EZHJ000 0OHM 5% 1/8W 2012 R/	R1357	0RJ0122D677	MCR03EZPJ120 12OHM 5% 1/10W 1608
R1289	0RH0000D622	MCR10EZHJ000 0OHM 5% 1/8W 2012 R/	R1358	0RJ0122D677	MCR03EZPJ120 12OHM 5% 1/10W 1608
R129	0RJ0472D677	MCR03EZPJ470 47OHM 5% 1/10W 1608	R1359	0RJ0000D677	MCR03EZPJ000 0OHM 5% 1/10W 1608 R
R1290	0RH0000D622	MCR10EZHJ000 0OHM 5% 1/8W 2012 R/	R136	0RJ0472C678	MCR01MZPJ470 47OHM 5% 1/16W 1005
R1291	0RH0000D622	MCR10EZHJ000 0OHM 5% 1/8W 2012 R/	R1360	0RJ0000D677	MCR03EZPJ000 0OHM 5% 1/10W 1608 R
R1292	0RH0000D622	MCR10EZHJ000 0OHM 5% 1/8W 2012 R/	R1361	0RJ0000D677	MCR03EZPJ000 0OHM 5% 1/10W 1608 R
R1293	0RH0000D622	MCR10EZHJ000 0OHM 5% 1/8W 2012 R/	R1362	0RJ0000D677	MCR03EZPJ000 0OHM 5% 1/10W 1608 R
R1300	0RJ6202D677	MCR03EZPJ623 62KOHM 5% 1/10W 1608	R1363	0RD3301A609	RDM92T1J3K30 3.3KOHM 5% 1/2W 6.5X
R1301	0RJ2402D677	MCR03EZPJ243 24KOHM 5% 1/10W 1608	R1364	0RJ7500D677	MCR03EZPJ751 750OHM 5% 1/10W 1608
R1302	0RJ4700D677	MCR03EZPJ471 470OHM 5% 1/10W 1608	R1365	0RJ7500D677	MCR03EZPJ751 750OHM 5% 1/10W 1608
R1303	0RJ1501D677	MCR03EZPJ152 1.5KOHM 5% 1/10W 160	R1366	0RJ7500D677	MCR03EZPJ751 750OHM 5% 1/10W 1608
R1304	0RJ0432D677	MCR03EZPJ430 43OHM 5% 1/10W 1608	R1367	0RJ0000D677	MCR03EZPJ000 0OHM 5% 1/10W 1608 R
R1305	0RJ0432D677	MCR03EZPJ430 43OHM 5% 1/10W 1608	R1368	0RJ0000D677	MCR03EZPJ000 0OHM 5% 1/10W 1608 R
R1307	0RJ1000D677	MCR03EZPJ101 100OHM 5% 1/10W 1608	R137	0RJ0472D677	MCR03EZPJ470 47OHM 5% 1/10W 1608
R1308	0RJ1000D677	MCR03EZPJ101 100OHM 5% 1/10W 1608	R138	0RJ1002D677	MCR03EZPJ103 10KOHM 5% 1/10W 1608
R1309	0RJ1000D677	MCR03EZPJ101 100OHM 5% 1/10W 1608	R139	0RJ0472D677	MCR03EZPJ470 47OHM 5% 1/10W 1608
R131	0RJ0472D677	MCR03EZPJ470 47OHM 5% 1/10W 1608	R140	0RJ0472D677	MCR03EZPJ470 47OHM 5% 1/10W 1608

LOC. NO.	PART NO.	DESCRIPTION / SPECIFICATION	LOC. NO.	PART NO.	DESCRIPTION / SPECIFICATION
R1400	0RJ1501D677	MCR03EZPJ152 1.5KOHM 5% 1/10W 160	R153	0RJ0472C678	MCR01MZPJ470 47OHM 5% 1/16W 1005
R1401	0RJ4701D677	MCR03EZPJ472 4.7KOHM 5% 1/10W 160	R154	0RJ1002D677	MCR03EZPJ103 10KOHM 5% 1/10W 1608
R1402	0RJ1000D677	MCR03EZPJ101 100OHM 5% 1/10W 1608	R155	0RJ3303D677	MCR03EZPJ334 330KOHM 5% 1/10W 160
R1403	0RJ1000D677	MCR03EZPJ101 100OHM 5% 1/10W 1608	R157	0RJ0472D677	MCR03EZPJ470 47OHM 5% 1/10W 1608
R1404	0RJ1001D677	MCR03EZPJ102 1KOHM 5% 1/10W 1608	R1607	0RJ0000D677	MCR03EZPJ000 0OHM 5% 1/10W 1608 R
R1405	0RJ1001D677	MCR03EZPJ102 1KOHM 5% 1/10W 1608	R1608	0RJ0000D677	MCR03EZPJ000 0OHM 5% 1/10W 1608 R
R1406	0RJ0000D677	MCR03EZPJ000 0OHM 5% 1/10W 1608 R	R1609	0RJ0000D677	MCR03EZPJ000 0OHM 5% 1/10W 1608 R
R1407	0RJ0000D677	MCR03EZPJ000 0OHM 5% 1/10W 1608 R	R162	0RJ0472D677	MCR03EZPJ470 47OHM 5% 1/10W 1608
R1408	0RJ0000D677	MCR03EZPJ000 0OHM 5% 1/10W 1608 R	R163	0RJ0472D677	MCR03EZPJ470 47OHM 5% 1/10W 1608
R1409	0RJ1500D677	MCR03EZPJ151 150OHM 5% 1/10W 1608	R164	0RJ1202D677	MCR03EZPJ123 12KOHM 5% 1/10W 1608
R1410	0RJ0000D677	MCR03EZPJ000 0OHM 5% 1/10W 1608 R	R165	0RJ1002D677	MCR03EZPJ103 10KOHM 5% 1/10W 1608
R1411	0RJ2200D677	MCR03EZPJ221 220OHM 5% 1/10W 1608	R166	0RJ0472D677	MCR03EZPJ470 47OHM 5% 1/10W 1608
R1412	0RJ2200D677	MCR03EZPJ221 220OHM 5% 1/10W 1608	R167	0RJ1002D677	MCR03EZPJ103 10KOHM 5% 1/10W 1608
R1413	0RJ0000D677	MCR03EZPJ000 0OHM 5% 1/10W 1608 R	R168	0RJ1002D677	MCR03EZPJ103 10KOHM 5% 1/10W 1608
R1414	0RJ1000D677	MCR03EZPJ101 100OHM 5% 1/10W 1608	R169	0RJ0000D677	MCR03EZPJ000 0OHM 5% 1/10W 1608 R
R1415	0RJ2200D677	MCR03EZPJ221 220OHM 5% 1/10W 1608	R170	0RJ0000D677	MCR03EZPJ000 0OHM 5% 1/10W 1608 R
R1416	0RJ2200D677	MCR03EZPJ221 220OHM 5% 1/10W 1608	R1703	0RJ1000C678	MCR01MZPJ101 100OHM 5% 1/16W 1005
R1417	0RJ1000D677	MCR03EZPJ101 100OHM 5% 1/10W 1608	R1704	0RJ1000C678	MCR01MZPJ101 100OHM 5% 1/16W 1005
R1418	0RJ1000D677	MCR03EZPJ101 100OHM 5% 1/10W 1608	R1706	0RJ0332C678	MCR01MZPJ330 33OHM 5% 1/16W 1005
R1419	0RJ1000D677	MCR03EZPJ101 100OHM 5% 1/10W 1608	R1708	0RJ0332D677	MCR03EZPJ330 33OHM 5% 1/10W 1608
R142	0RJ0472D677	MCR03EZPJ470 47OHM 5% 1/10W 1608	R1709	0RJ1002D677	MCR03EZPJ103 10KOHM 5% 1/10W 1608
R1420	0RJ1000D677	MCR03EZPJ101 100OHM 5% 1/10W 1608	R1710	0RJ0222C678	MCR01MZPJ220 22OHM 5% 1/16W 1005
R1421	0RJ1000D677	MCR03EZPJ101 100OHM 5% 1/10W 1608	R1713	0RJ4701D677	MCR03EZPJ472 4.7KOHM 5% 1/10W 160
R1422	0RJ1000D677	MCR03EZPJ101 100OHM 5% 1/10W 1608	R1714	0RJ0000C678	MCR01MZPJ000 0OHM 5% 1/16W 1005 R
R1423	0RJ1000D677	MCR03EZPJ101 100OHM 5% 1/10W 1608	R1715	0RJ1000D677	MCR03EZPJ101 100OHM 5% 1/10W 1608
R1429	0RJ1001C678	MCR01MZPJ102 1KOHM 5% 1/16W 1005	R1716	0RJ1000C678	MCR01MZPJ101 100OHM 5% 1/16W 1005
R143	0RJ2701D677	MCR03EZPJ272 2.7KOHM 5% 1/10W 160	R1717	0RJ1002D677	MCR03EZPJ103 10KOHM 5% 1/10W 1608
R1430	0RJ1201C678	MCR01MZPJ122 1.2KOHM 5% 1/16W 100	R1718	0RJ1000C678	MCR01MZPJ101 100OHM 5% 1/16W 1005
R1431	0RJ1201C678	MCR01MZPJ122 1.2KOHM 5% 1/16W 100	R1719	0RJ0332D677	MCR03EZPJ330 33OHM 5% 1/10W 1608
R1433	0RJ1000C678	MCR01MZPJ101 100OHM 5% 1/16W 1005	R1720	0RJ1000C678	MCR01MZPJ101 100OHM 5% 1/16W 1005
R1436	0RJ1201C678	MCR01MZPJ122 1.2KOHM 5% 1/16W 100	R1721	0RJ4701D677	MCR03EZPJ472 4.7KOHM 5% 1/10W 160
R1438	0RJ1201C678	MCR01MZPJ122 1.2KOHM 5% 1/16W 100	R1722	0RJ1002D677	MCR03EZPJ103 10KOHM 5% 1/10W 1608
R1439	0RJ1000C678	MCR01MZPJ101 100OHM 5% 1/16W 1005	R1724	0RJ0332C678	MCR01MZPJ330 33OHM 5% 1/16W 1005
R144	0RJ0472D677	MCR03EZPJ470 47OHM 5% 1/10W 1608	R1726	0RJ1000D677	MCR03EZPJ101 100OHM 5% 1/10W 1608
R145	0RJ2701D677	MCR03EZPJ272 2.7KOHM 5% 1/10W 160	R1727	0RJ0332D677	MCR03EZPJ330 33OHM 5% 1/10W 1608
R1452	0RJ1000D677	MCR03EZPJ101 100OHM 5% 1/10W 1608	R1728	0RJ0332D677	MCR03EZPJ330 33OHM 5% 1/10W 1608
R1453	0RJ4703D677	MCR03EZPJ474 470KOHM 5% 1/10W 160	R1729	0RJ0332D677	MCR03EZPJ330 33OHM 5% 1/10W 1608
R1454	0RJ4703D677	MCR03EZPJ474 470KOHM 5% 1/10W 160	R173	0RJ0472D677	MCR03EZPJ470 47OHM 5% 1/10W 1608
R1455	0RJ4701D677	MCR03EZPJ472 4.7KOHM 5% 1/10W 160	R1730	0RJ0332D677	MCR03EZPJ330 33OHM 5% 1/10W 1608
R1456	0RJ1501D677	MCR03EZPJ152 1.5KOHM 5% 1/10W 160	R1731	0RJ0332D677	MCR03EZPJ330 33OHM 5% 1/10W 1608
R146	0RJ2701D677	MCR03EZPJ272 2.7KOHM 5% 1/10W 160	R1732	0RJ0332D677	MCR03EZPJ330 33OHM 5% 1/10W 1608
R1460	0RJ1000C678	MCR01MZPJ101 100OHM 5% 1/16W 1005	R1733	0RJ0332D677	MCR03EZPJ330 33OHM 5% 1/10W 1608
R1461	0RJ1000C678	MCR01MZPJ101 100OHM 5% 1/16W 1005	R1734	0RJ0332D677	MCR03EZPJ330 33OHM 5% 1/10W 1608
R1462	0RJ1000C678	MCR01MZPJ101 100OHM 5% 1/16W 1005	R1735	0RJ0332D677	MCR03EZPJ330 33OHM 5% 1/10W 1608
R1463	0RJ1003D677	MCR03EZPJ104 100KOHM 5% 1/10W 160	R1736	0RJ0332D677	MCR03EZPJ330 33OHM 5% 1/10W 1608
R1465	0RJ1000C678	MCR01MZPJ101 100OHM 5% 1/16W 1005	R1737	0RJ0332D677	MCR03EZPJ330 33OHM 5% 1/10W 1608
R1466	0RJ1201C678	MCR01MZPJ122 1.2KOHM 5% 1/16W 100	R1738	0RJ0332D677	MCR03EZPJ330 33OHM 5% 1/10W 1608
R1467	0RJ1001D677	MCR03EZPJ102 1KOHM 5% 1/10W 1608	R1739	0RJ0332D677	MCR03EZPJ330 33OHM 5% 1/10W 1608
R1468	0RJ1201C678	MCR01MZPJ122 1.2KOHM 5% 1/16W 100	R1740	0RJ0332D677	MCR03EZPJ330 33OHM 5% 1/10W 1608
R147	0RJ0472D677	MCR03EZPJ470 47OHM 5% 1/10W 1608	R1741	0RJ0332D677	MCR03EZPJ330 33OHM 5% 1/10W 1608
R148	0RJ0472D677	MCR03EZPJ470 47OHM 5% 1/10W 1608	R1742	0RJ0332D677	MCR03EZPJ330 33OHM 5% 1/10W 1608
R149	0RJ2701D677	MCR03EZPJ272 2.7KOHM 5% 1/10W 160	R1743	0RJ1000D477	MCR03EZPF101 100OHM 1% 1/10W 1608
R150	0RJ0472D677	MCR03EZPJ470 47OHM 5% 1/10W 1608	R1744	0RJ1500D477	MCR03EZPF151 150OHM 1% 1/10W 1608
R151	0RJ0472C678	MCR01MZPJ470 47OHM 5% 1/16W 1005	R1745	0RJ0222D677	MCR03EZPJ220 22OHM 5% 1/10W 1608
R152	0RJ0472D677	MCR03EZPJ470 47OHM 5% 1/10W 1608	R1747	0RJ1000D677	MCR03EZPJ101 100OHM 5% 1/10W 1608

LOC. NO.	PART NO.	DESCRIPTION / SPECIFICATION	LOC. NO.	PART NO.	DESCRIPTION / SPECIFICATION
R1748	0RJ1000D677	MCR03EZPJ101 100OHM 5% 1/10W 1608	R205	0RJ1000D677	MCR03EZPJ101 100OHM 5% 1/10W 1608
R1749	0RJ1000D677	MCR03EZPJ101 100OHM 5% 1/10W 1608	R206	0RJ1000D677	MCR03EZPJ101 100OHM 5% 1/10W 1608
R175	0RJ1002D677	MCR03EZPJ103 10KOHM 5% 1/10W 1608	R207	0RJ1000D677	MCR03EZPJ101 100OHM 5% 1/10W 1608
R1750	0RJ0222C678	MCR01MZPJ220 22OHM 5% 1/16W 1005	R208	0RJ1000D677	MCR03EZPJ101 100OHM 5% 1/10W 1608
R1751	0RJ0222C678	MCR01MZPJ220 22OHM 5% 1/16W 1005	R209	0RJ1000D677	MCR03EZPJ101 100OHM 5% 1/10W 1608
R1752	0RJ4701D677	MCR03EZPJ472 4.7KOHM 5% 1/10W 160	R210	0RJ1000D677	MCR03EZPJ101 100OHM 5% 1/10W 1608
R1753	0RJ4701D677	MCR03EZPJ472 4.7KOHM 5% 1/10W 160	R211	0RJ1000D677	MCR03EZPJ101 100OHM 5% 1/10W 1608
R1758	0RJ1000D677	MCR03EZPJ101 100OHM 5% 1/10W 1608	R212	0RJ1000D677	MCR03EZPJ101 100OHM 5% 1/10W 1608
R1759	0RJ0222C678	MCR01MZPJ220 22OHM 5% 1/16W 1005	R213	0RJ1000D677	MCR03EZPJ101 100OHM 5% 1/10W 1608
R1760	0RJ0222C678	MCR01MZPJ220 22OHM 5% 1/16W 1005	R214	0RJ1000D677	MCR03EZPJ101 100OHM 5% 1/10W 1608
R1761	0RJ0222D677	MCR03EZPJ220 22OHM 5% 1/10W 1608	R215	0RJ1000D677	MCR03EZPJ101 100OHM 5% 1/10W 1608
R1762	0RJ0222D677	MCR03EZPJ220 22OHM 5% 1/10W 1608	R216	0RJ1000D677	MCR03EZPJ101 100OHM 5% 1/10W 1608
R1763	0RJ0222C678	MCR01MZPJ220 22OHM 5% 1/16W 1005	R217	0RJ1000D677	MCR03EZPJ101 100OHM 5% 1/10W 1608
R1764	0RJ0222C678	MCR01MZPJ220 22OHM 5% 1/16W 1005	R218	0RJ1000D677	MCR03EZPJ101 100OHM 5% 1/10W 1608
R1765	0RJ0222D677	MCR03EZPJ220 22OHM 5% 1/10W 1608	R219	0RJ1000D677	MCR03EZPJ101 100OHM 5% 1/10W 1608
R1766	0RJ0222D677	MCR03EZPJ220 22OHM 5% 1/10W 1608	R220	0RJ1000D677	MCR03EZPJ101 100OHM 5% 1/10W 1608
R1767	0RJ0222C678	MCR01MZPJ220 22OHM 5% 1/16W 1005	R221	0RJ1000D677	MCR03EZPJ101 100OHM 5% 1/10W 1608
R1768	0RJ0222D677	MCR03EZPJ220 22OHM 5% 1/10W 1608	R222	0RJ1000D677	MCR03EZPJ101 100OHM 5% 1/10W 1608
R1769	0RJ0222D677	MCR03EZPJ220 22OHM 5% 1/10W 1608	R223	0RJ1000D677	MCR03EZPJ101 100OHM 5% 1/10W 1608
R177	0RJ0472C678	MCR01MZPJ470 47OHM 5% 1/16W 1005	R224	0RJ1000D677	MCR03EZPJ101 100OHM 5% 1/10W 1608
R1770	0RJ0222C678	MCR01MZPJ220 22OHM 5% 1/16W 1005	R225	0RJ1000D677	MCR03EZPJ101 100OHM 5% 1/10W 1608
R1771	0RJ0000D677	MCR03EZPJ000 0OHM 5% 1/10W 1608 R	R226	0RJ1000D677	MCR03EZPJ101 100OHM 5% 1/10W 1608
R1773	0RJ0222D677	MCR03EZPJ220 22OHM 5% 1/10W 1608	R227	0RJ1000D677	MCR03EZPJ101 100OHM 5% 1/10W 1608
R1774	0RJ0222D677	MCR03EZPJ220 22OHM 5% 1/10W 1608	R228	0RJ1000D677	MCR03EZPJ101 100OHM 5% 1/10W 1608
R1775	0RJ1000D677	MCR03EZPJ101 100OHM 5% 1/10W 1608	R229	0RJ1000D677	MCR03EZPJ101 100OHM 5% 1/10W 1608
R1776	0RJ4701D677	MCR03EZPJ472 4.7KOHM 5% 1/10W 160	R230	0RJ1000D677	MCR03EZPJ101 100OHM 5% 1/10W 1608
R1777	0RJ2201C678	MCR01MZPJ222 2.2KOHM 5% 1/16W 100	R231	0RJ1000D677	MCR03EZPJ101 100OHM 5% 1/10W 1608
R1778	0RJ4701D677	MCR03EZPJ472 4.7KOHM 5% 1/10W 160	R232	0RJ1000D677	MCR03EZPJ101 100OHM 5% 1/10W 1608
R178	0RJ0472D677	MCR03EZPJ470 47OHM 5% 1/10W 1608	R233	0RJ1000D677	MCR03EZPJ101 100OHM 5% 1/10W 1608
R1780	0RJ4701D677	MCR03EZPJ472 4.7KOHM 5% 1/10W 160	R234	0RJ1000D677	MCR03EZPJ101 100OHM 5% 1/10W 1608
R1784	0RJ1000D677	MCR03EZPJ101 100OHM 5% 1/10W 1608	R235	0RJ1000D677	MCR03EZPJ101 100OHM 5% 1/10W 1608
R1787	0RJ1002D677	MCR03EZPJ103 10KOHM 5% 1/10W 1608	R236	0RJ1000D677	MCR03EZPJ101 100OHM 5% 1/10W 1608
R1789	0RJ0000C678	MCR01MZPJ000 0OHM 5% 1/16W 1005 R	R237	0RJ1000D677	MCR03EZPJ101 100OHM 5% 1/10W 1608
R179	0RJ0472C678	MCR01MZPJ470 47OHM 5% 1/16W 1005	R238	0RJ1000D677	MCR03EZPJ101 100OHM 5% 1/10W 1608
R1792	0RJ0000C678	MCR01MZPJ000 0OHM 5% 1/16W 1005 R	R239	0RJ1000D677	MCR03EZPJ101 100OHM 5% 1/10W 1608
R1794	0RJ0000C678	MCR01MZPJ000 0OHM 5% 1/16W 1005 R	R241	0RJ1000D677	MCR03EZPJ101 100OHM 5% 1/10W 1608
R1796	0RJ0000C678	MCR01MZPJ000 0OHM 5% 1/16W 1005 R	R242	0RJ0222C678	MCR01MZPJ220 22OHM 5% 1/16W 1005
R180	0RJ0472C678	MCR01MZPJ470 47OHM 5% 1/16W 1005	R243	0RJ0222D677	MCR03EZPJ220 22OHM 5% 1/10W 1608
R183	0RJ3300D677	MCR03EZPJ331 330OHM 5% 1/10W 1608	R244	0RJ0222D677	MCR03EZPJ220 22OHM 5% 1/10W 1608
R184	0RJ3300D677	MCR03EZPJ331 330OHM 5% 1/10W 1608	R245	0RJ0222D677	MCR03EZPJ220 22OHM 5% 1/10W 1608
R185	0RJ0472C678	MCR01MZPJ470 47OHM 5% 1/16W 1005	R246	0RJ0222D677	MCR03EZPJ220 22OHM 5% 1/10W 1608
R186	0RJ0472C678	MCR01MZPJ470 47OHM 5% 1/16W 1005	R247	0RJ0222D677	MCR03EZPJ220 22OHM 5% 1/10W 1608
R187	0RJ0472C678	MCR01MZPJ470 47OHM 5% 1/16W 1005	R248	0RJ0222D677	MCR03EZPJ220 22OHM 5% 1/10W 1608
R188	0RJ0472D677	MCR03EZPJ470 47OHM 5% 1/10W 1608	R249	0RJ0222C678	MCR01MZPJ220 22OHM 5% 1/16W 1005
R189	0RJ0000G676	MCR18EZHJ00 0OHM 5% 1/4W 3216 R/T	R250	0RJ0222C678	MCR01MZPJ220 22OHM 5% 1/16W 1005
R192	0RJ4701D677	MCR03EZPJ472 4.7KOHM 5% 1/10W 160	R251	0RJ0222D677	MCR03EZPJ220 22OHM 5% 1/10W 1608
R193	0RJ4701D677	MCR03EZPJ472 4.7KOHM 5% 1/10W 160	R255	0RJ4701D477	MCR03EZPF472 4.7KOHM 1% 1/10W 160
R195	0RJ4701D677	MCR03EZPJ472 4.7KOHM 5% 1/10W 160	R256	0RJ1002D677	MCR03EZPJ103 10KOHM 5% 1/10W 1608
R196	0RJ1000D677	MCR03EZPJ101 100OHM 5% 1/10W 1608	R257	0RJ0222D677	MCR03EZPJ220 22OHM 5% 1/10W 1608
R197	0RJ1000D677	MCR03EZPJ101 100OHM 5% 1/10W 1608	R258	0RJ0222D677	MCR03EZPJ220 22OHM 5% 1/10W 1608
R200	0RJ4701D677	MCR03EZPJ472 4.7KOHM 5% 1/10W 160	R259	0RJ0222D677	MCR03EZPJ220 22OHM 5% 1/10W 1608
R201	0RJ1000D677	MCR03EZPJ101 100OHM 5% 1/10W 1608	R260	0RJ0222D677	MCR03EZPJ220 22OHM 5% 1/10W 1608
R202	0RJ1000D677	MCR03EZPJ101 100OHM 5% 1/10W 1608	R301	0RJ0472D677	MCR03EZPJ470 47OHM 5% 1/10W 1608
R203	0RJ1000D677	MCR03EZPJ101 100OHM 5% 1/10W 1608	R302	0RJ1002D677	MCR03EZPJ103 10KOHM 5% 1/10W 1608
R204	0RJ1000D677	MCR03EZPJ101 100OHM 5% 1/10W 1608	R303	0RJ1002D677	MCR03EZPJ103 10KOHM 5% 1/10W 1608

LOC. NO.	PART NO.	DESCRIPTION / SPECIFICATION	LOC. NO.	PART NO.	DESCRIPTION / SPECIFICATION
R304	0RJ1002D677	MCR03EZPJ103 10KOHM 5% 1/10W 1608	R550	0RJ0000D677	MCR03EZPJ000 0OHM 5% 1/10W 1608 R
R305	0RJ1002D677	MCR03EZPJ103 10KOHM 5% 1/10W 1608	R554	0RJ1000D677	MCR03EZPJ101 100OHM 5% 1/10W 1608
R306	0RJ1002D677	MCR03EZPJ103 10KOHM 5% 1/10W 1608	R555	0RJ2202D677	MCR03EZPJ223 22KOHM 5% 1/10W 1608
R309	0RJ0472D677	MCR03EZPJ470 47OHM 5% 1/10W 1608	R556	0RJ4302D677	MCR03EZPJ433 43KOHM 5% 1/10W 1608
R310	0RJ0472D677	MCR03EZPJ470 47OHM 5% 1/10W 1608	R557	0RJ0222D677	MCR03EZPJ220 22OHM 5% 1/10W 1608
R311	0RJ0472D677	MCR03EZPJ470 47OHM 5% 1/10W 1608	R558	0RJ1000D677	MCR03EZPJ101 100OHM 5% 1/10W 1608
R312	0RJ0472D677	MCR03EZPJ470 47OHM 5% 1/10W 1608	R600	0RJ0332D677	MCR03EZPJ330 33OHM 5% 1/10W 1608
R313	0RJ0472D677	MCR03EZPJ470 47OHM 5% 1/10W 1608	R603	0RJ0332D677	MCR03EZPJ330 33OHM 5% 1/10W 1608
R314	0RJ0000D677	MCR03EZPJ000 0OHM 5% 1/10W 1608 R	R604	0RJ0332D677	MCR03EZPJ330 33OHM 5% 1/10W 1608
R315	0RJ0472D677	MCR03EZPJ470 47OHM 5% 1/10W 1608	R605	0RJ0332D677	MCR03EZPJ330 33OHM 5% 1/10W 1608
R316	0RJ0472D677	MCR03EZPJ470 47OHM 5% 1/10W 1608	R606	0RJ0332D677	MCR03EZPJ330 33OHM 5% 1/10W 1608
R319	0RJ1002D677	MCR03EZPJ103 10KOHM 5% 1/10W 1608	R607	0RJ0332D677	MCR03EZPJ330 33OHM 5% 1/10W 1608
R320	0RJ1002D677	MCR03EZPJ103 10KOHM 5% 1/10W 1608	R608	0RJ0332D677	MCR03EZPJ330 33OHM 5% 1/10W 1608
R321	0RJ0472D677	MCR03EZPJ470 47OHM 5% 1/10W 1608	R609	0RJ0332D677	MCR03EZPJ330 33OHM 5% 1/10W 1608
R322	0RJ0472D677	MCR03EZPJ470 47OHM 5% 1/10W 1608	R610	0RJ0332D677	MCR03EZPJ330 33OHM 5% 1/10W 1608
R323	0RJ0472D677	MCR03EZPJ470 47OHM 5% 1/10W 1608	R611	0RJ0332D677	MCR03EZPJ330 33OHM 5% 1/10W 1608
R324	0RJ1000D677	MCR03EZPJ101 100OHM 5% 1/10W 1608	R612	0RJ0332D677	MCR03EZPJ330 33OHM 5% 1/10W 1608
R325	0RJ1000D677	MCR03EZPJ101 100OHM 5% 1/10W 1608	R613	0RJ0000D677	MCR03EZPJ000 0OHM 5% 1/10W 1608 R
R326	0RJ1000D677	MCR03EZPJ101 100OHM 5% 1/10W 1608	R624	0RJ1000D677	MCR03EZPJ101 100OHM 5% 1/10W 1608
R327	0RJ0332D677	MCR03EZPJ330 33OHM 5% 1/10W 1608	R625	0RJ1000D677	MCR03EZPJ101 100OHM 5% 1/10W 1608
R329	0RJ1002D677	MCR03EZPJ103 10KOHM 5% 1/10W 1608	R626	0RJ0332D677	MCR03EZPJ330 33OHM 5% 1/10W 1608
R403	0RJ1002D677	MCR03EZPJ103 10KOHM 5% 1/10W 1608	R627	0RJ1003D677	MCR03EZPJ104 100KOHM 5% 1/10W 160
R407	0RJ1202D677	MCR03EZPJ123 12KOHM 5% 1/10W 1608	R629	0RJ1000D677	MCR03EZPJ101 100OHM 5% 1/10W 1608
R412	0RJ0472D677	MCR03EZPJ470 47OHM 5% 1/10W 1608	R632	0RJ0472D677	MCR03EZPJ470 47OHM 5% 1/10W 1608
R413	0RJ0472D677	MCR03EZPJ470 47OHM 5% 1/10W 1608	R633	0RJ0472D677	MCR03EZPJ470 47OHM 5% 1/10W 1608
R414	0RJ1001D677	MCR03EZPJ102 1KOHM 5% 1/10W 1608	R636	0RJ4701D677	MCR03EZPJ472 4.7KOHM 5% 1/10W 160
R415	0RJ1001D677	MCR03EZPJ102 1KOHM 5% 1/10W 1608	R637	0RJ4700D677	MCR03EZPJ471 470OHM 5% 1/10W 1608
R416	0RJ0000D677	MCR03EZPJ000 0OHM 5% 1/10W 1608 R	R639	0RJ0822D677	MCR03EZPJ820 82OHM 5% 1/10W 1608
R417	0RJ0000D677	MCR03EZPJ000 0OHM 5% 1/10W 1608 R	R640	0RJ0000D677	MCR03EZPJ000 0OHM 5% 1/10W 1608 R
R421	0RJ0472D677	MCR03EZPJ470 47OHM 5% 1/10W 1608	R642	0RJ1002D677	MCR03EZPJ103 10KOHM 5% 1/10W 1608
R422	0RJ4701D677	MCR03EZPJ472 4.7KOHM 5% 1/10W 160	R644	0RJ1001D677	MCR03EZPJ102 1KOHM 5% 1/10W 1608
R437	0RJ0222D677	MCR03EZPJ220 22OHM 5% 1/10W 1608	R646	0RJ2700D677	MCR03EZPJ271 270OHM 5% 1/10W 1608
R438	0RJ0000D677	MCR03EZPJ000 0OHM 5% 1/10W 1608 R	R647	0RJ2200D677	MCR03EZPJ221 220OHM 5% 1/10W 1608
R439	0RJ1000D677	MCR03EZPJ101 100OHM 5% 1/10W 1608	R648	0RJ1001D677	MCR03EZPJ102 1KOHM 5% 1/10W 1608
R441	0RJ1000D677	MCR03EZPJ101 100OHM 5% 1/10W 1608	R649	0RJ1500D677	MCR03EZPJ151 150OHM 5% 1/10W 1608
R446	0RJ1000D677	MCR03EZPJ101 100OHM 5% 1/10W 1608	R650	0RJ1000D677	MCR03EZPJ101 100OHM 5% 1/10W 1608
R448	0RJ1000D677	MCR03EZPJ101 100OHM 5% 1/10W 1608	R651	0RJ0000D677	MCR03EZPJ000 0OHM 5% 1/10W 1608 R
R521	EBC32306001	MCR03EZP5FX9100 910OHM 1% 1/10W 1	R652	0RJ2001D677	MCR03EZPJ202 2KOHM 5% 1/10W 1608
R522	0RJ9311D477	MCR03EZPF9311 9.31KOHM 1% 1/10W 1	R653	0RJ1002D677	MCR03EZPJ103 10KOHM 5% 1/10W 1608
R523	0RJ1001D677	MCR03EZPJ102 1KOHM 5% 1/10W 1608	R654	0RJ0000D677	MCR03EZPJ000 0OHM 5% 1/10W 1608 R
R524	0RJ0000D677	MCR03EZPJ000 0OHM 5% 1/10W 1608 R	R655	0RJ1002D677	MCR03EZPJ103 10KOHM 5% 1/10W 1608
R526	0RJ2001D677	MCR03EZPJ202 2KOHM 5% 1/10W 1608	R657	0RJ0102D677	MCR03EZPJ100 10OHM 5% 1/10W 1608
R527	0RJ2001D677	MCR03EZPJ202 2KOHM 5% 1/10W 1608	R658	0RJ2201D677	MCR03EZPJ222 2.2KOHM 5% 1/10W 160
R528	0RJ0000D677	MCR03EZPJ000 0OHM 5% 1/10W 1608 R	R659	0RJ0000D677	MCR03EZPJ000 0OHM 5% 1/10W 1608 R
R531	0RJ0000D677	MCR03EZPJ000 0OHM 5% 1/10W 1608 R	R662	0RH0000D622	MCR10EZHJ000 0OHM 5% 1/8W 2012 R/
R534	0RJ1002D677	MCR03EZPJ103 10KOHM 5% 1/10W 1608	R663	0RH0000D622	MCR10EZHJ000 0OHM 5% 1/8W 2012 R/
R536	0RJ1002D677	MCR03EZPJ103 10KOHM 5% 1/10W 1608	R664	0RH0000D622	MCR10EZHJ000 0OHM 5% 1/8W 2012 R/
R537	0RJ1502D677	MCR03EZPJ153 15KOHM 5% 1/10W 1608	R665	0RH0000D622	MCR10EZHJ000 0OHM 5% 1/8W 2012 R/
R539	0RJ1002D677	MCR03EZPJ103 10KOHM 5% 1/10W 1608	R666	0RH0000D622	MCR10EZHJ000 0OHM 5% 1/8W 2012 R/
R540	0RJ1002D677	MCR03EZPJ103 10KOHM 5% 1/10W 1608	R667	0RH0000D622	MCR10EZHJ000 0OHM 5% 1/8W 2012 R/
R541	0RJ1002D677	MCR03EZPJ103 10KOHM 5% 1/10W 1608	R668	0RH0000D622	MCR10EZHJ000 0OHM 5% 1/8W 2012 R/
R543	0RJ1502D677	MCR03EZPJ153 15KOHM 5% 1/10W 1608	R669	0RH0000D622	MCR10EZHJ000 0OHM 5% 1/8W 2012 R/
R544	0RJ1002D677	MCR03EZPJ103 10KOHM 5% 1/10W 1608	R670	0RH0000D622	MCR10EZHJ000 0OHM 5% 1/8W 2012 R/
R547	0RJ1000D677	MCR03EZPJ101 100OHM 5% 1/10W 1608	R671	0RH0000D622	MCR10EZHJ000 0OHM 5% 1/8W 2012 R/
R548	0RJ1000D677	MCR03EZPJ101 100OHM 5% 1/10W 1608	R672	0RJ0000D677	MCR03EZPJ000 0OHM 5% 1/10W 1608 R

LOC. NO.	PART NO.	DESCRIPTION / SPECIFICATION	LOC. NO.	PART NO.	DESCRIPTION / SPECIFICATION
R673	0RH0000D622	MCR10EZHJ000 0OHM 5% 1/8W 2012 R/	R759	0RJ0562D677	MCR03EZPJ560 56OHM 5% 1/10W 1608
R674	0RH0000D622	MCR10EZHJ000 0OHM 5% 1/8W 2012 R/	R762	0RJ1002C678	MCR01MZPJ103 10KOHM 5% 1/16W 1005
R675	0RH0000D622	MCR10EZHJ000 0OHM 5% 1/8W 2012 R/	R764	0RJ0562D677	MCR03EZPJ560 56OHM 5% 1/10W 1608
R676	0RH0000D622	MCR10EZHJ000 0OHM 5% 1/8W 2012 R/	R767	0RJ1000D677	MCR03EZPJ101 100OHM 5% 1/10W 1608
R677	0RH0000D622	MCR10EZHJ000 0OHM 5% 1/8W 2012 R/	R769	0RJ0222D677	MCR03EZPJ220 22OHM 5% 1/10W 1608
R678	0RH0000D622	MCR10EZHJ000 0OHM 5% 1/8W 2012 R/	R770	0RJ0332D677	MCR03EZPJ330 33OHM 5% 1/10W 1608
R679	0RH0000D622	MCR10EZHJ000 0OHM 5% 1/8W 2012 R/	R771	0RJ0222C678	MCR01MZPJ220 22OHM 5% 1/16W 1005
R680	0RH0000D622	MCR10EZHJ000 0OHM 5% 1/8W 2012 R/	R772	0RJ1000C678	MCR01MZPJ101 100OHM 5% 1/16W 1005
R681	0RH0000D622	MCR10EZHJ000 0OHM 5% 1/8W 2012 R/	R775	0RJ1000C678	MCR01MZPJ101 100OHM 5% 1/16W 1005
R682	0RH0000D622	MCR10EZHJ000 0OHM 5% 1/8W 2012 R/	R777	0RJ0332C678	MCR01MZPJ330 33OHM 5% 1/16W 1005
R684	0RH0000D622	MCR10EZHJ000 0OHM 5% 1/8W 2012 R/	R778	0RJ1002C678	MCR01MZPJ103 10KOHM 5% 1/16W 1005
R685	0RH0000D622	MCR10EZHJ000 0OHM 5% 1/8W 2012 R/	R779	0RJ1000C678	MCR01MZPJ101 100OHM 5% 1/16W 1005
R686	0RH0000D622	MCR10EZHJ000 0OHM 5% 1/8W 2012 R/	R780	0RJ4701D677	MCR03EZPJ472 4.7KOHM 5% 1/10W 160
R687	0RH0000D622	MCR10EZHJ000 0OHM 5% 1/8W 2012 R/	R781	0RJ1000D677	MCR03EZPJ101 100OHM 5% 1/10W 1608
R688	0RH0000D622	MCR10EZHJ000 0OHM 5% 1/8W 2012 R/	R782	0RJ1000D677	MCR03EZPJ101 100OHM 5% 1/10W 1608
R701	0RJ1002D677	MCR03EZPJ103 10KOHM 5% 1/10W 1608	R783	0RJ1002C678	MCR01MZPJ103 10KOHM 5% 1/16W 1005
R702	0RJ0000D677	MCR03EZPJ000 0OHM 5% 1/10W 1608 R	R784	0RJ0222D677	MCR03EZPJ220 22OHM 5% 1/10W 1608
R703	0RJ1000C678	MCR01MZPJ101 100OHM 5% 1/16W 1005	R785	0RJ1002D677	MCR03EZPJ103 10KOHM 5% 1/10W 1608
R704	0RJ0000C678	MCR01MZPJ000 0OHM 5% 1/16W 1005 R	R786	0RJ1002D677	MCR03EZPJ103 10KOHM 5% 1/10W 1608
R705	0RJ1000C678	MCR01MZPJ101 100OHM 5% 1/16W 1005	R787	0RJ0222D677	MCR03EZPJ220 22OHM 5% 1/10W 1608
R707	0RJ1002C678	MCR01MZPJ103 10KOHM 5% 1/16W 1005	R788	0RJ0332D677	MCR03EZPJ330 33OHM 5% 1/10W 1608
R708	0RJ0222C678	MCR01MZPJ220 22OHM 5% 1/16W 1005	R790	0RJ0332D677	MCR03EZPJ330 33OHM 5% 1/10W 1608
R709	0RJ1000C678	MCR01MZPJ101 100OHM 5% 1/16W 1005	R791	0RJ4701D677	MCR03EZPJ472 4.7KOHM 5% 1/10W 160
R710	0RJ1000C678	MCR01MZPJ101 100OHM 5% 1/16W 1005	R792	0RJ0222C678	MCR01MZPJ220 22OHM 5% 1/16W 1005
R711	0RJ1002C678	MCR01MZPJ103 10KOHM 5% 1/16W 1005	R793	0RJ1002C678	MCR01MZPJ103 10KOHM 5% 1/16W 1005
R712	0RJ0222D677	MCR03EZPJ220 22OHM 5% 1/10W 1608	R794	0RJ1002C678	MCR01MZPJ103 10KOHM 5% 1/16W 1005
R713	0RJ0332C678	MCR01MZPJ330 33OHM 5% 1/16W 1005	R795	0RJ0222C678	MCR01MZPJ220 22OHM 5% 1/16W 1005
R717	0RJ1000C678	MCR01MZPJ101 100OHM 5% 1/16W 1005	R796	0RJ1000C678	MCR01MZPJ101 100OHM 5% 1/16W 1005
R718	0RJ1000D677	MCR03EZPJ101 100OHM 5% 1/10W 1608	R797	0RJ1000C678	MCR01MZPJ101 100OHM 5% 1/16W 1005
R720	0RJ1002C678	MCR01MZPJ103 10KOHM 5% 1/16W 1005	R798	0RJ0000C678	MCR01MZPJ000 0OHM 5% 1/16W 1005 R
R722	0RJ1002D677	MCR03EZPJ103 10KOHM 5% 1/10W 1608	R799	0RJ4701D677	MCR03EZPJ472 4.7KOHM 5% 1/10W 160
R723	0RJ0222D677	MCR03EZPJ220 22OHM 5% 1/10W 1608	R800	0RJ0000D677	MCR03EZPJ000 0OHM 5% 1/10W 1608 R
R724	0RJ0332D677	MCR03EZPJ330 33OHM 5% 1/10W 1608	R801	0RJ0000D677	MCR03EZPJ000 0OHM 5% 1/10W 1608 R
R725	0RJ1000C678	MCR01MZPJ101 100OHM 5% 1/16W 1005	R805	0RJ0222D677	MCR03EZPJ220 22OHM 5% 1/10W 1608
R727	0RJ1000C678	MCR01MZPJ101 100OHM 5% 1/16W 1005	R807	0RJ0000D677	MCR03EZPJ000 0OHM 5% 1/10W 1608 R
R728	0RJ1002D677	MCR03EZPJ103 10KOHM 5% 1/10W 1608	R808	0RJ0000D677	MCR03EZPJ000 0OHM 5% 1/10W 1608 R
R729	0RJ4701D677	MCR03EZPJ472 4.7KOHM 5% 1/10W 160	R811	0RJ0222D677	MCR03EZPJ220 22OHM 5% 1/10W 1608
R733	0RJ0562D677	MCR03EZPJ560 56OHM 5% 1/10W 1608	R812	0RJ1002D677	MCR03EZPJ103 10KOHM 5% 1/10W 1608
R734	0RJ1000C678	MCR01MZPJ101 100OHM 5% 1/16W 1005	R813	0RJ0222C678	MCR01MZPJ220 22OHM 5% 1/16W 1005
R735	0RJ1002D677	MCR03EZPJ103 10KOHM 5% 1/10W 1608	R816	0RJ0000D677	MCR03EZPJ000 0OHM 5% 1/10W 1608 R
R737	0RJ4701D677	MCR03EZPJ472 4.7KOHM 5% 1/10W 160	R821	0RJ0682C678	MCR01MZPJ680 68OHM 5% 1/16W 1005
R739	0RJ1000C678	MCR01MZPJ101 100OHM 5% 1/16W 1005	R822	0RJ0000D677	MCR03EZPJ000 0OHM 5% 1/10W 1608 R
R740	0RJ0222D677	MCR03EZPJ220 22OHM 5% 1/10W 1608	R823	0RJ1500C678	MCR01MZPJ151 150OHM 5% 1/16W 1005
R741	0RJ1000C678	MCR01MZPJ101 100OHM 5% 1/16W 1005	R826	0RJ0000D677	MCR03EZPJ000 0OHM 5% 1/10W 1608 R
R743	0RJ0000C678	MCR01MZPJ000 0OHM 5% 1/16W 1005 R	R827	0RJ0682C678	MCR01MZPJ680 68OHM 5% 1/16W 1005
R744	0RJ0000C678	MCR01MZPJ000 0OHM 5% 1/16W 1005 R	R829	0RJ0000D677	MCR03EZPJ000 0OHM 5% 1/10W 1608 R
R745	0RJ1002D677	MCR03EZPJ103 10KOHM 5% 1/10W 1608	R843	0RJ1002D677	MCR03EZPJ103 10KOHM 5% 1/10W 1608
R746	0RJ1002D677	MCR03EZPJ103 10KOHM 5% 1/10W 1608	R847	0RJ1000D677	MCR03EZPJ101 100OHM 5% 1/10W 1608
R747	0RJ1002D677	MCR03EZPJ103 10KOHM 5% 1/10W 1608	R848	0RJ1000D677	MCR03EZPJ101 100OHM 5% 1/10W 1608
R748	0RJ1000C678	MCR01MZPJ101 100OHM 5% 1/16W 1005	R849	0RJ1000D677	MCR03EZPJ101 100OHM 5% 1/10W 1608
R751	0RJ0222D677	MCR03EZPJ220 22OHM 5% 1/10W 1608	R850	0RJ1002D677	MCR03EZPJ103 10KOHM 5% 1/10W 1608
R754	0RJ0562D677	MCR03EZPJ560 56OHM 5% 1/10W 1608	R860	0RJ0682C678	MCR01MZPJ680 68OHM 5% 1/16W 1005
R755	0RJ1002C678	MCR01MZPJ103 10KOHM 5% 1/16W 1005	R877	0RJ0682C678	MCR01MZPJ680 68OHM 5% 1/16W 1005
R756	0RJ0222C678	MCR01MZPJ220 22OHM 5% 1/16W 1005	R880	0RJ0682C678	MCR01MZPJ680 68OHM 5% 1/16W 1005
R757	0RJ1000C678	MCR01MZPJ101 100OHM 5% 1/16W 1005	R881	0RJ0682C678	MCR01MZPJ680 68OHM 5% 1/16W 1005



LOC. NO.	PART NO.	DESCRIPTION / SPECIFICATION
R882	0RJ0682C678	MCR01MZPJ680 68OHM 5% 1/16W 1005
R883	0RJ0682C678	MCR01MZPJ680 68OHM 5% 1/16W 1005
R884	0RJ0682C678	MCR01MZPJ680 68OHM 5% 1/16W 1005
R885	0RJ0682C678	MCR01MZPJ680 68OHM 5% 1/16W 1005
R886	0RJ0682C678	MCR01MZPJ680 68OHM 5% 1/16W 1005
R888	0RJ0682C678	MCR01MZPJ680 68OHM 5% 1/16W 1005
R891	0RJ0682C678	MCR01MZPJ680 68OHM 5% 1/16W 1005
R892	0RJ0682C678	MCR01MZPJ680 68OHM 5% 1/16W 1005
R896	0RJ0000D677	MCR03EZPJ000 0OHM 5% 1/10W 1608 R
R900	0RJ1002D677	MCR03EZPJ103 10KOHM 5% 1/10W 1608
R901	0RJ1002D477	MCR03EZPF103 10KOHM 1% 1/10W 1608
R902	0RJ2002D477	MCR03EZPF203 20KOHM 1% 1/10W 1608
R911	0RJ1002D677	MCR03EZPJ103 10KOHM 5% 1/10W 1608
R913	0RJ3302D677	MCR03EZPJ333 33KOHM 5% 1/10W 1608
R915	0RJ1002D677	MCR03EZPJ103 10KOHM 5% 1/10W 1608
R916	0RJ1002D677	MCR03EZPJ103 10KOHM 5% 1/10W 1608
R917	0RJ1002D677	MCR03EZPJ103 10KOHM 5% 1/10W 1608
R918	0RJ3302D677	MCR03EZPJ333 33KOHM 5% 1/10W 1608
R919	0RJ3302D677	MCR03EZPJ333 33KOHM 5% 1/10W 1608
R920	0RJ3302D677	MCR03EZPJ333 33KOHM 5% 1/10W 1608
R923	0RJ1002D677	MCR03EZPJ103 10KOHM 5% 1/10W 1608
R924	0RJ1002D677	MCR03EZPJ103 10KOHM 5% 1/10W 1608
R925	0RJ3302D677	MCR03EZPJ333 33KOHM 5% 1/10W 1608
R926	0RJ3302D677	MCR03EZPJ333 33KOHM 5% 1/10W 1608
R927	0RJ4701D677	MCR03EZPJ472 4.7KOHM 5% 1/10W 160
R930	0RJ3302D677	MCR03EZPJ333 33KOHM 5% 1/10W 1608
R931	0RJ1000D677	MCR03EZPJ101 100OHM 5% 1/10W 1608
R932	0RJ1002D677	MCR03EZPJ103 10KOHM 5% 1/10W 1608
R933	0RJ1002D677	MCR03EZPJ103 10KOHM 5% 1/10W 1608
R934	0RJ3302D677	MCR03EZPJ333 33KOHM 5% 1/10W 1608
R935	0RJ0000D677	MCR03EZPJ000 0OHM 5% 1/10W 1608 R
R936	0RJ0000D677	MCR03EZPJ000 0OHM 5% 1/10W 1608 R
R937	0RJ0000D677	MCR03EZPJ000 0OHM 5% 1/10W 1608 R
R938	0RJ0000D677	MCR03EZPJ000 0OHM 5% 1/10W 1608 R
R939	0RJ0000D677	MCR03EZPJ000 0OHM 5% 1/10W 1608 R
R940	0RJ0000D677	MCR03EZPJ000 0OHM 5% 1/10W 1608 R
<b>HARNESSs &amp; CONNECTORS</b>		
C1	6631900012E	Harness, SMH250 SMH250 300mM 2.50MM 10P UL
C2	6631900018H	Harness, 3P SPK LEFT SMH250 TERMINAL 450mM
C3	6631900048D	Harness, SMH200 SMH200 700mM 2.00MM 4P UL1
C4	6631900050B	Harness, SMH200 SMH200 900mM 2.00MM 10P UL
C5	6631900099C	Harness, SMH250 SMP250 400mM 2.50MM 3P UL1
C6	6631900100D	Harness, SMH250 SMP250 600mM 2.50MM 4P UL1
C7	6631T25020L	Harness, SMH250 SMH250 250mM 2.50MM 13P UL
C8	6631T25026J	Harness, SMH250 TERMINAL 35098 35097 800mM
C9	6631T39004D	Harness, 6631T39004D 1-1123722-9 1-1123722
C10	EAD3566430I	Harness, SMH200(900MM) SMH200-14(YEONHO) S
C11	EAD35682502	Harness, LVDS PDP STANDARD FI-X30HL(JAE) F
C12	EAD36925302	Harness, 14P(EXTENSION) SHIELD SMH200-14P
C13	EAD39526501	Harness, 4P(320MM) WITH CORE 12505HS-0400
J1100	6630G70016A	A03-7071-094 D-SUB 15P 2.29MM STR
J1102	6630G70017A	A02-0915-101 D-SUB 9P 2.77MM STRA
CN300	6630VE01269	Wafer, 91932-31169LF 68P 1.00MM 1R STRAI

LOC. NO.	PART NO.	DESCRIPTION / SPECIFICATION
CW	6630V90142A	Wafer, TPH254-R-1419-6A 6P 2.54MM 2R ANG
P1	6602T20009C	Wafer, SMAW200-04P 4P 2.00MM 1R ANGLE DI
P100	6602T20009C	Wafer, SMAW200-04P 4P 2.00MM 1R ANGLE DI
P100	6602T20009J	Wafer, SMAW200-10P 10P 2.00MM 1R ANGLE D
P101	6602T20009C	Wafer, SMAW200-04P 4P 2.00MM 1R ANGLE DI
P101	6602T20009N	Wafer, SMAW200-14P 14P 2.00MM 1R ANGLE D
P1101	6602T20008J	Wafer, SMW200-10P 10P 2.00MM 1R STRAIGHT
P1102	6630VF00704	Wafer, 12505WS-04A00 4P 1.25MM 1R STRAIG
P1300	6602T25008B	Wafer, SMW250-03P 3P 2.50MM 1R STRAIGHT
P1301	6602T25008C	Wafer, SMW250-04P 4P 2.50MM 1R STRAIGHT
P1400	6602T20008N	Wafer, SMW200-14P 14P 2.00MM 1R STRAIGHT
P800	6630V90116A	Wafer, FI-X30SSL-HF 30P 1.00MM 1R ANGLE
P900	6602T25008M	Wafer, SMW250-13P 13P 2.50MM 1R STRAIGHT
P901	6602T25008J	Wafer, SMW250-10P 10P 2.50MM 1R ANGLE DI
<b>JACKS</b>		
JK100	6612J10033A	PMJ016-13 13P DIN/RCA 14MM ANGLE
J1000	6612B00015C	DC1R019WDH. SOCKET 21P STRAIGHT S
J1001	6612B00015C	DC1R019WDH. SOCKET 21P STRAIGHT S
J1101	6612F00099A	PEJ024-01 1P 4P STRAIGHT TR 3.6MM
J1200	6612M00010A	PSC003-01 21P 21P/1C 3.81MM STRAI
J1201	6612M00010A	PSC003-01 21P 21P/1C 3.81MM STRAI
J1203	6612J10031B	PPJ209-01 14.0MM 1RX3C ANGLE BK S
J600	6612J10023A	KCN-BT-0-0053 10.5MM/11.5MM 1RX1C
JK	6612BBBHND	TOTX177 3P TX 2.54MM ANGLE 15MBPS
<b>SWITCHES</b>		
SW100	EBF32593901	TMUE312GAB 1C1P 12VDC 0.5A VERTIC
SW101	140-313B	KPT-1115AM 1C1P 12VDC 0.05A HORIZ
SW102	140-313B	KPT-1115AM 1C1P 12VDC 0.05A HORIZ
SW103	140-313B	KPT-1115AM 1C1P 12VDC 0.05A HORIZ
SW104	140-313B	KPT-1115AM 1C1P 12VDC 0.05A HORIZ
SW105	140-313B	KPT-1115AM 1C1P 12VDC 0.05A HORIZ
SW106	140-313B	KPT-1115AM 1C1P 12VDC 0.05A HORIZ
SW107	140-313B	KPT-1115AM 1C1P 12VDC 0.05A HORIZ
SW108	140-313B	KPT-1115AM 1C1P 12VDC 0.05A HORIZ
SW700	EBF32593901	TMUE312GAB 1C1P 12VDC 0.5A VERTIC
<b>OTHERs</b>		
B1	3890TKD002P	Box, LB500J(PCB) BRAND 542*397*445
B2	3890TKD002P	Box, LB500J(PCB) BRAND 542*397*445
X100	6212AC2002B	Crystal, 9H03200164 32.768KHZ 20PPM
X101	6212AB2883A	Crystal, HC-49SM 27.00000MHZ 27MHZ
X1300	156-A02R	Crystal, EUA18.4320F16E33L 18.432MHZ
X700	6212AB2015J	Crystal, HC-49SM 19.66080HZ 19.6608HZ
LD101	ODL200000CA	LED, DIP SAM5670(DL-2LRG) ROUND 4.8MM
PA101	6712000011B	Receiver Module, KSM-2013TE2A 1.3MA 15M 3P
IC201	SAA30310948	S/W, Firmware 4.17 5927 EUROPE FLASHROM
IC802	SAA30310836	S/W, Firmware 5.27 19E3 EUROPE FLASHROM
P300	EAG34998901	Socket, PCI 10074998-118MCALF 68P 1.27MM

LOC. NO.	PART NO.	DESCRIPTION / SPECIFICATION	LOC. NO.	PART NO.	DESCRIPTION / SPECIFICATION
<b>ACCESSORY</b>					
A1	SAC30033609	Title, CD MANUAL PDP DTV (LD73A/PD73A)			
A1	MFL34441603	Manual, Owners EU 27 LANGAGES SIMPLE BOOK			
A2	AKB33871401	Remote Controller Assembly, 19_22LS4D, EU(PAL)			
A21	MCK36759201	Cover, MOLD ABS HF-380 MKJ339814 BATTERY COVER			
A3	6410TEW010A	Power Cord, CEE,LP-34A&H05VV-FX3C 1.87M BLK			
A4	4972V00178B	Supporter, EXTRUSION AL WALL ASSY FOLDING STAND ONLY			
A5	4950TKA320A	Plate, PRESS SBHG T1.2 SUPPORT UPSET			
A6	FAB30006116	Screw, Machine FAB30006116 FH + 4MM 14MM MSWR			
A7	FAB30021701	Screw, Machine 1SZZVMR001A RING WALL 5MM 25MM			